

THE AMERICAN
GAS LIGHT JOURNAL.

(ILLUSTRATED.)

DEVOTED TO THE INTERESTS OF
ILLUMINATION, VENTILATION, WATER SUPPLY,
— AND —
GENERAL SCIENCE.

VOLUME XLII

(TWENTY-SEVENTH YEAR.)

FROM JANUARY 2d TO JUNE 16th, 1885.

A. M. CALLENDER & CO., Publishers.

OFFICE OF PUBLICATION, No. 42 PINE STREET, NEW YORK CITY.

INDEX TO VOL. XLII.

A.

Assaying Furnace, Gas-Heated..... 41
 Address of President, New England Association of Gas Engineers..... 117
 Address of Gen. Andrew Hickenlooper to the Members of the Ohio Gas Association..... 149
 Address of President, Western Gas Association..... 283

B.

*Boardman Hydraulic Main, the..... 59
 British Gas Undertakings..... 67
 Boilers, the Cleaning of..... 121
 Black Lead Paint, a New..... 147
 Barometrical Pressure, Effect of on Candle Power of Gas..... 201
 *Box and Waller Washer-Scrubber, the..... 263
 *Bower Recuperative Burner, the..... 289

C.

Capital to Output, the Relation of, by T. D. Gilbert..... 6
 Correspondence, Special English..... 11, 64, 113, 179, 236, 290
 Coal Gas, on the Use of, by H. Dixon, M. A., a Series of Three Lectures..... 33, 61, 88
 Coal Tar Colors..... 37
 Condensing Sulphuric Acid Gas..... 39
 Contract Awarded..... 41
 Calling the Roll, New England Association..... 116
 Coal Gas, Lecture on, by Prof. Thorpe..... 118
 Compressed Oil Gas Illumination..... 121
 Carbonic Oxide, the Venenose Nature of..... 148
 Coal Gas, Enriching Candle Power of with Naphtha..... 202
 Carbon Deposit, Its Formation and Removal under Different Heating Conditions..... 227
 Carbonic Acid and Iron and Lime Purification..... 238
 Clogging of Burner Tips in Houses Near "Dead" Ending Mains..... 255
 Coke—How Much is Lost as Screenings, after being Crushed; and What Advance Must be Added to Price of Crushed Coke to Make Its Sale Equally Profitable with that of the Coarse Product? by J. Light..... 234
 Coke Crusher, Which is the Best?..... 256
 Compensation of Secretary and Treasurer, New England Association..... 257
 Calling the Roll, Western Gas Association..... 283
 Carbonic Acid, Its Effect on the Illuminating Power of Coal Gas, by C. J. R. Humphreys..... 288

CORRESPONDENCE—

Wise Body of Municipal Councilors, a..... 14
 Utilization of Waste Heat of Gas Works..... 70
 "Knights of Labor" Speak Their Mind..... 210
 Suggesting a Remedy..... 321

D.

Deceased Members, American Gas Light Association..... 3
 Dividends Paid by San Francisco Gas and Electric Light Companies in 1884..... 95
 Discussing the President's Address, New England Association of Gas Engineers..... 143
 Dangers of Water Gas, the..... 177
 Disease, How it is Spread..... 263
 Death of M. Servier..... 310

E.

Experience in "Competition," the Teaching of, by Antiquus..... 10
 Edison Electric Illuminating Company, Annual Report of the..... 91
 Electric Safety Lamps, Improvement in..... 95
 English Gas Stocks and other Investments..... 142
 Election of Officers, New England Association..... 147
 Electric Lighting, Advances Made in During Past Year..... 200
 Election of Officers, Western Association..... 314

EDITORIALS—

Iowa Gas Association..... 1
 Pratt's Oil Works Go Up and Come Down..... 2
 Still in the Land of the Living..... 2
 Society of Gas Lighting, Annual Meeting of the..... 2
 Gas Meter as a Vexatious Problem, the..... 29
 Electric Lighting in America, Mr. W. H. Preece on the Subject of..... 57
 Siemens Burner, another Victory for the..... 58
 Conflict of Dates..... 58
 Gas Reformers of New York City..... 85
 There Will be no Conflict in Future..... 86
 Latest from Boston..... 86
 Misprint..... 86
 New England Association of Gas Engineers, Annual Meeting of the..... 114
 Colorado "Bill," a..... 115
 Ohio Gas Association, Annual Meeting of the..... 115

EDITORIALS—Continued.

Massachusetts Board of Health Gives an Opinion on the Poisonous Properties of Water Gas..... 141
 Cheap Gas Coal..... 142
 Guild of Gas Managers, Annual Meeting of the..... 169
 Messrs. Gibbs and Van Steenhergh Take a Trip to Troy, N. Y..... 170
 Obituary—Mr. Thomas Butterworth..... 197
 Obituary—Mr. Geo. Cornell..... 226
 Gas Commission for New York City, the Proposed..... 198
 Siemens Burner Wins Again..... 226
 How They Do Business at Troy, N. Y..... 226
 Slur, an Unwarranted..... 253
 Gas Reformers, Ludicrous Antics of the..... 254
 Change at Louisville, Ky..... 254
 Chicago Meeting of the Western Gas Association..... 281
 President Newman, All Hail to..... 282
 Cleveland (Ohio) Gas Affairs, a Chapter or Two in the History of..... 309
 Central New York Gas Engineers Association..... 310

F.

Figures, One or Two..... 208
 Fireproof Doors..... 318

G.

Gas Stoves a Means of Revenue, by R. B. Taber..... 3
 Gas Tar, Preparing and Applying a Coating of..... 30
 Gas Heat for Mechanical Purposes, by T. J. C..... 36
 Gas-Heated Bakers' Ovens, by T. J. C..... 60
 Gas Commission Resolution, New England Association..... 147
 Gas Stoves as a Means of Increasing the Consumption of Gas, by Jos. Bate..... 174
 Gasbolders Built to the Order of the "Gas Light and Coke Company" at the Horseferry Road Station..... 207
 Gas Question at St. Louis, Mo., the..... 235
 Gas Shrinkage, Relation of to Change in Temperature..... 256
 Gas Mains, What is the Best Joint for..... 257
 Gas Institute, Membership of the..... 310
 Gas Meter, the Proper Location of, by J. G. Miller..... 312

H.

Hocking Valley (Ohio) Coal..... 94
 Happenings, Some Recent..... 142

I.

Invented to Visit the White House, American Association..... 3
 Invention, Sir F. Bramwell, on the Progress of..... 92
 Invited Guests, New England Association..... 116
 In Memoriam Proceedings, Western Association..... 314
 Incandescent Electric Light, Cost of Production of, by F. Egner..... 315
 Items of Interest from Various Localities 12, 39, 68, 96, 123, 151, 181, 208, 237, 264, 291, 321

J.

Jamaica Plain (Mass) Gas Light Company, Thirtieth Annual Report..... 317

L.

Lime and Cements, Something about..... 68
 Locomotive Engine, Improvement of the..... 208
 Lime in Connection with Oxide of Iron, Does it Pay to Use any? by J. Fullagar..... 233
 Leaks on Lines of Gas Mains, How Can They Best be Discovered?..... 257
 Leakage and Condensation, What Percentage of Loss of Gas is Due or Chargeable to Each? Papers by E. Printz (258), and W. Enfield..... 259
 Loss in Weight of Coal as a Result of Six Months' Storage, by Gen. A. Hickenlooper..... 285

M.

Municipal Contracts, the Value of..... 2
 Membership List, Ohio Association..... 177
 Market for Gas Securities, the, 14, 41, 71, 99, 125, 152, 170, 211, 239, 254, 293, 321

N.

New Members, New England Association..... 116
 New Members, Western Association..... 284
 Natural Gas and Its Uses..... 121
 Neal, Mr. Geo. B., Refuses a Re-election..... 147
 Naphthaline Deposits, an Experience with, by E. C. Jones..... 199
 Naphthaline as a Deposit in Gas Works Plant, the Prevention of, Papers by E. McMillin and J. Light..... 203, 204
 Natural Gas, What is It, and Can It become a Competitor of Coal Gas as an Illuminating Agent? by I. Butterworth..... 205
 "Novelties" Exhibition to be Held by Franklin Institute, by H. C. A..... 316

O.

Oil and Gas Wells of Pennsylvania..... 38
 Ocean Mine Gas Coal, Map Showing Location of..... 87
 Oil as an Enricher, Best Quality to Use, and Best Method of Using..... 202
 Oxygen, Manufacture and Use of..... 263
 Obituary Resolutions, Western Association..... 314
 Oil Wells and Torpedoes..... 317

OFFICIAL NOTICES—

Annual Meeting New England Association of Gas Engineers..... 57, 85
 First Annual Meeting Ohio Gas Light Association..... 57, 85
 Secretary's Circular in Regard to above..... 60
 Annual Meeting Western Gas Association 113, 169, 197, 225
 Central New York Gas Engineers Association..... 253

OFFICIAL REPORTS—

XII. Annual Meeting American Gas Light Association, Concluded from Vol. XLI..... 3
 XV. Annual Meeting New England Association of Gas Engineers..... 116, 143, 171, 199, 227, 255
 First Annual Meeting Ohio Gas Light Association 174, 203, 231, 257, 285
 VII. Annual Meeting Western Gas Association..... 283, 311

P.

Public Lighting in Brooklyn, N. Y., Bids for..... 30
 Plumber, the, Once More Heard from..... 41
 Promoted..... 58
 Patents, Recent American..... 98, 125
 Petroleum Situation, the..... 123
 Petroleum and Its Residuals, by Wm. Farmer, C. E..... 178
 Presidential Office, Proposing to Limit Term of, New England Association..... 200
 Pipe around Retort House between Hydraulic and Condenser, Practical Value of..... 202
 Pressure Shown on a Gauge by Gas at Different Temperatures..... 256
 President's Address, American Association, Report of Committee on..... 3
 Past Presidents' Addresses, American Association, Report of Committee on..... 8
 President's Address, Western Gas Association, Report of Committee on..... 314

R.

Removal of Seal in Hydraulic Main, Results Obtained by the, by Eugene Vanderpool..... 9
 Residual Product, New Use for a..... 10
 Regenerative Burners, the Siemens..... 66
 Report of Treasurer, New England Association..... 142
 Retorts, Shape of Same and Manner of Setting, How Can They Best be Improved? by J. Anderson..... 285
 Red Lead in Steam Pipe Joints..... 318

S.

Sulphate of Ammonia in the Garden, Use of..... 15
 Suggestions for Reflection when in Thoughtful Mood, by Jos. R. Thomas, C. E..... 31
 Suicide by Gas..... 41
 Storage of Gas to Consumption, the Proper Ratio of, by Col. F. S. Benson..... 59
 Slag Cement..... 95
 Storage of Petroleum, an English Establishment for the..... 122
 Syracuse (N. Y.) Gas Company Reduces Price of Gas..... 170
 Steam in the Ashpan, Influence of, by C. F. Pritchard..... 171
 Striking Miners Resume Work..... 226
 Steam Passing through Our Grate Bars, Do We Gain in Heat or Save Fuel by the Practice? by E. McMillin..... 231
 Service Pipes, what is It that Obstructs Them During Extremely Cold Weather? by G. Tayler..... 260
 Steam-jet Exhauster and Naphthaline, by J. B. Howard..... 311
 Sulphate of Ammonia as a Manure, Value of..... 315
 Sulphur, Recovery of..... 319

T.

Testing Gas for Carbonic Acid..... 262

V.

Votes of Tbanks, American Association..... 9
 Victim, a New York..... 41

W.

Wet Coal, the Effect of upon the Illuminating Value of the Gas Distilled from It..... 229
 Welcoming the Visitors, Western Association..... 285

THE AMERICAN
GAS LIGHT JOURNAL.

(ILLUSTRATED.)

DEVOTED TO THE INTERESTS OF

ILLUMINATION, VENTILATION, WATER SUPPLY,

— AND —

GENERAL SCIENCE.

VOLUME XLIII.

(TWENTY-SEVENTH YEAR.)

FROM JULY 2d TO DECEMBER 16th, 1885.

A. M. CALLENDER & CO., Publishers.

OFFICE OF PUBLICATION, No. 42 PINE STREET, NEW YORK CITY.

INDEX TO VOL. XLIII.

A.

Amenity a Requisite to Success in the Gas Business, by E. Lindsley.....	59
Annual Banquets, in the Matter of, Western Association.....	59
*Atkinson's Differential Gas Engine.....	171
*Albo-Carbon Light.....	173
Australian Gas Light Company, New Works of the.....	204
Applications for Membership, American Association.....	227
Address of President, American Association.....	227

B.

Boring for Natural Gas at Cleveland, Ohio.....	122
--	-----

C.

Candle Power of Arc Lamps, the Actual, by H. C. Adams.....	2
Casting, a Large Italian.....	8
Correspondence, Special English.....	9, 66, 121, 177, 232, 289
Cast Iron Mains Laid with Cement, How to Prevent Breaks in Same during Winter Seasons.....	35
Cooper's Coal Lining Process, by G. S. P.....	38
*"Crinoline" Chimneys of the Cambria Iron Company.....	39
Cooper Coal Lining Process, by G. Shepard Page.....	63
Condensation; on the Elimination of Tar from Coal Gas, by A. B. Slater.....	65
*"Chamberlain Gas," Results of a Trial with, by Frederic Egner.....	93
Coal Slag as a Building Material.....	120
Charges Made against the Columbus (Ohio) Gas Light Company, Mr. Emerson McMillin in Reply to the.....	174
*Combustion, the Effects of Heating Air upon.....	201
Committee on Invitation, American Association.....	227
Committee on President's Address, American Association.....	230
Coal vs. Coke in the Jarvis Furnace.....	231
Committee on Nominations, American Association.....	255
Committee on Place of Meeting, 1886, American Association.....	255
Cooper's Coal Lining Process, by R. P. Spice.....	287
Coals, Safe Sea-Carriage of.....	317

CORRESPONDENCE—

Allen-Harris Process, Mr. Allen Advertises the.....	263
Anæsthetic, Is It a Harmless?.....	320
Mr. Thurber, Does He Own Stock in a Burner Company? Sidewalk Stopcocks.....	330
	153

D.

Dinner and Address, Central New York Association.....	38
*Difficulties Encountered in the Construction of a Gasholder Tank, by E. McMillin.....	256

E.

Election of Officers, Central New York Association.....	8
Electing Mr. Harbison to Honorary Membership in Central New York Association.....	8
Examining the United States Patent Office Records, by F. Egner.....	147
Evaporation Tests, Comparative.....	178
Experiment in Gas Making, and the Results Thereof, by F. Egner.....	206
English Gas Engineer, Welcoming a Distinguished.....	227
Election of New Members, American Association.....	227
Executive Committee, Report of, American Association.....	225
Election of Officers, American Association.....	286
Exhibition of Gas Appliances, Proposing an.....	285

EDITORIALS—

Guild of Gas Managers, Combining Business with Pleasure.....	1
Consumers Company, of Chicago, Ills.....	2
McIlhenny's Experiments in the Direction of Improved Methods of Bench Firing.....	30
Electric Lighting at Lawrence, Mass.....	58
Disastrous Pleasure Trip.....	58
Death and Burial of a Hero.....	86
Low Incandescent Burner.....	86
*"Novelties" Exhibition, the.....	113
Low Incandescent Burner, a Good Specimen of the.....	114
Chicago Gas Deal, the.....	114
New England Association, Semi-Annual Meeting of the They "Punched" Out the Regulators.....	142
Resigned His Position.....	142
Obituary—Hartley, F. W.....	254
" Odiome, Alfred.....	254
" Thompson, Hou. Francis.....	142
" Woodruff, Dr. E. B.....	198
*"Dr. Robinson, of Columbus, Ohio".....	170
Iowa Gas Association, Annual Meeting of the.....	170

EDITORIALS—Continued.

The Cincinnati Meeting.....	170
Do Your Duty.....	198
Report of Transactions, 1885 Meeting of the Gas Institute.....	198
The Meeting in Cincinnati.....	225
Gas Consumers Association and the New York State Political Canvass.....	253
Gas-Heated Bakers' Ovens.....	254
Personal—Mr. E. Vanderpool.....	254
Public Electric Lighting in New York City.....	281
Friend Harbison was "Justified".....	282
Not in Time.....	309
Appeal in Behalf of the Hartley Fund.....	309
Surprising News from Albany, New York.....	309
Important Decision, a Most.....	310

F.

Furnaces, Use of Steam in.....	8
Finance Committee, Report of, American Association.....	255
Formation of Coal.....	260

G.

Gas Appliances at the Parkes Museum.....	10
Gas Commissions, Report of Committee on Formation of, Western Association.....	59
Gas Bills vs. Gas Light, by Byron E. Chollar.....	62
Gas Commission for the State of Massachusetts, Text of Bill Creating a.....	92
Gas Engines of Large Power.....	98
*Gaseous Fuel.....	143

H.

Heating Regenerative Gas Furnaces by Radiation from Flame.....	148
--	-----

I.

Iron Purifying Material, by E. H. Jenkins.....	6
Inspection and Luncheon, Central New York Association.....	8
Incandescent Gas Light, the Lowe.....	199
It is Well to Know what You are Buying.....	30
Incandescent Lamps, Review of the Report Made by Franklin Institute Committee on Duration and Efficiency of, by H. C. Adams.....	148
Items of Interest from Various Localities 12, 40, 67, 95, 123, 151, 178, 207, 234, 261, 290, 318	

J.

Jarvis Furnace, Coal vs. Coke in the.....	231
Joint Discussion on the Somerville-Spice Papers, American Association.....	310

K.

Klonne Regenerative Furnaces at the Greenock Gas Works, the.....	118
Kendrick Incandescent Gas Lamp, the.....	200

L.

*Lungren Lamp, the New.....	173
Lowe Gas Processes, the.....	199
Lowe Manufacturing Company's General Exhibit at the "Novelties" Exhibition.....	199
Landed Coal, the Results of a Month's Working with, by Jas. Somerville.....	286

M.

Miscellaneous Exhibits at the "Novelties" Exhibition.....	230
Market for Gas Securities, the 2, 41, 70, 86, 114, 142, 170, 198, 235, 264, 292, 321	

N.

Natural Gas.....	8
New Plant of the Syracuse (N. Y.) Gas Light Company.....	37
Naming Place to Hold '86 Meeting of Western Association.....	88
Natural Gas, by E. McMillin.....	88
Natural Gas: Its Relation to the Gas Interest Generally, by J. M. Critchlow.....	115
Natural Gas in Plate Glass Manufacture.....	120
*"Novelties" Exhibition at Phila., Pa., Some Notes on the, by H. C. Adams.....	172, 199, 230
Natural Gas, Report of the Pittsburgh Commission on.....	231
New Members, American Association.....	227
Natural Gas, by W. H. Denniston.....	282
*"Novelties" Exhibition, Receipts at the.....	282

O.

OFFICIAL NOTICES, ETC.—	
American Gas Light Association.....	29, 141, 169, 197
Iowa Gas Association.....	57, 85, 113
New England Association of Gas Engineers.....	85

OFFICIAL REPORTS—

VII. Annual Meeting, Western Gas Association—Concluded from Vol. XLII., page 315.....	3, 32, 59, 87, 115
VI. Annual Meeting, Central New York Gas Engineers' Association.....	7, 37
XIII. Annual Meeting American Gas Light Association.....	227, 255, 282, 310

P.

*Pressure of Gas in Street Mains, by G. A. Hyde, sr.....	3
Programme of the Session, Central New York Association.....	8
Paint and Varnish, Removal of.....	11
Pressure in Elevated Districts, Regulation of.....	94
Pyrometers.....	98
Patents in Belgium and Austro-Hungary.....	126
Paper Made from Seaweed.....	150
Patents, Recent American.....	153
Peruvian Petroleum Fields.....	205
Pittsburgh Commission on Natural Gas, Report of.....	231
President's Address, American Association.....	227
Past and Present State of Gas Lighting in Scotland.....	233
Poisoning by Illuminating Gas.....	260
Proposition to Change Time of Holding Annual Meeting, American Association.....	286
Present State of the Gas Interest, by Jno. C. Pratt.....	312

Q.

Question-Box, Western Association.....	5
Question-Box, Ordered by Central New York Association.....	8

R.

Roll Call, Central New York Association.....	7
Routine Business, Central New York Association.....	7
Removal of Paint and Varnish.....	11
Refrigerating Machines.....	98
Regenerative Furnaces, the Klonne.....	118
Regenerative Gas Furnaces, on Heating by Radiation from Flame.....	148
Relation of Steam Power to Electric Lighting.....	150
Roll Call, American Association.....	255

S.

Steam in Furnaces, the Use of, by A. C. Wood.....	8
Stoppages in Small Gas Works, by V. L. Elbert.....	32
Syracuse (N. Y.) Gas Light Company, New Plant of the.....	37
Servier, the Late M.....	38
Sulphate of Ammonia, Use of as a Manure.....	67
Something Curious.....	98
Stopcocks and Sidewalk Boxes: Is it Necessary to Employ Same where Make or Output Reaches 30,000 cubic feet per Diem?.....	117
Steam Power, Relation of to Electric Lighting.....	150
Stevens Battery, Something about the.....	151
Siemens Lamps at the "Novelties" Exhibition.....	173
Scott Gas Lighting, Past and Present State of.....	233
Secretary's Report, American Association.....	255
Stoking Machinery, by M. S. Greenough.....	316

T.

Testing Coal for its Producing Qualities.....	10
Train Lighting.....	11
*Thermophote, or Self-Registering Photometer.....	31
Treasurer's Report, Western Association.....	59
Tar Fuel as Compared with Coke, Concerning Yield per Bort, and Life of Same.....	34
This and That from Europe.....	117
Technical Journalism.....	122
Test was Made, the.....	209
Treasurer's Report, American Association.....	255
Three-Hour Charges, by A. B. Slater.....	288

V.

Votes of Thanks, Western Association.....	118
Vincennes (Ind.) Gas Light Company, Annual Election.....	142

W.

Waste Heat from Benches, Utilization of, by J. W. Dunbar.....	6
Wasserman Lamp, the.....	174
*Wilbraham Gas Exhauster, the.....	230

66505
A M
V. 42-43

Cham

REMOTE STORAGE

THE AMERICAN

GAS LIGHT JOURNAL

RED HANCKENNY, N. Y.

PUBLISHING OFFICE No. 42 PINE STREET

DEVOTED TO THE INTERESTS OF ILLUMINATION, VENTILATION, WATER SUPPLY AND DISTRIBUTION, & GENERAL SCIENCE.

VOLUME XLII.—No. 1.
Whole No. 613.

NEW YORK, FRIDAY, JANUARY 2, 1885.

{ \$3 PER ANNUM
IN ADVANCE.

A. M. CALLENDER & CO., Proprietors. C. E. SANDERSON, Manager.
JOS. R. THOMAS, C.E., Editor.

ENTERED AT THE POST OFFICE AT NEW YORK, N. Y.,
AS SECOND CLASS MATTER.

Published on the 2d and 16th of each month, at No. 42 Pine Street, N. Y.

Terms of Subscription, Including Postage.—For the United States and Canada, \$3 per annum. European countries, \$3.50 (15 shillings—18 francs). All payments to be made in advance. Single copies, 15 cents.

Correspondence.—Wishing to make this JOURNAL a gazette of intelligent discussion to those of our readers who may wish to gain or give information on the subjects to which its columns are devoted, correspondence is solicited for publication from all who make the study of those subjects a pleasure or a profession.

Remittances should be made either by post-office order, registered letter, or bank draft on New York, payable to the order of A. M. Callender & Co.

Collections are invariably made directly from this office, for subscriptions, advertisements, etc. We have agents to solicit the same, but they are not authorized to receipt for money.

Books.—We will mail, post-paid, at publisher's lowest rates, any book—scientific or otherwise—to any address in the United States or Canada. No books will be sent C. O. D.

The American News Company, Nos. 39 and 41 Chambers street, New York, are agents for this JOURNAL. Newsdealers will send orders to them.

CONTENTS.

An Asterisk (*) denotes an illustrated article.

EDITORIALS—

The Iowa Gas Association.....	1
Pratt's Oil Works Go Up and Come Down.....	2
Still in the Land of the Living.....	2
Annual Meeting of the Society of Gas Lighting.....	2
The Value of Municipal Contracts.....	2
Twelfth Annual Meeting of the American Gas Light Association— Official Report—Continued from page 318.....	3
Committee of Arrangements to Manage Affairs of Next Annual Meeting— Deceased Members—An Invitation to Visit the White House—The Reception —Report of Committee on President's Address—Gas Stoves a Means of Revenue, by R. B. Taber—Relation of Capital to Output, by T. D. Gilbert— Report of Committee on Addresses of Past Presidents—Votes of Thanks—Adjournment.	
Results Obtained by the Removal of the Seal in the Hydraulic Main—By Eugene Vanderpool.....	9
The Teaching of Experience in "Competition"—By Antiquus.....	10
That New Use for a Residual Product.....	10
Special English Correspondence.....	11

ITEMS OF INTEREST FROM VARIOUS LOCALITIES.....	12
Correction in Regard to the Wilbraham Exhibit at American Institute Fair —And We Have to Acknowledge Another—Why the Accident Occurred in the Valve-House of the Worcester (Mass.) Gas Light Company—Philadelphia (Pa.) Gas Trust Contracts—Notice of Removal—Metropolitan Company, Brooklyn (N. Y.), Reduces Selling Rates—The Usual Newspaper Style of Prediction—The Louisville (Ky.) Gas War—Death of Mr. W. B. Warren—The Montreal Plumber Escapes Punishment—A Gasholder Collapses—The Proper Way to do It.	
CORRESPONDENCE—	
A Wise Body of Municipal Councilors.....	14
The Market for Gas Securities.....	14
Use of Sulphate of Ammonia in the Garden.....	15

THE IOWA GAS ASSOCIATION.

Two most pleasing features have been decidedly prominent in the doings of the gas fraternity during the past year, and we are inclined to take some share of credit unto ourselves as possibly having contributed somewhat to the advancement and maintenance of the objects that have achieved this pleasing prominence. First and foremost in value of the two—foremost certainly in so far as the pursuit of the practice tends to free established gas companies from the attacks of opposition marauders—is the almost universal desire to reduce selling rates. Not only has this desire been shown in the spirit, but has been followed in practice to such an extent as to make us feel assured that boards of direction will not in the future deviate from the true course that is to guide them in their dealings with the consumer.

The second feature is the increased degree of interest exhibited in the transactions of our associations of gas engineers and managers. It almost goes without saying that these fraternal gatherings have furnished the original incentive whereby was brought into life and action the policy of selling gas at cheap figures. If, then, our engineering societies had accomplished no other good (it hardly need be added that many a beneficent result has followed from their influence) than this, we might even rest contented with such fruition.

One of the greatest disappointments met with during the year in respect to association developments was the failure of the special committee, appointed by the American Gas Light Association to consider the matters spoken of in the annual addresses of Past-Presidents Hickenlooper and Forstall, to agree upon some concerted plan of action whereby the important subjects alluded to in those presidential communications might have become of permanent value to the fraternity at large. The composition of the committee was such as to cause great things to be looked forward to as the result of their deliberations; but, unfortunately, the report presented by them at the Washington session put an end to all such anticipations. The committee, however, in section 3 of their findings (the report will be found on pages 8 and 9 of this issue) give as their opinion that "a complete organization cannot be immediately effective." But they also add, "It is thought that the foundation of the organization may be already laid in the associations that already exist in several of the States," etc. If the gentlemen of the committee were unable to present any specific plan, such inability cannot be charged against them on account of their not having thoroughly investigated the subject; and if, as seems feasible and reasonable, the ends sought for may be finally gained in the multiplication of State Associations, why, then, we are all the more eager to welcome State Societies to our ranks.

Consequently it is with no common degree of cordiality that we introduce to the fraternity the latest acquisition to the banded brotherhood—and take the liberty of making the introduction in the lines forwarded us by an esteemed correspondent—the Iowa Gas Association:

"BURLINGTON, IOWA, Dec. 27, 1884.

"Editor JOURNAL: By invitation of our enterprising friend and neighbor, A. T. Averill, President of the Cedar Rapids Gas Light Company, a few gas men from this part of our State met, on December 17th, at the Grand Hotel, in Cedar Rapids, and organized themselves under the name of the "Iowa Gas Association," electing R. Sponeer, of Burlington, President, and C. M. Williams, of Cedar Rapids, Secretary. After a free interchange of views in an informal way, during the afternoon and evening, the discussion embracing a wide range of subjects of interest to the fraternity of this State, it was

unanimously resolved to meet again, at Burlington, on the third Wednesday of next September. The temperature was intensely cold on date of the initial meeting, and this circumstance prevented quite a number of those invited from being present, but who, no doubt, will find it convenient, and also to their advantage, to be with us at the September meeting. Notice of that event will be given to each one personally in due time.

"Our friend Averill has just finished rebuilding entire, and now has one of the largest and best equipped gas plants in the State of Iowa. Being President and principal owner, by the investment of a large sum of money in this very substantial improvement, he has done a great thing for his town, demonstrated his abiding faith in its future growth, and, at the same time, the permanency and value, both to the community and the investors, of a well-ordered and well-managed gas business. In addition to the pleasure of meeting his friends from other parts of the State, the writer was permitted to partake of the hospitalities of Mr. Averill's genial home during his short stay, and returned back to Burlington feeling that if it were possible for a man burdened with the cares, and subjected to the annoyances, of the gas business to be happy, Mr. Averill must be that man. S."

PRATT'S OIL WORKS GO UP AND COME DOWN.

One of the most important branches of the Standard Oil Company is that known as Pratt's, which is located in Brooklyn (E.D.), on North Twelfth and First streets. The refinery is an immense affair, and its presence has always been looked upon with mistrust and misgiving by the people residing in the vicinity. They have had sufficient reason for such feeling, as every short while a burst up of some kind or another would occur. The Williamsburgh Gas Light Company's works are located on the opposite side of North Twelfth street (the street is only 60 feet wide), and on more than one occasion the gas works employees have been reduced to a state of fear and trembling. It may possibly be remembered that on the night of January 12, 1880, an explosion of one of the large agitators at Pratt's refinery occurred, and such was the violence of the affair that one of the holders of the Williamsburgh Gas Light Company was so badly injured that its contents—in the neighborhood of 100,000 cubic feet—escaped into the open air, but fortunately without exploding. This was the occasion when a certain well-known professor of chemistry in the city of New York, who was afterward called in by the refinery people to investigate the circumstances that led to the outbreak, gave it as his opinion that the exciting cause had emanated from the gas works across the street; or, to put it accurately, the gasholder had been leaking, and the train of escape had been ignited by contact with the light in one of the street gas lamps. By the way, it might just here be remarked that the supposed offending street lantern did not have a single pane of glass broken in it, either before or after the rumpus. But to come back to December 21, 1884. On that date Pratt's works were sadly demoralized by fire and explosion, etc. The flames were not subdued entirely until thirty-six hours after first breaking out, and damage away up in hundreds of thousands resulted—some estimates placing the loss at \$700,000. The Williamsburgh Gas Company's coal sheds and hoist ways were damaged to the extent of probably \$1,500. The Brooklyn *Daily Eagle*, two or three days after the fire, said that "young Mr. Pratt" claimed that the gas works were in some degree responsible for the origination of the disaster; and it is quite possible he is just about "young" enough to believe so. It would seem to the unprejudiced as though here was a pretty good chance for that enterprising professor to earn another fee. He fixed up a worse case to his own satisfaction four years ago, as stated above, right in the same spot; and there is no earthly reason why he should not be able to do so again. Then, again, on mature reflection, we believe Mr. Rogers, one of the important members of the Pratt combination, now takes a great deal of interest in the affairs of the Williamsburgh Company; and this circumstance may possibly stand in the way of the chemist-professor on this occasion. Too bad.

STILL IN THE LAND OF THE LIVING.

Chicago and Philadelphia journalists pride themselves on every possible occasion that they are possessed of nearly every attribute going to make up the ubiquitous; but, still and all, it is just a trifle too bad that sometimes they will make a slip, and the "slip" by its happening has a saddening tendency to convince them that after all their hunt after perfect ubiquity is even yet like unto the search of the ancient student in alchemy, who very often declared that the secret was found—"all but." The latest enterprise in which we have information about our journalistic brethren's newest "slip" is one in regard to their having been ready to publish a certain gentleman's obituary even before the gentleman had "shuffled off this mortal coil," and was still with us hale and hearty in the flesh. The preliminaries were ready, and all that remained was to collect the principal facts so that the funeral sermon might go on; but, to their subsequent consternation, it was speedily

learned that the cadaver was not, and so their tear ducts were closed ere rightly their flow had commenced. The plain facts in the particular case are about as follows.

A telegram, dated Chicago, Ills., Dec. 24th, was received by a Philadelphia newspaper, in which it was stated Mr. Thomas C. Hopper, President of the American Meter Company, had dropped dead at the corner of State and Madison streets in the aforementioned city at a late hour on the evening of the 23d. There was some shadow of excuse for the Lake City man's error, but there does not appear to have been any extenuating circumstance furnishing a loophole of escape for his confrere in the City of Brotherly Love. A Mr. Hopper did give up the ghost on the particular spot at the designated hour, but it was not the American Meter Company's President, although the deceased gentleman (Mr. Alfred Hopper) was a cousin of his. There are few men doing business in Philadelphia more widely known than Mr. T. C. Hopper, and it would seem as though scant investigation, and made at slight trouble, could speedily have satisfied the Philadelphia scribe as to whether the Chicago despatch contained the elements of truth. This despatch was widely copied by newspapers in different parts of the country, and, naturally enough, much to the annoyance and discomfort of Mr. T. C. Hopper and his family. We take this occasion to say to Mr. H.'s friends and acquaintances in the gas business that he is in the enjoyment of good health and spirits, and that not over two weeks ago, in company with his son, the self-same gentleman paid a visit to the JOURNAL office. Those of our friends who have made the tour to 42 Pine street, Rooms 18, 19, 20, and 25, know just what expenditure of wind and muscle is required to reach the editorial sanctum, and from such knowledge may easily infer how likely it would be for a man unpossessed of a good share of vigor to successfully negotiate the trip.

ANNUAL MEETING OF THE SOCIETY OF GAS LIGHTING.

The Tenth Annual Meeting of the Society of Gas Lighting was held in New York city on date of Thursday, December 18, 1884. The meeting was promptly called to order at the hour of 3 P.M. One of the most gratifying features in connection with the routine business of the Society was the excellent showing of the year's work, made perfectly plain by the Annual Report of the Secretary (Capt. F. S. Benson); and no less pleasing was the knowledge of how the finances had prospered under the guiding care of Treasurer James H. Armington. Both reports were ordered to be spread in full upon the minute books.

Ordinary routine business having been disposed of, the members went into an election for officers to take charge of the Society's affairs during 1885, which resulted in the choice of the following-named gentlemen:

President—Joseph R. Thomas.

Vice-President—Eugene Vanderpool.

Treasurer—James H. Armington.

Secretary—Frederick S. Benson.

Member of Executive Committee—Alfred M. Smith.

Finance Committee—William Coombs, Dudley D. Flemming, and C. H. Coggeshall.

The following designation of names and months in which papers are to be presented was made in accordance with the following allotment:

January, Messrs. Theobald Forstall and Fred. S. Benson; February, Messrs. Thomas Turner and F. C. Sherman; March, Messrs. M. S. Greenough and C. H. Nettleton; April, Messrs. E. Vanderpool and F. A. Sabatton; May, Messrs. A. B. Slater and C. H. Coggeshall; June, Messrs. Jos. R. Thomas and James H. Armington; July, Messrs. William Coombs and O. E. Cushing; August, Messrs. S. G. Stiness and C. J. R. Humphreys; September, Messrs. J. L. Hallett and William Farmer; October, Messrs. C. D. Lamson and William Mooney; November, Messrs. A. M. Smith and George D. Cabot; December, Messrs. William A. Stedman and D. D. Flemming.

When the business portion of the proceedings was closed the annual dinner was partaken of; and while it may be truthfully stated that a most enjoyable and delightful hour or two was occupied in its discussion, many references were made to the sorrowful occurrence during the twelvemonth that deprived the members of the genial companionship and hearty counsel of their friend and associate, Mr. C. V. Smith.

THE VALUE OF MUNICIPAL CONTRACTS.—In the early part of December the Corporation Counsel of Jersey City, N. J., rendered an opinion concerning the contract entered into between the city of Bergen (now a part of Jersey City) and Messrs. D. & S. Parrish, granting said gentlemen exclusive right to lay pipes in the streets for the supply of gas. The contract was made in 1868, and was subsequently assigned to the Jersey City Gas Light Company. In view of the opposition movement in that locality the legal validity of this measure became of consequence; hence the appeal for its construction by the Corporation Counsel. That eminent authority on how to break contracts gives it as his opinion that the instrument of 1868 has no standing in court. Jersey formerly had the reputation of standing by its contracts.

[OFFICIAL REPORT.—Continued from page 318, Vol. XLI.]

Twelfth Annual Meeting of the American Gas Light Association.

HELD AT WILLARD'S HALL, WASHINGTON, D. C., OCT. 15, 16, AND 17.

SECOND DAY, MORNING SESSION—THURSDAY, OCT. 16.

Immediately after conclusion of joint discussion on the papers of Messrs. Nettleton and McMillin (given in last issue) President Stedman announced that he had appointed, as a

COMMITTEE OF ARRANGEMENTS TO MANAGE AFFAIRS OF NEXT ANNUAL MEETING, Messrs. A. Hickenlooper, John Fullager, and J. Anderson, of Cincinnati, Ohio; Emerson McMillin, of Columbus, Ohio; and H. J. Reimund, of Lancaster, Ohio.

DECEASED MEMBERS.

The President next called attention to the fact that the painful duty devolved upon him of announcing to the Association the demise, during the year, of two members, in the persons of Mr. W. G. Cartwright, of Hoboken, N. J., and Mr. M. H. Jones, of Easton, Pa. Continuing his reference to the matter, the Chairman said:

It is fitting that proper recognition of their memories be made by their fellow-members, and that such recognition be spread upon the minutes of the Association. The previous course pursued under similarly sad circumstances was to request the President and Secretary to prepare suitable obituary notices and have the same incorporated in the printed volume of the Transactions. As a volume of the proceedings will be published this year, I would suggest that a committee of two be appointed—care being taken to appoint thereon gentlemen who were familiarly acquainted with the deceased members—with instructions to follow the course established by precedent with regard to these matters.

Mr. S. G. Stiness moved that the usual policy of the Association be followed. The motion was adopted.

AN INVITATION TO VISIT THE WHITE HOUSE.

The President called upon Secretary Humphreys to read the following communication, which had been forwarded the Association from the White House:

EXECUTIVE MANSION, WASHINGTON, D. C., Oct. 16, 1884.

Dear Sir—It gives me pleasure to inform you that the President will receive the members of the American Gas Light Association, with the ladies who accompany them, at a quarter past two o'clock to-day.

A previous engagement precludes naming an earlier hour.

Very respectfully,

O. L. PRUDEN, Sec'y.

WILLIAM A. STEDMAN, Willard's Hotel.

Mr. Stiness—I move you, sir, that we accept the courteous invitation of President Arthur, and that we pay our respects to him this afternoon at the time named. An attempt was made to have the reception hour fixed at one o'clock, but a previous engagement of the President prevented such an arrangement. In a conversation held this morning with Mr. Pruden (President Arthur's private secretary), it was stated to the gentleman that the time occupied at the Executive Mansion by the members of the Association need not exceed ten or fifteen minutes. In view of this, it will therefore not become necessary to make any serious inroad upon the time which has been allotted for our session of this afternoon. I think, sir, it is nothing more than proper to one who has so manfully and creditably borne the mantle thrust upon him, that the American Association of Gas Engineers, coming as they do from all parts of the United States, should take this opportunity to pay their respects to him, not only as a gentleman, but also to him as the honored head of our nation.

Mr. Helme seconded the motion.

Mr. M. S. Greenough—I would like to inquire what the intention of the Executive Committee is. Are we to leave the hotel in a body at two o'clock, or are we to meet at the White House at a quarter past two?

Mr. Stiness—The Executive Committee decided we were to meet here. It was stated to the Committee, by the Private Secretary of the President, that at the White House two o'clock meant just two o'clock. In conversation with Mr. Helme, of the Committee of Arrangements (who was much pressed with business and asked me to attend to these details), it was arranged that we should leave here shortly before two o'clock, so as to reach the White House at the hour named in the invitation. Mr. Pruden explained that the President would enter the reception room at exactly a quarter past two. It was thought proper the Association should visit the Executive Mansion in a body, as they deemed that course the more becoming way of paying their respects to the President.

The motion to accept the invitation read by Secretary Humphreys was unanimously adopted.

THE RECEPTION.

When the appointed time had arrived the members of the Association, escorting the lady visitors, and a few invited guests—the total delegation numbering about 250—asssembled in the parlor of Willard's Hotel, and from thence proceeded to the White House. Arriving at the Executive Mansion, the visitors were conducted by Secretary Pruden to the "East Room," and were subsequently shown into the "Blue Room," where their formal presentation to President Arthur was made. The distinguished and affable gentleman received the delegates with his wonted courtesy, and not a single hitch marred the progress of the ceremony.

SECOND DAY—AFTERNOON SESSION.

At three o'clock P.M. the Association reconvened, and the following order of business proceeded with:

REPORT OF COMMITTEE ON PRESIDENT'S ADDRESS.

The President—The Committee on President's Address have presented a report, which the Secretary will please read. Secretary Humphreys then read the following:

"Gentlemen—Your Committee, to whom was referred the address of our President, would most respectfully report that the time before the close of this meeting does not admit of that careful consideration of the topics (so forcibly expressed by him) that their importance demands.

"Your Committee would, however, recall for your consideration, and recommend that some action be taken by the Society at this meeting, on the subject of combating the organized raiders on the gas interests—who are now so active throughout the country.

"Your Committee also recommend that five hundred copies of the address be printed for the use of the members.

F. C. SHERMAN,
W. H. DENNISTON, } Committee."
D. D. FLEMING,

The President—If there be no objection I declare the report received. What further action upon it shall be taken?

Mr. Denniston—I think there should be 700 copies of the address printed, so that two copies may be furnished each member. I therefore move that the recommendation of the Committee be amended by the insertion of the words "seven hundred" in place of "five hundred."

The amendment was agreed to, and the resolution, as amended, was adopted.

A communication from Mr. A. L. Allen, of Poughkeepsie, N. Y., was read, and laid upon the table.

The President—We have a paper contributed by Mr. R. B. Taber, of New Bedford, Mass.; but unfortunately a case of severe illness in his family prevented the attendance of the gentleman at our sessions. The paper awaits your decision as to whether or not it shall be read.

On motion of Capt. W. H. White the paper was received, and Secretary Humphreys was instructed to read it to the Association. In accordance with this plan the Secretary read the communication (forwarded by Mr. R. B. Taber, of the New Bedford (Mass.) Gas Light Company), which was entitled—

GAS STOVES A MEANS OF REVENUE.

Gas stoves represent, I think, a species (in naturalist's phrase) of which the whole question of the application of the heating power of gas to domestic and mechanical labor is the genus; and I confess myself a poor student who hopes much and knows little of the extent of that genus. But the study is everyday becoming more interesting since the additional impetus given by the constant discovery of natural gas in the gas wells of Pennsylvania, and the heating gas operators are developing every day a field which is the legitimate and direct work of the gas companies. Truly, we do not fully occupy our ground in the matter of illumination; the limit of saturation—the point at which the consumer has all the light he wants in the place he wants it, and is fairly satisfied—is nowhere attained, in New England, at least; but I take the hint from the heating company, and am bold to nail my Thesis on the church door of this Association, viz: A gas company shall be able to contract to light a hotel, cook its dinners, run its elevator, and heat its halls, as cheaply as can be done by any one else, and further, do all this more satisfactorily than any other agent, and I will defend my proposition.

The demonstration afforded in the series of the South Foreland lighthouse experiments, that gas has its "unco grip" on the heat end of the solar spectrum, from whence neither oil nor electricity can drive it, might be laid as a foundation for the theory of the heating power in the new study of thermal dynamics. The lately published facts concerning the conservation of heat force as expended in an Otto gas engine gives further encouragement; and the German experiments in the relative caloric effects of different gases drives the gas manager to his benches with a grim smile.

One thing developed the past few years is noticeable. Gas men learned from the steel trade how to apply heat; and the Siemens burner is as great

a success, *per ipse*, as the steel ingot. Mr. Fletcher, of Warrington, has applied to his laboratory apparatus a heated blast of air and gas. Is it possible that in that torrid climate of 2,300°, in which gas first develops, we shall find the first fruitage; that the greatest calorific power and most powerful illumination will be obtained by keeping this intense temperature, or as near this as practicable, at the point of ignition?

Turning now from the genus to the species—the application of gas as heat to domestic uses in the cooking and heating stoves—much that is satisfactory has been accomplished.

Since the gas companies turned their attention to this subject the small, two-ringed boiling stoves, often apparently contrived to emit the worst possible odor, have been withdrawn to give way to the self-supporting ranges—“kitcheners”—set up with iron connecting pipe—no longer summer residents merely, but veritable sojourners in the land. Experience has taught also the New Bedford Company to make all bills for the rental of heating stoves to expire May first of the following year; and to so place the stoves in the kitchens that they may remain all winter to further this object of making the gas stove a fixity. I would not, of course, imply there is no use for these smaller stoves, so serviceable in the nursery and for other small work. I simply call attention to the fact that there is a good call for gas for cooking in winter as well as in summer, and the knowledge that has been gained in practice can be thus formulated. Make your stoves serviceable all the year round.

It is not, in my opinion, a vexed or debatable point, “Can we afford to rent the stoves?” I dare propose, to those who cannot see enough profit in renting them, the other alternative, “give them away;” and in this proposition do not forget that they cost enough—indeed, the gas industry is handicapped by the stupendous price of these ungainly erections. True, we now have nickel trimmings free, and, now and then, steatite burners; still, oh, monstrous! “But one half penny worth of bread to this intolerable deal of sack.”

Would that our friends the gas meter and stove companies would make their wares handsomer and their prices lower, following the example of our gas companies which reduce the price and raise the candle power at the same time.

This much might be said for the system of rental; it brings the stove within reach of all, thereby directly attaining the object sought—increased day consumption. I think a fair rental to cover depreciation, care and labor, may be made to cover all the “outs” of this system.

The theoretical question of what kind of burner is best really is of little practical importance. An essay on this subject would be more fitting to such a body as this than to the occupant of the kitchen. It is possibly certain that the open flame burner under the oven is as available and powerful as any other form. Recent experiments, published in the *English Journal of Gas Lighting*, tend in that direction; but, as to my own judgment in this matter, practice must decide, although it is universally admitted the open flame has none of the drawbacks of the atmospheric burner at the period of first ignition, and this settles that point. For the ringed burners on the top of stoves, the green fires of the Fletcher type, as developed by the Buffalo Dental Company, are specimens of the finest combustion.

Economically the character of the burner is of no importance. All stove makers now manufacture their goods to burn about the same quantity of gas per hour at the same pressure; but more depends by far on the character of the person in whose hands the burner is placed than the kind of burner used; and everything depends on its simplicity and freedom from noise, as also from foul odors.

A gas heater is more profitable even than the cook stove as regards gas consumption; but the attendant circumstances are different. The consumption will perhaps average 50 per cent. more with the latter than the former; but this supply will be taken from mains not now lying idle; and since they are used in closed rooms, fines should be provided for the exit of waste products of combustion. The gas log is simply insufferable without a chimney attachment; the different forms of atmospheric burners are dangerous in tightly closed rooms, and the combustion of air in the open flame arrangement is decidedly deleterious. An experiment was tried with a “Verity fire” in an open grate without flue, which, after the first ten minutes every morning, worked well and without any perceptible odor; but with a flue, and the addition of being well set up, there is no cheerier fire, nor one so easily attended to, or so prompt in its action. I think for closed stoves the flameless fire will ultimately prove the most efficient. This idea is as yet hardly developed by gas stove makers.

After all, to sum up, what is the advantage of the gas stove speculation? Does it pay? As an outside branch of the business it might be said it draws customers, promotes good will, and indirectly prompts the consumer to find other uses for your product, thus accustoming him to the use of gas. If it served no other object, this last would be a great inducement in itself, and would offset the incurring of much care and inconvenience. The other liabilities—interest, depreciation, pipe, labor, etc.—are like unto your service

and meter in disguise, not a direct source of revenue, not intended to be (but really, practically) paid for by the rental.

The stove business, kept as a separate account, relieved by the credit of rentals, at the end of four years stands, say, at \$4,000—this outlay including the cost of many patterns of useless stoves—which dead accumulation can only be charged to that familiar source, “the pursuit of knowledge.” On this capital the depreciation is 10 per cent.—\$400; labor in setting stoves and cost of pipe for present year, \$200; total, \$600. The rentals for the present year on 300 stoves, including heaters, will be \$750, returning, therefore, an interest sum of 4 per cent. on the account. In the same time, however, the day consumption has increased step by step, until it now is three millions feet a year in excess of the ante-stove age, while in all that period not an extra laborer nor a single extra bench has been called in to aid the manufacturing department in making the few thousands feet of output required daily to supply this increased sale.

A heating gas company’s engineer lately informed me he had sold 160,000 cubic feet of gas a day in this branch of our business—employing gas for its calorific uses only. There is surely encouragement, then, for that new race of mortals who shall take the gas so learnedly and wisely made by the gentlemen of this Association, and dispose of it in the infinite variety of ways to which it may be applied.

On motion of Mr. H. B. Leach, the thanks of the Association were extended to the author.

Discussion.

Mr. J. P. Harbison—There are some statements in the paper presented by Mr. Taber with which my experience does not permit me to agree. I do not agree with him in that the proper way of attending to this business is solved by the rental system. I am totally opposed to that plan of procedure. I believe if gas companies generally should go into that style of business they would regret it exceedingly. They would be forced to employ a number of men to look after their wares, because the people who take the stoves, paying only a small rent for them, would feel no sort of responsibility with regard to the condition in which they were kept; and the gas companies would find, as a rule, that the stoves (being made, as they are, of sheet iron) would very seriously depreciate in value if not properly cared for—they would not receive the same share of attention that would be bestowed upon them if the persons employing them had bought them outright. Every housekeeper desires to manipulate matters in her kitchen for herself, and, naturally enough, objects to being dictated to or directed in her domestic affairs by an officer or employee of the gas company. I think such would be the general experience throughout the country. I believe we would be making ourselves a good deal of trouble were we to go into a house and suggest to the lady that she direct her kitchen maid to keep the gas stove clean, to polish it up, to take strict care of the burners, and all that sort of thing, finishing the list of instructions by insisting that all these methods must be pursued with great regularity. Now, on the other hand, if a stove is purchased outright, and is then worn out or destroyed through the owner’s neglect, why, the loss falls upon the owner, and the cost of this matter then ceases to be an expense, *per se*, to the gas company. In our city of Hartford we have had no trouble in the matter of selling the stoves; and we also note that those who are desirous of introducing gas stoves into their houses do not hesitate very long at the price. The Hartford Company, being practically, as the gas brethren all know, a benevolent institution, we do not ask any profit on the stoves we sell. We obtain the largest rate of discount which we can induce the stove manufacturers to grant us; and we give the party who purchases one of them the full benefit of that discount, simply adding the freight to first cost of stove. We also charge a customer the actual cost of connecting material used, also charging the value of time actually spent in doing the work. We do not give away anything. We make a profit on the gas that we sell, but none whatever on the appliances for consuming it. We have had very good success, and have now at work between six and seven hundred stoves in our “little town.” The number is continually increasing; and we have yet to find a single case where the users have not obtained entire and perfect satisfaction. Further than this, we have had no complaints regarding statement of account for the gas consumed. It is not in every case possible that the first attempts to work upon the stove meet with full success; but it is our practice to send an expert to give fullest instructions as to their manner of operation. The expert’s duty is to show in a practical manner that any and every sort of cooking can be done and well done; in fact, that every cooking operation may be performed more satisfactorily, at much less expense, and with far greater comfort, on the gas cooker than with a coal heated range. If gas managers generally should give their close attention to this business, they would undoubtedly find their annual consumption greatly increased. Such has been my experience; and further, as you reduce the selling rates from time to time, you will note the consumption will increase in still greater ratio in this direction. As has been well said in the paper, this consumption, aside from the raw material and cost of purification, practically costs the gas company nothing,

and would require no additional meter (which is a crumb of comfort to the meter manufacturers), and would exact no additional clerical force to make out the bills, for the gas consumed in the cookers would all go into the consumer's lighting account. We find that the plan works well, and is especially desirable of development since the extra demand made upon us may be furnished at that period of the 24 hours when our mains are not driven to supply gas for illuminating purposes. It is a most profitable sort of consumption to us in Hartford, and I have no doubt that it is just as profitable to others who are working in a similar way.

Mr. Pratt—What is the price charged by you for gas supplied to stoves?

Mr. Harbison—At the present time the price of gas in our city is \$1.80; after the 1st day of December it will be but \$1.60—such course having been agreed to by a vote of our directors taken on Monday of this week. (Applause.) In further reply to the question as to what we charge for gas supplied to stoves, I will say that we make no distinction. The gas passes through the same meter as does the gas supplied for purposes of illumination; and we are no respecter of persons in our business. The price is the same to everybody, no matter whether he burns 100 feet of gas in a month or whether his consumption reaches to 100,000 feet in the same space of time. The price in the past has been the same to all, and will be so in the future.

Mr. W. H. Pearson—My experience differs from that of Mr. Harbison in regard to the renting of gas stoves. Of course, being over in Canada, we are differently circumstanced from the position held by you in the States. We have no manufacturers there who will take hold of the business exclusively; and in Toronto we are under the necessity of manufacturing our own gas stoves, or at least a considerable portion of them. We have found, in our attempt to introduce gas stoves, that it is impossible, in the first instance, to sell them outright at all. Having had no experience in the use of gas cookers, the people are not willing to spend \$25 (or more) in their purchase until they know something about them. We were at first, therefore, under the absolute necessity of leasing or renting them, and are obliged to do so even at the present time, in order that the people may become fully aware of their value. My plan has been to charge a sufficiently high rent for a stove to make it desirable for the parties to purchase it at the end of four or five months. I find that people after having had a gas stove in use for four or five months, and becoming satisfied with it (as happens in almost every instance), they will purchase it; and such has been the case more largely this year than ever before. This may partly have occurred in consequence of the fact that on a certain kind of gas stove we decided to charge an increased rent. People are willing to spend four or five dollars in the way of rental when they are not willing to spend a much larger sum in the purchase of a stove. Our experience may differ hereafter, when the people are more fully alive to the advantages and benefits to be derived from cooking by gas. The paper suggests, if I recollect rightly, that, on the whole, the open flame burner was found to be more economical than the atmospheric burner. Just before leaving home I had some tests made with the different burners. I could not make them personally, as I was so much pressed for time; but I have every confidence in the person who carried them out and reported the results. The only sort of stove used in the tests was that of the description furnished by the Goodwin Company, and I should be very glad if someone connected with that establishment would furnish an explanation that would account for the different cooking results obtained when employing the different classes of burners. The stove may be heated by two methods, being fitted with both an atmospheric and an open flame burner. There may possibly have been something wrong about the tests; but if so I cannot trace that something out. The results were as follows: With the atmospheric burner we cooked 6½ pounds of beef in a period of one hour and forty minutes, and a total consumption of 24.9 feet of gas; with the open flame burner the same quantity of beef took three hours and twenty minutes time in its cooking, and a consumption of 42.7 feet of gas. I recently made a test on a stove that is sold in Montreal; operated with an atmospheric burner, it baked 6½ pounds of beef in one hour and forty-five minutes, the duty being accomplished with a consumption of 24.9 feet of gas, or just the same as accomplished in the case of the Goodwin stove. With the stove manufactured by ourselves, and operated with an atmospheric burner, we cooked 6½ pounds of beef in one hour and forty minutes, and with a consumption of 22 cubic feet of gas. In the Montreal stove, fitted with an open flame burner, we baked two loaves of bread, weighing 1½ pounds each, in 55 minutes, the gas consumption being 17.1 cubic feet; with our own stove, heating conditions being identical, the same duty was accomplished in 45 minutes, and with a gas consumption of only 14 cubic feet. In each case, so far as I could ascertain, the bread was baked equally well, and the beef was cooked (as nearly as we could judge) to exactly the same degree. I have often heard that the open flame burner was the more economical, but my own experience does not tend in that direction. I find that the open flame burners, and particularly so those right under the oven, gradually get partially choked up. Perhaps this may be accounted for by the large per-

centage of carbon contained in the water gas manufactured by us, and that such stoppage is not experienced by those supplying coal gas. Taking it altogether, my experience has been decidedly in favor of the Bunsen burner. With regard to the better introduction of gas stoves, I may state that we have found it advantageous to sell the gas consumed in them at a somewhat lower rate than is charged for that supplied for illumination. We are now selling gas for cooking and heating purposes, and also for gas engines, at \$1.25 per thousand feet; our regular price for illuminating purposes to our smallest consumers being \$1.60, and to consumers of over 200,000 feet monthly, \$1.25. Here, again, we differ a little from friend Harbison. The result of reducing the price and introducing the stoves has been very largely to increase our consumption for this purpose. We sent out 200 gas cookers this season. I estimate that our consumption for purposes other than illumination amounts to 12,000,000 cubic feet per annum, and it continues rapidly to increase.

Mr. H. B. Leach—Our experience has been very similar to that of Mr. Pearson. I am very glad that our friend Harbison has got a class of consumers who are willing to purchase the stoves; but in our little village I speedily found it would be impossible to introduce them in that manner, although I tried very hard to accomplish it. Having determined to introduce them at any rate, I found the only successful means of doing so was by renting them. I have been very successful in the endeavor, and feel perfectly satisfied with the result.

Mr. T. Littlehales—My own experience differs somewhat from that of Mr. Pearson. I would almost feel more disposed to give the stoves away than to lease them. We at first tried the leasing policy, and we found that when we had them returned to us the sheet iron would be half rusted through, they would be covered with grease; in short, it would take a man three-quarters of a day to clean one of them up. When we would send the refurbished stove out again, the lady of the house would say: "I don't want a second-hand stove; I want a new one." Then, again, when we charged anything like a reasonable rent, they would say: "What is the cost of this stove?" I would name the price (our rental rate was rather a large percentage on the cost), and the answer would be: "You are a modest man to ask such a large rate of interest on your money as that." Oftentimes they would buy the stove rather than pay what they thought a high rent. We found this style of complaint somewhat of a drawback to the leasing system. We appear now to have found a plan which will work very satisfactorily. When a person wants a gas stove we will say to him that it will do such and such things; that we are willing to put it up in his house, and make the connections; then if it does not do what we say it will we will remove it without cost to him. If, on a trial, it is found to do what we said it would, then we ask him to pay for it. I dislike the leasing plan very much. I believe that the trouble, annoyance and loss by the leasing practice more than counterbalances the advantage in increased send-out.

Mr. Leach—I omitted to say that the parties are obliged to take the same stove the next year if they wish to rent; but if they wish then to purchase we sell them a new stove.

Mr. G. D. Cabot—It seems to me that the matter of renting the stoves is one to be determined very much by the locality. Some of the gas people in towns near to our city rent their stoves, and I know that some of the stoves have been returned in very bad condition. My plan has been quite similar to that of Mr. Harbison—to sell the stoves at cost price. If a person makes any objection to immediate purchase, we put in a stove and let him use it for ten days or a fortnight, and then if he does not like it we will take it out. We have about two hundred stoves now in use, and have never been called upon to take back a single one. It seems to me that the matter of renting is one of those things to be decided upon by the local agent.

Mr. Harbison—Perhaps it is due to myself to state to the Association just what has been our course in our dealing with the people in regard to this matter. You will remember that, some years ago, a member of this Association was requested to furnish the Association with some statistics showing comparisons between cooking done upon gas stoves and that upon coal ranges; also statistics regarding the cost of fuel, and with respect to the results in weight of meats cooked, the percentage of loss, etc. I succeeded in obtaining a large number of copies of that table of statistics, and I have had them very generally distributed amongst our consumers. We have not hesitated to stake our reputation on the correctness of those statements. We have assured the people, on the strength of those statistics (knowing that the author was ready to back up any assertions that might be made which were not any greater than he had put forth), that there would be so great a saving in the weight of meat cooked on the gas stove, as compared with that cooked on the coal range, as to pay for the cost of the fuel used; so that really, in point of fact, it did not cost the householder a farthing for gaseous fuel for cooking purposes. When a man can boldly and unreservedly make that statement and be prepared to back it up with figures, there is no difficulty in selling stoves at cost rather than renting them. It at once takes away all objection to immediate and outright purchase. We can as-

sure them that it will not cost anything for fuel, that the cooking will be better done, and that it will be pleasanter and more convenient to them every way than was the old practice. I first demonstrated the accuracy of the statistics to my own satisfaction, by placing a cooker in the kitchen of my own residence, and making thereon a series of careful tests. The tests were convincing, and so I placed myself in the position to say to my consumers that the printed tables were accurately truthful. We have found our people ready to believe what we say with regard to it, and find them so now, too. I will say, further, that I do not know of a single case, since we commenced selling gas stoves, where a party has declined to own merely because it cost him something to do it. Every party who expressed a wish for a cooking stove has bought it and paid for it, and no one has declined to take a stove because we would not rent it to him.

Mr. Pearson—I may say that in Toronto I have done everything that Mr. Harbison has stated—possibly a little more. Every gas bill has printed upon its face, in such a place that everyone who reads it must notice it, a brief statement of the various advantages of gas cookers as compared with coal ranges. In addition to that, every gas consumer has more than once had circulars sent to him containing information with regard to the comparative amount of loss sustained by various articles of food during the process of cooking; yet, notwithstanding that, we have not been able (or not until very recently) to get the people in our city to purchase gas stoves. I might mention another matter connected with the gas stove business, and that is with reference to the attempt to introduce the use of gas stoves throughout the whole of the year. The principal objection made by my people to keeping them up all the year has been that, with the ordinary gas stove, they cannot heat water for their baths. I might mention that our street foreman, Mr. Laxton, has, after a good deal of experimenting, introduced a system of burners into an ordinary cooking stove; that cooking stove will cook by gas as well as any gas stove that I have ever seen, and the cost of introducing the pipes is only some seven or eight dollars. Underneath the water heater in this stove are placed a couple of Bunsen burners; and they will sufficiently heat water for the bath. A patent has recently been obtained for it, covering the United States as well as Canada; and members of the Association will soon hear more about it. I am satisfied it is going to fill a gap which we have felt to be a wide one for many years past.

Mr. T. D. Gilbert—If there is anything connected with the gas business that I may claim to be conversant with it is perhaps this very question of gas stoves. The discussion we have listened to all goes to show that if gas managers will in some way bring good gas stoves before their communities they can get good returns from them. One man may have better luck in renting, another may have better luck in selling, and yet another may find it to his interest to give them away. But that is not the point. The real question is, "Can we get the people generally to use them?" My own experience corresponds with that of Mr. Harbison. I first put a gas stove in my own house and satisfied myself that it was a good thing. Then the neighbors began talking about it. I got some of the more experimental of the residents to make a trial of them; I told them to bring the stoves back if they did not like them. By and by one after another began to employ them, and everybody liked them. At the beginning of the new year they did not go fast enough to suit us; so we took 20 per cent. discount right off from the manufacturer's prices, and thought it was a good investment. To show that it was, we got our money back in three months on every one of them so sold. This all goes to show that there are a hundred ways in which we can get these stoves before the people and induce the consumer to use them; still, the main point is, the greater the number we get into use the better off we shall be. As to the best way of effecting their introduction, it would seem as though each must be governed by his own necessities and experience.

Mr. Harbison—What is your price for gas per thousand?

Mr. Gilbert—Our average price, or the rate at which most of our consumption is supplied, is \$1.70. We are located away up in the wooded district (Grand Rapids, Mich.), and are obliged to haul our coal by rail for close on to 600 miles.

Mr. Starr—Are all classes of your supply registered on one meter?

Mr. Gilbert—The consumption is all registered on one meter, whether used for illumination or for cooking. We had at one time quite a serious opposition developed in the introduction and use of gas stoves. Twenty years ago we began the sale of gas cooking apparatus; and during the first seven years our success was so great that 95 per cent. of our consumers used gas stoves. The stoves, however, were all of very small sizes, but were found very effective. When the larger stoves and ranges came out some two or three years ago, our people wanted to get them and willingly gave up the small affairs. We have now about 250 large stoves at work in our town. It has been rather a misfortune to the gas interest that gas stoves have been so poorly arranged. They are made too deep and too short. You can only get one pie in an oven at one time; and people object to employing so much heat for such a small cooking operation. I understand that a gas

stove is now being manufactured which has an oven 18 or 20 inches in length; this improvement is in the right direction. There is no trouble in constructing gas stoves so as to deal properly with the products of combustion. The injurious and noxious fumes may all be safely carried off by simple flue connections. I am in hopes that by next year our gas stoves will have been so improved in shape and size that they will be rendered really invaluable to the housekeeper. We have labored under great difficulties heretofore on account of the cramped oven. I have not been a thorough advocate of the gas stove until this year. As to renting or selling—I tell any man who asks about the gas stove that I will set one up in his house free of cost to him; then, if he does not like it, I will take it back. In one or two instances I have had to take them back; but it is indeed very seldom that I am asked to do so.

Upon conclusion of the discussion the Chairman called for the reading of the next paper on the list, and accordingly introduced Mr. Thomas D. Gilbert, Secretary and Treasurer of the Grand Rapids (Mich.) Gas Light Company, who read the following paper on the subject of

THE RELATION OF CAPITAL TO THE OUTPUT.

The proportion of capital to its product should always be intimately considered by those seeking investments. If, through mismanagement or circumstances beyond control, any enterprise absorbs more money than is necessary to the accomplishment of a given amount of work, the result will be either small dividends or the charging of a price for the product that will induce competition from others who may wish to engage in the same business, and who perhaps will accordingly be enabled to do so under more favorable auspices than did the pioneers.

Heretofore this question of a proper relative proportion between the amount invested in gas works and the output of gas, or product of the capital, does not seem to have received much consideration. The reason is obvious, and may be briefly stated thus: Outside a few seaboard cities that had already attained considerable prominence before gas came into use, the organization and early history of all our gas companies has been much the same. Given a thriving town of a few thousand inhabitants; a few energetic men, with perhaps limited means; an exclusive charter from the municipality, with the right to charge what now seems to have been a high price for gas; works of a very limited capacity, built without reference to possible future needs; a steady increase or demand for light, until enlargement became necessary; again, an insufficient investment, owing to want of means or lack of faith in the future, etc.; tearing down and building greater, and we have the history of most of the gas works in the country.

All managers of gas property understand perfectly well that, could they start anew, it would be easy, with present knowledge and experience, to renew their plant with a smaller investment than was possible under former methods. On this enhanced cost stockholders naturally expected their dividends; and so it has come about that, in most places, high prices have been maintained, the use of gas restricted, managers became unpopular, and the business, in public estimation, became a synonym for everything disreputable.

Protected by supposed exclusive rights, the business was a monopoly; and it cannot be denied that until quite recently there has been shown a great want of that progressive spirit on the part of gas managers which gives to all business its best results. Under these circumstances new methods and new lights came into existence. Competition, encouraged by stubborn adherence on the part of old companies to high prices, obtained a foothold in many places, and the owners of gas property were obliged to consider the question whether the capital represented by their stock was not excessive. There is but little invested capital that occupies so precarious a position as gas property at the present time, unless well managed. The manufacture and distribution of gas is a business so peculiar in many of its characteristics as to be almost outside the domain of rules governing other enterprises. Capital once thus invested cannot be moved; and if not profitable, is lost forever. Competition is so deadly to it that it is impossible for rival companies to occupy the same streets without ruin to both, or a consolidation, with its attendant double investment, and cheap light rendered an impossibility.

How to avoid the evils of competition and an unnecessary investment of capital are questions that must be considered; for on them rests the value of all gas property. The exact amount of investment necessary or proper to produce one million cubic feet of gas is, of course, impossible to fix, owing to varying conditions of population, business, and cost of material. A densely populated district, with its usual proportion of large consumers of gas, should require a smaller proportionate investment than a sparsely settled territory, and hence be able to obtain gas cheaper; but it does not always work out in that way. The cost of many of our gas works has been enhanced by circumstances beyond control. In this country more than in any other we have periods of unusual development in all our cities. In the West we call it a "boom;" and "booms" have usually been contemporaneous with times of great railroad development.

These abnormal conditions have usually made necessary large present investments intended to meet future increased demands for gas and the money placed at a time when iron and labor (factors which enter so largely into the cost of gas works) were unusually high. Have we a right to expect full dividends on capital invested under such circumstances? Undisturbed and exclusive possession of the territory occupied is essential to success in our business, and will be beneficial to the public, if we deal fairly with it; but we have no right to expect it, unless we are content with moderate dividends on a fair valuation of our property. The interests of all who own gas property are so interwoven that what benefits or injures one benefits or injures all; and this is my only apology for calling the attention of the Association at this time to a question which is of more essential importance than any other connected with our business. If a company, favorably situated, persists in maintaining prices that seem excessive, for the purpose of paying dividends on excessive capital, it may be sure that rivals, attracted by a seeming opportunity for good investments, will, sooner or later, obtain a foothold, with the usual result of gas sold without profit, until both parties tire of the foolish contest, and "pool their issues." Then the public pays a price for light that will earn and pay dividends on the double investment; and a just relative proportion between the capital and the output rendered forever impossible. During the time that rival companies are furnishing gas at, or below, cost, their pernicious example is quoted as proof that prices elsewhere are excessive; and so it happens that this senseless rivalry works great injury to those who are earnestly striving to keep down their investments with a view to furnishing light at the lowest price consistent with reasonable dividends.

You will notice that I have not undertaken to say anything in this paper about what my own ideas are on the subject, because it is impossible to establish a rule which will be fair in all localities. I merely state in general terms what the policy of my company has been. Our city is not a very large one; we have only about 42,000 inhabitants; and we are now experiencing decided symptoms of the electric lighting craze. For many years we have been selling gas at much cheaper rates than those obtained in most of the large cities in our country. Cities like Detroit, Indianapolis, Chicago and New York have been charging from 20 to 25 per cent. more for gas than we have been charging. We have been satisfied with our dividends, and have been moderately successful. We found that our capital was increasing out of proportion to our output, for the very reason that we were compelled to rebuild when material was high. We have laid pipe in our street mains that cost us \$75 per ton; and we also have pipe that cost us but \$30 per ton. We were brought face to face with the question of how much of that cost we ought to charge up to construction. We have during the last six years adopted the policy of charging everything to expense that pertains to the enlargement and extension of our works, and give our stockholders the benefit of the rest of it. One result of this has been that we are now fairly successful. The people have been satisfied with the price of gas; and there has been no trouble as yet with competition. They may come "nosing" around us by-and-by, but there is not much temptation for the wreckers in view of the price at which we are selling gas. We think, on the whole, the policy we have pursued has been the better one. Of course, in the large cities they have their investments made; they also have their combinations, and they have things so arranged that what would apply to most of us would not apply to any of them. I take it, from what I have been able to hear and learn, that most of us here represent companies in the smaller cities. We have heard nothing said from the larger cities. I think that our interests are identical, and are all in the direction that I have taken the liberty to point out in the paper, which I submit to you for what it is worth.

On motion of Mr. Helme a vote of thanks was tendered to Mr. Gilbert.

Discussion.

Mr. William Helme—What is your capital and your output per annum?

Mr. Gilbert—Of course there are things connected with all gas companies that the owners do not care to publish; but I shall be very happy, in any private conversation with the gentleman, to give him any information of that kind desired.

Mr. Starr—What is the price of your gas?

Mr. Gilbert—We have three classes of customers: Those who consume 5,000 feet per month are charged at the rate of \$1.60; those who use between 1,000 and 5,000 feet pay \$1.80; and consumers of a lesser quantity than 1,000 cubic feet in thirty days pay at the rate of \$2 per thousand. We are of the opinion that our schedule is a low one. Mr. Harbison calls particular attention to the fact that all classes of his consumers are supplied at one price. Of course, he does his business in the manner deemed best by himself; yet it seems to me that the practice is not consistent with the general law of trade. You can always buy 100 yards of any material at a lesser figure than if you purchased but one yard; and it is perfectly proper that such should be the case. It is no more troublesome to take the register of a meter that has passed 10,000 feet in a week than it is to take the one that

has passed but 100 feet; indeed, I never could see any justice in putting an all-round price upon the gas sold. The increase in our business over that of a year ago, owing to the reduction in price and on account of the more general introduction of gas stoves and engines, has been so great that I can see the way clear to another considerable decrease in price in the very near future. There has been an advance of 20 per cent. in our output during the last year.

Mr. Helme—At what figure were you selling gas on the 1st of October, in year 1883?

Mr. Gilbert—At an average figure of \$2 per thousand cubic feet.

Mr. Helme—What is your output now?

Mr. Gilbert—The annual output now is 50,000,000 cubic feet.

Mr. Harbison—How many miles of mains have you?

Mr. Gilbert—About 24 miles.

Mr. Helme—If Mr. Gilbert has a capital of half a million dollars, he has \$10 invested for every thousand cubic feet of output for the year. I presume that his capital is very much less than that; and I do not doubt that his establishment is in excellent financial condition. If any of his shares are for sale at par I would like a chance at them.

Mr. Gilbert—I will tell the gentleman that I consider an investment of over \$5,000 to a million feet of output too large.

Mr. Helme—Any man who has stock in a gas company which has only \$5,000 invested for each million feet of output per year is in a very good condition. It is almost impossible to avoid putting more money than that in building gas works, even at the present time. Ours is a very peculiar business. What would be a very good rule in any other business does not always work out well in this. Towns that grow are eternally wanting you to extend your mains. Nine-tenths of your stockholders are not found in a proper financial condition when a sudden call is made upon them to contribute the capital necessary for an extension of the mains. What is the result? It is what every Californian understands by the words "freezing out." Those who cannot respond are frozen out; and this is not fair. There may be a few who are able and willing to respond; but the poorer ones will find themselves out in the cold. And yet, if you attempt to keep down to \$5,000 of capital invested to each million cubic feet of output, you will soon be in need of money to extend your mains; and if the extensions are not made you will have rather a lively time in quieting the demands made upon you. Every time you meet a resident of one of your suburban districts the first request will be, "When are you going to extend the gas mains out to my house?" After one or two oral applications of that nature are made from several residents of a particular district, and when it is found that the gas company is not acting quickly enough to suit the views of the complainants, why, the malcontents at next election elect a Councilman, perhaps, who will annoy you very much. In such suburban main extensions you are often required to spend thousands of dollars on which you get but sparse returns. If you measure in all cases the amount you must expend by the amount of business you get, the investment will sometimes amount to \$50 on a thousand feet. Under those circumstances what would you do? There are a good many here who would like to know from Mr. Gilbert just how he would solve that problem.

Mr. Harbison—I think Mr. Gilbert has answered it by the statement that he charges a portion of his consumers \$1.60 to \$1.80 per thousand, while the remainder pay \$2. Those who are paying him \$1.80 and \$2 are contributing the means, in the excess of price charged over their fellows, for making these enlargements. He charges the expense to construction account, and gives the stockholders what is left; and thus, according to his statement, they seem to be perfectly satisfied with. By his scheme the poorer people of Grand Rapids are extending his works for him, and are doing so for the benefit of the rich. My practice is in accordance with the example set us a great many years ago, in paying the laborer who wrought all day at the same rate as the one who wrought but an hour; and the one who wrought an hour at the same rate as the one who wrought all day—putting them all on the same footing. That is precisely the sort of golden rule that we are following. We make no distinction, but treat everybody alike, and try to gain the goodwill and confidence of all. In that way you increase your business so largely (and by bringing the price down low to begin with) that you have no difficulty in bringing the pro rata of percentage of the amount invested in proportion to your output; and you thus accomplish it in a way much more satisfactory to the people, and also to your own conscience. You can thus secure a low rate of investment in proportion to the amount of gas sent out.

Mr. Gilbert—This discussion has taken somewhat of the form of an arraignment; and I desire to say this much in reply: Our very smallest consumers are furnished with gas at \$2. Mr. Harbison speaks of that rate as being excessive; but I hardly think that he meant to use that term in an offensive sense.

Mr. Harbison—Not at all.

Mr. Gilbert—Even our smallest consumers in Grand Rapids have had gas, for the last year or two, at a less price than that paid by the large consumers

in a great many of our chief cities; and so we have no cause for conscientious trouble about it. We feel, indeed, as though we had been working for the good of all of them. If this discussion will only bring the gas fraternity to consider the question whether they will not put down prices, and get along with less capital, before they tempt competition and ruin their property, it will not have been in vain. That is the real problem before us. You cannot afford to invite competition. Of course, there may be differences of opinion about the policy of having varying schedules of prices; but it has been a good rule in all other classes of business to make such differential rates, and to our people the management has been, and is, perfectly satisfactory. Nobody complains. The man who lives on the outskirts, and pays \$2 per thousand, is perfectly satisfied, and would almost (because we have run the pipe to him) be satisfied at price. My friend Helme inquires how we can extend our mains without calling on the stockholders for more capital, and thus perhaps freeze out somebody who cannot respond. It is because, as I have already stated, if we have accumulated a surplus, (no matter how small it may be) beyond what we consider a fair dividend, we invest that surplus right into the operation of main extension. Perhaps we could lay by enough to add three or four miles of main to our system, possibly we could add but one mile in the twelvemonth; but we are all the time doing something in that direction, and always in those districts where the action will be most beneficial to us. We certainly have a good deal of pipe which is not productive; but the people living in those neighborhoods are generally folks who do business down town, and are consequently using gas in their stores and shops. At any rate, I know the plan works harmoniously with us.

Mr. W. H. Pearson—What do you consider a decent dividend?

Mr. Gilbert—That depends upon what the people have been accustomed to receiving.

Mr. Thos. Butterworth—Are the parties who originally owned and built the Grand Rapids works also at this date interested in the management?

Mr. Gilbert—Yes, sir.

Mr. Butterworth—There has been no "freezing out"?

Mr. Gilbert—No. We now have some of the same men in the company who were in it at the beginning, and when we were only sending out one million cubic feet per year.

Mr. Helme—What are Mr. Gilbert's dividends? Let us hear that.

Mr. Greenough—I want to say that I am very glad Mr. Gilbert has brought this thing up. Mr. Gilbert may possibly look upon himself as a man who has been arraigned for an imposition; but I want him to understand that there are a good many men in the gas fraternity who are backing him. It is a principle which has been active in the guidance of a good many gas companies. I think it is wrong to load up any sort of stock with all the water it can carry; and if the plan of the stock jobber is brought up in this meeting, it ought to receive the condemnation of the Association. It is a matter which has not in this country received the attention that it deserves, although it is a question that is gone into pretty carefully on the other side of the water. One of the most careful figurers in the gas profession a few years ago read a paper on the relation of capital to output, and in it he took the ground that any company with over £5 capital for every ton of coal carbonized, had got too much money invested. Putting that into our money it means that you must earn 25 cents per 1,000 feet of gas sold, in order to pay a ten per cent. dividend. The old English figure is one shilling for gas, one shilling for distribution, and one shilling for interest; but we cannot do that on this side of the water; although the company with which I am connected have, by pursuing the policy which Mr. Gilbert has followed in his company, brought themselves into very nearly that position. We have not got to earn much more than 25 cents in order to pay our dividend, and we are consequently in first-class fighting condition. I have no doubt that you can today put up works in all the large cities which as dividend payers will not require over 50 cents earned per thousand feet of gas consumed. When people allow themselves to put more stock than that into gas works, I think they are loading the business with more capital than it is intended for. I think this Association desires to endorse the views of Mr. Gilbert in giving an expression of their opinion on this matter. (Applause.)

Mr. Eugene Vanderpool—I have to differ with my friend Greenough with reference to the amount of capital invested in gas works in England in proportion to the number of thousand feet of gas distributed per annum, and to state that one shilling will not, in all cases, pay ten per cent. interest on the capital. I have some memoranda here which I took from Mr. Field's analysis of the accounts of the London gas companies, the suburban companies, and the provincial companies, both those owned by the cities and those owned by private corporations. I find that the capital, per thousand feet of gas sold per annum in London, is \$3.22; of the suburban companies, \$3.62; of the provincial companies owned by the cities, \$3.52; and of the provincial companies owned by private corporations, \$2.94. But the sales of gas there are much larger than with us, being in the city of London 5,580 per annum per head of population; in the large towns, 4,238; and in the smaller towns,

2,500 to 2,800 cubic feet. I have the returns of a number of companies in this country, and find that the capital invested, per thousand feet of gas sold per annum, will run, in towns of from five to ten thousand inhabitants, at about \$15; from 10,000 to 25,000, \$8; from 25,000 to 50,000 inhabitants, \$8; and from 50,000 to 100,000, \$7; and from 100,000 and upwards, \$6.25. The sales per head of population vary from 400 feet in the small towns, to 2,600 in the large cities. We must remember that in this country materials and labor are from two to three times higher than in England.

Mr. Greenough—As I understand the gentleman's figures, he says that from a population of a hundred thousand up the investment averages about \$6.25. You have to earn 62 cents in order to pay 10 per cent. dividend. I do not think that that invalidates my position at all. Mr. Livesey took the ground that those English companies had too much capital invested; that a good deal of the capital of the chartered companies was invested uselessly, and, to a certain extent, was thrown away. Those works could be replaced to-day at figures which would pay 25 per cent., beyond doubt. If the capitals of companies in this country be taken into account, I want gentlemen to remember how much capital has been put into most of our large cities which is uncalled for and unnecessary. In the city of New York to-day there is some \$26,000,000 of capital invested owing to competing gas companies. Will the gentleman tell me that if new works were to be there built, \$15,000,000 would not be ample to supply the needs of New York's consumers? In Baltimore (Md.) they had 9½ millions dollars invested before they took in the new Equitable Company into the last arrangement; yet at Baltimore they do not sell as much gas as we do in Boston, with but one-quarter of their capital. In Chicago (Ills.), as in some other large cities, they have a large amount of stock which is not represented by plant, etc. If the gentleman wishes to take the actual cost of the work, or what the stock should really represent, he will not, in my judgment, find the sums figure out to \$6.25.

Mr. McMillin—One of our noted gas financiers, Gen. Andrew Hickenlooper, of Cincinnati, Ohio, some years ago investigated this question pretty thoroughly; and in his annual address to this Association he spoke of it. His estimate for the entire country was about \$8 per thousand. In the preparation of a volume of "Economic Geology for Ohio," I had occasion to investigate the question pretty thoroughly; and I found that sum (\$8) was just about what was invested per thousand in the State of Ohio. The figures agree pretty well with those presented by Mr. Vanderpool. From the Columbus (Ohio) works we sent out last year 120,000,000 feet, and this year we will probably send out 150,000,000. Our capital, up to the first of last April, was \$400,000, but it has since been increased to \$500,000.

Mr. Wood—I think possibly one of Mr. Gilbert's remarks has been either overlooked or forgotten. This is in regard to the assertion which enables him to pay out of expense account for the extension of mains, declare dividends, and sell gas at a low price. It may be accounted for in his case in this way, owing to low distribution charges. He has only 24 miles of mains for conveying an annual output of 50,000,000 feet; and I think that main mileage is very largely below the average of companies represented here. It seems that his town is very compactly built up, consequently his conduits do not extend for miles out into the country, as is the case with many of us. His cost of distribution, therefore, is brought down to a minimum, which fact enables him to do as he has told us.

Mr. Gilbert—We have five or six miles of mains that do not pay 3 per cent. on the investment.

Mr. Helme—What were you selling gas at last year?

Mr. Gilbert—Two dollars per thousand on the average.

Mr. Geo. B. Neal—The hour fixed by the Committee of Arrangements for adjourning is six o'clock, and we have still the report of the Special Committee on the addresses of Past-Presidents Hickenlooper and Forstall to consider. While this discussion is very interesting, it seems to me that we shall not now have time to prolong it if we propose to adjourn at six o'clock. I would therefore suggest that we proceed to consider the report on the President's Address. I think we should not allow any discussion, however interesting, to crowd out the reception of the report mentioned.

The President—If it be the pleasure of the Association we will now listen to the report of the Special Committee appointed to consider the suggestions embraced in the inaugural addresses of Past-Presidents Hickenlooper and Forstall.

In accordance with the President's request, Mr. Eugene Vanderpool, chairman of that Special Committee, presented and read the following report:

REPORT OF COMMITTEE ON ADDRESSES OF PAST PRESIDENTS.

To the Members of the American Gas Light Association—Gentlemen: The Committee appointed by you to consider the recommendations contained in the annual addresses of Past-Presidents Hickenlooper and Forstall, would respectfully submit the following as a supplemental and final report:

1. It is the opinion of your Committee that it would be decidedly advantageous to the gas interests of the country if there was an organization prop-

erly officered and efficiently supported that would represent in a general way the gas interests of the country.

2. This organization could determine in an authoritative manner mooted questions of a technical character that now exist, or may hereafter arise, in our industry; and might also be instrumental in preventing the formation of so-called competing companies, and in obtaining legislation that would harmonize the interests of the consumers and the companies.

3. After much thought your Committee is convinced that a complete organization cannot be immediately effective; its growth will require time and experience. It is thought that the foundation of the organization may be already laid in the Associations that already exist in several of the States, having for their object the protection and advancement of their mutual interests. And it is hoped that at this meeting of the Association the members present representing companies interested in their State organizations will confer together and consider the expediency of taking prompt action in the direction suggested.

EUGENE VANDERPOOL,
THOS. TURNER,
A. B. SLATER,
A. C. WOOD. } Committee.

The President—If there is no objection the report of the Committee is received. What action will you take upon it?

Mr. J. P. Harbison—I move the report be adopted, and printed in the JOURNAL, and that the Committee be discharged.

The President—Are there any remarks to be made upon the motion of Mr. Harbison?

Mr. E. McMillin—It is unfortunate that the report was not presented at the beginning of the session, when we would have had sufficient time to digest it. It is now too late to discuss it properly.

Mr. Vanderpool—I will state that some of the members of the Committee did not arrive here until last night, consequently we did not hold a meeting until to-day.

The President—If there is nothing further to be said, I will put the question upon the adoption of Mr. Harbison's motion.

The motion was agreed to, and the President stated that routine business was in order.

VOTES OF THANKS.

Mr. Harbison—One year ago when the Committee on Nomination of Officers for the year now drawing to a close made their report, and in it presented the name of William A. Stedman, of Newport, R. I., for the office of President of this Association, the members who were personally acquainted with that gentleman knew (when subsequently he was unanimously elected President of our organization) that the proceedings of the year would be conducted with at least as much thoroughness and earnestness as had been those of any previous period in our history; and some of us who knew him intimately felt that our sessions might exceed in value those that "had gone before." I believe, sir, it is the unanimous opinion of the members of this Association, that such pleasant anticipations have been more than fulfilled, and make bold to say that our Twelfth Annual Session stands at the top of the record. There has been a notable increase in our adherence to rules of order, a much greater attention bestowed upon the reading of the papers, and a more generous participation in the discussions than has been witnessed at any of our previous meetings. It affords me, then, very great pleasure to move that a hearty vote of thanks be extended to President Stedman for the most efficient, able and courteous manner in which he has discharged the duties of his office during this session. (Applause.)

The motion was seconded by Mr. Butterworth, put by the Secretary, and unanimously agreed to by a rising vote.

The Secretary—Mr. President, it becomes my pleasant duty on behalf of the members of this Association to extend to you their heartfelt thanks for the very courteous and able manner in which you have presided over the affairs of the Association during the past year.

The President—Gentlemen, I wish to acknowledge what seems to me to be in the nature of an extraordinary courtesy on your part, and to say to you how much I am gratified at this expression of your favor in making such graceful recognition of the manner in which I have filled the Chair. Brother Harbison always had a remarkably keenscent after the good qualities of his neighbors, and a very hearty appreciation of them; indeed I can assure you he is an extraordinarily good friend. I was not, however, aware that I had done anything more than my simple duty, and a twelvemonth ago, when I accepted the office, I promised you that I would do the best I could. Necessarily the great bulk of the labor in preparing for the meeting, in arousing and maintaining the necessary interest among so many widely-scattered members, devolves very largely upon the Secretary of the Association; and I feel that it would be wrong for me to take to myself any large measure of the praise due (if there be any due) for the success of the meeting; and I so say because the gentleman beside me, as your Secretary, has done such hearty, faithful, assiduous and untiring work, that he has entirely surpassed me in

my efforts to make this meeting a success. Perhaps it may be an unparliamentary thing, nevertheless I am going to ask you to accord to the Secretary a hearty vote of thanks for his efficient labors on our behalf during the past year, and to that expression of your recognition I desire to add the tribute of my sincere admiration for his work and its result. Since I was in a position to know the amount of labor involved, and of the earnestness and fidelity with which every part of that labor was accepted and performed, and knowing what he has done, and how faithful to your interests he has been, I will ask you to pass a very hearty vote of thanks for the fidelity with which he has discharged all the duties of his office during the past year.

Mr. William Helme—I take great pleasure in seconding the motion of President Stedman.

Mr. Harbison—I desire to add a single word to what our President has said with regard to our worthy Secretary. I had a few minutes' conversation with a member of the Finance Committee right after the Committee had made their report, and after the Treasurer's report had been adopted by the Association. This gentleman informed me that in all the years of his acquaintance with the financial affairs of the Association he had not seen anything to compare with the manner in which the Treasurer's books had been kept during 1884. Now, not reflecting in the slightest degree upon the manner in which our former Treasurers have discharged their duties, I think the complimentary terms which this member of the Finance Committee used in regard to the way in which the books had been kept during the past year should be known to the members of the Association, and that it is due to our Treasurer that a public recognition of his services should be made. The report which was read yesterday was exceedingly creditable in respect of the manner in which the accounts had been kept. It was a very clear and comprehensive detailed statement of the financial condition of the Association at the present time, as well as a record of the business of the past year. I am heartily in accord with the motion.

The President—If there is nothing further to be said, I will put the motion: That this Association accords its hearty vote of thanks in testimony of its appreciation of the signal ability with which the Secretary has conducted the duties of his office during the past year. I think that we can compliment him by a rising vote.

The resolution was unanimously adopted in the manner indicated by the Chairman.

The Secretary—Gentlemen, I am very deeply touched by this kindly expression of your approval, and I can only say to all the members of the Association, and particularly so to the President, that my heartfelt thanks are due.

Mr. S. G. Stiness—Before this Association adjourns it owes it to itself to make some recognition of the very assiduous labors of a most indefatigable Committee of Arrangements, who have so well provided for our comfort and entertainment during our sessions in the city of Washington. I move that the thanks of the Association be extended to the Committee for their attention to our comfort.

The motion, seconded by Mr. Starr, was unanimously adopted.

Mr. William Helme—It is a great source of satisfaction to be able to feel that the Committee of Arrangements are entitled to an expression of approbation for what they have done. As you all know, Mr. Geo. A. McIlhenny is not very well able to get about, and it therefore devolved upon me to do what he would have done had he been in good health. We have done our best, in connection with the Secretary, to make everything satisfactory in so arranging matters that you may have had a pleasant time, and carry with you to your homes a pleasant memory of our meeting in Washington. I hope we may all meet next year with General Andrew Hickenlooper, in Cincinnati, Ohio, where he has promised to show us his new and handsome works; and I have no doubt that his and our expectations in respect to them will be in every way realized.

At this point the business sessions of the Twelfth Annual Meeting were adjourned *sine die*.

[A Paper read before the Society of Gas Lighting.]

Results Obtained by the Removal of the Seal in the Hydraulic Main.

By EUGENE VANDERPOOL.

The paper on this subject recently read by one of our members, and the interest and discussion induced thereby, have led to an examination of the results obtained by the removal of the seal from some of the dip pipes in the works of the Newark (N. J.) Gas Light Company.

Mr. McIlhenny was, I think, the first to invent and use a system for removing the seal, and he was followed at a later day by a great number of men who devised many methods of doing the same thing.

It was claimed ten years ago that by the removal of the seal the following results were to be obtained:

1. A larger yield and improved candle power from the same coal distilled at like temperatures.
2. A greater production of gas per mouthpiece, and a consequent saving in labor.
3. The prevention of the formation of carbon in the retorts.
4. The prevention of stoppages in the stand, bridge, and dip pipes.
5. A greater durability of the retorts.

The results that have been published in regard to the matter are quite contradictory, and the statistics we have are not entirely satisfactory or conclusive.

We put on the dip pipes of a number of our benches the same kind of valves used in the New Haven (Conn.) and some other gas works of the New England States. We have used these valves during a period of six years; and to determine whether there was a saving made by their use, the results obtained from these benches have been taken and compared with those obtained from other benches of the same general construction, and fitted with retorts and fire material made by the same manufacturer.

When using the valves a pressure of three-tenths of an inch was always maintained in the retorts fitted with them, the seal of the other retorts varying from three-quarters to one and a half inches. It has been found that the benches in which valves were used, when working at the same temperature as those under seal—

1. Carbonized more coal, and gave, consequently, a greater production of gas per mouthpiece.
2. That carbon was not deposited so rapidly.
3. That there were not so many stopped pipes.
4. That there was a scarcely estimable improvement in the quality of the gas.
5. That the retorts did not last as long.

To determine the economy, if any, obtained by the use of the valves, it is necessary to state the results obtained and the cost thereof, both when the valves were used and when not used.

Results Obtained with Valves.

Size of retorts, 14" x 25" x 8' 6", set in benches of 5's.

Number of days benches ran before resetting (average)...	593
Cubic feet of gas made per retort in lifetime (average)...	4,094,620
Number of hours each retort out for carbon (average)...	1,436
Cubic feet of gas made per retort in 24 hours.....	6,904

Results with Seal.

Size of retorts, 14" x 25" x 8' 6", set in benches of 5's.

Number of days benches ran before resetting (average)...	899
Cubic feet of gas made per retort in lifetime (average)...	5,850,000
Number of hours each retort out for carbon (average)...	4,089
Cubic feet of gas made per retort in in 24 hours.....	6,508

It is necessary to show the cost of building and running a setting of five retorts at a working heat, in order to determine the cost and value of each retort used.

Cost of a Setting of Five Retorts with Ordinary Furnace.

Cost, per retort, of skeleton.....	\$64 00
“ “ filling in.....	45 00
“ “ taking down and erecting iron work...	10 00
“ “ iron work.....	60 00
	<hr/>
	\$179 00

The amount chargeable to wear and tear of the skeleton per diem, when bench is under fire, is reached as follows: The skeleton should last twenty years, and the old material, when skeleton is torn down, is worth one-third its cost at time of erection—which makes 3 cents as the amount chargeable per diem when bench is under fire; and the cost of running a bench of fives at a working heat is as follows:

Cost of Running a Bench of Fives at a Working Heat, including, 1, fuel; 2, labor; 3, wear and tear of skeleton; 4, wear and tear of iron work—including ashpan, grate bars, furnace door, tools, and mouthpieces.

1. Fuel—60 bushels coke, at 7 cents.....	\$4 20
2. Labor, at \$2 per diem.....	45
3. Skeleton.....	03
4. Iron work.....	25

Total..... \$4 93

Cost per diem of each, 98.6 cents.

It is clear that, with the above expense remaining constant, there must be a saving when the production per mouthpiece is increased, as is the case where the valves are used, and to the following extent:

Cost per 1,000 cubic feet when retort makes 6,508 cu. ft.,	986	= 15.15 cents.
	6508	
“ “ “ “ “ 6,904 “	986	= 14.28 cents.
	6904	

Saving per thousand cubic feet due to use of valves... 00.87 cents.

It is also found that the saving by the use of the valves, caused by the lesser production of carbon, amounts to .30 of a cent per thousand cubic feet.

The saving due to the fewer stopped pipes is not estimated; and this is also true of the improvement in the quality of the gas.

The gain due to the valves amounts to 1.17 cents per thousand cubic feet; from which must be deducted the extra cost of replacing retorts, amounting to .44 of a cent, and the wear and tear of valves and interest on their increased cost over the ordinary dip pipe, amounting to .02 cent—or .46 of a cent in all.

This will leave the net saving due to the use of the valves at .71 of a cent per thousand cubic feet.

It must be borne in mind, however, that this saving was reached in working against an old-fashioned hydraulic main that sealed the dip pipe from three-quarters to one and a half inches; and it is clear the saving would not have been as great if a large main could have been used and the seal was not one and one half inches.

The valves require considerable attention, and complicate the working of a retort house; and the saving under the most favorable conditions is so small that in the designs for larger settings the writer has concluded to adopt a large hydraulic main and a light seal in preference to the valves.

The Teaching of Experience in "Competition."

By ANTIQUUS.

The "consumer" is living and learning. So many manifestations of anxiety for the welfare of those who compose that down-trodden and unfriended class were recently made that actually they (the "consumers") began to believe they were of some new importance in the community. So accordingly they aided their friends and champions in establishing "consumers," etc., gas companies, which should have especial care for them, and furnish extraordinarily cheap, and wonderfully good, gas. These efforts were in many cases successful. For a time the consumers enjoyed a millennium; but soon they began to find themselves dwindling in importance. They discovered they had been but means to ends for other than their own welfare. The "consumers" company which had been established repudiated the consumers, joined hands with the much-decried grinding monopoly of the old gas company, and raised the price of gas to a figure generally above what it formerly was, or at least above what it would have been in the natural plan of reduction followed by the old company. That course of experience has been gone through with time after time by the "consumer," until we almost weary of the story, and are exasperated at the want of perspicacity on the part of these people who will not look beyond their own doors. With the history of the gas companies of our country teeming with examples of the inevitable results of such action, we see it repeated with the belief that such results shall not be.

But, finally, in some places this universal experience is being considered. The "consumer," as we said, is living and learning that "all is not gold that glitters." We have in mind a recent case at Hudson, N. Y. Last spring the citizens and "consumers" of that town were visited by a cheap, "competitive" gas delegate—water gas, of course. The "new gas" was promised twenty per cent. cheaper, and twenty per cent. higher in candle power, than the old "coal gas" now being sold there. All the familiar attractions were held out. The city fathers were wined and dined, and put through the usual course of treatment. At all this the Hudson Gas Company, the long established source of gas supply, felt little alarm. They stated their case very simply and succinctly. They said to the city fathers: "Look about you," and asked them to consider the experience of others in these cases. They looked, it appears, and they pretty thoroughly gauged the benefits other towns and cities had derived from the blessings of "better and cheaper gas" and "competition." Evidently, the citizens of Hudson wanted no experience with "consumers" gas companies; for when, after full and long discussion of its merits, the question of granting the petition for the new competitive water gas company came finally before the Town Council this fall for decision, the councilmen voted promptly and unanimously, "No!"

THAT NEW USE FOR A RESIDUAL PRODUCT.—In our "Item" columns of last issue we published a statement that Mr. O. B. Monnett (of the Bucyrus, Ohio, Gas Company) had obtained letters patent on a "sheep wash" preparation that was manufactured out of a "waste product" from gas manufacture. We also extended to Mr. Monnett an invitation to give our readers

the benefit of a description of the new compound. This the gentleman does not seem disposed to do, but he informs us that we may say the "wash" is entirely made up, as to its components, from the spent lime of purifying boxes. Mr. M. claims that the price received for the preparation will much more than repay the original price paid for the lime. He does, however, confess his willingness to impart any desired information to those who will address him personally, or by letter, on the subject.

SPECIAL ENGLISH CORRESPONDENCE.

COMMUNICATED BY NORTON H. HUMPHREYS.

LONDON, Dec. 10, 1884.

In reference to the discussion on recuperation in connection with generator furnaces, which has been carried on in the correspondence columns of the *Journal of Gas Lighting* for some months past, and has extended to something over 100 letters, the suggestion to which I referred in my letter dated Oct. 10th, that the matter should be thoroughly investigated under the auspices of the Gas Institute, has not received the support of the Council. At a meeting held on the 21st ult. the subject came up for discussion, and after an animated debate the following resolution was passed: "That the Council do not consider it desirable that the question of regeneration as applied to the heating of gas retorts should be investigated by the appointment of a Research Committee at the present time." This decision leaves it an open question whether the subject was not considered to possess sufficient importance; or whether owing to the position of the Council as regards the proposed alterations in the rules they did not feel themselves at liberty to appoint a Research Committee for any purpose. The discussion above alluded to has brought out some communicated articles in connection with the subject; and the careful experiments made by Mr. Trewby, and those by Mr. Harold B. Dixon, may be specially mentioned. Some half dozen different and independent investigators have now tried experiments on the subject, and they all take up an opposite position to Mr. Valon. This gentleman passes a current of air very slowly through a red-hot tube, and says that it is not raised in temperature to any appreciable extent by that process; and his practical deduction is that the air passing through the secondary air channels of a regenerative furnace *is not heated*. But in arriving at this result he stands alone. The other experimenters find that the air is heated to nearly if not quite the temperature of the red-hot tube. One thing seems certain—if the regenerative arrangement does not heat the air, it secures economy of fuel in a manner at present not understood. Mr. Valon admits a saving of 16 per cent. of fuel by its use; so gas engineers will do well to adopt a generator furnace with recuperative channels in their retort-house, and so enjoy the saving of fuel and other advantages that are thereby obtainable. They can then read the interesting information which Mr. Valon and other gentlemen interested in the matter so good-naturedly publish for the benefit of the profession at their leisure. Whether his conclusions are right or wrong, Mr. Valon is entitled to our thanks for submitting his views to general criticism and discussion. Although not countenanced by the Gas Institute, the matter is not likely to drop, and further useful information on this important subject may be confidently looked for.

The Rev. W. R. Bowditch, who died on the 16th ult., was noted, some fifteen or twenty years since, for the attention which he bestowed upon the philosophical and scientific department of the gas industry. His book, entitled: "The Analysis, Technical Valuation, Purification and Use of Coal Gas," is at the present time held in great repute as one of the standard works for the profession; and his views on the subject of condensation, purification, etc., have been proved by experience to be perfectly sound and correct. The opinions laid down in the book above named, which was published in 1867, fairly represent the principles of gas engineering practice as carried on at this day; and the late Rev. W. R. Bowditch may be classed with Dr. Henry, of Manchester, and Mr. Lewis Thompson, forming a trio of philosophers that occupy a conspicuous position on account of the painstaking investigation and scientific ability they applied to the subject of illuminating gas. Among the special items in respect to which this gentleman anticipated actual practice by several years, I may mention three that have recently attracted considerable attention—viz., the regenerative gas burner, the Albo carbon light, in which the light afforded by a small gas burner is increased some five-fold, by the use of naphthalene as a carburetter, and the substitution of an artificial gaseous mixture as a standard for photometrical observations, in the place of sperm candles.

Some of our leading scientists have talked of the time when coal gas will be regarded as an insignificant by-product, and the primary object of distilling coal will be the obtaining of tar, ammonia and coke. The recent state of the market as regards tar products, and also ammonia, is scarcely such as to further the fulfilment of this prophecy. To some extent, however, the dream has been realized in fact. The Whitwood Chemical Company, situated in one of the best coal producing parts of England, has for some time

past been distilling coal to the extent of something over 1,000 tons per week, for the production of coke, tar, and ammonia. The gas produced concurrently with those products is of an inferior character, scarcely suitable for lighting; but, of course, available as a source of heat. After heating their retorts, boilers, etc., they have still a quantity of gas to spare, and they advertise that they are prepared to supply this at the low rate of 6d. per 1,000 cubic feet, the purchaser to provide the means for removing the gas. It remains to be seen whether this offer will induce factory or mill owners in the neighborhood to use gaseous fuel in the place of coal or coke, or whether it will prove a sufficient attraction to enterprising users of fuel to induce them to pitch their tents within hailing distance of the Whitwood Chemical Works. The weak point of these cheap gas schemes is the cost of distribution and storage. In ordinary gas undertakings the annual cost of distribution and storage, which comprises interest on capital, and the expenditure necessary for maintenance and repairs, amounts to something like 6d. per 1,000 cubic feet. This is not an important item in the case of illuminating gas of fair quality, but assumes stupendous proportions when applied to cheap gas suitable for heating purposes only. Heating gas of inferior quality supplied from a main tap, at atmospheric temperature is a different thing to heating gas direct from the outlet of the generator without being allowed to cool. Even if ordinary gas could be made at no cost—that is to say, assuming it to be a by-product, pure and simple—it could not be profitably distributed in this country for less than about 36 cents per 1,000 cubic feet.

The closing scene in connection with the "gas section" of the International Electric and Gas Exhibition, at the Crystal Palace, which was held during the winter of 1882-3, has just been enacted by the holding of the closing meeting of the General Committee on the 25th ult. It will be remembered that the Gas Institute took up the position of seeing that the "gas section" of this exhibition was properly carried out in a manner calculated to advance the interests of the gas industry. They sent a circular to all the gas undertakings throughout the country, requesting aid in meeting the necessary expenses, and in reply received a liberal amount of support. They estimated their requirements at £5,000, and in reply they received guarantees from some 200 subscribers, gas companies, for the greater part, but including some private individuals (amongst whom I am pleased to notice the proprietors of the AMERICAN GAS LIGHT JOURNAL.) Of this the sum of £4,426 has actually been called up and expended, and it is estimated that after paying all claims *pro rata*, to the subscribers. When it is remembered that, in addition to meeting the expenses attendant upon the getting together of the exhibits, etc. (the expenditure includes the cost of a very elaborate series of experiments for ascertaining the actual practical value of the various appliances exhibited, and the embodying of the same in the form of a report, a copy of which will be forwarded to every subscriber), it is evident that the General Committee have carried out their undertaking, not only in a fairly satisfactory, but in a very economical manner. They could not have attained such a result but for the assistance that has been so freely volunteered; such, for example, as the action of the South Metropolitan Gas Company, in placing a set of rooms and a gasholder full of gas at the disposal of the testing engineers. It is perhaps to be regretted that more expedition was not brought to bear on the carrying out of the tests, the publication of the report, and generally in the closing up of the affair. Events move so rapidly that in the period of eighteen months or so that has elapsed since the closing of the exhibition, many will have forgotten the circumstances which led to its formation. The interest attaching to the report is somewhat dulled by the fact that a considerable portion of the matter comprised in it has already leaked out in some form or another.

Of the report itself I need not say much, as it will, no doubt, be reviewed in due course. It comprises an octavo volume of 185 pages, while the 41 tables referred to, and included in it, are given in the form of a separate volume of equal size. The principal features are Mr. F. W. Hartley's report on the calorific power of the gas used for the experiments; Messrs. Dibdin and Foster's report upon gas burners; and the bulk of the work is occupied by a very elaborate series of experiments upon the heating and cooking stoves, carried out by Mr. D. Kinnear Clark. It is interesting to notice that, while most of the heating stoves realize 90 per cent. and upwards of the calorific value of the gas, the roasting stoves only realize about 16 per cent. In the latter it is found that no less than 80 per cent.—four-fifths of the total amount of heat produced—is carried off by radiation and conduction; so there is evidently room for considerable economy as regards the use of gas for roasting. The report is scarcely the sort of work that one would take up to read for recreation in an idle moment; but it is no less valuable on that account as a work of reference, and is to be specially recommended to the careful consideration of makers of gas stoves and appliances.

The year that is now drawing to a close has been a prosperous one for gas undertakings, although it has been free—perhaps unusually so—from specially prominent events. The advantages of using gas, not for lighting alone, but for heating and cooking, and also—in localities where the price is not

more than eighty-four cents per 1,000 cubic feet—for gas engines, and in connection with several technical processes, are becoming more and more prominent each year in the public estimation. Gas engines are now made which can be depended upon to run satisfactorily, with a consumption of something less than 25 cubic feet of gas per horse power *used* per hour. (I put the word “used” in italics because if the gas engines are not worked up to their maximum power, they use proportionately less gas.) Thus, with gas at a price of eighty to eighty-four cents per thousand cubic feet, a ten-horse power engine can be worked, for a working day of 10 hours, with a consumption of 2,500 cubic feet, costing not much more than two dollars per day. Half of this sum at least is saved in wages as compared with the cost of providing a similar amount of power by the medium of an ordinary steam engine and boiler. It is also found that the gas engine can be used in certain localities—such, for instance, as in the basement of a warehouse or store abutting upon a principal street, and surrounded with houses—where the steam boiler is objectionable. Turning to working a kitchen range, kept burning all day, in size sufficient to provide for about twenty people, will not use less than one cwt. of coal per day, costing from 16 to 20 cents, according to the locality; a gas stove can be used to prepare breakfast, with a consumption of not more than 20 cubic feet, or dinner, with a consumption of 50 to 60 cubic feet, say, 100 cubic feet for the day; and this is only about half the cost of the coal, to say nothing of the other advantages. As regards heating, gas is scarcely so economical as coal for maintaining the temperature of a room continuously from morning to night, but is found very useful for offices, libraries, drawing-rooms, or other apartments that are only required for an hour or two at a time. And where expense is no object it is used as a means of avoiding the smoke and dust inseparable from an ordinary coal fire. In respect to the original purpose for which gas was intended—that of supplying artificial light—a very great improvement is noticeable within the last few years in the quality of the burners and accessories used; thus the consumers get more value out of the gas; for, with the improved appliances, they can either have more light, or use less gas, as compared with the results afforded by the iron fishtail burner, and ground or slightly variegated glass globe that were formerly in general use. Consequently not only has the use of gas increased, on account of the additional demand for cooking stoves, heating stoves, and gas engines, but there is also an increased demand for lighting; and this in spite of the very great improvement in candles and lamps, and the introduction of cheap oils and petroleums into the market.

The market for materials—coal and iron—has been fairly tranquil; but a depression has been noticeable in regard to all the residual products. A low price for coal, of course, means a corresponding reduction in the price of coke; certain products from tar have fallen in value, thus affecting the price of tar; and ammonia, though in a low state at the beginning of the year, has got worse instead of better. But with a good demand for gas, and coal at low prices, the residuals are only of secondary importance.

In concluding my last letter for the year 1884, I may be permitted to express my best wishes that the AMERICAN GAS LIGHT JOURNAL, and all its readers, may enjoy the advantages attendant upon a bright, happy, and prosperous *New Year*.

ITEMS OF INTEREST FROM VARIOUS LOCALITIES.

CORRECTION IN REGARD TO THE WILBRAHAM EXHIBIT AT AMERICAN INSTITUTE FAIR.—In our article on the American Institute Fair display, published in issue of Dec. 16th, one or two mistakes were made, and the errors happened in relation to the particulars concerning the Wilbraham Bros.' exhibit. The No. 5½ Baker Pressure Blower on exhibition was a specimen of that machine intended for furnishing blast to cupolas and charcoal blast furnaces—in short, general smelting operations at foundries. The No. 5½ blower has a displacement of 30 cubic feet per revolution, and is suitable for a cupola 49 to 56 inches diameter inside the lining. It will furnish feed for the hourly smelting of from 7 to 10 tons of metal, and can easily supply a pressure of 60 ounces per square inch. This will be rated as somewhat of a higher order of duty than that assigned by us to the machine in our former note on the subject, wherein it was said the No. 5½ instrument would furnish blast for 50 smiths' fires. It would undoubtedly perform that duty, but we opine that there would also be fifty “anxious smiths” hunting coals in a lively fashion around their forges. The mistake in our rating happened through an inadvertence in hastily marking a copy of the Wilbraham catalogue for future reference. This catalogue, in specifying the various capacities of the machines, lists two series of apparatus—one intended for foundry purposes, the other for smiths' use—and the numbers of both classes begin at 1 and end at 7½ in each case, hence the mistake. Of course, this reference to the “lists” is not offered as any sort of apology for our error, but is mentioned as showing the cause that led to the “mixing up;” and is further submitted as evidence that we had no intention of “belittling” the power of the “Baker Pressure Blower.” Indeed, even were we so maliciously inclined,

our efforts in that line would “avail us nothing,” as that apparatus has made its sterling value known over and over again. The second error in regard to the exhibit was the statement that Wilbraham Bros. had recently furnished an exhauster to the Northern Liberties Gas Light Company, of Philadelphia, Pa. It should have read that the machine was constructed to the order of the Philadelphia Gas Trust, and by them erected at the works located in the Twenty-fifth ward of that city. Messrs. Wilbraham claim that this exhauster has the largest working capacity of any yet erected in this country. The same firm also furnished an exhauster to the Wilmington (Del.) Gas Light Company, which goes to show that Brother Curley is up and doing; but, then, who ever knew “Brother Tom.” when he was inactive?

AND WE HAVE TO ACKNOWLEDGE ANOTHER.—Still, this can hardly be set down against us, as the information concerning the matter was received in the most direct manner possible. The error occurred in the “Item” about the asbestos drop curtain, ordered for the Philadelphia (Pa.) Academy of Music, in which it was stated by us that the proportion of material in its make up was in the ratio of one-third cotton fiber to two-thirds asbestos fiber. The Chalmers-Spence Company write us to say that the correct composition of the curtain is in the ratio of 3 per cent. cotton to 97 per cent. asbestos—even that small per cent. of cotton being only employed on account of certain purely mechanical advantages desired, and its presence does not in the smallest degree affect the absolute fire-proof quality of the material.

WHY THE ACCIDENT OCCURRED IN THE VALVE-HOUSE OF THE WORCESTER (MASS.) GAS LIGHT COMPANY.—In our number for December 2d it was related that Mr. J. H. Rollins, Agent and Superintendent of the above named company, had occasion to display his courage in a rather striking manner on the evening of November 18th last. No one acquainted with Mr. Rollins would be surprised to learn that he was and is possessed of every requisite (physical and mental) to draw upon in cases of emergency, and those of the fraternity not acquainted with him personally will no doubt agree with us that it requires no mean order of courage to “battle with fire,” let alone to come out first-best in the heated contest. It now transpires that the primal cause leading to the burning of the Worcester valve-house may be traced to a sudden stoppage in one of the scrubbers. When this stoppage occurred, naturally enough, the exhauster was bound to drive the gas somewhere, and it is supposed that the weakest point of resistance encountered was at the seals of condenser drips, and thus on to sewer connection from same. The valve-house destroyed, containing valves, gauges, governor, and a 100-light meter, was also connected with the sewer by means of a four-inch pipe into which was pumped the holder drips. It is supposed that the gas, passing into the sewer, found its way speedily into the drain connection in valve-house and there took fire, with the consequences chronicled in issue of December 2d. The boy who first made the discovery of how things were going (a lad named Reynolds) has entirely recovered from the injuries received, but Mr. Rollins was rather more unfortunate in his experience. We are more than pleased, however, to say that he is all right again, although Rollins is certainly convinced he is hardly qualified to appear as the possessor of all the requisites going to make up the invulnerability credited to a salamander.

PHILADELPHIA (PA.) GAS TRUST CONTRACTS.—Last December the Committees in charge of such matters made the following contracts in regard to the items below specified: The contract for purchase and removal of carbon on hand at the various stations was awarded to M. G. Henning, of 1152 Beach street, at a stated price of \$5.25 per ton of 2,200 pounds. Pipe contracts were made with the Gloucester Iron Works to supply 15,000 lengths of 4-inch, at 23 cents per foot, and fittings for same at 2¼ cents per lb.; with the Mellert Foundry to supply 3,000 lengths 3-inch, at 17½ cents per foot; 550 lengths 12-inch at 84 cents; 55 lengths 20-inch, at \$2.10, and fittings for lot, at two and two-fifths cents per lb. The money value of awards foots up, in first case, to about \$45,000; in second to about \$14,800.

NOTICE OF REMOVAL.—The old headquarters of the Chicago Retort and Fire Brick Works (Mr. Geo. C. Hicks, President), has been removed from the old location at No. 79 Dearborn street, Chicago (Ills.), to the factory buildings at 45th and Clark streets, same city. Post office address is “Box 489.”

METROPOLITAN COMPANY, BROOKLYN, N. Y., REDUCES SELLING RATES.—From and after date of January 1st, 1885, the rates charged for gas by the Metropolitan Gas Light Company were adjusted to the following schedule, as per notification of the company's Secretary, Mr. C. H. Stoddard: To consumers of 50,000 cubic feet and upwards per month, \$2 per 1,000; to consumers of less than 50,000 cubic feet per month, \$2.25 per 1,000.

THE USUAL NEWSPAPER STYLE OF PREDICTION.—A daily newspaper might have some sort of an excuse for going into lively hysterical symptoms

when someone of its "great-headed" staff saw fit to enlighten (?) its subscribers on the subject of gas and gas companies, but we had rather looked for better and more rational sort of treatment from the hands—and pens—of the gentlemen in control of the publication known as the *Western Manufacturer*. Still, our western contemporary saw fit to indulge in the following pessimistic declaration on the subject of "monopoly:" "The act passed at the last Legislature of New York, giving the gas companies of New York city power to consolidate, has been acted on, and all but two companies have formed a gigantic pool—united in one great corporation with a capital stock of \$40,000,000. The citizens of New York will soon find out that the sole purpose of this combination was not, as some were led to believe, for the purpose of reducing the price of gas, but it was solely for the purpose of advancing the price and keeping out any gas company that may wish to begin business in the city under an agreement to furnish gas at a marked reduction from the rate now charged. Individuals or corporations who acquire a monopoly of any commodity regulate the price thereof to suit themselves and not the public. Combinations are always formed for gain—with the intent to beat some one. When the reverse of this is the case, the millennium is close at hand." The *Western Manufacturer* had better put a curb upon the license of its prophet; but somehow or another this always was a bad country for those who essayed the role of soothsayer. Maybe the millennium is close at hand upon the residents of New York, but to those living therein that delightfully fraternal period seems about as remote now as it ever has been. Certain it is the first thing the "combination" did was to reduce the selling price of gas here by 75 and 50 cents per thousand, and if it had not been for the fact that knavish legislation made possible in the past the future existence of redundant gas companies, New York's citizens might now be enjoying gas at \$1.25 per thousand. The *Western Manufacturer's* prophet had better remove to Philadelphia; he will have companions there.

THE LOUISVILLE (KY.) GAS WAR.—Mr. John G. Baxter, President of the old Louisville Gas Light Company, has given the word to commence operations against the corporation known as the Citizens Company, which concern will be ready to deliver gas to consumers on or about the 1st of February. The peculiar arrangement made with the old Louisville Company by the municipal authorities, when its charter was originally granted, as well as its subsequent modifications, would naturally enough be supposed to afford a perfect guarantee against the establishment there of any competing gas corporation. As we understand the case, the city of Louisville owns outright about one-half of the stock (total capitalization is 1½ million dollars) of the old company, and the dividends received thereon (the amount of annual dividends is restricted by law) have more than paid for the expenses incurred in lighting the street lamps; the charter of the old company obliges it to lay a certain length of new conduits each year, and this obligation has caused the expenditure of thousands of dollars upon which no interest money has ever been returned; the instrument also provides that the city's lights shall only be charged for at cost of same to gas company, as shown by the books of the company. Notwithstanding all this, a certain sort of scheming capitalists made application to the municipal authorities for a grant to operate an opposition works, and were finally successful. We believe that F. D. Carley, a gentleman more than likely rather closely identified with Chess, Carley & Co., who in turn are popularly supposed to be the chief agents, in the near Southwest, of the famous isopod—for we incline to the opinion that our readers will agree with us in the assertion that the legs of the Standard combination are all alike—is the chief financial spirit in the Citizens Company, and is, of course, only acting for the relief of the oppressed Louisville gas consumer. There are some who will feel disposed to claim that Mr. Carley and his coadjutors are engaged in the enterprise for the sake of the shekels that may be gleaned, and more than likely Mr. Baxter is included in the doubting list. Mr. B. certainly has some excuse for being a trifle suspicious, and particularly so when he recalls to mind various propositions submitted to his consideration at divers periods by the Citizens' backers. Now, be it remembered that Baxter is a Kentuckian, and that he has also gathered around him in the management of the Louisville Company other Kentuckians, who do not exhibit the least symptoms of fear when the war tocsin is sounded, but rather like the tones which usually grate so harshly on timorous ears. The Citizens combination having almost gotten to the point when the operation of distribution would commence, Mr. Baxter though it would be a good idea to fight the enemy with fire; and accordingly early in December he caused a notice to be published in the newspapers of his city that on and after January 1st 1885, the price of gas sold by the Louisville Company would be reduced to \$1 per thousand, in consideration of prompt payment of bills. The Citizens Company has laid but about ten miles of mains, and these, of course, have been laid through the heart of the territory; and the Louisville Company, in making the reduction, might have followed the course usually pursued in such like cases, by having the decreased price only apply to the consumption in the district piped by the invaders; but this practice (and very wisely) was not adhered to—the decreased rate applying to every

part of the city. When the announcement was publicly made, the Citizens' managers put on a bold front, and declared that their price for gas, when distribution should be commenced, would be at a lower figure than that of the old company. They proclaimed that if the Louisville Company should reduce its price to fifty cents per thousand the Citizens Company would come down still lower, and furnished the usual assurance that at all times would they supply, dollar for dollar, a richer illuminant than that of its (exact word in the advertisement) *competitor*. Of course the Carley concern proposes to operate a water gas system; hence the value of its candle power over that of its "competitor," comparative cheapness, etc. It is amusing to contrast all these claims with the evidence collected by Mr. Baxter and the Louisville Company's Engineer, Mr. A. H. Barret, when on their trip East last summer, in regard to the value of water gas. In an interview between Mr. Baxter and the reporter of a Louisville daily paper, concerning this very matter, Mr. B., in reply to the question as to whether he had investigated the cost of making water gas, replied: "The Louisville Company has fully investigated the subject, and has found that water gas cannot be manufactured in this city as cheaply as coal gas. It long ago had an opportunity to purchase water gas patents at very low figures, but refused to do so, not only on account of the cost of production, but also of the impurity of the gas and the danger attending its use."

The Louisville Company, even before the reduction, was gaining consumers at the rate of about 50 per month; and so it will be seen that its position in the strife is most favorable. As an example of the manner in which the plant of the Citizens Company is constructed, we might mention that at three different points on the ten miles of mains already down four drips may be counted on a length of 200 feet. Unaccounted-for gas ought to figure as somewhat of an item in the neighborhood of the bookkeeping department. The taxpayers of Louisville will have the pleasure of being assessed in the neighborhood of \$60,000 for public lighting for 1885 in case the old company is obliged to pass its dividends—and they will of necessity be passed while the "fight" is in progress. Yet they (the taxpayers) will have the solace of knowing that their City Fathers, or whatever other owlish assemblage of lawmakers as may have granted the opposition charter, are responsible for the imposition of the burden. We will keep track of "how the slaughter goes."

DEATH OF MR. W. B. WARREN.—We regret the necessity that compels us to chronicle the death of Mr. W. B. Warren, who for the past sixteen years has been the executive head of the Terre Haute (Ind.) Gas Light Company. The sad event occurred at half-past ten o'clock on the morning of December 16 last, and was all the more sorrowful from the manner of its suddenness. While walking along Fourth street at the hour mentioned, Mr. Warren staggered and fell to the sidewalk. He was instantly removed to the store of Mr. Meyers, and a messenger was sent for Dr. Swafford, who responded immediately, only to pronounce the patient dead. Mr. Warren was born in Jefferson County, New York, in the month of April, 1816, and first became a resident of Terre Haute in the year 1834. He was then a poor young lad, but bright, energetic, and enterprising. Careful in his habits, prudent in his speculations, and business-like in his commercial forecasts, it was not long before he amassed a competence. In 1850 Mr. Warren was united in marriage with Miss Sue Whitcomb, and this lady, with a son (Dr. Louis Warren) and a daughter survive him. In 1868 the now deceased gentleman was elected to the presidency of the Terre Haute Gas Light Company, and it is due to his sagacity and public spirit that the corporation holds such a secure place in the confidence of the citizens. Mr. Warren leaves to his children not alone a plethora of this world's goods, but also that which will now most console them in the dark hour of sorrow at his unlooked for taking-off—the heritage of a name loved and respected by one's fellow-citizens.

THE MONTREAL PLUMBER ESCAPES PUNISHMENT.—Some time ago we had occasion to report an explosion of gas that resulted fatally to a domestic in the employ of Mrs. Hutchins, of Montreal, Canada. It is not necessary to repeat the particulars of the unfortunate affair, as the account of same was published in the *JOURNAL* of Nov. 17. The coroner's jury that investigated the matter held a plumber named Brennan guilty of manslaughter for his carelessness in making a gas connection to a cooking stove in the house of Mrs. Hutchins, which was the primal cause leading to the fatal explosion. This proceeding on the part of a coroner's jury was so unusual (in that it was just and sensible) as to cause us to think that others of his ilk might in time be made to feel the weight of the law when their negligence would endanger life or property. The attention of the Grand Jury in session at Montreal on a late date was directed to the finding of the lesser jury; and, unfortunately for the safety of the community, the investigation by the superior body developed the fact that no law existed whereby such cases could be reached, and so a verdict of "no bill" was returned. It is a pity that this is the final outcome of the affair, for if ever a plumber deserved punishment (and whoever knew one of that famous craft that always did what was right?) it was the man Brennan.

A GASHOLDER COLLAPSES.—One of the old gasholders belonging to the St. Louis (Mo.) Gas Light Company collapsed on the night of Dec. 11. At 9:30 P.M. on that date two of the iron girders snapped, and two hours later the grand crash came. The holder sheets, columns, etc., fell flat into the tank, and none of the other holders were in any way injured. The ruined holder previous to its demolition contained an estimated content of 360,000 cubic feet, and this vast accumulation was ignited; the resultant illumination, which lasted about 20 seconds, was one of the grandest sights ever witnessed in St. Louis—but it was a terribly expensive spectacle. The total loss is placed at \$100,000. No damage was done to any of the surrounding property. The particulars received by us in regard to the affair have so far been of the most meagre sort, and we would call upon Engineer T. G. Lansden for a straight account of the trouble. The temperature of the atmosphere, we believe, experienced a very sharp decline in that locality on the day in question, and this sudden change in weather conditions may have had much to do with the snapping of the girders. We are informed that the holder was in use for about 27 years.

THE PROPER WAY TO DO IT.—The Youngstown (Ohio) Gas Light Company may be fairly assigned the banner position in the matter of public spirit and liberality in dealing with its consumers, all things being duly taken into consideration. The 1884 rates were low in every sense of the term; but Mr. Geo. Cornell, Secretary and Treasurer of the company, figured out to his own satisfaction, and speedily brought his board of directors around to his own way of thinking, that even the selling rates of '84 could be still further decreased with profit to the company during '85. At a board meeting recently held the subject was thoroughly canvassed, and the result of the deliberations was made manifest to the people of Youngstown in the shape of the following circular, bearing date of Dec. 22d, 1884: "Although the year 1884 has been one of severe depression in business, the people of Youngstown have given us a steady, liberal and increasing patronage. We desire to make a practical acknowledgment of our indebtedness to them by the following substantial reduction in the price of gas, to take effect on the first day of January, 1885:

	New Rate.	Old Rate.
A monthly consumption of less than 5,000 cu. ft.,	\$1.50 per M.	\$1.70
" " from 5,000 to 15,000 "	1.40 "	1.50
" " " 15,000 to 25,000 "	1.30 "	1.40
" " " 25,000 and upward "	1.20 "	1.30

Being a reduction of 20 cents per thousand cubic feet to the first-class (or smallest consumers) and ten cents to all others.

"We do not know of any city of 25,000 population in the country, and but few cities of any size, in which the price of gas has been reduced as low as at Youngstown, and we hope by this liberality and enterprise to retain our old patrons and secure many new ones." **YOUNGSTOWN GAS CO.,**

"**Geo. CORNELL, Sec'y and Treas.**"

These figures speak for themselves, and furnish the most cogent sort of proof that enterprise and liberality mark the spirit which guides the doings of the "man at the helm" of the Youngstown Company. The handsomely gotten up circular making public the new rates, also contains within its cover an invitation to all interested in the lighting of halls, churches, warehouses, or other situations requiring powerful illumination, to investigate and examine into the merits of the Siemens burner for satisfactorily performing such work. It gives the names of the places so illuminated within the precincts of Youngstown, and asks that critical study be made of the lighting effect obtained by their agency, and also the cost of their maintenance. The following places there have already installed the Siemens lights: Manning, McKeown & Co., one of 500-candle power; Plymouth Congregational Church, one of 500-candle power; Youngstown Roller Skating Rink, two of 500-candle power each; under contract with the managers of the Great Western Roller Skating Rink for two of 500 and two of 250-candle power each. Every company in the country can get similar places in their cities to install these large burners if they will only make the effort. In conclusion we are bound to add that the Youngstown folks are bent upon making the New Year pleasing to the gas consumer and prosperous for themselves. Keep up the good work, for good example is bound to be infectious.

Correspondence

[The JOURNAL is not responsible for the opinions expressed by correspondents.]

A Wise Body of Municipal Councillors.

TRENTON GAS LIGHT COMPANY,
TRENTON, N. J., Dec. 24, 1884.

To the Editor AMERICAN GAS LIGHT JOURNAL:

Among the "Items of Interest from Various Localities," in the GAS LIGHT JOURNAL of Dec. 16th, is one headed, "Electric Light for Trenton's (N. J.)

Streets," which states that the streets of Trenton are lighted with gasoline lamps because the city will not pay for gas.

There is a great mistake in the information that has reached you in that particular, which, out of respect to the Common Council of this city, I feel it my duty to set right, and which I am sure you will be glad to correct. Gas has always been burned in the street lamps of Trenton, on the lines of the mains of the Gas Light Company since the starting of the gas works here in 1849; and the city is now about as well lighted as most places of its size, by gas lamps burning all night and every night in the year.

The city maintains a number of gasoline lamps; but in all cases they are placed where there are no gas mains. As soon as mains are laid in a street, gas takes the place of the gasoline, and the gasoline lamps are put up in other places where the mains do not extend. No pretence of preference for gasoline lamps has ever been made by the Common Council; but such lamps have been used as the best substitute where gas could not be had, and their use in that way only shows the willingness of the city authorities to accommodate all parts of the city to the best of their power, and by no means betokens any prejudice against the Gas Light Company. It would be premature to speak with reference to the electric light company, as it is not yet in operation; and, indeed, it has no bearing on the error I wish to correct.

Yours truly,

JOHN S. CHAMBERS, Gen'l Manager.

[We are more than pleased to give space to the above, and acknowledge our indebtedness to Mr. Chambers' courtesy in so speedily setting us aright on this matter. It is gratifying to note that Trenton's Council is governed by a public-spirited policy in the matter of street lighting, for, as Mr. Chambers well knows, the reverse of the case is the usual rule in this country. Our informant in the Trenton lighting case had no reason to convey to us untruthful information; but possibly his imagination was rather vividly excited, and so the real circumstances were badly distorted.—Ed.]

The Market for Gas Securities.

Nothing of any particular moment or importance has been developed during the fortnight in regard to dealings in New York city gas shares, although Equitable stock moved up rather strongly. This company is now sending out gas to consumers, and those in authority in the corporation appear very hopeful as to the future outlook. At the time of writing (Dec. 31) Consolidated shares are freely offered at 85, the best bid price that we have record of being 82½. Brokers are, as a rule, "bearish" on the security, and one pretty well-informed investor has promulgated the opinion that Consolidated will see 75 quicker than it will par. In spite of the bearish arguments advanced we still adhere to the opinion that Consolidated is a decided purchase at 85, and advise those inclined to make a speculative venture to take advantage of the present opportunity. Quotations show no very marked change, Equitable alone excepted; the tendency is downward. By way of an interesting comparison we here give a very brief *resume* of highest and lowest quotations for city shares during '84: Manhattan, 327—260; Metropolitan, 257—215; Municipal, 240—195; New York, 169—145; Mutual, 138—117; Harlem, 138—105; Equitable, 105—85. We are in receipt of a communication from Mr. N. R. O'Connor, Secretary of the Harlem Illuminating Company, in which that individual, judging from what has been said in our columns regarding the future purposes of Messrs. Elkins, Maloney, *et al*, takes occasion to say that we are "misinformed as to the true object of the company," etc. We are likely to know when we have been "misinformed," and are always in readiness to acknowledge an error; but we take this occasion to inform the brilliantly versatile Secretary of the Elkins combination that we have no occasion to take back anything stated by us in regard to the Harlem Illuminating Company or its managers. We are sorry to inform our readers that Mr. Geo. Graham Lake, of New York city, came to an untimely death on date of Sunday, Dec. 21. While crossing West Broadway at Thomas street, on Dec. 12th, Mr. Lake attempted to pass in front of a heavy truck; he escaped the truck all right, but only to be knocked down by a rapidly moving street car of the 6th avenue line. He received a compound fracture of the leg, and the shock was of so severe a nature that he succumbed to its effects. Mr. Lake was one of the heaviest individual holders of gas securities in this country, and was at the time of his demise a director in the Harlem Company of this city, as also in the Williamsburgh Company of Brooklyn. One of his last important speculations was in regard to the settlement of the gas war at Baltimore, Md., for we guess it was in great part owing to him that the prevailing truce was effected.

Brooklyn shares are fairly steady. In out-of-town matters it is on the cards that Jersey City (N. J.) gas affairs will present a neat imbroglio before long. The United Gas Improvement Company having, as it is supposed, leased the works and plant of the Peoples and Jersey City Companies, proposes to wage a bitter warfare against the new Consumers Company, which concern will soon be ready to deliver gas. In view of all this it would seem as though a fair profit might be made by selling Jersey City shares at present quotations. Montreal gas is higher. Holders of Louisville (Ky.) gas need not be surprised at lower prices; and they should not take alarm at the shrinkage, as the two "B.'s" (Baxter and Barret) mean business.



A. M. CALLENDER & CO.,
PROPRIETORS.

Editor—JOS. R. THOMAS, C.E
Manager—C. E. SANDERSON.

PUBLISHED ON THE 2ND AND 16TH OF EACH MONTH
At No. 42 Pine Street, New York.

This is a recognized official organ of—
LIGHT, HEAT, STEAM, WATER-SUPPLY,
VENTILATION, SANITARY IMPROVEMENT,
AND GENERAL SCIENCE.

TERMS

SUBSCRIPTION—Three Dollars per annum, in advance.

AGENTS

NEW YORK—AMERICAN NEWS Co. 39 and 41 Chambers St.
BOSTON—S. M. PETTENGILL & Co., 6 State Street.
PHILADELPHIA—PRATT & Co., Corner 9th and Arch Streets.
England—C. W. HASTINGS, 22 Buckingham St., London, W. C.
Germany—B. WESTERMANN & Co., of New York

FRIDAY, JANUARY 2, 1885.

Use of Sulphate of Ammonia in the Garden.

A contributor to a London exchange writes: Last year I was induced to try an experiment in chrysanthemum growing, and for this purpose purchased one pound of sulphate of ammonia, which I bottled and corked, as the ammonia evaporates very rapidly. I then selected four plants from my collection, putting them by themselves, gave them a teaspoonful of ammonia in a gallon of water twice a week. In a fortnight's time the result was most striking; for though I watered the others with liquid cow manure, they looked lean when compared with the ammonia watered plants, whose leaves turned to a very dark green, which they carried to the edge of the pots until the flowers were cut. As a matter of course the flowers were splendid. The ammonia used is rather expensive, as I bought it from a chemist's shop; this year I intend getting agricultural ammonia, which is much cheaper. I have also tried it on strawberries, with the same satisfactory result, the crop being nearly double that of the others; it is very powerful, and requires to be used with caution.

Gas Stocks.

Quotations by Geo. W. Close, Broker and Dealer in Gas Stocks (with A. E. SCOTT & Co.,) 72 BROADWAY, NEW YORK CITY.

JAN. 2.

All communications will receive particular attention.
The following quotations are based on the par value of \$100 per share.

	Capital.	Par.	Bid	Asked
Central.....	\$440,000	50	60	—
“ Serip.....	220,000	—	47	57
Equitable.....	2,000,000	100	94	96
Harlem.....	2,000,000	50	115	117
“ Bonds.....	170,000	—	—	—
Manhattan.....	4,000,000	50	260	270
Metropolitan.....	2,500,000	100	225	230
“ Bonds.....	658,000	—	110	112

Mutual.....	3,500,000	100	120	122
“ Bonds.....	1,500,000	1000	104	106
Municipal.....	3,000,000	100	205	210
“ Bonds.....	750,000	—	107	110
New York.....	4,000,000	100	157	160
Northern.....	125,000	50	—	80
“ Serip.....	108,000	—	—	—
Gas Co's of Brooklyn.				
Brooklyn.....	2,000,000	25	126	128
Citizens.....	1,200,000	20	87	90
“ S. F. Bonds....	320,000	1000	106	110
Fulton Municipal.....	3,000,000	100	152	155
“ Bonds.....	300,000	—	104	108
Peoples.....	1,000,000	10	77	80
“ Bonds.....	290,000	—	105	110
“ “.....	250,000	—	90	95
Metropolitan.....	1,000,000	100	94	96
Nassau.....	1,000,000	25	115	118
“ Cfts.....	700,000	1000	88	90
Williamsburgh.....	1,000,000	50	137	140
“ Bonds.....	1,000,000	—	106	108
Richmond Co., S. I....	300,000	50	64	75
“ Bonds.....	40,000	—	—	—
Out of Town Gas Companies.				
Buffalo Mutual, N. Y....	750,000	100	80	85
“ Bonds.....	200,000	1000	95	100
Citizens, Newark.....	918,000	50	103	115
“ “ Bonds.....	124,000	—	105	110
Chicago Gas Co., Ills...	5,000,000	25	125	—
Peoples G. L. & C. Co.,				
Chicago, Ills.....			8	12
Cincinnati G. & C. Co..			180	182
Consolidated, Balt.....	6,000,000		83	84
“ Bonds.....	3,600,000		112½	113
Central, S. F., Cal.....			—	60
Capital, Sacramento, Cal.			55½	—
Hartford, Conn.....	750,000	25	122	128
Jersey City.....	750,000	20	125	130
Laclede, St. Louis, Mo.	1,600,000	100	88	—
Louisville, Ky.....	1,500,000	50	95	100
Montreal, Canada.....	2,000,000	100	181	182½
New Haven, Conn.....			25	166
Oakland, Cal.....			—	29
Peoples, Jersey City... ..			—	75
“ “ Bonds.....			—	—
Paterson, N. J.....			25	96
Rochester, N. Y.....			50	75
Washington, D. C.....	2,000,000	20	190	195
Wilmington, Del.....			50	188
Yonkers.....			50	—
St. Louis, Missouri.....	600,000	50	340	—
San Francisco Gas Co.				
San Francisco, Cal....			62½	62¾

Advertisers Index.

	Page
GAS ENGINEERS.	
Jos. R. Thomas, New York City.....	22
Wm. Henry White, New York City.....	16
GAS WORKS APPARATUS AND CONSTRUCTION.	
James R. Floyd, New York City.....	23
T. F. Rowland, Greenpoint, L. I.....	23
Deily & Fowler, Phila., Pa.....	23
Kerr Murray Mfg. Co., Fort Wayne, Ind.....	23
Stacey Mfg. Co., Cincinnati, Ohio.....	23
Bartlett, Hayward & Co., Baltimore, Md.....	23
Morris, Tasker & Co., Limited, Phila., Pa.....	22
Davis & Farnum Mfg. Co., Waltham, Mass.....	18
Tanner & Delaney Engine Co, Richmond, Va.....	16
R. D. Wood & Co., Phila., Pa.....	16
GAS AND WATER PIPES.	
A. H. McNeal, Burlington, N. J.....	22
Gloucester Iron Works, Phila., Pa.....	22
Warren Foundry and Machine Co., Phillipsburgh, N. J.....	22
Meffert Foundry and Machine Co., Reading, Pa.....	22
Cincinnati and Newport Iron and Pipe Co., Newport, Ky.....	22
SCRUBBERS AND CONDENSERS.	
G. Shepard Page, New York City.....	21
REGENERATOR FURNACES.	
Charles F. Dieterich, Baltimore, Md.....	270

RETORTS AND FIRE BRICK.

J. H. Gautier & Co., Jersey City, N. J.....	20
B. Kreischer & Sons, New York City.....	20
Adam Weber, New York City.....	20
Laclede Fire Brick Works, St. Louis, Mo.....	20
Brooklyn Retort and Fire Brick Works, Brooklyn, N. Y.....	20
Borgner & O'Brien, Phila., Pa.....	20
William Gardner & Son, Pittsburgh, Pa.....	20
Henry Maurer, New York City.....	20
Chicago Retort and Fire Brick Works, Chicago, Ills.....	20
Baltimore Retort and Fire Brick Co., Baltimore, Md.....	20
Standard Gas Retort and Fire Brick Co., Ironton, Ohio.....	20
Oakhill Gas Retort and Fire Brick Co., St. Louis, Mo.....	20

GAS STOVES.

American Meter Co., New York and Philadelphia.....	19
The Goodwin Gas Stove and Meter Co., Philadelphia, Pa.....	28

VALVES.

Ludlow Valve Manufacturing Co., Troy, N. Y.....	24
McNab & Harlin Mfg Co., New York City.....	326
John McLean, New York City.....	16

GAS METERS.

Barris, Griffin & Co., Phila., Pa.....	26
American Meter Co., New York and Philadelphia.....	27
The Goodwin Gas Stove and Meter Co., Phila. Pa.....	27
Helme & McLhenny, Phila., Pa.....	27
Maryland Meter and Mfg. Co., Baltimore, Md.....	28
D. McDonald & Co. Albany, N. Y.....	27
Nathaniel Tufts, Boston, Mass.....	28

EXHAUSTERS.

P. H. & F. M. Roots, Connersville, Ind.....	17
Smith & Sayre Manufacturing Co., New York City.....	24
Wilbraham Bros., Philadelphia, Pa.....	24

GAS COALS.

Penn Gas Coal Co., Phila., Pa.....	25
Perkins & Co., New York City.....	24
Newburgh Orrel Coal Co., Baltimore Md.....	25
Despard Coal Co., Baltimore, Md.....	25
Chesapeake and Ohio R.R. Coal Agency, N. Y. City.....	25
Westmoreland Coal Company, Phila., Pa.....	25

GAS ENGINES.

Schleicher, Schumm & Co., Phila., Pa.....	336
Continental Gas Engine Co. New York City.....	326

GAS LAMPS.

Siemens Regenerative Gas Lamp Co., Philadelphia, Pa.....	21
G. Shepard Page, New York City.....	25

GAS KILNS AND OVENS.

Thompson Gas Kiln and Oven Co., New York City.....	6
--	---

PURIFIER SCREENS.

John Cabot, Lawrence, Mass.....	326
---------------------------------	-----

STREET LAMPS.

J. G. Miner, Morrisania, New York City.....	326
Bartlett Street Lamp Mfg Co., New York City.....	17
Geo. D. Winchell Mfg Co., Cincinnati, Ohio.....	17

BURNERS.

G. Gefroer, Phila., Pa.....	22
Walter Anderson, New York City.....	330

PURIFYING MATERIAL.

Connelly & Co., New York City.....	16
------------------------------------	----

STEAM BLOWER FOR BURNING BREASE.

H. E. Parson, New York City.....	18
----------------------------------	----

PIPE COVERINGS.

Chalmers-Spence Company, N. Y. City.....	16
--	----

GAS FIXTURES.

Mitchell, Vance & Co., New York City.....	25
---	----

STEAM ENGINES.

Westinghouse Machine Co., Pittsburgh, Pa.....	17
---	----

STEAM PUMPS.

A. S. Cinneron Steam Pump Works, N. Y. City.....	17
--	----

PIPE CUTTING MACHINE.

Pancoast & Maule, Philadelphia, Pa.....	16
---	----

HYDRAULIC ELEVATOR.

Lane & Bodley Company, Cincinnati, Ohio.....	16
--	----

BOOKS.

The Chemist's Assistant.....	16
King's Treatise.....	18
Scientific Books.....	26
Fodell's Book-Keeping.....	18
Management of Small Gas Works.....	18
Directory of Gas Light Companies.....	16
Newbigglug's Gas Manager's Handbook.....	

SITUATION WANTED.

A young man thoroughly competent to take complete charge of a gas plant of any magnitude is desirous of obtaining a situation. Is thoroughly versed in the most approved principles and practice of modern gas engineering. Best of references. Address "H. H.," Office this Journal.

Situation Wanted

By a Gas Engineer and Retort Setter of nineteen years' experience. Best of references. Address 613-Jt "D. H.," care this Journal.

WM. HENRY WHITE,

Consulting & Constructing
Gas Engineer & Contractor.

ESTIMATES, PLANS, AND SPECIFICATIONS FURNISHED FOR NEW WORKS OR EXTENSIONS OF EXISTING WORKS.

32 Pine St., New York City.

Correspondence solicited.

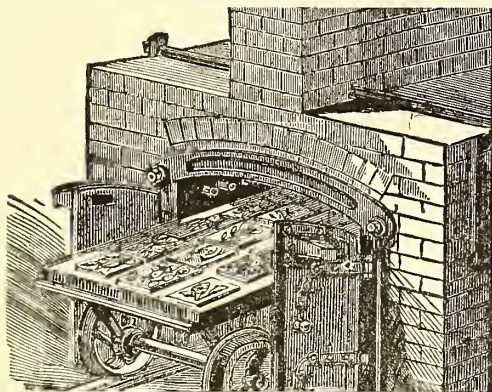

Glass-Staining Gas Kiln.
BAKERS' & CONFECTIONERS' OVENS (PAT.)
Thompson Gas Kiln & Oven Co.
59 Carmine St., N.Y.
Send for Circular by mail.

WM. FARMER, ENGINEER,
32 Park Place, Room 36, New York.

THE CHEMIST'S ASSISTANT; OR, KINDERGARTEN SYSTEM OF CHEMISTRY.

A system by which the elements and their valences are represented by illustrations and solid bodies.
BOX AND PAMPHLET COMPLETE, \$2.50.

John McLean
Man'facturer of
GAS VALVES.
298 Monroe Street, N. Y.

"ECLIPSE" HAND PIPE-CUTTING MACHINE.
Nos. 2 and 3.
Simple, powerful, portable, inexpensive. With it one man can easily cut 6 inch Pipe.
No. 2 Cuts and Screws 2 1/2 to 4 in.
No. 3 " " " 2 1/2 to 6 in.
PANCOAST & MAULE,
[Mention this Paper.] Philadelphia.

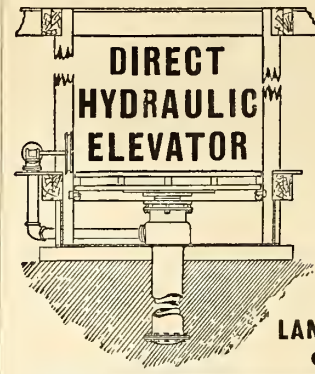

With Iron or Wood Platform.

Largely used by Leading Gas Co.s for Coal and Coke Lifts.

Adapted for use with city service, or special pumping and accumulator system. For prices address the

LANE & BODLEY CO.,
Cincinnati, O.

Iron Sponge,
GAS EXHAUSTERS,

AUTOMATIC GAS GOVERNORS,
CONNELLY & CO., Limited,
No. 407 BROADWAY, NEW YORK CITY.

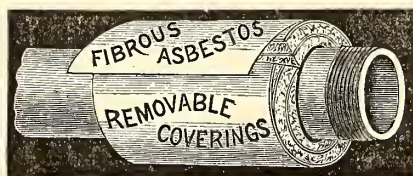

Pipe Coverings.

Fireproof, Non-Conducting Coverings for
STEAM PIPES, BOILERS,
And all Hot Surfaces.

Made in sections three feet long. Easy to apply; light and cheap.

These goods are used at Continental Works, Br'klyn. Asbestos Materials, Fibre, Braided Packing, and Cement.
CHALMERS-SPENCE COMPANY, 419 & 421 EIGHTH ST., N. Y.

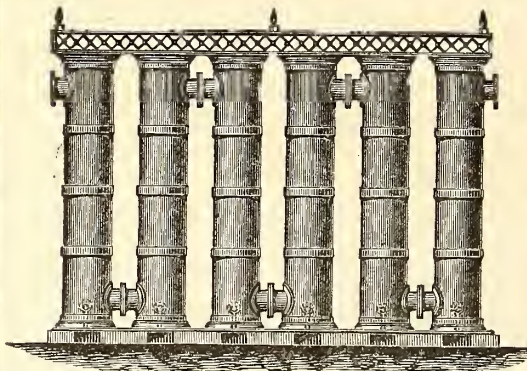

W. E. Tanner, Pres., W. R. Trigg, V.-Pres., A. Delaney, Supt.

Tanner & Delaney Engine Co.
RICHMOND, VA.

Gas Apparatus,

INCLUDING
Condensers of various styles, Scrubbers, Holders, Purifiers, Castings for Retort Houses, Etc.
ALSO STEAM ENGINES AND BOILERS.
Plans, Specifications, and Estimates Furnished.

R. D. WOOD & CO.,

400 Chestnut Street, Phila., Pa.

Cast Iron Gas & Water Pipe, Water Machinery & Gas Apparatus

Cast Iron Pipe, Fire Hydrants, Eddy Valves, Lamp Posts, Large Loam Castings, Flanged Pipe, Sugar House Work, Iron Roofs and Floors, Wrought & Cast Iron Tanks, Turbine Water Wheels and Pumps.

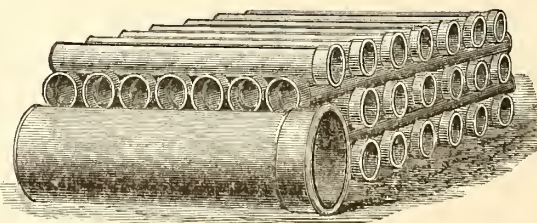

Casholders, Lime Trays, Center Valves, Purifiers, Bench Work, Exhausters, Condensers, Governors, Scrubbers, Gas Valves, Station Meters, Cast Iron Pipe Fittings.

Manufacturers of Heavy Castings and Machinery of Every Description.

ENGINEERS & CONTRACTORS FOR THE ERECTION OF GAS WORKS, & ALL MACHINERY CONNECTED THEREWITH
Estimates and specifications furnished for erection of new works or the extension or alteration of old ones.

Foundries and Works, - - Millville, Florence, and Camden, N. J.

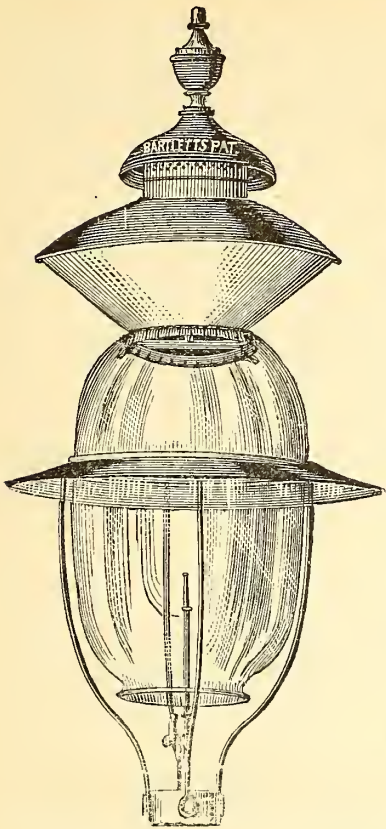

C. BARCALOW, PREST. J. V. BARCALOW, SEC. & TREAS.
BARTLETT
Street Lamp Mfg. Co.

MANUFACTURERS OF
Bartlett's Patent
GLOBE LAMPS,

FOR
Streets, Parks, Railroad Stations, Public Buildings, Etc.

LAMP POSTS A SPECIALTY.

Office and Salesroom,
No. 35 Howard Street, N. Y. City.

Gas Companies and others intending to erect lamps and posts will do well to communicate with us.

STREET LAMPS.

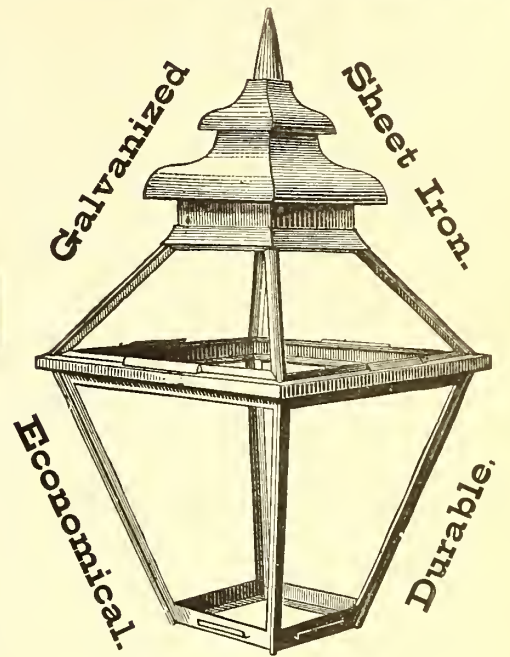

MANUFACTURED BY THE
Geo. D. Winchell Mfg. Co.,
Cor. Bank & Riddle Streets,
CINCINNATI, OHIO.

F. M. ROOTS.

S. C. ROOTS

D. T. ROOTS.

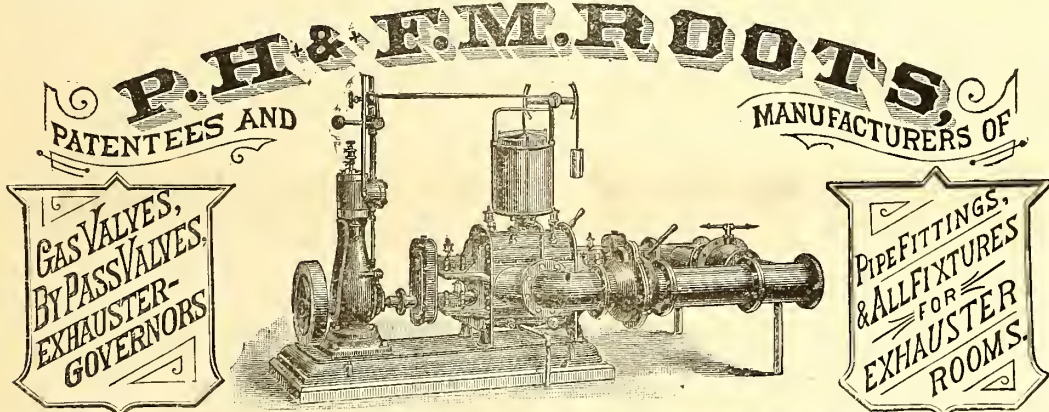

IMPROVED GAS EXHAUSTER,

WITH ENGINE ON SAME BED PLATE, OR WITHOUT.

BYE-PASSES, GAS VALVES, GOVERNORS, ELBOWS, PIPE-FITTINGS, Etc., FURNISHED TO ORDER.

P. H. & F. M. ROOTS, Patentees & Manufacturers, **CONNERSVILLE, IND.**

S. S. TOWNSEND, General Agent, 22 Cortland St. and 9 Dey St., N. Y.

JAS. BEGGS & CO., Selling Agents, 9 Dey St., N. Y.

COOKE & CO., Selling Agents, 22 Cortland St., N. Y.

✽ SEND FOR ILLUSTRATED CATALOGUE AND PRICE LIST. ✽

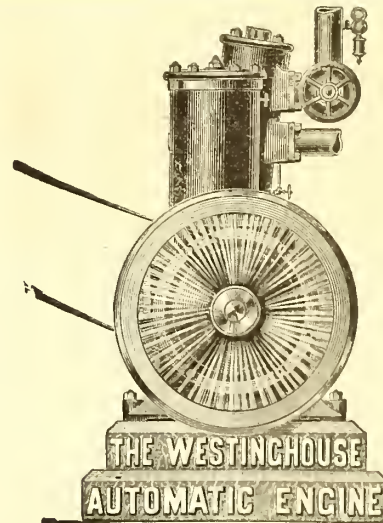

1,000 Engines Now in Use.

30,000 H.P. NOW RUNNING!

Sales, 2,000 H.P. per Month!

SEND FOR ILLUSTRATED CIRCULAR AND REFERENCE LIST

Westinghouse Machine Co.,
PITTSBURCH, PA.

SALES DEPARTMENT CONDUCTED BY

Westinghouse, Church, Kerr & Co., 17 Cortland Street, New York City.

Fairbanks, Morse & Co., Chicago, Cincinnati, Cleveland, Louisville, and St. Paul.

Fairbanks & Co., St. Louis, Indianapolis, and Denver.

Parke & Lacy, San Francisco, and Portland, Or.

Parke, Lacy & Co., Salt Lake City, Utah.

Inray, Hirsch & Kaepfel, Sydney and Melbourne, Australia.

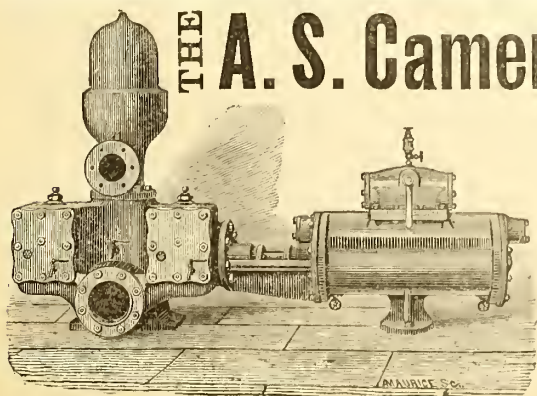

THE A. S. Cameron Steam Pump,

THE STANDARD OF EXCELLENCE.

Upward of 30,000 in Use.

BEST GAS WORKS PUMP
Ever Introduced.

Adapted to Every Possible Duty.

A. S. Cameron Steam Pump Works,
Foot East 23d St., N. Y.

F. J. DAVIS & J. R. FARNUM,

TRUSTEES AND AGENTS FOR THE

SINUOUS FRICTION CONDENSER.

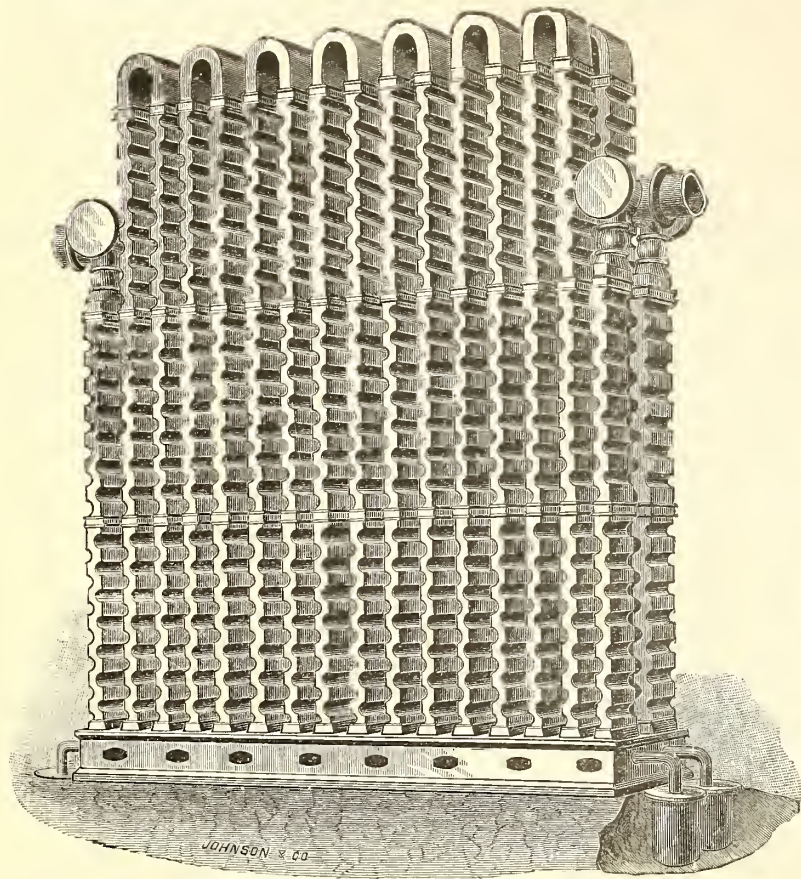

We desire to draw the attention of the gas community to the merits of the SINUOUS FRICTION CONDENSER. Companies intending to introduce new condensers into their works will do well to confer with us and examine plans and estimates before contracting for any other pattern. The FRICTION CONDENSER is now in use at the gas works located in the following places:

- | | | | |
|--------------------------------|------------------|-------------------------------|---------------------|
| Portland, Me. | Brookline, Mass. | Pawtucket, R. I. | Frederickton, N. B. |
| Newport, R. I. | Chelsea, Mass. | Jamaica Plain, Mass. | St. John, N. B. |
| Gloucester, Mass. | Woburn, Mass. | Attleboro, Mass. | Paterson, N. J. |
| Newton & Water-
town, Mass. | Peoria, Ill. | Calais, Me. | Dover, N. H. |
| | Clinton, Mass. | Fall River, Mass. | Waltham, Mass. |
| | | Nassau Works, Brooklyn, N. Y. | |

DAVIS & FARNUM MFG. CO.

MANUFACTURERS OF

Gas and Water Pipes,

AND

GAS AND WATER MACHINERY

OF THE MOST APPROVED PATTERN.

Also, Gasholders and Iron Roofing.

Orders from Gas and Water Companies promptly attended to.

WALTHAM, MASS.

Boston Office, Room 55, Mason Building, 70 Kilby Street.

Parson's Steam Blower,

FOR IMPROVING BAD DRAUGHT IN BOILERS, AND FOR BURNING BREEZE OR OTHER WASTE MATERIAL.

PARSON'S TAR BURNER,

FOR UTILIZING COAL TAR AS FUEL.

PARSON'S AIR JET TUBE CLEANER,

FOR CLEANING BOILER TUBES.

These devices are all first-class. They will be sent to any responsible party for trial. No sale unless satisfactory. Manufactured by the WATERTOWN STEAM BLOWER COMPANY.

H. E. PARSON, Supt., 42 PINE ST., N. Y.

King's Treatise on Coal Gas.

The most complete work on Coal Gas ever published.

In *ee* Vols. Bound, \$30.

A. M. CALLENDER & CO., 42 Pine St., N. Y.

DIRECTORY

OF THE

GAS LIGHT COMPANIES

Of the United States.

We have for sale a limited number of GOODWIN'S DIRECTORY OF GAS COMPANIES IN THE U. S. AND CANADA.

Price, \$5.

Orders to be sent to **A. M. CALLENDER & CO.,**
42 PINE STREET, N. Y. CITY.

BOOKS.

DISTILLATION OF COAL TAR AND AMMONIACAL LIQUOR.

By GEORGE LUNGE. Price \$8.50.

A TREATISE ON THE COMPARATIVE COMMERCIAL VALUES OF GAS COALS AND CANNELS.

By DAVID A. GRAHAM. Svo., Cloth. Price \$3.

Orders for these books may be sent to this office.

A. M. CALLENDER & CO.,
42 PINE ST., N. Y. CITY.

FODELL'S

System of Bookkeeping

FOR GAS COMPANIES.

Price \$5, which should be sent either in Check, P. O. Ord or Registered Letter.

Blank Books, with printed headings and forms on this system, will be supplied to Gas Companies, by applying to W. P. FODELL Philadelphia, or

A. M. CALLENDER & CO
OFFICE GAS LIGHT JOURNAL 42 Pine St., N. Y.

The Management of Small Gas Works.

BY C. J. R. HUMPHREYS.

Price, \$1.

Orders to be sent to **A. M. CALLENDER & CO.,**
42 PINE STREET, NEW YORK.

PRESERVE

The Journal

BY THE USE OF

THE STRAP FILE.

Advantages of the Strap File.

- 1st. It is simple, strong, and easily used.
- 2d. Preserves papers without punching holes.
- 3d. Will always lie flat open.
- 4th. Allows any paper on file to be taken off without disturbing the others.

Price, \$1.25. Sent either by express or mail, as directed. By mail the postage will be 20 cents which will be added to the price of the Binder.

A. M. CALLENDER & CO., 42 PINE ST., N. Y.

Awarded First Premium at American Institute Fair, 1884.

THE AMERICAN METER COMPANY,

MANUFACTORIES,

512 West Twenty-second Street, N. Y.

Arch and Twenty-second Street, Phila.

Nos. 244 & 246 North Wells Street, Chicago, Ill.

AGENCIES,

No. 177 Elm Street, Cincinnati, Ohio.

Nos. 122 & 124 Sutter Street, San Francisco, Cal.

No. 810 North Second Street, St. Louis, Mo.

NEW

INCANDESCENT Gas Fire,

FITTED IN THE No. 19 OPEN
FIRE-PLACE HEATER,

AND

Adapted to Parlor Stoves
and Grates of all Styles.

CIRCULARS WITH DIRECTIONS FOR MEASURE-
MENT AND PLACING IN POSITION,
ON APPLICATION.

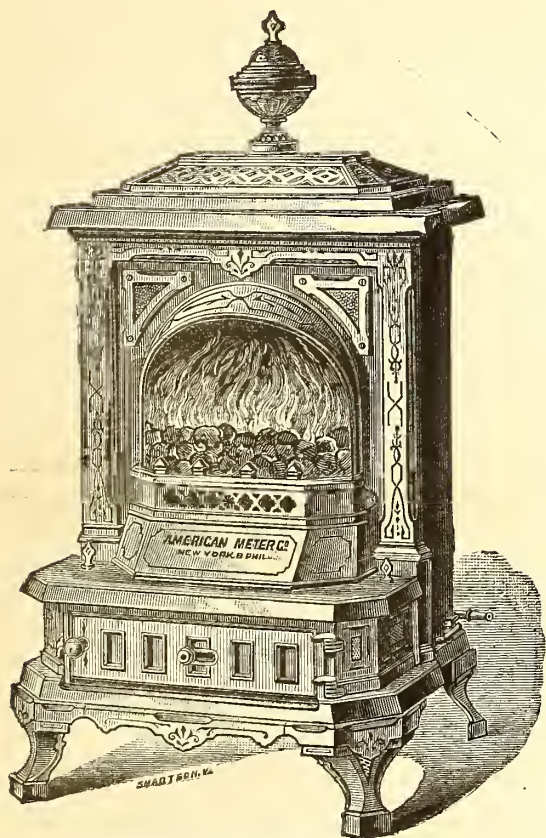

Open Fire Place Heater No. 19.
Fitted with the New Incandescent Gas Fire.

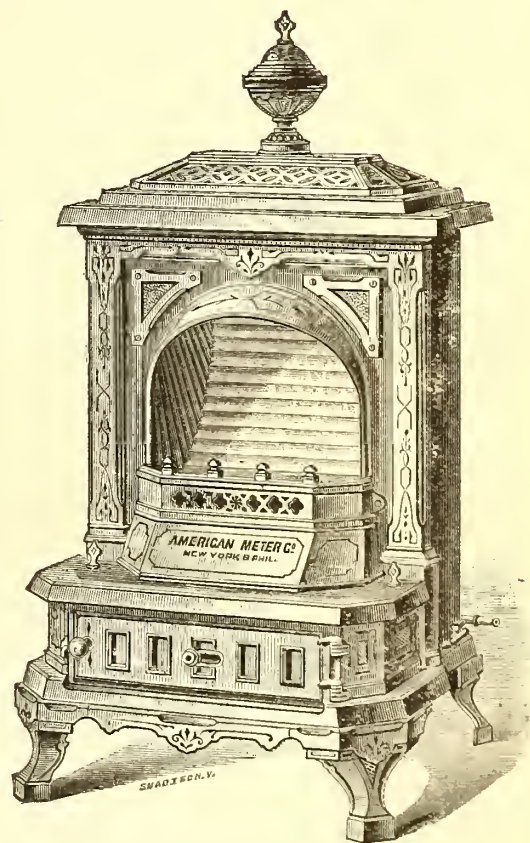

Open Fire Place Heater No. 19.
Fitted with Illuminating and Bunsen Burners and Copper Reflector

We call attention to Special Apparatus Heated by Gas for Manufacturing Purposes.

Gas Furnaces for Tinmen's use; Furnaces for melting Solder and Type Metal; Apparatus for bending Carriage Panels (in successful operation in Carriage Manufactories); Water Heaters for Kitchen Boilers, Baths, etc., and for attaching to Heating Coils and Pipes for Conservatories.

THE COMPANY MANUFACTURES

GAS STOVES FOR COOKING AND HEATING PURPOSES

In all Sizes, for Domestic, Restaurant, and Hotel Use.

These Stoves may be seen in operation at our Retail Store, No. 223 Sixth Av., N. Y. Call and examine.

SEND FOR CATALOGUE OF TWENTY DIFFERENT STYLES OF HEATING STOVES.

J. H. GAUTIER & CO..
CORNER OF
GREENE AND ESSEX STREETS,
JERSEY CITY, N. J.

MANUFACTURERS OF
**Clay Gas Retorts,
Gas House Tiles,
Fire Bricks, Etc. Etc.**
Ground Clay, Fire Brick and
Fire Sand in Barrels,

J. H. GAUTIER. T. B. GAUTIER.
C. E. GREGORY. C. E. GAUTIER.

BROOKLYN
Clay Retort & Fire Brick Works,
(EDWARD D. WHITE & CO.)
Manufacturers of Clay Retorts, Fire Brick,
Gas House and other Tile.
VAN DYKE, ELIZABETH, RICHARDS & PARTITION STS.
Office, 88 Van Dyke St., Brooklyn, N. Y.

LACLEDE FIRE BRICK MFG. CO.,
MANUFACTURERS OF
Fire Brick, Gas Retorts,

AND
ST. LOUIS STANDARD SEWER PIPE.
Blast Furnace and Cupola Linings, every description of Fire
Clay Material, Fire Clay Flue Linings, Chimney Tops
Dry Milled and Crude Fire Clays, etc.
OFFICE AND DEPOT
901, 903, and 905 Pine Street,
ST. LOUIS, MO.

ESTABLISHED IN 1845.
B. KREISCHER & SONS,
OFFICE FOOT OF HOUSTON ST., E. R., N. Y.
**Gas Retorts,
TILES, FIRE BRICK.**
AND EVERYTHING IN THE FIRE CLAY LINE.

MANHATTAN
FIRE BRICK & ENAMELLED CLAY
RETORT WORKS.
ADAM WEBER.

**CLAY GAS RETORTS
AND RETORT SETTINGS,
FIRE BRICKS, TILES, ETC.,**
Office and Works, 15th Street and Avenue C., N. Y.

Borgner & O'Brien,
MANUFACTURERS OF
**CLAY GAS RETORTS
AND RETORT SETTINGS,
FIRE BRICKS, TILES, ETC.**
23d St., Above Race,
PHILADELPHIA.
TWENTY YEARS' PRACTICAL EXPERIENCE.

JAMES GARDNER, JR.
Works,
LOCKPORT STATION, PA.

—ESTABLISHED 1864.—
WILLIAM GARDNER & SON,
Successor to GARDNER BROTHERS.

WILLIAM GARDNER.
Office, COAL EXCHANGE,
PITTSBURGH, PA., P. O. Box 373.

Fire Clay Goods for Gas Works.

C. H. SPRAGUE, No. 70 KILBY STREET, BOSTON, MASS., Agent for the New England States.

OFFICE, 418 to 422 East 23d St., New York.

ESTABLISHED 1856.

WORKS, PERTH AMBOY, NEW JERSEY.

HENRY MAURER,
Excelsior Fire Brick & Clay Retort Works
CLAY GAS RETORTS, BENCH SETTINGS, FIRE BRICK, TILES, ETC.

STANDARD GAS RETORT AND FIRE BRICK COMPANY,
J. ANDERSON, PRES. & MANG'R. OF IRONTON, OHIO. C. PETERS, SECRETARY.
Clay Gas Retorts, Fire Brick, and Fire Clay Goods of Every Description.
Plans of Livesey-Somerville, McIlhenny, and other Furnaces, and Competent Workmen Supplied.

CHICAGO
Retort & Fire Brick Works,
Office, Factory,
79 Dearborn St., Unity Building. | 45th and Clark Sts.
CHICAGO, ILL.
GEORGE C. HICKS, PRES. PAUL P. AUSTIN, SEC. & TREAS.
STANDARD
Clay Retorts and Settings.
BLOCKS & TILES
Of every Shape and Size to Order.
Standard Fire Bricks.

NEWBIGGING'S
Gas Manager's Handbook.
Price, \$4.80.
EVERY GAS MAN SHOULD HAVE ONE.
Orders may be sent to this Office.

OAKHILL
GAS RETORT & FIRE BRICK
COMPANY.
PARKER, RUSSELL & CO.
City Office, 45th & Clark Sts.,
ST. LOUIS, MO.

Our immense establishment is now employed almost entirely in
the manufacture of
MATERIALS FOR GAS COMPANIES.
We have studied and perfected three important points. Our re-
torts are made to stand changes of temperature, the strongest
heats of the furnace, and the abrasion of feeding and emptying.
Our customers are in almost every State of the Union, to all of
whom we refer.

THOS. SMITH, Prest. AUGUST LAMBLA, Vice-Prest. & Sup
BALTIMORE
RETORT & FIRE BRICK CO.
MANUFACTORY AT
LOCUST POINT, BALTIMORE, MD.
Connection with the City by Telephone.
**Clay Retorts, Blocks & Tiles,
FIRE BRICK, FIRE CLAY,
AND FIRE CEMENT.**

Red and Buff Ornamental Tiles and Chim-
ney Tops. Drain and Sewer Pipe (from
2 to 30 inches). Baker Oven Tiles
12x12x2 and 10x10x2.
WALDO BROS., 89 WATER ST., BOSTON, MASS.
Sole Agents for New England States

Siemens's Regenerative Gas Burners, For Lighting and Ventilating.

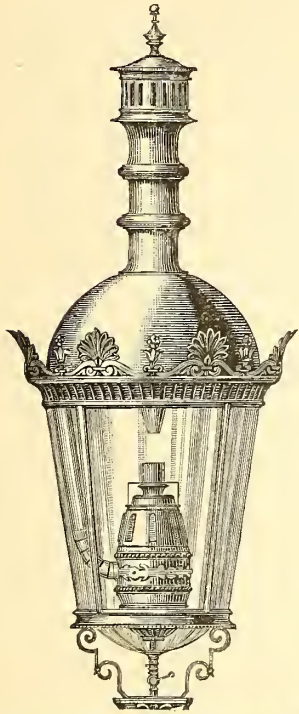

THE CHEAPEST, PUREST, AND MOST BRILLIANT OF ALL GAS LIGHTS.

Superior to the Electric Light in Economy,
Beauty, and Steadiness.

SPECIALLY ADAPTED FOR LIGHTING HALLS, FACTORIES, OPEN SPACES, ETC.

Numerous Tests made by various Gas Companies in the United States show an Efficiency of Ten Candle Power per Cubic Foot of Gas.

General Agents:

SIEMENS LIGHTING CO., 347 West Main St., Louisville, Ky.
 PHILIP MYERS, - - 528 California St., San Francisco, Cal.
 W. D. COLT, - - - 1420 F Street, Washington, D. C.
 T. T. RAMSDALL & CO., - 20 Swan Street, Buffalo, N. Y.
 J. F. WILCOX, - - - No. 11 Bissell Block, Pittsburgh, Pa.
 DENNEHY, WOLF & O'BRIEN,
 85 and 87 Dearborn Street, Chicago, Ill.

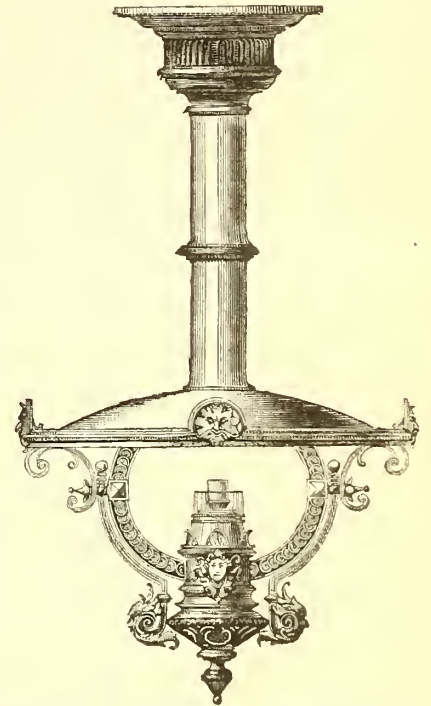

THE SIEMENS REGENERATIVE GAS LAMP COMPANY,

SOLE MAKERS FOR THE UNITED STATES,

N. E. Cor. 21st. St. and Washington Av., Philadelphia. Pa.

THE "STANDARD" WASHER-SCRUBBER,

KIRKHAM, HULETT & CHANDLER'S PATENT.

Total Capacity per 24 Hours of "Standard" Washers Ordered During the Following Years.

1877.....	4,000,000 cubic feet.
1878.....	4,750,000 "
1879.....	24,545,000 "
1880.....	42,967,500 "
1881.....	36,462,500 "
1882.....	39,300,000 "
1883.....	57,735,000 "
1884.....	26,177,500 "
Total.....	235,937,500 cubic feet.

Total Number and Capacity per 24 Hours of "Standard" Washers Erected and in Course of Erection in the Several Countries

	Number.	Cubic Feet per Day.
Great Britain..	151	157,070,000
Western Hemisphere.	38	39,337,500
Australia.....	18	12,150,000
New Zealand ..	2	650,000
France.....	6	4,550,000
Belgium.....	8	5,420,000
Germany.....	16	8,200,000
Holland.....	4	4,160,000
Denmark.....	1	150,000
Russia.....	2	3,500,000
Spain.....	1	350,000
India.....	1	400,000
Total.....	248	235,937,500

THE CONTINUED POPULARITY Of these Machines

Will be recognized from the following extracts from letters from representatives of some of the companies having them in use:

PITTSBURGH GAS CO., Nov. 25, 1884.

GEO. SHEPARD PAGE, Esq.:

Dear Sir—We use 1½ galls. water per 1,000 cubic feet, and obtain 11-oz. liquor. All the ammonia is removed from the gas, with one chamber clean. Six-tenths pressure runs the machine. It is running to our entire satisfaction. Respectfully yours,

[Signed] JOHN H. McELROY, Engr.

LACLEDE GAS WORKS, }
 ST. LOUIS, Nov. 25, 1884. }

GEO. SHEPARD PAGE, Esq.:

Dear Sir—The Scrubber is performing its work to our entire satisfaction. It has passed and thoroughly freed from ammonia 30 per cent. more gas than it was rated as being able to pass. The test paper shows not a trace of ammonia at the outlet.

Respectfully yours,
 [Signed] FREDERIC EGNER,
 Engr. and Supt.

"Standard" Washers Ordered During the Current Year.

	Cu. Ft. per Day
Anneberg Gas Co.....	200,000
Bombay Gas Co.....	400,000
Brussels Co.....	1,250,000
Chemnitz Gas Co.....	1,000,000
CITIZENS GAS CO., BUFFALO.....	750,000
Coke Works in Zabre, Ober-Schlesien.....	1,500,000
Cokerel der Friedenschutte, Upper Silesia.....	700,000
Dumfries Corporation.....	250,000
Dunedin Gas Co., New Zealand.....	400,000
King's Lynn Gas Co.....	300,000
Leiden, Holland.....	600,000
Lincoln Gas Co.....	400,000
Liverpool Gas Co.....	2,000,000
" ".....	3,000,000
LOUISVILLE GAS CO.....	1,500,000
Numea Gas Co.....	100,000
PITTSBURGH GAS CO.....	1,500,000
PORTLAND GAS CO., Oregon.....	562,500
SAN FRANCISCO GAS CO.....	4,000,000
Sheepbridge.....	40,000
ST. LOUIS GAS CO.....	2,000,000
Sydney Gas Co.....	2,500,000
WASHINGTON, D. C. GAS CO.....	2,000,000
Whitechurch Gas Co.....	175,000
Total.....	26,177,500

GEO. SHEPARD PAGE, No. 69 WALL STREET, NEW YORK,

SOLE AGENT FOR THE WESTERN HEMISPHERE.

A. H. M'NEAL,

BURLINGTON, N. J.

Flange-Pipes

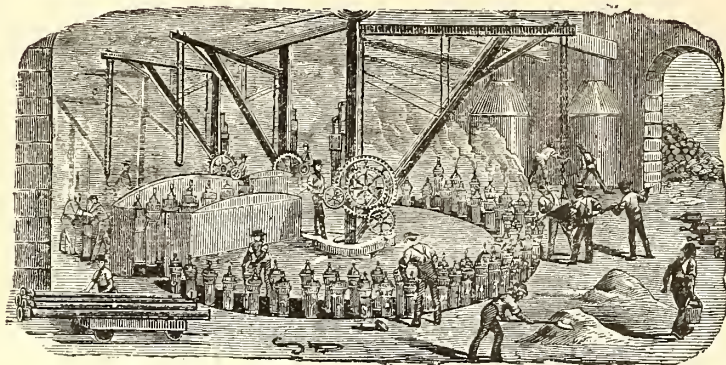

General Foundry Work.

CAST IRON PIPES

FOR WATER AND GAS.

JAMES S. MOORE, Pres.
BENJAMIN CHEW, Treas.

JAS. P. MICHELLON, Sec.
WM. SEXTON, Supt.

GLOUCESTER IRON WORKS,

GLOUCESTER CITY N. J.

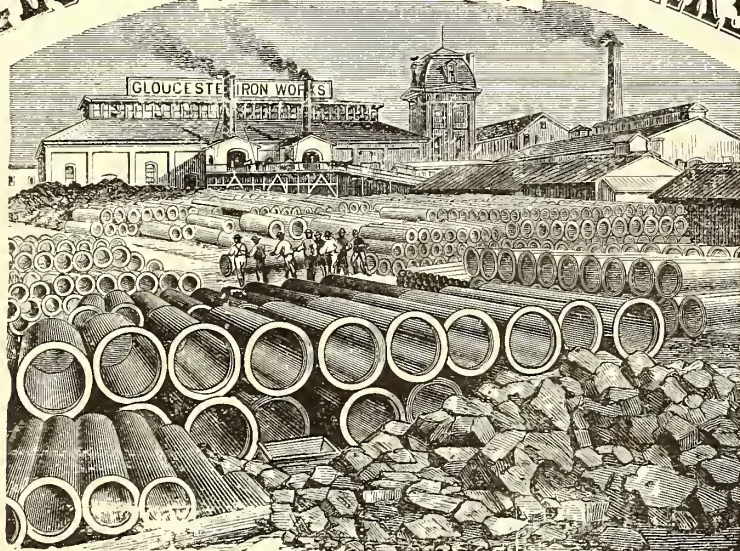

Cast Iron Gas & Water Pipes, Stop Valves, Fire Hydrants, Gasholders, &c.
Office No. 6 North Seventh Street, Philadelphia.

ESTABLISHED 1856.

WARREN FOUNDRY AND MACHINE CO.,

WORKS AT PHILLIPSBURGH, N. J.
NEW YORK OFFICE, 162 BROADWAY.

Cast Iron Water and Gas Pipe

FROM TWO TO FORTY-EIGHT INCHES DIAMETER.
ALSO ALL SIZES OF

FLANGE PIPE for Sugar House and Mine Work.
Branches, Bends, Retorts, Etc., Etc.

486-1

MATTHEW ADDY, President.

W. L. DAVIS, Selling Agent.

GEO. P. WILSHIRE, Sec. & Treas.

Cincinnati and Newport Iron and Pipe Company,

NEWPORT, KY.

Lamp Posts
AND
BENCH CASTINGS

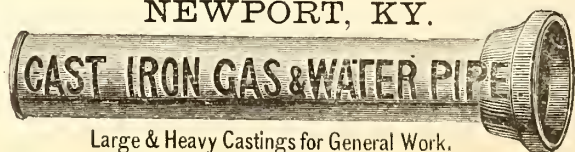

Branch
AND
SPECIAL CASTINGS

A Specialty.

Large & Heavy Castings for General Work.

FOR GAS & WATER CO'S.

Manufacture Pipe from 2 to 48 inches. All work guaranteed first quality.

Mellert Foundry and Machine Co.

Limited. Established 1848.

MANUFACTURERS OF



Specials—Flange Pipe, Valves and Hydrants,
Lamp Posts, Retorts, etc.

Machinery and castings for Furnaces, Rolling Mills, Grist and
Saw Mills, Mining Pumps, Hoists, etc.

GENERAL OFFICE, - - - READING, PA.

To Gas Companies.

We make to order **CAP BURNERS** to burn any amount
under a stated pressure. Send for samples.

Also, **SERVICE CLEANERS, DRIP PUMPS,** and **STREET
MAIN PROVING APPARATUS.**

C. A. GEFROER,
248 N. 8th Street, Phila., Pa.

MORRIS, TASKER & CO.,

Limited,

Builders of Gas Works,
PHILADELPHIA, PA.

LUDLOW VALVE MFG. CO

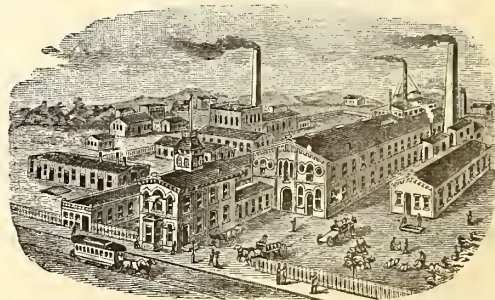

OFFICE AND WORKS,

938 to 954 River Street and 67 to 83 Vail Av.

TROY, N. Y.

Hydraulic Main Dip Regulators, also
Check Valves, Foot Valves, Yard-
wash and Fire Hydrants.
Send for Circulars.

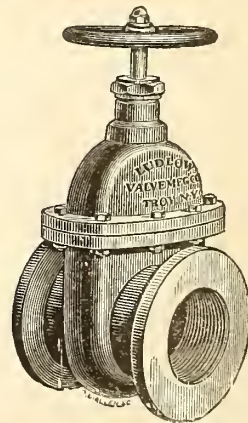

Valves.—Double and Single Gate, 1/2 in. to
48 in., outside and inside Screws. Indica-
tor, etc., for Gas, Water, Steam, and Oil.
Send for Circulars.

JOS. R. THOMAS, C.E.,

May be Consulted on all Mat-
ters Relating to Gas Works
and Gas Manufacture.

ADDRESS THIS OFFICE.

To Non-Paying GAS COMPANIES.

A Gas Engineer of 16 years' experience desires a position with
some Gas Light Company at present not paying to investors,
with a view of placing same on a paying basis. Understands
thoroughly the most economical modes of producing coal gas, as
well as the disposal of all residuals. Would accept the manage-
ment of a small works, with full charge of all books, accounts,
meter statements, etc. Address, for one week,
"A. T.," care this Office.

The Kerr Murray Mfg. Co.,

MANUFACTURERS OF

BENCH CASTINGS,

**Boilers and Engines,
STEAM JET AND ROTARY
EXHAUSTERS.**

HOT TAR SCRUBBERS.

**Annular and Pipe Air
Condensers.**

**Multitubular Water Condensers,
WATER SPRAY WASHERS,**

**Purifiers, Ash Lime Trays, Improved Dry
Center Seals, Meter Bye-Passes,
Hub & Flange Stop Valves.**

**Gasholders,
SINGLE AND DOUBLE LIFT.**

Latest and most improved patterns of gas apparatus, from 4 to 30 inch openings. Plans, specifications, and estimates furnished for erection of new and rebuilding of old works.

**Kerr Murray Mfg. Co.,
FORT WAYNE, IND.**

**JAMES R. FLOYD,
(SUCCESSOR TO HERRING & FLOYD)**

**Oregon Iron Works,
531 to 543 West 20th St., N. Y.**

Practical Builders of Gas Works,

MANUFACTURERS OF

**ALL KINDS OF CASTINGS
AND
APPARATUS FOR GAS-WORKS.**

BENCH CASTINGS

from benches of one to six Retorts each.

**WASHERS : MULTITUBULAR AND
AIR CONDENSERS ; CONDEN-
SERS ; SCRUBBERS**

(wet and dry), and

EXHAUSTERS

for relieving Retorts from pressure.

BENDS and BRANCHES

of all sizes and description.

**FLOYD'S PATENT
MALLEABLE RETORT LID.**

**PATENT
SELF-SEALING RETORT LIDS.**

**FARMER'S
PATENT BYE-PASS DIP-PIPE.**

**SABBATON'S PATENT
FURNACE DOOR AND FRAME.**

**BUTLER'S
COKE SCREENING SHOVELS.**

GAS GOVERNORS,

and everything connected with well regulated Gas Works at low price, and in complete order.

SELLER'S CEMENT

for stopping leaks in Retorts.

N. B.—STOP VALVES from three to thirty inches—
at very low prices.

Plans, Specifications, and Estimates furnished.

CONTINENTAL WORKS.

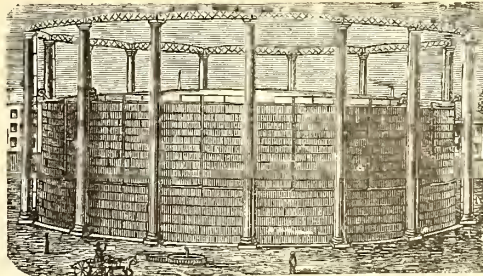

GASHOLDERS OF ANY MAGNITUDE.

**T. F. ROWLAND, Proprietor,
GREENPOINT, BROOKLYN, N. Y.**

ENGINEER AND MANUFACTURER OF

GAS-HOLDERS.

**CONDENSERS, SCRUBBERS, VALVES,
PURIFIERS, RETORTS, and HY-
DRAULIC MAINS,**

and all other articles connected with the Manufacture
Distribution of Gas. Plans and Specifications prepared
and Proposals given for the necessary Plant for Lighting
Cities, Towns, Mansions, and Manufactories.

H. RANSHAW, Prest. & Mangr. WM. STACEY, Vice-Pres. T. H. BIRCH, Asst. Mangr. R. J. TARVIN, Sec. & Treas.

STACEY MFG. CO.,

MANUFACTURERS OF

Single and Telescopic Gasholders,

IRON ROOFS, BRIDGES, LAMP POSTS,

Water and Oil Tanks, Coal Elevator Cars,

COKE CRUSHERS, BENCH CASTINGS,

And all kinds of Wrought and Cast Iron Work used in the erection of Coal and Oil Gas Works.
Rolling Mill Machinery and Heavy Castings a Specialty.

Foundry :

33, 35, 37 & 39 Mill Street.

Wrought Iron Works :

16, 18, 20, 22, 24 & 26 Ramsey Street.

Cincinnati, Ohio.

BARTLETT, HAYWARD & CO.,

Office, 24 Light.

BALTIMORE, MD.

Works, Pratt & Scott.

PURIFIERS.

Roofs.

Bench Castings.

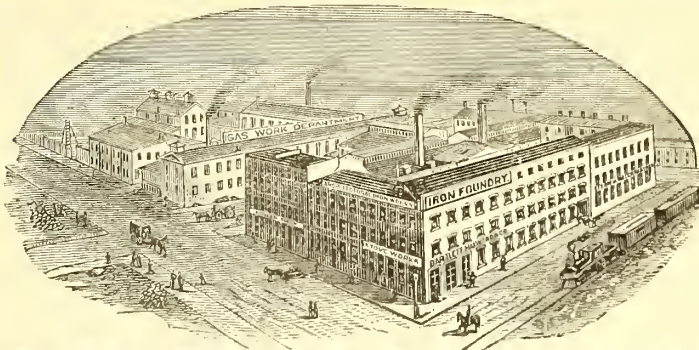

SCRUBBERS.

BOILERS.

CONDENSERS.

GASHOLDERS.

CONSTRUCTING ENGINEERS AND BUILDERS OF GAS WORKS.

1842. DEILY & FOWLER, 1884.

Laurel Iron Works.

Address, No. 39 Laurel Street, Philadelphia, Pa.

MANUFACTURERS OF

GASHOLDERS,

Single or Telescopic, with Cast or Wrought Iron Guide Frames.

Holder Built Since 1880 :

- | | | | | |
|--------------------------|-----------------------|----------------------------|---------------------------|----------------------------|
| Mount Joy, Pa. | West Point, N. Y. | Galveston, Texas (2d.) | Kalamazoo, Mich. (3d.) | Newport, R. I. |
| Rockaway B'ch, N.Y. (2) | Fitchburgh, Mass. | Marlboro, Mass. | Glen Island, N. Y. | Portland, Oregon. |
| Zanesville, O. (2d.) | New London, Conn. | Denver, Col. | Warren, Ohio. | Allegheny, Pa. (4d.) |
| Lancaster, O. | Derby, Conn. | Chicago, Ill. (West Side). | Bath, N. Y. | Atlanta, Ga. (2d.) |
| Blackwell's Island N. Y. | Bridgeport, Conn. | Pittsburgh, Pa. (S. Side). | Lynn, Mass. | N.Y. City (Central Gas Co) |
| Waltham, Mass., (1st.) | Allegheny, Pa. (1st.) | Pawtucket, R. I. | New Bedford, Mass. | Lynchburg, Va. (2d.) |
| Dorchester, Mass. | St. Hyacinth, Can. | Brookline, Mass. | Waterbury, Conn. | Saylesville, R. I. |
| Wheeling, West Va. | Norwalk, O. | Sherbrooke, Can. | Deseronto, Can. | Rondout, N. Y. |
| Lansing, Mich. | Brattleboro, Vt. | Burlington, N. J. (2d.) | Hoosic Falls, N. Y. (2d.) | Atlantic City, N. J. |
| Flint, Mich. | Waltham, Mass. (2d.) | Bridgeton, N. J. | Bethlehem, Pa. | Augusta, Ga. |
| Galveston, Texas (1st.) | West Chester, Pa. | Bay City, Mich. | Atlanta, Ga. (1st.) | Waltham, Mass. (2d.) |
| Milton, Pa. | Baltimore, Md. | Eric, Pa. | Savannah, Ga. | |
| Scranton, Pa. | Hollidaysburg, Pa. | Jackson, Mich. | Montgomery, Ala. | |

GAS COALS.

GAS COALS.

GAS COALS.

JAMES D. PERKINS.

PERKINS & CO.,

F. SEAVERN.

General Sales Agents.

THE YOUGHIOGHENY RIVER COAL COMPANY,

Organized August 1, 1882.

MINERS AND SHIPPERS OF THE WELL-KNOWN

Ocean Mine Youghioghenny Gas Coal.

The Coal from the Ocean Mine (recently operated by Messrs. W. L. Scott & Co., of Erie, Pa.,) is now used by all the leading Gas Companies in the United States from Maine to Texas, and is recognized as *the only reliable Youghioghenny Gas Coal.*

Messrs. W. L. Scott & Co. and W. L. Scott, Esq., still retain their interest in the new Company, and the same general policy which has characterized the management of the mine under these gentlemen will be continued by the new Company. With largely increased facilities and *unlimited supply of Coal*, any demand made upon the Colliery will meet with prompt fulfillment.

THE UNDERSIGNED CAN SUPPLY THE FOLLOWING SUPERIOR GRADES OF

GAS CANNELS:**Abram Cannel**, from the Abram Colliery, Wigan, England,**Plesio-Boghead Cannel**, from near the old Boghead Colliery, Scotland.**North Ince Hall Cannel**, from Liverpool, England.

Breckenridge Cannel, from Kentucky. The railroad now being constructed to the Ohio river will open up this superior Cannel deposit, and enable us to deliver it at any required point. See full description of this Cannel, and Map of the Colliery, in the "American Gas Light Journal," April 16, 1883, pages 172 and 173.

P. O. Box 3695,
New York.**PERKINS & CO., 228 and 229 N. Y. Produce Exchange****BEAVER STREET
ENTRANCE.****SMITH & SAYRE MFG. COMPANY,**

G. G. PORTER, Prest.

245 Broadway, N. Y.

CHAS. W. ISBELL, Sec'y.

Machinery & Apparatus for Gas Works

Drawings, Plans, and Estimates Furnished for the Improvement, Extension, or Alteration of Gas Works, or for the Construction of New Works.

Mackenzie's Patent Rotary and Steam Jet Gas Exhausters, Governors, Compensators, Condensers, Washers, Scrubbers. Isbell's Patent Automatic Street Pressure Governor, Gas and Water Valves, Hydraulic Main Dip Regulator, Bench Castings, etc. Purifying Boxes and "Standard" Scrubbers. Isbell's Patent Self-Sealing Retort Doors.

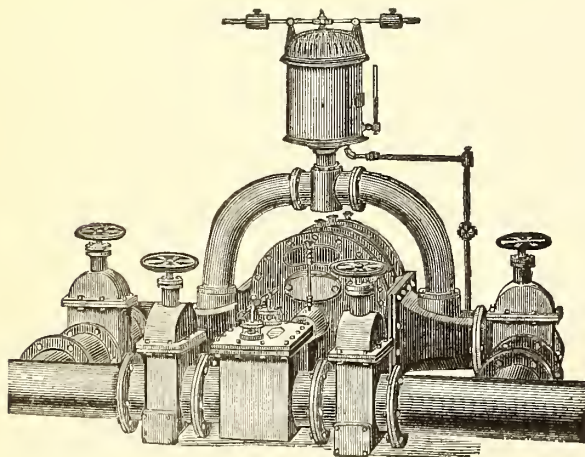
**The Wilbraham Gas Exhauster,**

"BAKER SYSTEM,"

WITH ENGINE ATTACHED, ON SAME BED PLATE OR WITHOUT.

Best, Cheapest and Most Durable Exhauster known.

WILBRAHAM BROS.,

No. 2320 Frankford Avenue, Philadelphia, Pa.

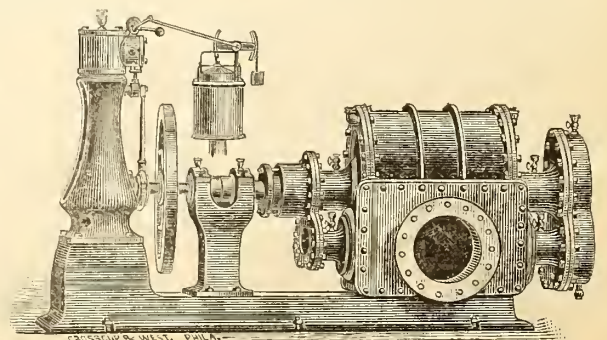

GAS COALS.

GAS COALS.

GAS COALS,

Newburgh Orrel Coal Co.,

MINERS AND SHIPPERS OF

**Newburgh Orrel, Tyrconnell
and Palatine Gas Coals.**

ALSO SHIPPERS OF FOUNDRY COKE.

Mines Situated at

Newburgh, Flemington & Fairmont, W.Va.

HOME OFFICE,

25 S. Gay St., Baltimore.

CHARLES MACKALL,
MANAGER.

CHAS. W. HAYS, Agent in New York,

Room 92, WASHINGTON BUILDING, No. 1 Broadway.

Shipping wharves at Locust Point. References furnished when required. Special attention given to chartering vessels.

THE DESPARD COAL COMPANY

OFFER THEIR SUPERIOR

DESPARD COAL

To Gas Light Companies and Manufacturers of Fire Clay Goods
Throughout the Country.

ROUSSEL & HICKS, } AGENTS. { BANGS & HORTON,
71 Broadway, N. Y. } 16 Kilby St., Boston.

Mines in Harrison Co., West Va. Wharves, Locust Point, Balt.

Company's Office, 15 German St., Baltimore, Md.

Among the consumers of Despard Coal we name: Manhattan
Gas Light Co., N. Y.; Metropolitan Gas Light Co., N. Y.; Jersey
City, (N. J.) Gas Light Co.; Washington (D. C.) Gas Light Co.;
Portland (Maine) Gas Light Co. Reference to them is requested.

MITCHELL, VANCE & CO.,

MANUFACTURERS OF

Chandeliers

and every description of

GAS FIXTURES.

Also manufacturers of Fine Gilt Bronzes and Marble Clock
warranted best time-keepers. Mantel Ornaments, etc.

Salesrooms, 836 Broadway, N. Y.

Special Designs furnished for Gas Fixtures for Churches, Public
Halls, Lodges, etc.

**CATHELL'S
Gas Consumer's Manual.**

Enables every gas consumer to ascertain at a glance, without any
previous knowledge of the gas meter, the quantity and money
value of the gas consumed. Also the best method of obtaining
from gas the largest amount of its light. It will be to the advantage
of Gas Companies to supply their consumers with one of
these Guides, as a means of preventing complaint arising from
their want of knowledge in regard to the registration of meters.

A. M. CALLENDER & CO., 42 Pine St., N. Y.

AMERICAN

GAS LIGHT JOURNAL.

\$3.00 per Annum.

A. M. CALLENDER & CO.,

42 Pine Street, N. Y. City.

**THE
PENN GAS COAL COMPANY**

OFFER THEIR

**COAL, CAREFULLY SCREENED,
AND PREPARED FOR**

GAS PURPOSES.

Their Property is located in the Youghiogheny Coal Basin, near Irwin's and Penn Station
on the Pennsylvania Railroad, and on the Youghiogheny River.

OFFICES

No. 209 South Third Street, Phil'a. 90 Wall Street, New York.

PLACES OF SHIPMENT.

Pennsylvania Railroad, Pier No. 2 (Lower Side).

Greenwich Wharves, Delaware River.

366-ly

Pier No. 1 (Lower Side), South Amboy, N. J.

Chesapeake & Ohio Railway Coal Agency,

FOR THE SALE OF THE

Superior Kanawha Gas Coals, Cannelton Cannel,

Also, SPLINT AND STEAM COALS

From the Kanawha and New River Regions, on the line of the Chesapeake & Ohio R'way.

C. B. ORCUTT, Sales Agent.

OFFICE, 150 BROADWAY, N. Y.

FRANCIS H. JACKSON, PRESIDENT.

EDMUND H. MCCULLOUGH, SEC. & TREAS.

THE WESTMORELAND COAL CO.

Chartered 1854.

Mines situated on the Pennsylvania and the Baltimore
and Ohio Railroads, in Westmoreland County, Penn.

POINTS OF SHIPMENT:

PHILADELPHIA, BALTIMORE, SOUTH AMBOY, N. J.

WATKINS (SENECA LAKE), N. Y.

Since the commencement of operations by this Company its well-known
Coal has been largely used by the Gas Companies of New England and the
Middle States, and its character is established as having no superior in gas-
giving qualities, and in freedom from sulphur and other impurities.

Principal Office, 224 South 3d St., Phila., Pa.

The Bower Gas Lamp.

The Perfected Duplex-Regenerative Gas Burner, under
the combined Patents of Anthony S. Bower,
Geo. S. Grimston, and Thos. Thorp.

The First Gold Medal awarded at the Crystal Palace Exhibition in
London, and two Gold Medals at the Stockport (Eng.) Exhibition of Gas
Appliances. Both in 1883.

GEO. SHEPARD PAGE, JOHN BOWER,
69 Wall Street, N. Y. City.

The Management of Small Gas Works.

By C. J. R. HUMPHREYS. Price, \$1.

A. M. CALLENDER & CO., 42 Pine St., N. Y.



INTERNATIONAL--1876--EXHIBITION.

The U. S. Centennial Commission

HAVE DECREED AN AWARD TO

HARRIS, GRIFFIN & CO.,

12th and Brown Sts., Philadelphia, and 49 Dey St., N. Y., U. S. A.,

FOR THE FOLLOWING REASONS :

The Exhibit consists of a Series of METERS from the Largest Size Station Meters for the use of the MANUFACTURE OF GAS, to those for the use of the ORDINARY CONSUMER. The Instruments are WELL MADE, RELIABLE as to INDICATION, and embody a number of sundry improvements which, with the general character of the Exhibit, entitle the whole to commendation.

Attest—J. L. CAMPBELL,
Secretary, pro-tem.

Signed—A. T. GOSHORN,
Director General

J. B. HAWLEY,
President

CHARLES E. DICKEY.

JAMES B. SMALLWOOD.

CHARLES H. DICKEY.

Maryland Meter and Manufacturing Co.,

DICKEY, TANSLEY & CO.,

Established 1866.

Nos. 22 and 24 Saratoga Street, Baltimore, Md.
No. 46 La Salle St., Chicago, Ill.

MANUFACTURERS OF

DRY GAS METERS, STATION METERS, GLAZED METERS, TEST METERS, METER PROVERS, PRESSURE AND VACUUM REGISTERS, GOVERNORS, INDICATORS, SERVICE AND METER COCKS, AND METER CONNECTIONS.

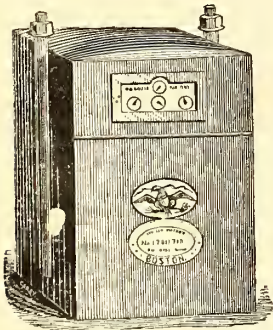

Dry Gas Meter.

With 39 years' experience and the best facilities for manufacturing, is enabled to furnish reliable work and answer orders promptly.

NATHANIEL TUFTS,

No. 153 Franklin Street, Boston, Mass.,

MANUFACTURER OF

DRY GAS METERS.

Station Meters of any Capacity.

Test and Experimental Meters, Pressure Registers, Pressure Gauges,
Pressure and Vacuum Gauges.

METER PROVERS, PHOTOMETERS, STREET LANTERNS, ETC., ETC.

Patent Cluster Lanterns for Street Illumination.

SCIENTIFIC BOOKS.

We are prepared to furnish to Gas Managers, and others interested in the topics treated of, the following books, at prices named :

KING'S TREATISE ON THE MANUFACTURE OF COAL GAS. Three vols.; \$10 per vol.	GAS CONSUMER'S MANUAL, by E. S. CATHELS, C.E. 10 cts.	CORRECT GAS MEASUREMENT; the serious Loss and Inconvenience to Gas Companies and the Public Caused by the Freezing and Inaccuracy of Wet Gas Meters, by GEORGE GLOVER. 40 cents.
GAS MANUFACTURE, by WILLIAM RICHARDS. 4to., with numerous Engravings and Plates, in Cloth binding. \$12.	PRACTICAL TREATISE ON HEAT, by THOMAS BOX. Second edition. \$5.	GAS WORKS, AND MANUFACTURING COAL GAS, HUGHES. \$1.40.
THE GAS ANALYST'S MANUAL, by F. W. HARTLEY. \$2.50.	FODELL'S SYSTEM OF BOOKKEEPING FOR GAS COMPANIES. \$5.	A PRACTICAL TREATISE ON GAS AND VENTILATION, with Special Relation to Illuminating, Heating, and Cooking by Gas, by E. E. PERKINS. \$1.25.
ANALYSIS, TECHNICAL VALUATION, PURIFICATION, and USE OF COAL GAS, by REV. W. R. BOWDITCH, M.A.; with Engravings; 8vo., Cloth. \$4.50.	GAS WORKS—THEIR ARRANGEMENT, CONSTRUCTION, PLANT, AND MACHINERY. \$8.	APPARATUS AND FITTINGS FOR GAS WORKS, by F. COLYER. 8vo., Cloth. \$8.
GAS MEASUREMENT AND GAS METER TESTING by F. W. HARTLEY. \$1.60.	COAL; ITS HISTORY AND USE, by PROF. THORPE. \$3.50.	GAS CONSUMER'S HANDY BOOK, by W. RICHARDS. 18 mo., Paper. 20 cents.
GAS CONSUMER'S HANDBOOK, by WILLIAM RICHARDS, C.E.; 18mo., Sewed. 20 cents.	THE GAS WORKS OF LONDON, by COLBURN. 60 cents.	
	THE GAS FITTER'S GUIDE, Showing the Principles and Practice of Lighting with Coal Gas, by JOHN ELDRIDGE. 40 cents.	

The above will be forwarded by express, upon receipt of price. We take especial pains in securing and forwarding any other Works that may be desired, upon receipt of order. All remittances should be made by check, draft, or post office money order.

A. M. CALLENDER & CO., No. 42 Pine Street, New York.

T. C. HOPPER, Pres. G. J. McGOURKEY, Vice-Pres. (New York). WM. N. MILSTED, Gen. Supt. & Treas. (New York). WM. H. DOWN Sec.

AMERICAN METER COMPANY,

WET AND DRY GAS METERS.	PRESSURE REGISTERS.	METER PROVERS.
STATION METERS.	PRESSURE & VACUUM REGISTERS.	PORTABLE TEST METERS.
EXHAUSTER GOVERNORS.	PRESSURE & VACUUM GAUGES.	EXPERIMENTAL METERS.
DRY CENTRE VALVES.	CRESSON GAS REGULATORS.	AMMONIA TEST METERS.
GOVERNORS FOR GAS WORKS.	MARSLAND WATER METERS.	BAR AND JET PHOTOMETERS.

Manufactories:	GAS STOVES,	Agencies:
512 W. 22d St., N. Y.	SUGG'S "STANDARD" ARGAND BURNERS,	177 Elm Street, Cincinnati.
Arch & 22d Sts., Phila.	SUGG'S ILLUMINATING POWER METER,	244 & 246 N. Wells Street, Chicago.
	Wet Meters, with Lizar's "Invariable Measuring" Drum.	510 North Second Street, St. Louis.
		122 & 124 Sutter St., San Francisco.

HELME & McILHENNY.

Successors to Harris & Brother.

ESTABLISHED 1848.

PRACTICAL GAS METER MANUFACTURERS,

Continue as heretofore at the OLD ESTABLISHMENT, Nos. 1115 and 1117 Cherry Street, Philadelphia, Pa.

To manufacture Wet and Dry Gas Meters, Station Meters, Experimental Meters, Meter Provers, Centre Seals, Governors, Pressure Registers, Indicators, Photometers, and all kinds of Gas Apparatus; Also furnish all other Articles appertaining to the use of Gas Works.

From our long Practical Experience of the Business (covering a period of 33 years) and from our personal supervision of all Work, we can guarantee all orders to be executed promptly, and in every respect satisfactorily.

WILLIAM HELME.

JOHN McILHENNY.

WM. WALLACE GOODWIN, Prest. and Treas.

WM. H. MERRICK, V.-Prest.

S. L. JONES, Sec.

S. V. MERRICK, Asst. Sec

THE GOODWIN GAS STOVE AND METER COMPANY,

Successors to W. W. GOODWIN & CO.

1012, 1014 and 1016 Filbert St., Phila., Pa. 142 Chambers St., New York.
126 Dearborn St., Chicago, Ill.

WALDO BROS., Agents, 88 Water St., Boston.

MANUFACTURERS OF THE "SUN DIAL" GAS STOVES, FOR COOKING AND HEATING PURPOSES.

Dry and Wet GAS METERS, Station Meters (Square, Cylindrical or in Staves) Glazed Meters, King's and Sugg's Experimental Meters, Lamp Post Meters, Etc., Etc., Meter Provers (sizes 2, 5 and 10 feet), Pressure Guages of all kinds, Pressure Registers, Pressure and Vacuum Registers, Pressure Indicators (sizes 4 inch, 6 inch and 9 inch), King's Pressure and Vacuum Gauges, Dry and Wet Centre Seals, Dry and Wet Governors, Exhauster Governors, Photometers of all descriptions. Letheby's Sulphur and Ammonia Test Apparatus complete—also Testing and Chemical Apparatus of all kinds, and of the most perfect description, for all purposes relating to Gas.

GOODWIN'S IMPROVED LOWE'S JET PHOTOMETER.

Agents for Bray's Patent Gas Burners and Lanterns.

Special attention to repairs of Meters, and all apparatus connected with the business.
All work guaranteed first class in every particular, and orders filled promptly.

G. B. EDWARDS, Mang'r, New York.
E. H. B. TWINING, Mang'r, Chicago.

D. McDONALD & CO., GAS METER MANUFACTURERS.

(Established 1854.)

No. 51 Lancaster Street, Albany. N. Y.

STATION METERS, EXPERIMENTAL METERS, METER PROVERS, PRESSURE & VACUUM REGISTERS, PRESSURE GAUGES, ETC.

Also STAR GAS STOVES, RANGES, and HEATING STOVES.

We use only the very best materials, and employ the most skilled labor, and by our long experience (29 years) and personal supervision of every detail, we feel justified in assuring the public that our goods will give perfect satisfaction. Every Meter emanating from our establishment will bear the State Inspector's Badge, and will be fully warranted by us. Our Annual and Calendar will be sent to Gas Companies upon application.

KING'S TREATISE ON COAL GAS.

The most complete work on Coal Gas ever published. Three vols., bound, \$30.

A. M. CALLENDER & CO., No. 42 Pine Street, New York.

THE GOODWIN GAS STOVE AND METER CO.,

Successors to W. W. GOODWIN & CO.,

1012, 1014 & 1016 Filbert St., Phila., 142 Chambers St., N. Y., 126 Dearborn St., Chicago.

Agents, WALDO BROTHERS, 88 Water Street, Boston.

WM. W. GOODWIN, PRES. & TREAS.
W. H. MERRICK, VICE-PRES.
S. LEWIS JONES, SEC.

SOLE MANUFACTURERS OF THE

SAMUEL V. MERRICK, ASST.-SEC.
G. B. EDWARDS, Mang'r, N. Y.
E. H. B. TWINING, Mang'r, Chicago.

"SUN DIAL" GAS STOVES

The Most Economical, Efficient, and Durable Gas Stove Made.

Since 1878 when we began to manufacture these Stoves, we have received 17 Gold, Silver, and Bronze Medals, and 6 Diplomas for Efficiency, Superiority of Workmanship, etc. etc.

ALL FITTINGS ARE NICKEL-PLATED WITHOUT EXTRA CHARGE.

THE OVEN BURNERS ARE CONSTRUCTED TO BURN EITHER PURE GAS OR GAS AND AIR MIXED.

FROM TWENTY-FIVE TO FORTY PER CENT. OF GAS SAVED BY THE USE OF OUR PATENT OVEN LINING.

STOVES THAT WILL COOK FOR ONE PERSON OR ONE THOUSAND PERSONS AT ONE TIME.

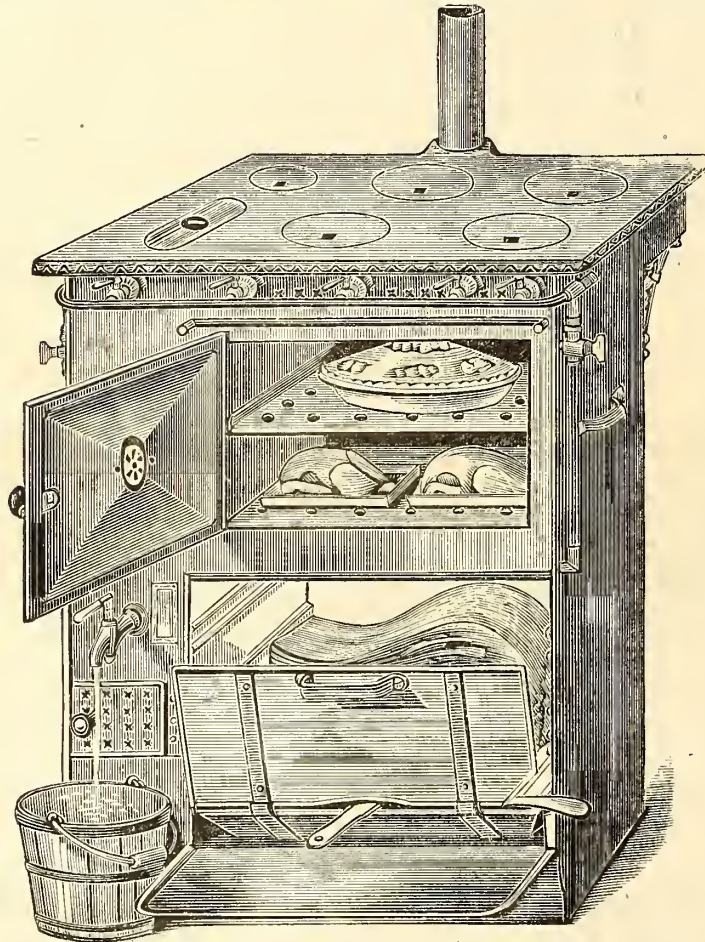

Gas Cooking Stove No. 9A. FITTED WITH OUR PATENT TOP AND OUTLET PIPE FOR CARRYING OFF COMPLETELY ALL THE PRODUCTS OF COMBUSTION FROM, OVEN, ROASTER, AND TOP BURNERS.

We carry in Stock Nos. 7, 8, and 8A Cooking Stoves fitted with our Patent Tops. See Catalogue and Price List.

We desire to call attention to our IMPROVEMENT IN THE TOP OF THE SUN DIAL GAS STOVE, by means of which all the odors and products of combustion from the ovens and top burners are entirely removed from the room. This is accomplished by channels and flues connected to the pipe shown at back of stove, to which is connected such additional pipe as may be necessary to connect the same with the flue or chimney, thereby producing the same effect in conveying away the products of combustion as is done in the use of the ordinary range, etc. This arrangement fills a want that has long been felt by those who have objected to the use of gas stoves for the reason of there being no adequate means to remove the products of combustion and odors from the roasting chambers, ovens, and boiling burners, all of which is now accomplished. *We have secured the improvement by Letters Patent in this country and Europe, and any attempt at infringement will be prosecuted.*

AGENTS FOR CLERK'S PATENT GAS ENGINE.

STOVES FOR LAUNDRIES, HATTERS, AND TAILORS.

HOT WATER GENERATORS FOR USE IN KITCHENS, BATH ROOMS, ETC., ETC.

BROILING RANGES FOR RESTAURANTS AND HOTELS.

OVER THIRTY-FIVE THOUSAND STOVES OF ALL SIZES SOLD SINCE 1878.

SEND FOR ILLUSTRATED CATALOGUE.

THE AMERICAN

GAS LIGHT JOURNAL

REDMAN & KENNY, N. Y.

PUBLISHING OFFICE No. 42 PINE STREET

DEVOTED TO THE INTERESTS OF ILLUMINATION, VENTILATION, WATER SUPPLY AND DISTRIBUTION, & GENERAL SCIENCE.

VOLUME XLII.—No. 2.
Whole No. 614.

NEW YORK, FRIDAY, JANUARY 16, 1885.

\$3 PER ANNUM
IN ADVANCE.

A. M. CALLENDER & CO., Proprietors. C. E. SANDERSON, Manager.
JOS. R. THOMAS, C. E., Editor.

ENTERED AT THE POST OFFICE AT NEW YORK, N. Y.,
AS SECOND CLASS MATTER.

Published on the 2d and 16th of each month, at No. 42 Pine Street, N. Y.

Terms of Subscription, Including Postage.—For the United States and Canada, \$3 per annum. European countries, \$3.50 (15 shillings—18 francs). All payments to be made in advance. Single copies, 15 cents.

Correspondence.—Wishing to make this JOURNAL a gazette of intelligent discussion to those of our readers who may wish to gain or give information on the subjects to which its columns are devoted, correspondence is solicited for publication from all who make the study of those subjects a pleasure or a profession.

Remittances should be made either by post-office order, registered letter, or bank draft on New York, payable to the order of A. M. Callender & Co.

Collections are invariably made directly from this office, for subscriptions, advertisements, etc. We have agents to solicit the same, but they are not authorized to receipt for money.

Books.—We will mail, post-paid, at publisher's lowest rates, any book—scientific or otherwise—to any address in the United States or Canada. No books will be sent C. O. D.

The American News Company, Nos. 39 and 41 Chambers street, New York, are agents for this JOURNAL. Newsdealers will send orders to them.

CONTENTS.

An Asterisk (*) denotes an illustrated article.

EDITORIALS—

The Gas Meter as a Vexatious Problem.....	29
Preparing and Applying a Coating of Gas Tar.....	30
Bids for Public Lighting in Brooklyn, N. Y.....	30
Suggestions for Reflection when in Thoughtful Mood—by Jos. R. Thomas, C. E.....	31
On the Use of Coal Gas—By H. Dixon, M. A.....	33
Gas Heat for Mechanical Purposes—By T. J. C.....	36
Coal Tar Colors.....	37
Oil and Gas Wells of Pennsylvania.....	38
Condensing Sulphuric Acid Gas.....	39

ITEMS OF INTEREST FROM VARIOUS LOCALITIES.....

Yonkers (N. Y.) Gas Light Company Reduces Price of Gas—An Interesting Note from East Chester Company, of Mt. Vernon, N. Y.—Another Victim—Coke Fuel Consumption and Railroads—A Novel Way of Catching a Thief—Cheaper Gas for Topeka, Kan.—Electric Light Plant Injured by Lightning Strokes at Houston, Texas—A Trifling Difference in the Figures—Personal—Another Mysterious Pilgrimage Case, with the Reason Therefor—The Gate City Gas Company Increases the Atlanta (Ga.) Death Roll—An Explosion of Gas at North Adams, Mass.	
A New York Victim.....	41
This One a Suicide.....	41
The Plumber Once More.....	41
Gas-Heated Assaying Furnace.....	41
Contract Awarded.....	41
The Market for Gas Securities.....	41

THE GAS METER AS A VEXATIOUS PROBLEM.

Of all the long string of reasons, according to the most usually accepted and indeed now universally put forward theories of the gas consumer as to why the managers of gas companies should be rated as but little, if any, removed from classification with ordinary road agents (often called highwaymen), none other seems to be so thoroughly convincing than the oft repeated fables respecting the gas meter. Mr. B. is perfectly willing to solemnly asseverate that upon the return of himself and family from their summer vacation (they were gone three months), they found a large gas bill awaiting quietly for settlement; and Mr. B. does not rest his case there. He is just as bold in his assertion that the house was closed up tight during the whole period; but in the next breath, as going to show his entire and positive fairness in the matter, he qualifies the absolute "tightness" by excepting the kitchen and one of the servant's bedrooms from the total. He was obliged to leave one domestic behind in order that the household goods might be watched over by vigilant eyes; but still and all he is perfectly certain that that gas bill represents at least five times the quantity of gas that could have been by any possibility consumed in the interregnum of the summer hegira. Then does the full measure of his wrath burst forth; and it is in truth hard to say which receives the most copious share of wordy castigation—the company or its meter. Indeed it matters but little so far as either of the culprits are concerned, as the interests of the two are so intimately connected that it is a case of Master or Tray. Before the softening influence of time has dulled the edges of his passion, the portly or slender (as the case may be), but equally indignant Mr. B. hies him away to the palatial marble halls of the oppressor, and all aglow with his earnestness of purpose, and anxiety for "a chance at 'em," he confronts the pampered cashier with an ominous frown, throws down the bill (still the stolid account awaits settlement), and then is his opportunity. The poor financial agent of a "bloated and grinding monopoly" hangs down his head, or else indulges in as vacuous an expression of countenance as he can command. He adopts neither line of conduct owing to shame or lack of courage on the one hand, or want of intelligence on the other. No; he has been through many such scenes before, and their frequent repetition has taught him the diplomacy, nay, necessity, of allowing "Nature take its course." When the first onslaught is over—the duration of which always depends much upon the physical and vocal condition of the disgruntled—a series of questions and answers are proceeded with. The vacuous look has departed from the cashier, and his head has resumed its normal poise. He asks the irate consumer whether the housekeeper in charge of the citadel has been catechised as to how much company she entertained in the kitchen during the absence of her employer, etc., and he is perfectly certain beforehand what the answer thereto is to be. Mr. B. did not put any of these questions to his faithful domestic, who had been employed by his family for a stated number of years (never less than seven), and was a most trustworthy, careful, economical person. Indeed it was solely on account of her superior qualifications in this regard that she was chosen to guard the home possessions, etc. When the wearisome cross examination draws to a close, the head of the household is satisfied, to a certain extent, that he has sufficiently asserted his knowledge of the rascality of the company, the duplicity of the meter, and other minor details going to make up the aggregate of the gross and unwarranted deception which has made him a martyr. Usually he ends by paying the bill, and goes off shaking his head as an evidence of the firm determination possessing his soul to

return to more primitive methods of artificial illumination. Sometimes he retires himself to the quiet of his library, and indites a letter to his favorite newspaper, in which he most pathetically portrays the evils suffered by him in particular, and his fellow consumers in general. It is to the letter-writing class of the disgruntled that the Anuanias-like character of the meter is most painfully apparent; and it is upon this theme that his pen most loves to dilate.

Before leaving people of Mr. B.'s classification we would like to put upon record a case which may possibly be worthy of mention here, as it came under the personal observation of the writer. Some years ago, in a town not so very far from New York city as to require an extended journey to reach it, there resided a gas consumer who was never known to pay a gas bill without previously disputing its authenticity as to correct rating of charged consumption. The party was also, as may readily be inferred, a pronounced enemy to the gas meter, and never lost an opportunity of making strong avowal of his lack of confidence therein. The particular instrument registering his supply was a little more closely looked after than the general run of meters in the company's district, and so its accuracy was well known as a fixed fact. The consumer was a liberal user of gas, which might be accounted for from the important fact that he was the possessor of quite an interesting and a numerically strong body of daughters. During the first week in a certain month of June he determined to visit Europe, with his entire flock as a body guard. The house was to be closed during his absence to all intents and purposes, *except* that one female servant was to remain on duty to keep things in order; and the domestic received minute instructions as to how she was to act in regard to lighting arrangements. She *might* use the bracket burner in her bedroom, but a kerosene lamp was considered sufficient for all other illuminating requirements, in kitchen, etc. Our prudent man (the keeping of a servant in his employment during his absence was proof that ordinarily he was liberal enough) informed the officers of the gas company of his intended trip, and told them, inasmuch as he should not remain away over three months, and that as gas was only to be used after the manner indicated, it would hardly be necessary to send an inspector to take the meter until such time as the family returned. They made the trip, and returned in good order after an absence of just 92 days. The first thing done was to grant the servant who had so nobly guarded the homestead permission to visit some relatives, her leave of absence covering a week's time. While she was away the inspector called, read the meter, and turned his reading into the office. A change had been made in the book-keeping department of the company, and the man who entered up the account handed the bill in due form to the collector. The latter called at the premises in question and inquired for paterfamilias; the gentleman was not at home, and the account was left with a domestic for transmission to the proper source. Materfamilias never deigned to look at it, but placed it in its appropriate pigeonhole. When the parental authority arrived back from his "outing," he in due course of time seated himself before his desk, and about the first thing to attract his attention was a pink-colored slip whose prior appearances had often been the signal for contention. He probably chuckled inwardly when he thought how small that quarter's gas bill must be; and how speedily that chuckle must have altered its nature when he found upon the harmless paper, spread out in bold relief, the figures \$18.50! Now was the time for action, and here was the opportunity for showing up the meter, to say nothing of convicting the gas company. That citizen made haste to the cashier, and demanded an explanation. The offended consumer vouched for the faithfulness of his servant; the inspector was examined—he verified the meter reading; and the unfortunate meter was then tested. The test proved its accuracy, and further developments awaited the return of the domestic. When she reported for duty her employer immediately cross-examined her, and she averred she had followed his instructions in the matter of lighting. Then the "great defrauded" calmly awaited the advent of the gas company's superintendent; his cross-examination finally elicited from the recreant maid that, acting upon the advice of her "company" (she had the luck to ensnare a plumber) she had been induced to employ a small gas cooker whereupon to prepare her food during the hot summer time. Her faithful swain had procured the cooker and agreed to take it away before her employer returned. He kept his bargain; but the mystery of the whole thing was to satisfactorily explain why both of the parties should fail to remember that the meter was constantly piling up evidence to convict them.

We are disposed to believe that gas managers, as a rule, are most anxious to conciliate their customers, and are fast becoming adepts in the art of smoothing over the rough places. Prevention rather than cure of the quoted evil is surely the most efficient means of eradicating it, although it is quite certain that the constitutional grumbler will, to some extent, live in the future; but a victory will have been gained if his gruesome shadow be assisted to "grow less." The papers presented by Messrs. Nettleton and McMillin, to the last assembly of the American Gas Light Association (See Vol. XLI., Dec. 16, '84), are important inasmuch as they go to show the generally

widespread attention now being directed to the importance of the regular periodical inspection of consumers' meters. Outside of the value of such inspection to a gas company in procuring intimate knowledge as to the life and working of each particular instrument, there is the further gain that a particularly obstreperous specimen of the consumer may at any time be confronted with this record to his utter confutation. It needs no argument here to show the fairness of the meter as a recording medium between the seller and consumer of gas—the average of the published figures in tests of government inspectors sufficiently prove the question. Right here we would say that Mr. Pearson, of Toronto, in his contribution to the discussion that followed the reading of the above-mentioned papers, put the case in the proper light when he said that gas managers in every State in the Union should not only be in favor of Government Inspection laws, but should give such statute formations absolute encouragement to become existent in sections where they were not already established. We believe that most of our States have already framed fair meter inspection enactments, and it is hoped the few remaining ones will follow the lead of the others. While we cannot agree with Mr. Monks, of the South Boston Gas Light Company (see discussion in volume above noted), as to the poor policy of making the inspection at the end of every three years, and do thoroughly coincide with Mr. Nettleton, as to his views on the subject, we heartily commend his plan of the glass encased or skeleton show meter, and applaud his selection of the place wherein to exhibit it. The smallest company in the country could with great profit to itself imitate his practice in this respect, and so stifle many a complaint ere it had rightly been emitted by the utterer. Forbearance, conciliation and proof tests are the potions most likely to still the spasms which so frequently agitate the average gas consumer when descending upon his favorite theme—the rascally, lying meter.

Preparing and Applying a Coating of Gas Tar.

There are many localities in this country where the preservation of common external woodwork, such as fence posts, well covers, grain cribs, etc., from the ravages of moisture, and frequent extremely variable changes in temperature, becomes somewhat in the nature of a vexatious, not to say expensive problem. It is far from being a new suggestion to call attention to the efficacy of ordinary coal gas tar in the painting of such wooden surfaces, for the practice is certainly ancient enough to convince the reader that its use is not recommended on the score of novelty. Complaints have frequently been made that gas tar applications do not possess the virtues claimed; still such complaints are much more than offset by abundant testimonials to the contrary coming from experimenters who have made careful practical trials of the matter. The sort of coal carbonized has, of course, a most important bearing on the constituents of the tar product; but it may be safely assumed that a coal carrying a not abnormally high percentage of sulphur impurity will yield a tar that is in all respects fitted to the work of arresting the undue progress of decay in the sorts of rough woodwork mentioned above.

A method of preparing the tar for this system of painting, much in vogue in certain parts of Europe, is the following: An iron kettle capable of holding three gallons of tar is set over a slow fire, and the contents allowed to simmer for about an hour. After the simmering process has occupied the allotted time, add a handful of quicklime and stir it well in. Remove from fire, and add, say, a quart of benzine or naphtha—or a portion just sufficient to make the finished mixture run easily from the end of an old paint brush. The "paint" is then ready for use, and should be applied while quite hot. The best results will follow when the woodwork operated upon is in a thoroughly dry state.

Bids for Public Lighting in Brooklyn, N. Y.

The following are the various bids submitted by the gas companies of the city of Brooklyn for the public lighting of that place during 1885:

	Street Lamps.	Public Buildings.
Brooklyn Gas Light Company, each per annum . . .	\$19.80	\$1.50 per M.
Williamsburgh " " " " . . .	21.75	1.75 "
Peoples " " " " . . .	22.00	1.75 "
Metropolitan " " " " . . .	22.00	1.75 "
Nassau " " " " . . .	22.00	1.75 "
Citizens " " " " . . .	22.00	1.75 "

For the first time in the history of Brooklyn proposals were made to supply arc illumination for the streets. The propositions were handed in by representatives of the Brooklyn and Municipal Electric Lighting Companies—the former to furnish the Western and the latter the Eastern Districts of the city with such lights as might be awarded them. It would not be surprising if they did obtain an award this time, as we note that Mr. Hugh McLaughlin (otherwise known as the "Democratic Boss" of the city) is interested in the first named concern. The annual charge for each "arc" was fixed by both companies at \$255.50, a familiar figure to New York taxpayers.

[A Paper read before the Society of Gas Lighting.]

Suggestions for Reflection When in Thoughtful Mood.

By JOSEPH R. THOMAS, C. E.

It was the desire and intention of those most active in the formation of the Society of Gas Lighting that its chief aim and object should be the bringing more immediately and intimately in contact with one another those persons engaged in the manufacture of illuminating gas in the vicinity of New York. The supposition was that a Society of this nature could not fail to operate beneficially, in so far as regarded the mutual improvement of all those connected with it, through the obtaining of an increased store of knowledge on all matters appertaining to the subject of gas manufacture; and the natural effect of this advance in knowledge must of necessity result advantageously in more fully preparing the recipients thereof for the successful prosecution of the business in which they are engaged, and therefore enable them to conduct that business in a more intelligent and satisfactory manner both to themselves and the companies represented by them.

In thus meeting together as a Society it was fair to presume that the persons composing the same would become quite intimately acquainted with one another, and it was quite in line with the presumption that the outcome of such intimacy would be to make them ready and willing, at any and all times, to impart, upon any subject brought before the Society, any particular or desired information possessed by the one and sought after by the other.

In order that the members might be brought frequently together, it was so arranged that the meetings of the body should be held monthly, and, further, that the sessions should take place alternately at the works of some individual member attached to the Society. It was foreseen that the provision made for meeting at the different gas works would develop frequent opportunities for making practical examination into the merits of any new apparatus installed in the plants—in short, furnishing certain means whereby critical inspection could be made upon any new departure in the method of accomplishing work intended to develop economy in gas manufacturing establishments.

Another feature proposed by the originators of the Society (and one rightly considered as of the greatest importance) was that papers, treating on some topic of general interest to the members, and intended to convey the writer's own ideas on the theme selected, were to be presented at each of the monthly sessions.

Now, to briefly sum up the case as it stands, in the attempt to determine whether the aims of its founders have been realized, I beg leave to say it is my honest conviction that the original objects have been attained; and that the outcome has been of very material benefit and advantage to us all as members of this Society, and furthermore has furnished us many an occasion on which we experienced a thrill of honest and justifiable pride when considering the uniform measure of success and progress that has attended our growth. The meeting together at the various gas plants has afforded the opportunity for critical inspection, examination, and comparison which it was designed to create; the presentation and reading of papers has had the desired effect of at once placing before us matter calculated to enhance the interest felt in attending the sessions, and stimulating that free interchange of opinion, through the medium of the ensuing discussion, which is best assured to inculcate and foster honest business intimacy.

This manner of freely, fully, and fairly discussing the various points relative to the merits or demerits of any new thing proposed is pretty sure to lead to a thorough sifting. A still further advantage of the practice of discussion will be found in the fact that a member, instead of relying simply and solely upon his own judgment, on matters that may have a most important signification to himself, owing to certain pressing force of circumstance or position, may have the benefit of the combined opinion and experience of his fellow-members.

If it be true, as it is said, "In a multitude of counsellors there is wisdom," then it should follow that, in the bringing up of any new matter before the Society, in the way mentioned, and after fair and free discussion is had, the information thus acquired would enable each and every one to reach the point of readily determining the most advantageous course to be pursued under identical circumstances.

Since the organization of the Society of Gas Lighting—now nine years—many things have been brought to our notice, all in the line of the same praiseworthy object—reducing the cost of gas manufacture. Among the most prominent of these may be mentioned the erection of a better class of benches, and the adoption of improved apparatus and methods for cleansing and purifying. In the operation of our plants the yield from a bench of retorts has been materially increased beyond that which was formerly obtained at not such a long period ago. This gratifying result has been brought about by the employment of larger carbonizing vessels, their better setting, and the institution of improved firing methods. Judging from the great strides thus far made in this direction, it seems only fair to assume that the

end has not yet been reached, and reasonable to surmise that well-directed and earnest application on the part of those prosecuting their researches on the subject may be trusted to develop still better practices for performing the work, and, at the same time, be also in the line of economy.

In referring back some years we may easily bring to mind the period when the maximum yield from a retort did not exceed 3,000 or 3,500 cubic feet per diem; and this, at the time, was considered a very good result. The increased yield gained from a working retort has advanced between that time and this, until now we are able to note in our ordinary operation retorts capable of a per diem production of 10,000 cubic feet. This glance over what has been accomplished in increased yield per retort during intervening periods, not so widely separated either, will simply show what great production gains have been already secured, and prompts us to believe that the ungleamed field opening up before us is yet large indeed.

Improved methods of firing have occupied a large share of attention, and the various forms of regenerator furnaces all have their advocates. In the substitution of these systems for the common old-style furnace, it is asserted, and no doubt truthfully so, by those who have employed them, that a very great saving in fuel expenditure is secured. Some supporters of the regenerator furnace claim that they can (and do) accomplish carbonization with a use of but 20 per cent. of the coke produced. This is undoubtedly a very low figure, and is also a much lower one than that claimed by some others who employ the advanced firing system—these latter asserting that from 25 to 30 per cent. of the coke product is required to maintain the heats at the necessary temperature. But aside from the item of precise percentage, any saving of fuel is an undoubted move in the right direction, since coke saved may be set down as coke gained—every bushel of the gain meaning so much more to the credit of the residual account.

And while talking about coke as a fuel, not alone in its use about a gas plant, but with reference as well to its value as a steam producer and a domestic agent, it seems worth while suggesting that the topic is well worthy of consideration on the part of every gas works manager. It is a fact, and its truth ought to be well known, that coke fuel has a far greater domestic value than that ordinarily assigned it. In domestic use it is more easily manageable, and its fire may be kept alive more readily, than is the case with its competitor, anthracite coal; and, besides, the question of relative economy is all in its favor. These assertions only require for their substantiation, on the part of all, a trifling amount of investigation, and are advanced by the writer as the result of his own careful observation. The present plan of domestic heating agent is all sufficient for its economical use, no matter whether it be the usual Baltimore heater, self-feeder, or kitchen range. In all such vehicles coke may be relied upon as a faithful and efficient substitute for anthracite coal as far as calorific effect is concerned, and the substitution can be made with the agreeable feature of being an economical transaction. These opinions have been verified by the experience gained in years of personal use of this residual.

Now, it is to be regretted that most of our gas managers have been quite dilatory in their attention to such a simple matter—that of neglecting to suitably prepare their coke product to fit it for general domestic consumption, by crushing it to suitable sizes. At the present time, in a great majority of localities, it is impossible for the householder to obtain any large quantity of the material suitably prepared for instant use. If care were taken to remedy this unpleasant (because unthrifty) order of things, and were the people thoroughly informed as to the efficiency and economic value of the material sought to be disposed of, instead of finding the yards of gas works encumbered with huge coke piles, as unfortunately is often now the case, the time would speedily arrive when the supply would be unequal to the demand. It is therefore in the line of advance that this defect be remedied—prepare your coke, let the people know you have done so, instruct them as to its use, and there can be but one result. A pleasant one certainly to yourselves, as it hardly needs be said that increased residual receipts are in every way satisfactory to the company you represent.

Yet another thing bearing upon the coke question, and to which I may be forgiven for referring. The question has often been raised at the meetings of our various gas associations—it is simple enough in itself, but it nevertheless has appeared with disheartening regularity—and that is, "What quantity of coke is produced from a ton (2,240 lbs.) of coal?" Now, although a very simple thing, this is a matter of great importance to every gas manager, and in more ways than one. This mooted point should be settled definitely, and it might be borne in mind that mere guess work will not do; but if a permanent basis is to be arrived at, careful investigation and faithfully continued experiment must constitute the groundwork in order that the matter may be settled absolutely. The quantity and quality of coke produced from a ton of coal is a most important factor in determining the value of a coal as a material for carbonization. From a long continued series of experiments which the writer is conversant with it was found that the coke product of several well-known American coals was as follows:

Kanawha cannel, 32 bushels; best qualities West Virginia, 36; West-

moreland (Pa.) County coal, 42 bushels—bear in mind all results given are based upon a ton of 2,240 pounds. From these figures it will be recognized that much of the confusion attaching to the coke discussions in the associations, as reported from yields obtained in different plants, arose from the fact that the stated product was obtained from coals having widely differing characteristics.

To carry out this question of coke product a little more fully, let us assume that the mixture being carbonized at a stated time is composed of 90 per cent. of the Westmoreland County coal and 10 per cent. of cannel. At this proportion we shall obtain the following result from the mixture :

Coke product from 10 per cent. of cannel	3.2 bushels.
“ “ “ 90 “ Westmoreland.....	37.8 “
Or a total of	41.0 bushels.

With this mixture—

Coke product from 10 per cent. cannel.....	3.2 bushels.
“ “ “ 90 “ West Virginia	32.4 “
Or a total of	35.6 bushels.

Assuming that for carbonizing and all other fuel purposes about the works 33 per cent. (or 11.6 bushels) is employed, then we would have left over for sale, with the first mixture, 29 bushels; with the second, 24 bushels. From these simple figures it will become evident how important an item, in determining the value of a coal proposed to be introduced into a gas works, is the factor of its coke producing capacity. To resolve this question, as above illustrated, into the matter of dollars and cents :

The cost of coal in case of first mixture, at present prices, would be—

10 per cent. of cannel, at \$9.50 per ton	\$0.95
90 per cent. of Westmoreland, at \$4.35 per ton	3.91½

Or one ton of the mixture.....	\$4.86½
Deduct 29 bushels coke, at 7 cents	2.03

\$2.83½

In the case of second mixture—

10 per cent. cannel, at \$9.50 per ton	\$0.95
90 per cent. West Virginia, at \$4.25 per ton	3.82½

Or one ton of the mixture	\$4.77½
Deduct 24 bushels coke, at 7 cents	1.68

\$3.09½

Then we see that the difference in cost of the two mixtures (for the coal alone) is shown to be 26 cents per ton in favor of the first. To arrive at precise accuracy as to the relative value of coals as gas producers, it will of course be necessary to take into critical account any increased yield, candle power, and cost of purification of one mixture over the other. But it is in such plain, matter of fact ways that a gas works manager may determine what is the most profitable description of coal to carbonize, and also enable him to estimate accurately the price he should pay for any sort of coal intended by him for mixing purposes. This latter he can accomplish by taking the price at which a standard coal is rated in the market, and making the equation from the cost and value of that in comparison with the value of the sort he may make trial of. There is in the long run no doubt that the best coal obtainable will ultimately prove the cheapest; and although some other grades may be offered at what at first seem much lower rates than those asked for the standard quality, it is just as well to place yourself in that position where you may know to a certainty whether the figure demanded for the poorer sort is one that will be for the interest of your company to purchase it at all. This plan is the much better and safer one to pursue.

Another matter which has demanded, and is now demanding, serious consideration is the piratical raiding made on gas investments all over the country. It is a sorry state of things to make confession of, that, despite our proud boast that we are a people guided in all affairs by a love of fairness and honesty, this wretched system of blackmailing seems to grow and flourish upon the foulness which it breeds. Judging from our past experience of these nefarious schemes, their promoters may be depended on to continue in their depredations until legal methods are devised for the proper protection of moneys honestly invested in gas plants. It goes without saying that such protection should be granted, and it is also certain that these measures will never become inscribed on our statute books until a unification of interest on the part of those holding gas securities shall have been arrived at. This amalgamation of interests must certainly in time become imposing enough to make the law framers feel its weight, and might be trusted eventually to compel the propagation of laws having for their object the protection alike of gas shareholder and gas consumer.

The apparent ease and facility with which these raiders obtain the privilege of entering into a city or town, by the specious (but how often exploded) pretence of their desire to organize and operate a gas company solely for the

public good, is rather astounding. One should suppose that this sort of sirenical operation would have long ceased to have any potency for the public ear; but the fact that the threadbare chord may still possess enchanting timbre only goes to show how gullible is that collective body known as the “dear public,” and how willing it is to dance, even though it may afterward be rather disquieted when the account of the piper is handed in for settlement. The complete fallacy of the opposition pledge has been shown time over and again in the past, and this state of the case proves of necessity how like unto those of the past will be the promises of the future.

Suppose we take, as our first example, a case right near at home, to show how opposition benefits (?) the gas consumer. We find in New York city eight gas companies engaged in supplying the inhabitants of the Metropolis with artificial light. Can it be questioned for a moment that all the gas required for their wants could have been made and supplied at cheaper rates than now charged if the three original companies had been left in undisputed possession of the field? The excess of capital represented by the at least five surplus concerns has been such as to effectually bar cheap gas in New York. This is plain to anyone of ordinary intelligence through the consolidation measures recently enacted and cemented in this city, whereby one vast corporation has been formed by the union of the old companies, with an aggregate capitalization of, in round numbers, about \$39,000,000; whereas, had the three pioneer companies been properly protected in their just and equitable rights, even should consolidation at any time have been effected by them, the joint capitalization, allowing the outside figures, need not have exceeded \$20,000,000. Despite this plainest of evidence, the “dear people” are still so blind (it may be, though, that their representatives are venal) that since the consolidation spoken of a new company has been granted a charter to operate a plant within certain limits of the city.

In Chicago, Ill., an old established company with possession of all the capital necessary to operate a works in that city, and equipped with every appliance requisite to the conditions of cheapening manufacture and selling at low rates, has been hounded by the gentry in opposition; and so well did the promoters of the scheme “feather their nests,” that possibly a few particulars regarding their Lake City operations may serve to illustrate (if not to adorn) the example.

The opposition company was capitalized in the total sum of \$5,000,000, divided into three-fifths stock and two-fifths bonds—these latter bearing 6 per cent. interest. The entire expenditure on plant and appurtenances did not cost the promoters a greater sum than one-half the bonded debt. Who got the balance? And what did those who got it do with it? Certainly the gentlemen who divided up the stock were in position to have accurate knowledge as to the likelihood and ability of the company earning a dividend on such highly diluted financial standing; therefore, knowing all these things, what is more likely than that they should let some of the unwary and confiding people in on the “ground floor?” Alas, it is to be feared that those who were admitted so near to the surface have since found out the trap-door that led into a sub-cellar. Money cannot be honestly made in such schemes; but money can be made by “going in” for the fleece of the warmly-clad lambs—innocent, confiding creatures they are; and how they do merit our sympathy when the motives that enticed them into the arms of the shearer are laid bare. Still, the little game is constantly repeated; they are gathered on the river bank, the shears are applied, their warm coating is ravished from them, and then are they ruthlessly cast out into a temperature financially below zero. Stranger still, though, hardly has the kink in their coats been restored in due process of time before they once more get “in on the ground floor.”

At one time, in the city of Baltimore, Md., gas companies multiplied with such rapidity that their increase somewhat resembled a financial problem almost akin to the provision of nature in the matter of the fecundity of cats and rabbits; and some were disconcerted to that degree they almost feared the city's limits would be scarce large enough to contain the plants sought to be erected within them. These timorous ones have had their fears allayed, at least for a time, since a halt has been called and a union of forces effected. But at what cost has the result been attained? The figures tell the story. What with stocks and bonds, the amount foots up to the neat sum of \$12,000,000. Those conversant with the population and lighting demands at the present time in the Monumental City know full well that a capital load of three millions would be more than ample for its every need, so far as the gas maker's industry is concerned. Cheap gas is simply an impossibility in the future history of Baltimore.

Coming back once more to the region of home, look over across the narrow limits of the East River, and behold the situation in Brooklyn, N. Y. A single glance is enough; and to you who are so thoroughly conversant with all the nauseating details of the “gas deals” there made in the last ten years a recount of the particulars is unnecessary. The case in the City of Churches is a most aggravated one, and has been peculiarly disastrous to many small investors who in good faith put their scanty store of savings into gas stocks. It has also been equally disastrous in its results to the gas

consumer. Just think of it; many a consumer is obliged to pay \$2.50 a thousand cubic feet for his supply, and all because of opposition.

Example after example might be cited, but enough has been said in support of the proposition that it certainly is high time concerted action should be taken to put an end to this disgracefully prevalent system of extortion and robbery.

Reverting once more to the doings of the Society, by way of conclusion I can refer with much pleasure to our sessions during 1884. The interest in our meetings has been well maintained by the members, and the papers presented, together with the discussions on same, have not only been interesting, but really valuable as well, in that some of them have made clear to us certain points in the practice of our mutual profession. I need not exhort you to keep up the good work—the record of our past is the surest indication of our zeal for the future.

It has been our misfortune during the past year to lose by the grim hand of death an honored member, and our late Vice-President, Mr. Charles Vandervoort Smith. To you who have been intimately associated with him, not only in this Society, but also in connection with matters allied to our business, as also in the friendliest of social relations, words of eulogy regarding his character and manly qualities are entirely unnecessary. He was a man who, with an opinion once formed on any topic, ever remained steadfast to his convictions; but these convictions, when analyzed, were sure to be found the result of a careful investigation into the merits of any subject brought to his notice. Gentlemanly and kind in all his dealings with those with whom he was brought in immediate contact; genial, frank and earnest in his intercourse with us, his memory will be treasured up in fond remembrance by those who knew him well and loved him most.

The Society has been particularly unfortunate in the frequent gaps made in its ranks by the grim harvester. The first to join the silent majority was Mr. Geo. W. Edge, followed at all too brief intervals by Mr. Geo. Dwight, Major G. Warren Dresser, and Mr. C. Vandervoort Smith. Noble Romans were they all—men who, during their stay amongst the living, devoted the fullest measure of their rare talents and abilities to the development and progression of our mutual calling; and who for sterling character and true worth were ever recognized in the foremost rank. But if the chilling hand of death has removed them from us in the person, the fleshless monarch is powerless to destroy the example they afforded us in their upright careers, which remain to us as powerful incentives for the faithful performance of our whole duty in whatever position has been assigned us.

[From Journal of the Society of Arts.]

On the Use of Coal Gas.

By HAROLD DIXON, M. A.

[The following article is the first of a series of three lectures delivered by the author before the Society of Arts (London, England), on the above named topic. This series is the first of the regular course of Cantor Lectures annually presented to the Society, and the succeeding portions of Mr. Dixon's discourse, "On the Use of Coal Gas," will be given in the JOURNAL. The lecture herewith reproduced was delivered on the evening of Monday, Dec. 1, 1884.]

Coal gas is a mixture of invisible gases which are produced by the destructive distillation of coal. To-night I do not intend to say anything about the processes employed in the manufacture of coal gas or the methods used for its purification. I am going to speak to you about the physical properties of the gas as it is delivered to us from the gas mains—to consider what kind of a body this coal gas is, what are the products of its combustion, and the methods in which it may be burnt.

First of all we may take, as it is the most striking physical property, its inflammability. When a heated body is brought into coal gas escaping into the air, it ignites and burns with a flame sometimes luminous, sometimes non-luminous, according as it is mixed or unmixed with air. In the case of gas escaping directly into air from a pipe we have a luminous flame; where the gas first mixes itself with air we get a non-luminous flame, and of these non-luminous flames there are several kinds, from an explosion, on the one hand, when a very rapid inflammation of the mixture of the gas and air passes through the whole mass of it, to the gas and air burning quietly, on the other hand, as I have here in this Bunsen burner. Let me show you first of all a few experiments on the inflammability of coal gas. If we take an ordinary bit of wood and light it, and in a short time blow it out, so that we have a glowing red end, and bring it into escaping coal gas, we find that it does not light it; bring something hotter—a poker at a fairly bright red heat—and this also fails to ignite it. I will compare it with a jet of hydrogen; the difference between them is fairly well marked. The poker is visibly red-hot, but it fails to ignite a jet of coal gas, whereas it ignites a jet of hydrogen gas. Coal gas is ignited only at a very bright red heat; a poker has, for instance, to be a bright red, visibly red in daylight, in order to ig-

nite coal gas; hydrogen is ignited at a slightly lower temperature. Coal gas contains about half its volume of hydrogen, but, curiously enough, it is not ignited at the same temperature that hydrogen is ignited at. The other large constituent of coal gas, viz., marsh gas, ignites at a still higher temperature. Davy, who experimented first on the ignition points of gases, says that an iron bar must be at a white sparkling heat in order to ignite marsh gas. Now hydrogen, we have seen, ignites readily enough with a red-hot poker; coal gas is not ignited with a poker that is visibly red-hot; it will, however, ignite when the poker is at a cherry-red heat.

The constituent of coal gas next in bulk is carbonic oxide. That ignites almost at the same temperature as hydrogen; it is very difficult to detect the difference between the two igniting points. But there is one constituent of coal gas present in a very small quantity, viz., bisulphide of carbon, which ignites at a very low temperature.

If we take a little liquid bisulphide of carbon and pour it into a glass vessel so that it will mix with air, we find that this mixture of air and carbon bisulphide vapor is exceedingly inflammable. I will warm up this glass rod and you see it ignites the vapor readily. The temperature of the ignition of carbon bisulphide vapor and air is about 300° Fahr. Now it might be supposed that the presence of a minute trace of the vapor of carbon bisulphide would confer its inflammability on coal gas. If we mix a little of this vapor with hydrogen, or with carbonic oxide, we find that it does confer its inflammability on those gases; but if we mix it with another constituent of coal gas, viz., olefiant gas, we do not find the inflammability of carbon bisulphide given to the mixture. The presence of olefiant gas destroys the low igniting point of a mixture containing carbon bisulphide. This is curious, but I know no explanation of the fact. It was, I believe, originally discovered by Dr. Frankland, who experimented with these various mixtures, and found that a mixture of olefiant gas with carbon bisulphide ignited at no lower temperature than olefiant gas itself.

Now, marsh gas is the constituent of coal gas which ignites at the highest point; then comes olefiant gas, then hydrogen, then carbonic oxide, and then this carbon bisulphide; but the coal gas itself ignites at about a mean temperature—that is to say, at a cherry red heat. Now I will show you another experiment on the ignition point of coal gas. We may cool gas down until we put it out. There is for every gaseous mixture a certain temperature at which it will burn, and below which it will go out; and if we place in the flame a mesh of iron or copper wire so as to conduct the heat away from the gaseous molecules, we may cool the flame down below its ignition point. Let me take a large mesh and put it down over the flame; the flame passes through it; there are not enough pieces of wire to conduct the heat away and bring it down below the ignition point. If we take a mesh a little smaller and bring this down on the gas flame, we find the gas put out; the coal gas passes readily through the mesh, as we see by its igniting when the mesh is red-hot. Taking a still smaller mesh, we find the flame is put out completely—that is to say, this mesh of iron wire conducts away the heat of the gas and brings it down below its ignition point. On this principle safety lamps are constructed; and I will say just one word about them. Safety lamps have been made for use in coal mines, where the gas which is met with is marsh gas. I believe that no free hydrogen, and no free olefiant gas is found in coal mines; it is all marsh gas. Now, marsh gas has this exceedingly high ignition point, and therefore, a safety lamp which is quite safe in a mine with a mixture of air and marsh gas, is not safe in a mixture of coal gas and air. To insure safety in a mixture of coal gas and air one must make the mesh of the lamp still smaller than is used in mines.

Now, the next property of the gas, one which follows from this, is the fact that it burns with a flame in air. This burning with a flame is entirely a relative phenomenon. The molecules of the coal gas, viz., the hydrogen, the carbonic oxide, and the hydrocarbons unite chemically with one of the constituents of the air, viz., oxygen, and in this chemical union the vibrations are produced which give us the sensation of light. Whenever we have two gases uniting chemically together at a high temperature we have this phenomenon of flame, but on no other conditions. A solid body burning in a gas does not give a flame, only one gas uniting at a high temperature, or burning with another. Now, if we lived in an atmosphere of coal gas, it would follow that coal gas would not be a combustible substance, but the air would be, and oxygen in a still higher degree. Flame occurs at the bounding surface between two gases entering into chemical combination one with the other. I can show you an experiment where a flame of air may be seen burning in coal gas, as well as a flame of coal gas burning in air. In this little apparatus on the table there are two tubes entering through the cork at the lower end, one of them broader than the other; one to admit air, and the other coal gas. I will connect one of these tubes to the gas supply so as to let coal gas enter into it and fill the glass globe. We have now an atmosphere of coal gas there, but since there will be an upward current it will draw some of the air into the globe through the other tube. This jet of air is now lighted, and on lowering the lights of the room you

will be able to see, especially when the moisture which is first of all precipitated on the sides of this globe has disappeared, that the air is burning in the atmosphere of coal gas. To make it a little brighter, I will push up a platinum wire with a borax bead at the end so as to color the flame. That it is really air burning in coal gas I can make plain by lighting the excess of coal gas which is now pouring out at the top of the globe. There you see coal gas at the top burning in air, and underneath the air burning in the coal gas. I have to stop the supply of air to put the flame out, otherwise there would be an explosive mixture formed and an explosion inside.

Before I pass on to treat in more detail of the chemical constituents of coal gas, I will try one or two more experiments on its physical properties. Let us consider now its specific gravity. An easy way to show that is to blow a soap bubble with it. With the pressure of coal gas we have here we can blow a bubble, and if I am skilful enough to detach it you will see it rise, showing how much lighter it is than air. [On rising a short distance the soap bubbles were ignited by a taper.]

Now, of the constituents of coal gas, hydrogen is by far the lightest; next to it comes marsh gas, after that carbonic oxide. The other constituents are comparatively heavy. One of the properties of a light gas is its power of passing rapidly through a porous substance, such as plaster of Paris, or compressed graphite. The explanation of this, on the dynamical theory of gases, is, as you know, that the gases are composed of a number of small molecules dashing about in straight lines, and coming into collision one with the other and with the sides of the containing vessel; and where there are minute interstices in the walls of the vessel the molecules pass through these interstices, and we find an exchange of the gases outside such vessel with the gases inside. Now consider, first of all, for the sake of simplicity, the case of two gases well known—oxygen and hydrogen. If we had a porous vessel with hydrogen inside, and oxygen outside, we should find that the hydrogen penetrated through the interstices of the vessel four times as fast as the oxygen went the other way. On the dynamical theory of gas this is explained in the following way: Hydrogen gas is made up of a vast number of small molecules of hydrogen, and oxygen gas is made up of a vast number of small molecules of oxygen; and the hydrogen molecules are traveling four times as fast as the molecules of oxygen. So that, taking any given portion of the surface of the vessel, and considering what number of collisions there will be between the hydrogen and the oxygen molecules respectively and this surface, we see that if there are the same number of molecules in the two gases, and the hydrogen molecules are traveling four times as fast as the oxygen molecules, the hydrogen molecules will come into collision with this surface four times as often as the oxygen. Now if there are a certain number of interstices in this surface through which these gases can pass, the quantity of hydrogen which will go through will be four times the quantity of the oxygen which will go through in the same time. That is the explanation of the phenomenon of diffusion on the dynamical theory of gases. Let me show you a few experiments in which this diffusive power of coal gas, and especially of the hydrogen and marsh gas contained in it, comes into play. The gases pass through the walls of a porous vessel, and decrease or increase the pressure within the vessel according as more gas comes from the inside to the outside, or from the outside to the inside. This vessel is made of one of those porous pots used in a Bunsen cell; I have closed it with a paraffin cork, through which I have passed a long glass tube. I dip this open end in a colored liquid. Now as it stands here in the air this vessel is full of air, and it is surrounded with air outside, the two being of the same density; so that the same number of molecules of air are passing out from the inside of the vessel into the atmosphere of this room as are passing from the atmosphere of the room into the inside of the vessel. The pressure, therefore, inside remains constant, and if we put any colored liquid into the tube it remains perfectly stationary. But if we plunge the vessel into a lighter gas, such as coal gas, on the theory we have been considering, this coal gas, or some of its constituents, will pass more readily through from the outside to the inside than the air which is now inside will come out, consequently there will be an increase of the quantity of the gas inside, the pressure will be raised, and we shall find bubbles of gas escaping from the end of the tube. I can put this into an atmosphere of coal gas by placing this glass jar over it, and, by means of an india rubber pipe, letting some gas into it. Bubbles of gas are now pouring out from the end of the tube, and I stop the supply of gas. Now what will happen? There is a certain amount of coal gas gone in, and it has driven an equal volume of the air out. If I take the glass jar away we now substitute the air for the coal gas outside, and you see the liquid rush up the tube, showing a diminution of pressure. If I put the glass vessel containing the coal gas back again over the porous vessel the pressure is increased, and the liquid is driven down again. You see, corresponding with the nature of the atmosphere outside, you have the variation of pressure inside accurately marked by the rise and fall of a column of colored liquid in the tube connected with the porous vessel.

Now, an instrument could easily be made—I think a French engineer has made such an instrument—by which the presence of coal gas would be de-

tected in a room. I know such an instrument has been used in mines to detect the presence of marsh gas. If instead of colored water in this tube we had mercury it would not run up so far, but it would run up several inches, and if we went into an atmosphere of marsh gas with this porous vessel filled with air, the marsh gas would enter more quickly than the air would pass out. The pressure inside would increase, and consequently the mercury would be down. Now it would be easy to cause the mercury to make metallic contact with a wire, and so connect a battery with a bell. Taking such an instrument as this into a mine, if there were a certain percentage of marsh gas present it would increase the pressure inside sufficiently to drive the mercury down until metallic contact was made, and then a bell would be rung. Exactly the same thing would do for coal gas. If one wanted to know whether coal gas was escaping anywhere, one might have such an instrument as this connected with a tube of mercury, two electric wires, and a Leclanché cell, and the wires might be carried to an office at any distance and connected with a bell. Then whenever coal gas escaped into the atmosphere where this porous vessel was, the pressure would increase inside, electric communication would be made, the bell would be rung, and you might go and find out where the escape was. I merely suggest that as a method which would be easily applicable for discovering at a distance whether there was an escape of coal gas.

One effect of this rapid diffusion of the very light hydrogen and marsh gas in coal gas is this, that these light gases mix themselves rapidly with air and form an explosive mixture with it. It is the presence of hydrogen in coal gas that makes it dangerous. Owing to its lightness hydrogen siphons itself upward through a bent tube. Here is a little apparatus to illustrate this siphoning of the hydrogen, and also the rapid diffusion of hydrogen with air, in order to form an explosive mixture. The same experiment may be made with coal gas, but it takes a longer time. The apparatus consists of a cylinder hanging by an upright, inverted and closed at the lower end by a piece of paper stretched round it by an india rubber ring. Passing through a hole in the paper there is a U tube with its shorter arm at the upper part of the cylinder. The longer arm is outside the cylinder; to it I can attach a tube from a hydrogen apparatus. By turning on the tap I can pour hydrogen into the cylinder. Hydrogen, being lighter than air, will displace the air at the top of the cylinder, and drive it out at the bottom; but it will not only do that, it will also diffuse with the air. I will, first of all, pass hydrogen in until I judge the cylinder is pretty well filled, then I will take off the tube here and allow the hydrogen in the cylinder to siphon itself up the longer arm of the U tube. Then as the hydrogen siphons itself up some air will be drawn in at the bottom, and owing to its rapid diffusive property the hydrogen will mix itself with the air, and we shall get an explosive mixture inside the vessel. The flame at the top here will begin to jerk, and perhaps to sing, and then it will run down and fire the explosive mixture. We must allow it a few minutes to fill before it would be safe to light. I now light the hydrogen at the end of the U tube. There is the hydrogen burning and siphoning itself up. Now it is beginning to sing, and the explosion follows.

I will now show an experiment on the power of platinum to light a mixture of coal gas and air by allowing a slow combination to take place between the hydrogen and oxygen of the air. Owing to this chemical combination the platinum increases in temperature until it reaches the ignition point of the gas. I warm up this little spiral of platinum, then take it out of the flame and allow it to cool, and put it in an unlighted jet of gas; it becomes hot, glows, and finally lights the gas. That is one way in which I have attempted to determine the different ignition points of these gases. It is not a very accurate way, but still it gives some approximation towards the truth. The platinum has to attain to a bright red heat before the coal gas ignites.

I will now go on to consider in more detail the various constituents of coal gas. I have written on the blackboard approximately the composition of ordinary coal gas. The hydrogen varies between 40 and 50 per cent., sometimes a little over 50 per cent.; but in no analysis I have ever seen or made have I found over 51 per cent. We may take it roughly that the hydrogen is 50 per cent. of the coal gas. Marsh gas varies between 35 and 42 per cent. I have taken it at 40 per cent. Carbonic oxide varies from 6 to 8 per cent.; and the most important of all, ethylene, and the other hydrocarbons of the same chemical type as ethylene, which may be classed together as olefines, occupy $3\frac{1}{2}$ volumes of the 100. In the next column I have put the volume of oxygen required to burn each of these constituents of coal gas. The 50 per cent. of hydrogen requires 25 per cent. of oxygen. The marsh gas requires double its volume of oxygen; the carbonic oxide requires half its volume; the olefines require about six times their volume of oxygen to burn them. In the next column are arranged the volumes of steam produced by the burning of these various constituents: 50 per cent. of hydrogen requires 25 per cent. of oxygen to burn it to 50 per cent. of steam. In the last column is put the volume of carbonic acid produced by the burning of these various constituents. Hydrogen gives no carbonic acid, for it contains no carbon; marsh gas produces double its volume of steam, and its own vol-

ume of carbonic acid ; carbonic oxide, no steam, and its own volume of carbonic acid ; and the olefines form about 20 volumes of steam and 14 volumes of carbonic acid.

With the properties of hydrogen most of us are familiar. It burns readily in oxygen, and explodes if mixed with half its volume of oxygen. It burns in air with a non-luminous flame. I can attach to this Kipp's apparatus a lamp in which the hydrogen may pass directly up to this steatite burner, and there we can light it. I have put into the body of the lamp some liquid olefines to show the influence of these hydrocarbons on the flame. You see the hydrogen gives barely any light at all ; but by mixing it with a slight trace of the vapor of the hydrocarbons belonging to this olefiant series, we immediately get a brilliant flame.

I have prepared samples of these various constituents of coal gas. All of them are invisible. Here is oxygen, carbonic oxide, marsh gas, and ethylene. I will show you as quickly as I can one or two experiments with these gases. First of all, the union of hydrogen and oxygen to form water. By means of this pneumatic trough I pass a little of the hydrogen into a glass explosion tube, so as to fill it roughly two-thirds full ; then mixing oxygen with it, I ignite it. You see the flame gives scarcely any light, but there is a loud report, owing to the sudden production of a volume of steam at a very high temperature. I will not take up your time by showing the explosion of all these gases, but I will light one or two of them in the air. Here is some marsh gas. After the first moment the flame becomes blue and almost non-luminous. The other constituent of coal gas—viz., carbonic oxide, of which there is 6 to 8 per cent.—burns with a characteristic blue flame, with the oxygen of the air to form its own volume of carbonic acid. This is a bottle containing ethylene. I will fill a small jar with the gas, so that the air can get at it rather better than it can in this bottle with the narrow neck. Under the water of the pneumatic trough one can easily transfer the gas from one bottle to the other. This ethylene has an exceedingly luminous flame when one burns it in this way in the air, but it always smokes ; and an illuminating gas made with a very large percentage of ethylene would smoke unless it were burned with certain precautions.

If we ignite a mixture of coal gas and air, we find that if the mixture is made in the right proportion we get an explosion. If the mixture is made in other proportions, with either more or less air than a certain quantity, it will not explode. The limits of explosion are from $3\frac{1}{2}$ to $9\frac{1}{2}$ volumes of air for every volume of coal gas. Of course coal gas differs a little in its qualities, and so the limits cannot be exactly defined ; but those are about the limits. If you mix four volumes of air with one volume of coal gas, a flame will be propagated through it ; and if you mix nine volumes of air with one of coal gas, a flame will be propagated through it. I will try one or two experiments of this nature, mixing a certain volume of air with a certain volume of coal gas. First, I will take the lesser quantity of air. I have filled this glass cylinder with air, about two-thirds full, and I will now fill it up with coal gas. We shall find we are just on the limit of an explosion. We may be just on one side or the other ; I cannot tell. I plunge a lighted taper in suddenly ; the mixture burnt, but there was no explosion down the tube—it simply burnt where the air got access to it ; so that three volumes of air to one of this gas is not explosive. I will now go to the other extreme, and take nine or ten volumes of air to one of coal gas. This is just within the limit ; there is a slight explosion, but hardly any noise. I will now repeat the experiment, taking one volume of coal gas to five or six of air. Here we have a sudden inflammation of the mixture, accompanied by a report. No great noise is made when only a small volume of coal gas and air is exploded in this way, and I think it is for this reason: The flame has to travel a considerable way down the cylinder or tube containing an explosive mixture of coal gas and air before what is known as the explosive wave is propagated ; and as this is a matter of very great importance, I should like to say a few words upon it.

Until four years ago the rate at which a mixture of oxygen and hydrogen was supposed to burn down a tube filled with it was 34 meters, or 37 yards, a second. This was the determination of Professor Bunsen, of Heidelberg. The rate at which flame traveled down a tube filled with carbonic oxide and oxygen was found by Bunsen to be only a little over one yard a second. The investigations of M. Mallard brought out this conclusion in the case of coal gas and air: The maximum velocity of explosion was obtained when one volume of coal gas was mixed with five of air ; and that velocity was about three feet a second, or about the same pace as the velocity of explosion of carbonic oxide and oxygen. Berthelot was the first who showed that these rates of explosion were enormously underrated. About the same time, but shortly afterward, I was experimenting on the explosion of gases, and a question arose as to the effect of a small quantity of a particular gas on the explosion of two others. To determine that, I thought it would be a good plan to measure the velocity of the explosion of these gases with different quantities of the third. I arranged an apparatus to measure this explosion ; but I found the rate of explosion was infinitely greater than I had the means of measuring. Whereas I was thinking to measure a velocity of three or four

yards a second, the explosion that happened in my tube certainly went hundreds of yards a second ; and I was totally unable to measure it. I saw, at all events, that the explosion was vastly quicker than was supposed.

Shortly after I did that work I came across Berthelot's paper, which was just published. He found that hydrogen and oxygen exploded at the rate of more than 1,000 meters a second. I determined to repeat these experiments, and put up a very delicate apparatus for the purpose. I am happy to say that my results came out exceedingly concordant with the later results of Berthelot. I used a tube 200 feet long, and near each end of the tube stretched a narrow strip of silver foil, which formed part of an electric circuit. When they were broken by the passage of the flame, a current passing through two electro-magnets was interrupted, causing the release of two styles, which made their mark on a moving plate. M. Berthelot employed pieces of tin foil, and placed in them a grain of fulminate ; so that when the flame passed by the fulminate exploded and destroyed the tin foil. I did not introduce this extra explosive, but trusted to that which the explosion was perfectly capable of doing—the immediate destruction of the silver foil by the passage of the flame.

I found as the mean of my results that a mixture of oxygen and hydrogen in a pure state, two volumes of hydrogen to one of oxygen, exploded at the rate of 2,817 meters a second—over 3,000 yards ; this number being the mean of six experiments. The mean of Berthelot's experiments is 2,810. This is a very close concordance, and I think will be regarded by chemists as satisfactory, showing that the velocity has been measured within a very small fraction of the truth. When you light a mixture of hydrogen and oxygen in the eudiometer, the explosion does not acquire this pace at once, but the gases begin burning slowly, and they gather pace as they go along ; for each layer is compressed by the burning layer above it, and each layer burns at a higher and higher pressure, until finally such a pressure is reached that the layer submitted to it is brought up to the ignition point by the heat produced by its compression. The layer below that is also brought up to the ignition point in a similar manner by compression ; and thus a constant rate of ignition is maintained. In the case of hydrogen and oxygen the explosion has only to go a few inches in order to establish this constant "explosive wave."

In the case of carbonic oxide and oxygen, Berthelot found as the mean of his experiments a rate of about 1,000 meters ; but I found a rate of over 1,500 meters. I discovered that the space given to this mixture by Berthelot to acquire its final velocity was not sufficient ; carbonic oxide and oxygen require nearly a yard before they acquire this maximum rate. I have not yet ascertained the explosion rate of marsh gas, as I have only made one experiment on it ; but it is something over 2,000 meters a second.

Now these velocities are very considerably diminished when we burn the gases in air instead of oxygen. The nitrogen of the air interferes with the action, because it itself has to be heated up to a high temperature, and, therefore, prevents the other gases reaching such a high temperature as they otherwise would. Therefore the velocity of explosion of coal gas in air is very considerably less than the velocity of the explosion of coal gas in oxygen. I do not know the velocity with sufficient accuracy to give you a number to-night ; but it is very considerably greater than that which has been assigned to it.

I can show you an experiment with coal gas and oxygen to compare with the one you saw just now with a mixture of coal gas and air. You saw then that at the extreme limits the mixture just burnt, but there was no noise ; at the maximum explosiveness the flame traversed the vessel very quickly, and there was a sharp whistling sound. Here is a little of the same coal gas mixed with oxygen. The loud report which follows the application of a light to this mixture marks the great difference between the burning of coal gas and oxygen and the burning of coal gas and air.

Now, the products of combustion of coal gas—leaving out for a moment the carbon bisulphide—are steam and carbonic acid. The steam is poured out into the atmosphere and mixes with it. If there is an excess of it, and the room is small, there is condensation of the steam on the sides of the room ; but in an ordinary room, with ordinary ventilation, you do not have condensation of steam. In the carbonic acid you have a gas which is poured out into the room, mixes with the air, and is carried away in the ordinary processes of ventilation. Steam is considerably lighter than air—roughly speaking, half as light. Carbonic acid is heavier than air. I can easily show you some of the properties of carbonic acid. It is most readily prepared by taking some powdered chalk and pouring on to it some acid, which liberates the carbonic acid. We can easily fill up a beaker with the gas. We find that when we bring a taper into it the light is immediately extinguished. Carbonic acid being heavier than air, I can dip up some of it with a cup, and pour it into another vessel. It pours rather slowly, as it is not much heavier than air. If I have poured any into this vessel I shall have it down at the bottom, and will let a light down and see. You see the jar is two-thirds full, and extinguishes the light at once. Carbonic acid, then, is an invisible, colorless gas, heavier than air. One can take it up in a cup, pour it from one

vessel to another, and it extinguishes a taper. I dip out some of this gas, pour it into a cylinder, and shake it up with lime water; immediately we get a milkiness due to the formation of carbonate of lime, from the union of the transparent lime water with carbonic acid gas. If we place a large vessel over a gas flame we are able in this way to get some of the products of combustion. We can shake up the contents of the vessel with lime water in the way I did just now, and we get the same milkiness as I got before when I mixed the carbonic acid with it. The carbon of the gas unites with the oxygen of the air to form this same gas, carbonic acid. The two products of combustion of coal gas—steam and carbonic acid—are both gases. Steam is a condensable gas, but carbonic acid is not at ordinary temperatures.

Just a word about this other constituent of coal gas and its product of combustion. Carbon bisulphide exists in very small quantity in coal gas, and is due to the sulphur in coal. We cannot get coal without some sulphur in it, and in the distillation of the coal, part of the sulphur of the coal unites with the carbon to form this volatile carbon bisulphide, which mixes with the other gases. Most of the sulphur in coal unites with hydrogen, forming sulphuretted hydrogen; but there is no difficulty in stopping the sulphuretted hydrogen in the purifiers. The carbon bisulphide, however, is more difficult to stop—part of it always comes over; and I believe at present, in London gas, there are about 12 grains of sulphur as carbon bisulphide in 100 cubic feet of coal gas. This carbon bisulphide, when the coal gas is burnt, burns to sulphurous acid; that sulphurous acid somewhat resembling carbonic acid in its chemical properties. It mixes with the air, but under some circumstances it is capable of oxidation to sulphuric acid, and sulphuric acid is injurious to various things which we have in our rooms.

Now, there has been a good deal of dispute as to the nature of the change by which the sulphurous acid coming from a gas flame is changed into sulphuric acid. It has been asserted on the one hand that sulphurous acid, in the presence of steam and the oxygen of the air, is readily converted into sulphuric acid; that you have formed in the atmosphere of a gas-lighted room a cloud of sulphuric acid particles, which are then deposited upon all substances in the room. But, on the other hand, it has been asserted that this could not be the case, for sulphuric acid is only found deposited on hygroscopic substances, and not on all substances in the room indiscriminately. The latter is, I think, the correct view. I think so for this reason: If sulphurous acid and oxygen are brought together and warmed up, they do not unite; they do not unite at the temperature of boiling water. If sulphurous acid and steam—not water, but steam—are brought together, they do not unite. They do not form a molecule of hydrogen sulphite, but they continue to exist as separate gases. Again, if sulphurous acid, steam, and oxygen are brought together and warmed up, so long as the steam remains in a gaseous state the sulphurous acid does not suffer the slightest trace of oxidation. I have experimented on this matter carefully. I have mixed these gases in a eudiometer, having measured them before mixture, and I have kept them in the eudiometer at temperatures varying between 0° and 100°, and so long as no water was condensed on the side of the eudiometer there was no trace of sulphuric acid produced. So that the sulphurous acid coming from the burning of coal gas in the air does not suffer what has been called aerial oxidation by steam and oxygen. It is only when that sulphurous acid meets with water—that is to say, damp surfaces—that it suffers oxidation.

Now what happens in a room lighted with coal gas containing sulphurous impurities? If there are hygroscopic substances in the room, if there are damp walls, if there are basins of water about, if there are certain things very like dry leather, which readily take up water, the water will dissolve the sulphurous acid and form hydrogen sulphite. Now, hydrogen sulphite in a liquid state—that body which we may represent by H_2SO_3 —very readily suffers oxidation; so that you find, if you put a basin of water in a room lighted with a sulphur-laden gas, you get the water gradually converted into hydrogen sulphate. Metal-work close over a gas burner condenses steam for a short time after the gas is lighted. The trace of sulphurous acid dissolved by this water is oxidized to sulphuric acid. Every time the burner is lighted the process is repeated; so that, in the course of time, a considerable quantity of sulphuric acid is formed on the metal. If you examine the bindings of books which have been placed up near the ceiling, and have got rotten through heat, you find sulphuric acid there. But I do not think for a moment that sulphurous acid was the cause of the rotting of the book binding; I think the rotting was caused by heat; that the bindings, having rotted, then became hygroscopic and condensed water; that the water dissolved the sulphurous acid, which then was readily oxidized to sulphuric acid. I know people say that on entering a gas lighted room where there is a large percentage of sulphur they can smell sulphurous acid; and I do not doubt that for a moment—I believe they can. But I call their attention to this fact, that the quantity of carbon bisulphide in the gas is only a mere trace, and that the quantity of oxygen required to burn coal gas is more than coal gas itself; roughly speaking, 100 volumes of coal gas require 130 volumes of oxygen. Then, since the oxygen is one-fifth of the atmosphere,

every 100 volumes of coal gas require 640 volumes of air; and, therefore, if you are burning coal gas in a room, and do not wish to be suffocated, you must allow this air to come into the room and the products of combustion to pass out. If you do that—if you supply for every 100 feet of the gas you burn the 640 necessary feet of air—then I say that that air in the room can never become saturated with aqueous vapor, and no sulphuric acid can be produced, except in the manner above described.

Gas Heat for Mechanical Purposes.

By T. J. C.

To the inhabitants of large manufacturing centers, who are perforce obliged to reside in districts whose air conditions are so decidedly the reverse of pleasant that they may with perfect truth and fitness be characterized as disgusting, because of their unwholesomeness and uncleanness, any positive advance in the application of firing principles to the mechanical arts, whereby the consumption of solid fuel will be sensibly lessened (and more especially when that solid fuel consists of bituminous coal), the substitution of the gas maker's product for that of the miners' contribution will indeed be in the nature of a most welcome boon. This congratulatory nature of things, however, is possibly more eagerly looked forward to in other countries than in our own, taking into due note the more or less great diffusion of anthracite coal veins throughout the States—but still the smoke evil grows apace with us; and soon with the thrifty Yankee, as now with his careful prototype in older lands, the question of economy in manufacturing operations must needs assume the nature of a most weighty, leading consideration. So it has come to pass that the cheaper bituminous product is outpacing its more valuable competitor, and without any attempt at exaggeration some of our towns are pretty nearly already in position to dispute the question of supremacy in the matter of sombre cloudiness with the honorably ancient "smoky hollows" of old England.

All this is of absorbing interest to the gas maker, and opens up a most attractive and lucrative field, replete with profit for inventive genius, which is now being quite actively explored. Already has great progress been made in the development of new uses to which gas may be applied in the harness of the industrial world, and the initial discoveries have been so varied and important as to render us measurably certain that such as have heretofore been reported and successfully employed may be accepted as but the indication of how great is to be the future extent of the gas man's domains.

Outside of the first really important impulse given to the employment of gas to other purposes than that of lighting, pure and simple—*i. e.*, in domestic operations and the furnishing of a reliable substitute for medium and small-sized motor powers—was the impetus afforded by the Smoke Abatement Exhibition held at South Kensington, London, England (formally opened on date of Nov. 30, 1881, closing on the date of Feb. 14, 1882), which was a most complete popular success. Indeed so thoroughly had the matter attracted the attention of the people that the London exhibition was virtually transferred to the manufacturing center of Manchester, in which city it secured a vast amount of public appreciation between the dates of March 17 and May 6th, 1882. The official data of the committees appointed to report on the various appliances exhibited on these occasions have since been published, and it is not necessary to the purport of this short note to make any particular mention of the findings of the various committees, except possibly in so far as they may refer to the exhibits of the Thompson Brothers (Leeds, England), who may truly be said to have been the overturners of long-established practice in the matter of staining, enamelling and annealing of glass; and again who have also initiated another system the principles of which are well calculated to exert just as great a revolution in the art of the gentlemen who out of their abundance are so favorably disposed towards their fellow man that they reckon thirteen as but a dozen—the bakers—as the gas kiln did in the case of the glass worker.

Taking first (although it is really not of so much importance to the American gas maker as is the baker's oven) the Thompson burning-in gas kiln as an evidence of advance in the application of gaseous fuel which has made considerable progress in America, the writer will endeavor to convey an idea of its advantages over the old style of working; but must of necessity furnish an imperfect description owing to the absence of drawings. Probably the best method under the present disadvantageous conditions of such illustration deficiency will be to employ an adaptation of the words of Messrs. Powell, Chance and Harris, conjoint compilers of a technological handbook entitled the "Principles of Glass Making," which are as follows:

"Thompson's patent gas kiln annealing oven is in every respect greatly to be preferred to the old-fashioned kilns previously described. The fuel employed is the ordinary lighting gas mixed with atmospheric air. Not only is the actual cost of burning, kiln for kiln reduced, but the saving of time is so considerable that a gas kiln can efficiently burn in two hours the same class

of work as by the old method would remain ten hours in the kiln. The pressure of the gas from supply main is controlled by proper apparatus. The gas passes to right and left of kiln through pipes suitably placed for proper disposition of fuel supply, and enters kiln through a series of jets piercing kiln sidewalls at center of oven; fourteen of the jets are provided for on each side wall, each jet having a separate tap, so that the gas supply to any particular part of kiln can be accurately regulated, and the heat be increased or diminished at any desired point at the pleasure of the operator. At the points where jets pierce the walls provision is made for the admixture of air with the gas before entering kiln. At top of kiln and running its entire top length is a flue connected with a chimney for creation of necessary air current, easily controlled by suitable dampers conveniently placed. The kiln is constructed of fire brick, and is bound together with angle-iron and tie-bolts. The front is fitted with cast iron doors opening outwards, and provided with spy-holes through which the progress of the burning can be observed. At bottom of kiln is laid a railway track on which is moved a cast iron carriage, that can be introduced or removed from kiln with perfect ease and freedom. The base of the carriage acts as the bed of the kiln, and on it are laid the different objects to be roasted or stained. This carriage base divides the kiln interior, and is lined with plaster so as to form a heat retaining bed for the glass material operated upon, and to protect the iron work of the carriage as well. It is usual to operate with duplicate carriages, so that one may be loaded ready to take its position in kiln when the other is withdrawn. The obvious advantage in glass staining by this method is that the work really becomes continuous, thus effecting a great saving in time, to say nothing at all about the wonderful economy in expense for fuel, absence of soot, clinkers, and other decidedly positive annoyances of the old *regime*. The authors above quoted give as their opinion that "the practical working of the Thompson kiln proves its economy, regularity and cleanliness."

The plan of the carriage is not a novel one, as many of the older coal or coke fired kilns were provided with such an arrangement, but these latter were very expensive affairs, the additional item of carriage cover (the goods when placed on carriage bed always had formerly to be encased completely) costing for an averaged sized kiln close on to \$400. The certainty with which the heat can be applied, together with the sureness of its after control, had much to do with the rapid success of the scheme in this country, where the matter of closeness in working economy is at present perhaps not so minutely inquired into as in England; although we may truthfully state that this last observation hardly applies to the case of the ordinary consumer of gas as an illuminating agent. This party is quite as precise in his scrutiny, and as profuse in his grumbling with us as is the case with our European brethren.

To show the speed and celerity of the Thompson system for burning-in stained glass, we are enabled to give the following particulars concerning some work recently done in England. A large manufacturing concern which had installed a Thompson kiln about four years ago (probably one of the first that had been built for practical working), received an order for a rather large lot of ornamental glass work intended for the decoration of a railway station hotel. The time allotted for the delivery of the work to the purchasers was quite limited, and its accomplishment in due season was somewhat doubted at first; but the attempt was made with the following results. The size of the kiln was 9 feet by 4 feet inside, consequently giving carriage surface for 36 square feet of space whereon to impose the material to be burned; this kiln was made to do active duty for three successive days on the order given by the hotel proprietors. The duty exacted and accomplished in the three days' working is annexed:

First day—9 kilns fired from 6 A.M. to 9 P.M., or 15 hours firing and cooling.
 Second day—8 " " 6 A.M. to 8 P.M., or 14 " " "
 Third day—10 " " 8 A.M. to 10 P.M., or 14 " " "

This result shows that one kiln, charged 27 times in a period of 43 hours, produced, as a completed and beautifully fired material, 972 square feet of glass, the duty being obtained with an aggregate gas consumption of 8,640 cubic feet, or an average per kiln charge of 320 cubic feet. It might also be added that not a single piece of the glass treated was either destroyed by breaking or impaired as to value by imperfect burning. The figures given (and they are from an unimpeachable source) amply demonstrate the certainty of operation of the Thompson method, at least when the practice of successive firing is followed. So great is this item that some firings in the above total of 27 were completed within the lapse of 30 minutes from the time the laden carriage was entered until it was withdrawn.

Another important consideration in regard to this firing plan is the almost entire absence of expense in keeping the kiln in order. As before noted, the kiln whose rapidity of operation is reported above was among the earliest of those constructed, and since its erection its owners have not had occasion to expend one cent upon it in the matter of repairs.

After thoroughly considering these things it can easily be understood why the seal of mechanical disfavor should have fallen upon the old-young method of fixing colors on stained glass by fire, and that operators in the industry

should bestow their favorable attention to the Thompson plan. Among those who are employing this system of firing in the United States the bare mention of these prominent names is sufficient evidence that the New York city artisan is thoroughly convinced of its utility and worth. The list includes Messrs. Louis Tiffany & Co., the La Farge Decorative Company, Herter Bros., Messrs. J. & R. Lamb, and also Mr. Le Prince and Mr. Giessler.

The concluding article will be devoted to the application of gaseous firing to bakers' ovens.

Coal Tar Colors.

Prof. Lewis M. Norton recently read before the Society of Arts of the Massachusetts Institute of Technology, a paper on the subject of "Coal Tar and the Colors Derived from It." We reprint the following synopsis:

Within the last fifteen years a complete revolution has been wrought in textile coloring, the effects of which are familiar to all of us in the brilliant fabrics in the stores, and the many delicately colored curtains, carpets and ornaments of our homes; and these changes have come, not so much from a change in style or taste, as from the introduction of the wonderful colors derived from coal tar, rendering possible a brilliancy and variety of tone in color not previously to be obtained. Under our protective tariff the most economical production in various manufactures has been seldom the aim; but under close competition the manufacturer is forced to pay more attention to the utilization of so-called waste products. Eighteen years ago coal tar not only possessed no value, but was a source of expense to companies engaged in the manufacture of illuminating gas; while to-day it possesses no inconsiderable market value, and, instead of adding to the cost of gas, it diminishes it. The value given to this waste product is the result, in a large degree, of work conducted in chemical laboratories, at first for purely scientific purposes.

Where coal tar is most perfectly utilized it is either subjected to distillation by the gas company, or sold by it to the coal tar distiller. Its composition is variable, but upon distillation it furnishes numerous valuable hydrocarbon oils, aromatic oxygen compounds, and solid hydrocarbons, and these products form the basis for the artificial color manufacture. The most valuable of these compounds obtained by distillation are benzole, toluol, naphthalene, and anthracene, hydrocarbons and carboic acid. One hundred pounds furnish about 1.5 pounds of benzole, and the other compounds in variable and somewhat larger quantities. Benzole is the starting point of the aniline color industry, and one pound of benzole represents about 2,200 pounds of coal, since it requires about 3,300 pounds of average English gas coal to furnish 100 pounds of tar. One pound of benzole will furnish about one pound one ounce of aniline red. After all the benzole and volatile products have been distilled from the coal tar, the residue, about fifty per cent. of the original quantity, is used for roofing, for concrete, and for so-called asphalt. The value of the residue is often much greater than that of the original tar.

In 1841 the chemist Zinin showed that aniline was a derivative of benzole; but it was some time after the first aniline colors were made that the chemical structure of benzole was understood. The theory, first advanced by Kekuli, in 1866, in regard to its construction, first made an intelligent manufacture of coal tar colors possible. Although this conception of Kekuli had reference simply to the internal structure of a molecule, and was purely a theoretical view, yet it has given an impulse that during the last twenty years has led to the establishment of immense factories, and given waste products every year a value of millions of dollars.

The first coal tar color brought upon the market was picric acid, introduced as a commercial product in 1855. A year later Perkin introduced a purple called mauveine, and from this dates the introduction of aniline colors. The fact that aniline yielded a highly-colored product of oxidation had been discovered by Runge in 1835, and the first suggestion of its commercial utilization was probably made by him. Following the introduction of mauveine came fuchsine, and in 1860 aniline blue first came upon the market; in 1862 the Nicholson blues and the aldehyde green. Aniline yellow and Hoffman's violet followed in 1863. With the year 1866, however, began the true development of the industry, and since that time almost every year has seen new shades introduced, which, on account of greater cheapness, have replaced those that preceded them.

While the investigation and discovery of these wonderful products have busied the organic laboratories of France, England, Switzerland and Germany, yet to the patient work of the Germans is due by far the greater part of the credit for the establishment of this industry. As offshoots from the laboratories of the universities and technical schools of Germany, are to be considered the manufactories of aniline colors to be found on such a grand scale in that country. There are about thirty-five color factories in Germany, nine in France, three in Belgium, seven in Switzerland, and eight in England. In many of these only one or two colors are made, and nearly

every one has its speciality. One factory in Germany employs 2,200 persons. Closely related to the aniline color industry stands the manufacture of artificial alizarine, also a derivative of coal tar. A good instance of the effect of one industry upon another is the fact that the low price of sugar to-day—due to the large production of beet sugar in Europe—is owing to the introduction of artificial alizarine. The large areas now devoted to the cultivation of the beet were fifteen years ago devoted to the raising of madder, from which alizarine is obtained in small quantities. But the discovery, in 1869, that alizarine could be cheaply obtained from the anthracene of coal tar was the death-blow of the madder industry. The total annual product of aniline colors in the world has at present a value of about \$25,000,000, and that of alizarine about half as much; while the total value of coal tar products of all kinds cannot fall far short of \$45,000,000 per annum. The main use of all this color, of course, is to color silk, wool and cotton, either in a fabric or before weaving; it is also used for letter paper, inks, etc. Silk fiber is easily colored, requiring no mordant. The color forms a chemical compound with the fiber, and cannot be removed by washing, but is slowly decomposed by light. Some of the aniline colors combine with the woolen fiber in the same way, but the colors are generally not so fast as upon silk; they are also slowly acted upon by light. It is but fair to say, however, that the colors made by anilines on wool or silk resist the light fully as well as those obtained by older methods of dyeing, while the shades far exceed them in magnificence. The coloring of vegetable fibers with aniline is far more difficult. Cotton fiber shows no inclination to form a compound with the dye, and a mordant must be used, the one most universally used being tannin. Many of the colors thus fastened upon cotton show remarkable fastness, both toward light and soap. Anilines fastened on cotton fiber with other mordants are exceedingly fugitive. Almost equal in importance with the textile uses is the use of aniline colors in printing; the great beauty of our modern prints is due to their use, together with alizarine.

In America we have two factories where aniline itself is made, and some others that import a partially manufactured product, and finish the making of the colors. There are three establishments of considerable size in the State of New York, and some other scattered aniline red plants. The main product of these is aniline red, of which enough is made in this country to supply the demand. Besides this, aniline blue for letter paper is made here, but about all the other shades are imported. Imported colors have cost our manufacturers, alizarine included, \$5,000,000 per annum. The export of any colored fabric from this country, in which the cost of coloring is a considerable item, is rendered difficult, to say the least. Often coal tar is distilled here, the benzole exported and distilled abroad into aniline salts, which are brought back to this country.

It is only by a thorough development of the color industry among us that our manufacturers of colored textiles can hope to compete for the markets of the world. England already appreciates the mistake she made in allowing Germany to lead in this industry.

Oil and Gas Wells of Pennsylvania.

Mr. T. J. Ricarde Seaver has prepared the following interesting notes on these topics, contributing the same to *Engineering*:

It may interest your readers to have a few facts from this part of the world on the recent important oil discoveries in Butler County, where recently the most prolific oil well in the world began to "gush" at the rate of 150 barrels, or over 6,000 gallons per hour. This and the practical application of natural gas as fuel to the iron and other industries of Pennsylvania, form the almost exclusively engrossing topics of the day in Pittsburg and Oil City. I lately spent a week in visiting many large works and natural gas wells at the close of my long vacation trip to America, and it was my good fortune to wind up a most interesting stay there with a visit to what our American friends term "the biggest gusher in the world."

The fortunate owners of this monster well are the Messrs. Phillips Bros., who bid fair to become millionaires. Their "find" is situated about 2½ miles from Bald Ridge Station, on the Western and Pittsburg Railway, about 35 miles from the latter city. Although Butler County has been producing the best quality of oil hitherto obtained in America, the quantity was nothing remarkable until last month, when the No. 1 well struck the "sand" at 1,650 feet, and 30 feet deeper began to flow at the rate of 120 barrels an hour. This, at that time, was the largest yield ever obtained, and it continues to flow now at about 60 barrels an hour. The No. 2 was well advanced into the sand on October 21st, and at 7 p.m., on that day, at a depth of 1,678 feet, it began to flow so violently that the preparations made for the reception of the oil were with difficulty made to suffice. Within 24 hours 6,000 barrels=252,000 gallons, flowed into the tanks, and was sent on its way to the refinery through the main pipe line to Cleveland, Ohio, 170 miles distant. Two other wells have been drilled into the sand at nearly the same depth, and within a few hundred yards distance, are producing from 100 to 115 barrels per hour each.

These large figures must naturally affect the market, and when the district was first opened up the price fell from 93 cents a barrel to 59½, but is now up to 74 cents (=3s. for 42 gallons). This is, of course, the crude petroleum, and does not include transport, which may be set down at 20 cents a barrel to Cleveland or Lake Erie, and 50 cents to the Atlantic seaboard. The transport is done by a company called the United Pipe Lines, who have enormous storage tanks and pumping stations scattered throughout the oil districts, whence main lines are laid to Cleveland on the one side, and New York and Philadelphia on the other. The total distance covered by their system of pipes must be little short of 1,000 miles, and the total storage capacity over 42,000,000 of barrels, or nearly 1,000 millions of gallons. Their pumping stations are from 15 to 25 miles apart, according to the configuration of the country through which the lines pass. The system of the Pipe Line Company is commercially something like banking; they open an account for each customer, and credit him with the oil delivered to their stations, and debit him with the quantities sold and delivered through their refineries, minus the cost of transport and a small commission.

Through the courtesy of Mr. Vandergrift and Mr. J. J. Buchanan, of Pittsburg, I am enabled to give you an idea of the strata through which the drilling has been done in Butler County. The following is a copy of the foreman drillers' log, taking the sea level as the datum line:

	Thickness of Strata in feet.	Total Depth.	Distance from Datum.
Well mouth above ocean in feet.....	—	—	1,436
Conductor.....	—	9	1,427
Slate, alternating with sand shells, bluish.....	133	142	1,294
Sandstone, dark grey.....	24	166	1,270
Slate and shales.....	6	172	1,264
<i>Coal.</i>			
Coal.....	1	173	1,263
Slate and shale, dark grey.....	49	222	1,214
<i>Limestone.</i>			
Limestone.....	—	222	1,214
Slate, dark grey.....	34	256	1,180
Sandstone, grey.....	16	272	1,164
Slate, shale, and sandy shells, dark.....	125	397	1,039
<i>Ferrif. Limestone.</i>			
Slate and sand shells, with some iron pyrites and coal.....	32	449	987
Sandstone, top white, bottom black, "60-ft. rock".....	43	492	944
Slate and shale, bluish grey, black at bottom.....	45	537	899
Sandstone, greyish white, "20-ft. rock".....	18	555	881
Slate and shale shelly, dark.....	52	607	829
Sandstone:			
White, "30-ft. rock".....	Mountain sandstone.	183	790
Grey, "20-ft. rock".....			
White and soft, "50 ft. rock".....			
" close, "40-ft. "			
" soft, "43-ft. "			
Slate, shale, and sand shells.....	145	935	501
Sandstone, hard and white.....	5	940	494
Slate, clean bluish grey.....	30	970	466
Sandstone, shaly grey.....	20	990	446
Shale, slaty bluish grey, with a gas vein at 1,190 ft. in a thin shell of fine bluish sandstone.....	260	1,250	186
Shale, sandy, with a few yellow pebbles, bluish.....	52	1,302	134
Slate, shaly, purplish.....	34	1,336	100
<i>Second Sand.</i>			
Sandstone, pebbly, 3 ft.....	}	36	1,372
" grey, 9 ft.....			
" slaty mixture, 12 ft.....			
" grey and fine, 12 ft.....			
Slate and shale, dark.....	38	1,410	26
Sandstone, uniform, hard white, "50-ft. rock".....	22	1,432	4
Slate, blue.....	28	1,460	24
Sandstone, homogeneous, fine white (30-ft. rock).....	42	1,502	66
Slate, shelly blue.....	8	1,510	74
Sandstone, yellowish grey, fine "boulder".....	14	1,524	88
Slate, blue.....	6	1,530	94
Sandstone, grey ("stray 3d").....	16	1,546	110

Third Sand.

Pebbly sandstone.....	} 20	1,566	130
Sandstone, white.....			
" grey and hard.....			
Slate, shaly dark blue.....	40	1,606	170

Fourth Sand.

Sandstone, dark "clover seed pebble".....	} 25	1,631	195
" fine white.....			
" good white pebble.....			

Oil.

NOTES.—Drilled dry; cased at 643 ft.; very little salt water below casing; gas at 1,190 ft., half sufficient to fire boiler with while drilling, but gave out in three or four days; about same amount of gas was found in 2d sand; very little oil in 3d sand; the hole filled up with oil to 300 ft. or 400 ft. from top of 4th sand, and flowed when drilled a few feet deeper. No red rock found in drilling; best daily production forty barrels.

The cost of drilling a well differs according to the manner in which it is contracted for. If the driller has to find all tools and deliver the well flowing, he gets about 3 dols. = 12s. a foot, and the maximum depth yet reached has been 2,200 feet without finding oil. If, on the other hand, the tools and materials are found for the drillers, it may be done for about half, or 6s. a foot.

Previous to the discovery of such abundant oil wells in Butler County, the great excitement around Pittsburg was (and indeed still is) the boring for "gas wells." The importance attached to these may be gathered from the fact that owing to the recent introduction of natural gas for the boilers and bloom heating furnaces at Carnegie Works, at Bessemer, over 250 men stokers and helpers have been discharged, and the change is so marked by the absence of smoke and incumbrance by coal, etc., and so appreciated by the managers, that it has been decided to apply it to all their furnaces where heretofore coal had been used. Its adoption at these works did not appear to me to be so economically carried out as at others I visited in the city of Pittsburg itself. At Bessemer the pressure was 60 lbs. to the square inch at the nozzles where the gas is introduced under the boilers, and 2 lbs. only at the heating furnaces. This difference is no doubt due to the fact that at the latter there are regenerative chambers on the Siemens principle, and these had previously existed. But at the boilers the old fire grates, pure and simple, were left, and the gas jets introduced through the old fire doors, with cold air. The gas enters through a ¼ inch aperture, and the pipe is surrounded by a 3 inch tuyere perforated at the sides, through which a current of air passes by natural draught and mixes with the gas in the proportion of about 15 of the former to 1 of the latter.

At two other works I saw a more economical application of natural gas as steam fuel. The pressure indicated by the mercury gauge was not over 6 oz., and the result even more satisfactory than at Bessemer. The gas was led to the front of the boiler in a 3-inch pipe (from a 6-inch main), and from this four ¼-inch pipes were taken at right angles and introduced under the old fire grate level, where the gas mingled with highly heated air derived from a series of flues heated by the waste. This heated air was only allowed to mingle with the gas at the proper point for ignition, and in the proportion suitable for complete combustion.

I also saw it applied to glass melting furnaces and others with the most satisfactory results. The prices charged for the gas, which is a light carbonated hydrogen, or marsh gas, is 30 cents, or 1s. 3d. per 1,000 cubic feet; and at this rate I was assured a very great economy over coal would be realized. It is now brought to the city by pipes 8-in. and 6-in. in diameter, of wrought iron, ¼-in. thick, lap-welded with screw joints; the thread is slightly beveled, and the pipes are tested up to 500 lbs. bursting pressure. These are laid about 3 ft. deep in the streets, and some extend from a distance of 18 miles. The pressure at the wells varies from 210 lbs. to 100 lbs. to the square inch, and it is calculated that a loss of 4 lbs. per mile is due to friction.

Within a short time it is expected that this gas will be exclusively used as fuel in the great majority of works in and around Pittsburg, and, to a great extent, for domestic heating, so soon as the municipal authorities shall have authorized its introduction to the heart of the city, under such restrictions and regulations as to pressure and distribution as will guarantee the public against accident. The pipes are being laid down all over the place, and the utmost activity reigns amongst the rival companies who have secured rights; and more important still, a good supply from their wells. For domestic uses it is proposed to charge 5s. per 1,000 cubic feet, 20 per cent. dearer than ordinary illuminating gas, but the caloric power of the well gas is far more intense. For illuminating purposes it is not suitable in its natural condition, but by passing it through heavy hydrocarbon oils (such as heavy petroleum) in a very fine state of division, to avoid clogging up the pipes, it would be superior in candle power to the ordinary coal gas.

Although the question of utilizing natural gas as fuel can have but a meagre interest for our English manufacturers, it may become of the

highest importance to some Continental countries. In Asiatic Russia the supply is practically inexhaustible. The "eternal fires" of Baku on the Caspian may soon be devoted to the more useful and practical purposes of iron and steel manufacture than that which for centuries and ages they have served—as emblems of worship for Oriental fanatics. In Transylvania and in Italy it is found in considerable abundance. Still nearer home, in France, near Grenoble, I am credibly informed a most important well exists, which, according to well-authenticated records, has been flaming since the time of Julius Caesar. This is well known as the "*Fontaine Ardente*" of the Gauls, and it is only within the last few months that an able French engineer, who had previously visited America, has commenced works there with the object of utilizing the gas for industrial purposes. He was drilling on the spot when I left Europe last September, and I presume ere this will have augmented the supply, and probably have discovered either coal or petroleum, or perhaps both, to reward him for his spirit of enterprise and conviction.

As regards its qualities as a fuel for open-hearth steel making, I can scarcely give you a better proof of its excellence than the fact that at Pittsburg a well-known maker has been using it for some time with this result—that, notwithstanding it costs him 4s. 7½d. to produce with natural gas that which he formerly did with other fuel at an expenditure of only 2s., he declares the product to be so superior in quality as to warrant his continuing and adapting his entire plant permanently to the use of this fuel.

At Bradford, Franklin, and Oil City the use of natural gas has now become almost exclusive, and the only thing left to be desired and hoped for is that the supply may never grow less.

Condensing Sulphuric Acid Gas.

An English contemporary notes that an ingenious, though somewhat complicated, apparatus for the condensation of sulphuric acid gas has been introduced at Roszdin, in Silesia, and found to work very satisfactorily. The sulphurous gases from the calcining furnaces are taken to a lead-lined tower packed with coke, flints, or any other suitable material in the usual manner, down which water trickles from a cistern on top of the tower; the water absorbs the sulphurous acid gas, and also the sulphuric acid and soluble sulphates that may be carried over from the calciner. It then flows out of the bottom of the tower, and is taken through a lead pipe to a series of closed shallow lead pans, a dozen in number, arranged one above the other in a fire brick chamber, through which pass the hot gases from the calciners on their way to the condensing tower. The lead pans communicate with each other by lead pipes, placed in diagonally opposite corners, and arranged so that the liquor is taken out from the top of each pan, and flows into the bottom of the pan below it. The hot gases passing around and between the pans cause the liquor to leave the lowest pan at considerable heat. This hot liquor then rises through another lead pipe to the top of a smaller tower, of cylindrical shape, and lined with lead, in the center of which revolves a shaft covered with lead, and having several discs of lead attached to it. These discs, revolving on the shaft, alternate with fixed ledges or shelves on the sides of the tower, and as the liquor flows down in a cascade over these ledges and discs it is broken up into very fine spray. At the same time a current of hot air is passing up the tower, and takes up and carries away the sulphurous acid gas that is liberated from the hot spray. It is drawn off from the top of the tower and led away to a sulphuric acid chamber, or other point at which it may be desired to further operate with the sulphurous acid. The hot liquors that have thus been freed from the sulphurous acid taken up in the condensation tower flow into a long closed cistern of lead, through which pass a large number of lead tubes arranged like a surface condenser. The air that is to pass into the spray tower is first forced through these tubes, which are surrounded by the hot liquor, and is in this way warmed. The apparatus is so made that the pipes expose sufficient surface to completely cool down the liquor, which then leaves the cistern and is pumped up to the top of the condensation tower to again absorb sulphurous acid, etc., and perform the same round. The warm air from the lead tubes is taken through heaters, which are exposed to the hot gases coming from the calciners, and, being thus made quite hot, passes into the spray tower as described. By continually circulating in this manner, the liquor finally takes up a considerable amount of sulphuric acid and soluble sulphates, and when sufficiently concentrated a portion is drawn off and evaporated down in lead pans, a corresponding quantity of fresh water being added in the condensation tower.

ITEMS OF INTEREST FROM VARIOUS LOCALITIES.

YONKERS (N. Y.) GAS LIGHT COMPANY REDUCES PRICE OF GAS.—Mr. James D. McIntyre, Secretary of the Yonkers Gas Light Company, forwards us the news, under January 7, that his company has had, despite the adverse circumstances attending the year's working, enough of prosperity to enable it to declare a semi-annual dividend of 3 per cent. on the capital stock, made payable on and after date of February 1. The managers of the corporation have also seen fit to make a decided reduction in the price of gas to consumers, the reduction to take effect on consumption registered on and

after January 1, 1885. The new schedule is as follows: To those using less than 10,000 cubic feet per month, \$1.50 per thousand; upward of that quantity, a further deduction of 10 cents per thousand will be allowed.

Gas affairs at Yonkers have been in a pretty badly mixed condition for the period of almost ten years; and all because of the readiness with which opposition charters were granted. The place is undoubtedly a thriving, flourishing one, and besides possessing quite an extensive collection of briskly active manufacturing establishments, is fast becoming peopled with a thoroughly substantial class of business men, representing the best grades of the merchant and professional orders of New York city, who find it at once pleasant and economical to locate their homes in the handsome town on the east bank of the Hudson, rather than at a lavish outlay be obliged to coop their families up in the narrow limits of the average Metropolitan homestead. But aside from this aspect of the growth of Yonkers the multiplication of gas companies there has quite decidedly outpaced the gas consuming needs of the people; and in this particular it is but like unto many of its neighbors. A correspondent, who is thoroughly conversant in the history of the Yonkers opposition, has most kindly furnished us with some interesting details regarding the same; and our informant's knowledge of the case is contained in the following:

"The Yonkers Gas Light Company has had to contend with the raiders for about ten years past, and the old corporation is intimately conversant with their peculiar methods. The first attack came with the appearance of the Westchester Gas Light Company, the operators of which, after having sunk a sum amounting to \$185,000, made a proposition to sell out to the old company, naming as an appropriate figure for the transfer the item of \$50,000. This proposition was refused; but the managers of the Yonkers Company did enter into negotiations which resulted in a settlement, for the time being, of active hostilities. The basis of the truce was a division of district, with ceding of mains on both sides, the Yonkers Company to make all the gas for the territory, supplying the Westchester holders with whatever quantity of gas was demanded on account of its consumption, and to charge a stipulated price (a very low one it was) for such supply, etc. This arrangement worked very well for the space of a year, when the spirit of peace was rudely disturbed by the advent of opposition No. 2, yecept the Municipal. The Westchester branch of the year-old combination became alarmed to such a degree that its presiding genius urged that the Yonkers Company head off the opposition by purchasing and employing the Lowe water gas system. This the latter refused to consent to; and the Westchester parties put in the water gas plant, and determined to operate once more on their own account. They seized hold of the mains as originally put down by them and began to supply gas indiscriminately. When the Westchester company went outside of the stipulated boundary the old company took possession of the mains ceded by them at time of truce agreement; and the joke of the thing was that the best portion of the Westchester's consumption happened to be along these particular conduits. With recovering the particular lines of pipes, as a necessity the consumers were gotten hold of also; and the Westchester Company, failing to appreciate the humor of the situation, entered suit against the Yonkers, claiming damages in the sum of \$100,000. The suit was decided adversely to complainants, and it cost them some \$1,700 before they were well clear of their ill-advised law proceedings. After that fiasco the whole matter settled down into the nature of a pretty triangular contest, and the imbroglio, after the lapse of five or six years, still keeps on. Its progress puts me in mind of the articles published in the JOURNAL during the month of January, 1884, descriptive of the old-time Loudon gas competition period; but of course the Yonkers matter but bears the same ratio to the Loudon period only as the flame of a tallow-dip compares with one of the new high-power burners.

"The companies are not slow at canvassing for consumers, and the consequence is that the householders are constantly altering their allegiance by continual change in the bestowal of their favors, now going to one company and then to a rival; the streets are torn up in all directions; the leakages of gas may be noted in abundance, and the public can get no remedy from the stench—it is a fact that many houses and stores are rendered almost uninhabitable from this circumstance—since each company claims, when appealed to, that the leak emanates not from its conduits, and consequently refuses to make search for the seat of the trouble. So it goes; continually going on from bad to worse. During the early period of the struggle there was apparently a sort of tacit understanding that a schedule of prices varying, according to consumption quantities, between \$1.25 and \$2 per thousand would be adhered to. In the latter end of December the old company ascertained that although the two other competitors were charging their own customers \$2, they were slyly trying to take customers away from the former by offering to supply them at \$1.50. This knowledge precipitated open warfare, the Yonkers Company advertised a general rate of \$1.50, and the newer concerns came down to \$1.25, which are the present (Jan. 7) ruling rates. Neither branch of the opposition ever paid a dividend, although the Yonkers Company manages to make a pretty regular return to its shareholders. The

Westchester is now run by a Receiver, and is engaged in defending a suit brought by Mr. W. Astor to recover \$50,000 and interest, now pending decision in Court of Appeals, the lower courts having decided adversely to defendants' standing in the case. How or when the fight will terminate no one can tell; but in the meantime the consumers are getting supplied with good gas at a low figure; still they will require a great expenditure of pity for their future plight if consolidation takes place. They may have the doubtful pleasure of paying good interest on three sets of capital."

AN INTERESTING NOTE FROM EAST CHESTER COMPANY, OF MT. VERNON, N. Y.—Mr. Charles Nettleton, whose valuable services to the fraternity of this country are so generally recognized and remembered in connection with his performance of the duties of the Secretaryship of the American Gas Light Association when that organization was not in the flourishing condition now so happily and completely attained by it, is still the guiding spirit in charge of affairs of the East Chester Gas Light Company, and, as its President, is thoroughly alive to the importance of keeping its helm in the right direction. The gentleman has empowered us to state that selling rates have been reduced in accordance with the annexed schedule, to take effect from first day of March next:

	New Rate.	Old Rate.
A monthly consumption of over 500 cubic feet...	\$2.00	\$2.50
A " " below 500 " " ...	3.00	3.50

This virtually amounts to an all-round price of \$2 per thousand, and is a very low figure when due note is made of the situation. Mr. Nettleton has determined to make considerable extension to the producing capacity of the East Chester plant, and the alterations and additions, among other items, include the erection of four benches of sixes, which are to be fired under the improved Stedman principle. The total expenditure necessary to complete the proposed changes will be between thirty and thirty-five thousand dollars. Brother Nettleton means to "keep the rascals out."

ANOTHER VICTIM.—It is a pity that when the "deal" was fixed up in Baltimore, Md., some sort of a provident fund was not arranged for looking to the suitable burial of those victims who are reported to have "blown out the gas" manufactured and sold there. A despatch received from that city, on date of Jan. 8th, says: "Wm. Bergman went to his home at a late hour last night, and when retiring blew out the gas. He was found dead in bed to-day" Following out the fund idea mentioned above, perhaps a fund has existence for the purchase of suitable tombstones wherewith to decorate the resting-place of the "blown-out" dead, in order that Baltimore, at least as to its graveyards, may rightfully retain the tall title of the "Monumental City."

COKE FUEL CONSUMPTION AND RAILROADS.—It is asserted that the Pennsylvania Railroad Company's engineers are devoting some attention to the value of crushed coke as a fuel. The experiments at present are being confined to steam raising in yard locomotives; but it is the ultimate purpose to employ it in the furnaces of passenger and freight engines of the road should the preliminary trials warrant the step. Our present information is that the project is likely to prove successful.

A NOVEL WAY OF CATCHING A THIEF.—A leading druggist's publication of this city says that on a recent feast day at Cotopaxi, Mexico, the leader of a band of thieves in that section concocted a scheme for a large haul of plunder by extinguishing the electric light in the cathedral. He used a small wire which, in his ignorance, he threw over the exposed wires carrying the electric lighting current, and the same, passing through his body, killed him instantly. His confederates were appalled at the sudden death of their leader and fled, escaping capture.

CHEAPER GAS FOR TOPEKA, KANSAS.—Mr. J. T. Clark, Secretary of the Excelsior Coke and Gas Company, of Topeka, forwards us the information that on November 1st, 1884, his board of directors determined to make a reduction in selling rates in continuation of the policy that has always marked the management of the company. The prices ruling since November 1st are as follows:

A monthly consumption of 8,000 cubic feet and over,	\$2.50 per 1,000
" " below 8,000 " "	2.70 "

The new schedule is made operative only in regard to such accounts as are settled on or before the tenth day of each month. Consumers neglecting to settle within the prescribed time will be charged at the former rate of \$3.00 per thousand. The last reduction, if we remember rightly, is the fifth one granted since the Topeka works went into operation. The efficiency of the plant has been kept at a high standard by taking advantage of improved methods and machinery; indeed the Excelsior plant has, it might as well be claimed, been entirely rebuilt within the past two years. Messrs. Holliday and Clark justly pride themselves on the fact that the lowering of sell-

ing rates has always been made without solicitation on the part of the consumers, and in accordance with the idea that the inhabitants of a city are entitled to a good round percentage of the prosperity which their increase in numbers and wealth affords to a corporation operating amongst them. How much better and safer this course is to the stockholders of the Excelsior Company than if its managers, in the flood-tide of present success, were to call in the services of the financial watering-pot. This last is the sort of flood-tide proceeding that enables the wreckers oftentimes to "make a port." To the dismay of the privateering gentry, as they increase and multiply (some six or eight different "construction companies"—destruction would more truthfully define them—have been formed in the last quarter) in numbers, the eligible landing-places appear to "grow beautifully small and elegantly less." Low selling rates have blockaded the passages; and fair treatment of consumers operates as a dangerously destructive torpedo boat to securing free wind and fair sailing by the buccaneers carrying the opposition flag.

ELECTRIC LIGHT PLANT INJURED BY LIGHTNING STROKES AT HOUSTON, TEXAS.—A queer circumstance is reported from Houston, Texas, where the climatic conditions during the latter part of December and the early portion of present month were marked by the occurrence of unusual and wonderfully intense and protracted electric storms. Nature's dynamos seem to resent the appearance of the artificial ones in Houston, and it may be possibly accounted for on the score that this is but another feature of what may be accomplished through the agency of the "glorious climate" of the Lone Star State. The *Houston Chronicle*, of date Dec. 31, in detailing the storms, and referring particularly to one of night previous, said: "The lightning prostrated several electric light poles in the First, Fourth and Fifth wards, smashing lamps and globes. At the electric light works the lightning played havoc with the plant, burning three dynamos out in two nights. Two extra or reserve machines were also struck by lightning, putting out every are light in the city. As a consequence extra dynamos have been ordered from New York, to be shipped here by express; but as it will take at least three days before they can arrive, Houston's 'pale moons' will be temporarily eclipsed. The actual damage to the electric lighting apparatus will reach up into the hundreds, to say nothing of the loss occasioned by temporary interruption of service." With even Nature's most potent artillery directed against them, and taking into account the present attitude of Houston's City Council with reference to the lighting contract, the lot of the Houston Electric Lighting Company appears to be a most unhappy one.

A TRIFLING DIFFERENCE IN THE FIGURES.—We all know that the promises of the electric lighting promoters require to be "taken" with a grain of salt—not meaning that the chloride of sodium grain is necessary to keep the promises in a state of freedom from decay (for there is a certain everlasting freshness about their pledges warranted to keep them clear of the corroding influence of the combined ravages of atmospheric effect and lapse of season), but rather that the pledges may be the more easily assimilated. A certain Mr. Curtis, representing the Thompson-Houston Electric Light Company, of Boston, Mass., has been trying to convince the Common Council of Poughkeepsie, N. Y., that are lighting would be a "good thing" for the taxpayers of that city, and so he has been offering the City Fathers an "option" on the purchase of sufficient plant wherewith to do the requisite lighting of the city's streets. Mr. Curtis does not appear particularly anxious to erect a plant on his own or his company's account, and perhaps this plan has been found a little too unlike a "good thing." However, in his proposal to the Council, Mr. Curtis submitted a detailed statement as to what outlay would be required on the part of the municipality to establish an electric lighting system that might be counted on as equal to street lighting needs there. He figured it out an investment of \$30,300 (mind the delicate preciseness of the "\$300") would equip a "six-mile-of-wire" plant and furnish everything requisite for the running of 100 lamps. Mr. A. L. Allen, of the Citizens' Gas Company, could not bring himself into that requisite digestive condition in which any amount of salt would enable him to complete the process of deglutition. The Citizens' Company does the street lighting in the city, and up to Dec. 31 we believe it had 623 street lamps to supply, on a total main length of 23.5 miles, and the price received therefor for the twelvemonth was \$19,932. Mr. Allen accordingly went into a calculation as to what amount of money would be really necessary so that the municipality might be placed in thorough position to operate an electric plant that would take the place of the present gas street lighting system. Taking as the basis of his calculation the figures furnished by Mr. Curtis, Mr. Allen was not long in piling up a needed first investment of \$100,000; and he did not exaggerate the case in a single instance. At 6 per cent. per annum here would be a charge of \$6,000 to start with, or about 31 per cent. of the total sum paid to Citizens' Company for doing the street lighting in 1884. No doubt if Mr. Curtis got the job through he would obtain a "good" commission on the transaction, the Boston Electric Company would have a "good" profit on

the first "lot" of plant agreed to be delivered, and have a right "good thing" in prospect resembling future orders for a "goodly" quantity of additional electric "goods" needed by Poughkeepsie to make the "outlying" streets leading off from Main street share in the "arc" illumination. We hardly think Mr. Curtis' figures are sufficiently voluminous to convince even a Poughkeepsie Councilman that they are hardly "good" enough to hold water.

AN EXPLOSION AT THE AUGUSTA (GA.) GAS WORKS.—Brother George S. Hookey, Manager of the Augusta (Ga.) Gas Works, has been "enjoying" a shake up; but the "Crackers" never attach much importance to a shake up, and certainly old Philadelphians (particularly the celebrated members of the heroic band of "Snappers") will be ever ready to give Geo. S. the credit of always being in the front rank when a shaking up was in process. Still, the rumpus that occurred at Augusta, on Monday, Dec. 29, cannot have been to his liking; and indeed it was fortunate that the matter turned out no worse than the record shows. At about 8 o'clock on the morning noted some workmen were engaged in connecting the inlet pipe of a recently completed gasholder (capacity 130,000 cubic feet) to outlet from station meter. Something or another displaced the bladder cap, and, quicker almost than it takes to narrate it, an explosion occurred that tumbled down the upper story of the meter house, and made a sad wreck of the meter. The two workmen on the job were more or less injured, but neither fatally. Steps were immediately taken to shut off the flow to the wrecked building, and there was no stoppage of supply to consumers. The damage amounted to about \$5,000. To show what a narrow escape "Snapper" George had, it is only just necessary to mention that not five minutes before the explosion occurred he left his office (in second story of meter house) to visit another part of the works. We had almost forgotten to state that a gentleman named Pendleton, one of the contractors doing the holder work, received a severe shock during the outbreak, but luckily escaped fatal wounds. It may be news to the Southern fraternity that the Hon. George T. Barnes was recently elected to the Presidency of the Augusta Company.

PERSONAL.—Mr. Jas. G. Miller, of the Green Bay (Wis.) Gas Light Company, reports business as "booming" there. The gentleman has been connected with this company since his original construction of its plant in 1870, and for some time back has been in active charge of affairs.

ANOTHER MYSTERIOUS PILGRIMAGE CASE, WITH THE REASON THEREFOR.—Littleton's example probably led Ramsdell astray, and Ramsdell's "Eastern" journey last June has had a demoralizing effect upon Ben. Perkins, of South Bend, Ind. It was rumored of late that Ben. had a wonderfully large number of "pressing" business engagements at Indianapolis (who doubts the pressing urgency of them now?) But it is rather strange he should say Indianapolis when he meant to utter Columbus. Preoccupation is undoubtedly thus betrayed; yet Ben. knows best, and we all know now why his objective point was the latter place rather than the former. We are sorry to unmask his deceit (or rather his preoccupation), and make plain to the brethren of the Hoosier State why it was thus. On the evening of Friday, Dec. 26, the culprit led to the foot of Hymen's altar a most willing captive in the charming person of Miss Ida Adams, a popular belle in social circles of Columbus, Ind. The Rev. G. J. S. Browne completed the sacrifice by joining the twain together according to prescribed form; and the gallant Ben. has since been heard to say that not a gas man in the West was half so well treated by old "St. Nick's" disposition of Christmas favors for 1884 than was his honorable self. No more than his usual luck, and may it follow him and his other half.

THE GATE CITY GAS COMPANY INCREASES THE ATLANTA (GA.) DEATH ROLL.—A guest at Mercer's European Hotel, at Atlanta (Ga.), lost his life through being suffocated by the inhalation of water gas on the night of Dec. 25th. When body of deceased was discovered it was noticed that the burner cock had been partially turned off, and from that circumstance it is conjectured the victim was in the habit of sleeping in a partly illuminated apartment. Water gas, on account of its great density, and its tendency to stratify under certain favoring conditions, makes a most dangerous sort of unattended night-light. Name of deceased is reported as "Brantley;" and he was not known as a resident of Atlanta. The case has attracted considerable attention there, as it naturally would when it is remembered that not a single fatal case of asphyxiation is chargeable to the old Atlanta Gas Company during its thirty years of distribution.

AN EXPLOSION OF GAS AT NORTH ADAMS, MASS.—A slight explosion of gas occurred in the town of North Adams on morning of Tuesday, Jan. 6th. A plumber hunting for an escape of gas with a lighted match was the cause of the trouble. For the first time on record in like cases we are happy to say that the only one injured was the plumber; but in accordance with history again, the only damage done unto him was the loss of a mustache! We hope he valued it highly.



A. M. CALLENDER & CO.,
PROPRIETORS.

Editor—JOS. R. THOMAS, C.E
Manager—C. E. SANDERSON.

PUBLISHED ON THE 2ND AND 16TH OF EACH MONTH
At No. 42 Pine Street, New York.

This is a recognized official organ of—
LIGHT, HEAT, STEAM, WATER-SUPPLY,
VENTILATION, SANITARY IMPROVEMENT,
AND GENERAL SCIENCE.

TERMS

SUBSCRIPTION—Three Dollars per annum, in advance.

AGENTS

NEW YORK—AMERICAN NEWS Co. 39 and 41 Chambers St.
BOSTON—S. M. PETTINGILL & Co., 6 State Street.
PHILADELPHIA—PRATT & Co., Corner 9th and Arch Streets.
England—C. W. HASTINGS, 22 Buckingham St., London, W. C.
Germany—B. WESTERMANN & Co., of New York

FRIDAY, JANUARY 16, 1885.

A New York Victim.

A man named A. P. Bloomfield lost his life on date Dec. 31st, '84, in Ashland House, New York city, through inhalation of illuminating gas. On retiring to bed he failed to note that the burner stopcock was loose, and in consequence unwittingly turned the current on after once putting out the flame. Bloomfield was formerly cashier of the aristocratic Knickerbocker Club, and latterly superintendent of the Pelham Club, whose race-course, etc., is located at Bartow-on-the-Sound. Life was not entirely extinct before discovery of his condition was made, but prompt medical aid failed to restore him.

This One a Suicide.

A German named Moritz Orbach committed suicide on night of Jan. 3d, in his apartments at No. 100 East Fourth street, New York city. He had closed up every crevice through which the gas might escape, turned on the current, and threw himself on his bed. His destitute condition is assigned as the reason why he killed himself. He left a letter to his landlady explaining his circumstances, and how he proposed to end his life.

The Plumber Once More.

Einstein, Hirsh & Co., importers of laces, etc., formerly did business on upper floor of premises 86 and 88 Franklin street, New York city, but decided to remove their location. On Saturday, Jan. 3d, the stock (usually reaching in value to half a million dollars) had been nearly all transferred to the new headquarters, the quantity remaining behind on that date being worth about \$40,000. A plumber had been authorized to remove the gas fixtures on the afternoon of that day. It was late when he got through the job, and he rather hurried matters at the finish. So great was his hurry that he failed to cap one of the bracket connec-

tions, and the gas escaped all night Saturday, the following Sunday, and up to 9 A.M. of Monday morning. When Einstein's folks visited the place on the 5th they found the rooms permeated with gas, and the "mechanic" was instantly summoned to find the leak. This he did on his prompt arrival by vigorously waving a lighted candle. Immediate result—explosion, fire, two fire alarms. Subsequent reckoning—loss by explosion, fire and water, \$68,000.

Gas-Heated Assaying Furnace.

The United States Mint exhibit at the New Orleans (La.) International Exhibition naturally attracts much attention. One of the most interesting features connected thereto (at least to the gas man) is the application of gas heat to the assaying furnace devised by Messrs. Reichhelm & Koester, of New York city. The air supply is furnished through the medium of a "Root Blower."

CONTRACT AWARDED.—The Indianapolis (Ind.) Gas Light Company has just awarded a contract to the Kerr-Murray Manufacturing Company for the erection of a set of sixteen feet purifier boxes, sixteen-inch centerseal and connections, with hydraulic lifts for raising purifier covers.

The Market for Gas Securities.

The city gas share market during the fortnight ended Jan. 14th has been inclined to show a decided downward tendency as to quotations. The only securities on city list proper which have fairly maintained prices ruling at close of year are Equitable and Harlem. The former is very stiffly held at 96, a bid of 95½ having failed to bring out a bona-fide transfer. Holders of Equitable, and more particularly those heavily loaded up, talk most confidently of the future prospects of the corporation; and it is rather amazing to hear some of their prognostications in regard to all the trouble they will hereafter cause the managers of the Consolidated Company. In the hereafter it will be, and a drearily long one at that. The likelihood is that the Equitable folks are "whistling to keep their courage up," and President Graham is no amateur in the delicate art of portraying rosy colors on the many financial canvases which he has so often deftly unrolled. The one great trouble, though, with the majority of brilliant colors is that exposure to the sun somewhat detracts from their stability, and we fear that were the sun of close investigation applied to the rather reckless assertions of the sanguine Equitable manipulators the airiness of the fabrics would be made apparent. Consolidated stock is weak and lower; and although the emission of the new certificates is as yet delayed, quite a little business has been transacted in contracts for future delivery. Sales have been made at as low a figure as 80, and the offerings at 81 are plentiful. The futures already disposed of generally cover smaller lots than 50 shares; and we know of several orders now in hand in which the buyers' directions are to purchase at "better than 80." Although the market for this security has gone against our predictions, we still adhere to the original claim that at 85 or below Consolidated is a purchase. It is now said that the new certificates will be ready for delivery by date of February 1st. This, however, is mere guesswork, and the truth of the case is that only the managers of the Consolidated Corporation know when the new shares will make their appearance. The Mutual Company paid a regular quarterly dividend of 2½ per cent. on Jan. 10th. Wednesday, Jan. 7th, 200 Manhattan, at auction, at 248.

Brooklyn (N. Y.) shares are dull. Williamsburgh Company declared a regular quarterly divi-

dend of 2½ per cent., payable 21st. Fulton Municipal paid a regular quarterly dividend of 3 per cent. on Jan. 15th. Mr. Joseph R. Thomas has conveyed to a syndicate of New York city capitalists (largely interested in real estate in the vicinity of Long Branch) a controlling interest in the capital stock of the Long Branch (N. J.) Gas Light Company. With this closing out of his interest Mr. Thomas retires from the Presidency of the Company—a position which was acceptably filled by him during the last eleven years. For quotations see below.

Gas Stocks.

Quotations by Geo. W. Close, Broker and Dealer in Gas Stocks (with A. E. SCOTT & Co.)

72 BROADWAY, NEW YORK CITY.

JAN. 16.

All communications will receive particular attention. The following quotations are based on the par value of \$100 per share.

	Capital.	Par.	Bid	Asked
Central.....	\$440,000	50	60	—
“ Scrip.....	220,000	—	47	57
Equitable.....	2,000,000	100	94	96
Harlem.....	2,000,000	50	114	118
“ Bonds.....	170,000	—	—	—
Manhattan.....	4,000,000	50	240	250
Metropolitan.....	2,500,000	100	210	220x
“ Bonds.....	658,000	—	110	112
Mutual.....	3,500,000	100	117	120
“ Bonds.....	1,500,000	1000	104	106
Municipal.....	3,000,000	100	195	200
“ Bonds.....	750,000	—	107	110
New York.....	4,000,000	100	148	151
Northern.....	125,000	50	—	80
“ Scrip.....	108,000	—	—	—
Gas Co's of Brooklyn.				
Brooklyn.....	2,000,000	25	127	130
Citizens.....	1,200,000	20	87	90
“ S. F. Bonds....	320,000	1000	106	110
Fulton Municipal.....	3,000,000	100	143	150x
“ Bonds.....	300,000	—	104	108
Peoples.....	1,000,000	10	78	80
“ Bonds.....	290,000	—	105	110
“ “.....	250,000	—	90	95
Metropolitan.....	1,000,000	100	90	93
Nassau.....	1,000,000	25	118	121
“ Ctfs.....	700,000	1000	88	91
Williamsburgh.....	1,000,000	50	137	140
“ Bonds... ..	1,000,000	—	106	108
Richmond Co., S. I.	300,000	50	64	75
“ Bonds.....	40,000	—	—	—
Out of Town Gas Companies.				
Buffalo Mutual, N. Y... ..	750,000	100	80	85
“ Bonds... ..	200,000	1000	95	100
Citizens, Newark.....	918,000	50	103	115
“ “ Bonds.....	124,000	—	105	110
Chicago Gas Co., Ills... ..	5,000,000	25	125	—
Peoples G. L. & C. Co., Chicago, Ills.....			8	12
Cincinnati G. & C. Co..			180	182
Consolidated, Balt.....	6,000,000		85	85½
“ Bonds.....	3,600,000		110	111½
Central, S. F., Cal.....			—	60
Capital, Sacramento, Cal.			55½	—
Hartford, Conn.....	750,000	25	122	128
Jersey City.....	750,000	20	130	140
Laclede, St. Louis, Mo.	1,600,000	100	88	—
Louisville, Ky.....	1,500,000	50	95	100
Montreal, Canada.....	2,000,000	100	181	182½
New Haven, Conn.....			25	166 170
Oakland, Cal.....			29	30
Peoples, Jersey City... ..			—	75
“ Bonds.. ..			—	—
Paterson, N. J.....			25	96 99
Rochester, N. Y.....			50	75 80
Washington, D. C.....	2,000,000	20	190	195
Wilmington, Del.....			50	188 —
Yonkers.....			50	90 92
St. Louis, Missouri.....	600,000	50	340	—
San Francisco Gas Co.				
San Francisco, Cal....			57½	58

Advertisers Index.

GAS ENGINEERS.	
Jos. R. Thomas, New York City	50
Wm. Henry White, New York City	43
GAS WORKS APPARATUS AND CONSTRUCTION.	
James R. Floyd, New York City	51
T. F. Rowland, Greenpoint, L. I.	51
Delly & Fowler, Phila., Pa.	51
Kerr Murray Mfg. Co., Fort Wayne, Ind.	51
Stacey Mfg. Co., Cincinnati, Ohio.	51
Bartlett, Hayward & Co., Baltimore, Md.	51
Morris, Tasker & Co., Limited, Phila., Pa.	50
Davis & Farnum Mfg. Co., Waltham, Mass.	18
Tanner & Delaney Engine Co., Richmond, Va.	43
R. D. Wood & Co., Phila., Pa.	44
GAS AND WATER PIPES.	
A. H. McNeal, Burlington, N. J.	50
Gloucester Iron Works, Phila., Pa.	50
Warren Foundry and Machine Co., Phillipsburgh, N. J.	50
Mellert Foundry and Machine Co., Reading, Pa.	50
Cincinnati and Newport Iron and Pipe Co., Newport, Ky.	50
SCRUBBERS AND CONDENSERS.	
G. Shepard Page, New York City	46
REGENERATOR FURNACES.	
Charles F. Dieterich, Baltimore, Md.	46
RETORTS AND FIRE BRICK.	
J. H. Gautier & Co., Jersey City, N. J.	48
B. Kreisler & Sons, New York City	48
Adam Weher, New York City	48
Laclede Fire Brick Works, St. Louis, Mo.	48
Brooklyn Retort and Fire Brick Works, Brooklyn, N. Y.	48
Borgner & O'Brien, Phila., Pa.	48
William Gardner & Son, Pittsburgh, Pa.	48
Henry Maurer, New York City	48
Chicago Retort and Fire Brick Works, Chicago, Ills.	48
Baltimore Retort and Fire Brick Co., Baltimore, Md.	48
Standard Gas Retort and Fire Brick Co., Ironton, Ohio.	48
Oakhill Gas Retort and Fire Brick Co., St. Louis, Mo.	48
GAS STOVES.	
American Meter Co., New York and Philadelphia.	47
The Goodwin Gas Stove and Meter Co., Philadelphia, Pa.	28
VALVES.	
Ludlow Valve Manufacturing Co., Troy, N. Y.	53
McNah & Harlin Mfg Co., New York City	46
John McLean, New York City	44
GAS METERS.	
Harris, Griffin & Co., Phila., Pa.	54
American Meter Co., New York and Philadelphia.	55
The Goodwin Gas Stove and Meter Co., Phila. Pa.	55
Helme & McIlbenny, Phila., Pa.	55
Maryland Meter and Mfg. Co., Baltimore, Md.	54
D. McDonald & Co. Albany, N. Y.	55
Nathaniel Tufts, Boston, Mass.	54
EXHAUSTERS.	
P. H. & F. M. Roots, Connersville, Ind.	45
Smith & Sayre Manufacturing Co., New York City	52
Wilbraham Bros., Philadelphia, Pa.	52
GAS COALS.	
Penn Gas Coal Co., Phila., Pa.	53
Perkins & Co., New York City	52
Newburgh Orrel Coal Co., Baltimore Md.	53
Despard Coal Co., Baltimore, Md.	53
Chesapeake and Ohio R.R. Coal Agency, N. Y. City	53
Westmoreland Coal Company, Phila., Pa.	53
GAS ENGINES.	
Schleicher, Schumm & Co. Phila., Pa.	56
Continental Gas Engine Co. New York City	44
GAS LAMPS.	
Siemens Regenerative Gas Lamp Co., Philadelphia, Pa.	49
G. Shepard Page, New York City	53
GAS KILNS AND OVENS.	
Thompson Gas Kiln and Oven Co., New York City	44
PURIFIER SCREENS.	
John Catot, Lawrence, Mass.	44
STREET LAMPS.	
J. G. Miner, Morrisania, New York City	45
Bartlett Street Lamp Mfg Co., New York City	45
Geo. D. Winchell Mfg Co., Cincinnati, Ohio.	45
BURNERS.	
G. Getroter, Phila., Pa.	50
Walter Anderson, New York City	50
PURIFYING MATERIAL.	
Connelly & Co., New York City	45
STEAM BLOWER FOR BURNING BREESE.	
H. E. Parson, New York City	18
PIPE COVERINGS.	
Chalmers-Spence Company, N. Y. City	43

GAS FIXTURES.	
Mitchell, Vance & Co., New York City	43
STEAM ENGINES.	
Westinghouse Machine Co., Pittsburgh, Pa.	53
STEAM PUMPS.	
A. S. Cameron Steam Pump Works, N. Y. City	45
PIPE CUTTING MACHINE.	
Pancoast & Maule, Philadelphia, Pa.	44
HYDRAULIC ELEVATOR.	
Lane & Bodley Company, Cincinnati, Ohio.	45
SHAFTING, PULLEYS, ETC.	
A. & F. Brown, New York City	43
BOOKS.	
The Chemist's Assistant	44
King's Treatise	46
Scientific Books	54
Fodell's Book-Keeping	46
Management of Small Gas Works	46
Newbigging's Gas Manager's Handbook	48

SITUATION WANTED.

A young man thoroughly competent to take complete charge of a gas plant of any magnitude is desirous of obtaining a situation. Is thoroughly versed in the most approved principles and practice of modern gas engineering. Best of references. Address "H. H.," Office this Journal.

MITCHELL, VANCE & CO.,

MANUFACTURERS OF

Chandeliers

and every description of

GAS FIXTURES.

Also manufacturers of Fine Gilt Bronzes and Marble Clock warranted best time-keepers. Mantel Ornaments, etc.

Salesrooms, 836 Broadway, N. Y.

Special Designs furnished for Gas Fixtures for Churches, Public Halls, Lodges, etc.

WM. HENRY WHITE,

Consulting & Constructing

Gas Engineer & Contractor.

ESTIMATES, PLANS, AND SPECIFICATIONS FURNISHED FOR NEW WORKS OR EXTENSIONS OF EXISTING WORKS.

32 Pine St., New York City.

Correspondence solicited.

WANTED,
A Manager Capable of Taking Charge of a Small Works.

Address, giving references and salary required,
HELENA GAS LIGHT AND COKE CO.,
614-2t HELENA, MONTANA.

Situation Wanted

As Superintendent of Gas Works, or Position with some Constructing Co.,

By a reliable, experienced man, thoroughly acquainted with the manufacture and distribution of gas and construction of works. Also a first-class gasfitter. Address "D.," care this Journal.

Situation Wanted

By a Gas Engineer and Retort Setter

of nineteen years' experience. Best of references. Address

618-1t "D. H.," care this Journal.

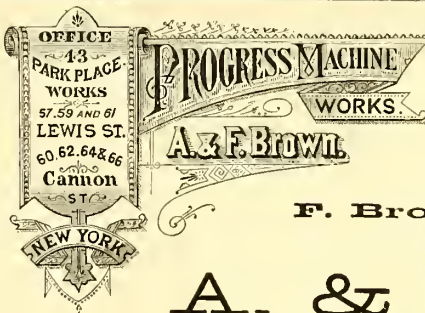

Shafting, Pulleys, HANGERS.

F. Brown's Patent Friction Clutch.

Send for Illustrated Catalogue and Discount Sheet to

A. & F. BROWN,
No. 43 Park Place, New York City.

Pipe Coverings.

Fireproof, Non-Conducting Coverings for **STEAM PIPES, BOILERS,** And all Hot Surfaces.

Made in sections three feet long. Easy to apply; light and cheap. Asbestos Materials, Fibre, Braided Packing, and Cement. These goods are used at Continental Works, Brooklyn.

CHALMERS-SPENCE COMPANY, 419 & 421 EIGHTH ST., N. Y.

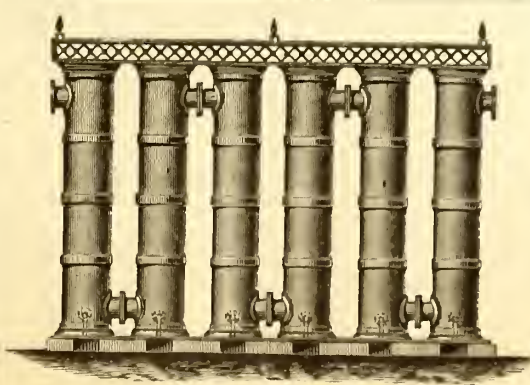
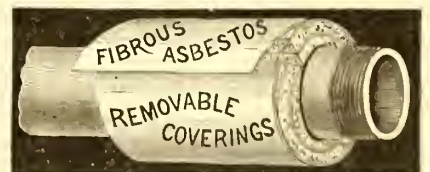

W. E. Tanner, Pres., W. R. Trigg, V.-Pres., A. Delaney, Supt.

Tanner & Delaney Engine Co.

RICHMOND, VA.

Gas Apparatus,

INCLUDING

Condensers of various styles, Scrubbers, Holders, Purifiers, Castings for Retort Houses, Etc.

ALSO STEAM ENGINES AND BOILERS. Plans, Specification and Estimates Furnished.

WM. FARMER, ENGINEER,
32 Park Place, Room 36, New York.

THE CHEMIST'S ASSISTANT; OR, KINDERGARTEN SYSTEM OF CHEMISTRY.

A system by which the elements and their valences are represented by illustrations and solid bodies.

BOX AND PAMPHLET COMPLETE, \$2.50.

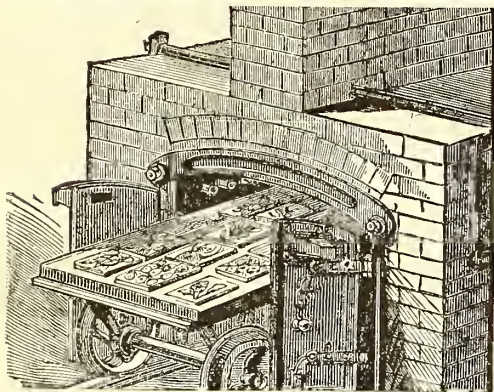

Glass-Staining Gas Kiln.

BAKERS' & CONFECTIONERS' OVENS (PAT.)

Thompson Gas Kiln & Oven Co.

59 Carmine St., N. Y.

Send for Circular by mail.

"ECLIPSE" HAND PIPE-CUTTING MACHINE.

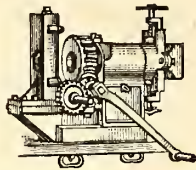

No. 1.
Powerful, inexpensive, simple in construction; can be attached to any bench or plank in a few moments. Cuts and Screws Pipes 1/4 to 2 in. Address for Prices, PANCOAST & MAULE, Philadelphia, Pa. [Mention this Paper.]

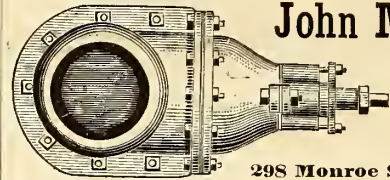

John McLean

Manufacturer of

GAS VALVES.

298 Monroe Street, N. Y.

CHURCH'S REVERSIBLE SCREEN FOR GAS PURIFIERS

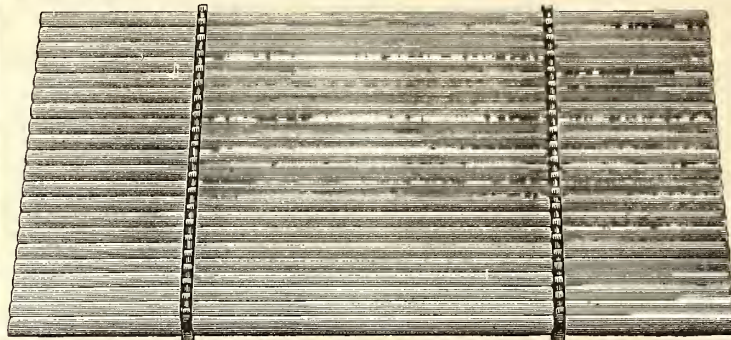

**Very Durable
Easily Repaired.**

**Oval Slats, with
Malleable Iron
Cross Bars.**

Apply to

JOHN CABOT,

LAWRENCE, MASS.

PATENTED JULY 9, 1878.

References in all parts of the country. Send for circular and list of companies who now have the Screen in use.

THE CONTINENTAL GAS ENGINE COMPANY.

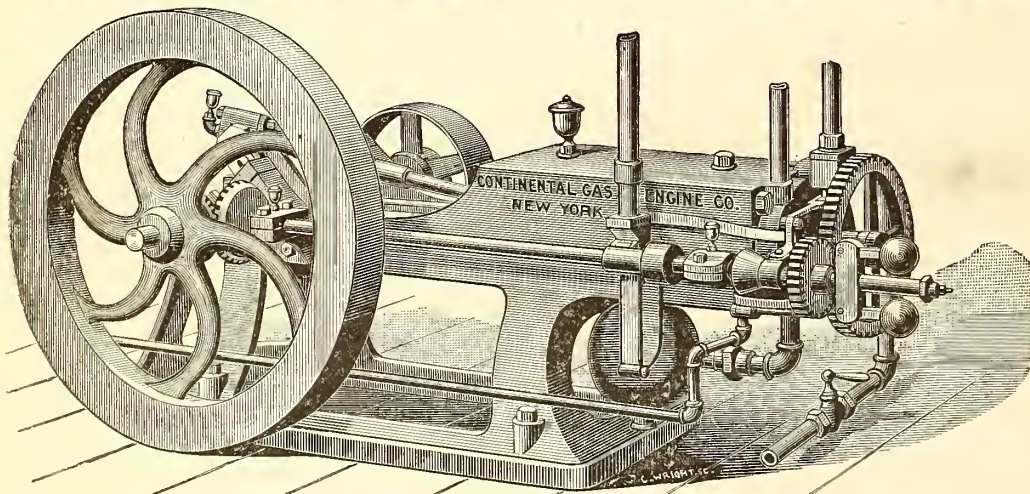

MANUFACTURERS OF

GAS ENGINES,

UNDER THE

GAUME AND OTHER PATENTS,

HAVE READY

Engines of 1/2, 1 and 1 1/2 H.P.

Arranged for power or for pumping, 1-horse power will pump 1,000 gals. water 100 ft. high with 35 ft. of gas; 1/2-horse power will pump 500 gals. 100 ft. high per hour with 25 ft. of gas.

Each Engine Tested by Indicator and Meter.

SIMPLE, ECONOMICAL, SAFE, AND SUBSTANTIAL.

Call and see engines in operation, or address for circulars and prices.

Office, No. 231 Broadway, N. Y. City.

R. D. WOOD & CO.,

400 Chestnut Street, Phila., Pa.

Cast Iron Gas & Water Pipe, Water Machinery & Gas Apparatus

Cast Iron Pipe, Fire Hydrants, Eddy Valves, Lamp Posts, Large Loam Castings, Flanged Pipe, Sugar House Work, Iron Roofs and Floors, Wrought & Cast Iron Tanks, Turbine Water Wheels and Pumps.

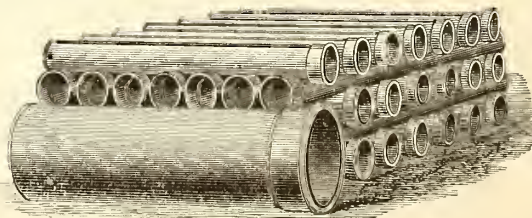

Casholders, Lime Trays, Center Valves, Purifiers, Bench Work, Exhausters, Condensers, Governors, Scrubbers, Gas Valves, Station Meters, Cast Iron Pipe Fittings.

Manufacturers of Heavy Castings and Machinery of Every Description.

ENGINEERS & CONTRACTORS FOR THE ERECTION OF GAS WORKS, & ALL MACHINERY CONNECTED THEREWITH

Estimates and specifications furnished for erection of new works or the extension or alteration of old ones.

Foundries and Works, - - Millville, Florence, and Camden, N. J.

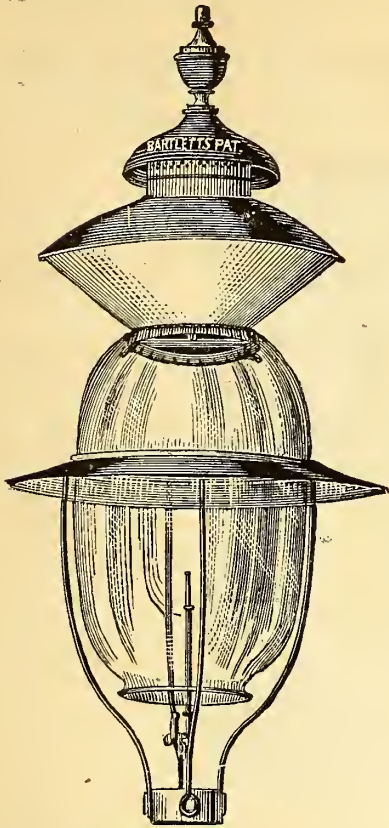

C. BARCALOW, PRES. J. V. BARCALOW, SEC. & TREAS.
BARTLETT
Street Lamp Mfg. Co.

MANUFACTURERS OF

Bartlett's Patent

GLOBE LAMPS.

FOR

Streets, Parks, Railroad Stations, Public Buildings, Etc.

LAMP POSTS A SPECIALTY.

Office and Salesroom,

No. 35 Howard Street, N. Y. City.

Gas Companies and others intending to erect lamps and posts will do well to communicate with us.

STREET LAMPS.

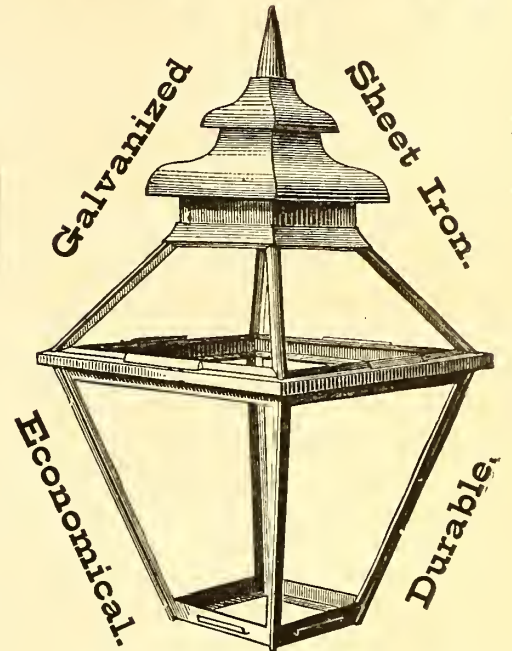

MANUFACTURED BY THE

Geo. D. Winchell Mfg. Co.,

Cor. Bank & Riddle Streets,
CINCINNATI, OHIO.

F. M. ROOTS.

S. C. ROOTS

D. T. ROOTS.

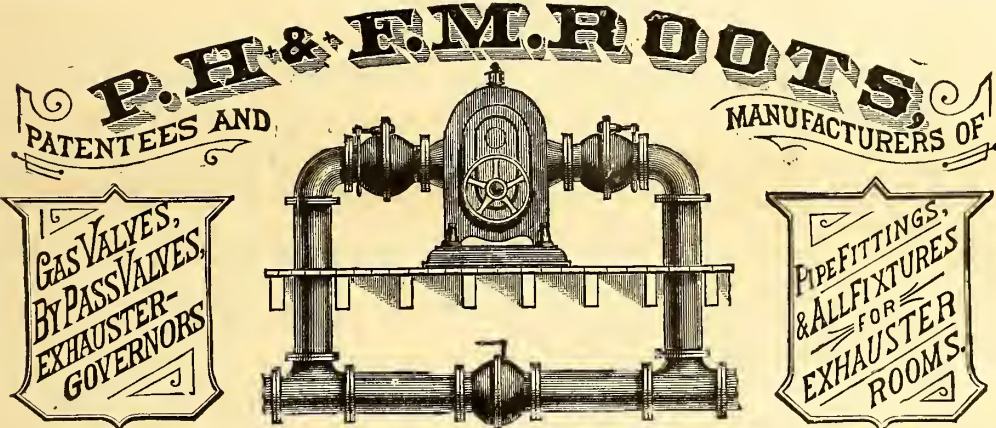

IMPROVED GAS EXHAUSTER,

WITH ENGINE ON SAME BED PLATE, OR WITHOUT.

BY-PASSES, GAS VALVES, GOVERNORS, ELBOWS, PIPE-FITTINGS, Etc., FURNISHED TO ORDER,

P. H. & F. M. ROOTS, Patentees & Manufacturers, **CONNERSVILLE, IND.**

S. S. TOWNSEND, General Agent, 22 Cortland St. and 9 Dey St., N. Y.

JAS. BEGGS & CO., Selling Agents, 9 Dey St., N. Y.

COOKE & CO., Selling Agents, 22 Cortland St., N. Y.

✿ SEND FOR ILLUSTRATED CATALOGUE AND PRICE LIST. ✿

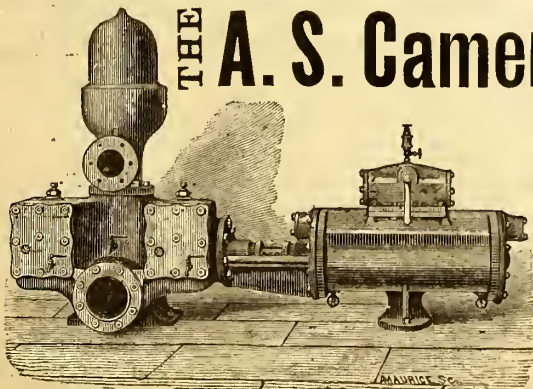

THE A. S. Cameron Steam Pump,

THE STANDARD OF EXCELLENCE.

Upward of 30,000 in Use.

BEST GAS WORKS PUMP
Ever Introduced.

Adapted to Every Possible Duty.

A. S. Cameron Steam Pump Works,
Foot East 23d St., N. Y.



Are adapted for use of Streets, Parks, Depots, Ferries, & Private Grounds.

WITH POSTS OR BRACKETS.

Jacob G. Miner,

MORRISANIA, N. Y. CITY.

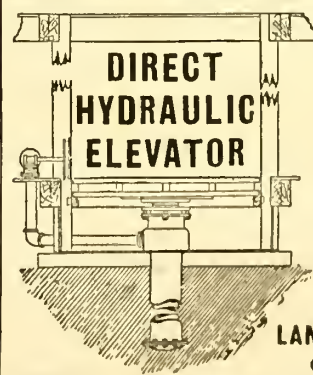

DIRECT HYDRAULIC ELEVATOR

With Iron or Wood Platform.

Largely used by Leading Gas Co.s for Coal and Coke Lifts.

Adapted for use with city service, or special pumping and accumulation system. For prices address the

LANE & BODLEY CO.,
Cincinnati, O.

Iron Sponge,
GAS EXHAUSTERS,
AUTOMATIC GAS GOVERNORS,
CONNELLY & CO., Limited,
No. 407 BROADWAY, NEW YORK CITY.

Chas. F. Dieterich's Regenerator Furnace.

(CAN BE ADAPTED TO ANY BENCH WITHOUT DISTURBING THE ORDINARY SETTINGS.)

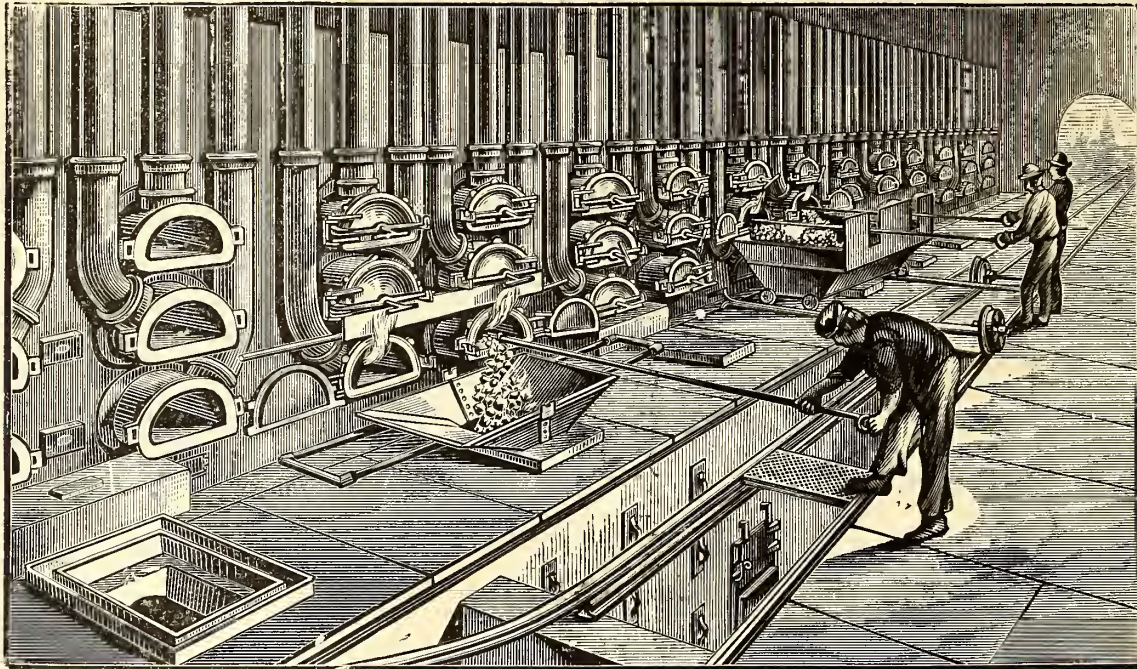

These Furnaces have been in operation at the works of the People's Gas Company, Baltimore, since June, 1878. A bench of sixes, with retorts 20 in. by 12 in. by 8 ft. 6 in. will burn off 1,350 pounds of coal in 3 hours. Twenty-five per cent. of the coke is sufficient to thoroughly burn off the charges.

We refer by permission to the following Companies who are using these Furnaces:

A. B. SLATER, Providence Gas Co. S. G. STINESS, Pawtucket Gas Co. JAS. H. ARMINGTON, Brooklyn Gas Lt. Co.

State, city, and factory rights granted on reasonable terms. For full particulars apply to

CHAS. F. DIETERICH, Engineer P. O. Box 512, BALTIMORE, MD.

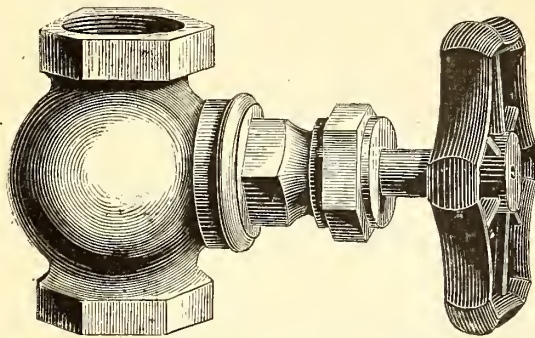

Factory, Paterson, N. J.

McNab & Harlin Mfg. Co.,

MANUFACTURERS OF

BRASS COCKS & VALVES
FOR STEAM, WATER, AND GAS.

Iron Pipes and Fittings
Seamless Brass & Copper Tubes.

Illustrated Catalogue and Price List.

56 JOHN STREET, N. Y.

The Management of Small Gas Works.

BY C. J. R. HUMPHREYS.

Price, \$1.

Orders to be sent to **A. M. CALLENDER & CO.,**
42 PINE STREET, NEW YORK.

King's Treatise on Coal Gas.

The most complete work on Coal Gas ever published.

Three Vols. Bound, \$30.

A. M. CALLENDER & CO., 42 Pine St., N. Y.

CATHELL'S Gas Consumer's Manual.

Enables every gas consumer to ascertain at a glance, without any previous knowledge of the gas meter, the quantity and money value of the gas consumed. Also the best method of obtaining from gas the largest amount of its light. It will be to the advantage of Gas Companies to supply their consumers with one of these Guides, as a means of preventing complaint arising from their want of knowledge in regard to the registration of meters.

A. M. CALLENDER & CO., 42 Pine St., N. Y.

BOOKS.

DISTILLATION OF COAL TAR AND AMMONIACAL LIQUOR.

By GEORGE LUNGE. Price \$8.50.

A TREATISE ON THE COMPARATIVE COMMERCIAL VALUES OF GAS COALS AND CANNELS.

By DAVID A. GRAHAM. 8vo., Cloth. Price \$3.

Orders for these books may be sent to this office.

A. M. CALLENDER & CO.,
42 PINE ST., N. Y. CITY.

FODELL'S System of Bookkeeping

FOR GAS COMPANIES.

Price \$5, which should be sent either in Check, P. O. Ord or Registered Letter. Blank Books, with printed headings and forms on this system, will be supplied to Gas Companies, by applying to W. P. BELL Philadelphia, or

A. M. CALLENDER & CO
OFFICE GAS LIGHT JOURNAL 42 Pine St., N. Y.

PRESERVE The Journal BY THE USE OF THE STRAP FILE.

Advantages of the Strap File.

- 1st. It is simple, strong, and easily used.
- 2d. Preserves papers without punching holes.
- 3d. Will always lie flat open.
- 4th. Allows any paper on file to be taken off without disturbing the others.

Price, \$1.25. Sent either by express or mail, as directed. By mail the postage will be 20 cents which will be added to the price of the Binder.

A. M. CALLENDER & CO., 42 PINE ST., N. Y.

THE AMERICAN METER COMPANY,

MANUFACTORIES,

512 West Twenty-second Street, N. Y.

Arch and Twenty-second Street, Phila.

Nos. 244 & 246 North Wells Street, Chicago, Ill.

AGENCIES,

No. 177 Elm Street, Cincinnati, Ohio.

Nos. 122 & 124 Sutter Street, San Francisco, Cal.

No. 810 North Second Street, St. Louis, Mo.

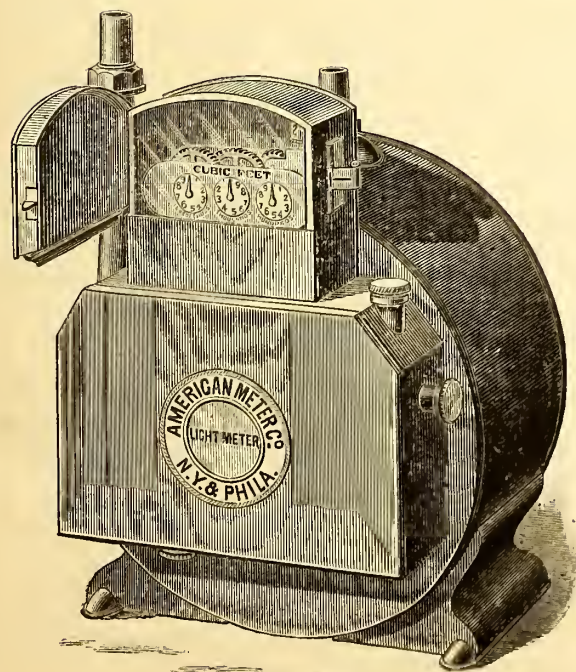
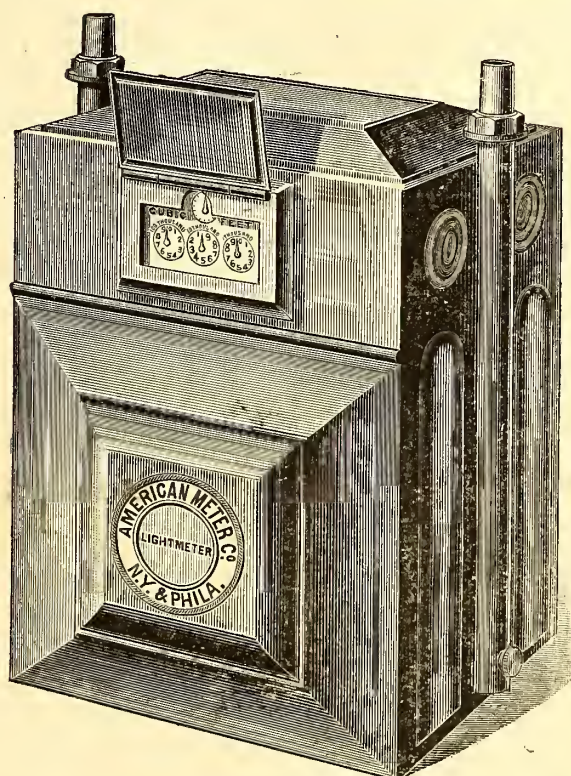

Mfr's of STANDARD WET AND DRY GAS METERS.

J. H. GAUTIER & CO..

CORNER OF

GREENE AND ESSEX STREETS,
JERSEY CITY, N. J.

MANUFACTURERS OF

Clay Gas Retorts,
Gas House Tiles,
Fire Bricks, Etc. Etc.
Ground Clay, Fire Brick and
Fire Sand in Barrels,

J. H. GAUTIER.
C. E. GREGORY.T. B. GAUTIER.
C. E. GAUTIER.**BROOKLYN**Clay Retort & Fire Brick Works,
(EDWARD D. WHITE & CO.)Manufacturers of Clay Retorts, Fire Brick,
Gas House and other Tile.
VAN DYKE, ELIZABETH, RICHARDS & PARTITION STS.
Office, 88 Van Dyke St., Brooklyn, N. Y.**LACLEDE FIRE BRICK MFG. CO.,**

MANUFACTURERS OF

Fire Brick, Gas Retorts,

AND

ST. LOUIS STANDARD SEWER PIPE.

Blast Furnace and Cupola Linings, every description of Fire
Clay Material, Fire Clay Flue Linings, Chimney Tops
Dry Milled and Crude Fire Clays, etc.

OFFICE AND DEPOT

901, 903, and 905 Pine Street,
ST. LOUIS, MO.

ESTABLISHED IN 1845.

B. KREISCHER & SONS,

OFFICE FOOT OF HOUSTON ST., E.R., N.Y.

Gas Retorts,**TILES, FIRE BRICK.**

AND EVERYTHING IN THE FIRE CLAY LINE.

MANHATTAN

FIRE BRICK & ENAMELLED CLAY

RETORT WORKS.**ADAM WEBER.**

CLAY GAS RETORTS

AND RETORT SETTINGS,
FIRE BRICKS, TILES, ETC.,

Office and Works, 15th Street and Avenue C., N. Y.

Borgner & O'Brien,

MANUFACTURERS OF

CLAY GAS RETORTS

AND RETORT SETTINGS,
FIRE BRICKS, TILES, ETC.

23d St., Above Race,

PHILADELPHIA.

TWENTY YEARS' PRACTICAL EXPERIENCE.

JAMES GARDNER, JR.

Works,
LOCKPORT STATION, PA.

—ESTABLISHED 1864.—

WILLIAM GARDNER & SON,

Successor to GARDNER BROTHERS.

WILLIAM GARDNER.

Office, COAL EXCHANGE,
PITTSBURGH, PA, P. O. Box 373.**Fire Clay Goods for Gas Works.**

C. H. SPRAGUE, No. 70 KILBY STREET, BOSTON, MASS., Agent for the New England States.

OFFICE, 418 to 422 East 23d St., New York.

ESTABLISHED 1856.

WORKS, PERTH AMBOY, NEW JERSEY.

HENRY MAURER,**Excelsior Fire Brick & Clay Retort Works**

CLAY GAS RETORTS, BENCH SETTINGS, FIRE BRICK, TILES, ETC.

STANDARD GAS RETORT AND FIRE BRICK COMPANY,

J. ANDERSON, PRES. & MANG'R.

OF IRONTON, OHIO.

C. PETERS, SECRETARY.

Clay Gas Retorts, Fire Brick, and Fire Clay Goods of Every Description.

Plans of Livesey-Somerville, McIlhenny, and other Furnaces, and Competent Workmen Supplied.

CHICAGO

Retort & Fire Brick Works,

Office, 79 Dearborn St., Unity Building. | Factory,
45th and Clark Sts.
CHICAGO, ILL.

GEORGE C. HICKS, PRES. PAUL P. AUSTIN, SEC. & TREAS.

STANDARD

Clay Retorts and Settings.

BLOCKS & TILES

Of every Shape and Size to Order.

Standard Fire Bricks.

NEWBIGGING'S**Gas Manager's Handbook.**

Price, \$4.80.

EVERY GAS MAN SHOULD HAVE ONE.

Orders may be sent to this Office.

OAKHILL**GAS RETORT & FIRE BRICK**

COMPANY.

PARKER, RUSSELL & CO.

City Office, 45th & Clark Sts,

ST. LOUIS, MO.

Our immense establishment is now employed almost entirely in
the manufacture of**MATERIALS FOR GAS COMPANIES.**We have studied and perfected three important points. Our re-
torts are made to stand changes of temperature, the strongest
heats of the furnace, and the abrasion of feeding and emptying.
Our customers are in almost every State of the Union, to all of
whom we refer.

THOS. SMITH, Prest.

AUGUST LAMBLA, Vice-Prest. & Sup

BALTIMORE**RETORT & FIRE BRICK CO.**

MANUFACTORY AT

LOCUST POINT, BALTIMORE, MD.

Connection with the City by Telephone.

Clay Retorts, Blocks & Tiles,

FIRE BRICK, FIRE CLAY,
AND FIRE CEMENT.Red and Buff Ornamental Tiles and Chim-
ney Tops. Drain and Sewer Pipe (from
2 to 30 inches). Baker Oven Tiles
12 x 12 x 2 and 10 x 10 x 2.

WALDO BROS., 88 WATER ST., BOSTON, MASS.

Sole Agents for New England States

Siemens's Regenerative Gas Burners, For Lighting and Ventilating.

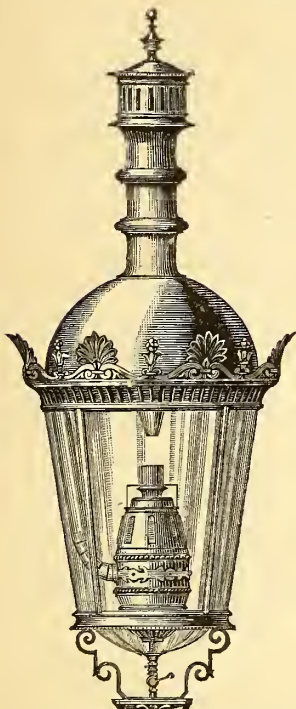

THE CHEAPEST, PUREST, AND MOST BRILLIANT OF ALL GAS LIGHTS.

Superior to the Electric Light in Economy, Beauty, & Steadiness.

SPECIALLY ADAPTED FOR LIGHTING HALLS, FACTORIES, OPEN SPACES, ETC.

Numerous Tests made by various Gas Companies in the United States show an Efficiency of Ten Candle Power per Cubic Foot of Gas.

General Agents:

- SIEMENS LIGHTING CO., 347 West Main St., Louisville, Ky.
- MEYER, MARSHALL & CO., 528 California St., San Francisco.
- DENNEHY, WOLF & O'BRIEN, 85 & 87 Dearborn St. Chicago, Ill.
- WILCOX & McGEARY, - No. 11 Bissel Block, Pittsburgh, Pa.
- T. T. RAMSDALL & CO., - 20 Swan Street, Buffalo, N. Y.
- SIEMENS GAS ILLUMINATING CO.,
Room 6, No. 157 Broadway, New York City.
- W. D. COLT, - - - - 1420 F Street, Washington, D. C.
- JOHN KIEFER, - - - 344 Lawrence, Street, Denver, Col.

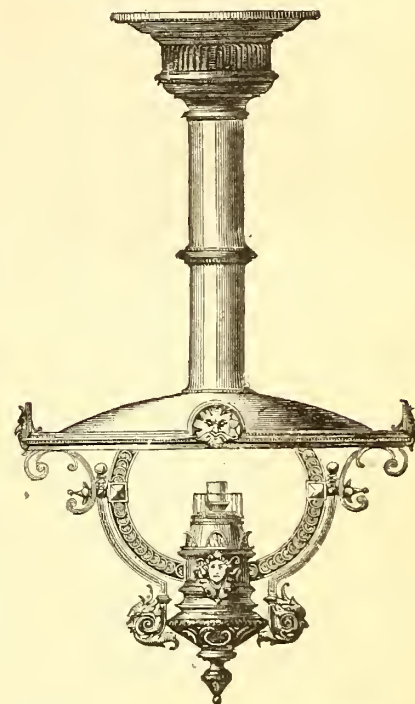

THE SIEMENS REGENERATIVE GAS LAMP COMPANY,
SOLE MAKERS FOR THE UNITED STATES,
N. E. Cor. 21st. St. and Washington Av., Philadelphia, Pa.

THE "STANDARD" WASHER-SCRUBBER, KIRKHAM, HULETT & CHANDLER'S PATENT.

Total Capacity per 24 Hours of "Standard" Washers Ordered During the Following Years.

1877.....	4,000,000 cubic feet.
1878.....	4,750,000 "
1879.....	24,545,000 "
1880.....	42,967,500 "
1881.....	36,462,500 "
1882.....	39,300,000 "
1883.....	57,735,000 "
1884.....	26,177,500 "
Total.....	235,937,500 cubic feet.

Total Number and Capacity per 24 Hours of "Standard" Washers Erected and in Course of Erection in the Several Countries

	Number.	Cubic Feet per Day.
Great Britain..	151	157,070,000
Western Hemisphere.	38	39,337,500
Australia.....	18	12,150,000
New Zealand	2	650,000
France.....	6	4,550,000
Belgium.....	8	5,420,000
Germany.....	16	8,200,000
Holland.....	4	4,160,000
Denmark.....	1	150,000
Russia.....	2	3,500,000
Spain.....	1	350,000
India.....	1	400,000
Total.....	248	235,937,500

**THE CONTINUED POPULARITY
Of these Machines**

Will be recognized from the following extracts from letters from representatives of some of the companies having them in use:

PITTSBURGH GAS Co., Nov. 25, 1884.

GEO. SHEPARD PAGE, Esq.:

Dear Sir—We use 1½ galls. water per 1,000 cubic feet, and obtain 11-oz. liquor. All the ammonia is removed from the gas, with one chamber clean. Six-tenths pressure runs the machine. It is running to our entire satisfaction. Respectfully yours,

[Signed] JOHN H. McELROY, Engr.

LACLEDE GAS WORKS, }
St. Louis, Nov. 25, 1884. }

GEO. SHEPARD PAGE, Esq.:

Dear Sir—The Scrubber is performing its work to our entire satisfaction. It has passed and thoroughly freed from ammonia 30 per cent. more gas than it was rated as being able to pass. The test paper shows not a trace of ammonia at the outlet. Respectfully yours,

[Signed] FREDERIC EGNER,
Engr. and Supt.

"Standard" Washers Ordered During the Current Year.

	Cu. Ft. per Day
Anneberg Gas Co.....	200,000
Bombay Gas Co.....	400,000
Brussels Co.....	1,250,000
Chemnitz Gas Co.....	1,000,000
CITIZENS GAS CO., BUFFALO.....	750,000
Coke Works in Zabre, Ober-Schlesien.....	1,500,000
Cokerei der Friedenshutte, Upper Silesia.....	700,000
Dunfries Corporation.....	250,000
Dunedin Gas Co., New Zealand.....	400,000
King's Lynn Gas Co.....	300,000
Leiden, Holland.....	600,000
Lincoln Gas Co.....	400,000
Liverpool Gas Co.....	2,000,000
".....	3,000,000
LOUISVILLE GAS CO.....	1,500,000
Nunica Gas Co.....	100,000
PITTSBURGH GAS CO.....	1,500,000
PORTLAND GAS CO., Oregon.....	562,500
SAN FRANCISCO GAS CO.....	4,000,000
Sheepbridge.....	40,000
ST. LOUIS GAS CO.....	2,000,000
Sydney Gas Co.....	2,500,000
WASHINGTON, D. C. GAS CO.....	2,000,000
Whitechurch Gas Co.....	175,000
Total.....	26,177,500

GEO. SHEPARD PAGE, No. 69 WALL STREET, NEW YORK,
SOLE AGENT FOR THE WESTERN HEMISPHERE.

A. H. M'NEAL,

BURLINGTON, N. J.

Flange-Pipes

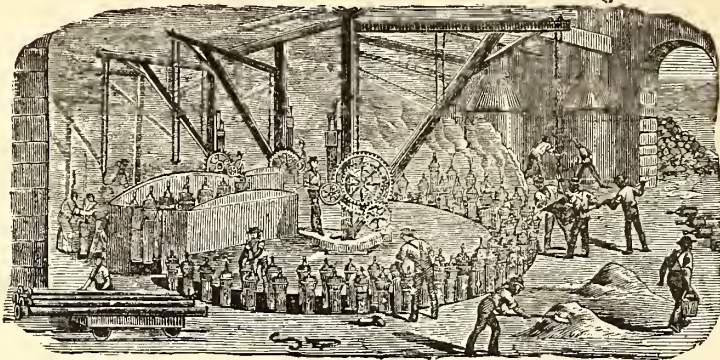

General Foundry Work.

CAST IRON PIPES

FOR WATER AND GAS.

JAMES S. MOORE, Pres.
BENJAMIN CHEW, Treas.

JAS. P. MICHELLON, Sec.
WM. SEXTON, Supt.

GLOUCESTER IRON WORKS,

GLOUCESTER CITY, N. J.

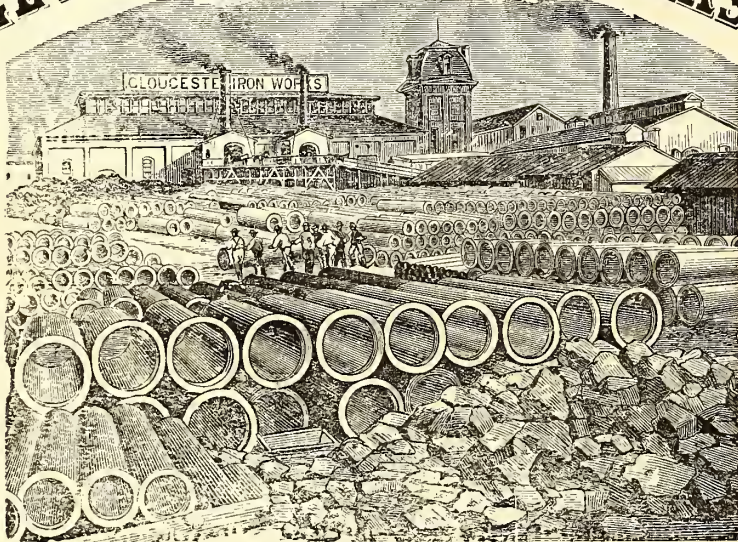

Cast Iron Gas & Water Pipes, Stop Valves, Fire Hydrants, Gasholders, &c.
Office No. 6 North Seventh Street, Philadelphia.

ESTABLISHED 1856.

WARREN FOUNDRY AND MACHINE CO.,

WORKS AT PHILLIPSBURGH, N. J.
NEW YORK OFFICE, 162 BROADWAY.

Cast Iron Water and Gas Pipe

FROM TWO TO FORTY-EIGHT INCHES DIAMETER.
ALSO ALL SIZES OF

FLANGE PIPE for Sugar House and Mine Work.
Branches, Bends, Retorts, Etc., Etc.

436-1

MATTHEW ADDY, President.

W. L. DAVIS, Selling Agent.

GEO. P. WILSHIRE, Sec. & Treas.

Cincinnati and Newport Iron and Pipe Company,

NEWPORT, KY.

Lamp Posts
AND
BENCH CASTINGS

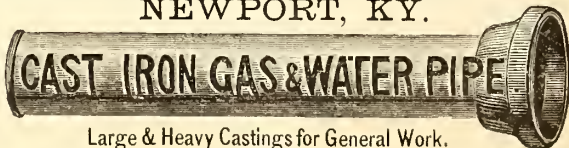

Branch
AND
SPECIAL CASTINGS

A Specialty.

Large & Heavy Castings for General Work.

FOR GAS & WATER CO'S.

Manufacture Pipe from 2 to 48 inches. All work guaranteed first quality.

Mellert Foundry and Machine Co. Limited. Established 1848.

MANUFACTURERS OF



Specials—Flange Pipe, Valves and Hydrants,
Lamp Posts, Retorts, etc.
Machinery and castings for Furnaces, Rolling Mills, Grist and
Saw Mills, Mining Pumps, Hoists, etc.

GENERAL OFFICE, - - - READING, PA.

To Gas Companies.

We make to order **CAP BURNERS** to burn any amount
under a stated pressure. Send for samples.

Also, **SERVICE CLEANERS, DRIP PUMPS,** and **STREET
MAIN PROVING APPARATUS.**

C. A. GEFROER,
248 N. 8th Street, Phila., Pa.

WALTER ANDERSON,

Manufacturer of all descriptions of

GAS BURNERS.

Also Metal E. H. Nickel Plated Tips for Water Gas.
COR. WHITE AND ELM STS., N. Y.

MORRIS, TASKER & CO., Limited,

Builders of Gas Works,
PHILADELPHIA, PA.

LUDLOW VALVE MFG. CO

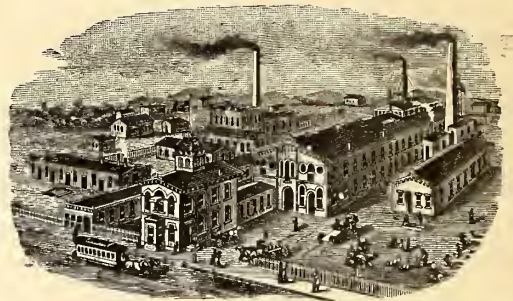

OFFICE AND WORKS,

938 to 954 River Street and 67 to 83 Vail Av.

TROY, N. Y.

Hydraulic Main Dip Regulators, also
Check Valves, Foot Valves, Yard-
wash and Fire Hydrants.
Send for Circulars.

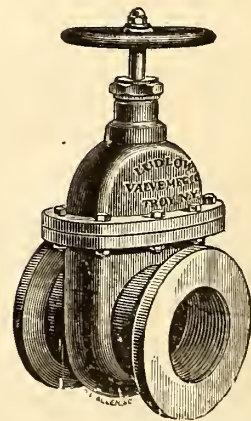

Valves.—Double and Single Gate, 1/2 in. to
48 in., outside and inside Screws. Indica-
tor, etc., for Gas, Water, Steam, and Oil.
Send for Circulars.

JOS. R. THOMAS, C.E.,

May be Consulted on all Mat-
ters Relating to Gas Works
and Gas Manufacture.

ADDRESS THIS OFFICE.

The Kerr Murray Mfg. Co.,

MANUFACTURERS OF

BENCH CASTINGS,

**Boilers and Engines,
STEAM JET AND ROTARY
EXHAUSTERS.**

HOT TAR SCRUBBERS.

**Annular and Pipe Air
Condensers.**

Multitubular Water Condensers,

WATER SPRAY WASHERS,

Purifiers, Ash Lime Trays, Improved Dry
Center Seals, Meter Bye-Passes,
Hub & Flange Stop Valves.

Gasholders,

SINGLE AND DOUBLE LIFT.

Latest and most improved patterns of gas apparatus, from
4 to 30 inch openings. Plans, specifications, and estimates fur-
nished for erection of new and rebuilding of old works.

Kerr Murray Mfg. Co.,

FORT WAYNE, IND.

JAMES R. FLOYD,

(SUCCESSOR TO HERRING & FLOYD)

Oregon Iron Works,

531 to 543 West 20th St., N. Y.

Practical Builders of Gas Works,

MANUFACTURERS OF

**ALL KINDS OF CASTINGS
AND
APPARATUS FOR GAS-WORKS.**

BENCH CASTINGS

from benches of one to six Retorts each.

**WASHERS: MULTITUBULAR AND
AIR CONDENSERS; CONDEN-
SERS; SCRUBBERS**

(wet and dry), and

EXHAUSTERS

for relieving Retorts from pressure.

BENDS and BRANCHES
of all sizes and description.

**FLOYD'S PATENT
MALLEABLE RETORT LID.**

**PATENT
SELF-SEALING RETORT LIDS.**

**FARMER'S
PATENT BYE-PASS DIP-PIPE.**

**SABBATON'S PATENT
FURNACE DOOR AND FRAME.**

**BUTLER'S
COKE SCREENING SHOVELS.**

GAS GOVERNORS,

and everything connected with well regulated Gas Works at
low price, and in complete order.

SELLER'S CEMENT

for stopping leaks in Retorts.

N. B.—STOP VALVES from three to thirty inches—
very low prices.
Plans, Specifications, and Estimates furnished.

CONTINENTAL WORKS.

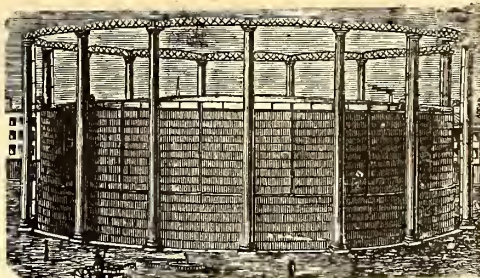

GASHOLDERS OF ANY MAGNITUDE.

T. F. ROWLAND, Proprietor,

GREENPOINT, BROOKLYN, N. Y.

ENGINEER AND MANUFACTURER OF

GAS-HOLDERS.

CONDENSERS, SCRUBBERS, VALVES,

PURIFIERS, RETORTS, and HY-

DR АуLIC MAINS,

and all other articles connected with the Manufacture-
Distribution of Gas. Plans and Specifications prepared
and Proposals given for the necessary Plant for Lighting
Cities, Towns, Mansions, and Manufactories.

H. RANSHAW, Prest. & Mangt. WM. STACEY, Vice-Pres. T. H. BIRCH, Asst. Mangt. R. J. TARVIN, Sec. & Treas.

STACEY MFG. CO.,

MANUFACTURERS OF

Single and Telescopic Gasholders,

IRON ROOFS, BRIDGES, LAMP POSTS,

Water and Oil Tanks, Coal Elevator Cars,

COKE CRUSHERS, BENCH CASTINGS,

And all kinds of Wrought and Cast Iron Work used in the erection of Coal and Oil Gas Works.
Rolling Mill Machinery and Heavy Castings a Specialty.

Foundry:

33, 35, 37 & 39 Mill Street.

Wrought Iron Works:

16, 18, 20, 22, 24 & 26 Ramsey Street.

Cincinnati, Ohio.

BARTLETT, HAYWARD & CO.,

Office, 24 Light.

BALTIMORE, MD.

Works, Pratt & Scott.

PURIFIERS.

Roofs.

Bench Castings.

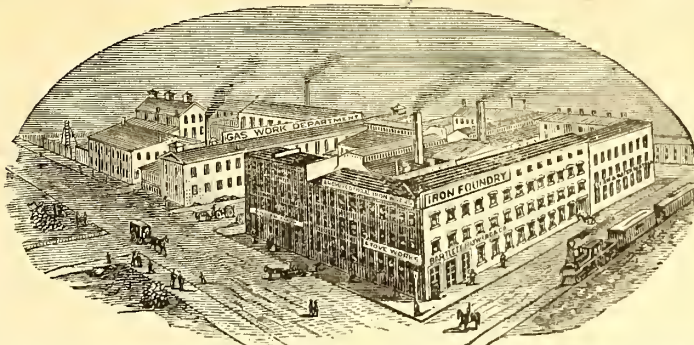

SCRUBBERS.

BOILERS.

CONDENSERS.

GASHOLDERS.

CONSTRUCTING ENGINEERS AND BUILDERS OF GAS WORKS.

1842. **DEILY & FOWLER,** 1884.

Laurel Iron Works.

Address, No. 39 Laurel Street, Philadelphia, Pa.

MANUFACTURERS OF

GASHOLDERS,

Single or Telescopic, with Cast or Wrought Iron Guide Frames.

Holders Built Since 1880:

- | | | | | |
|--------------------------|-----------------------|----------------------------|---------------------------|----------------------------|
| Mount Joy, Pa. | West Point, N. Y. | Galveston, Texas (2d.) | Kalamazoo, Mich. (3d.) | Newport, R. I. |
| Rockaway B'ch, N.Y. (2) | Fitchburgh, Mass. | Marlboro, Mass. | Glen Island, N. Y. | Portland, Oregon. |
| Zanesville, O. (2d.) | New London, Conn. | Denver, Col. | Warren, Ohio. | Allegheny, Pa. (2d.) |
| Lancaster, O. | Derby, Conn. | Chicago, Ill. (West Side). | Bath, N. Y. | Atlanta, Ga. (2d.) |
| Blackwell's Island N. Y. | Bridgeport, Conn. | Pittsburgh, Pa. (S. Side). | Lynn, Mass. | N.Y. City (Central Gas Co) |
| Waltham, Mass., (1st.) | Allegheny, Pa. (1st.) | Pawtucket, R. I. | New Bedford, Mass. | Lynchburg, Va. (2d.) |
| Dorchester, Mass. | St. Hyacinth, Can. | Brookline, Mass. | Waterbury, Conn. | Waynesville, R. I. |
| Wheeling, West Va. | Norwalk, O. | Sherbrooke, Can. | Deseronto, Can. | Rondout, N. Y. |
| Lansing, Mich. | Brattleboro, Vt. | Burlington, N. J. (2d.) | Hoosic Falls, N. Y. (2d.) | Atlantic City, N. J. |
| Flint, Mich. | Waltham, Mass (2d.) | Bridgeton, N. J. | Bethlehem, Pa. | Augusta, Ga. |
| Galveston, Texas (1st.) | West Chester, Pa. | Bay City, Mich. | Atlanta, Ga. (1st.) | Waltham, Mass. (2d) |
| Milton, Pa. | Baltimore, Md. | Erle, Pa. | Savannah, Ga. | |
| Scranton, Pa. | Hollidaysburg, Pa. | Jackson, Mich. | Montgomery, Ala | |

GAS COALS.

GAS COALS.

GAS COALS.

JAMES D. PERKINS.

PERKINS & CO.,

F. SEAVERNS.

General Sales Agents.

THE YOUGHIOGHENY RIVER COAL COMPANY,

Organized August 1, 1882.

MINERS AND SHIPPERS OF THE WELL-KNOWN

Ocean Mine Youghioghenny Gas Coal.

The Coal from the Ocean Mine (recently operated by Messrs. W. L. Scott & Co., of Erie, Pa.,) is now used by all the leading Gas Companies in the United States from Maine to Texas, and is recognized as *the only reliable Youghioghenny Gas Coal.*

Messrs. W. L. Scott & Co. and W. L. Scott, Esq., still retain their interest in the new Company, and the same general policy which has characterized the management of the mine under these gentlemen will be continued by the new Company. With largely increased facilities and *unlimited supply of Coal*, any demand made upon the Colliery will meet with prompt fulfillment.

THE UNDERSIGNED CAN SUPPLY THE FOLLOWING SUPERIOR GRADES OF

GAS CANNELS:**Abram Cannel**, from the Abram Colliery, Wigan, England,**Plesio-Boghead Cannel**, from near the old Boghead Colliery, Scotland.**North Ince Hall Cannel**, from Liverpool, England.

Breckenridge Cannel, from Kentucky. The railroad now being constructed to the Ohio river will open up this superior Cannel deposit, and enable us to deliver it at any required point. See full description of this Cannel, and Map of the Colliery, in the "American Gas Light Journal," April 16, 1883, pages 172 and 173.

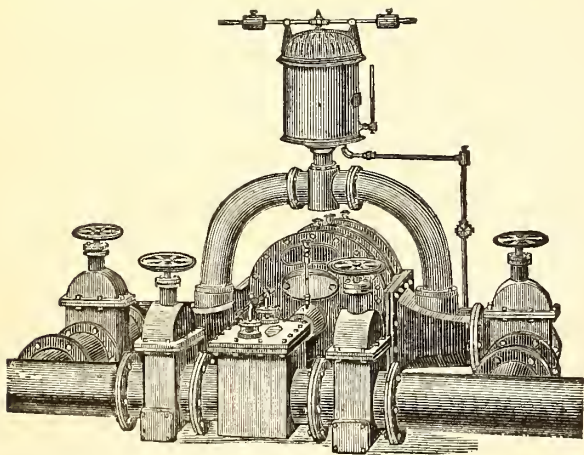
P. O. Box 3695,
New York.**PERKINS & CO., 228 and 229 N. Y. Produce Exchange****BEAVER STREET
ENTRANCE.****SMITH & SAYRE MFG. COMPANY,**

G. G. PORTER, Prest.

245 Broadway, N. Y.

CHAS. W. ISBELL, Sec'y.

Machinery & Apparatus for Gas Works

Drawings, Plans, and Estimates Furnished for the Improvement, Extension, or Alteration of Gas Works, or for the Construction of New Works.

Mackenzie's Patent Rotary and Steam Jet Gas Exhausters, Governors, Compensators, Condensers, Washers, Scrubbers. Isbell's Patent Automatic Street Pressure Governor, Gas and Water Valves, Hydraulic Main Dip Regulator, Bench Castings, etc. Purifying Boxes and "Standard" Scrubbers. Isbell's Patent Self-Sealing Retort Doors.

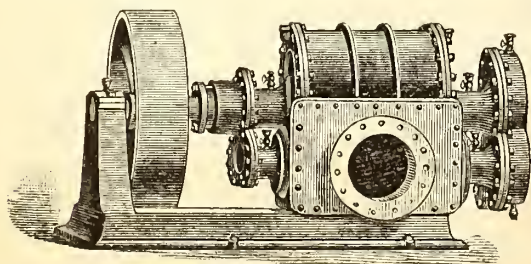

Gas Exhauster Driven by Belt.

The Wilbraham Gas Exhauster,

"BAKER SYSTEM,"

WITH ENGINE ATTACHED, ON SAME BED PLATE OR WITHOUT.

Best, Cheapest and Most Durable Exhauster known.

WILBRAHAM BROS.,

No. 2320 Frankford Avenue, Philadelphia, Pa.

GAS COALS.

GAS COALS.

GAS COALS.

Newburgh Orrel Coal Co.,
MINERS AND SHIPPERS OF

**Newburgh Orrel, Tyrconnell
and Palatine Gas Coals.**

ALSO SHIPPERS OF FOUNDRY COKE.

Mines situated at
Newburgh, Flemington & Fairmont, W.Va.

HOME OFFICE,
25 S. Gay St., Baltimore.

CHARLES MACKALL,
MANAGER.

CHAS. W. HAYS, Agent in New York,
Room 92, WASHINGTON BUILDING, No. 1 Broadway.

Shipping wharves at Locust Point. References furnished when required. Special attention given to chartering vessels.

THE DESPARD COAL COMPANY

OFFER THEIR SUPERIOR

DESPARD COAL

To Gas Light Companies and Manufacturers of Fire Clay Goods
Throughout the Country.

ROUSSEL & HICKS, } AGENTS. { BANGS & HORTON,
71 Broadway, N. Y. } 16 Kilby St., Boston.

Mines in Harrison Co., West Va. Wharves, Locust Point, Balt.
Company's Office, 15 German St., Baltimore, Md.

Among the consumers of Despard Coal we name: Manhattan
Gas Light Co., N. Y.; Metropolitan Gas Light Co., N. Y.; Jersey
City, (N. J.) Gas Light Co.; Washington (D. C.) Gas Light Co.;
Portland (Maine) Gas Light Co. Reference to them is requested.

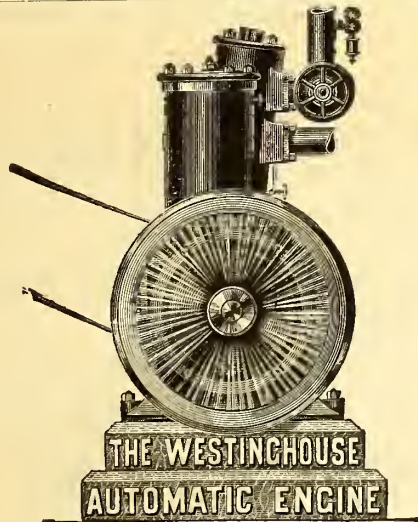

1,000 Engines Now in Use.

30,000 H.P. NOW RUNNING!

Sales, 2,000 H.P. per Month!

SEND FOR ILLUSTRATED CIRCULAR AND REFERENCE LIST.

Westinghouse Machine Co.,

PITTSBURCH, PA.

SALES DEPARTMENT CONDUCTED BY

Westinghouse, Church, Kerr & Co., 17 Cortlandt
Street, New York City.

Fairbanks, Morse & Co., Chicago, Cincinnati, Cleve-
land, Louisville, and St. Paul.

Fairbanks & Co., St. Louis, Indianapolis, and Denver.

Parke & Lacy, San Francisco, and Portland, Or.

Parke, Lacy & Co., Salt Lake City, Utah.

Imray, Hirsch & Kaoppel, Sydney and Melbourne,
Australia.

**THE
PENN GAS COAL COMPANY**
OFFER THEIR
**COAL, CAREFULLY SCREENED,
AND PREPARED FOR
GAS PURPOSES.**

Their Property is located in the Youghiogheny Coal Basin, near Irwin's and Penn Station
on the Pennsylvania Railroad, and on the Youghiogheny River.

OFFICES
No. 209 South Third Street, Phil'a. 90 Wall Street, New York.

PLACES OF SHIPMENT.
Pennsylvania Railroad, Pier No. 2 (Lower Side).
Greenwich Wharves, Delaware River.
Pier No. 1 (Lower Side), South Amboy, N. J.

Chesapeake & Ohio Railway Coal Agency,

FOR THE SALE OF THE

**Superior Kanawha Gas Coals, Cannelton Cannel,
Also, SPLINT AND STEAM COALS**

From the Kanawha and New River Regions, on the line of the Chesapeake & Ohio R'way.
C. B. ORCUTT, Sales Agent. | OFFICE, 150 BROADWAY, N. Y.

FRANCIS H. JACKSON, PRESIDENT.

EDMUND H. MCCULLOUGH, SEC. & TREAS.

THE WESTMORELAND COAL CO.

Chartered 1854.

Mines situated on the Pennsylvania and the Baltimore
and Ohio Railroads, in Westmoreland County, Penn.

POINTS OF SHIPMENT:
PHILADELPHIA, BALTIMORE, SOUTH AMBOY, N. J.
WATKINS (SENECA LAKE), N. Y.

Since the commencement of operations by this Company its well-known
Coal has been largely used by the Gas Companies of New England and the
Middle States, and its character is established as having no superior in gas-
giving qualities, and in freedom from sulphur and other impurities.

Principal Office, 224 South 3d St., Phila., Pa.

The Bower Gas Lamp.

The Perfected Duplex-Regenerative Gas Burner, under
the combined Patents of Anthony S. Bower,
Geo. S. Grimston, and Thos. Thorp.

The First Gold Medal awarded at the Crystal Palace Exhibition in
London, and two Gold Medals at the Stockport (Eng.) Exhibition of Gas
Appliances. Both in 1883.

GEO. SHEPARD PAGE, JOHN BOWER,
69 Wall Street, N. Y. City.

The Management of Small Gas Works.

By C. J. R. HUMPHREYS. Price, \$1.
A. M. CALLENDER & CO., 42 Pine St., N. Y.



INTERNATIONAL--1876--EXHIBITION.



The U. S. Centennial Commission

HAVE DECREED AN AWARD TO

HARRIS, GRIFFIN & CO.,

12th and Brown Sts., Philadelphia, and 49 Dey St., N. Y., U. S. A.,

FOR THE FOLLOWING REASONS :

The Exhibit consists of a Series of METERS from the Largest Size Station Meters for the use of the MANUFACTURE OF GAS, to those for the use of the ORDINARY CONSUMER. The Instruments are WELL MADE, RELIABLE as to INDICATION, and embody a number of sundry improvements which, with the general character of the Exhibit, entitle the whole to commendation.

Attest—J. L. CAMPBELL,
Secretary, pro-tem.Signed—A. T. GOSHORN,
Director GeneralJ. R. HAWLEY,
President

CHARLES E. DICKEY.

JAMES B. SMALLWOOD.

CHARLES H. DICKEY.

Maryland Meter and Manufacturing Co.,**DICKEY, TANSLEY & CO.,**

Established 1866.

Nos. 22 and 24 Saratoga Street, Baltimore, Md.

No. 46 La Salle St., Chicago, Ill.

MANUFACTURERS OF

DRY GAS METERS, STATION METERS, GLAZED METERS, TEST METERS, METER PROVERS, PRESSURE AND VACUUM REGISTERS, GOVERNORS, INDICATORS, SERVICE AND METER COCKS, AND METER CONNECTIONS.

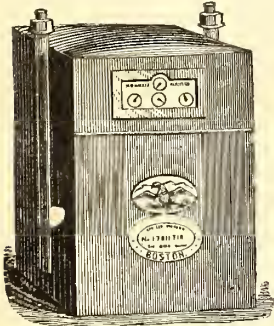

Dry Gas Meter.

With 39 years' experience and the best facilities for manufacturing, is enabled to furnish reliable work and answer orders promptly.

NATHANIEL TUFTS,

No. 153 Franklin Street, Boston, Mass.,

MANUFACTURER OF

DRY GAS METERS.

Station Meters of any Capacity.

Test and Experimental Meters, Pressure Registers, Pressure Gauges, Pressure and Vacuum Gauges.

METER PROVERS, PHOTOMETERS, STREET LANTERNS, ETC., ETC.

Patent Cluster Lanterns for Street Illumination.

SCIENTIFIC BOOKS.

We are prepared to furnish to Gas Managers, and others interested in the topics treated of, the following books, at prices named :

KING'S TREATISE ON THE MANUFACTURE OF COAL GAS. Three vols.; \$10 per vol.	GAS CONSUMER'S MANUAL, by E. S. CATHELS, C.E. 10 cts.	CORRECT GAS MEASUREMENT; the serious Loss and Inconvenience to Gas Companies and the Public Caused by the Freezing and Inaccuracy of Wet Gas Meters, by GEORGE GLOVER. 40 cents.
GAS MANUFACTURE, by WILLIAM RICHARDS. 4to., with numerous Engravings and Plates, in Cloth binding. \$12.	PRACTICAL TREATISE ON HEAT, by THOMAS BOX. Second edition. \$5.	GAS WORKS, AND MANUFACTURING COAL GAS, HUGHES. \$1.40.
THE GAS ANALYST'S MANUAL, by F. W. HARTLEY. \$2.50.	FODELL'S SYSTEM OF BOOKKEEPING FOR GAS COMPANIES. \$5.	A PRACTICAL TREATISE ON GAS AND VENTILATION, with Special Relation to Illuminating, Heating, and Cooking by Gas, by E. E. PERKINS. \$1.25.
ANALYSIS, TECHNICAL VALUATION, PURIFICATION, and USE OF COAL GAS, by REV. W. R. BOWDITCH, M.A.; with Engravings; 8vo., Cloth. \$4.50.	GAS WORKS—THEIR ARRANGEMENT, CONSTRUCTION, PLANT, AND MACHINERY. \$8.	APPARATUS AND FITTINGS FOR GAS WORKS, by F. COLYER. 8vo., Cloth. \$8.
GAS MEASUREMENT AND GAS METER TESTING by F. W. HARTLEY. \$1.60.	COAL; ITS HISTORY AND USE, by PROF. THORPE. \$3.50.	GAS CONSUMER'S HANDY BOOK, by W. RICHARDS. 18 mo., Paper. 20 cents.
GAS CONSUMER'S HANDBOOK, by WILLIAM RICHARDS, C.E.; 18mo., Sewed. 20 cents.	THE GAS WORKS OF LONDON, by COLBURN. 60 cents.	
	THE GAS FITTER'S GUIDE, Showing the Principles and Practice of Lighting with Coal Gas, by JOHN ELDRIDGE. 40 cents.	

The above will be forwarded by express, upon receipt of price. We take especial pains in securing and forwarding any other Works that may be desired, upon receipt of order. All remittances should be made by check, draft, or post office money order.

A. M. CALLENDER & CO., No. 42 Pine Street, New York,

T. C. HOPPER, Pres. G. J. McGOURKEY, Vice-Pres. (New York). WM. N. MILSTED, Gen. Supt. & Treas. (New York). WM. H. DOWN Sec.

AMERICAN METER COMPANY,

WET AND DRY GAS METERS. STATION METERS. EXHAUSTER GOVERNORS. DRY CENTRE VALVES. GOVERNORS FOR GAS WORKS. PRESSURE REGISTERS. PRESSURE & VACUUM REGISTERS. PRESSURE & VACUUM GAUGES. CRESSON GAS REGULATORS. MARSLAND WATER METERS. METER PROVERS. PORTABLE TEST METERS. EXPERIMENTAL METERS. AMMONIA TEST METERS. BAR AND JET PHOTOMETERS.

Manufactories:
512 W. 22d St., N. Y.
Arch & 22d Sts., Phila.

GAS STOVES,
SUGG'S "STANDARD" ARGAND BURNERS,
SUGG'S ILLUMINATING POWER METER,
Wet Meters, with Lizar's "Invariable Measuring" Drum.

Agencies:
177 Elm Street, Cincinnati.
244 & 246 N. Wells Street, Chicago.
810 North Second Street, St. Louis.
122 & 124 Sutter St., San Francisco.

HELME & McILHENNY.

Successors to Harris & Brother.

ESTABLISHED 1848.

PRACTICAL GAS METER MANUFACTURERS,

Continue as heretofore at the OLD ESTABLISHMENT, Nos. 1115 and 1117 Cherry Street, Philadelphia, Pa.

To manufacture Wet and Dry Gas Meters, Station Meters, Experimental Meters, Meter Provers, Centre Seals, Governors, Pressure Registers, Indicators, Photometers, and all kinds of Gas Apparatus; Also furnish all other Articles appertaining to the use of Gas Works.

From our long Practical Experience of the Business (covering a period of 33 years) and from our personal supervision of our Work, we can guarantee all orders to be executed promptly, and in every respect satisfactorily.

WILLIAM HELME

JOHN McILHENNY.

WM. WALLACE GOODWIN, Prest. and Treas.

WM. H. MERRICK, V.-Prest.

S. L. JONES, Sec.

S. V. MERRICK, Asst. Sec

THE GOODWIN GAS STOVE AND METER COMPANY,

Successors to W. W. GOODWIN & CO.

1012, 1014 and 1016 Filbert St., Phila., Pa. 142 Chambers St., New York.
126 Dearborn St., Chicago, Ill.

WALDO BROS., Agents, 88 Water St., Boston.

MANUFACTURERS OF THE "SUN DIAL" GAS STOVES, FOR COOKING AND HEATING PURPOSES.

Dry and Wet GAS METERS, Station Meters (Square, Cylindrical or in Staves) Glazed Meters, King's and Sugg's Experimental Meters, Lamp Post Meters, Etc., Etc., Meter Provers (sizes 2, 5 and 10 feet), Pressure Gauges of all kinds, Pressure Registers, Pressure and Vacuum Registers, Pressure Indicators (sizes 4 inch, 6 inch and 9 inch), King's Pressure and Vacuum Gauges, Dry and Wet Centre Seals, Dry and Wet Governors, Exhauster Governors, Photometers of all descriptions. Lethby's Sulphur and Ammonia Test Apparatus complete—also Testing and Chemical Apparatus of all kinds, and of the most perfect description, for all purposes relating to Gas.

GOODWIN'S IMPROVED LOWE'S JET PHOTOMETER.

Agents for Bray's Patent Gas Burners and Lanterns.

Special attention to repairs of Meters, and all apparatus connected with the business.
All work guaranteed first class in every particular, and orders filled promptly.

G. B. EDWARDS, Mang'r, New York.
E. H. B. TWINING, Mang'r, Chicago.

D. McDONALD & CO., GAS METER MANUFACTURERS.

(Established 1854.)

No. 51 Lancaster Street, Albany. N. Y.

STATION METERS, EXPERIMENTAL METERS, METER PROVING, PRESSURE & VACUUM REGISTERS, PRESSURE GAUGES, ETC.

Also STAR GAS STOVES, RANGES, and HEATING STOVES.

We use only the very best materials, and employ the most skilled labor, and by our long experience (29 years) and personal supervision of every detail, we feel justified in assuring the public that our goods will give perfect satisfaction. Every Meter emanating from our establishment will bear the State Inspector's Badge, and will be fully warranted by us. Our Annual and Calendar will be sent to Gas Companies upon application.

KING'S TREATISE ON COAL GAS.

The most complete work on Coal Gas ever published. Three vols., bound, \$30.

A. M. CALLENDER & CO., No. 42 Pine Street, New York.

THE "OTTO" GAS ENGINE.

Guaranteed to Consume 25 to 75
Per Cent. LESS GAS than ANY OTHER GAS ENGINE
PER BRAKE HORSE POWER.

TWIN ENGINES Impulse every revolution.
THE STEADIEST RUNNING GAS ENGINE YET MADE.

ENGINES AND PUMPS COMBINED,

For Hydraulic Elevators, Town Water Supply, or Railway Service.

Special Engines for Electric Light Work.

OVER 15,000
IN USE.

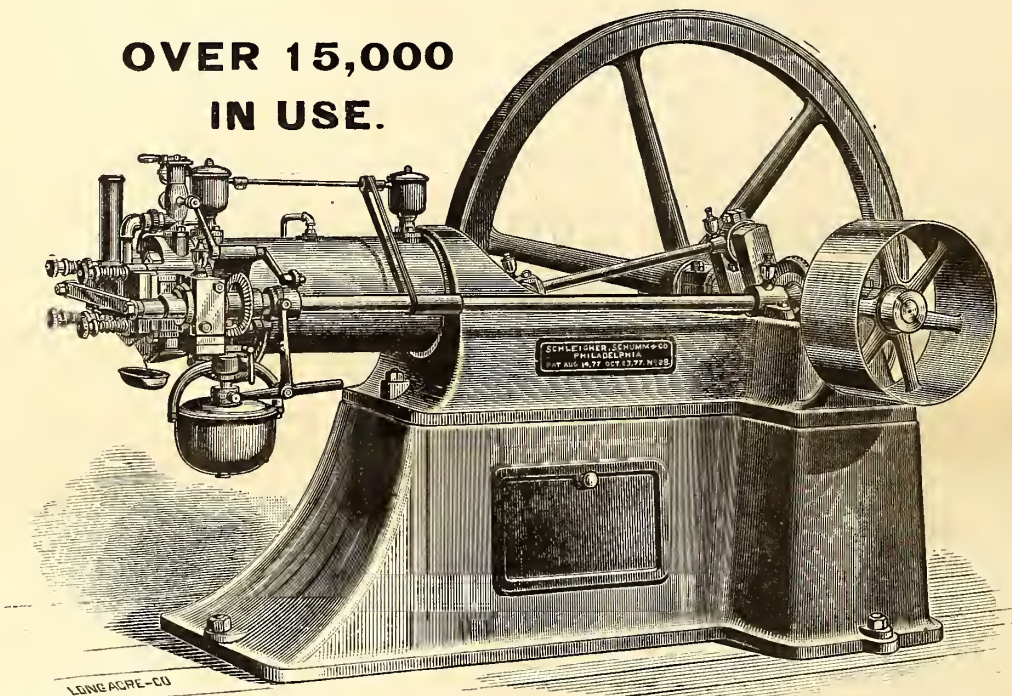

The Otto Gas Engine is now consuming, at a moderate computation, 2000 millions cubic feet of gas per year, nearly all of which is furnished during day time only.

**THE ONLY HIGHEST AWARD, ONLY GOLD MEDAL,
AT ELECTRICAL EXHIBITION, PARIS, 1881.**

MADE IN SIZES FROM 1 TO 25 HP. INDICATED.

FOR PARTICULARS, PRICES, ETC., APPLY TO

SCHLEICHER, SCHUMM & CO.,

Works:

N. E. Cor. 33d & Walnut Sts., Phila., Pa.

Branch Office:

214 Randolph Street, Chicago, Ill.

THE AMERICAN

GAS LIGHT JOURNAL

PUBLISHING OFFICE No. 42 PINE STREET

DEVOTED TO THE INTERESTS OF ILLUMINATION, VENTILATION, WATER SUPPLY AND DISTRIBUTION, & GENERAL SCIENCE.

VOLUME XLII.—No. 3.
Whole No. 615.

NEW YORK, MONDAY, FEBRUARY 2, 1885.

\$3 PER ANNUM
IN ADVANCE.

A. M. CALLENDER & CO., Proprietors. C. E. SANDERSON, Manager.
JOS. R. THOMAS, C.E., Editor.

ENTERED AT THE POST OFFICE AT NEW YORK, N. Y.,
AS SECOND CLASS MATTER.

Published on the 2d and 16th of each month, at No. 42 Pine Street, N. Y.
Terms of Subscription, Including Postage.—For the United States and Canada, \$3 per annum. European countries, \$3.50 (15 shillings—18 francs). All payments to be made in advance. Single copies, 15 cents.
Remittances should be made either by post-office order, registered letter, or bank draft on New York, payable to the order of A. M. Callender & Co.
Collections are invariably made directly from this office, for subscriptions, advertisements, etc. We have agents to solicit the same, but they are not authorized to receipt for money.

Members intending to propose the names of applicants for membership are requested to send them to the Secretary before the time of meeting.
 The Board of Directors will meet in room 13, in Young's Hotel, on the evening of February 17th, at 8 o'clock. Papers to be read before the Association should be forwarded to the Secretary in time to be presented to the Directors at this meeting for their approval.
 Friends of the Association are cordially invited to attend the Annual Meeting. Those wishing rooms engaged will please notify the Secretary on or before date of February 16th.

GEO. B. NEAL,
Secretary.

CONTENTS.

An Asterisk (*) denotes an illustrated article.

Annual Meeting New England Association of Gas Engineers—Official Notice.....	57
First Annual Meeting of the Ohio Gas Light Association—Official Notice.....	57
EDITORIALS—	
Mr. W. H. Preece on the Subject of Electric Lighting in America.....	57
Another Victory for the Siemens Burner.....	58
A Conflict of Dates.....	58
Promoted.....	58
The Proper Ratio of Storage of Gas to Consumption—By Col. F. S. Benson.....	59
*The Boardman Hydraulic Main.....	59
Gas Heat for Mechanical Purposes—Gas-Heated Bakers' Ovens—By T. J. C.....	60
First Annual Meeting of the Ohio Gas Light Association—Official Circulars.....	60
On the Use of Coal Gas—Lecture No. II., Coal Gas as a Source of Light—By H. Dixon.....	61
Special English Correspondence.....	64
The Siemens Regenerative Burners.....	66
British Gas Undertakings.....	67
Something about Lime and Cements.....	68
ITEMS OF INTEREST FROM VARIOUS LOCALITIES.....	68
A "Note" from Mr. Henry Aitken, of Falkirk—Probably Gas is Good and Cheap at Tiffin—Price of Gas Reduced at Springfield, Ohio—Contracts Secured—Personal—Killed while Experimenting—G. G. Ramsdell to Direct Affairs—Natural Gas Explosions—Evansville Gas and Electric Light Company—Election of Directors Brooklyn (N. Y.) Gas Light Company—Annual Meeting Paris (Ills.) Gas Light Company—Mr. Edison Makes another Prediction—Reducing Price of Gas at Richmond, Va.—No Electric Lights for Roman Churches—Public Lighting of Boston, Mass.—The Difference between the Two Sorts of Gases—Here is another Specimen.	
CORRESPONDENCE—	
Utilization of Waste Heat of Gas Works.....	70
The Market for Gas Securities.....	71

[OFFICIAL NOTICE.]

FIRST ANNUAL MEETING OF THE OHIO GAS LIGHT ASSOCIATION.

SECRETARY'S OFFICE OHIO GAS LIGHT ASSOCIATION,
TIFFIN, OHIO, Jan. 19, 1885.

The First Annual Meeting of the Ohio Gas Light Association will be held at the Burnett House, Cincinnati, Ohio, on the 18th day of February, 1885.

The Executive Committee expects that all the members will be in attendance at the meeting, and calls attention to the fact that matters of great importance, not only to the interest of Ohio but to the fraternity at large as well, will be discussed thereat.

The Association will be glad to welcome any of the brethren who may wish to pay a visit to the sessions.

JOS. BATE,
Secretary.

MR. W. H. PREECE ON THE SUBJECT OF ELECTRIC LIGHTING IN AMERICA.

It has long since been considered a truism by many that should one be desirous of obtaining the latest news he must travel some distance from home, in order that the fullest amount or measure of news may be secured. Without entering here into a dissertation as to the reasons why such an idea should have attained so great a following amongst seekers after the latest events of the day and hour, and without the slightest design or intention of either attempting to affirm or deny that generally the truism is well founded, we would like to call the attention of our readers to some statements, made in the early part of last December by Mr. W. H. Preece, F.R.S., before the Society of Arts, London, England. Mr. Preece's statements took the form of a lecture; and, by way of explanation, we will state that the lecturer is undoubtedly a most gifted electrician—in fact he is possessed of a large, varied and valuable stock of knowledge concerning the electric fluid, etc. It may also be added that he is quite a fluent talker, and furthermore has a great penchant for lecturing on his pet topic. Apart from all this it goes without saying that, having paid a visit to America, no matter how long a stay may have been made in our country, most Englishmen are seized with an irresistible desire to explain in print, when once safely home again, all about the wonders they have seen in Yankee land. The best part of this whole proceeding to us on this side of the water is the dogmatic manner in which the "authors" expound their views regarding the "customs of the country." Of course the practice, even at its worst, is harmless enough, and some of us

[OFFICIAL NOTICE.]

ANNUAL MEETING NEW ENGLAND ASSOCIATION OF GAS ENGINEERS.

OFFICE OF SECRETARY NEW ENGLAND GAS ASSOCIATION,
BOSTON, MASS., Jan. 24, 1885.

The Annual Meeting of the Association will be held at Young's Hotel, Boston, on the 18th and 19th days of February, commencing at 11 o'clock a.m., on Wednesday, the 18th.

may possibly be pardoned for indulging in a quiet laugh at one or two of the more than ordinarily ridiculous conclusions arrived at.

To give some slight idea of how some of Mr. Preece's brother Englishmen regard him, with respect to his willingness to "lecture," it may be observed that the *London Journal*, in a short editorial note on Mr. Preece's account of his American trip and subsequent lecture, declared, "Of him it may be said that he must lecture or die. Fortunately, if his lecturing does him good, it does not hurt anybody else." With this understanding as to the precise nature and degree of acuteness attendant upon Mr. Preece's peculiar mania, we may proceed to discuss one or two points in connection with "diseased's" presentation of the subject of electric lighting in America before the Society of Arts.

He starts out with the grandiose information that "electric lighting is flourishing in America much more than it is home," in support of the proposition adding that "there are 90,000 arc lamps alight every night in the States." How the gentleman managed to find out the precise number is still enveloped in mystery, and we fear it will remain so. He contrasts the "brilliantly illuminated avenues of New York city with the dull and dark streets of London," and then conveys the astonishing (to a New Yorker) information that he "drove from the Windsor Hotel to the Cunard wharf through streets entirely lighted by electricity." Perhaps he did; but the illumination must have been devised for his especial benefit and pleasure. It might also be remembered that whatever elegancies of electric illumination were perceived by Mr. Preece were only to be obtained by the taxpayers at an expenditure of \$255.50 per annum for each "arc." One "arc" supplants 52 gas lamps, costing at the rate of but \$17.50 each per annum; and it would seem as though, all things considered, a rather neat price was being paid for lighting the "brilliantly illuminated avenues of New York."

It is not our intention to go through the entire chapter of marvelous American electric lighting progress accounts so catchingly strung together by the enthusiastic English electrician; still, we might mention the case of that Brush-Swan experiment at Washington, D. C. Regarding this case, Mr. Preece said: "Washington has been experimentally illuminated by the Brush-Swan Electric Light Company, by very large arc lamps of 4,000 candle power each, fitted with large conical reflectors, throwing a great body of light down the streets to be illuminated. The various avenues radiating from the Capitol are thus lighted; and a circle of 14 lights, without reflectors, surrounds the top of the Capitol, the effect of which was reported to be very fine." Mr. Preece must have gotten this information from pure and simple sources—more than likely in some way connected with the particular Brush-Swan operators of the Washington experiment. The plain truth as to the Washington scheme is that a more ridiculously absurd piece of public lighting was never before foisted upon the people of any city in the world; and one cannot withstand adding, "its like will never be seen again," concluding with the hope that thereto we may cheerfully say "Amen."

As before intimated it is not our purpose to point out all the "glowing" examples instanced by the lecturer in support of his proposition that America was distancing the older countries in its public appreciation and application of electric lighting methods. It is quite sufficient to let the stories told by the lecturer on the subject experience the weight of the lapse of time. The solidity of that application will be quite sufficient to crush them out of shape, and so let their contained "wind" mingle with the outer atmosphere. What we desire to call particular attention to is this.

It is urged by Messrs. Preece and his associates, so deeply interested in the growth of electric lighting in England, that American electrical promoters are unhampered in one important respect—in so far that high-tension currents may be carried along aerial wires. They are not slow in asserting that perfect insulation is so easily attainable that the danger involved is really *nil*, and that the restricting of conductors beneath the roadways practically debar the electrical promoter from carrying on his business at a profit. The English legislator is slow to act; but at the same time he is also pretty sure, and is therefore not often given to the necessity of undoing that which he has once determined upon. His American brother unfortunately acts in the reverse way, and as a consequence he too often is obliged to devote much of his time in altering and amending the rules and regulations first formulated.

Beyond all doubt and cavil the aerial system of stringing electric light wires (considered without any reference to unsightliness) is disgraceful, hazardous, and positively perilous. The city of New York on two occasions during the present winter season has had ample illustration of the dangers attendant upon the practice. The first of these occurrences was reported in issue of *JOURNAL* for Dec. 16th, 1884 (p. 322), and on the afternoon of Saturday, Jan. 17th, a precisely similar case as the one previously explained was put upon record. Friday, Jan. 16th, was signalized by one of our usual midwinter storms. The thermometer was abnormally high, and a veering of the wind course to the southeast brought on a regular hurricane during the night, which lasted until well on in the afternoon of Saturday. The

"perfect" insulation of the wires was tested by repeated writhings and contortions of a long section which was separated from its fastenings; and the usual result followed. The naked portion of electric light wire made contact with the fire department circuits, and for upwards of an hour fire headquarters was absolutely left without means of communicating a signal to the engine houses of department. New York cannot afford to have its property so imperilled simply because electric lighting schemes may be made to return a profit on the money invested in them. Therefore do we contend that it is better to follow the plan of those who work slowly, even though some special enthusiasts be actually disgruntled to the point of claiming that the march of applied science is thereby throttled.

ANOTHER VICTORY FOR THE SIEMENS BURNER.

The above heading is hardly fair to that energetic gentleman Mr. Stein, who is the presiding and persistent official head of the Siemens Regenerative Gas Lamp Company, of Philadelphia, Pa., and whose alertness in the matter of seizing available opportunities for making plain to everybody what can be done in the way of lighting large areas with gas as the illuminating agent has ever been conspicuous. His successful competition with the electric lighting promoters of Philadelphia, Pa., whereby he wrested from them a goodly portion of the work of brightening the public squares at night, was recounted in the December 16th issue of *JOURNAL*, and so is still fresh in the minds of the fraternity. Of course the victor had good reason to feel elated over the victory; and it must be said of the gentleman that one effect success upon him is to spur him on to "seek pastures green and fields anew," wherein he may still revel in the fruits of new conquest. A celebrated owner of American thoroughbred racing stock is said to instruct his jockeys to "go on in front," and never trust to "a waiting finish," for fear that possibly the "finish" might be "drawn too fine;" and as a reason for such instructions he advances the plea that if his horse *is* "to show the white feather, the animal might as well wave it when in front as when in the middle or the rear of the pack." Friend Stein evidently believes in that theory, for he *does* set out after business as soon as the flag drops; and just put a pin here—when Stein "goes out in front" he stays there. Here is his latest "burst of speed."

All good Cleveland men are supposed to have in contemplation a visit to that inauguration ball that is to take place at Washington, D. C., on the evening of March 4th. The Blaine men cannot really object to this, seeing that about 28 years have intervened since "Buchanan's Ball." The Pension Building having been selected as the place for the dancing festivities, Stein knew very well that the place had to be lit up, and so he put in his "little bid." The electric promoters were hot on the scent, and made a great effort; but our irrepressible heavyweight, following in the wake of all celebrated men, made the "greatest effort of his life," and "carried the day"—or rather the night. On the occasion of the festivities mentioned the Pension Building will be entirely lighted with gas, the contract made calling for the furnishing of 86 five hundred-candle power Siemens burners. The ball-room proper (320 feet long by 125 feet wide) will be assigned 40 lamps; each of the 30 supper rooms (40' by 40') to contain one lamp; the remaining 16 to be appropriately arranged in corridors and at main entrance. This is undoubtedly the most important and largest exponent of public lighting of this sort ever before attempted in the United States, and it is certain to prove successful. What will be Stein's next move? And while we are upon the subject we cannot help thinking that Mr. Geo. A. McIlhenny and the Washington Gas Light Company had much to do with the final issue.

A CONFLICT OF DATES.

From the "Official Notices" appearing in this issue it will be perceived that the dates selected for the annual meetings of the New England and Ohio Gas Light Associations are in unison in so far as the day of month is concerned, thus of necessity giving rise to an unfortunate state of affairs. The fault of conflict cannot be laid to the officers of the older body, as the New England Association has for years held its annual session during the middle or latter portion of February, and consequently had the right of selection. The Ohio Association's action is all the more regrettable after one has read the official circulars, forwarded by Secretary Bate, since perusal of them shows that, if the printed programme is duly carried out (and it is certain it will be), a most fruitful meeting will result. The conflict of dates will keep many an Eastern visitor from attendance at Cincinnati on February 18th. It may be trusted that the Ohio body will take measures to obviate this conflict as to 1886; and we confidently assert that the 1885 sessions of both assemblies will be of benefit to the fraternity at large.

PROMOTED.—At the recent annual election of Directors of the San Francisco (Cal.) Gas Light Company Mr. J. B. Crockett, Jr., was chosen President. Mr. Crockett has for some time past been the efficient Engineer of the San Francisco corporation.

[A Paper read before the Society of Gas Lighting.]

The Proper Ratio of Storage of Gas to Consumption.

By COL. F. S. BENSON.

It was not without experiencing a feeling somewhat akin to embarrassment, that I found myself selected to prepare and read the first paper before you in this new year of our deliberations; and I must confess to a strong impression that my effort may not raise the standard—either of exhaustive calculation or theoretical and chemical research—sufficiently high to afford an example to my associates in the profession; thus losing the somewhat pleasing idea that I might possibly take unto myself the credit of having stimulated them to renewed effort in the preparation of elaborate and finished essays on some of the more obscure points in our common business. But I trust, however, if, failing to accomplish that (and thereby earning the criticism of a few), I shall earn the gratitude of the many, to whom, if I may so express it, the task of writing a paper for this Society on some abstruse question, and afterward submitting the same to the sharp criticism and rapid mental calculation of all, looks like an almost insurmountable, and possibly even a thankless, task.

Interesting incidents and wonderful experiences sufficient to arrest your attention, and important enough to form in themselves at once a novel and exceptional topic, or whose recital would go to make a thoroughly "taking" subject for a paper, do not occur every day, or even every year, to any one of us; and we are therefore obliged perforce to recur to the well-worn theme and oft-told story, so often encountered and so frequently recited on the road that leads from the retort house to the consumer's meter.

Now, to leave the realms of self-abnegation and deprecatory explanation, it undoubtedly has often occurred to us that perhaps our papers, even if lacking many prominent features possessed by finished compositions, or the conspicuous exactness of standard text books outlining and explaining the mysteries of gas manufacture, might accomplish the object of producing a general and animated discussion on some vital and practical point. If this end were achieved, it would seem as though nothing more need be desired. It is with this object in view that I call your attention to the subject of "The Proper Ratio of Storage of Gas to Consumption;" or, in other words, when shall the holder capacity be increased? Of course, it is assumed at the outset that this question is to be considered only in reference to the maintenance of a properly proportioned and well balanced plant; and furthermore a plant situated in a district possessing a healthy annual growth in the matter of output. It seems to me that this is a question sure to arise in the experience of every gas engineer, and one whose claim to pressing attention and careful solution must needs be carefully considered.

I hardly may note that authorities differ in regard to this matter. Clegg states that, given a daily consumption of 305,000 cu. ft., storage capacity for 125,000 cu. ft. is sufficient; Frederick Colyer, in his volume on "Gas Works, their Construction, etc.," insists that the minimum storage capacity should be equal to two-thirds of the largest make of gas per 24 hours; in small works he asserts the storage should be equal to the largest production of any one day in the year—the last proposition, to my mind, being much nearer to the mark than the former. Indeed, I might here state what has become a common answer to this question among our American engineers; their prevailing reply being that a holder capacity of 75 per cent. of largest consumption in 24 hours is proper and sufficient.

The duty of stating the necessity, as also making requisition, for an increase in holder capacity naturally enough falls to the engineer; and with this duty is inseparably connected that of *explaining* the necessity, by the advancement of proper and cogent reasons for such request. How much better, then, is it in such situations to have your arguments backed up by those adopted beforehand through the combined wisdom and practical experience contained in a Society like this, rather than to depend entirely or partly on the text books—for these, even at their best, can produce but a theoretical suggestion.

That it is a question of *economy* alone in manufacture is to be very gravely doubted; safety also is involved, since circumstances might arise necessitating a stoppage of the plant for the making of unexpected repairs at a moment when, with small holder capacity and large consumption, this cessation of manufacture would endanger the supply; and, warned by history, we all know these vexatious accidents have a most unpleasant faculty for happening at the most inopportune seasons. Different locations, too, in regard to the class of consumers supplied, etc., have much to do with this question of holder room; and perhaps a rule that would apply to and govern a majority of cases might be utterly useless in its application to a small minority.

Take, for instance, a large manufacturing town, containing many woolen or cotton mills kept in operation until 8 or 9 o'clock P.M. for six nights in the week. Under such working necessity the gas engineer is placed at the disadvantage of being obliged to send out a large quantity of gas during a period lasting but a few hours; and when the mills close down for the night the demand for gas becomes almost *nil*. It seems to be unnecessary to note

that in such a case, both for safety and economy, a greatly increased storage capacity would be required over that found sufficiently ample in situations where the consumption is more equably divided over the entire evening.

In looking the matter over, then, as carefully and as intelligently as possible, I have come to the conclusion that the safe and economical ratio of proportion is to have a storage capacity equal to the average consumption of heaviest month's send-out in the year—which month, in this part of the country at least, may undoubtedly be set down as December; and I may here add the corollary, when such consumption exceeds the holder capacity it is high time for the engineer to agitate the matter of a new holder, with the understanding that part of the "agitation" will be directed toward setting the time by which the holder is to be completed at a period sufficiently early for the following fall and winter's business.

With such a rule carried out we should not be in doubt about "giving up" a bench when the consumption begins to decrease; whether or not it would be best to "let it down" permanently, instead of "holding on to its use for a few days," all on account of fear that "dark weather" might occur, and thus "run short" of gas. On the other hand, to chase away all such conflict of doubt and fear, should the engineer decide not to take the "chance of letting down the bench," why, he accepts the other alternative of "missing" from 6 to 30 retorts each 24 hours, through lack of storage room; thus woefully adding to the percentage of "unused retorts"—so damaging to the figures expressing "average production of gas per man," and "gas per bench under fire;" both important factors in the cost per thousand cubic feet.

Such a ratio of holder capacity would also, in most cases, admit that minor or major repairs be made at any hour of day or night, even if the repairs necessitated the stoppage of the works for a short time, without vitally endangering the supply.

The gas engineer is often confronted by one or more of his directors with the query, "Can you not get along with your present holders?" even when the storage room is far below the proper one; and to the query he is obliged to answer, "Yes, we *can* get along;" and he would have to respond similarly had he but 50 per cent. of holder room as compared with his consumption, because it *could* be done—but only at an expense of both safety and economy.

Is it not better, then, to establish a hard and fast rule—one to which we can agree unanimously—as to where the proper proportion lies; and, further, when once agreed upon, to assume any deviation from it to be an evidence of poor economy and poor engineering?

The Boardman Hydraulic Main.

The improvement in hydraulic main construction herewith presented to the notice of the readers of the JOURNAL is a result of the practical studies and continued experiments of Mr. A. E. Boardman, of Macon, Ga. The inventor, in common with his brother engineers, has experienced considerable difficulty in the matter of handling the accumulation of heavy tars which so often bother the gas manager working under the high and steady heats obtained by the use of the modern regenerative furnaces; and his device is designed and applied with the idea of affording an easy means for facilitating the removal of these heavy tars, to the end that the frequency of stopped stand pipes may be diminished.

The illustration represents a transverse section of the hydraulic main through center of one of stand pipes. The stand pipe, *E*, enters the side of

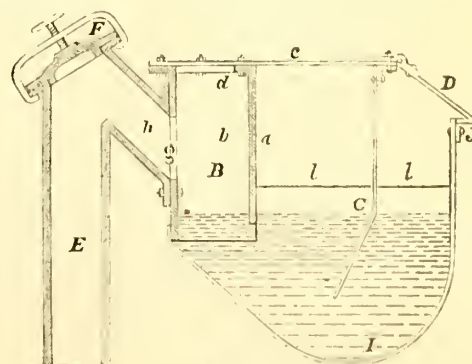

dip pipe, *B*, through the inclined bridge pipe or branch, *h*, and opening, *g*. This stand pipe is furnished with a removable cap or lid, *F*, to allow ready access to stand, bridge, and dip pipes for their easy cleansing. The dip pipes, *B*, instead of being independent vertical ones, as usually constructed, are preferably built in the shape of a rectangular box divided by vertical partitions into separate compartments, one for each retort in the setting. The lower ends of these compartments are, of course, open, being sealed by the ordinary water seal, while the tops are covered by the top plate of the

main, *c*, and bolted to it by the flanges, *d*. The partitions separating the dip boxes extend two or three inches below the rear wall, in order to prevent the gas from passing from one to another—an occurrence which, under certain conditions, might otherwise ensue. The lower edge of the rear wall, *a*, beneath which the gas passes to the body of the main, should be serrated, so as to reduce to as slight degree as possible the oscillation of the gas in the retorts.

The bottom of main, *I*, is inclined down and away from the dip boxes, so that the tar as formed will drain rapidly to the lowest point near the back of the main. The rear of main extends some distance up above the water line to the point, *J*. The apron, *C*, extends the entire length of main and to a certain depth in the water, so that, by no possible chance, can the gas issuing from the boxes, *B*, escape into the cleansing compartment.

The cleansing compartment is located between the apron, *C*, and rear of main, *J*, and is closed by means of the movable top or cover, *D*. This cover may be opened at any time, and whatever tar may have been accumulated can be removed through the opening or pulled along toward the tar pipes at ends of main, the choice of displacement method depending entirely on the will of the operator.

Division plates, *t*, may be inserted, extending a trifle above the normal water line, with the effect of dividing the entire main length into as many sections as are deemed desirable, to the end that the lowering of water line during the operation of cleansing any one section will not unseat the dip boxes in another. If the divisional plan be followed each section, of course, would require to be provided with tar and overflow pipes.

The ease with which every part of a main on the Boardman plan can be reached and cleaned, without in the least interfering with the make of gas; the single change in the direction of gas flow during its progress from the retort to the main; the solitary cap to be removed in order to clear the stand, bridge, and dip pipes of obstructive accumulations; and the one and only place where leakage has to be guarded against, are points of excellence which are well qualified to attract the attention and commend themselves to the notice of every gas engineer.

Those who have experienced the aggravating annoyances connected with the deposits of heavy tar in their hydraulic mains (where is the manager who can say he has not at some period battled with the nuisance?), along with the consequent more frequent stoppages in stand pipes; and also those contemplating the adoption of regenerator furnace systems, with the view of obtaining a productive duty of from eight to ten thousand cubic feet per retort in 24 hours, would do well to examine into the merits of this improvement in hydraulic main construction. We might add that Mr. Boardman has had the plan in use at his Macon (Ga.) works for some time back, and the arrangement has fulfilled his expectations in every particular.

Gas Heat for Mechanical Purposes.

By T. J. C.

Gas-Heated Bakers' Ovens.—In continuation and conclusion of the subject treated of in the last issue of the JOURNAL, the first portion being devoted to a description of the Thompson Brothers method of firing gas kilns, it is herewith proposed to make some mention of the Thompson plan of heating bakers' ovens by gas. It is undoubtedly admitted now that the gas-heated kiln is a perfect success; and this verdict has perforce been rendered because of the satisfactory and long continued practical working results obtained by those who have adopted the system. This in itself constitutes a great stride in advance toward bringing the gas maker directly within the pale of a manufacturing territory hitherto exclusively occupied by the seller of solid fuel, and that such a step has been achieved affords neither a mean nor narrow reason why congratulation should be indulged in on the part of the gas engineer. But while this advance has been registered, it must still be borne in mind that the manufacture of artistic glass goods is rather restricted, in so far as certain localities must of necessity be chosen as centers of such production, and that one of these centers is still further able to supply a wide extent of territory blessed with a numerous population. Remembering this, then, only the gas maker of the favored center of glass manufacture will be especially benefited by increased send out, and it is on that score one is disposed to assert that the successful introduction of the gas-heated baker's oven would be more generally beneficial to the gas industry of America, since every city, town, and even hamlet in the country may safely be counted on to contain some sort of a baker's establishment. Indeed, remembering the multiplicity of bakers' ovens, it would not appear at all unreasonable to assume that the future consumption of gas will be greatly augmented by the aid of gaseous firing as applied to the trade of the baker.

Almost every one is at least in some degree familiar with the present practice of heating the baker's oven, and can appreciate the filthiness and uncouthness of that practice. Coal-heated ovens are cumbersome, costly and dirty; and the ovens heated by wood fuel are absolutely filthy. The oven mouthpiece is opened, chips or shavings or billets of wood are thrown upon

the tiles, the collection is set fire to, and the process of heating begins. When the required temperature is supposed to be attained the rakes are resorted to, and the tiles must be "swabbed out" with a mop. In short, the wood fuel plan may be classed with many another practice as belonging to the barbaric age. Smoke and soot, dust and ashes, all in abundance; irregularity of heat, uncertainty of working—it is a wonder that it has survived so long. The anthracite-heated oven, while far from cleanly, is a most expensive method; and in fact it is a very easy matter to determine the situation of such an oven by inspecting the flagstones in front of a bake shop during the progress of a gentle fall of snow with the thermometer, say, at 32°. The observer may note that the falling flakes melt almost as soon as they make contact with the footway of the sidewalk. It will hardly be considered an economical action on the part of the manufacturer of the "staff of life" to keep the pedestrians' way clear of snow through the agency of his oven; but this, in effect, is one thing that he does accomplish.

One of the chief advantages claimed for the Thompson plan of gas heating for bakers' ovens is that the heat is saved, or rather it is directed to the oven proper, and not wasted or spent in raising the temperature of an immense mass of masonry. It is not the intention of the writer at the present time to give any extended description of the Thompson oven, the purpose being to attract the notice of the fraternity to the fact that a principle has been devised whereby the problem of such application of gas firing has been at once successfully and economically made, and which has already been extensively carried out in England. However, to give some idea, imperfect though it may be, of the Thompson plan, it might be said in general terms that the principle is quite similar to the one involved in the Thompson gas-fired kiln. The inventors recommend that for continuous baking, such, for instance, as the case of a combined confectionery and bread baking establishment, the externally heated oven be employed. Suppose you were looking at the exterior front wall and mouthpiece of a baker's oven; at the base of wall and near to each end are situated suitable compartments or boxes communicating directly with oven interior, sunk to a slight depth below floor tiling of oven. In these compartments are placed the burners (the supply pipes to which are brought down over front wall) intended to supply the heat. When the heated air current begins to move it ascends close against interior front wall of oven, reaches the arched roof, rolls along its top, strikes back wall, and descends again to oven floor tiles. Here it enters a space communicating with or leading to a series of flues running lengthwise underneath oven tiles—the number of these flues is determined by size of oven—when the current forces its way back to point of starting, and thence out through flue connection to chimney.

For intermittent baking, or in such instances as where but one or two batches of bread are to be provided for, it is recommended to employ the internal plan of heating, which is similar in principle to the other, differing therefrom only in the disposition of the lengthwise flues. The system is really an adaptation of the regenerative principle of firing.

None of these ovens have as yet been put up in the United States, but a contract has been made with a "Vienna" Baking Company, of this city, for the erection of an oven 12' x 10' inside measurement. When this shall have been placed in successful operation more will be said about it.

As before intimated, a number of them have been working for some time in England, and to show some figures relative to their economy it may be here mentioned that not long ago (early last December) the writer was shown a letter received from the proprietor of a large baking establishment located at Leeds, England, in which it was stated that on a then recent occasion the oven (9' x 8' inside) had been in steady working from 8 A.M. until 6 P.M.; the bakers had "come on" at 6 A.M., gas was turned on with their arrival, and shut off at the end of two hours, when cooking was commenced and proceeded with until 1 P.M.; then, requiring more heat than usual, on account of extra work, gas was again turned on until 2:15 A.M. The gas was "on" for a total of 3½ hours; and the total consumption required to keep the oven at working heat during the period of 10 hours was 585 feet; and it should be here added that the oven was, even at the end of that time, quite ready for further effective duty.

[OFFICIAL CIRCULARS.]

First Annual Meeting of the Ohio Gas Light Association.

[We cheerfully accord space to the following "official circulars" containing important information for the Ohio fraternity, and the fraternity at large as well, concerning the first annual meeting of the Ohio Gas Light Association. The circulars explain themselves.]

CIRCULAR No. I.

OFFICE OF SECRETARY OHIO GAS LIGHT ASSOCIATION, }
TIFFIN, OHIO, Jan. 19, 1885. }

To Mr. _____, of _____ Gas Company,

DEAR SIR:—During the past summer a number of gentlemen connected with the gas interest of our State met in consultation, having for their object

the organization of a State Association of Gas Superintendents and Managing Directors. It was decided to send out such number of circular letters as would be sufficient to show by the reply of parties thus addressed whether a State Association was considered desirable by the practical men engaged in the gas business.

These letters having been received for the most part with favor, a call was then made by circular for a meeting to be held at Columbus, Sept. 17th. This met with a hearty response, and forty names were placed on the roll. An organization was at once effected, officers chosen, and, after a most profitable session, the meeting adjourned. The regular Annual Assembly of the Association will be held at Cincinnati, on the third Wednesday of February, 1885.

The attention of superintendents is especially called to the fact that during the discussions at Columbus the *scientific* subjects were neglected, but a most animated and profitable handling of the more practical details was had. And in this connection we wish to suggest that as each superintendent or managing director is constantly meeting with something new or troublesome in the daily management of his works, and as all such matters are of interest to the whole fraternity, it is desirable that all interesting details or incidents be written up with such remarks or inquiries as the writer may wish to make, and the communication forwarded to the Secretary of the Association. He will arrange such papers, and submit them to the Executive Committee for inspection.

It is believed that if every one who has any question to ask, or information to impart, on any subject connected with the daily workings of a gas works, will thus place the matter in shape for discussion, the Association at its next meeting will not lack in interest.

No gas superintendent—no matter how small his works—but has a varied experience. If he has nothing to give he certainly will find something which will be of benefit to receive, and all is freely given.

Your attention is earnestly called to this matter, and it is hoped you will at once send in your application for membership. The entrance fee is \$3.00. Annual dues \$2.00.

Let us have a representative from each of the eighty gas companies of Ohio at our February meeting.

This Association is not expected to interfere with the interests of the Western Association, but to bring together in closer fellowship the working brethren of our State, and for the general good.

OHIO GAS LIGHT ASSOCIATION,
JOS. BATE, SEC'Y.

CIRCULAR No. II.—*Notification from Executive Committee.*

OFFICE OF SECRETARY OHIO GAS LIGHT ASSOCIATION, }
TIFFIN, OHIO, Jan. 19, 1885.

To Members of the Association, and all Practical Gas Managers in the State:

The Executive Committee of the Association wish to call your attention to the fact that the First Annual Meeting will be held at the Burnett House, in Cincinnati, Ohio, at 9:30 A.M., on the 18th day of February, 1885.

They have selected the following subjects for discussion, and expect to have short papers prepared on each by the members to whom the several subjects shall be assigned. It is earnestly desired that *all* the members will endeavor to be prepared to discuss all matters thoroughly and intelligently, so that our First Annual Meeting may be most profitable.

Subjects:

- 1—The prevention of naphthalene as a deposit in gas works plant.
- 2—How to prevent tar passing into purifiers.
- 3—The use of gas stoves as a means of increasing the consumption of gas.
- 4—Natural gas; what is it, and can it become a competitor of coal gas as an illuminating agent?
- 5—Does it pay to use any lime in connection with oxide of iron?
- 6—How much coke is lost as screenings after being crushed, and what advance should be added to price of coarse coke to make crushed coke equally profitable to sell by gas companies?
- 7—What plan or system is the best for finding leaks in lines of gas mains, and what is the best joint for gas mains?
- 8—What percentage of the loss of gas is due to leakage, and what to condensation?
- 9—What is it that obstructs the service pipes to lamp posts and to consumers in extreme cold weather, and is there any way to prevent this annoyance?
- 10—How can the form of the retort or the manner of setting the same be improved?
- 11—Gas vs. coke for heating retorts.
- 12—Regenerative furnaces.
- 13—Do we gain any heat or save any fuel by passing steam through our grate bars?
- 14—What is the loss in weight of coal from a storage of six months, or the

difference between weights of coal when put into coal house and weights charged into retorts?

As all the above subjects are of great practical importance to all gas managers, it is hoped there will be a free discussion of all.

A. HICKENLOOPER,
JAMES RAYNOLDS,
P. W. HUNTINGTON,
A. S. BUSHNELL,
H. J. REINMUND, } Exec. Com.

JOS. BATE, Sec'y.

[From Journal of the Society of Arts.]

On the Use of Coal Gas.

By HAROLD DIXON, M.A.

[In accordance with statement made in issue of JOURNAL for Jan. 16, we reprint below the second lecture on this subject delivered by the author before the Society of Arts, London, England. The date of its presentation to the Society was Monday, Dec. 8, 1884.]

LECTURE II.—COAL GAS AS A SOURCE OF LIGHT.

When last I had the privilege of addressing you I mentioned that the diffusion of lighter gas into denser air through a porous diaphragm might be made use of for determining whether there was an escape of gas in a room; that the lighter gas, passing more quickly through a porous diaphragm than the heavier air got out, would increase the pressure inside the vessel, push down a column of mercury, make metallic contact with a battery, and ring a bell. Since last week I have received one or two letters on this subject, and, thinking it might be of interest, I have put up a rough apparatus to illustrate how such an instrument as I have described might be made. Instead of having a straight arm, in which a colored liquid, such as a solution of indigo, is moved, I have connected with the porous vessel a bent U-tube, with mercury in the bend. There is a platinum wire sealed through the glass tube, which I can connect with the wire from a battery; a wire also passes down the open end of the tube, and may be placed at any distance from the top of the column of mercury. If I connect up, and let a little coal gas escape close to the porous pot, the gas immediately diffuses through the pot more quickly than the air can get out; the pressure is increased inside, the mercury is pushed down in the arm connected with the vessel, is pushed up in the other arm, and metallic contact is made between the mercury and the platinum wire. Immediately the battery circuit is completed, a bell at the other end of the room announces the escape of coal gas from this pipe.

I pass on now to the subject proper of my lecture this evening—the use of coal gas as an illuminating agent. We saw last time that, of the components of coal gas, only a small part, by volume, contributes to the light; that the carbonic oxide, hydrogen, and marsh gas, which made up some 95 to 97 per cent. of the whole, contribute barely anything to the light given by the gas flame; that the other constituents, the ethylene or olefiant gas, and the other gases of the same type as ethylene (the olefines), and the benzene and the naphthalene, are the gases whose burning gives light in the flame. Now, the light is due to what may be not inaptly called a selective combustion. When coal gas is burnt in air, and care is taken that the gas does not mix too quickly with the air, but comes into it gradually, the hydrogen of the hydrocarbons burns before the carbon. Let us take ethylene as representing the luminiferous constituents of coal gas; each molecule of ethylene is composed of two atoms of carbon and four of hydrogen, and chemists write it C_2H_4 . This ethylene, when it is raised to a high temperature in contact with air, is decomposed, the hydrogen burning first and the carbon afterward. There is a race for the oxygen of the air between the two constituents of the ethylene, and the hydrogen, being the fleetest of the two, gets to the oxygen first and is burnt to water. So for a short time the carbon of the ethylene is unburnt, and is separated from the hydrogen. It aggregates into little solid particles, which are raised to incandescence by the burning gases around. The carbon then, in its turn, reaches the air outside of the flame, and burns to carbonic acid. If we wish, then, to get light from coal gas, we must burn it in such a manner that the hydrogen burns first and the carbon afterward.

Before I go on to show the particular burners which have been devised by many skilful hands to gain this object—the selective combustion of the hydrogen before the carbon—I will burn a sample of coal gas which has been deprived of the luminiferous hydrocarbons by treating it with Nordhausen acid; and to compare with that I will take some ordinary coal gas, and burn it in a similar vessel. In these two vessels, then, I have a sample of coal gas which has been treated with Nordhausen acid (and so deprived of the luminiferous hydrocarbons), and a sample of ordinary coal gas. When I burn them, you see the difference in illuminating power is very well marked. In one case you have a flame with more or less light in it, due to the separation of carbon; in the other you get no light at all. In the latter case the coal gas has been deprived of the three or four per cent. of ethylene and luminiferous hydrocarbons by the Nordhausen acid.

I will try another experiment with ethylene, to show you an example of selective combustion. With this ethylene I will fill this glass cylinder one-third full. I will now take another gas—chlorine—and fill up the cylinder with it, so that in this way I get a mixture of two volumes of chlorine and one of ethylene. Now I apply a light. I ask you to look at this deposit of carbon. The mixture of ethylene and chlorine is perfectly transparent; but as the flame ran down the cylinder the chlorine effected a selective combustion. It took the hydrogen only and left the carbon. The carbon is left in this finely divided state, and the whole of this cylinder is now filled with this fine smoke—little solid particles of carbon—because the carbon has not the same affinity for chlorine that hydrogen has.

A selective combustion, similar to this but not selective in so marked a degree, is shown when coal gas is burnt in air. The hydrogen has a stronger affinity for, and is quicker in burning with, the oxygen of the air than the carbon is. The latter gets left behind, just as it was left behind in burning with chlorine, only there is this difference—that in the case of the chlorine the carbon was not burnt at all, but was all left behind; whereas in the case of ethylene burning in air, or coal gas burning in air, the carbon is finally burnt.

Through a bye-pass in this lamp I am now passing some ordinary coal gas. It burns with a luminous flame, giving a light, perhaps, of some seven or eight candles—certainly not more. You notice that if I turn on the gas too full we get this roaring of the gas flame, of which I shall have to speak more fully directly; but I now turn it down, so that it no longer roars or flares. The flow of gas can be turned through the body of the lamp, where it passes over some condensable hydrocarbons, and then you see the gas mixed with these hydrocarbons gives us a very much whiter flame than ordinary coal gas. This lamp illustrates the effect which these hydrocarbons have on the illuminating power. Now, since it is entirely due to the small quantity of ethylene and other hydrocarbons that we get light from coal gas, their proportion is, of course, a matter of great importance. Anything in the process of gas manufacture which will add to the volume of ethylene any other hydrocarbons will increase the value of the gas; and the best way for determining the value of a sample of coal gas is to determine the volume of olefines which it contains.

This lamp will also illustrate another point, and that is the effect of pressure on the burning of coal gas. You see if I turn the tap on full, there is now such pressure at the burner that we get this roaring flame, and very little light from it; not nearly so much light, you will notice, although the flame is longer, that there is when I turn the gas down and burn less. We get a better light with a steady flame than we do when it is roaring. Now I will turn the tap down and regulate the gas supply until it burns with a quiet flame; then, by quickly turning this tap round, I can make the gas pass over the hydrocarbons. The gas will then become mixed with some of the hydrocarbon vapor, and you will see that, although it is burning under the same pressure, it will no longer burn with a quiet flame. Turning off the gas from the hydrocarbons, there is a quiet flame with the same pressure of gas. It is evident, then, that coal gas must be burnt with a due regard to pressure; a rich gas must be burnt with less pressure than a poor gas to get a steady light.

Now, pressure chiefly acts in this way: With a high pressure the gas is forced out quickly from the small orifice of the burner, and so mixes with the atmosphere before it burns. But there is also another thing. When gas issues quickly from an orifice, it forms what we may call whirlpools of gas, and burns irregularly on this account. I do not know, and I do not think anyone has yet explained, why coal gas which has passed round a corner suddenly, like the corner of a gas tap near to the burner, should burn with an unsteady flame some six or eight inches off; but such is the fact. The coal gas in passing round the corner suddenly seems to be thrown into eddies, and it is a long time before it steadies down to a regular flow. Why it should be so long I am quite in ignorance, but there is the fact; so that, if you have a tap close to the burner, and the pressure is too high, and you try to reduce the pressure by turning down the tap, you will very often get such an eddy produced, and a flickering flame is the consequence; so I recommend, in all gas burners in a room, that the tap should be placed some two or three feet off the burner. In that case, in spite of the gas running past the sharp edge of the tap, it has time to steady itself down into its normal flow, and burn with a steady flame.

I have here an ordinary gas burner—a fishtail—and I have connected it with a bag containing coal gas. By suitable pressure on the bag, we can drive out the gas at any rate we please. I am increasing the pressure now, but however much one increases the pressure, even to making the gas roar, one does not increase the light one gets from it. The gas is forced out into the air and mixes with it; the rush of gas produces a partial vacuum in the immediate neighborhood of the orifice, the air is drawn in and mixes with the gas, and the two burn together with this blue, almost non-luminous flame. Here is another burner, connected to the same supply pipe. In the one case we have the gas pouring straight out into the atmosphere, un-

checked in its flow; in the second case we have a governor placed between the gas pipe and the orifice where the gas issues into the air. This governor checks the flow of the coal gas, and only allows a certain quantity to pass. The effect is that the flow is regulated and maintained at that rate which is found to give the best light for the particular sample of coal gas used. While one flame roars and gives but little light, the other continues to burn steadily and well. Now, unfortunately, in all gas supplies on a large scale one cannot get rid of inequalities of pressure. Some houses are on higher ground than others, and of course, owing to the lightness of coal gas, they have an excess of pressure. Again, when large quantities of coal gas are being consumed, as in the evening hours, the pressure has to be turned on in the gas works, and sometimes—until the consumption reaches its maximum—there is an excess of pressure in the mains. Now, with a governor such as I have shown you here this roaring and wasting of the gas is completely got rid of. I will not go so far as to say that every burner in a house must necessarily have a governor, but I think a governor should be placed on each floor, which will regulate the flow of gas to all the burners on that floor. But the burners with which one is more particularly concerned—those in our sitting rooms and dining rooms—should each have their separate governor. By this means one gets a steadier flame, and one burns the gas to greater advantage.

We may say, then, that the first requisite for obtaining a good artificial light from coal gas is that the flow of gas into the air should be regular and as slow as possible. Several contrivances have been elaborated to produce this result. Some are complicated, and some apparently quite simple; and I may say that the simple ones seem to me to work nearly as well as the more complicated. Here are two different kinds. In the one there is a large chamber introduced into the burner below the orifice; into this chamber the gas passes through a small hole. The hole being smaller than the orifice through which the gas finally escapes, the gas rushes through the small hole into the chamber, and then passes slowly out through the orifice. The other plan is to have a movable diaphragm just below the burner, which is pushed up by the pressure of the gas. Whenever the pressure of the gas below this diaphragm is greater than the pressure above, by the weight of the diaphragm it moves up and partially closes the orifice through which the gas escapes. Such is the form of governor used in Mr. Sugg's burners. A piece of steatite is pushed up by the gas, and partially blocks the hole from which the gas escapes into a chamber below the burner; so that, if the gas is running in under a greater pressure, the diaphragm is pushed higher up than when the gas is running in under a smaller pressure; consequently, with the greater pressure the hole through which the gas can escape to the orifice is smaller than in the other case; so that the same quantity passes to the burner, whatever pressure is used. I have not time to describe all the various forms of governors that have been devised for limiting the flow of gas; I merely describe these two types, for all others depend, I think, upon the same principles—either the filling of a large chamber through a small hole, or else the movement of some diaphragm which checks the passage through which the gas is flowing, like the throttle-valve of a steam engine.

Now, the second requisite for obtaining a good light from coal gas is that the supply of air should be steady, regular, and slow to the gas flame. We have seen that it is necessary to have the supply of gas steady and slow, and we find the same thing is true of the supply of air.

Now, with a flat-flame burner in the air without a chimney, it is not easy to get the supply of air regular. One of the devices which have been adopted with very considerable success, I think, is to make a little projecting ridge all along the top of the burner. Mr. Sugg calls this the table-top burner. This ridge prevents the air which is rising to feed the flame from impinging too directly on the flow; it is spread out a little by this ridge, and so meets the flame a little further up. Another successful device is due to Mr. Geo. Bray. Mr. Bray has checked the flow of air in the flame. He has placed a metal shoulder on each side of the burner, and the air is thus prevented from coming in contact with the edge of the flame for some considerable distance (about an inch) on each side of the central orifice. I light this burner, and you notice how the flame hugs the shoulder where the air is prevented from impinging against it by this metallic projection. In this way a very broad flame is obtained. The difference in illuminating power between these two—the "table-top" and the "shoulder" burner—is, I think, inappreciable. In the few experiments I have made on their illuminating power I found this burner of Mr. Sugg's to give slightly the better duty, but the difference was so small as hardly to be appreciable. The shoulder gives a little broader flame, and the other, I think, a little intenser light. Each of these gas lamps consists of a cluster of three burners, and in these clusters we have another principle coming into play—first recognized, I believe, by Mr. Bray—the augmentation of the heat of one flame by the heat of others. If we have one flame burning in the vicinity of another the two will give out more light together than they do independently apart. The sum of the two lights is increased when they are burning close together.

That is owing, first of all, to the air which passes up between the flames being heated by radiation; and, secondly, the gas itself is heated by radiation from the other flame. To put it in another way, which really comes to the same thing, the radiation from one flame is stopped by the other flame, and, therefore, each is hotter. Now these flat-flame burners have been very much improved in the last few years, so much so that there is not much difference now between the light which can be obtained from them and from the Argand burners, where the gas is burnt in a round ring under a chimney. There is one point about these flat-flame burners which I should like to call your attention to, for I do not know that it has been studied particularly by photometrists, that is the transparency of a gas flame to the light of another gas flame. In an Argand burner we have a ring of flame, so that the light from the further portion of the flame has to come through the nearer portion before it reaches us. Now it is certain that there is some loss here, but I do not know that there has been any accurate experiment made as to the loss which light suffers by going through a gas flame. I have come across one or two determinations of the illuminating power of such a flat flame as I have burning on the table—first taken from the flat side, and, secondly, taken edgewise. The difference in illuminating power is found to be considerable. I have some figures here of experiments which Mr. Harcourt made about a year and a half ago. He found that the light from a flat-flame burner was about 33 per cent. less when it was put edgewise. That is to say, if you call the light given from a flat flame 100, he got about 67 for the light coming from the edge of the flame. The flame is evidently not transparent; but I was surprised to find that the transparency is so small as it is. I made an experiment last week of this kind. An inch and a half in front of a flat-flame burner I placed a metallic diaphragm with a slot in it. I measured the value of the gas flame seen through the slot with Mr. Harcourt's pentane photometer. Next I lit a second gas flame an inch and a half further off—that is to say, three inches from the slot, and I measured its illuminating power independently. I then lit the two together, and measured the light from the two. Now, if the first flame had been perfectly transparent to the second flame, the light I should have received when burning both flames would have been equal to the sum of the two lights taken independently, but that was far from the case. In one experiment I found a loss of 24.7 per cent., and in the second case a loss of 25.4 per cent. So that we may take it that a flat flame of the thinness you see here obstructs the light from another flame to such an extent that only three-quarters of the light from the second flame gets through. The bearing of this on the relative merits of the flat flame and the Argand is at once seen. In the Argand you depend greatly on the transparency of the flame, because a great part of the flame is hidden from you by the flame in front, whereas in the flat flame it is not so. The flame is spread out over a large surface, and the light only suffers absorption in the plane of the flame.

There is another burner, also a flat-flame burner, surrounded by a globe, about which I have a few words to say. I think coal gas as an illuminant would be much more popular with English people if the makers of the globes which are commonly sold had been persuaded, or could be persuaded, to make the openings through which the air enters just about double as large as they have made them. One is accustomed to see in one's friends' houses, almost without exception, a globe with an opening as small as 2½ inches. Openings of 2 inches are quite common, and I have seen them as small as 1½ inches. Now, what is the effect of such a globe with so small an opening on the burning of gas? The air comes in with a rush to the flame, and is thrown into eddies, in pouring through such a narrow orifice. Consequently the flame is thrown first on one side, and then on the other, and it is in a continual state of flickering, always on the quiver, never still for half a second. It is this continual flickering when one is reading that is the chief objection to coal gas as an illuminant, as we find it in most houses. The flickering is entirely got rid of if you only have the opening big enough. Here is a burner on the table supplied with a governor, and with a globe with a large opening—3½ inches, nearly 4 inches across, so that the air can pass into the flame with a steady flow; it is not thrown into eddies, and does not agitate the gas. Such a burner as this does not burn any more gas than a burner surrounded by the globe with a small opening.

If we want to get the best light possible from the consumption of a certain quantity of coal gas, the way to do it is to burn it in a lamp with a chimney provided with a damper; for by this means we can regulate the supply of air to the flame so as to give it just that quantity which burns the flame with the maximum quantity of light. Now the maximum light is given just below the point at which the flame begins to tail up and smoke. One should stop just short of that, and the way to do it is this: Turn on the gas and get your supply—five feet per hour, or whatever the burner is constructed for—and then turn down the air until the flame just does not smoke. In that way you get the best light from a coal gas flame.

I have here what is known as the London Argand burner; it has a ring of steatite pierced with a number of holes, through which the gas comes in little jets, which very soon coalesce into a bright ring. Then, surrounding

this ring, placed a little lower than the burner, is a metal cone which causes the air passing in at the bottom of the burner to impinge upon the flame. On the same stand I have another burner in which this Argand principle, if I may call it so, is further developed. There are two rings through which the gas is burned, one inside the other, and the air passes up between the two. We have, in fact, a double Argand. The chimney has a shoulder which compresses the two annular flames. This burner requires to burn some little time before it gives a steady flame, but when it has been burning for some ten minutes it gives an exceedingly intense light, especially in the lower portion of the flame. I will leave this burning so as to get warm. The London Argand does not require any manipulation. Sir James Douglass' double Argand requires to be burned some little time before it develops a maximum quality of light, and the flame should be turned up after it has been burning a little while.

Mr. Sugg has also made Argands with more than one ring. Here I have a very fine burner with two rings and a straight chimney. You notice the chief difference between the two burners in this: Whereas Sir James Douglass has placed a conical chimney over the flame, so as to throw the air against the outside of the flame, and so compress it, in Mr. Sugg's burner the chimney is straight. It gives a very large, steady flame, but I think, on the whole, it is not so intense and white a flame as one gets from the burners of Sir James Douglass. There are, of course, many varieties of Argand burners; I could not show you all; I have only taken such as appeared to me to be the most characteristic, and, I may add, among the best that are made.

Of regenerative burners I propose to show you one—that of Mr. Bower. It is, I believe, an improvement on the Grimston burner with which I was acquainted some few years ago. By the kindness of Mr. Bower I have this lamp suspended here in the corner of the room. The lamp is what is known as a reversed regenerator—that is to say, the flame is at the bottom; the products of combustion pass up through a series of iron chambers and pass away through a pipe, and the air which feeds the lamp is drawn down past the iron chambers through which the products of combustion are passing away, and therefore is strongly heated up before it reaches the flame. The iron chambers above the flame when it is turned up become red-hot. Below the lamp is placed a glass shade to prevent the outer air reaching the flame; but Mr. Bower has found that the lamp is improved by allowing a little air to enter. He accordingly has an adjustable valve by which air can be admitted to the flame—there is a screw by which the quantity of air so entering can be regulated—and this air impinges on the lower surface of the flame. The hot air passing down through the regenerators strikes on the upper surface of the flame, whilst the cold air only strikes on the under surface. The reason for this arrangement is, I believe, that in the old Grimston burner, where no cold air came in, the glass shade underneath got exceedingly hot, and always got dimmed, as if a deposit formed upon it. Perhaps this was owing to the glass becoming partly devitrified. But with this system of admitting a little cold air, Mr. Bower tells me the dimming does not occur. I have not yet had an opportunity of experimenting with this the latest form of the Grimston lamp, but I am assured that it gives a duty—that is to say, an illumination per cubic foot of gas burned—of something like seven or eight candles; if so, I can only say it is a most marvelous lamp, and I look forward with great interest to measuring it photometrically.*

About the relative merits of coal gas, oil and electricity as illuminants, I do not propose to speak to you this evening; I am only concerned with coal gas itself; but I have written up on the blackboard a few statistics concerning the cost of artificial illumination, for which I must apologize if they are out of date. In the first column are the names of the illuminants; in the second column the price per lb., per gallon, or per 1,000 cubic feet of the illuminating material; and in the third column the cost per hour of lighting a room of moderate size well—that is, giving it an illumination of 25 candles. The table was drawn up from the results of photometric experiments by Mr. Vernon Harcourt:

	Per lb.	Cost per hour.
Spermaceti candles.....	—	9½d.
Stearine.....	—	4½d.
Sherwood wax.....	—	2½d.
	Per gall.	
Alexandria oil.....	1s. 10d.	½d.
Colza oil (in moderator lamp)....	4s. 0d.	1½d.
	Per 1,000	
Flat-flame gas burner.....	—	½d.
Large Argand “.....	—	½d.
Siemens regenerative burner....	—	0.2d.

*Since this lecture was delivered I have tested the 25 feet Bower lamp by Mr. Harcourt's pentane photometer. The light given by the burner in a horizontal plane, burning 27.1 (corr.) cubic feet of 16.5 candle gas per hour, was equal to 182 candles. This is equal to 6.7 candles per cubic foot, or 6.5 candles per cubic foot of 16 candle gas. The cost of obtaining an illumination of 25 candles from this burner, burning 16 candle gas, would be 1-7d. per hour. I must add that below the horizontal plane the intensity of the light increases.

I will now show you a still more brilliant gas burner at the other side of the room. One purpose for which a very brilliant light is required is for the beacons on our coast which warn sailors when they are approaching the shore, and guide them through the tortuous channels round our island. Of these burners those invented by the engineer of the Trinity House—Sir James Douglass, and those of Mr. J. R. Wigham, of Dublin—rank in the first class. This burner of Sir James Douglass is burning ordinary coal gas here, but it was devised to burn a richer cannel gas. In it the Argand principle has been repeated six times; we have six rings of flame, one outside the other. Each ring has a separate tap by which the flow of gas to it may be regulated, and it has the same cone-shaped chimney which Sir James Douglass adopted in the smaller Argand on the table. Owing to the shoulder in the chimney the air is thrown against the flame, and we get a very much intenser light than we otherwise should; and not only that—and this is the point of greatest importance—we get the flame contracted into a smaller body than we otherwise should get it. This inrush of air all round pushes the flame together. I think the actual contraction makes the flame brighter; but when such a flame is placed behind a lens, the nearer you can bring all the light to one focus, the more truly can you send out the refracted rays parallel, and therefore the less scattered the beam from the lantern will be. The smaller the flame the better the result with the lens, and this is the reason, I think, why these burners are so successful when shown in a lighthouse lantern. The particular thing to notice about this burner is the exceedingly bright zone of light about one inch above the metal base. This zone is placed in the focal plane of the lantern, and the light from it is most accurately focussed by the lens, and the refracted rays sent out parallel. Using such a lamp as this in one of the experimental towers on the South Foreland, and placing in front of it a lens six feet high by four feet broad, I found on a clear night, at a distance of about two miles, that the light received from it by a photometer disk was equal to the light from over 90,000 candles, the burner consuming only 96 or 97 cubic feet of cannel gas per hour.

Speaking of the experiments at the South Foreland naturally leads me to one other topic, not perhaps directly connected with the subject, but one on which those interested in gas manufacture will perhaps forgive me for saying a few words—that is, the standard of light to be used in testing gas flames. Two or three standards of light have been devised, and one has successfully stood the ordeal of trial. I refer to the pentane standard of Mr. Vernon Harcourt. But one objection has been urged against this standard which neither Mr. Harcourt nor others who have experimented on the subject have been able fully to meet. There is a doubt whether the light produced by the pentane flame, two and a half inches high, varies with the height of the barometer. It may be true that this has little concern for testers of coal gas, for the coal gas itself may suffer an exactly similar variation. As the coal gas goes up, so may the standard; and consequently the readings may be concordant one with the other under different conditions of atmospheric pressure. But when we come to consider a standard of light, such as is required in many physical experiments, it at once strikes us that a standard which may vary with the variations of atmospheric pressure can not be an absolute standard.

You all know that an absolute standard has been proposed in France, and, indeed, accepted by an international commission on standards—viz., the light given by a square centimeter of platinum at the melting point. I need hardly remind any of you who have worked with melted platinum, or seen it, what an exceedingly awkward standard this is. Not only is it exceedingly awkward to work, but as the platinum passes from the melting to the solid state, as it crystallizes on the surface, the amount of light which it radiates varies very considerably. The platinum standard yields a constant light, I believe, for about the space of a minute and a half. The only use of such a standard would be to standardize something more useful and portable.

But I venture to think there may be another method of obtaining a constant light which may not be subject to variations of light with variations of pressure. I refer to an electric glow lamp with a very high resistance compared with the light that it gives out, connected with a battery, and some instrument for accurately measuring the strength of current flowing through the circuit. I have lately been experimenting with such a lamp in conjunction with Mr. Vernon Harcourt. In the experiments I have referred to at the South Foreland, where we have often to measure the light from the lighthouses through an opening in the shutter of a hut exposed to the full southwest winds, we have found it exceedingly difficult at times to work with the pentane standard, and we have been anxious to devise another standard, which we could standardize first of all with the pentane, and then use. We have only lately had an apparatus of sufficient delicacy constructed, but as far as our experiments go this standard promises to be of some use in future photometry; and I have brought it before you this evening, so that anyone engaged in photometry may have an opportunity of examining it before it goes down to the South Foreland.

Here is a glow lamp of about ten ohms resistance, and it gives a light of

about one candle with a current of one ampère. The life of such a lamp as that, I think, may be a long one; we may look forward to it out-living many of its brighter brethren which give a light of from fifteen to fifty candles. This one is content with giving out only one candle light. Here I have a simple form of rheostat—a wooden cylinder and a brass cylinder, on which a German silver wire may be wound from one to the other, so as to alter the resistance of the circuit. I pass the current, first of all, through this electro-dynamometer, which tells me the strength of the current. The current goes through a fixed coil of copper wire, and also through a movable coil suspended inside the other. The movable coil suffers attraction when the current passes and turns round against the torsion of a wire. By a milled head at the top, I can put so much torsion into the wires as to bring the coil back to its original position of zero.

The method of working is this: The pentane flame is brought up to its normal height of 2½ inches; the current is sent through the dynamometer, through the rheostat, and through the lamp; and the resistance of the rheostat is altered until the light is equal to that from the pentane. Then the reading of the scale is made. This gives the torsion in this wire, and the square root of that is proportional to the strength of the current. By turning the rheostat to the right or left, the amount of current flowing through can easily be regulated, and so the light adjusted to that of the pentane. Here are some of the readings taken last week. We were particularly anxious to take readings with a low barometer, and on two days last week the barometer fell to 29.3 inches. The following are four readings on different days:

Barometer. Inches.	Dynamometer Scale.
29.3	1,204
29.5	1,212
29.6	1,225
29.7	1,238

You notice there is a regular increase in the scale readings with the rise of the barometer; but as yet we have only had this small range of four-tenths of an inch. Let me point out a very curious coincidence in these numbers. I said just now that the square root of the scale readings is proportional to the strength of current. Let us take the square root of the two extreme readings:

$$\frac{\sqrt{1238}}{\sqrt{1204}} \text{ is } \frac{1014}{1000}$$

That is, the strength of the current is 1.4 per cent. greater in one case than in the other. Now, what is the difference between the two barometer readings? The ratio $\frac{29.7}{29.3}$ is also $\frac{1014}{1000}$, or a difference of 1.4 per cent. I do not

wish to speak positively on this point, as there are several conditions which might affect the scale readings—such as changes in the torsion of the wire, or in the transparency of the glow lamp. Our experiments with the apparatus have only just begun; but they seem to point to slight changes of light from the pentane flame with variations of the barometer—changes just perceptible with such an instrument as this, but totally inappreciable by any method of measuring light by a gas flame.

Next week I propose to consider those flames which have been used as a source of heat, and those which, by heating up a solid substance to incandescence, have been used as sources of light.

SPECIAL ENGLISH CORRESPONDENCE.

COMMUNICATED BY NORTON H. HUMPHRYS.

SALISBURY, Jan. 10, 1885.

I have more than once alluded to the increased interest evinced by the general non-professional public in the uses of coal gas, and regarded it as a satisfactory sign in the interests of the gas industry; for coal gas is a commodity that will stand any amount of investigation, and the result of studying its properties will be that an increased demand will arise for improved appliances. Englishmen are proverbially intelligent on matters that touch their pockets; and the result of this increased interest will be that gas consumers generally will perceive how to avoid those fruitful sources of discontent and complaint—high gas bills—by the use of burners and fittings properly designed for utilizing the full value of the gas consumed; and the blame that has been bestowed, frequently with no unsparing hand, upon gas and gas companies will be diverted to the true cause—to the burners which do not develop more than 30 or 40 per cent. of the standard illuminating power of the gas, and stoves that waste the heat by imperfect combustion, or by diverting it up the flue pipe, or anywhere else but the place where it is wanted.

Holding this opinion, it will be obvious that I regard with great satisfaction, as a sign of the above interest alluded to, the fact that the Society of Arts, an old established and influential society, formed for the promotion of

general technical education, has selected the subject of "The Uses of Coal Gas" for a series of three lectures during the present session. A gentleman whose name is familiar in connection with the gas affairs of London, Mr. Harold B. Dixon, M.A., was selected as the lecturer, and the lectures were delivered on the 1st, 8th, and 15th ultimo, respectively. The committee have every reason to congratulate themselves upon their choice, for Mr. Dixon was certainly happy in placing before the public a large amount of useful information respecting the properties of gas, and the proper ways of using it either for lighting, heating, or cooking, delivered in that light and easy conversational style which is indispensable to the successful exposition of scientific subjects before a mixed audience. The information is not merely interesting, but of undoubted practical value to all users of gas. It comprises many points which gas engineers and others have repeatedly brought to the notice of their customers, who have frequently received them, however, with but little attention, regarding them as a "sprat to catch a mackerel," and betraying some little suspicion that the ultimate end in view was the swelling of the gas bill; but when uttered from an independent platform, by an undoubted authority on the subject, it will attract the attention which it intrinsically deserves.

A report of these lectures has been specially prepared and undergone revision by the lecturer for the pages of the *Journal of Gas Lighting*, and published in the present numbers of that magazine. Although necessarily comprising much that gas engineers are already familiar with, it furnishes very interesting reading, by no means devoid of value, for the use of the profession. It frequently happens that the time bestowed upon the study of a subject with which we were previously (or conceived ourselves to be) perfectly familiar, is not altogether wasted; and in the present case the reader will find some additional light shed upon well-known debatable matters in connection with the gas industry. The first lecture* deals with the physical properties of coal gas as supplied from the mains; such as its inflammability, specific gravity, and diffusive power; its principal constituents, hydrogen, marsh gas, carbonic oxide, ethylene, carbon bisulphide, and the quantity of oxygen or air required to consume them, also the resulting products of combustion; its exploding force, including the velocity of the explosive wave, and the proportions of gas and air that are necessary to secure an explosive mixture, the limit being shown by experiment to be about $3\frac{1}{2}$ to $9\frac{1}{2}$ parts of air to one part of gas; the effects of the products of combustion, including the sulphur compounds, as regards ventilation. "Coal Gas as a Source of Light"† is the subject of the second lecture. Besides noticing the constituents that confer the property of burning with a luminous flame on the gas, considerable prominence is given to the important practical subject of the effect of pressure on the illuminating power, in connection with which it is recommended that when the tap is used as a regulator, such as obtains when the gas is supplied at such a pressure that the tap is only required to be, say, about half-way on, it should be situated two or three feet away from the burner; as under these circumstances a swish or eddy is produced by the passage of the gas through the small opening in the tap, which is liable to produce an unsteady flame, unless the current has an opportunity of quieting down into a steady, easy flow before reaching the burner. The utility of pressure regulators or governors, either applied at the service pipe or at the burner, is referred to. The information respecting the transparency of gas flames is also of great practical importance. Mr. Dixon found that an ordinary flat-flame burner obscured 25 per cent. of the light given off by a second burner placed behind it. Several different kinds of burners were exhibited and explained. It was also shown, on the authority of Mr. Vernon Harcourt, that, for equal amounts of light, gas is five times as cheap as oil, and ten to forty times cheaper than various kinds of candles. The third lecture treats of coal gas as a source of heat, and deals with various means of cooking and heating by means of gas. And, by way of a postscript, a practical illustration is given. A friend of the lecturer uses gas entirely for cooking, and for heating all the water used in the house for a household of eleven persons, using one large cooking stove, one boiler, five Bunsen burners, and two water heaters. These have been in constant use for three years, and the average cost per annum, which includes twelve ordinary lighting burners, also in regular use, with gas at 64 cents per 1,000 cubic feet, is \$140.

For some years past Messrs Bradbury & Hirsch, artificial manures merchants, of Liverpool, have made a practice of issuing an "Annual Review" at the commencement of each year; and this publication has attracted attention in gas circles as comprising a well written statement of the state of the sulphate of ammonia trade, not merely comprising a list of prices, but considering fully and at length the various causes that have tended to affect the operations of the year, and also future prospects. I have just seen a copy of the review for 1884, just issued, in which no less than 14 pages (quarto size) are devoted to the subject of sulphate. The present low state of the market is attributed to the operations of unscrupulous speculators, re-

specting whom some deservedly caustic remarks are made; it is shown that over production has not existed, and the supposed competition of nitrate of soda as a rival manurial agent, if it has affected prices at all, is not of much importance. The total production of sulphate in the United Kingdom is estimated at 87,000 tons, of which quantity only 1,500 tons are put down as from sources other than gas works; of this quantity it is calculated that about 65,000 tons are exported to the Continent. As instancing the great fall that has been experienced lately in the value of sulphate, I may quote the average prices during the last three years:

1882.....	£20 8s. 6d. per ton.
1883.....	16 11s. 0d. "
1884.....	14 9s. 3d. "

From which it appears that the average price obtainable during the past year is only 70 per cent. of that which could be secured only two years previously.

A new departure in the way of differential rates for gas has been inaugurated for the new year by the managers of a small undertaking near Bristol. The directors of the Keynsham Gas Company have notified their consumers that in future the price of gas will be 5s. per 1,000 cubic feet to consumers of not less than 1,000 cubic feet per quarter; from which it appears that smaller consumers using less than this very moderate quantity will be mulcted in the previous price of 5s. 6d. And also that any excess of consumption over the amount used in the corresponding quarter of the previous year will be charged at 4s. 2d. per 1,000 cubic feet. The proprietors of small gas undertakings—not being encumbered by Parliamentary obligations, and being practically as safe from the risk of competition as they would be if backed up by Parliamentary authority, seeing that the amount of business they do is too small to attract the attention of enterprising and not too scrupulous speculators, who might otherwise be inclined to make things rather hot for the existing company—enjoy a perfect freedom of action as regards the arrangements they choose to make with their customers. The new arrangements now advertised by the directors of the Keynsham Gas Company, so far as I know, are quite novel and unprecedented.* Being personally unacquainted and perfectly ignorant as regards any person connected with that company, I feel quite at liberty to freely criticise them. They are certainly worthy of careful consideration, and it is possible that they may be found to be suited to the requirements and interests of many other small undertakings. To say the least, they indicate no small amount of astuteness. As to charging small consumers a higher price, a good deal of sentiment may be forthcoming about having one price for the poor and another for the rich; but gas undertakings must be conducted in accordance with the usual rules of commerce, and these have long since decided that the purchaser on a small scale must pay more than the buyer on a large scale, and that ounces or pounds cannot be retailed *pro rata* according to the price per hundred weight. Further, my own experience has led to the opinion that even if consumers of less than 2,000 cubic feet per quarter were charged 10 per cent. above the regular price, they would still contribute less than their fair proportion to the profits of the company; not only because they entail a larger proportion of office expenses, but also because of the larger proportion of bad debts, "slow" meters, leakage, not to add stealage. Seeing that only one small burner in regular use for three hours per diem would exceed the limit of quarterly consumption above named, it seems that only under exceptional cases should the consumption be less. Turning to the second innovation—the reduced price for any excess of consumption as compared with the corresponding quarter of the previous year. This is the same thing as the offering of a premium of 20 per cent. on new business, which is a very good plan, provided the *bona-fide* new business could be fairly sifted out; this, however, is rather a difficult matter. A customer commencing to use gas for the first time, or one who did not use any gas at all during the corresponding quarter of last year, as might be the case on account of absence from home, might claim, according to this arrangement, to have the whole of his supply charged at the reduced price of 4s. 2d. And the consequence would be that regular customers who had used gas constantly from one year's end to another, perhaps for the last quarter of a century, would claim, and with a considerable show of justice, that they had as much right, or even more, to the favorable consideration of the company as the new-comer or the irregular customer. So it appears that this plan is likely to be attended with many difficulties in practice.

The weather has been more favorable to the gas industry during the last two or three weeks than in the earlier part of the winter. We had a long and a mild autumn; but with Christmas time there set in not particularly severe cold, but dry and frosty weather, with a continual dull and cloudy atmosphere that entailed dark mornings and evenings and shortened the hours of daylight. Consequently the general experience has been a brisk demand for gas, and coming just at the time of maximum consumption, this has en-

* See JOURNAL, issue of Jan. 16, pp. 33-36.

† See JOURNAL, pp. 61-63.

* Mr. Humphrys undoubtedly means that his statement regarding the novelty involved in the Keynsham differential rates only applies to European countries. American gas managers have had plenty of such examples set before them in this country.

tailed some inconvenience where the plant is already worked to its full capacity. A fair trade is being done in coke, but there has not been a sufficient degree of continued cold to create a brisk demand.

The Siemens Regenerative Burners.

[Dr. Otto Götze, who is connected with the establishment of Messrs. Friedrich Siemens & Co., at Berlin, read the following paper before the German Association of Gas Engineers at the Mid-Rhine meeting of that Society. We are indebted to *Gas and Water* for the translation.—Ed.]

The lamps at present sent out by Messrs. Friedrich Siemens & Co. are pretty much like those which have been for some time well known, but there are some substantial improvements in their construction. The former soldering is quite abandoned, and the whole lamp, the cover as well as the exit-tube and the chimney top, are made out of cast iron or wrought iron, and the whole united into one solid piece. The new models present the following points for notice:

1. The possibility of centering all the essential parts, and of fixing them in that relation. The mouths of the small burner tubes are fixed in an iron circle; while formerly the circle which bound these tubes together yielded somewhat to their pressure, and the circle of tubes became, therefore, slightly eccentric. The outer cover is made of cast iron at the end exposed to the flame; it can therefore be turned upon the lathe, and is not distorted either by transport or by use; which could not always be said when this part of the lamp was made of plate.

2. The upper part of the regenerator can, without trouble, be taken off and replaced by another. When the lamp is at work half this part is red-hot, and therefore in time becomes rusty, burns away, or becomes distorted. It is of importance, also, that repairs should be effected with ease. The former regenerative parts, screwed in, were found, after somewhat prolonged use, to be difficult to remove without affecting the whole construction, and in that case it was out of the question to effect any repairs on the spot.

3. The gas chamber is separated from the regenerator, and is entirely made of brass, for the great heat induced leakages in the gas chambers of the older construction, in which brass was connected with iron. Here, too, it was necessary, in order to effect repairs, that the whole lamp should be removed.

4. By unscrewing two screws, $\frac{1}{4}$ inch in diameter, the whole lamp can be taken to pieces. It is thus possible for all to examine the construction, to find out what is the matter when things do not work well, and with little trouble, in many cases, to correct that which is at fault; all of which was impossible in lamps of the older form.

I shall now pass on to give some of my own experiences as to the working and use of these lamps. As far as the experience of gas managers in the use of these lamps for public lighting is concerned, I may, for the most part, appeal to themselves. Hard and fast rules as to the sizes which ought to be chosen for particular cases it is impossible to give, for the requirements of different places vary, and the amount of light which for one place would be sufficient would for another place fall short of the demand for brilliant illumination. When we have to do with the lighting of street areas and the crossings of crowded streets, sizes between II. and III. may be chosen. These sizes may be fitted up on the ordinary lamp-posts, as in Berlin, or may be set up on posts specially constructed for them, as in Basle, Thorn, and other places. For the illumination of great squares, on the other hand, where the area to be lit up is more extended, it is recommended that the lamps be placed high, on special lamp-posts. For large squares the size II. will seldom suffice; one or more of size I. will be required, according to the dimensions of the square. Higher numbers than I. it will only be advisable to use for public lighting when any other system of lighting will give rise to complaint, or when the dimensions of a square, surrounded by buildings, permit the use of reflectors, or when the bent lateral tube of sizes I. and II. is objected to on artistic grounds. These cases excepted, it is better to use a larger number of medium sizes, because the utility of the light produced would otherwise fall short as compared with the amount of gas consumed. We would in such a case fall into the error with which the electric arc has been justly charged. Complaints have repeatedly been made that the pipes leading straight up to the lamp have become frozen. To obviate this difficulty, as well as better to preserve the cylinder, it would be well, in the first place, to extinguish the lamps by two successive turns, so that the cooling may not be too sudden. Again, it is advisable that in all new constructions the stopcock and regulator should be in a pit some seven feet from the lamp-post, and should be laid in the course of the horizontal piping; then between the lamp-post and the lamp the two pipes—the one for gas supply, the other for self-lighting—should both be surrounded by a wider copper or patent welded tube filled with slag-wool. The self-lighting pipe must then, of course, travel from the pit. This pit must be at least 7 feet from the lamp-post, in order that the lamplighter may see what he is about when turning the flame up or down.

What I have said about public lighting applies equally to the lighting of works and railway stations and yards. Gaslighting in railway stations seems to demand some attention, for this is the field in which the contest between gas and the electric light is most animated. The advantages of the intensive gaslighting over arc lighting may probably be expressed in the following way. I have special railway establishments in my mind, but the following propositions apply generally: (a) Smaller outlay; on the average one-fifth. (b) The power of using the existing sources of gas to light up various districts in various ways as the demand arises. (c) Cost no higher, even when gas is bought; if a private gas works be resorted to the cost is much less than that of electricity. (d) Possibility of modifying the sizes of burners to meet temporary needs. (e) Greater security. (f) Lighting and extinction of particular lamps, adjustment of each flame to the amount of light required. (g) Less depth of shadow. (h) Possibility of carrying away the heat of gas flames in closed rooms, and of effecting thereby a very thorough ventilation. What has been said above as to the use of single lamps for public lighting applies generally to large areas of all kinds in which, as in works, it is sometimes of great importance that there should be no shadows. For railway stations the lamps should be more numerous and raised to a height of from 20 to 23 feet for waiting-rooms, vestibules, etc., in which we have the reflection from the walls to depend upon. Single lamps of higher power may with advantage be employed. In connection with this it may be remarked that the experiments conducted in Upper Italy, at the railway station of Alessandria, have been so decisive that in the course of this year Genoa, Ventimiglia and Bologna have arranged for intensive gaslighting, and in Basle the electric lamp has been dismissed from the central railway station, and regenerative lamps ordered. At the railway station of Dirschau each shed has its own branch pipe; the stopcocks corresponding to all the sheds are brought together into the same place, and all the gas lamps have an independent self-lighting supply. The stopcocks of the individual lamps remain always open, and are only once adjusted so as to secure an equal height of flame for all the burners. In this way the opening and closing of one master stopcock brings the whole gas lighting thoroughly under control; and this can thus be rendered extremely economical—a matter of great importance to railway stations and yards. The system has also found its place in post offices, sorting rooms, etc., though perhaps not so widely as might have been wished; and also in several universities, academies, technical schools, and so forth. These lamps of our construction have also been used for harbor lighting, as in Friedrichshafen, Geestemünde, and Stralsund; and for lighthouses, as at Bremerhaven. The most diverse works—rolling mills, forges, coke works, and so on—have set up regenerative lamps; and in many works the use of single lights has to a great extent given way to a general illumination by these lamps. Instead of eight jets 4 feet 2 inches apart, a single regenerative No. II. may be employed. In high rooms single jets have frequently been replaced by a general roof illumination; but when the room is low it is better that the walls be lit up. Some kinds of works present special points of interest. In dye works intensive burners do better than the arc light, because the light comes better through steam; and besides, the gas burners can be used to get up ventilation and remove this steam, for which purpose the roof is pierced, and a wide tube let through it; the tube which brings up the products of combustion from the gas lamp is pointed at the top, and the heated gases run smartly through its apex; this rapid stream sucks air out of the room, after the manner of an injector.

For chemical works, in which inflammable substances have to be dealt with, a safety lamp is constructed, which Messrs. Meister, Lucins and Brüning have set up with the best results in many cases where the illumination had previously been from without. In spinning factories the system has not made much progress, with the exception of Upper Italy, where whole factories are so arranged, and with the best results, both financial and illuminative. Among others, the factory of Carlo Raggio, in Novi-Ligure, saves 25 per cent. of gas, while getting a better light. For jute spinning and weaving, and for spinning all white fibers, the intensive light is well adapted. For offices the steady light and good ventilation have rendered it very suitable. For shops of different kinds, such as jewelers or German silver shops, ironware, hardware, knickknackery shops, florists, confectioners, butchers, drapers, and especially for shops the contents of which are liable to tarnish, or to be spoiled by the products of combustion of gas, the regenerative system is a necessity. For example, the polished steelware works of J. A. Heurrels, of Solingen, has a shop in Berlin which has been lit for three years by regenerative lamps. The firm has benefited by a large yearly saving, besides having a better light, for its goods do not now tarnish in the least. Under the old system of open gas flames the whole stock had to be taken down, cleaned and polished up once a fortnight at least; now they have absolutely ceased this manipulation. A similar result has been obtained by Messrs. Koch and Bergfeld, silverware works, Bremen. In closed rooms where gas is used, if the regenerative burners be employed and the products carried away, living plants may be kept in the room, as the experience at

the winter garden of the Duke of Coburg-Gotha, at Gotha, serves to show. When lamps are suspended from the roof, it is recommended that they be suspended in such a wise that they can be let down to the ground, or else that some means of access be provided from the roof.

British Gas Undertakings.

The following interesting details concerning the above subject are reprinted from the *Journal of Gas Lighting*:

The Parliamentary Returns for 1883 relating to all authorized gas undertakings in the United Kingdom—separating those belonging to Companies from those controlled by Local Authorities—have only just been issued, although the Order of the House of Commons for printing them was made on May 27 last. This delay is regrettable for many reasons; and it is hoped that arrangements may be made in future for the more speedy appearance of these very valuable statistics. Apart from their age, however, the returns are in many respects an improvement upon their predecessors. Taking the Companies' return first, the form has been enlarged by the addition of two headings, increasing the number to 24; while the particulars of others have been modified. In the last return the charges for meters were inserted in the same column as the prices of gas. But this arrangement was not as clear as might have been wished; and so the meter rents now form a separate entry, which is an improvement. The other additional column is for the length of mains in miles—an interesting contribution to the statistics of gas supply, and one that throws a side-light upon the position of a good many undertakings. A slight but not unimportant alteration is made in the column stating the illuminating power of the gas supplied, which is now that furnished by official tests, and no longer left, as was possible under the earlier form, to the unverified statement of the providers.

Generally it may be said that the latest return is fuller than those which have preceded it. The failures to return are reduced to two in England—Chapel-en-le-Frith and Kirkham; and one in Ireland—the Cork Consumers' Company. The omissions, therefore, do not materially affect the totals furnished at the end of the list, although it would naturally have been more satisfactory had the entries been regular throughout. It appears, moreover, that some of the Companies making returns have been unable to fill in all the columns (the mileage of mains is not available in 46 instances); and in other cases the figures are qualified as estimated, or prefaced by the suggestive word "about." On the whole, however, taking into consideration the extent and bearings of the information required, the response of the Companies to the Order of the House has been loyal and complete.

Before proceeding to show the details of the return relating to Companies, or to examine that relating to Local Authorities, it will be convenient to cite the totals in respect of both classes of undertakings, for comparison with each other and with the figures referring to the previous year. The gross amount of share and loan capital authorized for the gas companies of the United Kingdom, at the end of 1883, was no less than £48,153,985; of which the sum of £34,114,530 was actually paid up or borrowed. Similarly the local authorities of the United Kingdom had power to raise £21,163,139 for this purpose, and had actually raised £17,874,351. Adding these two classes of statistics together, we find that the grand total of capital authorized for gas supply in the United Kingdom was £69,317,124; of which £51,988,881 was actually raised and employed. The return for 1882 showed that the companies could then raise £46,906,701, and the local authorities could borrow £20,911,154; while the amounts actually raised by them were £32,934,935 and £17,326,183 respectively, giving grand totals of £67,817,855 of authorized, and £50,261,118 of employed capital. The increase for the year was therefore £1,499,269 in authorized, and £1,727,763 in employed capital; apparently indicating that legislative authorizations were not keeping pace with actual requirements. The increase of the companies was £1,247,284 in authorized, and £1,179,595 in employed capital; the increase of the local authorities being similarly £251,985 and £548,168. These figures are significant. They indicate a more rapid extension, involving a heavier drain upon the resources of the companies as compared with the local authorities; and as all the new capital must necessarily have been raised under the auction clauses, there is every possible guarantee that it was in each case kept down to the lowest amount that would satisfy current requirements. The same figures also show that the local authorities are not taking the "lion's share" in the general increase of the gas interest of the country, but that, when comparison of one year with another is not seriously affected by transfers of undertakings, the great mass of gas companies, comprising a number of small concerns, have decidedly more than their proportional quota of elasticity.

Comparisons based upon considerations of capital alone require to be supplemented by others drawn from records of what is done for the money. Here, however, the imperfections of the returns, such as they are, introduce a slight amount of error. Naturally, it is easier to obtain returns of capital

obligations than of other data which are in general less rigorously settled. Still, the Board of Trade officials have carefully made up all the totals that could be added, and the following are the results:

In 1883 about 7,631,304 tons of coal were carbonized by all the statutory gas undertakings of the Kingdom, producing altogether 76,837,967,813 cubic feet of gas, of which 70,116,324,062 cubic feet were sold to 2,019,846 consumers and for lighting 375,536 public lamps. There is no ready means of ascertaining the population of the districts occupied by these undertakings, or it would be interesting to note the average consumption per head. In the previous year 7,280,757 tons of coal were carbonized, and 72,583,343,401 cubic feet of gas were made, of which 66,613,943,898 cubic feet were sold to 1,971,971 consumers and for 361,311 public lamps. The increase for the year was therefore 350,547 tons of coal carbonized; 4,254,624,412 cubic feet of gas made, and 3,502,380,164 cubic feet sold; 47,875 consumers, and 14,225 public lamps. That is, the increased carbonization of coal was at the rate of 4.81 per cent. on the return for the previous year, the production of gas increased at the rate of 4.46 per cent., the consumption of gas increased by 5.25 per cent., the increase in the number of consumers was 2.42 per cent., and in the number of public lamps 3.93 per cent. It will be observed that the rate of production of gas also rose from 9,969 cubic feet to 10,068 cubic feet per ton; being a surprisingly high rate for such a mass of works taken all together, great and small, from all parts of the Kingdom, and using all varieties of coal. It is very satisfactory to find that the rate of increase was greater in regard to the gas sold than in the gas made. This points to a progressive diminution of the unaccounted-for gas. The comparatively slight increase in the number of consumers also shows that a great deal of the increased consumption was due to a real expansion of business done with existing consumers, and only a portion of it with new patrons. The steady increase in the number of public lamps shows not only that our towns are growing on all sides, necessitating the formation and lighting of new roads, but that the position of gas as a street luminant has not been weakened, but rather strengthened, in face of an active competition.

It would be possible to draw many proportional comparisons between the totals compiled from the companies' and local authorities' returns; but such results would, in the main, be more curious than instructive. It may be placed on record, however, that of the gross bulk of gas sold in the Kingdom the companies supplied 68.18 per cent. and the local authorities 31.82 per cent. For the previous year the ratio was 68.28 and 31.72.

Coming back now to the return of the companies, it appears that their total authorized share capital at the end of 1883 amounted to £39,060,992, of which £29,038,726 was paid up. The authorized loan capital, including debenture stock, was £9,092,993, of which £5,075,804 was borrowed. The amount of borrowing power remaining in reserve was therefore considerably more in proportion than the ratio of unused share capital. Of the authorized capital, £9,339,760 is subject to the auction clauses; and £2,538,709 of this has actually been raised, the premium upon which was £1,088,675, or an average of nearly 43 per cent.

The total length of mains given in the statement is 11,914 miles; but, as already stated, this is passing over 46 works which cannot give their mileage. The average mileage of these undertakings may range from 5 to 10, as they are not large; and if the latter were taken—which would probably be a liberal estimate—it would bring up the total mileage for the gas companies of the United Kingdom to 12,374, and the works that do not make any return would increase this to about 13,000. Few undertakings have more than 50 miles of street mains charged; and the influence of mileage upon price may be detected on the surface in a good many of the entries. Thus, the Gas Light and Coke Company (before the amalgamation with the London Company) had 1,730 miles of mains for 198,290 consumers, or 114.6 per mile. The South Metropolitan Company had 61,009 consumers on about 670 miles of mains, or about 91 per mile. The Dublin Company, however, had only 16,917 consumers on about 600 miles of mains, or less than 30 per mile. It is, evident, therefore, that in this respect the conditions of the undertaking supplying the Irish capital cannot possibly be so favorable as those of the Metropolitan companies. Taking a celebrated low-price company—the Plymouth—there are 8,540 consumers on 49 miles of mains, or nearly 174.3 per mile. It does not follow, however, that this matter of cheapness and close packing is a rule without any exception, for in some localities, with from 300 to 400 consumers per mile, the price is not conspicuously low. If it were possible to co-ordinate the number of consumers with the bulk of gas sold to the mileage unit, a more trustworthy rule might be deduced. This could be easily done with a few selected examples; but not with a mass of returns such as those now before us.

We have on previous occasions examined these statistics, and pointed out the largest and smallest of the undertakings, the dearest and cheapest gas, etc.; wherefore it will be unnecessary to do the same now, for a year or two does not bring much change in the relative positions of concerns of this order. It will suffice to say that the growth which is manifested by the totals relating to their operations is fairly distributed among them; and the

prices stated for gas have in very many instances been reduced in comparison with the figures belonging to the previous year.

The return relating to local authorities' gas undertakings has also been enlarged, and the form improved. The additional headings are to the same purport as those inserted in the companies' return, and relate to meter rents and mileage of mains. Many of the returns are made up to March 25, 1884. The general totals of the operations of these undertakings have been already dealt with. The financial data are a little more mixed than in the case of the companies; and the application of the profits is very erratic. The length of mains belonging to local authorities is entered as 6,053½ miles, and the information was not forthcoming in 20 instances. Adding this figure to that of the companies' return—making a similar allowance for the missing measurements—we obtain 19,100 as the probable extent in miles of the gas mains of the Kingdom; and every portion of these must by law be maintained full of gas and under a sufficient pressure and in sufficient quantity for any demand that may be made by the inhabitants of the district through which the mains pass. It is a great obligation; and the ease and certainty with which it is discharged should not lessen, in the eyes of an observer, the magnitude of the mental and physical work involved in the duty.

Something About Lime and Cements.

The London *Builder* is publishing a series of articles on "Lime, Cement, and their Uses," intended for the better information of the student in these materials. The articles in question are quite well worthy the attention and thought of other than students, as they contain a number of practical and valuable hints put in language entirely divested of technicality. We extract the following:

"The principal difference to be observed between lime and cement is that whereas lime has strong adhesive powers and small cohesive powers, cement possesses the reverse properties. Lime, therefore, is improved in strength by the addition of a suitable sand, while the strength of cement is greatest when it is used by itself. To determine the constructive value of a sample of lime by means of laboratory or testing-room experiments is much more difficult than the carrying out of an ordinary cement test. In fact, such tests are seldom adopted, for from a knowledge of the components of the limestone from which the lime is burned, and from its general appearance, a very just opinion can be formed as to its suitability for the work for which it is intended to be used, and it is only necessary to insure that it is worked in a proper manner.

"When, however, a test is made, it is simply the hardness which the sample attains after gauging that is determined, and this is done by what is known as a Vicat needle. A Vicat needle is an instrument consisting of a needle with a flat point fixed to a light rod, which slides in the framework of the machine; the needle being weighted to the required amount, is allowed to fall from a certain height on to the pat of lime, and the indentation measured by means of a Vernier scale on the guide-rod. It is usual to make the pat to be tested of one part lime to three parts of clean, sharp sand, about three in. square, and at least 1½ in. thick. The needle should have a diameter at the point of 0.1 in., and should weigh with the rod and attachments 4 ounces; the fall should be six inches, and the experiment carried out seven days after making the pat.

"The knowledge of the analysis of the limestone (or even generally its geological position) from which the lime under consideration has been burned, will at once decide whether it is a rich or hydraulic lime, and an examination will decide if it is well burned and fresh. The matter of burning can be, in the matter of rich limes, easily determined by taking a small piece of it, dipping it into water, and then putting it on one side for a short time. If it all falls to a white impalpable powder it is a sure indication that the lime is properly burned. If, on the other hand, hard lumps remain, this is an indication that it is not well burned, and a few more pieces should be taken from different parts of the bulk and the same experiment carried out. The foregoing, it need not be forgotten, refers to rich limes only; the hydraulic and eminently hydraulic limes take a much longer time to "slack," some of them as much as a week or ten days, or even longer; in fact, from the difficulty experienced in "slacking" them, they are generally ground to facilitate the operation. The freshness of the lime is essential, because lime that has become "killed" by absorption of the carbonic acid from the atmosphere will not make good mortar. If all the lumps of lime have clean, sharp edges without cracks or any indication of powdering it is in a perfect condition for use. Lime is supplied from the manufacturer as "lump" lime or ground. The rich limes are generally supplied as lump lime, and the hydraulic limes are generally ground; but, unless it is to be used at once, it is preferable to have it in lumps, as in that condition it will keep a longer time in good condition.

"Roman cement, plaster of Paris, parian, and Keene's cement, though not used for purely such constructive purposes as are lime and Portland cement,

are still of the same category. Roman cement was the immediate forerunner of Portland cement. It was no doubt called Roman because it was thought that in it had been rediscovered the cement used by the Romans, and to which age has given such a high reputation; it is, however, needless to say that the Romans were innocent of Roman cement. It is an essentially hydraulic cement, containing considerably less lime than Portland cement, and a correspondingly increased quantity of silica and alumina, and it is burned at a much lower temperature. It is produced by the simple calcination of an argillaceous limestone, which is found in many parts along the English coast. The principal seat of the industry was in the Isle of Sheppey, where large quantities of the stone were found; but it has been entirely superseded by Portland cement, and very little is now made. It is of a dark brown color, and sets very quickly whether left in air or put in water. It attains its maximum strength in a very short time, and when tested for tensile strength in the same way as Portland cement, breaks at about 200 lbs. per square inch when seven days old, and it never increases much more. Medina, lias, and other cements are simply variations of it.

"Plaster of Paris is calcined alabaster or gypsum, and is sulphate of lime containing about one-third part of water. The object of calcination is, therefore, only to expel the combined moisture. The calcination is carried out at a very low temperature, and it is then ground to the desired fineness. In some districts the gypsum is first ground to powder and the moisture evaporated from it by placing it on hot plates. Plaster of Paris sets very quickly when water is added to it. It is of value only for internal work, as it never attains very great strength or hardness. For working cornices, etc., in rooms, it is often mixed with lime-putty to make it slower setting.

"Keene's, Martin's, and parian cement are all manufactured from plaster of Paris by the addition thereto of alum, sulphate of potash, or borax. By these additions in the proper proportions the plaster is rendered extremely hard on the surface, and is capable of taking a certain amount of polish. Many of the artificial marbles are made with one or another of them as a base, with coloring matter added to give the vein of the stone or marble it is intended to imitate."

ITEMS OF INTEREST FROM VARIOUS LOCALITIES.

A "NOTE" FROM MR. HENRY AITKEN.—Mr. Henry Aitken, of Falkirk, Scotland, who enjoys a justly-merited reputation for straightforwardness and application as a gas engineer among the fraternity on both sides of the Atlantic, has conveyed to us the following interesting communication. It bears date of January 5th:

"To the Editor AMERICAN GAS LIGHT JOURNAL:—In your Journal, in issue of Dec. 16th, page 311, you furnish report of a paper, read before the American Gas Light Association, by Mr. S. G. Stiness, on the subject of 'A Positive Cure for Choked Stand-pipes.' Since I have had some experience in this matter, and as I have devised a plan which keeps the hydraulic main free from all deposit of tar or pitch, I beg you would be kind enough to allow me to place the following remarks before your readers.

"Mr. Stiness' contention is that if the hydraulic main is kept free from pitch or heavy tar, there will be no choked stand-pipes; and his pleasant experience of a few months no doubt gives him confidence in saying that his idea is correct. Whether or not Mr. Stiness is correct in this contention is not the point upon which I would now desire to enter. What I wish is to describe a simple means for keeping the hydraulic main clear, and at the same time furnish a gas with an increased illuminating power of from 10 to 25 per cent., the extent of the increase depending on the nature of the gas making material employed.

"Early in 1883 I mailed each of your subscribers a copy of my patent taken out in Great Britain in 1874, and issued in the United States either in that year or early in 1875. This patent shows that one way of working the process therein described is effected by placing the condensers above the hydraulic main, so as to enable the tars to flow back into it. The hydraulic main being covered so as to keep it hot—say, at a temperature of 160° to 170° F.—these hot tars flowing through it will dissolve the hard tars or pitch, and thus the whole would flow out together.

"There is the further advantage to be gained from this manner of working, viz: Any of the light oils or spirits condensed and absorbed by the tars in the process of condensation are heated up in the hydraulic main, converted into vapor, and carried off by the gas, thus greatly adding to the illuminating power; and it is also to be borne in mind that when gases are so treated there is not the slightest trouble with naphthalene. Not only so, but experience has taught us that such gases have the power of absorbing naphthalene that had formed and been deposited in the pipes when gas was being passed through them which had been treated under the old-fashioned or previously employed methods of condensation.

"No doubt it is not always convenient to place the condensers above the level of the hydraulic main, and I am fully aware that in nearly all gas plants as now constructed the condensers are not so placed; still the circum-

stance is not a grave objection, as it is an easy matter to pump the fars from condensers into hydraulic main, heating them up to, say, 170° F. on their passage. For this purpose only a small pump and a steam heater are required, or even a steam-jet might be used—though the pump is decidedly to be preferred—or a steam pipe might be laid on bottom of hydraulic main. Such a pump and heater would cost here only about \$100—a small sum when one considers all the advantages which I claim result from my manner of working.”

PROBABLY GAS IS GOOD AND CHEAP AT TIFFIN.—Brother Joseph Bate, Supt. and Sec'y of the Tiffin (Ohio) Gas Light Company, as also Secretary of the Ohio Gas Light Association, propounds to us the following conundrum: “Edison is flourishing here in the shape of an accumulating indebtedness. Why is this, when he came here to close us up?” The reason for the “sad accumulation” may very likely be found in the heading of this item, and it certainly would be a sufficient one. The real truth of the matter is, though, Mr. Edison has never been very successful in his attempts at “closing anybody up,” unless exception be made in the case of “closing up” and “out” the bank balances of some of the speculators who “got in on the ground floor” of that wonderful “parent company” of his not such a long time ago. By-the-way, the President of the Tiffin Gas Company is the Hon. Geo. E. Seney. Mr. Seney has represented his district in the House of Representatives for the term ending with this session, and so well did he acquit himself that he was, at the election held last November, chosen as his own successor. There are some *trusted* gas men after all.

PRICE OF GAS REDUCED AT SPRINGFIELD, OHIO.—At the regular annual meeting of the Board of Directors of the Springfield (Ohio) Gas Light Company, held on Tuesday, Jan. 13th, it was unanimously agreed upon to reduce the selling price of gas from ruling rate of \$2 to the figure of \$1.75 per thousand cubic feet. The reduction was also made to include all gas consumed in the public buildings, although the Company has a contract with the municipal authorities at the \$2 price which does not expire until September, 1885. The new rate was made without solicitation on the part of the consumers; indeed, this is the most gratifying feature connected with the generally widespread movement now taking place with regard to the lowering of selling rates. The gentlemen concerned in the management of the Springfield Company are to be congratulated upon their liberal policy.

CONTRACTS SECURED.—Mr. Adam Weber, proprietor of the Manhattan Fire Clay Goods Works, of New York city, has entered into a contract with the authorities in charge of the United States Military Academy, located at West Point, this State, for the erection of two benches of “sixes” and one of “threes,” to be put up in accordance with his latest and most improved plan. The same gentleman is under contract to erect fifteen benches of “sixes” to the order of the Buffalo (N. Y.) Gas Light Company.

PERSONAL.—The many friends of Mr. Charles F. Smith will be glad to learn that, after several years of residence in Havana, Cuba, where he was engaged as engineer to the new gas company in the metropolis of the West Indies, he has resigned that position and returned to the United States, and is now at his home in Fitchburg, Mass. Mr. Smith achieved an excellent reputation as Superintendent of the Woonsocket (R. I.) Gas Company, which model works were designed and erected during his term of stay at that place. Although among the younger members of the fraternity, he has already had a wide, varied and rather remarkable experience. It was during his administration in Havana that the terrific explosion of the government powder magazine occurred, demolishing all the holders at the new company's works, except one small vessel of a capacity of 40,000 cubic feet. Notwithstanding the extent and completeness of the disaster, which would have unnerved many an older manager, by the most ingenious and extraordinary expedients he kept up the supply of gas, and not a single consumer was seriously inconvenienced. During Mr. Smith's stay in the “ever-faithful Isle” he was twice stricken with yellow fever, and he experienced many another vicissitude incident to a life in the tropics. He is a deservedly popular member of the fraternity, and a thorough believer in the orthodoxy of what the canvassers for the sale of water gas patents style the old-fogy method of gas manufacture. Mr. Smith is disposed to the view that old fogies are inclined to deal honestly with their fellow men.

KILLED WHILE EXPERIMENTING.—A despatch from Denver (Col.), dated Jan. 18th, brought the news that Dr. G. E. Smith, a retired physician of that city, was killed by an explosion of hydrogen gas. Deceased was engaged in the making of an experiment.

G. G. RAMSDELL TO DIRECT AFFAIRS.—That irrepressible “gas man,” bright, active and popular, Geo. G. Ramsdell, of Vincennes, Ind., will not “down.” At the semi-annual meeting of the Vincennes Board of Trade, held on Tuesday, Jan. 13th, he was chosen President of the body. Keep on,

George; and, bearing in mind certain things that transpire at elections, who knows where you will land? A friend at our elbow suggests that Ramsdell always lands on his feet.

NATURAL GAS EXPLOSIONS.—Almost every day we are treated to an account of a natural gas explosion that occurred in some portion of the natural gas territory. One of the most remarkable occurrences of that nature is said to have happened at a point about eight miles from Pittsburg, Pa., on Jan. 22. A gang of laborers were engaged in repairing a leak in a natural gas conduit, and the explosion was caused by one of the hands who, while right over the spot where the escape was located, struck a match to *light his pipe!* The investigating match of the plumber may now hide itself.

EVANSVILLE GAS AND ELECTRIC LIGHT COMPANY.—The annual meeting of stockholders in the Evansville (Ind.) Gas and Electric Light Company was held on date of Monday, Jan. 19th. The stockholders expressed themselves as thoroughly well pleased with the state of affairs made apparent through a reading of the working reports for the year. The combined effects of prompt and polite attention to all complaints, with a general decrease in amount of gas bills, could but result in a decided increase in the total number of gas consumers, and universal satisfaction with the management of the company. A dividend of six per cent. was declared on the capital stock. After the various reports had been read and disposed of an election for directors for ensuing year was entered into. The following gentlemen were chosen: Francis J. Reitz, R. K. Dunkerson, Samuel Bayard, Wm. Heilman, Thos. E. Garvin, and Jacob Eichel. The Directors then organized the Board by the election of Mr. F. J. Reitz as President; R. K. Dunkerson, Vice-President; Samuel Bayard, Treasurer; J. B. Hall, Jr., Secretary. Mr. I. C. Baxter was re-appointed Superintendent of the gas (Mr. G. M. Hoag being appointed Superintendent of the electric) department of the works.

ELECTION OF DIRECTORS, BROOKLYN (N. Y.) GAS LIGHT COMPANY.—The following gentlemen were chosen to compose the Directorate of the Brooklyn Gas Light Company for 1885, at the annual election of that corporation, held on Monday, Jan. 12th: Messrs. C. E. Bill, Jas. How, P. C. Cornell, S. L. Husted, H. D. Polhemus, H. K. Sheldon, A. M. White, J. H. Armington, and H. H. Rogers.

ANNUAL MEETING PARIS (ILL.) GAS LIGHT COMPANY.—The annual meeting of the directors of the Paris (Ill.) Gas Light Company was held on Tuesday, Jan. 6th. The selection of officers for year resulted in the choice of Mr. C. W. Powell, as President and Treasurer; R. N. Parrish, as Vice-President; and W. H. Levings as Secretary; the latter named gentleman was also appointed Superintendent. In common with all sections of the United States, Paris (Ill.) shared in the general business depression ruling in 1884; but the gas company there reports its account books as showing a most satisfactory state of affairs. The officers of the corporation rightly attribute the circumstance to the fact that during the year a reduction in selling rates of 40 cents per 1,000 cubic feet was made. The annual price of each lamp post in street lighting service was also reduced in the sum of \$5. Gas is furnished to ordinary consumers at the rate of \$2.40 per 1,000.

MR. EDISON MAKES ANOTHER PREDICTION.—The daily papers of this city claim that Mr. Thos. A. Edison recently asserted, while in conversation with Mr. Erastus Wiman, that the experiments preliminary to running the elevated railroads by electricity were advancing favorably. He said he should not be surprised to see steam engines dispensed with on those roads within a period of two years, or even earlier. I suppose we need not remind Mr. Edison that *some* gas is yet being made in New York city; and he probably has not forgotten that he indulged in some surmises ancient metropolitan gas manufacture at not such a remote date either.

REDUCING PRICE OF GAS AT RICHMOND, VA.—At the regular monthly meeting of the Richmond (Va.) Board of Aldermen, held Monday evening, Jan. 12th, the resolution previously passed by the City Council, which ordered the making of a reduction in selling rates for gas, was taken up and discussed. Messrs. Burwell and Glasgow urged immediate concurrence in action taken by Council. When the question was put not a single vote was recorded as against the proposition. The new selling rates are \$1.50 to ordinary consumers, and \$1 to the city. The new schedule went into effect on consumption registered from Feb. 1st. Ex-Concouncilman Higgins and his fellow agitators of a year ago ought really to be credited with this result, since it was their well-directed efforts that placed the Richmond City gas works in shape to make this reduction possible.

NO ELECTRIC LIGHTS FOR ROMAN CHURCHES.—The following is a portion of an interesting article which appeared in the New York *Sun* of recent date: “Rome, Dec. 12, 1884.—On the 11th day of December, 384, the Roman Church was in great mourning, for Damasus, the great friend of Hieronymus,

was dead. Yesterday, fifteen centuries afterward, the whole city of Rome celebrated the memory of the great Pope in his own Basilica of St. Lorenzo, in Damaso, and the Roman people flocked to the church as in times of yore they flocked to the Coliseum or the Circus Maximus. The Basilica of St. Lorenzo in Damaso is well known to the tourist, as that church is embodied in the right wing of the great palace of the Roman chancery. The palace is the seat of almost all the Roman congregations, the residence of the grand Penitenciary, Cardinal Monaco, and of the Vice-Chancellor, Cardinal Mertel. In the times of Pius IX. it was the seat of the Roman Parliament, and Pellegrius Rossi was stabbed at the first steps of its main stairway. The celebration of St. Damasus has been quite an event for Rome. The three aisles of the basilica were literally covered with lights and flowers. Nearly 200 chandeliers and 2,000 tapers burned in the temple, and from the cupola a stream of electric light illuminated the tiara and the keys, which pontifical emblems were towering over the great baldachin under which lies the body of the saint. A crowd of little gilded angels supported, at regular intervals all along the aisles, rich festoons of flowers. From the seven niches of the side aisles hung alternately chandeliers and baskets of flowers. The decoration was so tasteful and so rich that many criticised it as being too profane, and even intimated that the presence of the electric light in the church, together with so many flowers and cheerful ornaments, suggested one of the most lively scenes of 'Excelsior,' which was being performed at the Costanzi Theater. These criticisms were so persistent and universal that the authorities were obliged to prohibit the electric light, which was used after the first evening only as a means of illumination in the courtyard of the Cancellaria, where the carriages of the Cardinals and of the Roman princes were stationed during the religious services. * * * These solemnities have created a bad feeling on account of the electric light episode. When the solemnity was over (Dec. 12), a notice was given to all the clerical papers of Rome warning all the rectors of churches, both in Rome and abroad, against the use of baskets of flowers hanging from the ceiling, and against magnesium, calcium, and electric lights."

PUBLIC LIGHTING OF BOSTON, MASS.—We extract the following particulars from the annual report of the Superintendent of Lamps of the city of Boston (Mr. John T. Manson), for the year 1884:

Comparison of prices paid for gas consumed in public lamps from 1877 to Dec. 31, 1884—

	1877.	1878.	1879.	1880-3	1884.
City proper...	\$2.00	\$1.90	\$1.75	\$1.50	\$1.30
South Boston.....	2.40	2.25	2.25	2.00	1.85
East Boston.....	2.40	2.25	2.25	2.00	1.85
Roxbury.....	2.40	2.25	2.25	1.87½	1.65
Dorchester.....	2.90	2.75	2.75	2.25	2.00
Brookline and Brighton	2.90	2.75	2.50	2.25	2.00
Jamaica Plain.....	2.90	2.75	2.75	2.25	2.00
Charlestown.....	2.40	2.25	2.25	1.87½	1.75

The following schedule shows the prices charged by the different companies for gas supplied to public buildings and private consumers:

	Public Buildings.	Private Consumers.
Boston Gas Light Company.....	\$1.50	\$1.50
Roxbury " ".....	2.00 (5 p.c. off)	2.00
Dorchester Gas Light Company.....	2.50*	2.50*
Charlestown " ".....	2.00	2.30
South Boston " ".....	2.00†	2.00†
East Boston " ".....	2.00	2.00
Jamaica Plain " ".....	2.37½	2.50
Brookline " ".....	2.25	2.50

The large 3-cluster burner Bray lanterns which were experimentally tried some time ago have given such general satisfaction that the Lamp Committee ordered the erection of several more, which were placed at prominent points throughout the city and in the suburbs. These high power Bray burners and lanterns are all rated to a consumption of 30 cubic feet per hour, and are distributed as follows: In Boston proper, 24; Roxbury, 4; South Boston, 1; Charlestown, 4. In addition to the 30-foot Bray lanterns the Charlestown Company maintains three improved high power lanterns—two of them rated to consume 100 cubic feet per hour, the other consuming 75 feet per hour. These lights burn all night and every night in year, and the city pays for same 65 cents each per night. Since the rebuilding of Warren bridge the Committee decided to light it with lanterns carrying 9 feet per hour burners. At \$1.30 per 1,000, Mr. Manson places the annual cost of their maintenance at \$51.17 each—of which sum \$44.79 is for gas, and \$6.38 is the charge for lighting and care. During the year the Committee decided to place 5-foot per hour burners in lanterns situated on wide thoroughfares (4-feet per hour is the prevailing rule in Boston); this was done to a total of 261 lamps. Mr. Manson places the cost of each (gas same as before) at \$31.26—of which sum \$24.38 represents gas, and \$6.38 lighting and care.

* If paid within 15 days, \$2.

† If paid within 10 days, \$1.80.

Public electric street lighting was first introduced into Boston on date of Feb. 15th, 1882, beginning with five "arcs," located along Scollay square. On Jan. 1, 1883, there were 114 of these lights; 381 on Jan. 1, 1884; and 401 on Jan. 1st, 1885. Of these lights 218 are assigned to Brush Company; 141 to New England Weston Company; 26 to Merchant's Company, and 16 to Union Company. The electric companies charge a uniform price of 65 cents per lamp per night. In the contracts made the several companies agree to indemnify the city against "any and all claims for damages for injuries to persons or property arising from imperfect insulation of wires, or construction or maintenance, or use of its wires or apparatus, etc." Within the limits of corporate authority, of city of Boston, on date of December 31, 1884, there were operated 12,809 public lights. Of these 9,817 were gas lamps; 2,591 were oil lamps; and 401 were arc lights. The comparative total cost of each description for years 1883-4 is as annexed:

	1883.	1884.
Gas lamps.....	\$271,777.89	\$255,463.30
Oil lamps.....	6,479.36	5,565.93
Electric lights.....	58,855.18	90,785.80
Gross.....	\$337,112.43	\$351,815.03

The ordinary gas lighted lamps in city are kept burning on a schedule that foots up to an annual total of 3,828 hours each.

THE DIFFERENCE BETWEEN THE TWO SORTS OF GASES.—A man accompanied by a female entered the small hotel at No. 123 Canal street, New York city (known as the New Transit House), at 6 A.M., on morning of Jan. 23d, registering as "Mr. Neuman and wife." They were assigned to a room and retired. Some hours after their arrival the odor of escaping gas was noticed; search after the leak showed its source to be located in the room occupied by the persons above mentioned. The proprietor of the hotel was notified, and by his orders the door of the apartment was broken open. The inmates were found dead in bed. The burner was turned fully on, and was without a safety pinion. The inference is plain—a case of "turning off and on." Neuman was subsequently identified to have been a man named Bendett, an assistant or clerk at a grocery store located in No. 6 Ludlow street. His female companion was not identified. This was a case of water gas; now note the difference. On the date of Thursday evening, Jan. 22d, a woman, first name Sarah, employed as a domestic in a family occupying residence at No. 434 East 84th street, this city, blew out the gas preparatory to going to bed. Ten hours afterward discovery of her condition was made. She was removed to the Presbyterian Hospital, where recovery ensued. No need to say what sort of gas she inhaled.

HERE IS ANOTHER SPECIMEN.—A woman named Rose Schesslinger retired to bed in her apartments, No. 1,031 Market street, San Francisco, Cal., at 10 P.M., on night of Jan. 3d. She was left undisturbed until 4:30 P.M. of following day. Investigation proved that she had blown out the gas either knowingly or unwittingly. The woman recovered; and it was coal illuminating gas that was supplied to the premises.

Correspondence

(The JOURNAL is not responsible for the opinions expressed by correspondents.)

Utilization of Waste Heat of Gas Works.

OFFICE ST. CROIX GAS LIGHT CO., }
CALAIS, MAINE, Jan. 16, 1885. }

To the Editor AMERICAN GAS LIGHT JOURNAL:

Permit me to make the acknowledgment that the JOURNAL has been a great source of profit to me during several years, and more particularly so since, owing to circumstance and situation, I have been unable to attend the Association meetings.

With your permission I would like herewith to present a brief "note," giving my experience with regard to heating steam boilers in gas works from the waste heat of the benches, in the hope that it may possibly prove of interest to some of your readers. Starting in with the deliberate opinion that any gas company, possessing a proper chimney and connections as a part of its plant, need not be at the expense of one dollar in connection with extra fuel used in generating steam, I will explain the method that has been in perfectly satisfactory use in our works for some time.

Our plan is to tap the flues near the ground line—care being exercised not to baffle the heat through allowing it to descend after it leaves the bench—this being done to avoid placing the boiler on top of the stack. The boiler is placed and set up on the floor at side of bench, in the usual way. We introduce the flue at back end of boiler, and pass the heat through the tubes only. The quantity of heat required is controlled by a damper arrangement in boiler stack, and the excess or surplus heat is led into chimney by direct flue. If required, all the heat can be sent through the boiler, and so as not to injure the draught of bench if the details are carefully observed.

I shall hold myself pleased to furnish any of your readers with whatever other information they may require.

Very truly,
F. N. DAVIS, Supt. & Treas.



A. M. CALLENDER & CO.,
PROPRIETORS.

Editor—JOS. R. THOMAS, C.E
Manager—C. E. SANDERSON.

PUBLISHED ON THE 2ND AND 16TH OF EACH MONTH
At No. 42 Pine Street, New York.

TERMS
SUBSCRIPTION—Three Dollars per annum, in advance.

MONDAY, FEBRUARY 2, 1885.

The Market for Gas Securities.

The city gas share market is and has been dull and listless. At the time of writing (Jan. 29th) the list is in an unsettled state, and generally inclined to weakness. This weakness may in part be attributed to the fact that the Legislature is in session, and also because Mr. Sherwood, in company with quite a select few whose names are familiar to the New York public as those of folks particularly apt to air their eloquence with reference to reform whenever they have an opportunity of so doing, are at present indulging in a rather "windy" attack upon the Consolidated Company of this city. A meeting was held at Delmonico's uptown house on evening of Jan. 27th, and the amount of "blowing" indulged in was simply immense. The "professional" reformers in attendance included the rather familiar names of Jackson H. Schultz, F. B. Thurber, A. S. Sullivan, and many others. Mr. N. R. O'Connor was also present; and of course pure and simple benevolence for the "suffering consumer" induced his attendance at the meeting. The gas meter attracted great attention as usual; and Mr. Sherwood, in the bitterness of his feelings, claimed that "when he had gone to the gas companies for redress for grievances he had been treated like a dog." He certainly "barked" loudly at the Delmonico session. An amateur journalist named Bottsford inflicted the "reformers" with an address that beat anything "Prof." Lowe ever delivered himself of. One year ago Bottsford could not make the distinction between a gasholder and a condenser. He has been "reading up" since, and now knows it all.

The trouble with the "gas reformers" is that they dont know what they are talking about. Assemblyman Coffey has introduced the "annual joker" in the shape of a resolution offered by him to forbid gas companies throughout the State from charging a higher rate than \$2 per 1,000 cubic feet. The resolution is supposed to be aimed more particularly at the Citizens' Company, of Brooklyn, N. Y., as Mr. Coffey resides in its district.

New York Gas Light Company paid a dividend of 1 per cent. on Feb. 2; New York Municipal has paid one of 20 per cent.; and the Manhattan one of 10 per cent. on Feb. 2.

Gas Stocks.

Quotations by Geo. W. Close, Broker and Dealer in Gas Stocks (with A. E. SCOTT & Co.)

72 BROADWAY, NEW YORK CITY.

FEB. 2.

All communications will receive particular attention.
The following quotations are based on the par value of \$100 per share.

	Capital.	Par.	Bid	Asked
Central.....	\$440,000	50	60	—
“ Scrip.....	220,000	—	47	57
Equitable.....	2,000,000	100	93	95
“ Bonds.....	1,000,000	—	102½	103½
Harlem.....	2,000,000	50	110	113
“ Bonds.....	170,000	—	—	—
Manhattan.....	4,000,000	50	240	250

Metropolitan.....	2,500,000	100	210	220
“ Bonds.....	658,000	—	110	112
Mutual.....	3,500,000	100	120	122
“ Bonds.....	1,500,000	1000	104	106
Municipal.....	3,000,000	100	190	200
“ Bonds.....	750,000	—	107	110
New York.....	4,000,000	100	145	150
Northern.....	125,000	50	—	80
“ Scrip.....	108,000	—	—	—
Gas Co's of Brooklyn.				
Brooklyn.....	2,000,000	25	127	130
Citizens.....	1,200,000	20	84	86
“ S. F. Bonds.....	320,000	1000	106	110
Fulton Municipal.....	3,000,000	100	148	150
“ Bonds.....	300,000	—	104	108
Peoples.....	1,000,000	10	77	80
“ Bonds.....	290,000	—	105	110
“ “.....	250,000	—	90	95
Metropolitan.....	1,000,000	100	96	—
Nassau.....	1,000,000	25	119	—
“ Cfts.....	700,000	1000	92	94
Williamsburgh.....	1,000,000	50	134	137
“ Bonds.....	1,000,000	—	106	108
Richmond Co., S. I.....	300,000	50	64	75
“ Bonds.....	40,000	—	—	—
Out of Town Gas Companies.				
Buffalo Mutual, N. Y.....	750,000	100	80	85
“ Bonds.....	200,000	1000	95	100
Citizens, Newark.....	918,000	50	103	115
“ Bonds.....	124,000	—	105	110
Chicago Gas Co., Ills.....	5,000,000	25	125	—
Peoples G. L. & C. Co., Chicago, Ills.....			8	12
Cincinnati G. & C. Co.....			180	182
Consolidated, Balt.....	6,000,000		82½	83
“ Bonds.....	3,600,000		110	111½
Central, S. F., Cal.....			—	58
Capital, Sacramento, Cal.....			55½	—
Hartford, Conn.....	750,000	25	122	128
Jersey City.....	750,000	20	124	128
Laclede, St. Louis, Mo.....	1,600,000	100	88	—
Louisville, Ky.....	1,500,000	50	95	100
Montreal, Canada.....	2,000,000	100	181	182½
New Haven, Conn.....			25	166
Oakland, Cal.....			29	30
Peoples, Jersey City.....			—	75
“ Bonds.....			—	—
Paterson, N. J.....			25	96
Rochester, N. Y.....			50	75
Washington, D. C.....	2,000,000	20	190	195
Wilmington, Del.....			50	188
Yonkers.....			50	90
St. Louis, Missouri.....	600,000	50	340	—
San Francisco Gas Co.				
San Francisco, Cal.....			58¼	59

Advertisers Index.

	Page
GAS ENGINES.	
Jos. R. Thomas, New York City.....	78
Wm. Henry White, New York City.....	72
GAS WORKS APPARATUS AND CONSTRUCTION.	
James R. Floyd, New York City.....	79
T. F. Rowland, Greenpoint, L. I.....	79
Delly & Fowler, Phila., Pa.....	79
Kerr Murray Mfg. Co., Fort Wayne, Ind.....	79
Stacey Mfg. Co., Cincinnati, Ohio.....	79
Bartlett, Hayward & Co., Baltimore, Md.....	79
Morris, Tasker & Co., Limited, Phila., Pa.....	78
Davis & Farnum Mfg. Co., Waltham, Mass.....	74
Tanner & Delaney Engine Co., Richmond, Va.....	72
R. D. Wood & Co., Phila., Pa.....	72
GAS AND WATER PIPES.	
A. H. McNeal, Burlington, N. J.....	78
Gloucester Iron Works, Phila., Pa.....	78
Warren Foundry and Machine Co., Phillipsburgh, N. J.....	78
Mellert Foundry and Machine Co., Reading, Pa.....	78
Cincinnati and Newport Iron and Pipe Co., Newport, Ky.....	78
SCRUBBERS AND CONDENSERS.	
G. Shepard Page, New York City.....	77
REGENERATOR FURNACES.	
Charles F. Dieterich, Baltimore, Md.....	46

RETORTS AND FIRE BRICK.

J. H. Gautier & Co., Jersey City, N. J.....	76
B. Kreischer & Sons, New York City.....	76
Adam Weber, New York City.....	76
Laclede Fire Brick Works, St. Louis, Mo.....	76
Brooklyn Retort and Fire Brick Works, Brooklyn, N. Y.....	76
Borgner & O'Brien, Phila., Pa.....	76
William Gardner & Son, Pittsburgh, Pa.....	76
Henry Maurer, New York City.....	76
Chicago Retort and Fire Brick Works, Chicago, Ills.....	76
Baltimore Retort and Fire Brick Co., Baltimore, Md.....	76
Standard Gas Retort and Fire Brick Co., Ironton, Ohio.....	76
Oakhill Gas Retort and Fire Brick Co., St. Louis, Mo.....	76
Cincinnati Gas Retort & Fire Brick Co., Cincinnati, O.....	72

GAS STOVES.

American Meter Co., New York and Philadelphia.....	19
The Goodwin Gas Stove and Meter Co., Philadelphia, Pa.....	84

VALVES.

Ludlow Valve Manufacturing Co., Troy, N. Y.....	78
McNab & Harlin Mfg Co., New York City.....	46
John McLean, New York City.....	72

GAS METERS.

Harris, Griffin & Co., Phila., Pa.....	82
American Meter Co., New York and Philadelphia.....	83
The Goodwin Gas Stove and Meter Co., Phila. Pa.....	83
Helme & McIlhenny, Phila., Pa.....	83
Maryland Meter and Mfg. Co., Baltimore, Md.....	82
D. McDonald & Co. Albany, N. Y.....	83
Nathaniel Tufts, Boston, Mass.....	82

EXHAUSTERS.

P. H. & F. M. Roots, Connersville, Ind.....	73
Smith & Sayre Manufacturing Co., New York City.....	80
Wilbraham Bros., Philadelphia, Pa.....	80

GAS COALS.

Penn Gas Coal Co., Phila., Pa.....	81
Perkins & Co., New York City.....	80
Newburgh Orrel Coal Co., Baltimore Md.....	81
Despard Coal Co., Baltimore, Md.....	81
Chesapeake and Ohio R.R. Coal Agency, N. Y. City.....	81
Westmoreland Coal Company, Phila., Pa.....	81

GAS ENGINES.

Schleicher, Schumm & Co., Phila., Pa.....	56
Continental Gas Engine Co. New York City.....	44

GAS LAMPS.

Siemens Regenerative Gas Lamp Co., Philadelphia, Pa.....	77
G. Shepard Page, New York City.....	81

GAS KILNS AND OVENS.

Thompson Gas Kiln and Oven Co., New York City.....	72
--	----

PURIFIER SCREENS.

John Catot, Lawrence, Mass.....	44
---------------------------------	----

STREET LAMPS.

J. G. Miner, Morrisania, New York City.....	45
Bartlett Street Lamp Mfg Co., New York City.....	73
Geo. D. Wheelwell Mfg Co., Cincinnati, Ohio.....	73

BURNERS.

G. Gevrotter, Phila., Pa.....	78
Walter Anderson, New York City.....	50

PURIFYING MATERIAL.

Connelly & Co., New York City.....	73
------------------------------------	----

STEAM BLOWER FOR BURNING BREASE.

H. E. Parson, New York City.....	74
----------------------------------	----

PIPE COVERINGS.

Chalmers-Spence Company, N. Y. City.....	72
--	----

GAS FIXTURES.

Mitchell, Vance & Co., New York City.....	73
---	----

STEAM ENGINES.

Westinghouse Machine Co., Pittsburgh, Pa.....	81
---	----

STEAM PUMPS.

A. S. Cameron Steam Pump Works, N. Y. City.....	73
---	----

PIPE CUTTING MACHINE.

Pancoast & Maule, Philadelphia, Pa.....	72
---	----

HYDRAULIC ELEVATOR.

Lane & Bodley Company, Cincinnati, Ohio.....	78
--	----

SHAFTING, PULLEYS, ETC.

A. & F. Brown, New York City.....	72
-----------------------------------	----

BOOKS.

The Chemist's Assistant.....	72
King's Treatise.....	74
Scientific Books.....	82
Fodell's Book-Keeping.....	74
Management of Small Gas Works.....	74
Newbigging's Gas Manager's Handbook.....	76

**FOR SALE,
100 MINER GLOBE STREET LAMPS.**

The lamps have been in use, but only those that are in good order are offered for sale. For terms, etc., address
THE NEW YORK & NEW JERSEY GLOBE GAS LIGHT CO.,
615-tf No. 1 Park Place, New York City.

WANTED,

A Manager Capable of Taking Charge of a Small Works.

Address, giving references and salary required,

HELENA GAS LIGHT AND COKE CO.,

614-2t

HELENA, MONTANA.

CINCINNATI

Gas Retort & Fire Brick Co.,

(ESTABLISHED 1872.)

CINCINNATI, OHIO.

Manufacturers of Gas Retorts, Retort Settings, Fire Brick, Tiles, Etc.

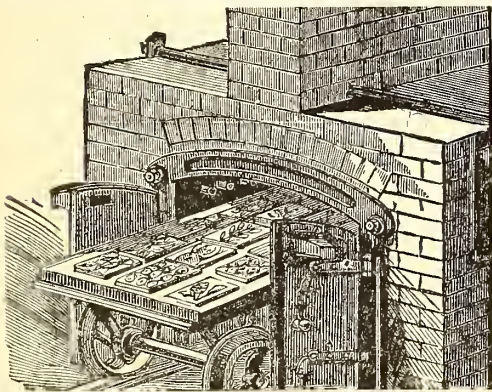

Glass-Staining Gas Kiln.

BAKERS' & CONFECTIONERS' OVENS (PAT.)

Thompson Gas Kiln & Oven Co.

59 Carmine St., N. Y.

Send for Circular by mail.

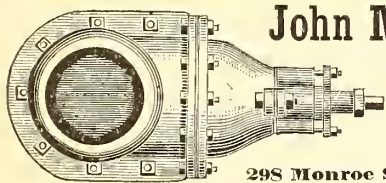

John McLean

Manufacturer of

GAS VALVES.

298 Monroe Street, N. Y.

WM. FARMER, ENGINEER,
32 Park Place, Room 36, New York.
THE CHEMIST'S ASSISTANT; OR, KINDERGARTEN SYSTEM OF CHEMISTRY.
A system by which the elements and their valences are represented by illustrations and solid bodies.
BOX AND PAMPHLET COMPLETE, \$2.50.

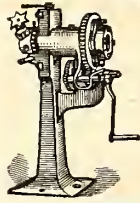

**"ECLIPSE"
HAND PIPE-CUTTING MACHINE.**

Nos. 2 and 3.

Simple, powerful, portable, inexpensive. With it one man can easily cut 6 inch Pipe.

No. 2 Cuts and Screws 2 1/2 to 4 in.
No. 3 " " " 2 1/2 to 6 in.

PANCOAST & MAULE,
[Mention this Paper.] Philadelphia.

WM. HENRY WHITE,
Consulting & Constructing
Gas Engineer & Contractor.

ESTIMATES, PLANS, AND SPECIFICATIONS FURNISHED FOR NEW WORKS OR EXTENSIONS OF EXISTING WORKS.

32 Pine St., New York City.

Correspondence solicited.

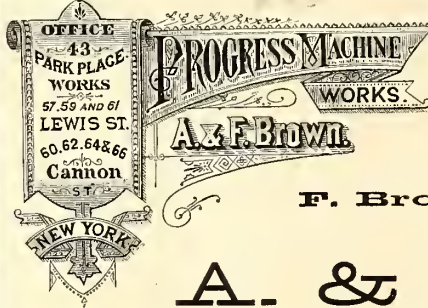

**Shafting, Pulleys,
HANGERS.**

F. Brown's Patent Friction Clutch.

Send for Illustrated Catalogue and Discount Sheet to

A. & F. BROWN,

No. 43 Park Place, New York City.

Pipe Coverings.

Fireproof, Non-Conducting Coverings for
STEAM PIPES, BOILERS,
And all Hot Surfaces.

Made in sections three feet long. Easy to apply; light and cheap. Asbestos Materials, Fibre, Braided Packing, and Cement. These goods are used at Continental Works, Br'klyn.

CHALMERS-SPENCE COMPANY, 419 & 421 EIGHTH ST., N. Y.



W. E. Tanner, Pres., W. R. Trigg, V.-Pres., A. Delaney, Supt.

Tanner & Delaney Engine Co.
RICHMOND, VA.

Gas Apparatus,

INCLUDING
Condensers of various styles, Scrubbers, Holders, Purifiers, Castings for Retort Houses, Etc.

ALSO STEAM ENGINES AND BOILERS.
Plans, Specification and Estimates Furnished.

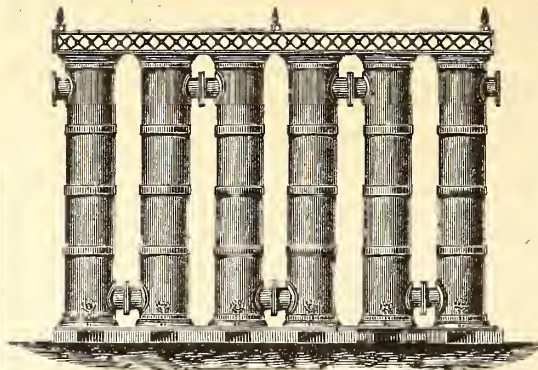

R. D. WOOD & CO.,

400 Chestnut Street, Phila., Pa.

Cast Iron Gas & Water Pipe, Water Machinery & Gas Apparatus

Cast Iron Pipe, Fire Hydrants, Eddy Valves, Lamp Posts, Large Loam Castings, Flanged Pipe, Sugar House Work, Iron Roofs and Floors, Wrought & Cast Iron Tanks, Turbine Water Wheels and Pumps.

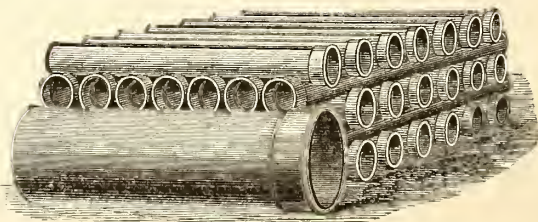

Casholders, Lime Trays, Center Valves, Purifiers, Bench Work, Exhausters, Condensers, Governors, Scrubbers, Gas Valves, Station Meters, Cast Iron Pipe Fittings.

Manufacturers of Heavy Castings and Machinery of Every Description.

ENGINEERS & CONTRACTORS FOR THE ERECTION OF GAS WORKS, & ALL MACHINERY CONNECTED THEREWITH

Estimates and specifications furnished for erection of new works or the extension or alteration of old ones.

Foundries and Works, - - Millville, Florence, and Camden, N. J.

C. BARCALOW, PREST. J. V. BARCALOW, SEC. & TREAS.

BARTLETT Street Lamp Mfg. Co.

MANUFACTURERS OF

Bartlett's Patent

GLOBE LAMPS,

FOR

Streets, Parks, Railroad Stations, Public Buildings, Etc.

LAMP POSTS A SPECIALTY.

Office and Salesroom,
No. 35 Howard Street, N. Y. City.

Gas Companies and others intending to erect lamps and posts will do well to communicate with us.

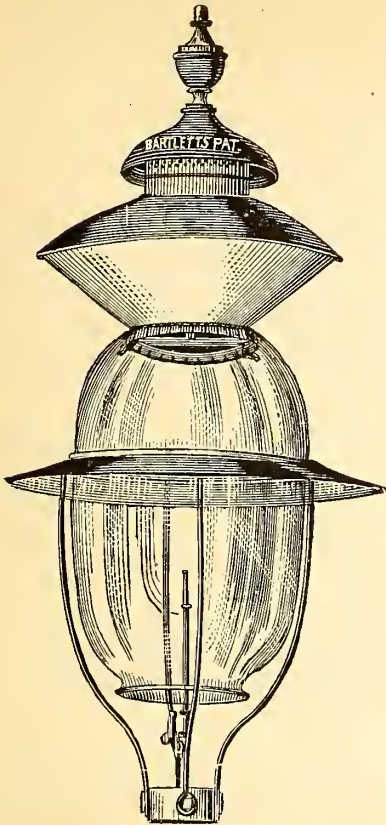

STREET LAMPS.

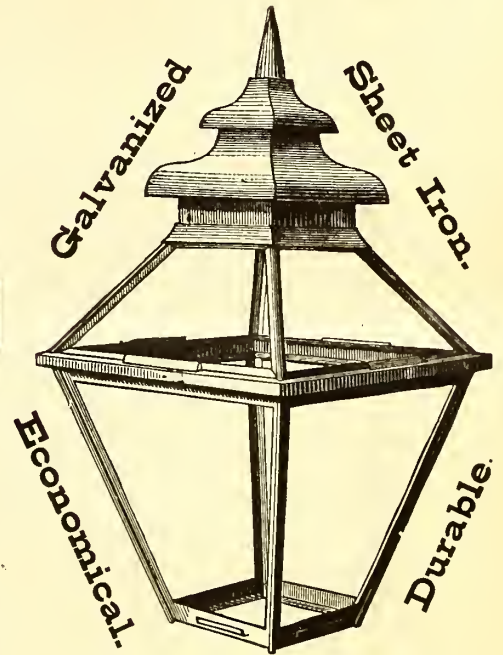

MANUFACTURED BY THE

Geo. D. Winchell Mfg. Co.,

Cor. Bank & Riddle Streets,
CINCINNATI, OHIO.

F. M. ROOTS.

S. C. ROOTS

D. T. ROOTS.

P. H. & F. M. ROOTS
PATENTEES AND MANUFACTURERS OF

GAS VALVES, BY-PASS VALVES, EXHAUSTER-GOVERNORS

PIPE-FITTINGS, & ALL FIXTURES FOR EXHAUSTER ROOMS.

IMPROVED GAS EXHAUSTER,

WITH ENGINE ON SAME BED PLATE, OR WITHOUT.

BY-PASSES, GAS VALVES, GOVERNORS, ELBOWS, PIPE-FITTINGS, Etc., FURNISHED TO ORDER,

P. H. & F. M. ROOTS, Patentees & Manufacturers, **CONNERSVILLE, IND.**

S. S. TOWNSEND, General Agent, 22 Cortland St. and 9 Dey St., N. Y.

JAS. BEGGS & CO., Selling Agents, 9 Dey St., N. Y.

COOKE & CO., Selling Agents, 22 Cortland St., N. Y.

✧ SEND FOR ILLUSTRATED CATALOGUE AND PRICE LIST. ✧

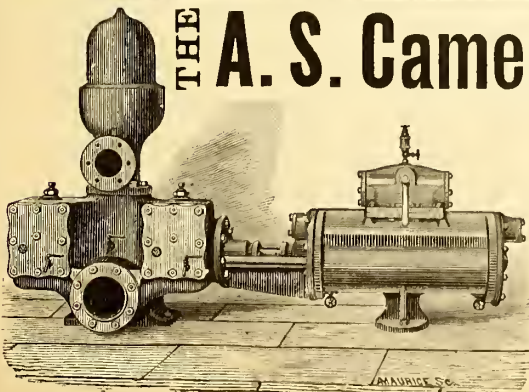

THE A. S. Cameron Steam Pump,

THE STANDARD OF EXCELLENCE.

Upward of 30,000 in Use.

BEST GAS WORKS PUMP
Ever Introduced.

Adapted to Every Possible Duty.

A. S. Cameron Steam Pump Works,

Foot East 23d St., N. Y.

MITCHELL, VANCE & CO.,

MANUFACTURERS OF

Chandeliers

and every description of

GAS FIXTURES.

Also manufacturers of Fine Gilt Bronzes and Marble Clocks warranted best time-keepers. Mantel Ornaments, etc.

Salesrooms, 836 Broadway, N. Y.

Special Designs furnished for Gas Fixtures for Churches, Public Halls, Lodges, etc.

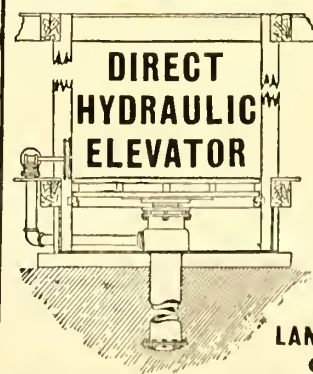

With Iron or Wood Platform.

Largely used by Leading Gas Co.s for Coal and Coke Lifts.

Adapted for use with city service, or special pumping and accumulator system. For prices address the

LANE & BODLEY CO.,
Cincinnati, O.

Iron Sponge, GAS EXHAUSTERS,

AUTOMATIC GAS GOVERNORS,

CONNELLY & CO., Limited,

No. 407 BROADWAY, NEW YORK CITY.

F. J. DAVIS & J. R. FARNUM,

TRUSTEES AND AGENTS FOR THE

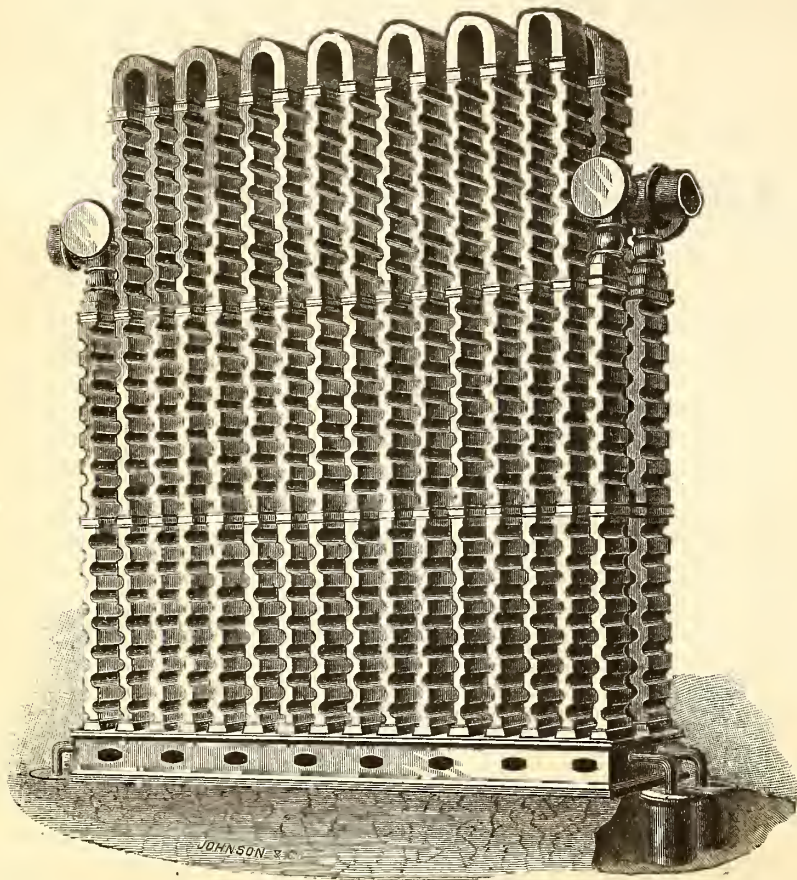
SINUOUS FRICTION CONDENSER.

We desire to draw the attention of the gas community to the merits of the **SINUOUS FRICTION CONDENSER**. Companies intending to introduce new condensers into their works will do well to confer with us and examine plans and estimates before contracting for any other pattern. The **FRICTION CONDENSER** is now in use at the gas works located in the following places:

Portland, Me.	Brookline, Mass.	Pawtucket, R. I.	Frederickton, N. B.
Newport, R. I.	Chelsea, Mass.	Jamaica Plain, Mass.	St. John, N. B.
Gloucester, Mass.	Woburn, Mass.	Attleboro, Mass.	Paterson, N. J.
Newton & Water- town, Mass.	Peoria, Ill.	Calais, Me.	Dover, N. H.
	Clinton, Mass.	Fall River, Mass.	Waltham, Mass.
		Nassau Works, Brooklyn, N. Y.	

DAVIS & FARNUM MFG. CO.

MANUFACTURERS OF

Gas and Water Pipes,

AND

GAS AND WATER MACHINERY

OF THE MOST APPROVED PATTERN.

Also, Gasholders and Iron Roofing.*Orders from Gas and Water Companies promptly attended to.***WALTHAM, MASS.**

Boston Office, Room 55, Mason Building, 70 Kilby Street.

Parson's Steam Blower,

FOR IMPROVING BAD DRAUGHT IN BOILERS, AND FOR BURNING BREEZE OR OTHER WASTE MATERIAL.

PARSON'S TAR BURNER.

FOR UTILIZING COAL TAR AS FUEL.

PARSON'S AIR JET TUBE CLEANER,

FOR CLEANING BOILER TUBES.

These devices are all first-class. They will be sent to any responsible party *for trial*. No sale unless satisfactory. Manufactured by the **WATERTOWN STEAM BLOWER COMPANY**.

H. E. PARSON, Supt., 42 PINE ST., N. Y.**King's Treatise on Coal Gas.**

The most complete work on Coal Gas ever published.

Three Vols. Bound, \$30.

A. M. CALLENDER & CO., 42 Pine St., N. Y.**CATHELL'S****Gas Consumer's Manual.**

Enables every gas consumer to ascertain at a glance, without any previous knowledge of the gas meter, the quantity and money value of the gas consumed. Also the best method of obtaining from gas the largest amount of its light. It will be to the advantage of Gas Companies to supply their consumers with one of these Guides, as a means of preventing complaint arising from their want of knowledge in regard to the registration of meters.

A. M. CALLENDER & CO., 42 Pine St., N. Y.**BOOKS.****DISTILLATION OF COAL TAR AND AMMONIACAL LIQUOR.**By **GEORGE LUNGE**. Price \$8.50.**A TREATISE ON THE COMPARATIVE COMMERCIAL VALUES OF GAS COALS AND CANNELS.**By **DAVID A. GRAHAM**. 8vo., Cloth. Price \$3.

Orders for these books may be sent to this office.

A. M. CALLENDER & CO.,
42 PINE ST., N. Y. CITY.**FODELL'S System of Bookkeeping**

FOR GAS COMPANIES.

Price \$5, which should be sent either in Check P. O. Ord or Registered Letter.

Blank Books, with printed headings and forms on this system, will be supplied to Gas Companies, by applying to **W. P. BELL** Philadelphia, or**A. M. CALLENDER & CO**
OFFICE GAS LIGHT JOURNAL 42 Pine St., N. Y.**The Management of Small Gas Works.**BY **C. J. R. HUMPHREYS.**

Price, \$1.

Orders to be sent to **A. M. CALLENDER & CO.,**
42 PINE STREET, NEW YORK.**PRESERVE****The Journal**

BY THE USE OF

THE STRAP FILE.

Advantages of the Strap File.

- 1st. It is simple, strong, and easily used.
- 2d. Preserves papers without punching holes.
- 3d. Will always lie flat open.
- 4th. Allows any paper on file to be taken off without disturbing the others.

Price, \$1.25. Sent either by express or mail, as directed. By mail the postage will be 20 cents which will be added to the price of the Binder.

A. M. CALLENDER & CO., 42 PINE ST., N. Y.

THE AMERICAN METER COMPANY,

MANUFACTORIES,

512 West Twenty-second Street, N. Y.

Arch and Twenty-second Street, Phila.

Nos. 244 & 246 North Wells Street, Chicago, Ill.

AGENCIES,

No. 177 Elm Street, Cincinnati, Ohio.

Nos. 122 & 124 Sutter Street, San Francisco, Cal.

No. 810 North Second Street, St. Louis, Mo.

ALL SIZES
CONSTANTLY
IN STOCK.

PRICE LISTS
ON
APPLICATION.

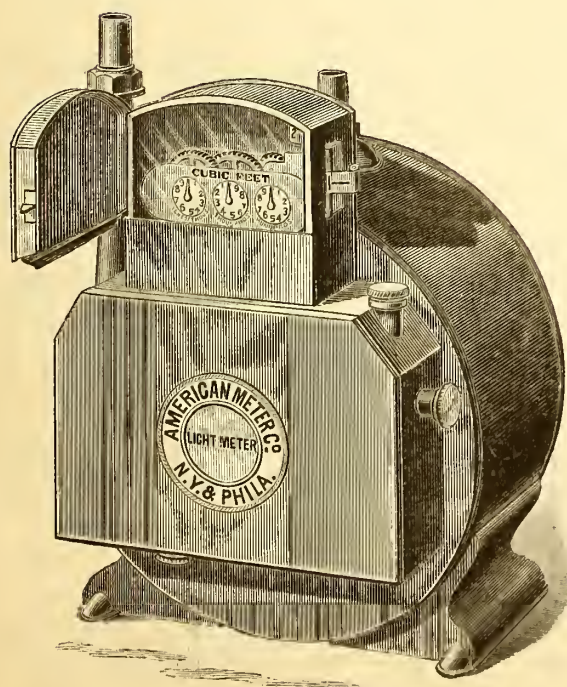
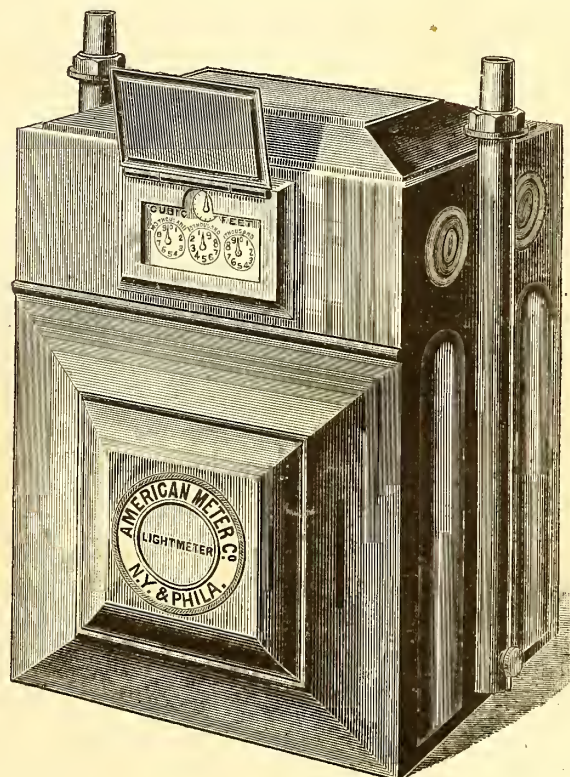

Mfr's of STANDARD WET AND DRY GAS METERS.

J. H. GAUTIER & CO.,
 CORNER OF
 GREENE AND ESSEX STREETS,
JERSEY CITY, N. J.
 MANUFACTURERS OF

**Clay Gas Retorts,
 Gas House Tiles,
 Fire Bricks, Etc. Etc.**
 Ground Clay, Fire Brick and
 Fire Sand in Barrels,

J. H. GAUTIER. T. B. GAUTIER.
 C. E. GREGORY. C. E. GAUTIER.

BROOKLYN
Clay Retort & Fire Brick Works,
 (EDWARD D. WHITE & CO.)
 Manufacturers of Clay Retorts, Fire Brick,
 Gas House and other Tile.
 VAN DYKE, ELIZABETH, RICHARDS & PARTITION STS.
 Office, 88 Van Dyke St., Brooklyn, N. Y.

LAGLEDE FIRE BRICK MFG. CO.,
 MANUFACTURERS OF

Fire Brick, Gas Retorts,
 AND
ST. LOUIS STANDARD SEWER PIPE.
 Blast Furnace and Cupola Linings, every description of Fire
 Clay Material, Fire Clay Flue Linings, Chimney Tops
 Dry Milled and Crude Fire Clays, etc.

OFFICE AND DEPOT
 901, 903, and 905 Pine Street,
 ST. LOUIS, MO.

ESTABLISHED IN 1845.

B. KREISCHER & SONS,

OFFICE FOOT OF HOUSTON ST., E. R., N. Y.

Gas Retorts,

TILES, FIRE BRICK.

AND EVERYTHING IN THE FIRE CLAY LINE.

MANHATTAN
 FIRE BRICK & ENAMELLED CLAY
RETORT WORKS.
ADAM WEBER.

**CLAY GAS RETORTS
 AND RETORT SETTINGS,
 FIRE BRICKS, TILES, ETC.,**

Office and Works, 15th Street and Avenue C., N. Y.

Borgner & O'Brien,

MANUFACTURERS OF

**CLAY GAS RETORTS
 AND RETORT SETTINGS,
 FIRE BRICKS, TILES, ETC.**

23d St., Above Race,

PHILADELPHIA.

TWENTY YEARS' PRACTICAL EXPERIENCE.

JAMES GARDNER, JR.
 Works,
 LOCKPORT STATION, PA.

—ESTABLISHED 1864.—
WILLIAM GARDNER & SON,
 Successor to GARDNER BROTHERS.

WILLIAM GARDNER.
 Office, COAL EXCHANGE,
 PITTSBURGH, PA., P. O. Box 373.

Fire Clay Goods for Gas Works.

C. H. SPRAGUE, No. 70 KILBY STREET, BOSTON, MASS., Agent for the New England States.

OFFICE, 418 to 422 East 23d St., New York.

ESTABLISHED 1856.

WORKS, PERTH AMBOY, NEW JERSEY.

HENRY MAURER,
Excelsior Fire Brick & Clay Retort Works
 CLAY GAS RETORTS, BENCH SETTINGS, FIRE BRICK, TILES, ETC.

STANDARD GAS RETORT AND FIRE BRICK COMPANY,
 J. ANDERSON, PRES. & MANG'R. OF IRONTON, OHIO. C. PETERS, SECRETARY.
Clay Gas Retorts, Fire Brick, and Fire Clay Goods of Every Description.
 Plans of Livesey-Somerville, McIlhenny, and other Furnaces, and Competent Workmen Supplied.

CHICAGO
Retort & Fire Brick Works,
 Office, Factory,
 79 Dearborn St., Unity Building. | 45th and Clark Sts.
 CHICAGO, ILL.
 GEORGE C. HICKS, PRES. PAUL P. AUSTIN, SEC. & TREAS.
STANDARD
Clay Retorts and Settings.
BLOCKS & TILES
 of every Shape and Size to Order.
Standard Fire Bricks.

NEWBIGGING'S
Gas Manager's Handbook.
Price, \$4.80.

EVERY GAS MAN SHOULD HAVE ONE.
 Orders may be sent to this Office.

OAKHILL
GAS RETORT & FIRE BRICK
 COMPANY.

PARKER, RUSSELL & CO.
 City Office, 45th & Clark Sts,
 ST. LOUIS, MO.

Our immense establishment is now employed almost entirely in
 the manufacture of
MATERIALS FOR GAS COMPANIES.

We have studied and perfected three important points. Our re-
 torts are made to stand changes of temperature, the strongest
 heats of the furnace, and the abrasion of feeding and emptying.
 Our customers are in almost every State of the Union, to all of
 whom we refer.

THOS. SMITH, Presl. AUGUST LAMBLA, Vice-Prest. & Sup
BALTIMORE
RETORT & FIRE BRICK CO.

MANUFACTORY AT
 LOCUST POINT, BALTIMORE, MD.
 Connection with the City by Telephone.
**Clay Retorts, Blocks & Tiles,
 FIRE BRICK, FIRE CLAY,
 AND FIRE CEMENT.**

Red and Buff Ornamental Tiles and Chim-
 ney Tops. Drain and Sewer Pipe (from
 2 to 30 inches). Baker Oven Tiles
 12 x 12 x 2 and 10 x 10 x 2.

WALDO BROS., 88 WATER ST., BOSTON, MASS.
 Sole Agents for New England States

Siemens's Regenerative Gas Burners, For Lighting and Ventilating.

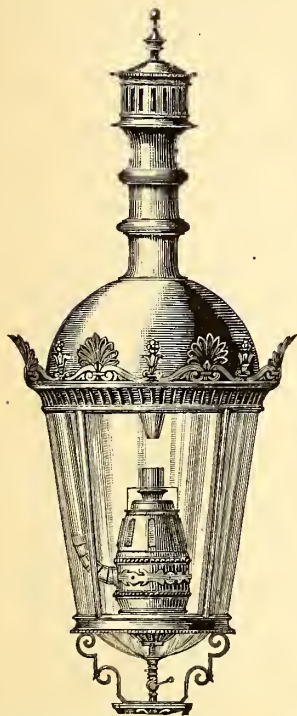

THE CHEAPEST, PUREST, AND MOST BRILLIANT OF ALL GAS LIGHTS.

Superior to the Electric Light in Economy, Beauty, & Steadiness.

SPECIALLY ADAPTED FOR LIGHTING HALLS, FACTORIES, OPEN SPACES, ETC.

Numerous Tests made by various Gas Companies in the United States show an Efficiency of Ten Candle Power per Cubic Foot of Gas.

General Agents:

SIEMENS LIGHTING CO., 347 West Main St., Louisville, Ky.
 MEYER, MARSHALL & CO., 528 California St., San Francisco.
 DENNEHY, WOLF & O'BRIEN, 85 & 87 Dearborn St. Chicago, Ill.
 WILCOX & McGEARY, - No. 11 Bissel Block, Pittsburgh, Pa.
 T. T. RAMSDALL & CO., - 20 Swan Street, Buffalo, N. Y.
 SIEMENS GAS ILLUMINATING CO.,
 Room 6, No. 157 Broadway, New York City.
 W. D. COLT, - - - 1420 F Street, Washington, D. C.
 JOHN KIEFER, - - - 344 Lawrence, Street, Denver, Col.

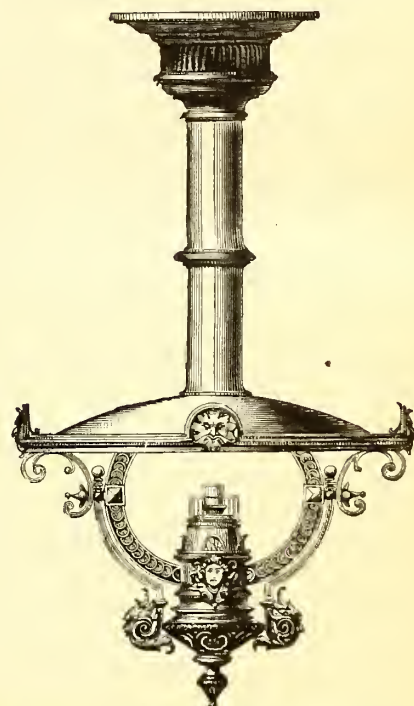

THE SIEMENS REGENERATIVE GAS LAMP COMPANY.

SOLE MAKERS FOR THE UNITED STATES,

N. E. Cor. 21st. St. and Washington Av., Philadelphia, Pa.

THE "STANDARD" WASHER-SCRUBBER, KIRKHAM, HULETT & CHANDLER'S PATENT.

Total Capacity per 24 Hours of "Standard" Washers Ordered During the Following Years.

1877.....	4,000,000	cubic feet.
1878.....	4,750,000	"
1879.....	24,545,000	"
1880.....	42,967,500	"
1881.....	36,462,500	"
1882.....	39,300,000	"
1883.....	57,735,000	"
1884.....	26,177,500	"
Total.....	235,937,500	cubic feet.

Total Number and Capacity per 24 Hours of "Standard" Washers Erected and in Course of Erection in the Several Countries

	Number.	Cubic Feet per Day.
Great Britain..	151	157,070,000
Western Hemisphere.....	38	39,337,500
Australia.....	18	12,150,000
New Zealand.....	2	650,000
France.....	6	4,550,000
Belgium.....	8	5,420,000
Germany.....	16	8,200,000
Holland.....	4	4,160,000
Denmark.....	1	150,000
Russia.....	2	3,500,000
Spain.....	1	350,000
India.....	1	400,000
Total.....	248	235,937,500

THE CONTINUED POPULARITY

Of these Machines

Will be recognized from the following extracts from letters from representatives of some of the companies having them in use:

TOLEDO GAS LIGHT AND COKE CO., }
 TOLEDO, OHIO, NOV. 25, 1884. }

GEO. SHEPARD PAGE, Esq.:

Dear Sir—Replying to your kind favor of 21st inst., I would say that the "Standard" Washer-Scrubber is doing work that is entirely satisfactory to us. During the summer I had 12-oz. liquor; but since cool weather commenced I have been having from 18 to 23-oz. liquor, just as we would elect. There is not a trace of ammonia passing the Scrubber that a test of reddened litmus or yellow turmeric paper would indicate. The machine, in my opinion, is all that could be desired as a means for removing all the ammonia from the gas.

Very respectfully,

C. R. FABEN, Jr.,

Superintendent.

"Standard" Washers Ordered During the Current Year.

	Cu. Ft. per Day
Anneberg Gas Co.....	200,000
Bombay Gas Co.....	400,000
Brussels Co.....	1,250,000
Chemnitz Gas Co.....	1,000,000
CITIZENS GAS CO., BUFFALO.....	750,000
Coke Works in Zabre, Ober-Schlesien.....	1,500,000
Cokereif der Friedenshutte, Upper Silesia.....	700,000
Dumfries Corporation.....	250,000
Dunedin Gas Co., New Zealand.....	400,000
King's Lynn Gas Co.....	300,000
Leiden, Holland.....	600,000
Lincoln Gas Co.....	400,000
Liverpool Gas Co.....	2,000,000
" ".....	3,000,000
LOUISVILLE GAS CO.....	1,500,000
Numea Gas Co.....	100,000
PITTSBURGH GAS CO.....	1,500,000
PORTLAND GAS CO., Oregon.....	562,500
SAN FRANCISCO GAS CO.....	4,000,000
Sheepbridge.....	40,000
St. Louis Gas Co.....	2,000,000
Sydney Gas Co.....	2,500,000
WASHINGTON, D. C. GAS CO.....	2,000,000
Whitchurch Gas Co.....	175,000
Total.....	26,177,500

GEO. SHEPARD PAGE, No. 69 WALL STREET, NEW YORK,

SOLE AGENT FOR THE WESTERN HEMISPHERE.

A. H. M'NEAL,

BURLINGTON, N. J.

Flange-Pipes

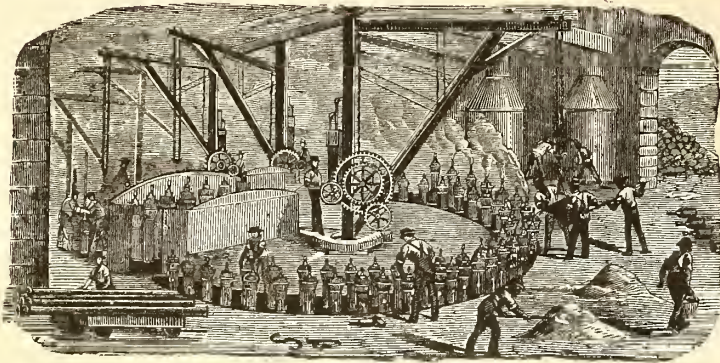

General Foundry Work.

CAST IRON PIPES

FOR WATER AND GAS.

JAMES S. MOORE, Pres.
BENJAMIN CHEW, Treas.

JAS. P. MICHELLON, Sec.
WM. SEXTON, Supt.

GLOUCESTER IRON WORKS, GLOUCESTER CITY N. J.

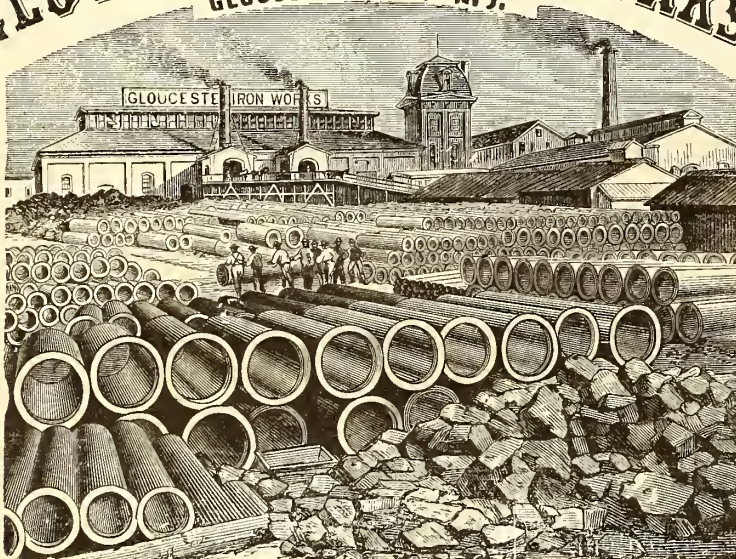

Cast Iron Gas & Water Pipes, Stop Valves, Fire Hydrants, Gasholders. &c.

Office No. 6 North Seventh Street, Philadelphia.

ESTABLISHED 1856.

WARREN FOUNDRY AND MACHINE CO.,

WORKS AT PHILLIPSBURGH, N. J.
NEW YORK OFFICE, 162 BROADWAY.

Cast Iron Water and Gas Pipe

FROM TWO TO FORTY-EIGHT INCHES DIAMETER.
ALSO ALL SIZES OF

FLANGE PIPE for Sugar House and Mine Work.
Branches, Bends, Retorts, Etc., Etc.

MATTHEW ADDY, President.

W. L. DAVIS, Selling Agent.

GEO. P. WILSHIRE, Sec. & Treas.

Cincinnati and Newport Iron and Pipe Company,

NEWPORT, KY.

Lamp Posts
AND
BENCH CASTINGS

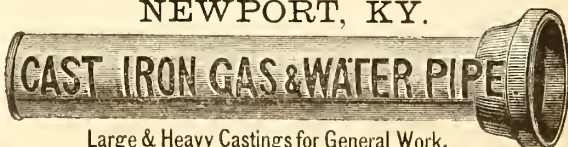

Branch
AND
SPECIAL CASTINGS

A Specialty.

Large & Heavy Castings for General Work.

FOR GAS & WATER CO'S.

Manufacture Pipe from 2 to 48 inches. All work guaranteed first quality.

Mellert Foundry and Machine Co.

Limited. Established 1848.
MANUFACTURERS OF



Specials—Flange Pipe, Valves and Hydrants,
Lamp Posts, Retorts, etc.
Machinery and castings for Furnaces, Rolling Mills, Grist and
Saw Mills, Mining Pumps, Hoists, etc.

GENERAL OFFICE, - - - READING, PA.

To Gas Companies.

We make to order **CAP BURNERS** to burn any amount
under a stated pressure. Send for samples.

Also, **SERVICE CLEANERS, DRIP PUMPS,** and **STREET
MAIN PROVING APPARATUS.**

C. A. GEFROERER,

248 N. 8th Street, Phila., Pa.

MORRIS, TASKER & CO., Limited,

Builders of Gas Works,
PHILADELPHIA, PA.

LUDLOW VALVE MFG. CO

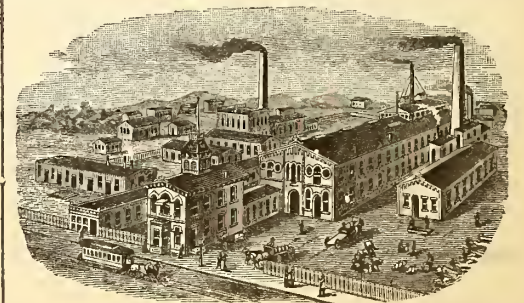

OFFICE AND WORKS,

938 to 954 River Street and 67 to 83 Vail Av.

TROY, N. Y.

Hydraulic Main Dip Regulators, also
Check Valves, Foot Valves, Yard-
wash and Fire Hydrants.
Send for Circulars.

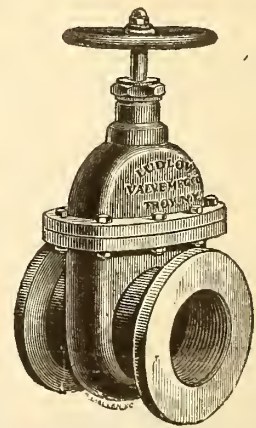

Valves.—Double and Single Gate, 1/2 in. to
48 in., outside and inside Screws. Indica-
tor, etc., for Gas, Water, Steam, and Oil.
Send for Circulars.

JOS. R. THOMAS, C.E.,

May be Consulted on all Mat-
ters Relating to Gas Works
and Gas Manufacture.

ADDRESS THIS OFFICE.

To Non-Paying GAS COMPANIES.

A Gas Engineer of 16 years' experience desires a position with
some Gas Light Company at present not paying to investors,
with a view of placing same on a paying basis. Understands
thoroughly the most economical modes of producing coal gas, as
well as the disposal of all residuals. Would accept the manage-
ment of a small works, with full charge of all books, accounts,
meter statements, etc. Address, for one week,
"A. T.," care this Office.

KERR MURRAY MFG. CO.,

MANUFACTURERS OF

Single Lift and Telescopic

GASHOLDERS.

Built, 1884:

Altoona, Pa.....	Capacity, 160,000 cubic feet.
Pittsburgh, Pa.....	" 250,000 "
" ".....	" 220,000 "
Bellaire, Ohio.....	" 50,000 "
Youngstown, Ohio.....	" 60,000 "
Canton, ".....	" 60,000 "
Akron, ".....	" 80,000 "
Xenia, ".....	" 10,000 "
Adrian, Mich.....	" 65,000 "
Ypsilanti, Mich.....	" 25,000 "
Muskegon, ".....	" 70,000 "
South Bend, Ind.....	" 70,000 "
Anderson, ".....	" 20,000 "
Plainfield, ".....	" 10,000 "
Springfield, Illinois.....	" 100,000 "
Evanston, ".....	" 50,000 "
Freeport, ".....	" 35,000 "
Elgin, ".....	" 60,000 "
Sheboygan, Wis.....	" 20,000 "
Key West, Fla.....	" 10,000 "

Plans and estimates furnished for the erection of new and the rebuilding of old works. Address

Kerr Murray Mfg. Co.,

FORT WAYNE, IND.

JAMES R. FLOYD,

(SUCCESSOR TO HERRING & FLOYD)

Oregon Iron Works,

531 to 543 West 20th St., N. Y.

Practical Builders of Gas Works,

MANUFACTURERS OF

ALL KINDS OF CASTINGS

AND

APPARATUS FOR GAS-WORKS.

BENCH CASTINGS

from benches of one to six Retorts each.

WASHERS: MULTITUBULAR AND

AIR CONDENSERS; CONDENSERS;

SCRUBBERS

(wet and dry), and

EXHAUSTERS

for relieving Retorts from pressure.

BENDS and BRANCHES

of all sizes and description.

FLOYD'S PATENT

MALLEABLE RETORT LID.

PATENT

SELF-SEALING RETORT LIDS.

FARMER'S

PATENT BY-PASS DIP-PIPE.

SABBATON'S PATENT

FURNACE DOOR AND FRAME.

BUTLER'S

COKE SCREENING SHOVELS.

GAS GOVERNORS,

and everything connected with well regulated Gas Works at low price, and in complete order.

SELLER'S CEMENT

for stopping leaks in Retorts.

N. B.—STOP VALVES from three to thirty inches—at very low prices.

Plans, Specifications, and Estimates furnished.

CONTINENTAL WORKS.

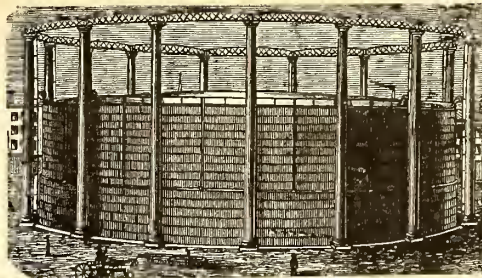

GASHOLDERS OF ANY MAGNITUDE.

T. F. ROWLAND, Proprietor,
GREENPOINT, BROOKLYN, N. Y.

ENGINEER AND MANUFACTURER OF

GAS-HOLDERS.

CONDENSERS, SCRUBBERS, VALVES,

PURIFIERS, RETORTS. and HY-

DRAULIC MAINS,

and all other articles connected with the Manufacture Distribution of Gas. Plans and Specifications prepared and Proposals given for the necessary Plant for Lighting Cities, Towns, Mansions, and Manufactories.

H. RANSHAW, Prest. & Mangr. WM. STACEY, Vice-Pres. T. H. BIRCH, Asst. Mangr. R. J. TARVIN, Sec. & Treas.

STACEY MFG. CO.,

MANUFACTURERS OF

Single and Telescopic Gasholders,

IRON ROOFS, BRIDGES, LAMP POSTS,

Water and Oil Tanks, Coal Elevator Cars,

COKE CRUSHERS, BENCH CASTINGS,

And all kinds of Wrought and Cast Iron Work used in the erection of Coal and Oil Gas Works. Rolling Mill Machinery and Heavy Castings a Specialty.

Foundry:

33, 35, 37 & 39 Mill Street.

Wrought Iron Works:

16, 18, 20, 22, 24 & 26 Ramsey Street.

Cincinnati, Ohio.

BARTLETT, HAYWARD & CO.,

Office, 24 Light.

BALTIMORE, MD.

Works, Pratt & Scott.

PURIFIERS.
Roofs.
Bench Castings.

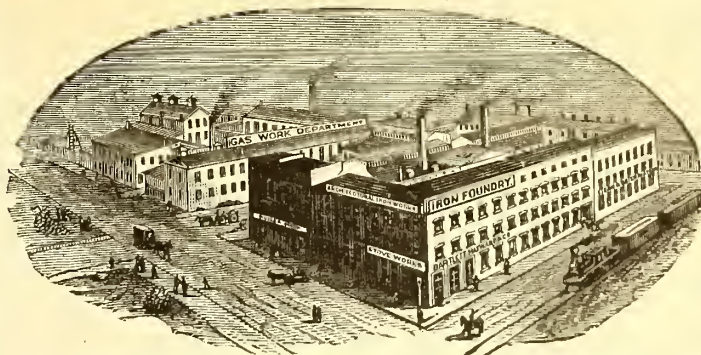

CONDENSERS.
BOILERS.
SCRUBBERS.

GASHOLDERS.

CONSTRUCTING ENGINEERS AND BUILDERS OF GAS WORKS.

1842. **DEILY & FOWLER, 1884.**

Laurel Iron Works.

Address, No. 39 Laurel Street, Philadelphia, Pa.

MANUFACTURERS OF

GASHOLDERS,

Single or Telescopic, with Cast or Wrought Iron Guide Frames.

Holders Built Since 1880:

Mount Joy, Pa.	West Point, N. Y.	Galveston, Texas (2d.)	Kalamazoo, Mich. (3d.)	Newport, R. I.
Rockaway B'ch, N.Y. (2)	Fitchburgh, Mass.	Marlboro, Mass.	Glen Island, N. Y.	Portland, Oregon.
Zanesville, O. (2d.)	New London, Conn.	Denver, Col.	Warren, Ohio.	Allegheny, Pa. (2d.)
Lancaster, O.	Derby, Conn.	Chicago, Ill. (West Side)	Bath, N. Y.	Atlanta, Ga. (2d.)
Blackwell's Island N. Y.	Bridgeport, Conn.	Pittsburgh, Pa. (S. Side)	Lynn, Mass.	N.Y.-City (Central Gas Co)
Waltham, Mass., (1st.)	Allegheny, Pa. (1st.)	Pawtucket, R. I.	New Bedford, Mass.	Lynchburg, Va. (2d.)
Dorchester, Mass.	St. Hyacinth, Can.	Brookline, Mass.	Waterbury, Conn.	Saylesville, R. I.
Wheeling, West Va.	Norwalk, O.	Sherbrooke, Can.	Deseronto, Can.	Rondout, N. Y.
Lausling, Mich.	Waltham, Mass. (2d.)	Burlington, N. J. (2d.)	Hoosic Falls, N. Y. (2d.)	Atlantic City, N. J.
Flint, Mich.	West Chester, Pa.	Bridgeton, N. J.	Bethlehem, Pa.	Augusta, Ga.
Galveston, Texas (1st.)	Baltimore, Md.	Bay City, Mich.	Atlanta, Ga. (1st.)	Waltham, Mass. (3d)
Milton, Pa.	Hollidaysburg, Pa.	Erie, Pa.	Savannah, Ga.	
Scranton, Pa.		Jackson, Mich.	Montgomery, Ala	

GAS COALS.

GAS COALS.

GAS COALS.

JAMES D. PERKINS.

PERKINS & CO.,

F. SEAVERNS.

General Sales Agents.

THE YOUGHIOGHENY RIVER COAL COMPANY,

Organized August 1, 1882.

MINERS AND SHIPPERS OF THE WELL-KNOWN

Ocean Mine Youghioghenny Gas Coal.

The Coal from the Ocean Mine (recently operated by Messrs. W. L. Scott & Co., of Erie, Pa.,) is now used by all the leading Gas Companies in the United States from Maine to Texas, and is recognized as *the only reliable Youghioghenny Gas Coal.*

Messrs. W. L. Scott & Co. and W. L. Scott, Esq., still retain their interest in the new Company, and the same general policy which has characterized the management of the mine under these gentlemen will be continued by the new Company. With largely increased facilities and *unlimited supply of Coal*, any demand made upon the Colliery will meet with prompt fulfillment.

THE UNDERSIGNED CAN SUPPLY THE FOLLOWING SUPERIOR GRADES OF

GAS CANNELS:**Abram Cannel**, from the Abram Colliery, Wigan, England,**Plesio-Boghead Cannel**, from near the old Boghead Colliery, Scotland.**North Ince Hall Cannel**, from Liverpool, England.

Breckenridge Cannel, from Kentucky. The railroad now being constructed to the Ohio river will open up this superior Cannel deposit, and enable us to deliver it at any required point. See full description of this Cannel, and Map of the Colliery, in the "American Gas Light Journal," April 16, 1883, pages 172 and 173.

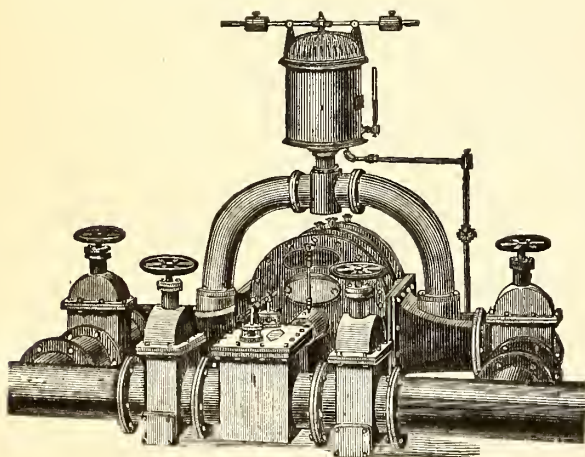
P. O. Box 3695,
New York.**PERKINS & CO., 228 and 229 N. Y. Produce Exchange**BEAVER STREET
ENTRANCE.**SMITH & SAYRE MFG. COMPANY,**

G. G. PORTER, Prest.

245 Broadway, N. Y.

CHAS. W. ISBELL, Sec'y.

Machinery & Apparatus for Gas Works

Drawings, Plans, and Estimates Furnished for the Improvement, Extension, or Alteration of Gas Works, or for the Construction of New Works.

Mackenzie's Patent Rotary and Steam Jet Gas Exhausters, Governors, Compensators, Condensers, Washers, Scrubbers. Isbell's Patent Automatic Street Pressure Governor, Gas and Water Valves, Hydraulic Main Dip Regulator, Bench Castings, etc. Purifying Boxes and "Standard" Scrubbers. Isbell's Patent Self-Sealing Retort Doors.

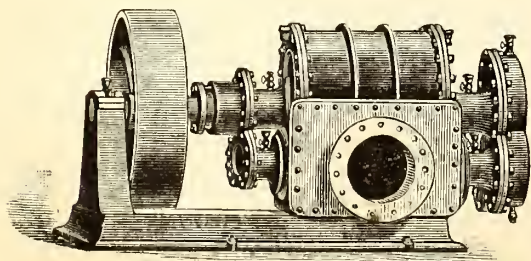

Gas Exhauster Driven by Belt.

The Wilbraham Gas Exhauster,

"BAKER SYSTEM,"

WITH ENGINE ATTACHED, ON SAME BED PLATE OR WITHOUT.

Best, Cheapest and Most Durable Exhauster known.

WILBRAHAM BROS.,

No. 2320 Frankford Avenue, Philadelphia, Pa.

GAS COALS.

Newburgh Orrel Coal Co.,

MINERS AND SHIPPERS OF

**Newburgh Orrel, Tyrconnell
and Palatine Gas Coals.**

ALSO SHIPPERS OF FOUNDRY COKE.

Mines Situated at

Newburgh, Flemington & Fairmont, W.Va.

HOME OFFICE,

25 S. Gay St., Baltimore.

**CHARLES MACKALL,
MANAGER.**

CHAS. W. HAYS, Agent in New York,

Room 92, WASHINGTON BUILDING, No. 1 Broadway.

Shipping wharves at Locust Point. References furnished when required. Special attention given to chartering vessels.

THE DESPARD COAL COMPANY

OFFER THEIR SUPERIOR

DESPARD COAL

To Gas Light Companies and Manufacturers of Fire Clay Goods
Throughout the Country.

**ROUSSEL & HICKS, } AGENTS. { BANGS & HORTON,
71 Broadway, N. Y. } { 16 Kilby St., Boston.**

Mines in Harrison Co., West Va. Wharves, Locust Point, Balt.

Company's Office, 15 German St., Baltimore, Md.

Among the consumers of Despard Coal we name: Manhattan
Gas Light Co., N. Y.; Metropolitan Gas Light Co., N. Y.; Jersey
City, (N. J.) Gas Light Co.; Washington (D. C.) Gas Light Co.;
Portland (Maine) Gas Light Co. Reference to them is requested.



1,000 Engines Now in Use.

30,000 H.P. NOW RUNNING!

Sales, 2,000 H.P. per Month!

SEND FOR ILLUSTRATED CIRCULAR AND REFERENCE LIST.

Westinghouse Machine Co.,

PITTSBURCH, PA.

SALES DEPARTMENT CONDUCTED BY

**Westinghouse, Church, Kerr & Co., 17 Cortlandt
Street, New York City.**

**Fairbanks, Morse & Co., Chicago, Cincinnati, Clevel-
land, Louisville, and St. Paul.**

Fairbanks & Co., St. Louis, Indianapolis, and Denver.

Parke & Lacy, San Francisco, and Portland, Or.

**Parke, Lacy & Co., Salt Lake City, Utah, and Butte,
Montana.**

D. A. Tompkins & Co., Charlotte, N. C.

**Murray, Hirsch & Kaepfel, Sydney and Melbourne,
Australia.**

GAS COALS.

GAS COALS,

THE

PENN GAS COAL COMPANY

OFFER THEIR

COAL, CAREFULLY SCREENED,

AND PREPARED FOR

GAS PURPOSES.

Their Property is located in the Youghioghenny Coal Basin, near Irwin's and Penn Station
in the Pennsylvania Railroad, and on the Youghioghenny River.

OFFICES

No. 209 South Third Street, Phil'a. 90 Wall Street, New York.

PLACES OF SHIPMENT.

Pennsylvania Railroad, Pier No. 2 (Lower Side).

Greenwich Wharves, Delaware River.

366-1y

Pier No. 1 (Lower Side), South Amboy, N. J.

Chesapeake & Ohio Railway Coal Agency,

FOR THE SALE OF THE

Superior Kanawha Gas Coals, Cannelton Cannel,

Also, SPLINT AND STEAM COALS.

From the Kanawha and New River Regions, on the line of the Chesapeake & Ohio R'way.

C. B. ORCUTT, Sales Agent.

OFFICE, 150 BROADWAY, N. Y.

FRANCIS H. JACKSON, PRESIDENT.

EDMUND H. McCULLOUGH, SEC. & TREAS.

THE WESTMORELAND COAL CO.

Chartered 1854.

**Mines situated on the Pennsylvania and the Baltimore
and Ohio Railroads, in Westmoreland County, Penn.**

POINTS OF SHIPMENT:

PHILADELPHIA, BALTIMORE, SOUTH AMBOY, N. J.

WATKINS (SENECA LAKE), N. Y.

Since the commencement of operations by this Company its well-known
Coal has been largely used by the Gas Companies of New England and the
Middle States, and its character is established as having no superior in gas-
giving qualities, and in freedom from sulphur and other impurities.

Principal Office, 224 South 3d St., Phila., Pa.

The Bower Gas Lamp.

**The Perfected Duplex-Regenerative Gas Burner, under
the combined Patents of Anthony S. Bower,
Geo. S. Grimston, and Thos. Thorp.**

The First Gold Medal awarded at the Crystal Palace Exhibition in
London, and two Gold Medals at the Stockport (Eng.) Exhibition of Gas
Appliances. Both in 1883.

**GEO. SHEPARD PAGE, JOHN BOWER,
69 Wall Street, N. Y. City.**

The Management of Small Gas Works.

By **C. J. R. HUMPHREYS.** Price, \$1.

A. M. CALLENDER & CO., 42 Pine St., N. Y.

INTERNATIONAL--1876--EXHIBITION.



The U. S. Centennial Commission

HAVE DECREED AN AWARD TO

HARRIS, GRIFFIN & CO.,

12th and Brown Sts., Philadelphia, and 49 Dey St., N. Y., U. S. A.,

FOR THE FOLLOWING REASONS :

The Exhibit consists of a Series of METERS from the Largest Size Station Meters for the use of the MANUFACTURE OF GAS, to those for the use of the ORDINARY CONSUMER. The Instruments are WELL MADE, RELIABLE as to INDICATION, and embody a number of sundry improvements which, with the general character of the Exhibit, entitle the whole to commendation.

Attest—J. L. CAMPBELL,
Secretary, pro-tem.Signed—A. T. GOSHORN,
Director GeneralJ. R. HAWLEY,
President

CHARLES E. DICKEY.

JAMES B. SMALLWOOD.

CHARLES H. DICKEY.

Maryland Meter and Manufacturing Co.,
DICKEY, TANSLEY & CO.,
Established 1866.

Nos. 22 and 24 Saratoga Street, Baltimore, Md.
No. 46 La Salle St., Chicago, Ill.

MANUFACTURERS OF

DRY GAS METERS, STATION METERS, GLAZED METERS, TEST METERS, METER PROVERS, PRESSURE AND VACUUM
REGISTERS, GOVERNORS, INDICATORS, SERVICE AND METER COCKS, AND METER CONNECTIONS.

NATHANIEL TUFTS,

No. 153 Franklin Street, Boston, Mass.,

MANUFACTURER OF

DRY GAS METERS.

Station Meters of any Capacity.

Test and Experimental Meters, Pressure Registers, Pressure Gauges,
Pressure and Vacuum Gauges.

METER PROVERS, PHOTOMETERS, STREET LANTERNS, ETC., ETC.

Patent Cluster Lanterns for Street Illumination.

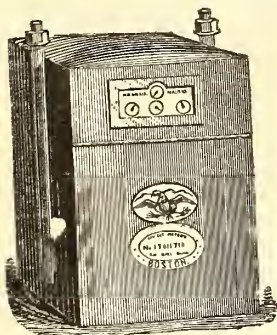

Dry Gas Meter.

With 39 years' experience and the best facilities for manufacturing, is enabled to furnish reliable work and answer orders promptly.

SCIENTIFIC BOOKS.

We are prepared to furnish to Gas Managers, and others interested in the topics treated of, the following books, at prices named :

KING'S TREATISE ON THE MANUFACTURE OF COAL GAS. Three vols.; \$10 per vol.	GAS CONSUMER'S MANUAL, by E. S. CATHELS, C.E. 10 cts.	CORRECT GAS MEASUREMENT; the serious Loss and Inconvenience to Gas Companies and the Public Caused by the Freezing and Inaccuracy of Wet Gas Meters, by GEORGE GLOVER. 40 cents.
GAS MANUFACTURE, by WILLIAM RICHARDS. 4to., with numerous Engravings and Plates, in Cloth binding. \$12.	PRACTICAL TREATISE ON HEAT, by THOMAS BOX. Second edition. \$5.	GAS WORKS, AND MANUFACTURING COAL GAS, HUGHES. \$1.80.
THE GAS ANALYST'S MANUAL, by F. W. HARTLEY. \$2.50.	FODELL'S SYSTEM OF BOOKKEEPING FOR GAS COMPANIES. \$5.	A PRACTICAL TREATISE ON GAS AND VENTILATION, with Special Relation to Illuminating, Heating, and Cooking by Gas, by E. E. PERKINS. \$1.25.
ANALYSIS, TECHNICAL VALUATION, PURIFICATION, and USE OF COAL GAS, by REV. W. R. BOWDITCH, M.A.; with Engravings; 8vo., Cloth. \$4.50.	GAS WORKS—THEIR ARRANGEMENT, CONSTRUCTION, PLANT, AND MACHINERY. \$8.	PURIFICATION OF COAL GAS, by R. P. SPICE. 8vo. \$3.
GAS MEASUREMENT AND GAS METER TESTING by F. W. HARTLEY. \$1.60.	COAL; ITS HISTORY AND USE, by PROF. THORPE. \$3.50.	GAS CONSUMER'S HANDY BOOK, by W. RICHARDS. 18 mo., Paper. 20 cents.
GAS CONSUMER'S HANDBOOK, by WILLIAM RICHARDS, C.E.; 18mo., Sewed. 20 cents.	THE GAS WORKS OF LONDON, by COLBURN. 60 cents.	
	THE GAS FITTER'S GUIDE, Showing the Principles and Practice of Lighting with Coal Gas, by JOHN ELDRIDGE. 40 cents.	

The above will be forwarded by express, upon receipt of price. We take especial pains in securing and forwarding any other Works that may be desired, upon receipt of order. All remittances should be made by check, draft, or post office money order.

A. M. CALLENDER & CO., No. 42 Pine Street, New York.

T. C. HOPPER, Pres. G. J. MCGOURKEY, Vice-Pres. (New York). WM. N. MILSTED, Gen. Supt. & Treas. (New York). WM. H. DOWN Sec.

AMERICAN METER COMPANY,

WET AND DRY GAS METERS.
STATION METERS.
EXHAUSTER GOVERNORS.
DRY CENTRE VALVES.
GOVERNORS FOR GAS WORKS.

PRESSURE REGISTERS.
PRESSURE & VACUUM REGISTERS.
PRESSURE & VACUUM GAUGES.
CRESSON GAS REGULATORS.
MARSLAND WATER METERS.

METER PROVERS.
PORTABLE TEST METERS.
EXPERIMENTAL METERS.
AMMONIA TEST METERS.
BAR AND JET PHOTOMETERS.

Manufactories:
512 W. 22d St., N. Y.
Arch & 22d Sts., Phila.

GAS STOVES,
SUGG'S "STANDARD" ARGAND BURNERS,
SUGG'S ILLUMINATING POWER METER,
Wet Meters, with Lizar's "Invariable Measuring" Drum.

Agencies:
177 Elm Street, Cincinnati.
244 & 246 N. Wells Street, Chicago.
810 North Second Street, St. Louis.
122 & 124 Sutter St., San Francisco.

HELME & McILHENNY,

Successors to Harris & Brother.

ESTABLISHED 1848.

PRACTICAL GAS METER MANUFACTURERS,

Continue as heretofore at the OLD ESTABLISHMENT, Nos. 1115 and 1117 Cherry Street, Philadelphia, Pa.

To manufacture Wet and Dry Gas Meters, Station Meters, Experimental Meters, Meter Provers, Centre Seals, Governors, Pressure Registers, Indicators, Photometers, and all kinds of Gas Apparatus; Also furnish all other Articles appertaining to the use of Gas Works.

From our long Practical Experience of the Business (covering a period of 33 years) and from our personal supervision of all Work, we can guarantee all orders to be executed promptly, and in every respect satisfactorily.

WILLIAM HELME.

JOHN McILHENNY.

WM. WALLACE GOODWIN, Prest. and Treas.

WM. H. MERRICK, V.-Prest.

S. L. JONES, Sec.

S. V. MERRICK, Asst. Sec

THE GOODWIN GAS STOVE AND METER COMPANY,

Successors to W. W. GOODWIN & CO.

1012, 1014 and 1016 Filbert St., Phila., Pa. 142 Chambers St., New York.
126 Dearborn St., Chicago, Ill.

WALDO BROS., Agents, 88 Water St., Boston.

MANUFACTURERS OF THE "SUN DIAL" GAS STOVES, FOR COOKING AND HEATING PURPOSES.

Dry and Wet GAS METERS, Station Meters (Square, Cylindrical or in Staves) Glazed Meters, King's and Sugg's Experimental Meters, Lamp Post Meters, Etc., Etc., Meter Provers (sizes 2, 5 and 10 feet), Pressure Guages of all kinds, Pressure Registers, Pressure and Vacuum Registers, Pressure Indicators (sizes 4 inch, 6 inch and 9 inch), King's Pressure and Vacuum Gauges, Dry and Wet Centre Seals, Dry and Wet Governors, Exhauster Governors, Photometers of all descriptions. Lethby's Sulphur and Ammonia Test Apparatus complete—also Testing and Chemical Apparatus of all kinds, and of the most perfect description, for all purposes relating to Gas.

GOODWIN'S IMPROVED LOWE'S JET PHOTOMETER.

Agents for Bray's Patent Gas Burners and Lanterns.

Special attention to repairs of Meters, and all apparatus connected with the business.
All work guaranteed first class in every particular, and orders filled promptly.

G. B. EDWARDS, Mang'r, New York.
E. H. B. TWINING, Mang'r, Chicago.

D. McDONALD & CO., GAS METER MANUFACTURERS.

(Established 1854.)

No. 51 Lancaster Street, Albany, N. Y.

STATION METERS, EXPERIMENTAL METERS, METER PROVERS, PRESSURE & VACUUM REGISTERS, PRESSURE GAUGES, ETC.

Also STAR GAS STOVES, RANGES, and HEATING STOVES.

We use only the very best materials, and employ the most skilled labor, and by our long experience (29 years) and personal supervision of every detail, we feel justified in assuring the public that our goods will give perfect satisfaction. Every Meter emanating from our establishment will bear the State Inspector's BADGE, and will be fully warranted by us. Our Annual and Calendar will be sent to Gas Companies upon application.

KINC'S TREATISE ON COAL GAS.

The most complete work on Coal Gas ever published. Three vols., bound, \$30.

A. M. CALLENDER & CO., No. 42 Pine Street, New York.

THE GOODWIN GAS STOVE AND METER CO.,

Successors to W. W. GOODWIN & CO.,

1012, 1014 & 1016 Filbert St., Phila., 142 Chambers St., N. Y., 126 Dearborn St., Chicago.

Agents, WALDO BROTHERS, 88 Water Street, Boston.

WM. W. GOODWIN, PRES. & TREAS.
W. H. MERRICK, VICE-PRES.
S. LEWIS JONES, SEC.

SOLE MANUFACTURERS OF THE

SAMUEL V. MERRICK, Asst.-Sec.
G. B. EDWARDS, Mang'r, N. Y.
E. H. B. TWINING, Mang'r, Chicago.

"SUN DIAL" GAS STOVES

The Most Economical, Efficient, and Durable Gas Stove Made.

Since 1878, when we began to manufacture these Stoves, we have received 17 Gold, Silver, and Bronze Medals, and 6 Diplomas for Efficiency, Superiority of Workmanship, etc. etc.

ALL FITTINGS ARE NICKEL-PLATED WITHOUT EXTRA CHARGE.

THE OVEN BURNERS ARE CONSTRUCTED TO BURN EITHER PURE GAS OR GAS AND AIR MIXED.

FROM TWENTY-FIVE TO FORTY PER CENT. OF GAS SAVED BY THE USE OF OUR PATENT OVEN LINING.

STOVES THAT WILL COOK FOR ONE PERSON OR ONE THOUSAND PERSONS AT ONE TIME.

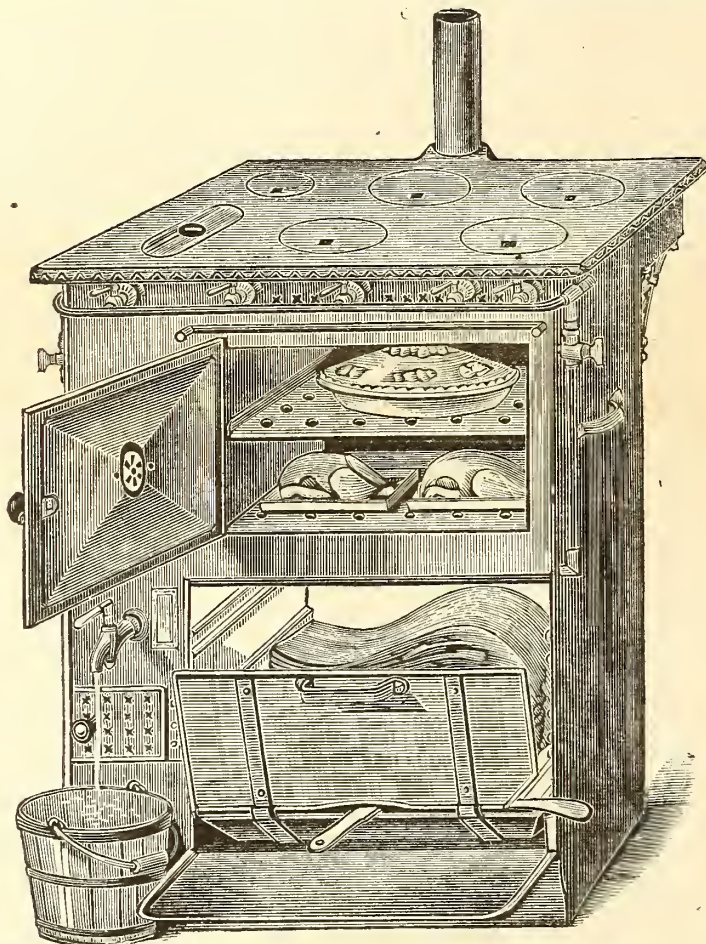

Gas Cooking Stove No. 9A. FITTED WITH OUR PATENT TOP AND OUTLET PIPE FOR CARRYING OFF COMPLETELY ALL THE PRODUCTS OF COMBUSTION FROM, OVEN, ROASTER, AND TOP BURNERS.

STOVES FOR LAUNDRIES, HATTERS, AND TAILORS.

HOT WATER GENERATORS FOR USE IN KITCHENS, BATH ROOMS, ETC., ETC.

BROILING RANGES FOR RESTAURANTS AND HOTELS.

OVER THIRTY-FIVE THOUSAND STOVES OF ALL SIZES SOLD SINCE 1878.

SEND FOR ILLUSTRATED CATALOGUE.

We carry in Stock Nos. 7, 8, and 8A Cooking Stoves fitted with our Patent Tops. See Catalogue and Price List.

We desire to call attention to our IMPROVEMENT IN THE TOP OF THE SUN DIAL GAS STOVE, by means of which all the odors and products of combustion from the ovens and top burners are entirely removed from the room. This is accomplished by channels and flues connected to the pipe shown at back of stove, to which is connected such additional pipe as may be necessary to connect the same with the flue or chimney, thereby producing the same effect in conveying away the products of combustion as is done in the use of the ordinary range, etc. This arrangement fills a want that has long been felt by those who have objected to the use of gas stoves for the reason of there being no adequate means to remove the products of combustion and odors from the roasting chambers, ovens, and boiling burners, all of which is now accomplished. *We have secured the improvement by Letters Patent in this country and Europe, and any attempt at infringement will be prosecuted.*

AGENTS FOR CLERK'S PATENT GAS ENGINE.

THE AMERICAN

GAS LIGHT JOURNAL

REDMAN & KENNY, N.Y.

PUBLISHING OFFICE No. 42 PINE STREET

DEVOTED TO THE INTERESTS OF ILLUMINATION, VENTILATION, WATER SUPPLY AND DISTRIBUTION, & GENERAL SCIENCE.

VOLUME XLII.—No. 4.
Whole No. 616.

NEW YORK, MONDAY, FEBRUARY 16, 1885

{ \$3 PER ANNUM
IN ADVANCE.

A. M. CALLENDER & CO., Proprietors. C. E. SANDERSON, Manager.
JOS. R. THOMAS, C.E., Editor.

ENTERED AT THE POST OFFICE AT NEW YORK, N. Y.,
AS SECOND CLASS MATTER.

Published on the 2d and 16th of each month, at No. 42 Pine Street, N. Y.

Terms of Subscription, Including Postage.—For the United States and Canada, \$3 per annum. European countries, \$3.50 (15 shillings—18 francs). All payments to be made in advance. Single copies, 15 cents.

Remittances should be made either by post-office order, registered letter, or bank draft on New York, payable to the order of A. M. Callender & Co.

Collections are invariably made directly from this office, for subscriptions, advertisements, etc. We have agents to solicit the same, but they are not authorized to receipt for money.

Correspondence.—Wishing to make this JOURNAL a gazette of intelligent discussion to those of our readers who may wish to gain or give information on the subjects to which its columns are devoted, correspondence is solicited for publication from all who make the study of those subjects a pleasure or a profession.

Books.—We will mail, post-paid, at publisher's lowest rates, any book—scientific or otherwise—to any address in the United States or Canada. No books will be sent C. O. D.

The American News Company, Nos. 39 and 41 Chambers street, New York, are agents for this JOURNAL. Newsdealers will send orders to them.

CONTENTS.

An Asterisk (*) denotes an illustrated article.

OFFICIAL NOTICES—

Annual Meeting New England Association of Gas Engineers.....	85
First Annual Meeting of the Ohio Gas Light Association.....	85

EDITORIALS—

The Gas Reformers of New York City.....	85
There Will be no Conflict in Future.....	86
The Latest from Boston.....	86
A Misprint.....	86
Map Showing Location and Surroundings of the Youghiogheny River Coal Company's Ocean Mine Gas Coal.....	87
On the Use of Coal Gas—Lecture No. III., Coal Gas as a Source of Heat—By H. Dixon.....	88
Annual Report of the Edison Electric Illuminating Company.....	91
Sir F. Bramwell on the Progress of Invention.....	92
Hocking Valley (Ohio) Coal.....	94
Improvement in Electric Safety Lamps.....	95
Slag Cement.....	95
Dividends Paid by San Francisco Gas and Electric Light Companies in 1884.....	95

ITEMS OF INTEREST FROM VARIOUS LOCALITIES.....

The Electric Lighting of Hell Gate Channel—Personal—Suffocated by Gas—For Sale at Half Price—Great Decrease in the English Coal Mining Death Rate—Boring for Natural Gas at Ironton, Ohio—Its True Function—One Way for Small Gas Companies to Avoid Trouble—Cheaper Gas for New Rochelle, N. Y.—Broken Panes—A Puzzled Saloonkeeper—Proposing to Make another Reduction—Some Thought it was Dynamite—Meter-Making Hands on Strike—Their Pledges were Kept—A Novel Point on which an Application for an Injunction is Based—Brooklyn (N. Y.) Street Lighting.....	96
Recent Patents.....	98
The Market for Gas Securities.....	99

[OFFICIAL NOTICE.]

ANNUAL MEETING NEW ENGLAND ASSOCIATION OF GAS ENGINEERS.

OFFICE OF SECRETARY
NEW ENGLAND ASSOCIATION OF GAS ENGINEERS,
BOSTON, MASS., Jan. 24, 1885.

The Annual Meeting of the Association will be held at Young's Hotel, Boston, on the 18th and 19th days of February, commencing at 11 o'clock A.M., on Wednesday, the 18th.

Members intending to propose the names of applicants for membership are requested to send them to the Secretary before the time of meeting.

The Board of Directors will meet in room 13, in Young's Hotel, on the evening of February 17th, at 8 o'clock. Papers to be read before the Association should be forwarded to the Secretary in time to be presented to the Directors at this meeting for their approval.

Friends of the Association are cordially invited to attend the Annual Meeting. Those wishing rooms engaged will please notify the Secretary on or before date of February 16th.

GEO. B. NEAL,
Secretary.

[OFFICIAL NOTICE.]

FIRST ANNUAL MEETING OF THE OHIO GAS LIGHT ASSOCIATION.

SECRETARY'S OFFICE OHIO GAS LIGHT ASSOCIATION,
TIFFIN, OHIO, Jan. 19, 1885.

The First Annual Meeting of the Ohio Gas Light Association will be held at the Burnett House, Cincinnati, Ohio, on the 18th day of February, 1885.

The Executive Committee expects that all the members will be in attendance at the meeting, and calls attention to the fact that matters of great importance, not only to the interest of Ohio but to the fraternity at large as well, will be discussed thereat.

The Association will be glad to welcome any of the brethren who may wish to pay a visit to the sessions.

JOS. BATE,
Secretary.

THE GAS REFORMERS OF NEW YORK CITY.

One of the leading ambitions of the average New York citizen, and particularly so of the "fussy" person who desires to acquaint his neighbors with the important fact that he is a "self-made man," is to set himself up as a reformer of something or another. His most ardent predilection is in the direction of "investigating abuses known to exist, and which are honey-combing our municipal system," etc. When municipal affairs present nothing of a suspicious nature, he must venture out in search of "other weighty matters that are pressing heavily upon the best interests of our citizens," etc., giving a great portion of his valuable time, to say nothing of an endless amount of "concentrated thought," to the devising of schemes whereby all these "oppressions may be corrected." New York city's political governors and machine regulators having been walking over the straight path of late, the "reformers" had to make choice of a side-issue this season, and accordingly selected the Consolidated Gas Company as a proper and fitting object whereupon to exercise their wonderful talents.

One peculiar faculty attaching to the professional reformer is his intimate knowledge of every known business and profession; suppose he has amassed money trading in leather; he regards that as conclusive proof that he knows all about meters—for is there not leather in meters? We might possibly infer from this, cognizant as he is about there being “leather and leather,” that is why he is so prone to disbelieve in the meter’s accuracy. The reformer who has traded for a life-time in sugars knows how matters will sometimes “go wrong” with a shipment; therefore is he ready to believe that the gas man does occasionally “mix things up.” Indeed he is measurably certain that the big gasholders are inflated with air, and that the retorts and generators are but a well-devised sham to put a gasified appearance upon the whole transaction, and bear a similar relation to the manufacture of gas in about the identical proportion maintained by the suburban cow to the urban hydrant or pump in their connection with the supply of our lacteal fluid.

Speaking now in all seriousness as to the movement recently inaugurated in this city for the ostensible purpose of investigating the methods of the metropolitan gas companies, sober-minded persons cannot view the proceedings so far taken other than in the light of an aggravated farce. The principal mover in the premises, John H. Sherwood, a large holder of improved real estate, and also connected with the Fifth Avenue Bank, may be set down at the outset as a “crank” on the subject of gas and gas companies. The very mention of gas is enough to set him agoing; and it is very much easier to start him off on his pet theme than it is to stop him when once in motion. When it was resolved to hold that inauguration meeting at Delmonico’s (referred to in our “Market for Gas Securities,” of last issue), Mr. Sherwood, according to the daily papers, was the prime mover in the enterprise, and the opportunity of airing himself in the public prints was availed of to the fullest extent. One of the most amusing of his outpourings was contained in the columns of the *Tribune*. To a reporter of that paper he bewailed the iniquity of the recent consolidation in “piling up fictitious capital to increase the enormous taxes annually wrung from the gas consuming public.” He dilated upon the rascality of the gas managers who, by greatly increasing the pressure conditions of distribution, compel a “three-foot burner to consume eight and ten feet per hour,” and gave it as his unqualified opinion that one-third of the forty millions of capital in the Consolidated Company would be amply sufficient to duplicate its plant. Now, we would suppose that Mr. Sherwood ought to know something about the values of real estate in New York city, seeing that he has amassed a large fortune through operations in the same since “the year of the riot;” and with this knowledge he deliberately makes the above ridiculous statement. Suppose that Mr. Sherwood were disposed to purchase all the freehold property now owned by the Consolidated Company, how much does he think it would cost him? Were he limited to one-third of forty millions wherewith to build his mythical gas plant, being first obliged to purchase the Consolidated’s real estate, he might erect a works large enough to supply light to one of his apartment houses, and would find himself hard pressed at that.

But this versatile gentleman is not only a real estate expert and competent apportioner of capital, but, by his own admission, is a gas engineer as well; for he told the same reporter, immediately after his explanation of how a three-foot gas burner could be made to pass ten feet per hour, the following pretty yarn:

“There are two kinds of gas made in New York. One is immeasurably superior to the other in point of brilliancy and candle power; yet the inferior gas is made and sold in large quantities to please old-fogy managers who learned gas making under Murdock, and have added nothing to their knowledge in the last quarter of a century. Do you know that I make gas enough in my cellar to supply this whole house—good gas, too; and it costs me less than I would have to pay the Consolidated Company whose pipes are laid all around me.”

Men like General Roome and his confreres are certainly *old* engineers, who have devoted a life-time (and an honorable one) to the study of the principles of their calling; but it is news to us that they “learned gas making under Murdock;” and, from a personal acquaintance covering many years, we are at a loss to understand how they can be considered as old-fogies—unless old-fogyism means a willingness to persevere in the upright and honest methods that they have followed all their lives. But perhaps Mr. Sherwood has “let the cat out of the bag;” for who knows but down in that secret place of his he may have concealed the germ of some great discovery which is to work such a great revolution in our industry that even before its effulgence the brilliancy of Engineer Crutchett’s “Steam Carbon Gas” will pale. If this surmise be correct, inventor Sherwood should not let his process longer waste its power for good betwixt the cellar walls and underneath the basement floor of his residence at 115th street and Sixth avenue.

The truth about the matter is this, and the sooner Mr. Sherwood and his brother filibusters can convince themselves of it the better will it be for themselves. The Consolidated Gas Company, of New York city, would only be too willing to have the law regulate its course in every particular. But such regulations are not to be framed in a day nor in a year; and neither are

their germs found in the stupidly idiotic trash recently presented before the Assembly and Senate now in session at Albany, by Messrs. Roesch and Cullen. The clauses of the acts submitted by the representatives named are so absurd that our space would be simply wasted did we try to present them before our readers.

If it be the honest and sincere desire of the organization calling itself the “Gas Consumers’ Association of the State of New York” to attempt to govern the gas industry of this State by the enactment of laws equitable alike to consumers and producers, let them start in by asking for the appointment of a commission whose sole duty shall be the framing of measures that shall act to the just protection of all the interests concerned.

THERE WILL BE NO CONFLICT IN FUTURE.

In our last issue the circumstance of the unfortunate conflict of dates between the days set apart for the respective meetings of the New England and Ohio Gas Associations was pointed out, and we felt called upon to express our regret at the fact. We also ventured upon making the assertion that no such *contretemps* would take place in respect to next year. That our prediction was correct is borne out by a letter since received by us from Mr. Jos. Bate, Secretary of the Ohio Association. Mr. Bate says that the matter had been noticed at the Springfield session of the Executive Committee, but arrangements had so far progressed at that time as to render any change in the previously chosen date quite impossible. The gentleman assures us that the future arrangement will be of a nature calculated not to interfere in any manner with sessions of other Associations. Secretary Bate gives us authority to make the above statement.

THE LATEST FROM BOSTON.

In our issue for December 16th it was stated that the Board of Aldermen whose term of office expired with the close of 1884 had left as a legacy to their successors the disposal of the question as to whether or not the particular brand of opposition, labeled the Bay State Gas Company, should have the right to construct and operate a plant in Boston, Massachusetts. [People in this section of the country should not confound this Bay State Company with the Shoe and Leather Company. They are not in any manner identified with one another. The Bay State gas financiers are engaged in an attempt to “divide” the earnings of old established gas plants in large cities; while the Shoe and Leather Company are large employers of convict prison labor.] The heirs to the legacy have disposed of their patrimony in short order. When the new Board got into proper working harness the petition of the Bay State people was at once taken up. At one time it looked as though the measure would be favorably acted upon without a reference to the Paving Committee; but eventually such a reference was ordered, we believe on date of January 26th—it may possibly have been a week earlier, as our advices on this matter are somewhat meager. At the Board meeting of Feb. 2d the Paving Committee handed in a report on the question. The chief points claimed to have been considered in the deliberations of Committee were, “Will the admission of a company to compete with those already enjoying the privileges asked for be for the public good? And is the petitioner a proper company to which to grant these privileges?” The deliberators found no difficulty whatever in disposing of the questions in favor of the petitioners. Indeed they go so far as to say, “It is evident to your committee that the advantages to our citizens are very great in admitting a competing company, while it will bring into our community a large amount of taxable property, and result in the circulation of a large amount of money among the unemployed laboring classes.” In other words, the Committee find that it will be a good thing to plunder the Boston Gas Company in order that Boston’s tax valuation may be increased by a trifle, and the “unemployed laboring classes” are voted as worthy of a share in the operation. The report of the Committee was accepted, and the order granting leave was laid over for one week. A telegraphic despatch received by us late on Tuesday, February 10th, through the courtesy and attention of a friend, informs us that the order was passed at meeting of Board, held on February 9th. As near as we can make it out now, the case at present stands thus: The Consumers Company claim the right to go ahead, despite the veto of Mayor Martin—see *JOURNAL*, December 2d and 16th; and the Bay State Company have just been granted Aldermanic consent to proceed with their scheme. Take it all in all, it looks as though there were “piping times” in store for the Hub.

A MISPRINT.—In our last issue (February 2d), on page 58, first column, twenty-sixth line, commencing, “supplants 52 gas lamps,” should read,—“supplants 5.2 gas lamps.”

PROGRESS.—Six years ago China had only 6 miles of telegraph lines in operation. Now Canton, in the South, has been brought into direct communication with the chief city in the North. A message from thence to New York could be delivered in the space of five hours.

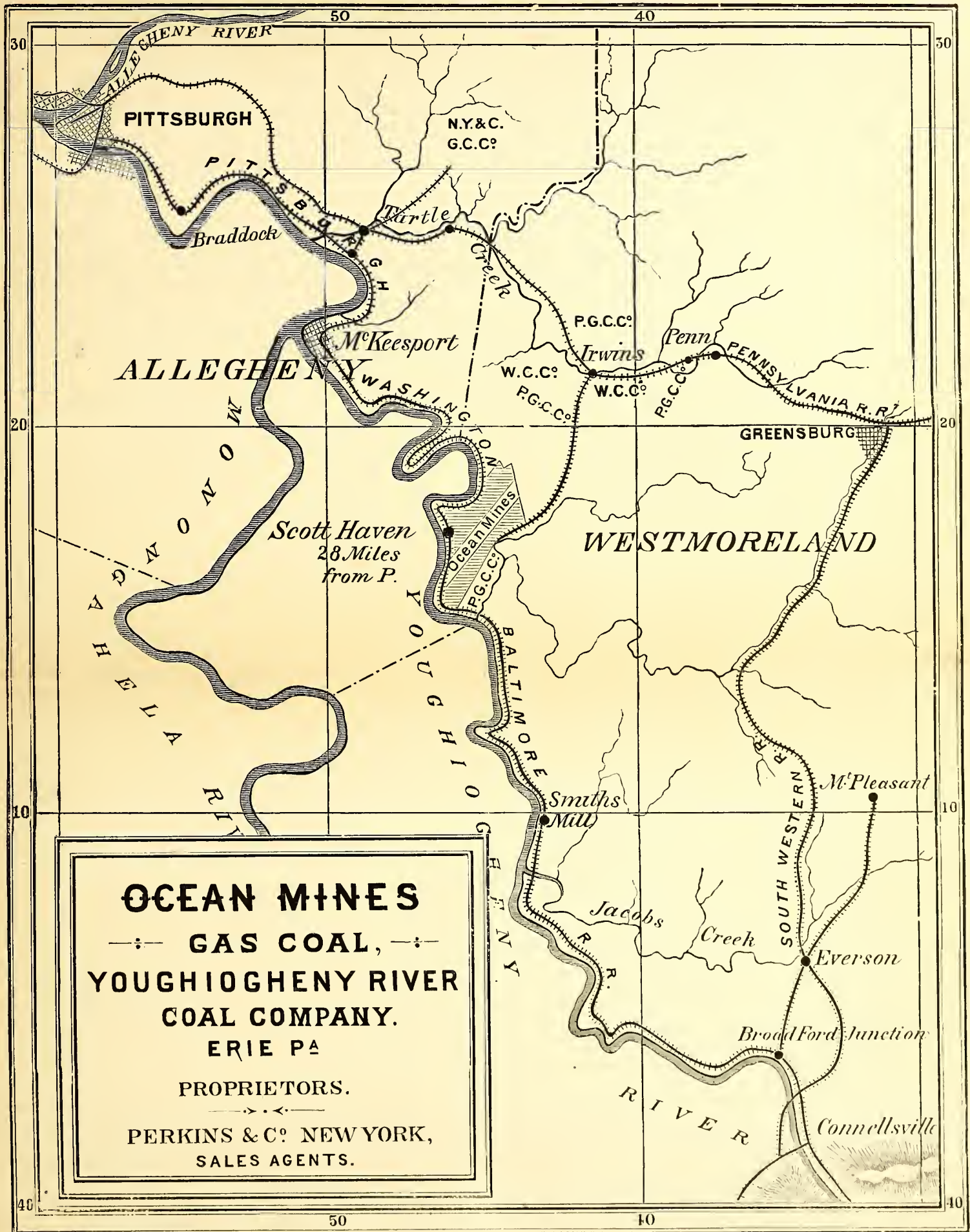

Map Showing Location and Surroundings of the Youghiogheny River Coal Company's Ocean Mine Gas Coal.

The Ocean Mines are located in the center of the world-famous Youghiogheny Coal Field, and cover an area of three thousand three hundred (3,300) acres, showing a total productive capacity of thirty-six million (36,000,000) tons. The Youghiogheny Coal has justly earned the reputation of being the *best American Gas Coal* obtainable; and attention is called to the fact that the facilities possessed by the proprietors of the Ocean Mine are unsurpassed by those of any other colliery in the United States. See advertisement of Ocean Mine Youghiogheny Gas Coal on page 108 of this issue. Full particulars on application to PERKINS & CO., General Sales Agents, 228 N. Y. Produce Exchange. P. O. Box 3695.—Adv.

[From Journal of the Society of Arts.]
On the Use of Coal Gas.

By HAROLD DIXON, M.A.

[Below will be found a reprint of the third and concluding lecture delivered by Mr. Dixon before the Society of Arts, London, England, on date of Monday, Dec. 15. For previous lectures by the author on this topic see JOURNAL, issues of Jan. 16 and Feb. 2.]

LECTURE III.—COAL GAS AS A SOURCE OF HEAT.

With your permission, I should like to say a few words, as a preliminary to this lecture, on a subject that has been much debated—the effect of haze and fog on different sources of light. Some of this audience are aware that experiments have been carried on during the past year at the South Foreland on this subject, and that various illuminants have been tested with regard to their penetrative power through mist and fog; and although the investigation is not over, and I am not in a position to give precise results, I can make a few general remarks on the subject. I am often told—“So, I hear the electric light is absorbed by a fog; it is no use.” That statement is not really correct. The electric light does go through a fog as well as another light, if it is as bright in the red rays—the less refrangible rays—as the other light is. There is a popular fallacy, and many writers commit it, in supposing that the absorption of light is independent of the quality of the light; whereas the absorption of light takes place selectively, just as the absorption of heat takes place selectively. When a beam of heat falls on a plate of glass it suffers a certain percentage of absorption; the beam which has filtered through the first glass suffers less absorption in passing through a second plate of glass, and still less in passing through a third. And in the same way Professor Langley has shown that light suffers a selective absorption. Where a beam of light passes through any medium, such as a plate of glass, it suffers a certain percentage of absorption; the beam of light which has passed through the first suffers a less percentage of absorption in passing through a second plate of glass, still less in passing through a third, and so on. In other words, the beam, when it has lost its absorbable constituents, then suffers less than it did at starting.

Now the bearing of this with regard to the penetrative power of the electric and other lights is this: If the electric light is stronger in the long rays than another source of light, produced by gas or oil, and it passes through a certain thickness of haze, it loses its absorbable constituents, but the residual light is stronger than the residual light from the other source, and therefore that residual light will pass further through haze than light from the gas or oil. But if the two are of equal intensity to start with—that is to say, if the two equally affect a photometer disc—and the two lights pass through a certain thickness of haze, then the electric light loses more of its constituents than the oil or gas light, and therefore the residue is less strong than the residue of the gas or oil. Taking, then, two lights of equal intensity, one electric and the other gas light, the latter will go further through haze. But if the electric light is very much stronger, as electric light can be made, than any gas flame or oil flame, then, in spite of its greater absorption, it will go further than those other weaker flames.

I said that there was a fallacy in the usual way of expressing the absorption of light. The fallacy consists in regarding the absorption as *regular*. If a is the intensity of the source of light, and x the fraction of that which passes through one layer of haze, and y is the number of layers through which it passes, then it is ordinarily said that the light which passes through any number of layers, y , and comes to the observer's eye, is expressed by ax . But in reality the absorption is not regular. The loss of light is greater at first, and becomes less and less as the shorter waves are filtered out of the beam.

When a gas flame burning in air is allowed to mix itself with air, it loses light. I showed you experiments last week in which coal gas, forced out through a small orifice at high pressure, mixed itself with the air, and gave less light than when it flowed with a gentler stream through the opening. Now, if we mix air with the coal gas before it reaches the orifice, we also find that it gives less illumination. A burner has been constructed which is commonly called by chemists a Bunsen burner, after Professor Bunsen of Heidelberg, but is now usually referred to as an atmospheric burner, in which air is mixed with coal gas before it is burnt. On the table there are several of these burners, made of a straight piece of metal pipe, with orifices near the bottom; the gas issues from a small hole into this straight pipe, and, passing upward, draws in a current of air through the holes—two or three, as the case may be—in the pipe. The coal gas thus mixes itself with about twice or two and a half times its volume of air, and burns with a non-luminous blue flame. The Bunsen burner gives a flame which will deposit no soot on any solid body held in it; it gives a flame with hardly any light, its non-luminosity, of course, being dependent on the fact that no carbon is separated in the burning of the gas. To get a luminous flame, the hydrogen of the hydrocarbons in the coal gas must burn before the carbon; the

carbon must be separated and strongly heated up before it is finally burnt to carbonic acid. In the Bunsen burner the carbon and hydrogen burn together; the hydrogen does not have that start of the carbon which it has in the ordinary flame. But, although we are very familiar with this Bunsen flame, the reason of it is not so obvious. It used to be always explained in this way: The oxygen of the air, being allowed to mix with the coal gas before it issued, burnt or oxidized the carbon straight to carbonic acid, without giving it a chance of existing in the solid state unburnt. But although that is a partial explanation, it is not the whole matter. Here is a pipe with the holes at the bottom closed, so that no air can get in; the gas is burning with the ordinary luminous smoky flame. If, instead of allowing air to enter the flame, we pass in some gas which will not aid the combustion, such as carbonic acid, we find that the flame loses its light and becomes very much like an ordinary Bunsen flame. I have here attached a Kipp's apparatus for generating carbonic acid, so that I can pour carbonic acid into the stream of gas, and let the two burn together. You notice that as the carbonic acid mixes with the coal gas the flame loses its light, turns blue, and is hardly distinguishable from the flame of the ordinary atmospheric burner. Now this effect cannot be due to the oxidation of the carbon by letting in air, but only carbonic acid. If I continue to increase the supply of carbonic acid, the flame gets bluer, and is finally extinguished. The air which is admitted to a Bunsen burner acts not only by oxidizing the carbon directly to carbonic acid, but also by this dilution of the coal gas; and the effect of the carbonic acid, I think, in this experiment is twofold: it dilutes the gas—it separates the particles of the gas from one another—and it also cools down the flame. Both causes tend to destroy the illuminating power of the flame. In the first place, the dilution, by increasing the distance between the carbon atoms, prevents their aggregation; and, secondly, the presence of this inert gas, taking no part in the combustion, absorbs heat, and therefore cools down the flame. Both these effects are found in the Bunsen burner, besides the oxidation.

I think, then, the reason why the Bunsen burner is not luminous is, first, that the carbon is oxidized by the oxygen of the air let into it; secondly, that the coal gas is diluted by the nitrogen of the air admitted; and, thirdly, the flame is cooled down. The Bunsen flame is not cooled below the temperature of the luminous flame—it is hotter than the luminous flame; but it is cooled down below the temperature of a gas flame mixed with undiluted oxygen. When a little pure oxygen is mixed with coal gas, it burns with a more luminous flame, owing to the increase of temperature in spite of the direct oxidation of some of the carbon. I can show you an experiment on this point, proving that the mere presence of a small quantity of oxygen is not sufficient to weaken the luminosity. Here is a burner with a supply of coal gas, in the center of which a small tube is fixed, through which I can bring a supply of oxygen to the flame. I gradually bring into the flame a little oxygen, when we see that the intensity of the light is very much increased. It is evident that the mere presence of oxygen in the flame need not necessarily, by oxidation, destroy the light. Now, I increase the supply of oxygen to this burner, and we find that as the oxygen increases the light gradually diminishes, and we shall finally get a small non-luminous flame of a very high temperature. As the oxygen is turned up, you see the character of the flame is altered. It no longer gives light; it burns with a blue-violet flame, and the tip is green.

The high temperature produced by the burning of coal gas, either in air or oxygen, has been utilized for producing an artificial light. Let me show you one or two simple experiments on the temperature of this flame. Platinum you know is a most refractory substance, melting at the highest temperature of any known metal. On introducing a spiral of platinum wire into this flame, it is immediately melted. Here is a little cylinder of lime, against which the non-luminous flame is caused to impinge; and here we have the well-known lime light, or Drummond light. Now, two burners not dissimilar to this in principle have lately been devised, one by Mr. Lewis and the other by M. Clamond, which depend on the high temperature produced by the burning of coal gas in a supply of air. I will turn off the oxygen from this coal gas flame, and instead introduce a blast of air. The temperature produced by this means is of course not so high as that which you saw melted the platinum readily, but still we get a very high temperature. When the air is blown in we get a non-luminous flame, and if I introduce a bit of platinum, of the same thickness as was melted just now, it gets heated up to a bright red; with a rather thinner wire the light emitted is much whiter. This in effect is the platinum lamp of Mr. Lewis. I have not got, I am sorry to say, the lamp itself to show you; but it is made by blowing air into a coal gas flame and letting it play on a little cage of platinum wire in exactly the way I showed you just now; only I believe he has succeeded in making the blast of air enter the flame without producing that hissing noise, at all events not in so marked a degree as you heard just now. I have only once had the pleasure of seeing the Lewis gas supplied on a large scale, and then I do not think it was quite free from the hissing noise—it was just noticeable. I believe Mr. Lewis is now lighting some of the stations

on the Underground line, and probably many of my audience are more familiar with the light than I am myself. In the Clamond light the chief difference is this—that magnesia (the oxide of magnesium) is heated up by the blowpipe flame; for it is nothing but a blowpipe flame—a current of air blown through coal gas. Magnesia, like lime, glows, when heated, with an intense white light. Of course the chief objection to both these burners being brought into large use is this—that a supply of air at high pressure is necessary, so that either one must have a blower to send in the current of air, or else a double set of mains must be laid down from the central supply.

The two flames we have considered—the luminous gas flame and the non-luminous Bunsen flame—have both their uses, the one chiefly as a source of light, the other as a source of heat. The luminous flame I have already discussed, and I want now more fully to consider the applications of the non-luminous in heating and cooking.

We have seen that when a solid substance is placed in the non-luminous flame it glows brightly, and gives out far more light than the non-luminous flame itself. Without any artificial supply of air under pressure, this Bunsen flame will heat up a coil of platinum wire to a bright incandescence. The luminous gas flame containing solid particles of carbon will radiate heat much more strongly than a non-luminous Bunsen flame. Heated gas by itself is almost incapable of radiating heat. Solid particles are necessary for radiation. Now, in the ordinary flame we have solid particles of carbon, and it is the solid carbon which gives the radiant heat. In the non-luminous flame we have no solid particles, and we therefore have very little radiant heat. But if we consider the temperature of the flame alone, we find that a Bunsen flame is of a higher average temperature than the luminous flame. It gives out, actually, the same quantity of heat when the same quantity of gas is burnt; but since in the Bunsen flame the combustion takes place in a smaller space, the average temperature of the flame is higher, so that a coil of platinum wire held in it will be raised to a higher temperature than if held in an ordinary luminous flame. Now, the Bunsen flame may be used as a source of radiant heat, by heating up a solid body, such as platinum, fire-brick, asbestos, or other incombustible substance. The Bunsen burner may also be used as a source of heat by applying the flame directly to a vessel in which water or other material is contained. If we want to boil water, certainly the easiest and cleanest way is to place a kettle over a Bunsen flame; no soot is deposited, for there are no solid particles of carbon in the flame, and the kettle remains clean.

Of the various kinds of Bunsen burners which have been devised to heat water, those constructed by Mr. Fletcher, of which I have several specimens here, seem to me to be admirably fitted for that purpose. I have no doubt that others may be as good, but I am not so well acquainted with them. I have here two specimens of the simplest form of burner, in which the gas flowing from a small pipe creates a partial vacuum, and draws in the necessary supply of air, so that the air and coal gas mix in the base of the burner and then burn with a non-luminous flame. These burners are very easily regulated; you can get a very small flame or a very big flame as required. For the purpose of cooking, this Bunsen burner seems to be most admirably adapted, wherever water is to be boiled, or wherever food is to be baked or braised; but there is a difference of opinion with regard to roasting, and I do not feel myself in a position to be able to lay down the law at all on this subject. My chief experience with regard to cooking has been with a Bunsen burner. Now, a Bunsen burner will roast meat very well, provided that the products of combustion are not poured straight on to whatever is being cooked; the flame must be used to heat up the walls of the roaster, and the radiant heat from the walls must roast the meat. Such, I think, is the right way in which to roast meat if you use a Bunsen burner; do not place the joint straight over the top of the burner, so that the carbonic acid and steam pass directly on to the meat, but have the burners arranged alongside the walls of the roaster, and so heat up the walls as to cook the joint by radiant heat, and not simply by heated gases. In some forms of gas ovens the air inside the oven is heated up, and this air, with the products of combustion of the coal gas, bakes the joint; but that, I think, is not the best way of doing it. The other way is to allow a constant supply of air to pass through the roaster, coming in at the bottom and passing out at the top, mixed with the products of combustion, and to cook the joint by the heat radiated from the sides of the roaster.

By the kindness of Mr. Fletcher I am able to show a stove—a kitchen, perhaps, I should call it—in which the Bunsen or atmospheric burner alone is employed. The roaster itself is quite open at the bottom, so that a continual supply of fresh air is sweeping in, and passing out at the top with the products of combustion. There are two small rows of gas burners heating up the opposite sides of the roaster, and the radiant heat from them roasts the joint between them. On the top of the roaster three burners are placed, over which kettles and saucepans may be boiled. Underneath these burners, between them and the roaster, is a space for cooking chops or grilling steaks, and so on. One of these burners is made to rotate, so that the flame can be turned either upward or downward. When you want to grill, the burner is

turned over; the iron is then above the flame, and becomes strongly heated, and the radiant heat from it grills the chop. On turning the burner over, the flame being above, it can be used for boiling or braising.

Now, in an arrangement where such a gas stove as this replaces the ordinary kitchen fireplace, I venture to think that great economy will be found; not that coal gas is so cheap that we cannot get a greater quantity of heat by burning coal of the same value, but because the whole thing is so clean and easy to work. First of all, we have no pouring of coal into the cellar, we have no digging of coal out of the cellar, we have no dust and cinders to clear away; secondly, the stove is only alight when it is required. It is not necessary to keep the kitchen fire burning all day, because you can light the gas in a moment, and in ten minutes it is ready for use. The third advantage of the gas system in the house is this—that you do away altogether with I may call the *bete noir* of domestic life—the kitchen boiler. With water as we have it supplied in England, with a certain quantity of magnesium and calcium salts dissolved in it, the kitchen boiler has a crust continually forming on it, and it requires periodical cleaning out. Unless this is done there is always a danger of the fur blocking up the supply pipe, and causing a dangerous pressure of steam. Another danger, too, may occur; the crust forms all over the inside of the boiler, and increases day by day as the water is heated in it, and may become of such a thickness that the iron of which the boiler is made, being cut off from contact with the water, may become red hot. If, then, some of the fur breaks off, the water may come in contact with the red hot iron, and the sudden evolution of steam consequent on that may be sufficient to burst the boiler. Now, in an arrangement which I should recommend, the kitchen boiler is done away with altogether, just as the kitchen fire is done away with in favor of the gas oven. Hot water is obtained where it is wanted by a *therma*, or water heater—one upstairs for baths, and another downstairs for washing. By the kindness of Mr. Sugg I am able to show you here a very perfect specimen of the water heater designed by Mr. Vernon Harcourt. In it a ring of gas burners is lighted at the bottom; at the top the cold water flows into a sieve, whence it passes in fine spray, and falls on a metal plate; through the middle of this metallic plate it passes through an orifice on to a second plate; it flows along that and falls off around the circumference on to a third plate, through the middle of which it passes, and so on. The products of combustion—the steam and carbonic acid—from the coal gas pass upward through this series of waterfalls, and the heat of the gas is thus absorbed by the water, the products of combustion passing off at the top quite cool. The supply of gas and water must be so regulated that before the water reaches the bottom it is raised to the temperature required—about 110° or 120° F., which is sufficiently hot for ordinary purposes, for a bath, or washing up dishes. In this way, in ten minutes a bath may be supplied with hot water; no iron pipes need pass through the house from the kitchen upstairs, because the water is heated *in situ*. A similar *therma* may be placed in the kitchen, where hot water is required, perhaps, more abundantly than upstairs. With these devices—the hot water apparatus and the gas stove—the burning of coal for cooking and heating is quite got rid of.

I ought, perhaps, to say a few words on the other system of roasting by gas—that of heating by radiation direct from the gas flame. That is the method which has been used by Mr. Sugg in his gas kitcheners. His, I believe, are generally made of copper. He has two rows of luminous gas jets, one in front and the other behind, and the joint is made to turn on a spit between them. In this way the radiant heat of the luminous flames roasts the joint. He claims for it that the joint has a better flavor than it has when it is cooked by a Bunsen burner. My own experience is that joints cooked in Mr. Fletcher's stoves have a most excellent flavor, certainly quite as good as when roasted before an ordinary fire. I have tasted joints cooked in gas ovens—improperly cooked, because the supply of air was not sufficient; the meats were really baked in that case by hot air, and were not roasted by radiation, and I think that made all the difference. In these roasters the meat is entirely cooked by radiation. That all the dainties I propose to show you cooking in this stove will turn out successfully, I will not venture to predict, because I am a very inexperienced cook; but I may say this, that a bachelor may grill a steak or a chop with a gas stove and be perfectly satisfied with it. In this gas kitchener I have been roasting a leg of mutton, baking potatoes and a fruit tart, and making tomato soup, and if those who are experienced in domestic cookery will kindly pronounce upon them afterwards they shall be placed at their disposal.

Just a word or two about the ventilation of rooms by the ordinary English method of a coal fire, aided by crevices under the doors and in the window sashes, and the system of ventilation and lighting a room at once as it can very well be done by coal gas. The ordinary method of ventilating a room I have called the English method—an open coal fire aided by the crevices under the door—because in the vast majority of houses we go into in England we find that such is the only method of ventilation provided.

What happens in such a room as this? If the fire burns well it will draw in some thousand cubic feet of air an hour, a little more or less, and that will

be supplied not from the general air of the room, but from the lowest stratum of air in the room, that on a level with our feet. The air in the upper part of the room will remain unaffected, and only the air low down near the floor will be drawn into the fire. Now the air which flows in to fill this space will pass in under the door, through the key-hole, or any other small crack where it can find entrance, and many colds and unpleasant consequences are produced by this method. It does produce a draught certainly in the room, but it does not change the air we are breathing so well as if we had a very much smaller ventilating power placed in the upper portion of the room. Now, if a room were lighted with such a regenerative burner as I showed you last Monday, where the air was continually drawn in to feed the coal gas flame, and then, mixed with the products of combustion, passed away through a pipe, we should have a continual change of air in the upper parts of the room—exactly where the change is required. The heated products of combustion of any flame in a room, be it candle or lamp or coal gas, are lighter than ordinary air, and pass up to the ceiling, and so does the breath from the people in the room. The consequence is that in an ordinary room the impure air is near the ceiling, and the purer air near the floor. It is not important to change the air near the floor; it is important to change it in the upper part of the room. Now, a gas burner in which the products of combustion are drawn away, does so ventilate a room by changing the air at the top. Where a burner carrying off its products of combustion cannot easily be placed in a room, it is easy to place a ventilator near the cornice to carry off the vitiated air. The heated gases from the gas flame, or whatever other flame is used to light the room, must pass towards the ceiling; and if we give them there an orifice to escape by, they will escape by it. But we must remember one thing; one must supply continually a stream of fresh air to take the place of the air so drawn off, and we must not allow the air to force itself in through nooks and crannies and so produce draughts. What we want in ventilation is a large body of air flowing gently through a large opening. In this way draughts are avoided, and the fresh air spreads itself out quietly throughout the whole room. I think one of the best systems of ventilation is that in which the in-currents of air are brought up by a large pipe and allowed to flow out some 7 or 8 feet from the floor. As it is brought into the room it has an upward flow which throws it out towards the ceiling. Such a current of air will not have sufficient force to flow right up to the ceiling and mix with the products of combustion and hotter air derived from the gas flames, but it will form a layer under these, and will then gradually subside all over the room. Some of it will, of course, be drawn to the gas burner and will there be burnt, and it will then pass to the ceiling. Another portion will pass downwards and feed the fire, and that will pass up the chimney. The important part of such an arrangement is this, that the fresh air is brought in at two-thirds of the height of the room, and spreading itself out evenly over the room, feeds both the gas flames and the fire, and the people in it. Now, in such a system of ventilation the gas flame in the room plays an important part. Even if we cannot have that which I think is the best system, a regenerative burner, carrying off its products of combustion, and so producing an artificial ventilation, we can have ordinary gas burners and orifices near the ceiling to carry off the heated air.*

Among the apparatus for heating and ventilation worked by gas is one which works very successfully, called the "Lux Calor;" it gives both light and warms the air. In the center is a ring burner. The products of combustion pass upwards, and then turning over, pass downwards through the annular space between two metal cylinders. These cylinders are in contact inside and outside with the air of the room, so that whatever will be condensed out of the products of combustion by cooling are condensed in the apparatus. We find that water, mixed with some carbonic acid, and a small quantity of sulphurous acid from the sulphur of the coal gas, flows in drops from the bottom of the apparatus. Air is continually passing through the cylinders, and is warmed up in its passage. The cylinders between which the hot products of combustion of coal gas are passing heat up the air in contact with them, so that the air becomes lighter than the corresponding column of air outside and rises. Accordingly we have a continual draught in of fresh air at the bottom, and warm air passing out at the top. It does not come anywhere in contact with the products of combustion of the coal gas, but merely in contact with the hot sides of the cylinders. The air then in the room continually passes through these copper cylinders and so becomes warmed. The apparatus may also be arranged so as to bring in a supply of fresh air from the outside of the house, and warm it in bringing it in. At the back of the apparatus is a hole to which can be attached a pipe

* At the end of the first lecture of this course there is an omission which I take the opportunity of supplying. In speaking of the formation of sulphuric acid from the sulphur in coal gas, I said that no condensation of steam, and consequently no oxidation of the sulphurous acid, could take place in a room to which the necessary air supply was maintained. I omitted to state that the air supply for ordinary ventilation should be such as to keep the quantity of carbonic acid present in the room below a certain small maximum. If 10 cubic feet of gas are burnt per hour in a room of 2,500 cubic feet capacity, the whole of the air must be renewed once in two hours, in order that the quantity of carbonic acid in the atmosphere of the room may not exceed 5 per cent. If the ventilation is such as to cause this renewal of the atmosphere, then the steam produced by the burning of the coal gas will not exceed 1 per cent. of the atmosphere, and will pass away uncondensed.

from the outer air, and through this pipe the air is drawn; it would pass through this system of cylinders, and is warmed in its passage. The burner itself having a glass sheet in front, or else being open, gives light, and the whole apparatus may stand in a passage or office, and both light and warm the air in it.

Now I am not so thorough-going an advocate of coal gas as to wish that our coal fires should be entirely abolished. I confess that I like poking a fire, and I know many people share my prejudice; but there are many rooms (bedrooms, for instance) where one would be very glad to light up a fire on going to bed, or on rising in the morning, without the trouble of having a coal fire laid. For such a purpose I think an asbestos fire answers most admirably. It is made in this way: One has an atmosphere flame—that is to say, coal gas mixing itself with air, and burning with this non-luminous flame, and in the flame is placed a fire brick or asbestos, or some incombustible substance. On the table I have such an asbestos grate. In the front of it is a pipe bringing in the coal gas, so that the atmospheric flame plays over a quantity of asbestos fastened in between the crannies of fire brick placed at the back of it. It is lit in a moment; it gives out plenty of radiant heat, which is the kind of heat we want; and I think it presents a very agreeable appearance. And not only that, it serves perfectly well for boiling a kettle, which can be placed in front of it on a little hob provided for the purpose. What we want in a fire-place chiefly is radiant heat. We do not want the Continental gas stove, which gives us simply hot air in the room. English people are accustomed to be warmed by radiation, and to live in cool air. It oppresses us to pass into a room where the air is heated; we like to inhale cool air, but we like to feel the wall and other objects in the room to be warm. This, of course, is effected by radiation. Radiant heat passes directly through ordinary air without heating it in any appreciable degree; air is only heated when it comes in contact with hot substances. Now, such a fire as I have on the table gives out radiant heat through the device of placing in a non-luminous-Bunsen flame a solid substance which is raised up to a bright red heat, and then radiates heat. Such a stove, I think, is suitable for many rooms in a house not frequently lived in. I do not think it is quite a satisfactory substitute for a sitting-room fire. But consider for a moment what the effect would be if the kitchen fires of all London houses were abolished, with their boilers and other abominations, and if one-half the other fires were also abolished and replaced by such stoves as I have shown you this evening. These stoves have been standing in the room unconnected by any pipe to the chimney, and nobody can see any products of combustion coming from them. The coal gas in them is perfectly burnt, and passes away as steam and carbonic acid. With such heating arrangements as these we should have no smoke, and with no smoke in London, we should have no London fog. We should have fog, but we should not have that particular article called "London" fog, in which the particles of moisture which make up the mist become coated with a carbonaceous, sulphurous cuticle. This acrid, sooty scum is that which gives it that particular character which has earned the London fog its notoriety. The English Channel has quite as many fogs in it, perhaps more than London has, but the fog in the English Channel is a clean white mist; it wets you a little, but when it has passed away you are none the worse, whereas London fog, owing to this cuticle of dense smoke upon it, is one of the most deleterious things of modern civilization. Now, the moderate use of coal gas would very greatly, I think, diminish the evils of the London fog, and I think it would not at all diminish the comfort of our houses. I think that such a stove as Mr. Fletcher has lent me this evening, and with such a heater as Mr. Harcourt has devised, we might get on very comfortably in our houses; and I think with such an asbestos stove in our bedrooms we should be more comfortable than we generally are. At the same time we should have the satisfaction of knowing that we were preserving the atmosphere free from taint, and not choking our neighbors with our kitchen smoke.

In bringing this course of lectures to a conclusion, I have to thank the gentlemen who have so kindly placed their apparatus at my disposal, especially Sir James Douglass, for that brilliant lighthouse burner he lent me; Mr. Fletcher for these stoves and burners; Mr. Sugg for many admirable burners; and Messrs. Ritchie for this heating and lighting stove; and to all of you for the very great attention with which you have listened to me.

A vote of thanks to the lecturer having been passed unanimously, on the proposal of the Chairman, Mr. B. F. Cobb, Mr. Harold Dixon said:

By way of reply, perhaps I may read a short abstract from my note-book of the cost of such a system as I have attempted to explain to-night of cooking and heating entirely by gas. These figures are obtained from the house of a friend of mine in Oxford, whose hospitality is well known, and whose table, as I can vouch for, is of the best. He tells me he has done all his cooking for the last three years in a Fletcher gas roaster, and he has heated all the water used in his house in a therma similar to this, not the same, but one of Mr. Fletcher's; and in his kitchen he has adopted a boiler something like a large saucepan with a coal gas flame underneath. The cost of that, on the average for a household of eleven persons, including twelve gas burners,

because he employs gas in the kitchen, scullery, passage, hall, and consulting-room, is £28 a year. This is an average of three years' consumption. It seems to me, if one considers what is the average amount of coal burnt in a kitchen fire for a family of 11 persons, and consider what the coal gas burnt at twelve burners constantly alight is, that the sum becomes exceedingly small. The following is the list of apparatus worked by the gas—one large cooking stove, and one small one, one boiler, five Bunsen ring burners, and two water heaters. This is all done for £28 a year; but I must mention that the price of coal gas in Oxford is only 2s. 8d. per 1,000 cubic feet.

Annual Report of the Edison Electric Illuminating Company.

[Mr. S. B. Eaton, vice-president of the Edison Electric Illuminating Company, of New York city, has presented the following annual report to the stockholders of that corporation. Believing that the figures given will prove how far Mr. Edison has succeeded in accomplishing the job undertaken by him (that of "closing up" the gas companies of New York city) some five years ago, we submit the same without further comment.]

To the Stockholders of the Edison Electric Illuminating Company, of New York City:

Your company has now completed the fourth year of its existence, and your board feel that the results achieved are a fair cause for congratulation as to the past, and for encouragement as to the future.

Your enterprise was one of peculiar boldness. Starting almost from the moment that Mr. Edison had demonstrated the scientific success of his great invention, you undertook to apply practically, and to its fullest extent, a system which had scarcely been tried at all, except in the laboratory, and which, so far as underground and central station work was concerned, existed only theoretically. When the construction of the present central station was commenced there were in use perhaps a half-dozen small, imperfect, isolated plants; and with only these to guide you, you undertook and have carried to scientific and financial success the great problem of underground central station lighting by electricity in competition with gas.

At the date of the last annual report the First District had scarcely more than reached the point where its receipts were in excess of its expenses. During each and every month of the present year they have shown a handsome increase as compared with last year, and instead of a loss, as in 1883, the operations of 1884 will leave a surplus of fully 3½ per cent. on the capital stock, after paying expenses of every kind.

The following table shows in detail the average number of customers and of lamps connected, the collections, operating and general expenses (including all repairs and renewals), taxes, etc., and the profit or loss for each quarter of the years 1883 and 1884. It will be remembered that prior to February 1st, 1883, the light was supplied, as an experiment, free of cost to consumers.

Month.	Average of customers connected.	Average of lamps connected.	Collections.	Operating and general expenses.	Loss.	Profit.
1883.						
Feb. March..	330	4,374	\$3,788 64	\$9,904 48	\$6,115 84
Ap. My. June.	393	5,931	8,711 89	14,752 28	6,040 39
Jly. Aug. Sep.	439	8,685	15,689 01	15,197 31	\$491 70
Oct. Nov. Dec	483	10,172	24,900 11	17,693 08	7,207 03
1884.						
Jan. Feb. Mar	498	10,685	28,659 34	18,229 88	10,429 46
Ap. My. June.	541	11,594	25,400 54	18,148 97	7,251 57
Jly. Aug. Sep.	582	12,503	23,849 34	19,975 88	3,873 46

The financial results of the foregoing table are summarized in the following:

	1883.	1884.
February and March.....	\$ 6,115 84 loss*	\$10,429 46 profit.
April, May, and June.....	6,040 39 loss.	7,251 57 profit.
July, August, and September.....	491 70 profit.	3,873 46 profit.
Oct., Nov., and Dec.....	7,207 03 profit.	14,000 00 profit.†
Net loss, 1883.....	\$4,457 50	
Net profit, 1884.....		\$35,554 40

As a matter of course, the profits of the station fall off considerably in the summer months, as will be seen from an examination of the foregoing tables. To neutralize this falling off in part, your company has undertaken to fur-

nish electric motor fans to be run by current from the central station; and while their introduction last summer was not possible until too late to secure any considerable results, the fans met with such favor as to warrant the belief that next summer they can be developed into an appreciable and permanent source of revenue.

A heavy item in the operating expenses of the First District has heretofore been that of lamp renewals. Owing to imperfect electrical determinations in the construction of the district, and the consequent inequality of electrical pressure, the lamp breakage was unduly heavy. It is very gratifying to state that during the past summer these defects of construction have been mostly corrected, and improvements have also been made in the lamps themselves, with the result of raising the life of lamps from 400 hours of use in January to 914 hours in November, which is equal to a monthly saving of about \$400 in operating expenses on the number of lamps in use at the present time.

The average monthly life of lamps during the past year, as reported by the superintendent of the station, has been as follows:

January.....	400 hours of use.
February.....	523 " "
March.....	349 " "
April.....	448 " "
May.....	400 " "
June.....	389 " "
July.....	502 " "
August.....	553 " "
September.....	727 " "
October.....	730 " "
November.....	914 " "

The following additions have been made to construction account of First District since January 1st, 1884:

New plant, including two engines, 150 h. p. each; two dynamos, 1,200 lights each; two regulators, and expenses of installing same.....	\$34,125 03
Station apparatus.....	1,123 01
Street conductors, viz., 3,849½ feet.....	17,140 39
House connections and original lamps.....	2,958 41
Meters.....	133 31
Tools and implements.....	22 68
Motors.....	2,439 00
Office fixtures.....	59 33
Total.....	\$58,001 16

The expediency of these expenditures, which have only been made after careful deliberation, is best shown in the financial results achieved, which are due in a considerable degree to the fact that the increased expense of running the station, as enlarged, bears but a small proportion to the increase of receipts secured by the enlargement. The station is even now taxed to its utmost capacity, and it is evident that further additions to the existing plant could be made with substantial advantage to the company. In fact, the superintendent of the station reports that there are now on file over 100 applications for the light, of which at least 50, requiring about 750 lamps, would furnish very desirable customers.

Notwithstanding the recent reduction of the price of gas from \$2.25 to \$1.75 per 1,000 cubic feet, our First District station has not yet lost a single customer, which is the best possible proof that our light, at its present cost (one and one-fifth cents per hour of use for lamps of 16-candle power), is found more desirable and satisfactory than gas even at the reduced price.

Of even greater importance, however, than the enlargement of the First District is the question of starting a district up-town. When your company was organized it was believed that its authorized capital would be sufficient to install both an up-town and a down-town district, but the delays and difficulties encountered with the down-town district were so great that the capital proved insufficient to install it alone, and even now your company finds itself in debt to the Light Company for more than \$70,000 for money advanced and balance of license, though against this your company claims certain offsets arising from the increased cost of the First District. In fact, the down-town district has been operated in the face of every possible disadvantage; but your board has believed that it was pursuing the right policy in showing what could be done under all these unfavorable circumstances, hoping thereby to shorten the time when it could enlist the necessary capital for work up-town.

The present district, which is bounded by Wall street, Broad street, Exchange place, Broadway, Spruce street, and the East River, is perhaps the least remunerative of any in the city, being occupied mainly by banking and other offices, which are closed on an average earlier than 6 o'clock, so that the hours of light consumption are very short.

A far richer field for your enterprise would be an up-town district, extend-

* For two months only. The loss for three months would be even larger.
 † The profits for December are estimated at..... \$5,500 00
 The actual profits for October and November were..... 8,500 00
 Making the estimated total for the quarter, as above..... \$14,000 00

ing perhaps from 23d street to the Central Park, and from Eighth to Madison avenue. Not only would the hours of light consumption be much longer, but, owing to the great cheapening now made in the cost of everything connected with the Edison system, the cash capital required entirely to install and equip a station of light-giving capacity equal to the present one (and situated somewhere within the limits indicated) would be, as appears from preliminary estimates already made, not over one-half the amount spent for the down-town station. It is estimated that during the coming year this latter will earn fully 5 per cent. on its stock, or equal, in other words, to 10 per cent. on the cost at which it could now be duplicated. In an up-town station, where there would be longer hours of light consumption, it seems very reasonable to assume that half again as much profit, or at least 15 per cent. net per annum at the start, could be earned; and were it not for the general depression at present affecting all electric light investments, embracing both the good and the bad, your trustees would not hesitate to come before you at once with some scheme to raise the capital for a large up-town installation. In all probability considerably more than 15 per cent. could be earned in an up-town district; but even on this basis it is felt that with the results already achieved in the First District, the time is near when a successful plan can be formulated for an up-town station, and as soon as one large station is started up-town there can be no doubt that the extension of the system throughout the entire city of New York will follow.

Your present capital stock is the same as at the date of the last report, viz., \$1,000,000, made up as follows:

Paid in.....	\$987,010
Unpaid subscriptions.....	11,490
Stock in treasury.....	1,500
	\$1,000,000

As the fiscal year of the company ends on the 31st of December, it is recommended that the time for the annual meetings in future be changed to the third Tuesday in January, when the actual results of each previous twelve months can be presented in their entirety, without the necessity for partial estimates which at present exists.

Sir F. Bramwell on the Progress of Invention.

[Sir F. Bramwell, President of the Institution of Civil Engineers (Eng.), delivered his inaugural address before that body on date of Tuesday, January 20. For a condensed report of same we are indebted to the *London Journal*.]

Commencing with the improvements effected in girder construction, Sir F. Bramwell referred to the works now in progress at the Forth Bridge; and cited the St. Louis Bridge and the East River Bridge, New York, as instances in which novelty had been introduced. He then passed on to consider the question of harbor construction, dwelling at some length on the principle employed by Mr. Stoney, of Dublin, where cement masonry is moulded into the form of a wall for its whole height and thickness, the blocks having a weight of 350 tons. This subject naturally led into the allied one of sub-aqueous work; and, in connection therewith, tunnelling and boring work generally was dealt with. In ordinary land tunnelling Sir Frederick said there had, since 1862, been great progress, by the substitution of dynamite, and preparations of a similar nature, for gunpowder, and by the improvements in the rock drills worked by compressed air, which are used in making the holes into which the explosive is charged. For boring for water, and for many other purposes, the diamond drill had proved of great service; and most certainly its advent should be welcomed by the geologist, as it had enabled specimens of the stratum passed through to be taken in the natural unbroken condition, exhibiting not only the material and the very structure of the rock, but the direction and the angle of the dip of the bed. Coal-getting machines, such as those of the late Mr. Firth, worked by compressed air, reduced to a minimum the waste of coal, relieved the workman of a most fatiguing labor in a constrained position, and saved him from the danger to which he is exposed in the hand operation. The employment of hydraulic wedges in lieu of gunpowder to force down the block of coal which had been under-cut was one of the means to be looked to for diminishing explosions in collieries. As to accidents in mines, investigations had been made into the probable part played by the minute dust which prevails in dry collieries. The experiments of Sir F. Able had been of the most striking and conclusive character, and corroborated investigations of the late Macquorn Rankine into the origin of explosions in flour mills and rice mills, which had previously been so obscure. One of the earliest workers in this direction was Mr. Galloway.

Passing over the subjects of pile driving, the improvement of navigable canals and rivers, shipbuilding and ordnance, to which Sir F. Bramwell next directed attention, we come to his remarks on the materials employed in construction. On this matter he said: Probably few materials have been found

more generally useful to the civil engineer, in works which are not of metal, than has been Portland cement. During the last 22 years great improvements have been made in the grinding and in the quality of the cement. The artificial material, brick, cannot in these days be said to surpass in quality the bricks used by the Romans in this island 1,900 years ago; but as regards the mode of manufacture, and the materials employed, there is progress to be noted. The brick making machine and the Hoffmann kiln have economized labor and fuel, while attempts have been made (which I trust may prove successful) for utilizing the clay which is to be found in the form of slate in these enormous mounds of waste which disfigure the landscape in the neighborhood of slate quarries. Certain artificial stones, moreover, appear at last to be made with a uniformity and a power of endurance. In respect of these qualities they compare favorably with the best natural stone; and still more favorably having regard to the fact that they can be made of the desired dimensions and shape, thus being ready for use without the labor of preparation. Of timber in new countries the engineer commonly is glad to avail himself to an extent which among us is unknown. Owing to the ready adaptability of metals to the uses of the engineer, the employment of wood is decreasing. Many attempts have been made to render timber proof against the two great defects of rapid decay and ready combustibility. The asbestos paint is used to coat the wooden structures of the Inventions Exhibition. To the employment of this it is not too much to say those buildings owed their escape, in last year's very dry summer, from being consumed by a fire that broke out in an exhibitor's stand, destroying every object on that stand, but happily not setting the painted woodwork on fire, although it was charred below the surface. A surface application may not enable wood to resist the effects of a continued exposure to fire; but it does appear that it can prevent its ready ignition.

Dealing with the improvements which have been effected in the production of steel, Sir Frederick said: Eight years since I delivered, at the Royal Institution, a lecture on "The Future of Steel;" and every year that has passed has justified the opinions I then ventured to put forward as to the way in which steel, made by fusion, would supersede iron made by the puddling process. I am not afraid to repeat my prophecy that the time will come when the use of iron made by that process will be restricted to the manufacture of small articles produced by the hand labor of the village blacksmith, for whose art its plastic character and ready power of welding eminently fit it. Probably the first great revelation in steel manufacture was the exhibition of the ingots, with other products, shown by Krupp in the Exhibition of 1851. The making of steel in crucibles is not so satisfactory a mode of obtaining uniformity in large masses as is either of the other two great systems of manufacture—the Bessemer and the Siemens, the two processes which have changed the whole complexion of the iron industry. By the process of Messrs. Thomas and Gilchrist, it has been rendered possible to employ successfully, in the production of steel, iron derived from ores which, prior to the date of this invention, had been found wholly inapplicable for the purpose. In the manufacture of pig iron many improvements have been effected. The mysterious influences that a very small percentage of some material will exercise upon the quality of the great bulk of another material with which it may be united are well shown in the case we have been considering—that of steel—where a few tenths of 1 per cent. of carbon added to the iron suffices to change the iron into steel. We are not surprised, therefore, when we find that other metals may have their qualities improved for many useful purposes by judicious alloy; and in this way the metal copper, so long used in its alloyed condition of "gun-metal," has within the last few years been still further improved by alloying it with other substances, and thus making it into the now well-known articles of "phosphor-bronze" and "manganese-bronze"—very useful materials to those of our members engaged in the construction of machinery. I think the time is not far distant when, following the lead of Sir Joseph Whitworth, all steel in its molten state will be subjected to pressure, not with the object of making the metal more dense, but of diminishing the size of any cavities containing imprisoned gases. If this is not done, then some other mechanical means will be employed to get rid of the cavities altogether, and thus to produce (without variations in the constituents of the steel) a casting that shall be practically, if not absolutely, free from blowholes, and so that such casting, when afterward forged by pressure, and not by percussion, may be thoroughly trusted to contain no latent defect.

In regard to steam engines and boilers, Sir Frederick said it was difficult to point to any great substantive novelty. These machines had, however, been more and more scientifically investigated, and the results of such investigation had been practically applied, and attended with the advantages anticipated. At the same time, the engineer using steam as his vehicle in a heat motor still had to submit to the chagrin of seeing the largest portion of the heat pass away unutilized. This defect had for years attracted the attention of scientific engineers. Extending his remarks on this subject, he continued as follows: There is, however, another form of heat motor which, while vainly essayed during 50 years, has within the last eight years come

into common use, and the application of which, in cases requiring anything up to 30 indicated horse power, is daily increasing. I allude to the gas engine. By a happy change in the mode of burning the mixture, and of utilizing the heat thereby generated, the injurious shock of the early forms of gas engine, and the larger consumption of gas which caused these earlier forms of engine to be discarded after trial, were obviated. In 1866 the French engineer who tried a Hugon gas engine found that 74 cubic feet of gas per indicated horse power per hour were required. This is now replaced by the 20 to 23 feet per indicated horse power consumed in the engines of the present day. With the low price of gas commonly prevalent in England, this consumption does not cost more than some $\frac{1}{4}$ d. per horse power per hour. It may be said that with coal, even at the London price of £1 per ton, I might use a steam engine having the low economy of 8.5 pounds of coal per indicated horse power per hour before I should be called upon to spend $\frac{1}{4}$ d. per indicated horse power per hour for fuel. You would be astonished to hear, however, that in an investigation instituted last year by the Corporation of Birmingham, when considering whether they should approve of a proposal to lay down power-distributing mains throughout their streets, it was found, on indicating some six non-condensing steam engines taken indiscriminately from among users of power, that the consumption in one instance was as high as 27.5 pounds, while it never fell below 9.6 pounds, and the average of the whole was as much as 18.1 pounds. This heavy consumption arose largely from a very prevalent defect—that of too great cylinder capacity; for unless a non-condensing engine is admirably designed, and made with the object of using very high expansion, there is nothing so wasteful as the employment of that which the buyer of an engine looks upon as an advantage—very great cylinder capacity. Even assuming that the user of a gas engine were entitled to compare it with a non-condensing steam engine consuming only some 5 pounds of coal per indicated horse power per hour, and demanding, therefore, at 1s. per cwt., only $\frac{1}{4}$ d. for the purchase of coal, this difference in cost is well repaid by the saving of boiler space, of the wear and tear and of the renewal of the boiler, of the consumption of coal while getting up steam and during meal times, and the saving in the engineer's or stoker's wages. On public grounds, too, there are the advantages of freedom from boiler explosion, and of cessation of smoke production. Engines are now being made to develop 50 horse power; and, when used on a large scale, so that it would pay to have an attendant devoting his whole time, there is no need to work them with illuminating gas from the street mains. They can be driven by producer-made gas on Dowson's system; and, when worked in this way, 1.5 pounds of "culm" will give 1 horse power, and one lad is sufficient to manage a gas-producing apparatus of a size adequate to provide for engines developing 300 indicated horse power.

At the meeting of the British Association, at York, in 1881, I said that unless some wholly unexpected improvement were made in the steam engine, those who lived to see the celebration of the centenary of the Association in 1931 would find the steam engine had become a curiosity, and was relegated to museums; for I could not believe steam would continue to be the vehicle for transmitting heat into work. With respect to the power of the tide, however, I for one have been very much fascinated with the scope there appeared to be for engineering in utilizing tidal power, especially where there was a great ebb and flow. But very few businesses needing motive power can allow their plant to remain idle for nearly half the working day; and as there is an objection to remedying this condition of things by working, when possible, both during the night-tide and during the day-tide, this was an obstacle in most cases to the use of tidal power. Further, when it was sought to preserve continuity of action by providing a series of reservoirs, the outlay needed was so large that the mere interest on it would pay for the fuel for a steam engine—I am afraid, therefore, that, except in certain cases—such as the pumping of water into a reservoir, or the charging of so-called storage batteries, or matters of this kind not connected with ordinary manufacture—this source of power is not likely to compete commercially with heat motors until coal is very much dearer. It is not to be wondered at that the proverbial uncertainty of the wind causes motors which have to be driven by it to be disregarded as substitutes for steam engines; but it is well worth considering whether wind motors could not be employed as adjuncts to them.

Touching on the subject of the transmission of power from one part of a machine to another, Sir Frederick acknowledged that many improvements had lately been made. On this point he said: For long distances we have the development of hydraulic transmission; pipes being now laid down for supplying water under 700 lbs. pressure per square inch; we have companies authorized, if not at work, for laying down pipes to distribute compressed air; we have now, by reason of the improvement in gas engines, the ability to lay on power in every town illuminated by gas (which practically means every town and large village); and we have in New York, and in some other cities of the United States, high-pressure steam, conveyed in mains below the streets, to be used both for power and for heating, for which second purpose, however, it should be remembered the contents of a gas main are equally available. There is the rope system at Schaffhausen; and we may take it

as clearly established that we are, day by day, becoming more alive to the benefit, where little power is required, or where considerable power is required but only intermittently, of deriving that power from a central source.

The concluding portion of the address dealt with the important subjects of water and gas supply, regenerative furnaces, the development of the mineral oil industry, and the utilization of natural gas. Sir Frederick's remarks on these topics were as follows: Except in the magnitude of the work and the excellence of the design, of which the new Liverpool Water Works now in progress may well stand as a typical example, there is not much to say as regards progress in those water works which are dependent upon storage. In the United States and Canada the waste of water that takes place not only causes the mains to be incapable of keeping up the pressure under the excessive draught, but renders sources of supply insufficient, which would otherwise be ample for years to come. Progress has been made here in the matter of house fittings by which waste has been greatly checked, and the risk of contamination that formerly existed with certain closet fittings is ended. This question of house fittings has always been a difficult one, and cannot be grappled with by water authorities such as those in the United States and Canada—that is, municipal authorities afraid of offending the voter. We owe it, however, to Mr. Deacon, the engineer of an English municipal water authority, that it is now possible to deal with the correction of household connections at a minimum of cost, and, what is equally important, with a minimum of annoyance to the householder. In most of our towns the supply is satisfactory; but, in spite of the alarm raised by the suggestion of double mains, we might do well in many cases, where there is a pure but limited supply, to have a dual system of mains, and thus to distribute the pure water separately and for potable purposes. The Parisians at least have recognized the expediency of thus "sorting" their supply when that supply is of varying quality, and when the best of it is limited in quantity. In cases where there appears to be no thoroughly satisfactory source of water, the experience of the efficacy of iron purification, as practiced at Antwerp, does hold out very considerable promise.

Gas has been alluded to by me under the heads of motors, and of transmission of power and of heat; but I now desire to say a few words in connection with it under its more ordinary aspect—that of a distributed illuminant. In 1862 the price of ordinary coal gas in London was from 4s. to 5s. per 1,000 cubic feet; the illuminating power was such that five cubic feet of the gas burnt in a specified burner in one hour should give a light equal to 12 sperm candles, each burning 120 grains in the hour. At that time the consumer was, as it was facetiously called, "protected" by restricting the company to a maximum statutory dividend. Obviously so soon as this dividend was earned all incentive to improvement was removed. One of the few cases in which recent legislation relating to private companies supplying public wants can meet with the approval of the political economist was that which a few years ago first recognized that it would be well for the private company and for the public that the ordinary incentive of increased profit for increased exertion should remain, and that introduced in certain gas undertakings the sliding scale. This provided for a normal price, and a maximum dividend, but allowed the company to rateably increase the dividend in accordance with a decrease in price below the normal. Under this wiser legislation 16-candle gas is sold in London for as little as 2s. 10d. per 1,000 cubic feet. But illuminating gas has to be considered by the engineer under two distinct heads—one, its manufacture and distribution; the other, its utilization. This last, it is true, is but to a small extent in the hands of those engineers who have the charge of the first. Considerable progress has, however, been made of late in illumination; largely, it is true, owing to a greater liberality on the part of lighting authorities, and the use thereunder of multiple burners in street lanterns, but to a considerable extent due to that much more to be desired improvement, whereby a greater amount of light is obtained from the same volume of gas. The regenerative gas burners, and other modes of burning, into which time will not permit me to enter, promise to largely increase (it is said, even to more than double) the candlepower per cubic foot of gas burnt. Such improvement as this is undoubtedly of great moment, not only on the score of economy, but on the sanitary ground of diminishing the amount of products of combustion poured into a room in relation to the light afforded therein. It need hardly be mentioned that the decrease in cost and the increase in profits are largely due to the application of chemistry to this manufacture, by which application the former nuisance-creating by-products have been made sources of revenue and fertilizers for our fields.

I have also, in the most cursory manner, mentioned gas as a means of distributing heat. But a word should be said about those valuable improvements in gas furnaces—I do not mean the Siemens furnace—which have enabled coal gas to be applied to the melting of even very refractory metals by means of most inexpensive plant. Nor have I spoken of those other applications where, either burnt with coke (it may be of the very coal from which the gas itself was derived), or caused to raise incombustible bodies to

incandescence, it forms the cheerful and smokeless substitute for a smoky coal fire, or is utilized for the purposes of domestic cookery. In this latter case, however, if absolute cleanliness and ventilation are not preserved, there will (as the unhappy traveler, compelled to temporarily sojourn in the "limited" hotels of the present day finds to his cost) be one universal dirty gas oven flavor impressed upon all his food, be it the homely leg of mutton, or the lordly haunch of venison.

Although it is quite certain that the first suggestion for using liquid fuel (notably tar to aid in heating gas retorts) must date long before 1862, yet the great development of the mineral oil industries since that date has led (and especially in Russia, in whose territory such enormous yields of oil are afforded) to the employment of this material as a fuel in furnaces and in steam boilers. Next to the infinitely divisible forms of gaseous and of liquid fuel comes, as I have said elsewhere, the dust fuel introduced by Mr. Crampton. In the use of any of these three forms regularity of mechanical supply is a condition involved. Any one of these three, therefore, irrespective of all other considerations, is desirable, because it is a means of dispensing with that most unsatisfactory form of labor—"stoking;" dispensing also with the production of smoke, and with the diminution of maximum effect attendant on the hand-feeding of coals, where the condition of the fuel in the grate and its temperature must be ever varying. Having regard to these advantages which are to be obtained in using oil, and to the cheapness of the material in Russia, one is not surprised to find that there are lines of steamers on the Caspian worked entirely by liquid fuel, and that the same kind of fuel is used to fire the locomotives in many districts.

I have mentioned the improvement in small furnaces worked by illuminating gas. But I am not entitled to bring within my period the regenerative gas furnace—that great invention made by our lamented friend, the late Sir William Siemens, with whose name in this matter should be coupled that of his brother, Mr. Frederick Siemens. This latter gentleman, by a course of study, has only recently discovered that so far from the heating power of the flame being increased by its confinement within narrow chambers, and by its being brought into contact with the material to be operated upon, such arrangements only diminish this power; and he has further found that this discovery can be usefully applied in practice by keeping the roof of a regenerative gas furnace at such a height above the earth on which the materials to be heated lie that the flame can traverse from one side of the furnace to the other, free of contact with the roof above or with the materials below. Very excellent economic effects and a high heat have, it is stated, been obtained by causing the outgoing products of combustion to give up their heat to the incoming cold fuel. I have seen such furnaces in operation, making steel by the hearth process; and it is the fact that the chimney has been without a trace of red glow within it.

The natural oils which are used as fuel are rarely employed in the crude state as obtained from the wells, but undergo more or less refining before use. There is another natural fuel, however, which has been discovered in America, and within the last few years largely utilized—this is the gas obtained from wells in a manner similar to that in which the oil is obtained. It is a marsh gas of high calorific power, and is in certain parts of the United States being used very largely for domestic heating, for the heating of furnaces of every description, including those for the manufacture of plate glass and of steel. It is also being employed for the manufacture of lamp or carbon black, and for the carbon points for electric lighting. It is stated that within a radius of 20 miles from the town of Pittsburg, taken as a center, there are 25 wells, each producing 3,000,000 cubic feet per 24 hours; and that the produce of the whole of the wells at present opened up is 100,000,000 cubic feet of gas per day. To my mind this is one of the most perfect fuels which can be imagined. It does not require preparation, but can be and is used in the same state as that in which it issues under high pressure from the wells; it can be mechanically controlled with the greatest nicety, and, when properly burnt, it is entirely free from smoke or similar defects. When employed in the Siemens regenerative furnace, the producer which is necessary where coal is used is entirely dispensed with.

Sir Frederick closed his address by remarking that, even with the severe limitation which he had imposed on himself, he found omissions were inevitable, and concluded by assuring the meeting that during his term of office he would do everything in his power to uphold the dignity, the honor, the usefulness, and the prestige of the Institution.

Hocking Valley (Ohio) Coal.

Saward's Journal, in an article on "The Character and Composition of Hocking Valley Coal," says the character of the coal throughout the field is fairly uniform. Taken as whole, it is an open-burning coal of pronounced character, but the lower bench, burned by itself, is somewhat cementing. It is distinctly laminated, and holds a moderate proportion of mineral charcoal. It ignites easily, swells slightly in burning, and leaves a white or gray ash. It is well approved for steam generation, and also for rolling mill fuel.

To household use it is admirably adapted, rivaling in this line of service the Block coals of the Mahoning and Tuscarawas valleys. The most important single use to which it is put is iron making. The successful experience of the blast furnaces that have been built in the valley within the last ten or twelve years, and that have made the Hocking Valley coal their chief and often their sole reliance for fuel, leaves no open questions in regard to its adaptation to this important service. As a furnace coal it is not surpassed in the State, and scarcely by any known bituminous coal. It is also used to a small extent in gas making.

In chemical composition, the average of ten mines, including several of the best of the field (the mines being located in Shawnee, and from there westward as far as Nelsonville), is as follows:

Average of Ten Mines of the Hocking Valley. (Lord.)

Moisture.....	5.93
Volatile combustible matter.....	36.48
Fixed carbon.....	52.41
Ash.....	5.13
Total.....	100.00
Sulphur.....	1.19

The best showing from any one of these mines, and also the poorest results from any one mine, are given below—Nos. 1 and 2:

	1.	2.
Moisture.....	6.61	5.38
Volatile combustible matter.....	36.40	37.58
Fixed carbon.....	54.17	51.21
Ash.....	2.81	5.83
Total.....	99.99	100.00
Sulphur.....	.51	1.94

While there is something to choose between the products of these two mines, the figures show scarcely wider differences than we ought to expect from different rooms of the same mine.

The range of the several elements in these ten mines is also shown below:

Moisture.....	5.26 to 7.09 per cent.
Volatile combustible matter.....	35.61 to 37.58 "
Fixed carbon.....	50.92 to 54.59 "
Ash.....	2.81 to 6.86 "
Sulphur.....	0.516 to 1.94 "

These figures evidently show one of the very best coals of the State, and beyond question the steadiest in composition of any of the large fields. When it is remembered that each analysis represents all of the seam that is sent out by the miner, just as it is found in the mine from which it is taken, so far as this can be provided for by careful and thorough sampling, it will be seen that the average above given actually and accurately represents the lump coal that is sent out from the central and western portions of the Hocking Valley field.

In strength and ability to bear handling, the coal is somewhat unequal; but the product of the entire field ranks high. The coal of Sunday Creek, Shawnee, and Straitsville, when skillfully mined, is scarcely surpassed in strength by the famous Block coal of the Mahoning Valley. While other portions of the field fall below this standard to a certain extent, the coal that they furnish is at least equal in strength to any other Ohio coal.

The coal is everywhere mined by undercutting and blasting. The "bearing in" is done in the bottom bench of the seam, which is the best part of the coal in several respects. The cost of powder ranges between 3 and 4 cents per ton of coal.

The coal is universally prepared for market by screening. The standard that is generally recognized for the screens is 12 by 6 feet, with 1½ inches between bars. The bars are either steel or iron, and are generally ½ inch to ¾ inch wide on the upper surface.

One-third of the coal sent out by the miner passes through a screen of these dimensions. Of this third, somewhat less than half is slack, which has hitherto been mainly lost. The balance is unequally divided between nut and pea coal, when the latter grade is made. If the pea coal is not separated, the slack is increased to this extent. The nut coal is counted about half the value of the lump coal at the mine. The pea coal does little more than pay for handling. Reduced to percentages, the several grades appear as follows:

Lump coal.....	66 per cent.
Nut coal.....	10 to 20 per cent. }
Pea coal.....	5 to 15 per cent. } 33 per cent.
Slack.....	9 to 25 per cent. }

By recently introduced elevators, the Ohio Central Coal Company has brought down the percentage of slack to between 9 and 10 per cent. of what the miner sends out.

The extreme regularity of the coal, the excellent roof that covers it, the

fact that the mines are, in so large a part of the field, level free or hill mines, all these facts reduce the demand for skill in mining to somewhat lower terms than elsewhere. At least, mining can be done here with a smaller amount of training and experience than in many other districts.

Improvement in Electric Safety-Lamps.

The *Mining Journal* points out that in electric safety-lamps as hitherto constructed for use in mines, if the globe enclosing the filament be broken, the filament will generally retain sufficient heat to ignite carburetted hydrogen, and consequently explosion may ensue. It has been proposed to enclose an incandescent lamp within a glass casing or lantern filled with water; but in this arrangement if the glass casing be broken the water will escape, and the lamp then is practically unprotected, and therefore dangerous. It has also been proposed to fill the outside casing with water impregnated with carbonic acid gas under pressure for operating a flexible disc (or equivalent means), to which is attached a contact piece in such a manner that a pressure within the casing will cause contact to be made so as to establish the electric circuit. In this arrangement if the casing be broken the gas and liquid contained therein will escape, the interior pressure will be removed, the circuit will be immediately broken, and the lamp extinguished. In practice, however, it has been found that the breaking of the circuit in the manner described produces a sparking which would ignite explosive gases, so that such lamps have not been practicable.

The improvements proposed by Mr. T. Coad, of Finsbury, England, consist principally in preventing such sparking by constructing the contact pieces of sufficient length, and in placing over such contact pieces a covering of suitable material, such as india rubber or the like, which will closely embrace the parts so as to effectually exclude all dangerous gas from coming into contact with the sparks produced on the breaking of the electric current. And further, in order to prevent the sparking which might be produced by metallic contact, whether accidental or otherwise, he dispenses with the use of terminals by carrying the conducting lines direct from the lamp into the battery, so that when the lamp is fixed thereto the wires will be entirely enclosed and protected. In order to prevent the escape of the carbonic acid gas employed to produce the pressure within the glass casing he employs a flanged disc and a flanged ring. The outer glass casing consists of a flanged dome, the bottom of the flange of the dome resting against the upper face of the disc, and the top of the flange bearing against the under side of the flanged ring. The disc and ring are clamped together by bolts and nuts, so as to allow of securing, by means of suitable packing, a tight joint between the glass and the ring and disc, thereby effectually preventing the escape of the compressed gas.

The battery and its receptacle, the lamp, the flexible disc, and the spring for breaking contact if the lamp be broken, are all of known construction. There are contact pieces to receive a covering of suitable material, such as india rubber or the like, which will closely embrace the contact pieces; the lower contact piece is provided with a lock nut for adjusting its position with regard to the upper contact piece; there are the usual conducting wires, which he carries direct from the lamp into the battery, where they are connected direct to the poles of the battery instead of to the terminals usually fixed thereto; the wires when the lamp is fixed thereto will be thereby entirely enclosed and protected. There is a flanged disc and a flanged ring for fixing the outer glass over the lamp, the glass being filled with water impregnated with carbonic acid gas as heretofore; the outer glass is flanged, the bottom of the flange resting against the upper face of a flanged disc, and the top of the flange bearing against the under side of the flanged ring; there are bolts and nuts for clamping the disc and ring together, and the packing for securing a tight joint between the glass and the ring and disc. In a lamp of this construction, if the interior pressure be removed from the flexible disc by the casing or glass becoming broken, the disc will be forced upward by a spring, which will also carry up the contact piece, and contact will be thereby broken between the two contact pieces; the sparking produced by the breaking of the circuit in this manner will be prevented from igniting the explosive gases, as such gases will be effectually excluded by the covering over the contact pieces. Further, any sparking which might otherwise occur is obviated by dispensing with the use of terminals, and carrying the conducting wires direct to the battery. By employing the flanged disc and ring, and flanged outer glass connected together as described, the escape of the carbonic acid gas employed to produce the pressure within the glass casing is effectually prevented.

The novelties claimed are: 1. In miners' incandescent electric safety-lamps the described method of preventing the effects of sparking in the event of the breakage of the electric circuit by enclosing the contact pieces with a covering of suitable material. 2. The method of preventing sparking in miners' incandescent electric safety-lamps by carrying the conducting wires direct from the lamp into the battery, whereby they will be enclosed and protected; and—3. The described means for producing a tight joint to prevent the escape from the outer glass casing of the compressed gas employed to operate the flexible disc.

Slag Cement.

Engineering has on several occasions directed attention to the ingenious and very successful methods pursued by Mr. Frederick Ransome for the preparation of a cement from blast furnace slag and lime. In its latest "Note" on the subject our contemporary mentions a discovery, made by Mr. Charles Wood some twelve years ago, that slag run from a blast furnace in a molten condition falls into a fine granulated state, which removed one of the main objections to its utilization—the great cost attending its reduction to powder by mechanical means. One of the materials composing the Ransome cement is thus obtained ready for use, and being practically a waste product, its cost is nominal, the expense attending its application being limited to handling. By his earlier method the other material employed—chalk or lime—was ground and mixed with the slag, the combination being then calcined and again ground; from this resulted a cement possessing very high qualities both as regards quickness in setting and strength. Very recently, however, Mr. Ransome, following the same line of investigation, has improved greatly on his former simple process, and he has found that the spent lime from gas works may be employed with results as good as those obtained with lime prepared specially for the purpose. In order, however, to get rid of the sulphur with which the lime is saturated when it leaves the gas purifier, Mr. Ransome resorts to a very simple and efficacious device. He mixes a certain proportion of powdered coal or coke with the slag and lime, and when this is exposed to the heat of the calcining furnace, the action of the coal or coke converts the sulphate into a sulphide of lime, that is subsequently entirely got rid of by the introduction of a jet of steam which drives off the whole of the sulphur impurities as sulphuretted hydrogen, leaving the lime quite pure. This, however, is only one of the recent improvements to which we have referred. A highly important modification is the use of a revolving retort for the calcination of the slag and lime. It is found that after the materials have been thoroughly burnt in this manner, they remain in the same fine state of subdivision as when they were placed in the retort, and on being discharged will pass through a sieve of 80 meshes to the inch. The costly process of grinding, which is unavoidable in the ordinary method of manufacture, is thus avoided, while the cement is said to lose none of its useful characteristics in this novel process. Of course this system is equally applicable where fresh lime is employed, instead of the waste material from gas works, only in such a case it is unnecessary to add the powdered coke, or to apply the steam jet. We have referred in general terms to the strength of the cement produced by this method; the following table of comparative tests made with samples of Portland and Ransome cement show clearly the remarkable qualities possessed by the latter; the samples in each case were 1½ inch square, giving a sectional area of 2¼ square inch.

Age of Sample.	Portland Cement. Breaking Load. lbs.	Ransome Cement. Breaking Load. lbs.
2 days.....	510	740
3 "	698	870
7 "	818	1,170
12 "	1,300
15 "	1,330
21 "	1,440
28 "	936
7 years.....	1,327

The foregoing figures speak for themselves, and indicate clearly that the Ransome cement possesses striking advantages over Portland, especially as it reaches a strength within a few days which is higher than the Portland after seven years. Very important advantages are also found in the simplicity of manufacture, and the suppression of the final process of the cement manufacturer—that of grinding. The plant used is therefore simpler and involves much less expense in maintenance and labor for the production of a given quantity of cement than is required in the ordinary mode of manufacture. When, in addition to this, it is remembered that waste materials are employed, it will be easily understood why the slag cement can be made for half the cost of Portland, and the commercial importance of Mr. Ransome's process will be readily appreciated.

Dividends Paid by San Francisco (Cal.) Gas and Electric Light Companies in 1884.

An occasional correspondent sends us a statement concerning the number and amount of dividends paid by gas and electric light companies of San Francisco during the year ended December 31, 1884. The figures were first published in the *San Francisco Bulletin*, and are interesting, since they go to show how "opposition" plants deplete the pocketbooks of investors. It will also be noted that the California Electric Light Company has proved very far from being the "bonanza" which its "locators" fondly imagined, and loudly declared, they had "struck." The details are as follows:

	Dividends.	Amount.
California Electric Light	6	\$18,000
Central Gas (Sacramento)	4	42,500
Central Gas Light	2	40,000
Gas Consumers' Association	4	5,250
Oakland Gas Light and Heat	12	72,000
San Francisco Gas Light	2	150,000
Total, 1884		\$327,750
Total, 1883		387,000

The California Electric Light Company paid 6 dividends of 6c. per share each in the first six months of the year, since when some heavy expenses have been incurred in the erection of masts for lighting certain portions of the city. The Capital Gas Company paid a quarterly dividend of \$1.25 per share in January, 1884, and three quarterly dividends of \$1 per share in April, July, and October. As the par value of the shares in this company is \$50, the dividends for the last three quarters of the year were at the rate of 8 per cent. per annum. The property of the Central Gas Light Company is leased to a Philadelphia corporation for 20 years. This corporation is understood to guarantee to the stockholders of the Central Company 4 per cent. per annum on the capital. The first quarterly dividend under this arrangement was paid in August, and the second in November. The Gas Consumers' Association is an organization which has a patent for the regulation of the pressure of gas at the meter, whereby the light is made steadier and the consumption greatly lessened. The expense of this attachment is said to be less than one-half of the saving in gas bills. This Association pays its dividends quarterly, the first three having been at the rate of 25c. per share and the last at the rate of 30c. per share. The Oakland Gas Light Company was re-incorporated a few months ago under the name of the Oakland Gas, Light and Heat Company, with the same capital, shares, and officers. The object of the change was to enlarge the sphere of business, so as to take in the manufacture and sale of electric light, power, and heat in connection with gas. The company pays 20c. per share monthly on a capital of \$3,000,000, in 30,000 shares. The San Francisco Gas Light Company paid a dividend of 50c. per share last January, and another of \$1 per share last May. This is 1½ per cent. for the year on the capital. In 1883 the company paid \$280,000 in dividends, or at the rate of 2.80 per cent. on the capital. The past two years have been the most unprofitable in the history of the company. The Central Gas Light Company entered the field in competition three years ago, and the cutting of rates which followed, while it has been of advantage to consumers, has depleted profits, and has had a very depressing effect on the value of shares. The price of shares in the San Francisco Gas Light Company has been reduced from 95 and upward to 48, but now 58. The company used to pay dividends monthly with great regularity, first at 6 per cent. per annum, and afterward at 9 per cent. In January, 1880, these were reduced to 8 per cent.; in March, 1880, they were reduced to 7 per cent.; and in August, 1881, they were suspended, so that the dividends for 1881 were only 4.08 per cent. In 1882 the company paid \$400,000 in four dividends, or at the rate of 4 per cent. For the past two years the dividends have been at the rate of 2.15 per cent. per annum. During a portion of this time the price of gas was \$1.50; last October the price was raised to \$2.25, both companies agreeing to that basis. An attempt was made to have this rate ratified by the Supervisors, but the Mayor vetoed the bill. Still, the company is collecting its bills on that basis.

ITEMS OF INTEREST FROM VARIOUS LOCALITIES.

THE ELECTRIC LIGHTING OF HELL GATE CHANNEL.—The electric promoters seem to believe that the tower lights placed over that seething cauldron so aptly named Hell Gate are thoroughly competent to fill the task allotted by their erectors—the ample illumination of that dangerous channel connecting Long Island Sound with New York harbor proper. At least we must judge that such is the idea and belief of their designers, and the entire set of electrical followers as well; for on every available opportunity are the praises of Hell Gate's lights sung to the usual "meter;" and it may safely be asserted that the "meter" lacks not a plentiful sprinkling of staccato "signs." If these praises were but solely directed to the beauty of the spectacle presented by the "arcs" on clear nights, why, all of them would be true; but the trouble is, not only is beauty alone claimed for them—effectiveness and complete adaptability are also vouched for as having been attained. *Engineering* in a recent issue rather unwittingly proves why these latter "claims" should have no foundation, and does it thus: "The approach to New York harbor from Long Island Sound on the northeast, called Hell Gate, is through a narrow, tortuous channel, through which navigation is rendered difficult by reason of the rapid currents which vary with the tide. This channel has been illuminated by a group of nine 6,000-candle power Brush electric lights, which are placed at an elevation of 250 feet, and are visible at a distance of 40 miles." All of this is true enough in the main;

but we fail to perceive what striking advantage is to accrue to the mariner who desires to tread the devious ways of that small but celebrated strait. It may comfort him somewhat (although we doubt it) to have positive knowledge that when a certain point in his voyage is reached he is just 40 miles away from the perilous spot; but it does seem as though he would not need the assistance of the "arcs" to tell him so. What he might desire would probably be the assurance when the maelstrom was entered, the "arcs" were capable of shining on his pathway, and thus alleviate the dangers of the pass. No matter what the electrical promoters assert in regard to the effectiveness of the Hell Gate lighting, it is to the testimony of those for whose ostensible benefit the expense was incurred that the greatest weight should be attached. The Sound navigators are constantly complaining of the lighting system, and on a recent occasion one of the best pilots in the Sound service (Captain J. F. Peck, of the steamboat *Northam*), while describing a rather dangerous trip that he had successfully accomplished, freed his mind, concerning the Brush lights, in the following pungent style: "During thick weather we are obliged to feel our way carefully down the harbor * * * * Let me say, just here, as to lights, that the new-fangled electric light at the 'Gate' is worse than useless to our Sound navigators. One can see the light; but it is so dazzling that nothing else can be seen. It makes the darkness visible around it, and obscures whatever that darkness may contain." While we are obliged to confess that Capt. Peck's language may not be as limpid as some might desire, it is nevertheless clear enough to bring conviction to most minds that he does not look upon the Hell Gate towers as conducing very greatly towards the safety of the Sound pilot.

PERSONAL.—Mr. R. D. Wirt, who for the past three years has succeeded most thoroughly in managing the duties connected with the position of Superintendent of the Independence (Mo.) Gas Light and Coke Company, has taken upon his shoulders the additional load of caring for the Independence water works in a managerial capacity.

SUFFOCATED BY GAS.—A man named T. C. Schuren, a temporary guest at the Commercial House, Youngstown, Ohio, was suffocated through the inhalation of illuminating gas which escaped into an apartment of the above-named hotel, on the evening of January 27th. Deceased, prior to retiring, was somewhat unsteady from the effect of a too free indulgence in liquor. It is supposed that it was a case of turning the gas off and then on again. His home was at Cleveland, Ohio, and he was pretty well off as to this world's goods.

FOR SALE AT HALF PRICE.—The stockholders of the Electric Lighting Company, at Dubuque, Iowa, having been on the "ragged edge" of financial weakness for many a weary month, at last decided to wind up the concern, and so have gone into a voluntary liquidation. This brave band of enthusiasts started in to make grass grow thick and fast around the coal sheds, etc., of the Dubuque Gas Works; but, as we all know, "the best laid plans of mice and men gang aft a-glee," hence this short obituary mention regarding the blighted hopes and sad prospects of the Dubuque electrical promoters. Matters having gone on from bad to worse with them, it was determined at the last annual meeting to discontinue the business and offer the plant for sale at "half price." The reports show that the company had been losing money at the rate of at least \$1,500 per annum. Gone and forgotten.

GREAT DECREASE IN THE ENGLISH COAL MINING DEATH RATE.—The official figures showing total number of deaths (during 1884) resulting from explosions in English coal mines are very favorable when compared with those of previous years. In fact the tables prove that the past year has been freer from these occurrences than any of its predecessors making up the last fifth of a century. The yearly tables dating back from 1865 are as follows:

Year.	No. lives lost.	Year.	No. lives lost.
1865.....	168	1875.....	288
1866.....	651	1876.....	95
1867.....	286	1877.....	345
1868.....	154	1878.....	586
1869.....	257	1879.....	184
1870.....	185	1880.....	499
1871.....	269	1881.....	116
1872.....	154	1882.....	250
1873.....	100	1883.....	134
1874.....	166	1884.....	52

This speaks well for the management of English colliery operations during the twelvemonth, and bids us hope that the time is not far distant when the occupation of the coal miner will be removed from the list embracing the names of those considered extra hazardous.

BORING FOR NATURAL GAS AT IRONTON, OHIO.—The proprietors of the Belfort Iron Works Company, of Ironton, Ohio, have for some time past

been impressed with the idea that it would be worth while to make an attempt to bore for natural gas wherewith to secure cheap fuel for their furnaces. They started the drills agoing in January, and when the bore-hole had penetrated to a depth of 100 feet it encountered a weak vein. The gas flow, when ignited at well mouth, had only sufficient pressure to sustain a flame of about nine feet in height, and this volume being entirely insufficient for the needs of the works, boring was once more proceeded with. On February 1st the drills were down to a depth of 500 feet, with no new developments. The Belfort iron works are located quite close to the plant of the Ironton Gas Company, and as a consequence the gas folks are viewing the boring progress with a very pardonable feeling of curiosity.

ITS TRUE FUNCTION.—One of our exchanges says that Dr. W. B. Richardson has been carefully studying the subject of how best to produce painless death among the lower animals. As a result of his inquiries the Doctor claims to have succeeded in securing ethanasia for them, which he proposes to effect in the following manner. The animals to be destroyed are placed in a chamber into which is forced a current of carbonic oxide, passing, at 80° Fah., over a mixture of chloroform and carbon bisulphide. Extinction of life is soon effected in the chamber by the lethal nature of its atmosphere so brought about. The attention of city and town authorities, within whose limits water gas concerns are operated, should be called to Dr. Richardson's proposition.

ONE WAY FOR SMALL GAS COMPANIES TO AVOID TROUBLE.—The following practice pursued by Mr. J. C. Pratt, President of the Jamaica Plain (Mass.) Gas Light Company, is not put forth as containing anything novel, nor does it follow that the very largest company in the country could not fail of finding sufficient profit in carrying out a similar policy, because we offer it to the consideration of managers of the less extensive works. Indeed it is a trifle humiliating to be obliged to refer to the thing at all, for the system is so plain and matter-of-fact that one would naturally suppose every company had instituted and carried it out long ago, and had done so merely as a matter of absolute necessity. Speaking of large companies, before going any further at this point into the practice of President Pratt, we cannot forbear mentioning a circumstance that happened in New York city shortly after the Consolidated Gas Company became a fixed fact. In one of the up-town districts a decision was arrived at that a certain section of the territory formerly supplied by one plant should be supplied from the mains of another—the change being made in order that distribution might thereby be facilitated. In short, it was a change from coal to water gas—the water gas plant, owing to its location, being much better calculated to furnish the supply in the particular section. The consumers were not previously notified of the arrangement, and the burners that had been doing duty in regulating the consumption of the coal gas were left undisturbed, and the water gas was passed through them. The consequences may easily be imagined; the storekeepers and householders complained that the gas was so bad as to be really worse than useless. There was no light, but there was plenty of smoke, etc. Of course, in a week or two all this was remedied through a substitution of proper burners; but it would have been much more to the credit of the business tact of those in charge of that particular branch of the Consolidated Company if the consumers had been told what they should have been informed of before the one sort of gas was cut off and the other turned on.

Mr. Pratt has simply gone to the slight trouble of getting up a small notized circular, printed on plain white paper, a copy of which he has had mailed to each one of his company's consumers. He commences by cautioning people against purchasing burners from irresponsible parties—peddlers, and others of that stripe. This he does because he has learned that "traveling agents" are abroad who have been visiting the householders and offering these latter inducements to purchase a superior gas saving burner, placing the consumption of same at 3 feet per hour, etc. The "agents" succeeded in getting many of the Jamaica Plain people to invest in the article, and some of the "samples" tested by Mr. Pratt have been shown to consume 6 feet per hour. Of course, the agent does not experience much trouble in making a sale after "plainly showing what a great advantage is obtainable." With his handy pliers he takes off a 3-foot burner from a fixture, and calmly replaces it with one burning double that quantity, and then inveighs against the "rascality of the gas man." Seeing is believing, but reading is the printed truth. The consumer sees and believes, buys a dozen or two burners and pays for them. Off goes the agent; at the end of the month comes the gas bill. Perhaps reading is convincing then; convincing of what? That the agent was a fraud? Oh, no! That the gas company's meter is a liar? Oh, yes! This is the state of affairs that Mr. Pratt's practice prevents. He warns the consumer against such traps for the unwary, and then informs him that he may purchase at the office of the gas company, at cost, the best, most reliable, and economic burners that are manufactured. The Jamaica Plain Company makes no charge for attaching the burners, and gives a guarantee that each burner sold will not burn more than its rated

consumption. Every medium and small sized company suffers from the incursions of the "traveling agent," and when that worthy is "carrying a select line of excellent gas burners in stock," it is well worth the while of the "gas man" of the town to make the "agent's sales" as light as possible through having instructed the gas consumer that the proper place for him to obtain a good and reliable gas burner is at the office of the gas company.

CHEAPER GAS FOR NEW ROCHELLE, N. Y.—Mr. C. C. Van Benschoten, a gentleman who has been quietly working along for many years in directing the affairs of the New Rochelle (N. Y.) Gas Light Company, has never made much noise amongst the fraternity of the Empire State, but he has been and is a careful observer of events as they transpire in the history of our common calling. New Rochelle is a small place, and presumably outside the designs of the wreckers, as the daily consumption of gas there is under 10,000 cubic feet; so that "the man in charge of the helm" at that point need have but slight fear that the aforementioned gentry would strive to "make port" in his locality. In these matters, though, there are other things to be considered besides the warding off of opposition; and of these other things increased output—not to mention a desire or wish to benefit one's fellow-townsmen—should furnish sufficient incentive to a lowering of selling rates. If Mr. Van Benschoten can see his way clear to the course below mentioned, we are certain that not a shadow of excuse is left for any other manager in the State of New York for charging a higher rate. We are glad to give place to Mr. Van B.'s letter, and hope that a perusal of it will set some of the managers of small works to thinking. The rate before reduction was \$3.50 per thousand.

"NEW ROCHELLE, N. Y., Jan. 30, 1885.

"To the Editor JOURNAL:—The increased consumption of illuminating gas manufactured by us during the year just closed has given us encouragement; and as an incentive to a still greater increase in our business we have decided to reduce the price of gas on and after Feb. 1, 1885, to \$2.50 per thousand cubic feet to all consumers who settle their bills by the 10th of each month; 10 per cent. additional will be charged on all bills remaining unpaid after that date. In relation to this reduction we are glad to state that it is voluntary on our part, and not because of threatened opposition of any kind; our motive is to deal squarely with our patrons. The village grant under which we are working gives us the privilege of charging \$3.50 net per thousand until we reach the daily output of 50,000 cubic feet. We have reached a consumption of only about one-fifth of that amount, and now propose to sell gas of equal illuminating power at \$2.50; and we are further pleased to be enabled to state that we know of no other gas works of the same capacity selling illuminating gas at a lower figure."

It seems unnecessary to add that Mr. Van Benschoten is a firm believer in coal gas.

BROKEN PANES.—It is said that about \$5,000 worth of street gas lantern panes were broken by the stone-throwing and bean-shooting urchin of Philadelphia, Pa., during 1884. Pretty "paneful" expense, that.

A PUZZLED SALOONKEEPER.—A saloonkeeper at Detroit, Mich., has had some experience with electricity, which he describes as "shocking." He stands his liquor glasses upon a copper tray, underneath which run a gas pipe and an electric lighting wire. The insulation of the latter became defective, and contact with the tray was made. Our German host "reached" for a glass (tray and glasses were generally in a dripping state) while things were in "contact;" hence the shock. The wire is carefully looked after now.

PROPOSING TO MAKE ANOTHER REDUCTION.—The way matters are now shaping, it looks as though the Gas Trust at Philadelphia, Pa., see their road clear toward bringing the price of gas down to \$1.50 per thousand from date of April 1, 1885.

SOME THOUGHT IT WAS DYNAMITE.—At about 9 A.M. on the morning of Feb. 4 the residents of the city of Galena, Ill., were startled out of their wonted quiet by the echoes of a violent explosion. The source of the uproar was speedily traced to a cistern sunk in Bench street, at a point directly in front of the First Presbyterian Church. It appears that the cistern had been dry for some time back, and the iron top serving as a cover had been frozen fast in the receiving socket. On the morning in question the fire department laborers had orders to fill the cistern with water, and the cover was accordingly pried open. One of the men engaged on the job thought he smelled gas; and his nose not having a sufficiently keen scent, he brought the inevitable match into play. He was right—"there was gas around;" and the lighted match found it at the "first try." The match igniter recovered his senses in about half an hour; but his fellow-workmen decided that the cistern would not "hold water" for quite a while. A main belonging to the Galena Gas Company had started a joint close to the cistern wall; the gas found its way into the convenient receptacle afforded; the frost kept the cover sealed tightly; and the workman and his match are responsible for

causing the English residents of Galena to think that dynamiters were "up and doing."

METER-MAKING HANDS ON STRIKE.—On January 29th last some of the hands employed in the Goodwin Gas Stove and Meter Company's factory, at Philadelphia., Pa., undertook to tell Mr. Goodwin that he was not sufficiently well versed in running his own establishment; at least one would infer that from the action taken. Mr. Goodwin has always enjoyed (and very justly so) the reputation of being liberal with his workmen, and he kept paying top rates for labor long after the time was reached when justice to himself demanded that a reduction should be made. On the date above mentioned the Goodwin Company gave notice that certain piece-work hands would be required to submit to an average decrease of 12½ per cent. in their pay. This they refused to accede to, and the whole posse of them left work in a body—those to whom the decreased rate applied along with those not affected at all making common cause of the affair, presumably at the dictation of a body calling themselves "Knights of Labor." Mr. Goodwin has since refused to treat with representatives from that body who are trying to make a settlement of the strike, and will maintain his position. According to our information, 40 hands left the shop without the slightest sign of warning to their employers; and of this number 23 had no earthly excuse for their cowardly and miserable course. If the "Knights" think they can coerce Brother Goodwin they make a mistake in their estimate of him.

THEIR PLEDGES WERE KEPT.—When Mr. Higgins and his associates were engaged in showing the city authorities at Richmond, Va., that the time had arrived when the gas plant should be put in proper condition, so that the consumers might obtain the needed supply at a reduced expense, they were obliged to pledge themselves, if the sought-for improvements were effected, that under the new condition of things the cost of gas in the holder should not be over 60 cents per thousand cubic feet. To show that this pledge was kept and practically carried out, we submit the following tabulated statement:

Statement Showing Net Profit of Richmond (Va.) City Gas Works for Year Ending Dec. 31, 1884.

Cash receipts for gas sold.....	\$190,250 25	
" " coke sold.....	18,295 21	
" " meter connections.....	1,580 24	
Delinquent bills.....	958 40	
28,772,103 cubic feet gas sold city, at \$1 per M.....	28,772 10	
19,987½ bushels coke to City Missions, at 6 cents.....	1,199 25	
Inventory, Dec. 31, 1884.....	21,111 04	
		\$262,166 49
Less Payroll.....	\$60,800 00	
Coal.....	50,897 97	
Expenses.....	8,118 67	
Extensions.....	8,519 71	
Inventory, Jan. 1, 1884.....	23,354 48	
		151,690 83
Net profit.....		\$110,475 66

Cost of gas per 1,000 cubic feet in holder, 58.06 cents; number of consumers, January, 1885, 3,822; cash receipts, January, 1885, \$26,551.04. Number consumers, January, 1884, 3,754; cash receipts, January, 1884, \$24,272.95. Verily, the city authorities, and the people as well, will have to concede that Mr. Higgins knew what he was talking about.

A NOVEL POINT ON WHICH AN APPLICATION FOR AN INJUNCTION IS BASED.—A decidedly novel point has been advanced by an applicant before a Pennsylvania court as a reason why an injunction should issue. On Thursday, Feb. 5th, a man named Moritz Wolff, residing on Fifth street, McKeesport, Pa., made application for an injunction restraining the National Tube Works Company from laying a pipe, under the roadway in front of his dwelling, destined to act as a conduit for natural gas. His affidavit asserted that the line was being laid from Murraysville to McKeesport; and was for the sole use of defendant. As the main was being laid in midwinter, the period most favorable for the contraction of iron pipe, plaintiff claimed that summer heat would inevitably cause expansion, and consequent opening of the joints. Defendants deny the allegation as to such danger. They claim the line to be a model one, put down in accordance with every precaution, and fitted with the best known joints. Defendant admits that straight lines of pipe would possibly be open to danger, but claims that as the line in question includes a number of bends, these curves take up and provide at one and the same time for expansion and contraction. Judge Ewing hesitated about stopping the work, but appeared to attach due weight to plaintiff's claim, as was perfectly natural for him to do, remembering the number and violence of the natural gas explosions that have agitated Pittsburg and its vicinity on recent dates.

Another case similar to the above, and against the same defendants, was to be brought before the attention of the court on the following day (6th), and as neither plaintiff nor defendant in Wolff's case had presented sufficient affidavits, Judge Ewing continued the argument over until Saturday (7th), with the understanding, though, that pipe laying would be suspended during intervening period. We have received no later advices than those of morning of 6th, and would ask that our friends at Pittsburg be kind enough to post us as to the decision arrived at.

BROOKLYN (N. Y.) STREET LIGHTING.—The "reform" board of aldermen in the city of Brooklyn are repeating their tactics of former years in regard to delaying the awarding of contracts for lighting the city's streets in 1885. The whole business looks as though somebody was waiting for a "dividend." It appears, also, that an item was inserted in the yearly tax levy appropriating \$15,000 to be expended in maintaining electric lights; and the two electric companies propose to divide that amount between them, they agreeing to furnish lights at the price of \$255 each per annum. The "reform" member of the board, rejoicing in the name of McCarty, gives it as his opinion that one-half of the total amount (\$340,000) appropriated for the street lighting of 1885 should be expended on "arc" lamps. The proposition is so extremely verdant (unless Mr. McCarty is largely interested in electric lighting stock) that grass would appear very much blanched when placed in comparison with it. Brooklyn city, owing to its peculiar manner of growth, being spread over an immense area, and the fact that it is essentially a place of residence (it is perfectly safe to assume that nine-tenths of the population are in their beds by 11 P.M.), offers but little encouragement to electric lighting speculators. At the stated price of \$255 per lamp, it would certainly mean an expenditure of over one-half million of dollars to properly light one-half the city with the "arcs"—although, were one to take the estimated displacement vouched for by the Brooklyn electricians (one arc is set down as taking the place of 12 gas lamps), the cost would be much less. If the displacement figure given were divided by three, the result would be about right. Perhaps Mr. McCarty only suggested the substitution of electricity for gas, on such a wholesale basis, in a jocular way; or perhaps he threw the hint out as a sort of reminder that the gas men ought to "come to terms" with a little greater alacrity than they are at present displaying. By way of conclusion, it may be here added that Brooklyn has long enjoyed the reputation of being (as to its streets) one of the best lighted cities in the United States.

RECENT PATENTS.

The following list of patents relating to improvements in gas apparatus, etc., granted by the United States Patent Office since January 1, 1885, is specially reported for the JOURNAL by FRANKLIN H. HOUGH, Solicitor of American and Foreign Patents, 925 F Street, N. W., Washington, D. C.

ISSUE OF JAN. 6, 1885.

310,487. Gas, apparatus for the manufacture of. A. L. Allen, Poughkeepsie, N. Y.

310,240. Gas regulator. T. Angell, Brooklyn, N. Y.

ISSUE OF JAN. 13, 1885.

310,616. Gas and other machines, cooling attachment for. J. Ring, St. Louis, Mo.

310,841. Gas conducting mains, preventing leakage from. M. Moeser, Allegheny, Pa.

310,745. Gas furnace. W. Swindell, Allegheny, Pa.

310,580. Gas governor, automatic. M. O. Gorman, Jersey City, N. J.

310,744. Gas retort. A. C. Swain, Chico, Cal.

310,605. Gas valve, automatic. I. B. Millner, Bay City, Mich.

ISSUE OF JAN. 20, 1885.

311,131. Gas and electric light fixture combined. P. H. Klein, N. Y. City.

310,945. Gas burner. W. M. Jackson, Providence, R. I.

311,161. Gas generator. F. Clauss, Elizabeth, N. J.

311,124. Gas, process of and apparatus for manufacturing. J. Hanlon, New York, N. Y.

ISSUE OF JAN. 27, 1885.

311,403. Gas, furnace for generating illuminating. S. I. Anthony, New York, N. Y.

311,441. Gas generator. L. Mond, Winnington Hall, County of Chester, England.

311,214. Gas motor. G. M. Ward, Newark, N. J.

ISSUE OF FEB. 3, 1885.

311,483. Gas, apparatus for manufacturing. A. O. Granger and J. H. Collins, Philadelphia, Pa.

311,484. Gas generating apparatus. A. O. Granger, Philadelphia, Pa.

311,493. Gas generating apparatus. I. James, Mattoon, Ill.

311,840. Gas lighting apparatus. F. Lane, Boston, Mass.

311,858. Gas Machine. W. C. Strong, Redfield, Me.

311,585. Gas works, hydraulic main for. C. W. Isbell, New York, N. Y.



A. M. CALLENDER & CO.,
PROPRIETORS.

Editor—JOS. R. THOMAS, C.E
Manager—C. E. SANDERSON.

PUBLISHED ON THE 2ND AND 16TH OF EACH MONTH
At No. 42 Pine Street, New York.

TERMS

SUBSCRIPTION—Three Dollars per annum, in advance.

MONDAY, FEBRUARY 16, 1885.

The Market for Gas Securities.

The city gas share market during the fortnight has been dull and steady, although Equitable exhibited considerable strength toward the close. Consolidated seems inclined to go lower, and why it should follow the downward course is rather enigmatical to those on the inside. Transactions have taken place at a fraction below 80, and the croakers are predicting 75 as a figure sure to be seen in future quotations. This view we do not incline to, and still adhere to the opinion that Consolidated is a purchase. Equitable moved up rather sharply, and is strongly held at asking price of 97. The "gas reformers" are still wagging their tongues and shaking their heads over the enormities practiced by the gas makers of New York city, and the records of their meetings present a most amusing collection of absurdities. The initial session developed that progressive amateur, Bottsford, and one of the later seances resuscitated the venerable figure of Mr. James Crutchett, C.E., who expatiated upon the merits and economies of "Steam Carbon Gas." The patriarchal enthusiast informed the "reformers" that "good illuminating gas could be sold at a profit at the charge of 30 cents per thousand cubic feet; and heating gas, at 15 cents per thousand, had millions in it." That is the sort of "pap" which is being supplied to Messrs. Sherwood, *et al.*

Brooklyn stocks are dull and steady; the only changes worth noting have taken place in Brooklyn and Williamsburgh Companies' stocks—the former is higher by two points, the latter showing a decline similar to advance in former. On Feb. 9th the Supreme Court of Missouri affirmed the judgment rendered by Court of Appeals on a former occasion in case of St. Louis Gas Light Company against city of St. Louis. The decision awards the gas company judgment for \$957,346 for gas furnished city from 1865 to 1873. This sum includes interest on deferred payments. Peoples, of Jersey City, has fallen about 20 points.

Gas Stocks.

Quotations by Geo. W. Close, Broker and Dealer in Gas Stocks (with A. E. SCOTT & Co.)

72 BROADWAY, NEW YORK CITY.

FEB. 16.

All communications will receive particular attention.

The following quotations are based on the par value of \$100 per share.

	Capital.	Par.	Bid	Asked
Central.....	\$440,000	50	60	—
" Scrip.....	220,000	—	47	57
Equitable.....	2,000,000	100	95	97
" Bonds.....	1,000,000	—	102½	103½
Harlem.....	2,000,000	50	110	113
" Bonds.....	170,000	—	—	—
Manhattan.....	4,000,000	50	240	250

Metropolitan.....	2,500,000	100	210	220
" Bonds.....	658,000	—	110	112
Mutual.....	3,500,000	100	120	122
" Bonds.....	1,500,000	1000	104	106
Municipal.....	3,000,000	100	190	200
" Bonds.....	750,000	—	107	110
New York.....	4,000,000	100	145	150
Northern.....	125,000	50	—	80
" Scrip.....	108,000	—	—	—
Gas Co's of Brooklyn.				
Brooklyn.....	2,000,000	25	129	131
Citizens.....	1,200,000	20	84	86
" S. F. Bonds....	320,000	1000	106	110
Fulton Municipal.....	3,000,000	100	148	150
" Bonds.....	300,000	—	104	108
Peoples.....	1,000,000	10	77	80
" Bonds.....	290,000	—	105	110
" ".....	250,000	—	90	95
Metropolitan.....	1,000,000	100	96	—
Nassau.....	1,000,000	25	119	—
" Cdfs.....	700,000	1000	92	94
Williamsburgh.....	1,000,000	50	132	135
" Bonds.....	1,000,000	—	106	108
Richmond Co., S. I.	300,000	50	64	75
" Bonds.....	40,000	—	—	—
Out of Town Gas Companies.				
Buffalo Mutual, N. Y.	750,000	100	80	85
" Bonds.....	200,000	1000	95	100
Citizens, Newark.....	918,000	50	103	115
" " Bonds.....	124,000	—	105	110
Chicago Gas Co., Ills....	5,000,000	25	125	—
Peoples G. L. & C. Co., Chicago, Ills.....			8	12
Cincinnati G. & C. Co..			180	182
Consolidated, Balt.....	6,000,000		81½	82
" Bonds.....	3,600,000		110	111½
Central, S. F., Cal.....			—	58
Capital, Sacramento, Cal.			56	—
Hartford, Conn.....	750,000	25	123	129
Jersey City.....	750,000	20	124	128
Laclede, St. Louis, Mo.	1,600,000	100	88	—
Louisville, Ky.....	1,500,000	50	95	100
Montreal, Canada.....	2,000,000	100	181	182½
New Haven, Conn.....			25	166
Oakland, Cal.....			29	30
Peoples, Jersey City... ..			—	45
" " Bonds.....			—	—
Paterson, N. J.....			25	90
Rochester, N. Y.....			50	75
Washington, D. C.....	2,000,000	20	190	195
Wilmington, Del.....			50	188
Yonkers.....			5	90
St. Louis, Missouri.....	600,000	50	—	—
San Francisco Gas Co.				
San Francisco, Cal....			59½	60

Advertisers Index.

	Page
GAS ENGINEERS.	
Jos. R. Thomas, New York City.....	106
Wm. Henry White, New York City.....	100
GAS WORKS APPARATUS AND CONSTRUCTION.	
James R. Floyd, New York City.....	107
T. F. Rowland, Greenpoint, L. I.....	107
Delly & Fowler, Phila., Pa.....	107
Kerr Murray Mfg. Co., Fort Wayne, Ind.....	107
Stacey Mfg. Co., Cincinnati, Ohio.....	107
Bartlett, Hayward & Co., Baltimore, Md.....	107
Morris, Tasker & Co., Limited, Phila., Pa.....	106
Davis & Fernum Mfg. Co., Waltham, Mass.....	74
Tanner & DeLaney Engine Co., Richmond, Va.....	100
R. D. Wood & Co., Phila., Pa.....	100
GAS AND WATER PIPES.	
A. H. McNeal, Burlington, N. J.....	106
Gloucester Iron Works, Phila., Pa.....	106
Warren Foundry and Machine Co., Phillipsburgh, N. J.....	106
Mellert Foundry and Machine Co., Reading, Pa.....	106
Cincinnati and Newport Iron and Pipe Co., Newport, Ky.....	106
SCRUBBERS AND CONDENSERS.	
G. Shepard Page, New York City.....	105
REGENERATOR FURNACES.	
Charles F. Dieterich, Baltimore, Md.....	46

RETORTS AND FIRE BRICK.

J. H. Gautier & Co., Jersey City, N. J.....	104
B. Kreischer & Sons, New York City.....	104
Adam Weber, New York City.....	104
Laclede Fire Brick Works, St. Louis, Mo.....	104
Brooklyn Retort and Fire Brick Works, Brooklyn, N. Y.....	104
Borgner & O'Brien, Phila., Pa.....	104
William Gardner & Son, Pittsburgh, Pa.....	104
Henry Maurer, New York City.....	104
Chicago Retort and Fire Brick Works, Chicago, Ills.....	104
Baltimore Retort and Fire Brick Co., Baltimore, Md.....	104
Standard Gas Retort and Fire Brick Co., Ironton, Ohio.....	104
Oakhill Gas Retort and Fire Brick Co., St. Louis, Mo.....	104
Cincinnati Gas Retort & Fire Brick Co., Cincinnati, O.....	104

GAS STOVES.

American Meter Co., New York and Philadelphia.....	19
The Goodwin Gas Stove and Meter Co., Philadelphia, Pa.	84

VALVES.

Ludlow Valve Manufacturing Co., Troy, N. Y.....	106
McNab & Harlin Mfg Co., New York City.....	102
John McLean, New York City.....	100

GAS METERS.

Harris, Griffin & Co., Phila., Pa.....	110
American Meter Co., New York and Philadelphia.....	111
The Goodwin Gas Stove and Meter Co., Phila. Pa.....	111
Helme & McIlhenny, Phila., Pa.....	111
Maryland Meter and Mfg. Co., Baltimore, Md.....	110
D. McDonald & Co. Albany, N. Y.....	111
Nathaniel Tufts, Boston, Mass.....	110

EXHAUSTERS.

P. H. & F. M. Roots, Connersville, Ind.....	101
Smith & Sayre Manufacturing Co., New York City.....	108
Wilbraham Bros., Philadelphia, Pa.....	108

GAS COALS.

Penn Gas Coal Co., Phila., Pa.....	109
Perkins & Co., New York City.....	108
Newburgh Orrel Coal Co., Baltimore Md.....	109
Despard Coal Co., Baltimore, Md.....	109
Chesapeake and Ohio R.R. Coal Agency, N. Y. City.....	109
Westmoreland Coal Company, Phila., Pa.....	109

GAS ENGINES.

Schleicher, Schumm & Co., Phila., Pa.....	112
Continental Gas Engine Co. New York City.....	102

GAS LAMPS.

Siemens Regenerative Gas Lamp Co., Philadelphia, Pa.....	105
G. Shepard Page, New York City.....	109

GAS KILNS AND OVENS.

Thompson Gas Kiln and Oven Co., New York City.....	100
--	-----

PURIFIER SCREENS.

John Catot, Lawrence, Mass.....	102
---------------------------------	-----

STREET LAMPS.

J. G. Miner, Morrisania, New York City.....	101
Bartlett Street Lamp Mfg Co., New York City.....	101

BURNERS.

G. Gefroter, Phila., Pa.....	106
Walter Anderson, New York City.....	108

PURIFYING MATERIAL.

Connelly & Co., New York City.....	101
------------------------------------	-----

STEAM BLOWER FOR BURNING BREASE.

H. E. Parson, New York City.....	74
----------------------------------	----

PIPE COVERINGS.

Chalmers-Spence Company, N. Y. City.....	100
--	-----

GAS FIXTURES.

Mitchell, Vance & Co., New York City.....	101
---	-----

STEAM ENGINES.

Westinghouse Machine Co., Pittsburgh, Pa.....	109
---	-----

STEAM PUMPS.

A. S. Cameron Steam Pump Works, N. Y. City.....	101
---	-----

PIPE CUTTING MACHINE.

Pancoast & Maule, Philadelphia, Pa.....	101
---	-----

HYDRAULIC ELEVATOR.

Lane & Bodley Company, Cincinnati, Ohio.....	101
--	-----

SHAFTING, PULLEYS, ETC.

A. & F. Brown, New York City.....	102
-----------------------------------	-----

HYDRAULIC MAIN.

A. E. Boardman, Macon, Ga.....	100
--------------------------------	-----

BOOKS.

The Chemist's Assistant.....	100
King's Treatise.....	102
Scientific Books.....	110
Fodell's Book-Keeping.....	101
Management of Small Gas Works.....	102
Newbigging's Gas Manager's Handbook.....	101

SITUATION WANTED,

As Superintendent of a Gas Works.

Fifteen years' experience. Best of references. Address 616-14 "B. F.," care this Journal.

For Sale at a Bargain.

COMPLETE 4-INCH GAS GENERATING APPARATUS,

From our old works. Iron Frame for Roof; Mouthpieces, Stand Pipes, etc., etc.

Just the thing for adding to capacity of works already in operation, or for starting a new works. Address

616-8t GAS COMPANY, LIMA, OHIO.

A Good Paying Investment.

AN INTEREST IN A GAS WORKS

Located in a village near New York City containing 10,000 inhabitants. Has exclusive right of lighting for twenty years. Any desired information will be given responsible parties by addressing "C. E. T.," care this Journal.

FOR SALE,

100 MINER GLOBE STREET LAMPS.

The lamps have been in use, but only those that are in good order are offered for sale. For terms, etc., address

THE NEW YORK & NEW JERSEY GLOBE GAS LIGHT CO., 615-1f No. 1 Park Place, New York City.

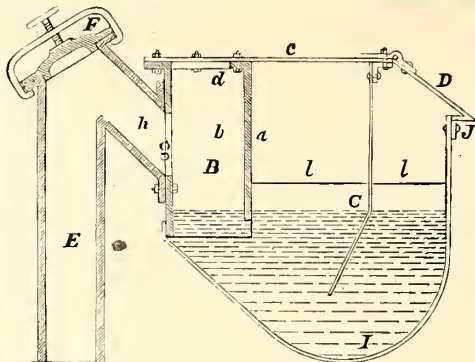

Boardman Hydraulic Main,

Patented October 7, 1884.

For description, see AM. GAS LIGHT JOURNAL of Feb. 2, 1884. For terms, apply to

A. E. BOARDMAN, Macon, Ga.

WM. FARMER, ENGINEER,
32 Park Place, Room 36, New York.

THE CHEMIST'S ASSISTANT; OR, KINDERGARTEN SYSTEM OF CHEMISTRY.

A system by which the elements and their valences are represented by illustrations and solid bodies. BOX AND PAMPHLET COMPLETE, \$2.50.

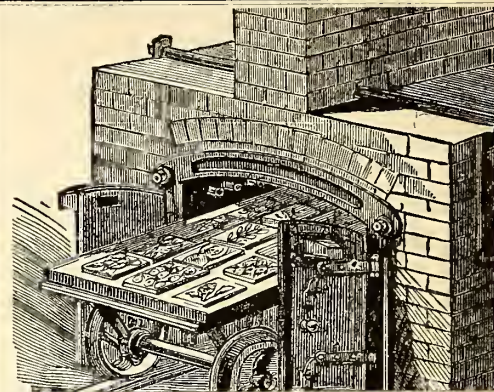

Glass-Staining Gas Kiln.
BAKERS' & CONFECTIONERS' OVENS (PAT.)

Thompson Gas Kiln & Oven Co.

59 Carmine St., N. Y.
Send for Circular by mail.

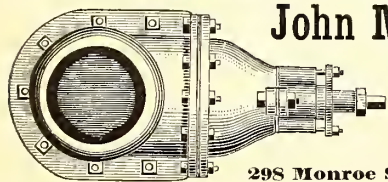

John McLean

Manufacturer of
GAS VALVES.

298 Monroe Street, N. Y.

Pipe Coverings.

Fireproof, Non-Conducting Coverings for

STEAM PIPES, BOILERS,
And all Hot Surfaces.

Made in sections three feet long. Easy to apply; light and cheap. Asbestos Materials, Fibre, Braided Packing, and Cement. These goods are used at Continental Works, Br'klyn.

CHALMERS-SPENCE COMPANY, 419 & 421 EIGHTH ST., N. Y.

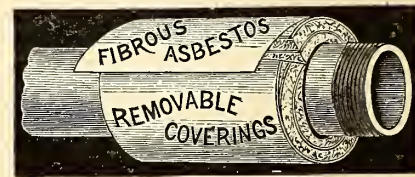

WM. HENRY WHITE,

Consulting & Constructing

Gas Engineer & Contractor.

ESTIMATES, PLANS, AND SPECIFICATIONS FURNISHED FOR NEW WORKS OR EXTENSIONS OF EXISTING WORKS.

32 Pine St., New York City.

Correspondence solicited.

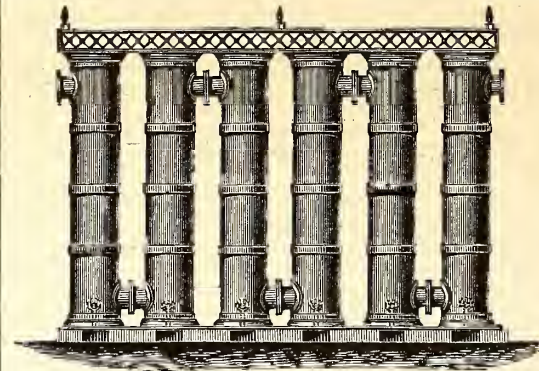

W. E. Tanner, Pres., W. R. Trigg, V.-Pres., A. Delaney, Supt.

Tanner & Delaney Engine Co.

RICHMOND, VA.

Gas Apparatus,

INCLUDING

Condensers of various styles, Scrubbers, Holders, Purifiers, Castings for Retort Houses, Etc.

ALSO STEAM ENGINES AND BOILERS. Plans, Specifications and Estimates Furnished.

R. D. WOOD & CO.,

400 Chestnut Street, Phila., Pa.

Cast Iron Gas & Water Pipe, Water Machinery & Gas Apparatus

Cast Iron Pipe, Fire Hydrants, Eddy Valves, Lamp Posts, Large Loam Castings, Flanged Pipe, Sugar House Work, Iron Roofs and Floors, Wrought & Cast Iron Tanks, Turbine Water Wheels and Pumps.

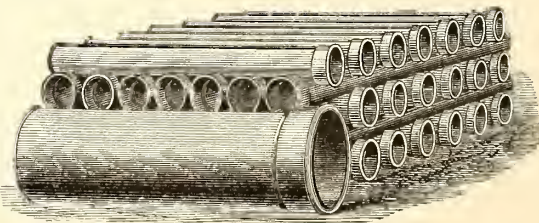

Casholders, Lime Trays, Center Valves, Purifiers, Bench Work, Exhausters, Condensers, Governors, Scrubbers, Gas Valves. Station Meters, Cast Iron Pipe Fittings.

Manufacturers of Heavy Castings and Machinery of Every Description.

ENGINEERS & CONTRACTORS FOR THE ERECTION OF GAS WORKS, & ALL MACHINERY CONNECTED THEREWITH

Estimates and specifications furnished for erection of new works or the extension or alteration of old ones.

Foundries and Works, - - Millville, Florence, and Camden, N. J.

C. BARCALOW, PREST.

J. V. BARCALOW, SEC. & TREAS.

BARTLETT Street Lamp Mfg. Co.

MANUFACTURERS OF

Bartlett's Patent

GLOBE LAMPS,

FOR

Streets, Parks, Railroad Stations, Public Buildings, Etc.

LAMP POSTS A SPECIALTY.

Office and Salesroom,

No. 35 Howard Street, N. Y. City.

Gas Companies and others intending to erect lamps and posts will do well to communicate with us.

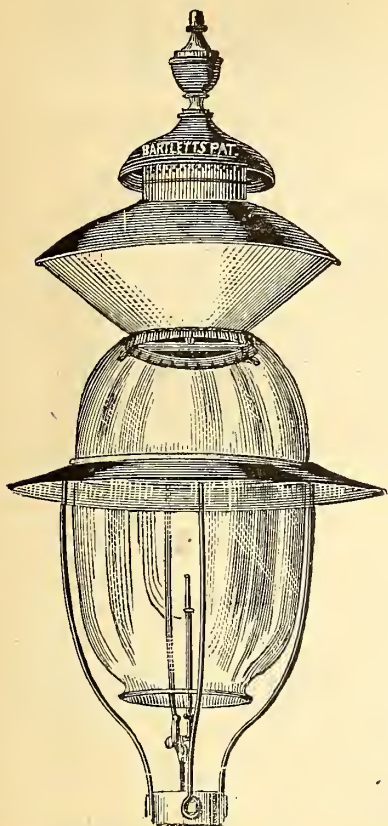

THE GLOBE
STREET LAMP.

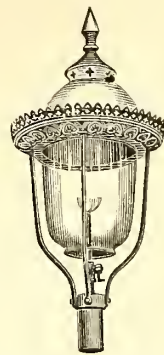

MINER'S PATENT
STREET LAMPS.

Are adapted for use of Streets, Parks, Depots, Ferries, & Private Grounds.

WITH POSTS OR BRACKETS.

Jacob G. Miner,

MORRISANIA, N. Y. CITY.

MITCHELL, VANCE & CO.,

MANUFACTURERS OF

Chandeliers

and every description of

GAS FIXTURES.

Also manufacturers of Fine Gilt Bronzes and Marble Clock warranted best time-keepers. Mantel Ornaments, etc.

Salesrooms, 836 Broadway, N. Y.

Special Designs furnished for Gas Fixtures for Churches, Public Halls, Lodges, etc.

F. M. ROOTS.

S. C. ROOTS

D. T. ROOTS.

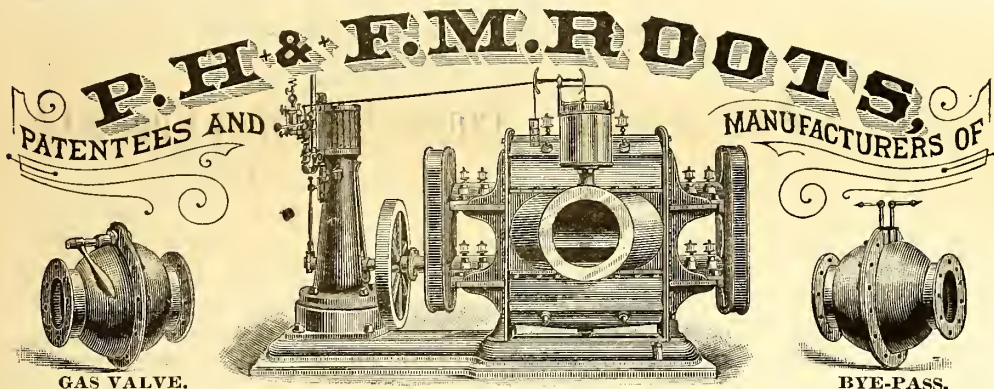

IMPROVED GAS EXHAUSTER,

WITH ENGINE ON SAME BED PLATE, OR WITHOUT.

BYE-PASSES, GAS VALVES, GOVERNORS, ELBOWS, PIPE-FITTINGS, Etc., FURNISHED TO ORDER,

P. H. & F. M. ROOTS, Patentees & Manufacturers, CONNERSVILLE, IND.

S. S. TOWNSEND, General Agent, 22 Cortland St. and 9 Dey St., N. Y.

JAS. BEGGS & CO., Selling Agents, 9 Dey St., N. Y.

COOKE & CO., Selling Agents, 22 Cortland St., N. Y.

✽ SEND FOR ILLUSTRATED CATALOGUE AND PRICE LIST. ✽

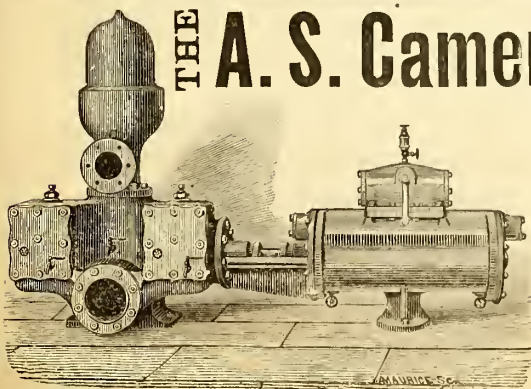

THE A. S. Cameron Steam Pump,

THE STANDARD OF EXCELLENCE.

Upward of 30,000 in Use.

BEST GAS WORKS PUMP

Ever Introduced.

Adapted to Every Possible Duty.

A. S. Cameron Steam Pump Works,

Foot East 23d St., N. Y.

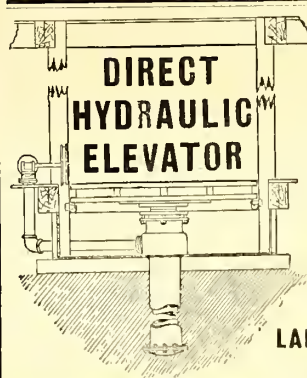

With Iron or Wood Platform.

DIRECT
HYDRAULIC
ELEVATOR

Largely used by Leading Gas Co.s for Coal and Coke Lifts.

Adapted for use with city service, or special pumping and accumulator system. For prices address the

LANE & BODLEY CO.,
Cincinnati, O.

"ECLIPSE" HAND PIPE-CUTTING MACHINE.

No. 1.

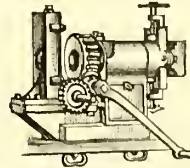

Powerful, inexpensive, simple in construction; can be attached to any bench or plank in a few moments. Cuts and Screws Pipes 1/4 to 2 in.

Address for Prices,
PANCOAST & MAULE,
Philadelphia, Pa.

(Mention this Paper.)

Iron Sponge, GAS EXHAUSTERS,

AUTOMATIC GAS GOVERNORS,

CONNELLY & CO., Limited.

No. 402 BROADWAY, NEW YORK CITY.

NEWBIGGING'S Gas Manager's Handbook.

Price, \$4.80.

EVERY GAS MAN SHOULD HAVE ONE.

Orders may be sent to this Office.

THE CONTINENTAL GAS ENGINE COMPANY.

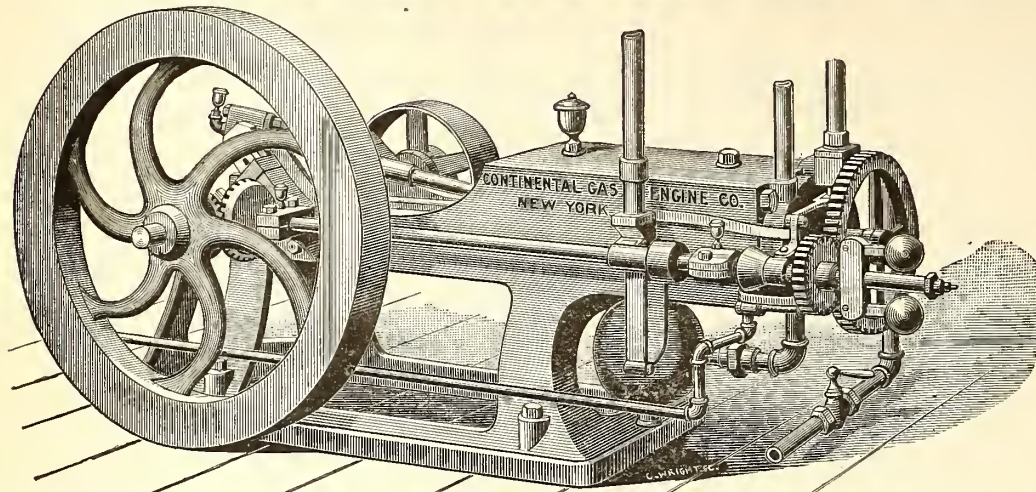

MANUFACTURERS OF
GAS ENGINES,

UNDER THE
GAUME AND OTHER PATENTS,
HAVE READY

Engines of ½, 1 and 1½ H.P.

Arranged for power or for pumping, 1-horse power will pump 1,000 gals. water 100 ft. high with 25 ft. of gas; ½-horse power will pump 500 gals. 100 ft. high per hour with 25 ft. of gas.

Each Engine Tested by Indicator and Meter.

SIMPLE, ECONOMICAL, SAFE, AND SUBSTANTIAL.

Call and see engines in operation, or address for circulars and prices.

Office, No. 231 Broadway, N. Y. City.

The Management of Small Gas Works.

BY C. J. R. HUMPHREYS.

Price, \$1.

Orders to be sent to **A. M. CALLENDER & CO.,**
42 PINE STREET, NEW YORK.

BOOKS.

DISTILLATION OF COAL TAR AND AMMONIACAL LIQUOR.

By GEORGE LUNGE. Price \$8.50.

A TREATISE ON THE COMPARATIVE COMMERCIAL VALUES OF GAS COALS AND CANNELS.

By DAVID A. GRAHAM. 8vo., Cloth. Price \$3.

Orders for these books may be sent to this office.

A. M. CALLENDER & CO.,
42 PINE ST., N. Y. CITY.

PRESERVE

The Journal

BY THE USE OF

THE STRAP FILE.

Advantages of the Strap File.

- 1st. It is simple, strong, and easily used.
- 2d. Preserves papers without punching holes.
- 3d. Will always lie flat open.
- 4th. Allows any paper on file to be taken off without disturbing the others.

Price, \$1.25. Sent either by express or mail, as directed. By mail the postage will be 20 cents which will be added to the price of the Binder.

A. M. CALLENDER & CO., 42 PINE ST., N. Y.

CHURCH'S REVERSIBLE SCREEN FOR GAS PURIFIERS

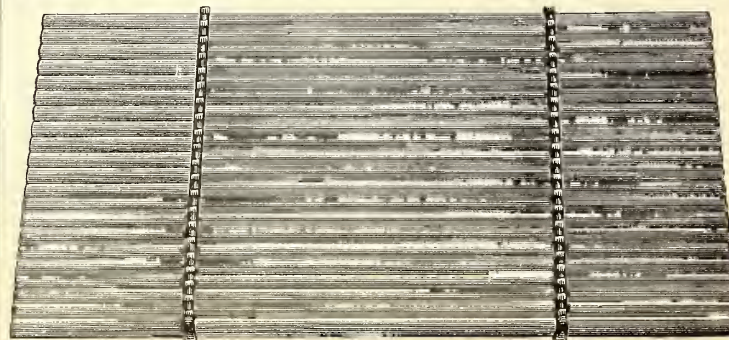

PATENTED JULY 9, 1878.

References in all parts of the country. Send for circular and list of companies who now have the Screen in use.

Very Durable
Easily Repaired.

Oval Slats, with Malleable Iron Cross Bars.

Apply to

JOHN CABOT,
LAWRENCE, MASS.

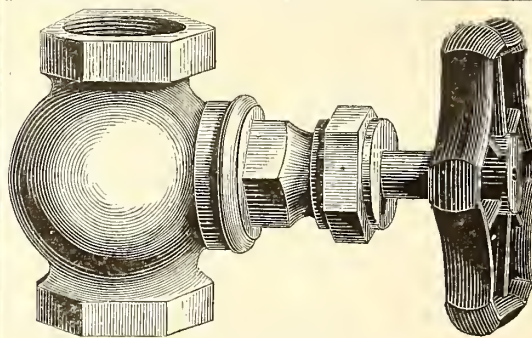

Factory, Paterson, N. J.

McNab & Harlin Mfg. Co.,

MANUFACTURERS OF

BRASS COCKS & VALVES

FOR STEAM, WATER, AND GAS.

Iron Pipes and Fittings

Seamless Brass & Copper Tubes.

Illustrated Catalogue and Price List

56 JOHN STREET, N. Y.

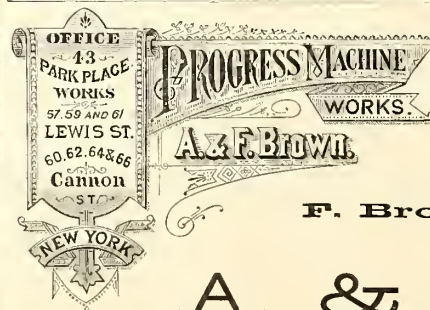

Shafting, Pulleys, HANGERS.

F. Brown's Patent Friction Clutch.

Send for Illustrated Catalogue and Discount Sheet to

A. & F. BROWN,

No. 43 Park Place, New York City.

King's Treatise on Coal Gas.

The most complete work on Coal Gas ever published.

Three Vols. Bound, \$30.

A. M. CALLENDER & CO., 42 Pine St., N. Y.

AMERICAN GAS LIGHT JOURNAL.

\$3.00 per Annum.

A. M. CALLENDER & CO.,

42 Pine Street, N. Y. City.

THE AMERICAN METER COMPANY,

MANUFACTORIES,

512 West Twenty-second Street, N. Y.

Arch and Twenty-second Street, Phila.

Nos. 244 & 246 North Wells Street, Chicago, Ill.

AGENCIES,

No. 177 Elm Street, Cincinnati, Ohio.

Nos. 122 & 124 Sutter Street, San Francisco, Cal.

No. 810 North Second Street, St. Louis, Mo.

ALL SIZES
CONSTANTLY
IN STOCK.

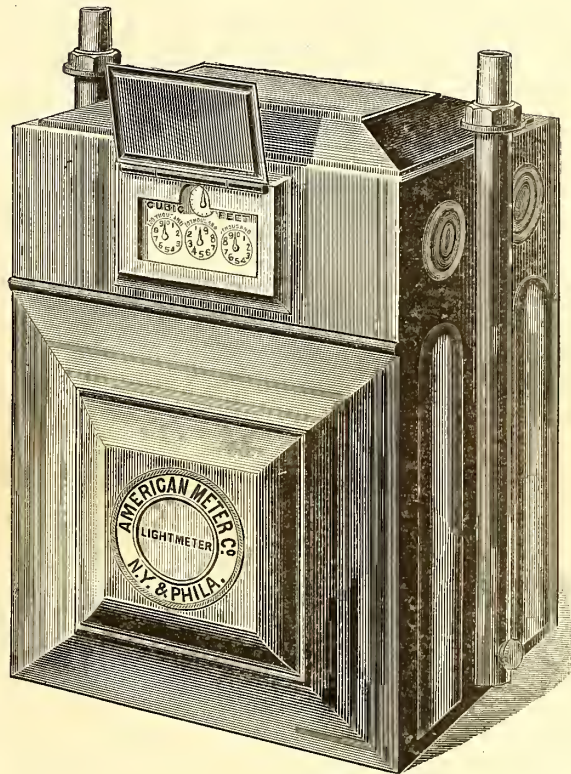

PRICE LISTS
ON
APPLICATION.

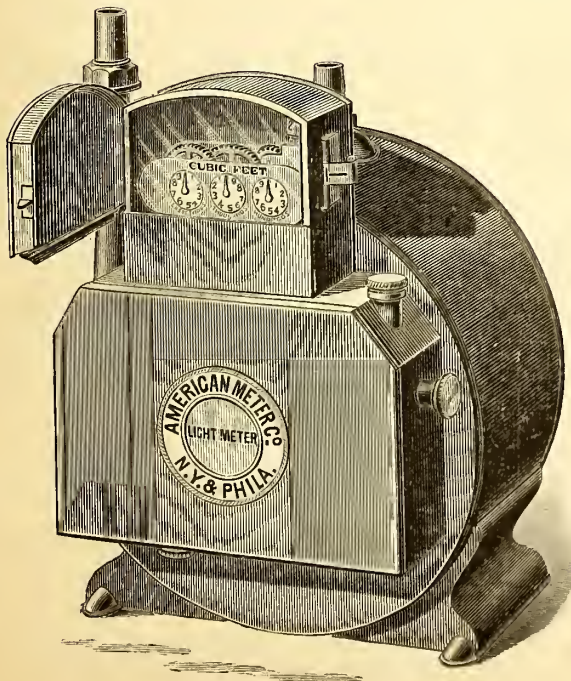

Mfr's of STANDARD WET AND DRY GAS METERS.

J. H. GAUTIER & CO..
 CORNER OF
 GREENE AND ESSEX STREETS,
JERSEY CITY, N. J.
 MANUFACTURERS OF
Clay Gas Retorts,
Gas House Tiles,
Fire Bricks, Etc. Etc.
 Ground Clay, Fire Brick and
 Fire Sand in Barrels,
 J. H. GAUTIER. T. B. GAUTIER.
 C. E. GREGORY. C. E. GAUTIER.

BROOKLYN
Clay Retort & Fire Brick Works,
 (EDWARD D. WHITE & CO.)
 Manufacturers of Clay Retorts, Fire Brick,
 Gas House and other Tile.
 VAN DYKE, ELIZABETH, RICHARDS & PARTITION STS.
 Office, 88 Van Dyke St., Brooklyn, N. Y.

LACLEDE FIRE BRICK MFG. CO.,
 MANUFACTURERS OF
Fire Brick, Gas Retorts,
 AND
ST. LOUIS STANDARD SEWER PIPE.
 Blast Furnace and Cupola Linings, every description of Fire
 Clay Material, Fire Clay Flue Linings, Chimney Tops
 Dry Milled and Crude Fire Clays, etc.
 OFFICE AND DEPOT
 901, 903, and 905 Pine Street,
 ST. LOUIS, MO.

ESTABLISHED IN 1845.
B. KREISCHER & SONS,
 OFFICE FOOT OF HOUSTON ST., E.R., N. Y.
Gas Retorts,
TILES, FIRE BRICK.
 AND EVERYTHING IN THE FIRE CLAY LINE.

MANHATTAN
 FIRE BRICK & ENAMELLED CLAY
RETORT WORKS.
ADAM WEBER.
CLAY GAS RETORTS
AND RETORT SETTINGS,
FIRE BRICKS, TILES, ETC.,
 Office and Works, 15th Street and Avenue C., N. Y.

Borgner & O'Brien,
 MANUFACTURERS OF
CLAY GAS RETORTS
AND RETORT SETTINGS,
FIRE BRICKS, TILES, ETC.
 23d St., Above Race,
PHILADELPHIA.
 TWENTY YEARS' PRACTICAL EXPERIENCE.

JAMES GARDNER, JR.
 Works,
 LOCKPORT STATION, PA.

—ESTABLISHED 1864.—
WILLIAM GARDNER & SON,
 Successor to GARDNER BROTHERS.

WILLIAM GARDNER.
 Office, COAL EXCHANGE,
 PITTSBURGH, PA, P. O. Box 373.

Fire Clay Goods for Gas Works.

C. H. SPRAGUE, No. 70 KILBY STREET, BOSTON, MASS., Agent for the New England States.

OFFICE, 418 to 422 East 23d St., New York.

ESTABLISHED 1856.

WORKS, PERTH AMBOY, NEW JERSEY.

HENRY MAURER,
Excelsior Fire Brick & Clay Retort Works
 CLAY GAS RETORTS, BENCH SETTINGS, FIRE BRICK, TILES, ETC.

STANDARD GAS RETORT AND FIRE BRICK COMPANY,
 J. ANDERSON, PRES. & MAN'G'R. OF IRONTON, OHIO. C. PETERS, SECRETARY.
Clay Gas Retorts, Fire Brick, and Fire Clay Goods of Every Description.
 Plans of Livesey-Somerville, McIlhenny, and other Furnaces, and Competent Workmen Supplied.

CHICAGO
Retort & Fire Brick Works,
 Office, Factory,
 79 Dearborn St., Unity Building. | 45th and Clark Sts.
 CHICAGO, ILL.
 GEORGE C. HICKS, PRES. PAUL P. AUSTIN, SEC. & TREAS.
STANDARD
Clay Retorts and Settings.
BLOCKS & TILES
 Of every Shape and Size to Order.
Standard Fire Bricks.

CINCINNATI
Gas Retort & Fire Brick Co.,
 (ESTABLISHED 1872.)
CINCINNATI, OHIO.
 Manufacturers of Gas Retorts, Retort Set-
 tings, Fire Brick, Tiles, Etc.

OAKHILL
GAS RETORT & FIRE BRICK
COMPANY.
PARKER, RUSSELL & CO.
 City Office, 45th & Clark Sts.,
ST. LOUIS, MO.

Our immense establishment is now employed almost entirely in
 the manufacture of
MATERIALS FOR GAS COMPANIES.
 We have studied and perfected three important points. Our re-
 torts are made to stand changes of temperature, the strongest
 heats of the furnace, and the abrasion of feeding and emptying.
 Our customers are in almost every State of the Union, to all of
 whom we refer.

THOS. SMITH, Prest. AUGUST LAMBLA, Vice-Prest. & Sup
BALTIMORE
RETORT & FIRE BRICK CO.
 MANUFACTORY AT
LOCUST POINT, BALTIMORE, MD.
 Connection with the City by Telephone.
Clay Retorts, Blocks & Tiles,
FIRE BRICK, FIRE CLAY,
AND FIRE CEMENT.

Red and Buff Ornamental Tiles and Chim-
 ney Tops. Drain and Sewer Pipe (from
 2 to 30 inches). Baker Oven Tiles
 12 x 12 x 2 and 10 x 10 x 2.
WALDO BROS., 88 WATER ST., BOSTON, MASS.
 Sole Agents for New England States

Siemens's Regenerative Gas Burners, For Lighting and Ventilating.

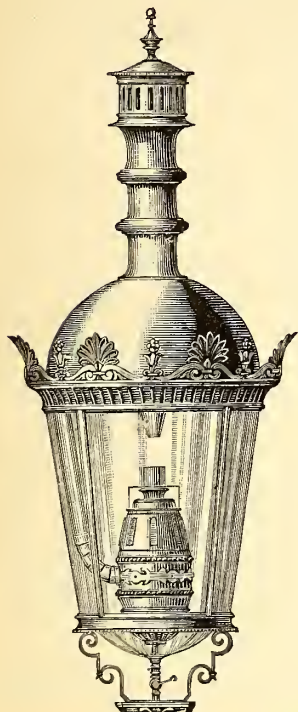

THE CHEAPEST, PUREST, AND MOST BRILLIANT OF ALL GAS LIGHTS.

Superior to the Electric Light in Economy, Beauty, & Steadiness.

SPECIALLY ADAPTED FOR LIGHTING HALLS, FACTORIES, OPEN SPACES, ETC.

Numerous Tests made by various Gas Companies in the United States show an Efficiency of Ten Candle Power per Cubic Foot of Gas.

General Agents:

SIEMENS LIGHTING CO., 347 West Main St., Louisville, Ky.
 MEYER, MARSHALL & CO., 528 California St., San Francisco.
 DENNEHY, WOLF & O'BRIEN, 85 & 87 Dearborn St. Chicago, Ill.
 WILCOX & McGEARY, - No. 11 Bissel Block, Pittsburgh, Pa.
 T. T. RAMSDALL & CO., - 20 Swan Street, Buffalo, N. Y.
 SIEMENS GAS ILLUMINATING CO.,
 Room 6, No. 157 Broadway, New York City.
 W. D. COLT, - - - - 1420 F Street, Washington, D. C.
 JOHN KIEFER, - - - 344 Lawrence, Street, Denver, Col.

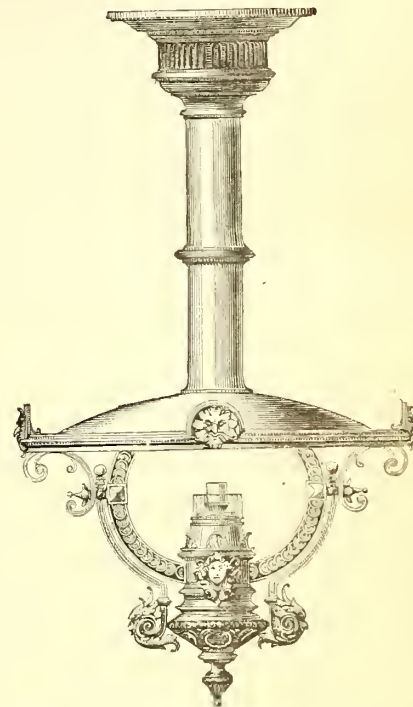

THE SIEMENS REGENERATIVE GAS LAMP COMPANY.

SOLE MAKERS FOR THE UNITED STATES,

N. E. Cor. 21st. St. and Washington Av., Philadelphia, Pa.

THE "STANDARD" WASHER-SCRUBBER,

KIRKHAM, HULETT & CHANDLER'S PATENT.

Total Capacity per 24 Hours of "Standard" Washers Ordered During the Following Years.

1877.....	4,000,000 cubic feet.
1878.....	4,750,000 "
1879.....	21,545,000 "
1880.....	42,967,500 "
1881.....	36,462,500 "
1882.....	39,300,000 "
1883.....	57,735,000 "
1884.....	26,177,500 "
Total.....	235,937,500 cubic feet.

Total Number and Capacity per 24 Hours of "Standard" Washers Erected and in Course of Erection in the Several Countries

	Number.	Cubic Feet per Day.
Great Britain..	151	157,070,000
Western Hemisphere.....	38	39,337,500
Australia.....	18	12,150,000
New Zealand	2	650,000
France	6	4,550,000
Belgium	8	5,420,000
Germany	16	8,200,000
Holland	4	4,160,000
Denmark.....	1	150,000
Russia	2	3,500,000
Spain	1	350,000
India.....	1	400,000
Total.....	248	235,937,500

THE CONTINUED POPULARITY Of these Machines

Will be recognized from the following extracts from letters from representatives of some of the companies having them in use:

TOLEDO GAS LIGHT AND COKE CO., }
 TOLEDO, OHIO, NOV. 25, 1884. }

GEO. SHEPARD PAGE, Esq.:

Dear Sir—Replying to your kind favor of 21st inst, I would say that the "Standard" Washer-Scrubber is doing work that is entirely satisfactory to us. During the summer I had 12-oz. liquor; but since cool weather commenced I have been having from 18 to 23-oz. liquor, just as we would elect. There is not a trace of ammonia passing the Scrubber that a test of reddened litmus or yellow turmeric paper would indicate. The machine, in my opinion, is all that could be desired as a means for removing all the ammonia from the gas. Very respectfully,

C. R. FABEN, Jr.,

Superintendent.

"Standard" Washers Ordered During the Current Year.

	Cu. Ft. per Day
Anneberg Gas Co.....	200,000
Bombay Gas Co.....	400,000
Brussels Co.....	1,250,000
Chemnitz Gas Co	1,000,000
CITIZENS GAS CO., BUFFALO.....	750,000
Coke Works in Zabre, Ober-Schlesien	1,500,000
Cokerei der Friedenshütte, Upper Silesia	700,000
Dumfries Corporation.....	250,000
Dunedin Gas Co., New Zealand	400,000
King's Lynn Gas Co.....	300,000
Leiden, Holland.....	600,000
Lincoln Gas Co.....	400,000
Liverpool Gas Co.....	2,000,000
"	3,000,000
LOUISVILLE GAS CO.....	1,500,000
Nimera Gas Co.....	100,000
PITTSBURGH GAS CO.....	1,500,000
PORTLAND GAS CO., OREGON	562,500
SAN FRANCISCO GAS CO.....	4,000,000
Sheepbridge	10,000
ST. LOUIS GAS CO.....	2,000,000
Sydney Gas Co.....	2,500,000
WASHINGTON, D. C. GAS CO.....	2,000,000
Whitechurch Gas Co	175,000
Total.....	26,177,500

GEO. SHEPARD PAGE, No. 69 WALL STREET, NEW YORK,

SOLE AGENT FOR THE WESTERN HEMISPHERE.

A. H. M'NEAL,

BURLINGTON, N. J.

Flange-Pipes

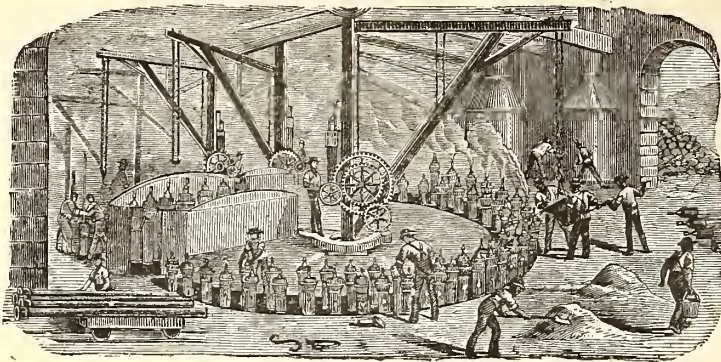

General Foundry Work.

CAST IRON PIPES

FOR WATER AND GAS.

JAMES S. MOORE, Pres.
BENJAMIN CHEW, Treas.

JAS. P. MICHELLON, Sec.
WM. SEXTON, Supt.

GLOUCESTER IRON WORKS, GLOUCESTER CITY N. J.

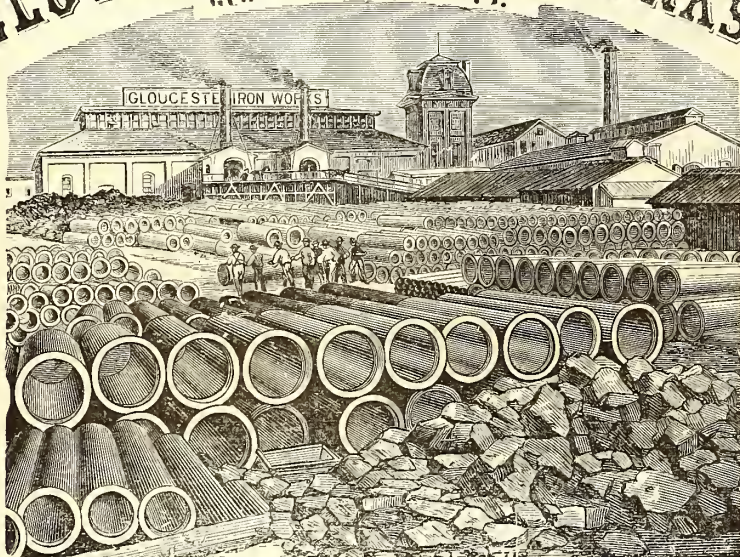

Cast Iron Gas & Water Pipes, Stop Valves, Fire Hydrants, Gasholders, &c.
Office No. 6 North Seventh Street, Philadelphia.

ESTABLISHED 1856.

WARREN FOUNDRY AND MACHINE CO.,

WORKS AT PHILLIPSBURGH, N. J.
NEW YORK OFFICE, 162 BROADWAY.

Cast Iron Water and Gas Pipe

FROM TWO TO FORTY-EIGHT INCHES DIAMETER.
ALSO ALL SIZES OF

FLANGE PIPE for Sugar House and Mine Work.
Branches, Bends, Retorts, Etc., Etc.

436-1

MATTHEW ADDY, President.

W. L. DAVIS, Selling Agent.

GEO. P. WILSHIRE, Sec. & Treas.

Cincinnati and Newport Iron and Pipe Company,

NEWPORT, KY.

Lamp Posts
AND
BENCH CASTINGS

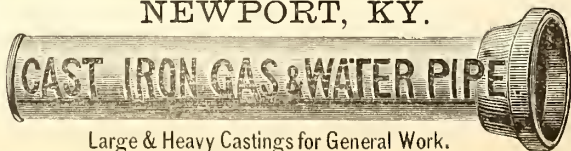

Branch
AND
SPECIAL CASTINGS

A Specialty.

Large & Heavy Castings for General Work.

FOR GAS & WATER CO'S.

Manufacture Pipe from 2 to 48 inches. All work guaranteed first quality.

Mellert Foundry and Machine Co.

Limited. Established 1848.
MANUFACTURERS OF



Specials—Flange Pipe, Valves and Hydrants,
Lamp Posts, Retorts, etc.
Machinery and castings for Furnaces, Rolling Mills, Grist and
Saw Mills, Mining Pumps, Hoists, etc.

GENERAL OFFICE, - - - READING, PA.

To Gas Companies.

We make to order **CAP BURNERS** to burn any amount
under a stated pressure. Send for samples.

Also, **SERVICE CLEANERS, DRIP PUMPS, and STREET
MAIN PROVING APPARATUS.**

C. A. GEFROERER,
248 N. 8th Street. Phila., Pa.

WALTER ANDERSON,

Manufacturer of all descriptions of

GAS BURNERS.

Also Metal E. H. Nickel Plated Tips for Water Gas.

COR. WHITE AND ELM STS., N. Y.

MORRIS, TASKER & CO., Limited,

Builders of Gas Works,
PHILADELPHIA, PA.

LUDLOW VALVE MFG. CO

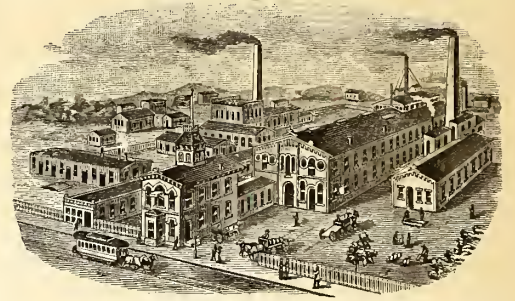

OFFICE AND WORKS,

938 to 954 River Street and 67 to 83 Vail Av.

TROY, N. Y.

Hydraulic Main Dip Regulators, also
Check Valves, Foot Valves, Yard-
wash and Fire Hydrants.
Send for Circulars.

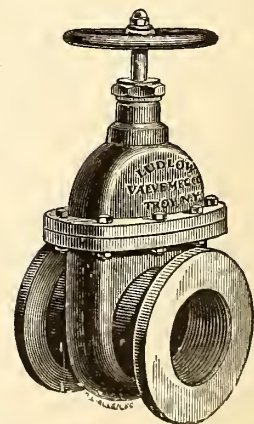

Valves.—Double and Single Gate, 1/2 in. to
48 in., outside and inside Screws. Indica-
tor, etc., for Gas, Water, Steam, and Oil.
Send for Circulars.

JOS. R. THOMAS, C.E.,

May be Consulted on all Mat-
ters Relating to Gas Works
and Gas Manufacture.

ADDRESS THIS OFFICE.

KERR MURRAY MFG. CO.,

MANUFACTURERS OF

Single Lift and Telescopic GASHOLDERS.

Built, 1884:

Altoona, Pa.....	Capacity, 160,000 cubic feet.
Pittsburgh, Pa.....	" 250,000 "
" ".....	" 220,000 "
Bellaire, Ohio.....	" 50,000 "
Youngstown, Ohio.....	" 60,000 "
Canton, ".....	" 60,000 "
Akron, ".....	" 80,000 "
Xenia, ".....	" 10,000 "
Adrian, Mich.....	" 65,000 "
Ypsilanti, Mich.....	" 25,000 "
Muskegon, ".....	" 70,000 "
South Bend, Ind.....	" 70,000 "
Anderson, ".....	" 20,000 "
Plainfield, ".....	" 10,000 "
Springfield, Illinois.....	" 100,000 "
Evanston, ".....	" 50,000 "
Freeport, ".....	" 35,000 "
Elgin, ".....	" 60,000 "
Sheboygan, Wis.....	" 20,000 "
Key West, Fla.....	" 10,000 "

Plans and estimates furnished for the erection of new and the rebuilding of old works. Address

Kerr Murray Mfg. Co.,
FORT WAYNE, IND.

JAMES R. FLOYD,
(SUCCESSOR TO HERRING & FLOYD)

Oregon Iron Works,
531 to 543 West 20th St., N. Y.
Practical Builders of Gas Works,
MANUFACTURERS OF
ALL KINDS OF CASTINGS
AND
APPARATUS FOR GAS-WORKS.

BENCH CASTINGS
from benches of one to six Retorts each.
WASHERS: MULTITUBULAR AND
AIR CONDENSERS; CONDENSERS; SCRUBBERS

(wet and dry), and
EXHAUSTERS
for relieving Retorts from pressure.
BENDS and BRANCHES
of all sizes and description.

FLOYD'S PATENT
MALLEABLE RETORT LID.
PATENT
SELF-SEALING RETORT LIDS.
FARMER'S
PATENT BY-PASS DIP-PIPE.
SABBATON'S PATENT
FURNACE DOOR AND FRAME.
BUTLER'S
COKE SCREENING SHOVELS.

GAS GOVERNORS,
and everything connected with well regulated Gas Works at low price, and in complete order.

SELLER'S CEMENT
for stopping leaks in Retorts.
N. B.—STOP VALVES from three to thirty inches—
at very low prices.
Plans, Specifications, and Estimates furnished.

CONTINENTAL WORKS.

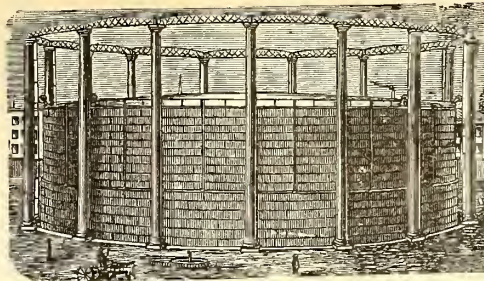

GASHOLDERS OF ANY MAGNITUDE.

T. F. ROWLAND, Proprietor,
GREENPOINT, BROOKLYN, N. Y.
ENGINEER AND MANUFACTURER OF
GAS-HOLDERS.
CONDENSERS, SCRUBBERS, VALVES,
PURIFIERS, RETORTS. and HY-
DRAUIC MAINS,

and all other articles connected with the Manufacture
Distribution of Gas. Plans and Specifications prepared
and Proposals given for the necessary Plant for Lighting
Cities, Towns, Mansions, and Manufactories.

H. RANSHAW, Pres. & Mangr. WM. STACEY, Vice-Pres. T. H. BIRCH, Asst. Mangr. R. J. TARVIN, Sec. & Treas.

STACEY MFG. CO.,

MANUFACTURERS OF

Single and Telescopic Gasholders,

IRON ROOFS, BRIDGES, LAMP POSTS,

Water and Oil Tanks, Coal Elevator Cars,
COKE CRUSHERS, BENCH CASTINGS,

And all kinds of Wrought and Cast Iron Work used in the erection of Coal and Oil Gas Works.
Rolling Mill Machinery and Heavy Castings a Specialty.

Foundry: 33, 35, 37 & 39 Mill Street. **Wrought Iron Works:** 16, 18, 20, 22, 24 & 26 Ramsey Street.

Cincinnati, Ohio.

BARTLETT, HAYWARD & CO.,

Office, 24 Light.

BALTIMORE, MD.

Works, Pratt & Sc

PURIFIERS.

Roofs.
Bench Castings.

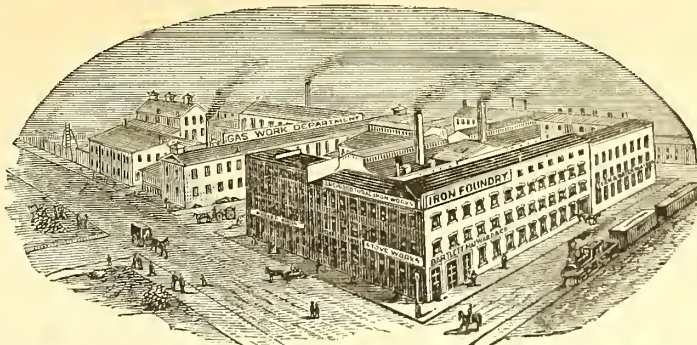

SCRUBBERS.

CONDENSERS.

GASHOLDERS.

CONSTRUCTING ENGINEERS AND BUILDERS OF GAS WORKS.

1842. **DEILY & FOWLER,** 1884.

Laurel Iron Works.

Address, No. 39 Laurel Street, Philadelphia, Pa.

MANUFACTURERS OF

GASHOLDERS,

Single or Telescopic, with Cast or Wrought Iron Guide Frames.

Holders Built Since 1880:

Mount Joy, Pa.	West Point, N. Y.	Galveston, Texas (2d.)	Kalamazoo, Mich. (3d.)	Newport, R. I.
Rockaway B'ch, N.Y. (2)	Fitchburgh, Mass.	Marlboro, Mass.	Glen Island, N. Y.	Portland, Oregon.
Zanesville, O. (2d.)	New London, Conn.	Denver, Col.	Warren, Ohio.	Allegheny, Pa. (2d.)
Lancaster, O.	Derby, Conn.	Chicago, Ill. (West Side)	Bath, N. Y.	Athlanta, Ga. (2d.)
Blackwell's Island N. Y.	Bridgport, Conn.	Pittsburgh, Pa. (S. Side)	Lynn, Mass.	N.Y. City (Central Gas Co)
Waltham, Mass., (1st.)	Allegheny, Pa. (1st.)	Pawtucket, R. I.	New Bedford, Mass.	Lynchburg, Va. (2d.)
Dorchester, Mass.	St. Hyacinth, Can.	Brookline, Mass.	Waterbury, Conn.	Saylesville, R. I.
Wheeling, West Va.	Norwalk, O.	Sherbrooke, Can.	Deseronto, Can.	Rondout, N. Y.
Lansing, Mich.	Brattleboro, Vt.	Burlington, N. J. (2d.)	Hoosic Falls, N. Y. (2d.)	Atlantic City, N. J.
Flint, Mich.	Waltham, Mass (2d.)	Bridgton, N. J.	Bethlehem, Pa.	Augusta, Ga.
Galveston, Texas (1st.)	West Chester, Pa.	Bay City, Mich.	Atlanta, Ga. (1st.)	Waltham, Mass. (3d.)
Milton, Pa.	Baltimore, Md.	Erie, Pa.	Savannah, Ga.	
Scranton, Pa.	Hollidaysburg, Pa.	Jackson, Mich.	Montgomery, Ala	

GAS COALS.

GAS COALS.

GAS COALS.

JAMES D. PERKINS.

PERKINS & CO.,

F. SEAVERNS.

General Sales Agents.

THE YOUGHIOGHENY RIVER COAL COMPANY,

Organized August 1, 1882.

MINERS AND SHIPPERS OF THE WELL-KNOWN

Ocean Mine Youghioghenny Gas Coal.

The Coal from the Ocean Mine (recently operated by Messrs. W. L. Scott & Co., of Erie, Pa.,) is now used by all the leading Gas Companies in the United States from Maine to Texas, and is recognized as *the only reliable Youghioghenny Gas Coal.*

Messrs. W. L. Scott & Co. and W. L. Scott, Esq., still retain their interest in the new Company, and the same general policy which has characterized the management of the mine under these gentlemen will be continued by the new Company. With largely increased facilities and *unlimited supply of Coal*, any demand made upon the Colliery will meet with prompt fulfillment.

THE UNDERSIGNED CAN SUPPLY THE FOLLOWING SUPERIOR GRADES OF

GAS CANNELS:**Abram Cannel**, from the Abram Colliery, Wigan, England.**Plesio-Boghead Cannel**, from near the old Boghead Colliery, Scotland.**North Ince Hall Cannel**, from Liverpool, England.

Breckenridge Cannel, from Kentucky. The railroad now being constructed to the Ohio river will open up this superior Cannel deposit, and enable us to deliver it at any required point. See full description of this Cannel, and Map of the Colliery, in the "American Gas Light Journal," April 16, 1883, pages 172 and 173.

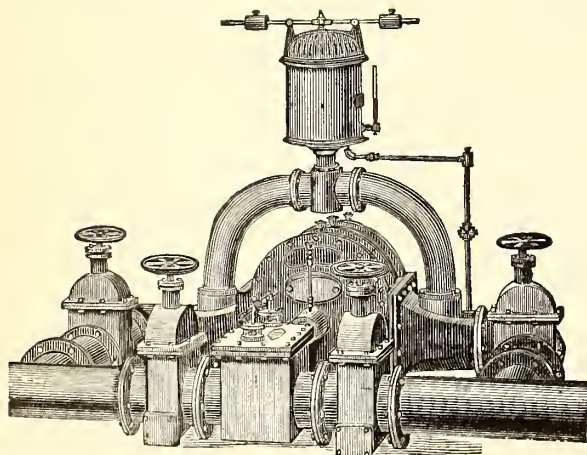
P. O. Box 3695,
New York.**PERKINS & CO., 228 and 229 N. Y. Produce Exchange**BEAVER STREET
ENTRANCE.**SMITH & SAYRE MFG. COMPANY,**

G. G. PORTER, Prest.

245 Broadway, N. Y.

CHAS. W. ISBELL, Sec'y.

Machinery & Apparatus for Gas Works

Drawings, Plans, and Estimates Furnished for the Improvement, Extension, or Alteration of Gas Works, or for the Construction of New Works.

Mackenzie's Patent Rotary and Steam Jet Gas Exhausters, Governors, Compensators, Condensers, Washers, Scrubbers. Isbell's Patent Automatic Street Pressure Governor, Gas and Water Valves, Hydraulic Main Dip Regulator, Bench Castings, etc. Purifying Boxes and "Standard" Scrubbers. Isbell's Patent Self-Sealing Retort Doors.

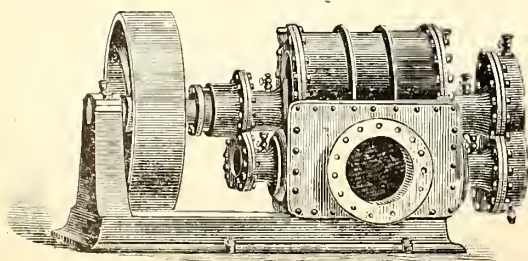

Gas Exhauster Driven by Belt.

The Wilbraham Gas Exhauster,

"BAKER SYSTEM,"

WITH ENGINE ATTACHED, ON SAME BED PLATE OR WITHOUT.

Best, Cheapest and Most Durable Exhauster known.

WILBRAHAM BROS.,

No. 2320 Frankford Avenue, Philadelphia, Pa.

GAS COALS.

Newburgh Orrel Coal Co.,
MINERS AND SHIPPERS OF
**Newburgh Orrel, Tyrconnell
and Palatine Gas Coals.**

ALSO SHIPPERS OF FOUNDRY COKE.

Mines Situated at

Newburgh, Flemington & Fairmont, W. Va.

HOME OFFICE,

25 S. Gay St., Baltimore.

CHARLES MACKALL,
MANAGER.

CHAS. W. HAYS, Agent in New York,

Room 92, WASHINGTON BUILDING, No. 1 Broadway.

Shipping wharves at Locust Point. References furnished when required. Special attention given to chartering vessels.

THE DESPARD COAL COMPANY

OFFER THEIR SUPERIOR

DESPARD COAL

To Gas Light Companies and Manufacturers of Fire Clay Goods
Throughout the Country.

ROUSSEL & HICKS, } AGENTS. { BANGS & HORTON,
71 Broadway, N. Y. } 16 Kilby St., Boston.

Mines in Harrison Co., West Va. Wharves, Locust Point, Balt.

Company's Office, 15 German St., Baltimore, Md.

Among the consumers of Despard Coal we name: Manhattan
Gas Light Co., N. Y.; Metropolitan Gas Light Co., N. Y.; Jersey
City, (N. J.) Gas Light Co.; Washington (D. C.) Gas Light Co.;
Portland (Maine) Gas Light Co. Reference to them is requested.

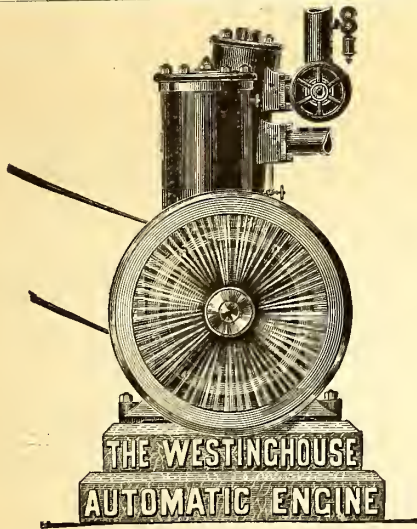

1,000 Engines Now in Use.

30,000 H.P. NOW RUNNING!

Sales, 2,000 H.P. per Month!

SEND FOR ILLUSTRATED CIRCULAR AND REFERENCE LIST.

Westinghouse Machine Co.,

PITTSBURGH, PA.

SALES DEPARTMENT CONDUCTED BY

Westinghouse, Church, Kerr & Co., 17 Cortlandt
Street, New York City.

Fairbanks, Morse & Co., Chicago, Cincinnati, Cleve-
land, Louisville, and St. Paul.

Fairbanks & Co., St. Louis, Indianapolis, and Denver.

Parke & Lacy, San Francisco, and Portland, Or.

Parke, Lacy & Co., Salt Lake City, Utah, and Butte,
Montana.

D. A. Tompkins & Co., Charlotte, N. C.

Imray, Hirsch & Kaepfel, Sydney and Melbourne,
Australia.

GAS COALS.

GAS COALS,

THE

PENN GAS COAL COMPANY

OFFER THEIR

COAL, CAREFULLY SCREENED,

AND PREPARED FOR

GAS PURPOSES.

Their Property is located in the Youghiogheny Coal Basin, near Irwin's and Penn Station
on the Pennsylvania Railroad, and on the Youghiogheny River.

OFFICES

No. 209 South Third Street, Phil'a. 90 Wall Street, New York.

PLACES OF SHIPMENT.

Pennsylvania Railroad, Pier No. 2 (Lower Side).

Greenwich Wharves, Delaware River.

366-1y

Pier No. 1 (Lower Side), South Amboy, N. J.

Chesapeake & Ohio Railway Coal Agency,

FOR THE SALE OF THE

**Superior Kanawha Gas Coals, Cannelton Cannel,
Also, SPLINT AND STEAM COALS.**

From the Kanawha and New River Regions, on the line of the Chesapeake & Ohio R'way.

C. B. ORCUTT, Sales Agent. | OFFICE, 150 BROADWAY, N. Y.

FRANCIS H. JACKSON, PRESIDENT.

EDMUND H. MCCULLOUGH, SEC. & TREAS.

THE WESTMORELAND COAL CO.

Chartered 1854.

Mines situated on the Pennsylvania and the Baltimore
and Ohio Railroads, in Westmoreland County, Penn.

POINTS OF SHIPMENT:

PHILADELPHIA, BALTIMORE, SOUTH AMBOY, N. J.
WATKINS (SENECA LAKE), N. Y.

Since the commencement of operations by this Company its well-known
Coal has been largely used by the Gas Companies of New England and the
Middle States, and its character is established as having no superior in gas-
giving qualities, and in freedom from sulphur and other impurities.

Principal Office, 224 South 3d St., Phila., Pa.

The Bower Gas Lamp.

The Perfected Duplex-Regenerative Gas Burner, under
the combined Patents of Anthony S. Bower,
Geo. S. Grimston, and Thos. Thorp.

The First Gold Medal awarded at the Crystal Palace Exhibition in
London, and two Gold Medals at the Stockport (Eng.) Exhibition of Gas
Appliances. Both in 1883.

GEO. SHEPARD PAGE, JOHN BOWER,
69 Wall Street, N. Y. City.

The Management of Small Gas Works.

By C. J. R. HUMPHREYS. Price, \$1.

A. M. CALLENDER & CO., 42 Pine St., N. Y.



INTERNATIONAL--1876--EXHIBITION.

The U. S. Centennial Commission

HAVE DECREED AN AWARD TO

HARRIS, GRIFFIN & CO.,

12th and Brown Sts., Philadelphia, and 49 Dey St., N. Y., U. S. A.,

FOR THE FOLLOWING REASONS :

The Exhibit consists of a Series of METERS from the Largest Size Station Meters for the use of the MANUFACTURE OF GAS, to those for the use of the ORDINARY CONSUMER. The Instruments are WELL MADE, RELIABLE as to INDICATION, and embody a number of sundry improvements which, with the general character of the Exhibit, entitle the whole to commendation.

Attest—J. L. CAMPBELL,
Secretary, pro-tem.

Signed—A. T. GOSHORN,
Director General

J. B. HAWLEY,
President

CHARLES E. DICKEY.

JAMES B. SMALLWOOD.

CHARLES H. DICKEY.

Maryland Meter and Manufacturing Co.,

DICKEY, TANSLEY & CO.,

Established 1866.

Nos. 22 and 24 Saratoga Street, Baltimore, Md.

No. 46 La Salle St., Chicago, Ill.

MANUFACTURERS OF

DRY GAS METERS, STATION METERS, GLAZED METERS, TEST METERS, METER PROVERS, PRESSURE AND VACUUM REGISTERS, GOVERNORS, INDICATORS, SERVICE AND METER COCKS, AND METER CONNECTIONS.

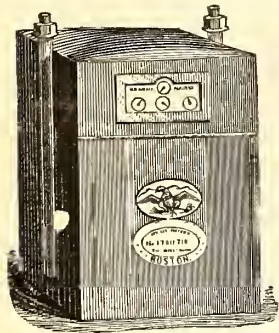

Dry Gas Meter.

With 39 years' experience and the best facilities for manufacturing, is enabled to furnish reliable work and answer orders promptly.

NATHANIEL TUFTS,

No. 153 Franklin Street, Boston, Mass.,

MANUFACTURER OF

DRY GAS METERS.

Station Meters of any Capacity.

Test and Experimental Meters, Pressure Registers, Pressure Gauges, Pressure and Vacuum Gauges.

METER PROVERS, PHOTOMETERS, STREET LANTERNS, ETC., ETC.

Patent Cluster Lanterns for Street Illumination.

SCIENTIFIC BOOKS.

We are prepared to furnish to Gas Managers, and others interested in the topics treated of, the following books, at prices named :

<p>KING'S TREATISE ON THE MANUFACTURE OF COAL GAS. Three vols.; \$10 per vol.</p> <p>GAS MANUFACTURE, by WILLIAM RICHARDS. 4to., with numerous Engravings and Plates, in Cloth binding. \$12.</p> <p>THE GAS ANALYST'S MANUAL, by F. W. HARTLEY. \$2.50.</p> <p>ANALYSIS, TECHNICAL VALUATION, PURIFICATION, and USE OF COAL GAS, by REV. W. R. BOWDITCH, M.A.; with Engravings; 8vo., Cloth. \$4.50.</p> <p>GAS MEASUREMENT AND GAS METER TESTING by F. W. HARTLEY. \$1.60.</p> <p>GAS CONSUMER'S HANDBOOK, by WILLIAM RICHARDS, C.E.; 18mo., Sewed. 20 cents.</p>	<p>GAS CONSUMER'S MANUAL, by E. S. CATHELS, C.E. 10 cts.</p> <p>PRACTICAL TREATISE ON HEAT, by THOMAS BOX. Second edition. \$5.</p> <p>FODELL'S SYSTEM OF BOOKKEEPING FOR GAS COMPANIES. \$5.</p> <p>GAS WORKS—THEIR ARRANGEMENT, CONSTRUCTION, PLANT, AND MACHINERY. \$8.</p> <p>COAL; ITS HISTORY AND USE, by PROF. THORPE. \$3.50</p> <p>THE GAS WORKS OF LONDON, by COLBURN. 60 ce</p> <p>THE GAS FITTER'S GUIDE, Showing the Principles and tice of Lighting with Coal Gas, by JOHN ELDBRED cents.</p>	<p>CORRECT GAS MEASUREMENT; the serious Loss and Incon- venience to Gas Companies and the Public Caused by the Freezing and Inaccuracy of Wet Gas Meters, by GEORGE GLOVER. 40 cents.</p> <p>GAS WORKS, AND MANUFACTURING COAL GAS, HUGHES. \$1.80.</p> <p>A PRACTICAL TREATISE ON GAS AND VENTILATION, with Special Relation to Illuminating, Heating, and Cooking by Gas, by E. E. PERKINS. \$1.25.</p> <p>URIFICATION OF COAL GAS, by R. P. SPICE. 8vo. \$3.</p> <p>GAS CONSUMER'S HANDY BOOK, by W. RICHARDS. 18 mo., Paper. 20 cents.</p>
---	---	--

The above will be forwarded by express, upon receipt of price. We take especial pains in securing and forwarding any other Works that may be desired, upon receipt of order. All remittances should be made by check, draft, or post office money order.

A. M. CALLENDER & CO., No. 42 Pine Street, New York,

T. C. HOPPER, Pres. G. J. McGOURKEY, Vice-Pres. (New York). WM. N. MILSTED, Gen. Supt. & Treas. (New York). WM. H. DOWN Sec.

AMERICAN METER COMPANY,

WET AND DRY GAS METERS. STATION METERS. EXHAUSTER GOVERNORS. DRY CENTRE VALVES. GOVERNORS FOR GAS WORKS.

PRESSURE REGISTERS. PRESSURE & VACUUM REGISTERS. PRESSURE & VACUUM GAUGES. CRESSON GAS REGULATORS. MARSLAND WATER METERS.

METER PROVERS. PORTABLE TEST METERS. EXPERIMENTAL METERS. AMMONIA TEST METERS. BAR AND JET PHOTOMETERS.

Manufactories:
512 W. 22d St., N. Y.
Arch & 22d Sts., Phila.

GAS STOVES,
SUGG'S "STANDARD" ARGAND BURNERS,
SUGG'S ILLUMINATING POWER METER,
Wet Meters, with Lizar's "Invariable Measuring" Drum.

Agencies:
177 Elm Street, Cincinnati.
244 & 246 N. Wells Street, Chicago.
810 North Second Street, St. Louis.
122 & 124 Sutter St., San Francisco.

HELME & McILHENNY.

Successors to Harris & Brother.

ESTABLISHED 1848.

PRACTICAL GAS METER MANUFACTURERS,

Continue as heretofore at the OLD ESTABLISHMENT, Nos. 1115 and 1117 Cherry Street, Philadelphia, Pa.

To manufacture Wet and Dry Gas Meters, Station Meters, Experimental Meters, Meter Provers, Centre Seals, Governors, Pressure Registers, Indicators, Photometers, and all kinds of Gas Apparatus; Also furnish all other Articles appertaining to the use of Gas Works.

From our long Practival Experience of the Business (covering a period of 33 years) and from our personal supervision of all Work, we can guarantee all orders to be executed promptly, and in every respect satisfactorily.

WILLIAM HELME.

JOHN McILHENNY.

WM. WALLACE GOODWIN, Prest. and Treas.

WM. H. MERRICK, V.-Prest.

S. L. JONES, Sec.

S. V. MERRICK, Asst. Sec

THE GOODWIN GAS STOVE AND METER COMPANY,

Successors to W. W. GOODWIN & CO.

1012, 1014 and 1016 Filbert St., Phila., Pa. 142 Chambers St., New York.
126 Dearborn St., Chicago, Ill.

WALDO BROS., Agents, 88 Water St., Boston.

MANUFACTURERS OF THE "SUN DIAL" GAS STOVES, FOR COOKING AND HEATING PURPOSES.

Dry and Wet GAS METERS, Station Meters (Square, Cylindrical or in Staves) Glazed Meters, King's and Sugg's Experimental Meters, Lamp Post Meters, Etc., Etc., Meter Provers (sizes 2, 5 and 10 feet), Pressure Guages of all kinds, Pressure Registers, Pressure and Vacuum Registers, Pressure Indicators (sizes 4 inch, 6 inch and 9 inch), King's Pressure and Vacuum Gauges, Dry and Wet Centre Seals, Dry and Wet Governors, Exhauster Governors, Photometers of all descriptions. Letheby's Sulphur and Ammonia Test Apparatus complete—also Testing and Chemical Apparatus of all kinds, and of the most perfect description, for all purposes relating to Gas.

GOODWIN'S IMPROVED LOWE'S JET PHOTOMETER.

Agents for Bray's Patent Gas Burners and Lanterns.

Special attention to repairs of Meters, and all apparatus connected with the business.
All work guaranteed first class in every particular, and orders filled promptly.

G. B. EDWARDS, Mang'r, New York.
E. H. B. TWINING, Mang'r, Chicago.

D. McDONALD & CO., GAS METER MANUFACTURERS.

(Established 1854.)

No. 51 Lancaster Street, Albany. N. Y.

STATION METERS, EXPERIMENTAL METERS, METER PROVERS, PRESSURE & VACUUM REGISTERS, PRESSURE GAUGES, ETC.

Also STAR GAS STOVES, RANGES, and HEATING STOVES.

We use only the very best materials, and employ the most skilled labor, and by our long experience (29 years) and personal supervision of every detail, we feel justified in assuring the public that our goods will give perfect satisfaction. Every Meter emanating from our establishment will bear the State Inspector's Badge, and will be fully warranted by us. Our Annual and Calendar will be sent to Gas Companies upon application.

KING'S TREATISE ON COAL GAS.

The most complete work on Coal Gas ever published. Three vols., bound, \$30.

A. M. CALLENDER & CO., No. 42 Pine Street, New York.

THE "OTTO" GAS ENGINE.

Guaranteed to Consume 25 to 75
Per Cent. LESS GAS than **ANY** OTHER GAS ENGINE
PER BRAKE HORSE POWER.

TWIN ENGINES Impulse every revolution.
THE STEADIEST RUNNING GAS ENGINE YET MADE.

ENCINES AND PUMPS COMBINED,

For Hydraulic Elevators, Town Water Supply, or Railway Service.

Special Engines for Electric Light Work.

OVER 15,000
IN USE.

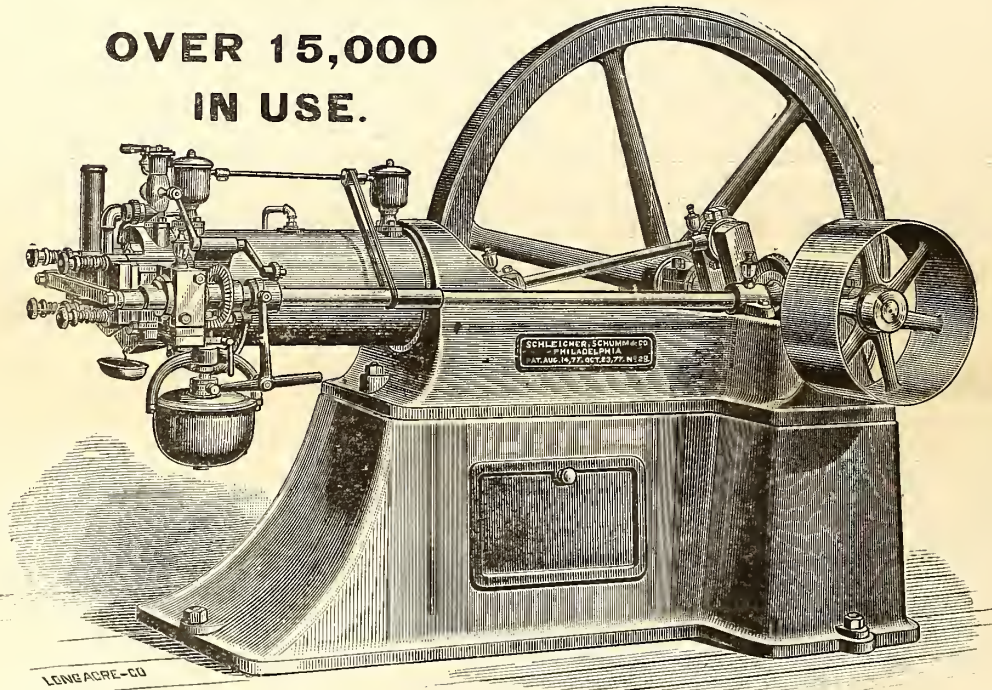

The Otto Gas Engine is now consuming, at a moderate computation, 2000 millions cubic feet of gas per year, nearly all of which is furnished during day time only.

**THE ONLY HIGHEST AWARD, ONLY GOLD MEDAL,
AT ELECTRICAL EXHIBITION, PARIS, 1881.**

MADE IN SIZES FROM 1 TO 25 HP. INDICATED.

FOR PARTICULARS, PRICES, ETC., APPLY TO

SCHLEICHER, SCHUMM & CO.,

Works:

N. E. Cor. 33d & Walnut Sts., Phila., Pa.

Branch Office:

214 Randolph Street, Chicago, Ill.

THE AMERICAN

GAS LIGHT JOURNAL

REDMAN & KENNEDY, N. Y.

PUBLISHING OFFICE No. 42 PINE STREET

DEVOTED TO THE INTERESTS OF ILLUMINATION, VENTILATION, WATER SUPPLY AND DISTRIBUTION, & GENERAL SCIENCE.

VOLUME XLIII.—No. 5.
Whole No. 617.

NEW YORK, MONDAY, MARCH 2, 1885.

{ \$3 PER ANNUM
IN ADVANCE.

A. M. CALLENDER & CO., Proprietors. C. E. SANDERSON, Manager.
JOS. R. THOMAS, C.E., Editor.

ENTERED AT THE POST OFFICE AT NEW YORK, N. Y.,
AS SECOND CLASS MATTER.

Published on the 2d and 16th of each month, at No. 42 Pine Street, N. Y.

Terms of Subscription, including Postage.—For the United States and Canada, \$3 per annum. European countries, \$3.50 (15 shillings—18 francs). All payments to be made in advance. Single copies, 15 cents.

Remittances should be made either by post-office order, registered letter, or bank draft on New York, payable to the order of A. M. Callender & Co.

Collections are invariably made directly from this office, for subscriptions, advertisements, etc. We have agents to solicit the same, but they are not authorized to receipt for money.

Correspondence.—Wishing to make this JOURNAL a gazette of intelligent discussion to those of our readers who may wish to gain or give information on the subjects to which its columns are devoted, correspondence is solicited for publication from all who make the study of those subjects a pleasure or a profession.

Books.—We will mail, post-paid, at publisher's lowest rates, any book—scientific or otherwise—to any address in the United States or Canada. No books will be sent C. O. D.

The American News Company, Nos. 39 and 41 Chambers street, New York, are agents for this JOURNAL. Newsdealers will send orders to them.

CONTENTS.

An Asterisk (*) denotes an illustrated article.

OFFICIAL CIRCULAR—

Annual Meeting Western Gas Association..... 113

EDITORIALS—

Annual Meeting of the New England Association of Gas Engineers 114

A Colorado "Bill"..... 115

Annual Meeting of the Ohio Gas Association..... 115

Fifteenth Annual Meeting of the New England Association of Gas Engineers—Official Report..... 116

Roll Call—New Members—Invited Guests—President's Address.

Lecture on Coal Gas, by Prof. Thorpe..... 118

Special English Correspondence..... 119

The Cleaning of Boilers..... 121

Compressed Oil Gas Illumination..... 121

Natural Gas and its Uses..... 121

An English Establishment for the Storage of Petroleum..... 122

The Petroleum Situation..... 123

ITEMS OF INTEREST FROM VARIOUS LOCALITIES..... 123

Exporting American Engines—Calling for Bids for the Erection of Gas-holders—Giving an Account of His Stewardship—Predictions Verified—Judge Ewing Refuses to Grant the Injunction—Rochester Electric Wires Cause a Fire—Flatbush (L. I.) Street Lighting Squabble—Awarding the Brooklyn (N. Y.) Street Lighting Contracts—Indianapolis (Ind.) Gas Light Company Makes a Progressive Move—Something from Denver, Colorado—Chasing Out the Electrical Promoters—How the Brethren Dwell in Unity—An Electric Freak at Williamsport, Pa.—Once More in the Gas Works Construction Business—Personal—It was only a Hoax—The Stacey Manufacturing Company will Build the Holder—Not the Gas Trust Plant.

Recent Patents..... 125

The Market for Gas Securities..... 125

[OFFICIAL CIRCULAR.]

ANNUAL MEETING WESTERN GAS ASSOCIATION.

SECRETARY'S OFFICE WESTERN GAS ASSOCIATION, {
QUINCY, ILLS., Feb. 16, 1885. }

The Eighth Annual Meeting of the Western Gas Association will be held at Chicago, Ills., on the 13th, 14th and 15th days of May. The matter of a selection of a hotel, etc., is already receiving the attention of the able local Committee of Arrangements, Messrs. Edwin Lee Brown, Peter T. Burtis, and Henry Pratt, and timely notice of their action will be furnished in these columns.

Although nearly three months must elapse before the date of our meeting, I am prompted by several motives in issuing this circular at the present time. In the first place, I wish to inform you that the same zeal and activity in the interests of our Association which have characterized its preparations heretofore are being manifested by our members generally, even at this early day. Flattering as has been our growth in the past, the coming reunion in the great metropolis of the Northwest promises to witness a larger attendance, and a correspondingly larger increase of membership than any of its predecessors. Our Association is now on such a substantial and enduring footing that anything like united action on the part of its members will be a sure forerunner of success; but it is not necessary to tell you that no effort must be relaxed, and no stone left unturned, if we would accomplish all that is to be desired. In this connection I invite, even more urgently than ever before, the zealous co-operation of every member of our fraternity. It has always seemed to me, and I am more forcibly impressed with the reflection now than at any time in the past, that too many of the preliminary details and arrangement of a programme are entrusted to the discretion of the Secretary. Now, while such an expression of your confidence may in itself be pleasing to that official, and though the thought may be gratifying to your Secretary that the many members of our organization are willing to empower him to take such steps as he may deem most fitting for bringing to a successful issue the grand finale, year by year; yet I would respectfully importune you to render me all the assistance possible, not that I have any wish or intention to slight the work in hand, but because I know that with your efficient aid the next meeting will prove more interesting and profitable than any others that have heretofore been held.

Should you ask in what way you can assist me, I would say let each and every one endeavor to present something of interest to the Association at its next meeting. Upon looking over the imposing array of names which constitute our membership, I cannot but be impressed with the belief that there is not one of the number who is incapable of presenting a paper—a bit of information, experience, or suggestion, which would be well worth the attention of his auditors. There are none so old, none so young, none so inexperienced or lacking in ability, but who can contribute, if they will, to the value and importance of our coming meeting. All that I can do in this matter is to ask (and you can rest assured that I shall not be backward in my solicitations), but it remains with yourselves to give.

This, my annual appeal for the preparation of those literary contributions which form such an essential, not to say vital, factor of interest at our gatherings, will meet, I hope and believe, with the same generous encouragement that has seconded my requests in the past. The presentation of papers at our St. Louis meeting was as liberal as their contents were valuable; and I desire to return to their authors my individual thanks for their warmly ap-

preciated efforts in the interest of our Association. They have already received their well-deserved and enduring reward in the vote of thanks tendered to them by the united voice of their fellow members, and by the perpetuation of their interesting contributions in the widely disseminated columns of the GAS LIGHT JOURNAL. At the risk of being deemed too presumptuously persistent, I call on them again to favor us in some shape with their past year's experience. I earnestly urge those (and their name is legion) who have not yet contributed essays on any of the almost numberless topics pertaining to our profession, to devote at least a part of their time during the ensuing ten weeks towards an effort to add to the interest of our meeting. Some labor will be required, and perhaps a certain amount of self-sacrifice may be involved; but you will receive your reward in the commendation of your brother members, and in the enjoyment of the satisfaction of having assisted in no slight degree to the beneficial results of our annual reunion.

It would give me great pleasure to have any member make suggestions, which might profitably be carried out, that would materially add to the pleasure or entertainment of those in attendance. There are doubtless many little matters, but nevertheless important in their way, which, if suggested and adopted, would prove marked attractions to our ordinary routine of business. At any rate, I am prepared to give a respectful hearing to any suggestion that may be offered, and if its acceptance should be found practicable the recommendation shall meet with favorable consideration. There may be members who would like to have a paper presented on some particular subject which would be of special interest to them, and perhaps to many others. If there are any such, and they will take the trouble to inform me of their wishes, I shall gladly endeavor to find a competent author to present the information of which they may feel in need. I invite correspondence with members "all along the line," and every letter of suggestion or inquiry will meet with deserved attention and a prompt response.

Members will confer a favor by notifying me at as early a date as is possible of the titles of their papers. Those desirous of joining our Association can procure blank forms of application by addressing the undersigned.

A. W. LITTLETON, Secretary.

P. S.—Since writing the above I have received the formal report of the committee on the selection of a hotel for our Chicago meeting. Due notice of their action, which I feel confident will be heartily approved, will be given in the next issue of this JOURNAL.

ANNUAL MEETING OF THE NEW ENGLAND ASSOCIATION OF GAS ENGINEERS.

The members of the pioneer American association of gas managers assembled in yearly conclave, for the Fifteenth Annual meeting, on the 18th and 19th days of February last, their favorite trysting place, the famous hostelry known as Young's Hotel, having been once more selected as affording appropriate shelter and suitable provender for themselves and guests. It goes without saying that no mistake was made in such selection, for previous experience of the identical spot had amply tested and completely demonstrated the thoroughness of all the appointments at "Young's Haven."

Having thus descanted upon the attractions of the hostelry, and for fear that we may be voted as paying too large a mead of notice towards the appointments for, and satisfaction of, the mere enjoyment of "creature comfort," the explanation is advanced that the weather was, as our specimen Anglomaniac would likely express it, just "beastly nawsty." A mention of the weather conditions prevailing all through the continuance of the Boston meeting of 1885 leads to the remark that it is hoped those of our Eastern countrymen who have been bewailing the fact that our latter winter seasons have been sadly lacking in the "snap" and "intensity" of their predecessors—degenerating, in fact, from their former frosty royalty—are now satisfied that the Frost King has not entirely deserted these dominions. Snow, close to zero, gloomy rawness, etc., made outdoor exercise anything but pleasant or inviting during the Fifteenth Annual Meeting of the New England Association of Gas Engineers. Perhaps it was better it should be so, seeing that external attractions were less likely to distract attention from the business proper of the sessions.

A pretty general understanding had been arrived at, toward the close of '84, that the principal topic (and one of grave importance to the brotherhood of the New England Association) to claim the attention of the members would be a consideration of the rascally action taken by the Board of Aldermen of the city of Boston with reference to the opposition gas schemes now fairly set afloat within the limits of the "Hub." With this tacit understanding, it was quite well known that the annual assemblage would not be disposed to enter largely into the discussion of technical matters connected with the practical operations of the gas maker's craft; and this determination was sensible and appropriate, when it is remembered that should the Bay State marauders see fit, with the prestige of their Boston victory (if the present

triumph of Messrs. Addicks & Co. over every true and honest business principal may be denominated as such) fresh upon them, to extend their nefarious mode of operations to other cities of the Commonwealth of Massachusetts, it might readily be foreseen that nothing existed to prevent the self-same worthies from casting their net over the other New England States in their noisome efforts to "make a haul." We do not wish it to be inferred that the late session was devoid of value in a technical way. Although but two papers were presented, it can be truthfully asserted that these were of an order calculated to throw light on two subjects which have perplexed, and are now perplexing, the minds of many an engineer and superintendent.

Looking at the technical value of the meeting in another light than that of the presentation of set papers on special subjects, we are especially pleased to note the successful working of the plan which emanated with the resolution adopted at the '84 meeting from a suggestion made by the retiring President, Mr. A. B. Slater. Mr. Slater proposed that the Association appoint what might be termed a Board of Referees, to whom any of the members could, during the interim of the annual meetings, apply for advice and counsel upon any matters that the routine working of their plants should find them unable to cope with. While this proposition did not secure the assent of a majority of those in attendance, Mr. John P. Harbison (who was an active supporter of the plan) came to the rescue by suggesting that it would be well, as long as the Board of Referees were not to be given official existence, to at least order that a "question box" be provided, into which those anxious to have certain troublesome points answered might place their queries; then, when the regular order of business had terminated, the questions were to be read to the Association and the members invited to give their experience on the matters propounded. Mr. Harbison's motion having been carried, its wisdom was amply illustrated at the '85 session, for one of the most noteworthy features of the recent proceedings was the discussion so brought about.

The attendance at Young's on the days of meeting was very large, and goodly addition was made to the list of active members. A marked feature, also, was the number of invited guests present, these latter including Mr. T. G. Lansden, President of the Western Gas Association; Mr. A. C. Wood, of the Central New York Association; and Messrs. Page, Down, Floyd, and Isbell, of New York city, Stanley, of Brooklyn, Davis, of Boston, and many others. Right here it would not be out of place to say that Mr. Armington did the Association a good service when he insisted upon a carrying out of the rule requiring that no one should be admitted into the apartments allotted to the purposes of the Society during the continuance of the business sessions. No gentleman could object to the fairness of that arrangement; indeed, no gentleman would attempt to gain such admittance without first having received an express intimation that he was welcomed as a guest.

President Greenough's address speaks for itself—it will be found on pages 117 and 118. He of course referred to the "opposition" plans of the Bay State and kindred concerns, and spoke of the bill for a State Gas Commission now before the Massachusetts Legislature. He also made mention of the carbonic oxide matter in its relation to the public health, and noted that the State Board of Health were engaged in an exhaustive analysis of that subject. The preliminary report of that body has since been handed to the Massachusetts lawmakers. We have received a copy of it, unfortunately too late for publication with this number; but we may state that its findings are of the most positive sort as against the public policy of allowing water gas to be distributed as an illuminating agent.

The concluding sentence of the report reads as follows: "In conclusion, we may say that our opinion, based upon experiments, is decidedly averse to the general distribution of the so-called water gas, containing, as it does, so large a proportion of carbonic oxide." Profs. Sedgwick and Nichols, the testifying members of the Board of Health of Massachusetts, having no interest in the furtherance of any sort or kind of water gas schemes, have given their opinion in this case—not as the paid "experts" of any particular sort of manipulators, but as the chosen guardians and conservators of the health and lives of the people who hold them responsible to the duties of their public trust. Of a verity, then, now do the gas makers of Massachusetts know where to take their stand. This report will be dealt with at length in our next issue.

The Association re-elected Mr. M. S. Greenough to the position of President; Messrs. J. P. Harbison and A. M. Norton being also chosen to succeed themselves to the office of Vice-Presidents. Mr. Geo. B. Neal, who has held the office of Secretary and Treasurer ever since the organization of the Association, saw fit to declare that he thought he had served the Association for such a length of time as to earn a favor at its hands; and the favor sought for was that the Society would allow him to decline a re-election. While many were inclined to contest this request, it was eventually conceded that the worthy gentleman should have his way. Mr. Stiness, on behalf of the members, paid the retiring Secretary a well-merited expression of approbation at his past course, and regretted the determination which compelled them to accept his declination for a re-election. Mr. Neal responded neatly,

and had the further satisfaction of witnessing the induction to the Secretary's desk and Treasurer's duties of a gentleman well qualified to take up the tasks at the point where his predecessor left them off—Mr. Charles H. Nettleton, of Birmingham, Conn. The papers presented were the following: "The Influence of Steam in the Ashpan," by Mr. C. F. Pritchard, of Lynn, Mass.; "An Experience with Naphthalene Deposits," by Edward C. Jones, of South Boston, Mass.

The Association selected Providence, R. I., as the place for holding the next annual meeting. At 2 P.M. on second day the banquet was enjoyed by the members and their guests, and a pleasantly, hospitable occasion and ceremony was enjoyed to the fullest measure. Owing to the circumstances mentioned by Mr. Greenough in his address, joined to the exceedingly inclement weather experienced, no formal visit to the new plant of the Boston Gas Company was made, although quite a number of those who remained over for the following day (Friday, 20th) journeyed down to Commercial Point, and there made a leisurely inspection of about the finest specimen of a gas plant at present completed in this country.

A COLORADO "BILL."

The infant State of Colorado has often furnished food for thought, and has done so in many curious ways. To commence with, her name, we believe, is derived from the Spanish style of expressing a thing that is red—hence probably the reason why her legislators are desirous of making an attempt at "painting" the gas companies with a stiff coating of legislation like unto the sample given below. Colorado is also noted as having blessed the American agriculturist with that curiously striped insect known to fame as the potato-bug; then, last and not least, not long since one of her then Senators astonished and bewildered the dudes of the country by the simple means of allowing the "society reporters" to make complete examination and exhaustive explanation of the "wondrous beauty, marvelous construction, and exceeding great cost" of his *robes de nuit*. With all these reasons why "Colorado should be rejoiced at her proud position," a certain honorable member of her present House of Representatives, rejoicing in the name of Stuart, thinks that he can still further advance the "fair fame and reputation of his native State" by proposing to enact the following, which he terms, "A 'Bill' for an act establishing reasonable maximum rates to be charged by gas companies supplying cities and towns, and the inhabitants thereof, with gas, and providing penalties for the violation of its provisions." Had he commenced his precious "bill" with the understanding and avowed determination that the enactment was intended to "shut up the plants of existing gas companies in the State of Colorado, and to prevent the future formation of others," he would have been quite near the mark. Candor, however, compels us to say that Mr. Stuart may possibly have his own peculiar notions as to what construction one has a right to place upon the expression, "reasonable maximum rates," since even as though a former brother legislator did see fit to estimate the extent of his senatorial renown by the quality and cost of his night-shirts. The balance of the "bill" is as follows:

"Be it enacted by the General Assembly of the State of Colorado:

"SECTION I. No person, company or corporation supplying the inhabitants of cities or towns in this State with gas for illuminating or other purposes, shall charge, demand, or receive therefor a price to exceed one dollar per thousand feet; *provided, however*, that an additional charge of twenty-five cents per thousand feet may be added thereto where the amount is not paid within five days after statement is rendered.

"No charge shall be allowed or made for meters or use of pipes, or other or different charges than is herein provided for. Any person, company or corporation violating the provisions of this act shall be guilty of extortion, and, upon conviction, shall, for each offense, be fined in a sum not less than \$300, nor more than \$1,000.

"SECTION II. Any company, corporation or individual supplying gas, as provided in the last section, that shall refuse to supply the same on the conditions and at the prices stated in the last section shall be guilty of an attempt to practice extortion, and, upon conviction, shall be punished as provided in the last section; and the District Court, upon proof of such facts, may place the affairs and business of such gas company in the hands of a receiver.

"SECTION III. No person, company or corporation shall be permitted to set up any chartered or contract privilege to charge for the services rendered by them more than their reasonable value, or claim, under any charter or contract, that they have any right to charge unreasonable rates or make unreasonable claims.

"The rates fixed in this act are reasonable.

"SECTION IV. Nothing in this act is to be so construed as to violate the terms of any existing contract where the price of gas is distinctly fixed by such contract.

"SECTION V. All acts and parts of acts inconsistent with this act are hereby repealed."

The "far west" has usually been credited with the reputation of being the proper sphere wherein the talents and energies of our eastern youth might find a chance for quick development and speedy expansion; but Mr. Stuart (provided he can have his way) evidently intends that the gas supply of Colorado shall not be included in the list of avocations open to the enterprising eastern immigrant. Not only so; but, in effect, Mr. Stuart declares

that Colorado can do without gas, unless the benevolently disposed capitalists of that region, blessed with senators possessed of wondrous nightrobes, are inclined to manufacture illuminating gas for the mere charity of the thing. At first blush we were disposed to think Mr. Stuart might possibly have secured an exclusive monopoly of all the Colorado right and title to every known electrical lighting patent (with a first mortgage upon those still buried within the brains of future inventors) and appliance; but the gentleman to whom we are indebted for a copy of the "bill" disposes of that theory, since he writes: "The uninitiated might suppose that next in order would be a bill for an act to establish reasonable rates to be charged for votes of members of the Legislature. This would, however, be a mistake; as it is generally supposed that whatever sum can be gotten is reasonable, and, further, that the maximum has not yet been discovered."

This statement presents a new (and yet an old) solution of the reasons *in ambiguo* within the Stuart "bill."

ANNUAL MEETING OF THE OHIO GAS ASSOCIATION.

The enterprising Ohio gas men who, in August last, gathered together at Columbus for the purpose of discussing the propriety and utility of the formation of a State Association of Gas Managers, were not apt to be misled in their conclusions. The temper of that conference plainly evidenced that the time had arrived when such an organization could be made a fruitful means for advancing the best interests of the Ohio fraternity. When the matter was first brought to our attention, and the names of those connected with the movement were made known, it required but little cogitation to form the opinion that success must inevitably attend the future operations of the proposed Society's acknowledged aims and ends. The history* of the "organization meeting," held at Columbus, Ohio, Sept. 17, 1884, when the Ohio Gas Association became a permanent feature, convinced even the most skeptical that the "infant" Society was bound to make its mark on the history of the craft. It is an undoubted trait of the "Westerner" that, whatever be the enterprise he engages in, he bends his energies and devotes his time to the accomplishment of its purposes, and the First Annual Meeting of the new Association gave every testimony that the Ohio gas man's heart was in his work.

We had previous occasion to express our regret that the date selected conflicted with the time appointed for the New England meeting, and since receiving some account of what transpired at Cincinnati we regret the "conflict" all the more. Not being gifted with ubiquity we journeyed eastward, as was our rightful duty. Mr. Bate's promise that this matter should be corrected has been adhered to, and the Ohio Association will hereafter hold their annual meetings on the third Wednesday in March.

The attendance at the Burnett House on the 18th and 19th of February was extremely large, fully 95 per cent. of the members being on hand, and the membership list was augmented by 20 per cent. It will be noted that Secretary Bate's "official notice" named only one day for keeping up the sittings; but the press of business was so great that before adjournment was reached two days' time had been consumed, an extra evening session being included. Gen. Andrew Hickenlooper presided, and when it is said that the General is one of the best parliamentarians in the Buckeye State enough is told to make it known that he controlled the body with efficiency and skill. His annual address was an excellent one, and in it he dealt largely with the history of the company whose policy he has so long and ably dictated. No less than eleven papers were contributed and read, and it is little wonder that Secretary Bate and the Executive Committee have sufficient reason for congratulating themselves upon the publication of that Tiffin circular† No. II. That circular contained a list of fourteen subjects, upon some one of which assignments were made to certain members who were supposed to prepare short papers in accordance with request of Executive Committee. Not much shirking was indulged in, and the only topics not ventilated in this way were those included under the 2d, 7th, 11th, 12th, and 14th headings. Duplicate papers were contributed on Nos. 1 and 8.

On the afternoon of second day the members, in a body, visited the new and elegant plant of the Cincinnati Gas Light Company; and President Hickenlooper had the genuine pleasure of overhearing a buzzing sound most pleasantly convincing him of what description was the impression made upon the sightseers. Ascending to the hall in the upper portion of the building, directly over superintendents' office and residence (Brother Fullager's quarters), a splendid banquet had been provided, through the hospitality of the Cincinnati Gas Light Company, for the enjoyment of the Society and its guests. How the company's generosity was appreciated needs no mention here. The Society elected the following Board of officers for ensuing year: President, Gen. Andrew Hickenlooper; Vice-President, H. J. Reimund; Treasurer, P. W. Huntington; Secretary, Irvin Butterworth. The retiring Secretary, Mr. Jos. Bate, received a hearty vote of thanks (honestly merited, too,) for his untiring energies on behalf of the Association. A fully detailed report of the proceedings will appear in future issues of the JOURNAL. Before closing this all too brief editorial mention, we wish to extend our thanks to Gen. Hickenlooper and Mr. Emerson McMillin for courtesies received in connection with the Ohio meeting.

* See JOURNAL, Oct. 16, 1884, pp. 203-5.

† See JOURNAL, Feb. 2, 1885, p. 61.

[OFFICIAL REPORT.]

Fifteenth Annual Meeting of the New England Association of Gas Engineers.

HELD AT YOUNG'S HOTEL, BOSTON, MASS., FEB. 18 AND 19, 1885.

FIRST DAY—MORNING SESSION—FEB. 18.

The Fifteenth Annual Meeting of the New England Association of Gas Engineers was held at Young's Hotel, Boston, Mass., on the 18th and 19th days of February last. The Association was called to order at 11 A.M., on date of February 18th, with the President, Mr. M. S. Greenough, of Boston, Mass., in the Chair. A complete report of proceedings of the Fourteenth Annual Convention having been published in the AMERICAN GAS LIGHT JOURNAL, a reading of the minutes of that meeting was dispensed with.

ROLL CALL.

Calling of the roll disclosed the presence of the following named members :

Honorary Member.

Joseph R. Thomas, New York City.

Active Members.

William Yorke, Portland, Maine.	G. L. Manchester, E. Hampton Mass.
L. P. Gerould, Manchester, N. H.	George B. Neal, Boston, Mass.
C. L. Gerould, Manchester, N. H.	C. F. Prichard, Lynn, Mass.
John M. Hill, Concord, N. H.	Edward G. Pratt, N. Attleboro, Mass.
A. M. Norton, Nashua, N. H.	A. D. Perry, Quincy, Mass.
John Andrew, Chelsea, Mass.	J. H. Rollins, Worcester, Mass.
Horace A. Allyn, Cambridge, Mass.	Chas. F. Spaulding, Brookline, Mass.
David Brayton, Brockton, Mass.	W. K. Stratton, Haverhill, Mass.
David Boynton, Chicopee, Mass.	J. Q. A. Spear, Boston, Mass.
F. C. Blood, Ware, Mass.	W. H. Snow, Holyoke, Mass.
George D. Cabot, Lawrence, Mass.	Chas. S. Spaulding, Brookline, Mass.
Oliver E. Cushing, Lowell, Mass.	Aaron Thompson, Woburn, Mass.
David W. Crafts, Northampton, Mass.	William Tarbell, Waltham, Mass.
John Cabot, Lawrence, Mass.	Dudley D. Tilton, Newburyport, Mass.
Patrick Coyle, Charlestown, Mass.	J. R. Todd, Natick, Mass.
William B. Durfee, Fall River, Mass.	Robert B. Taber, New Bedford, Mass.
Wm. B. Durfee, Jr., Fall River Mass.	A. W. Tarbell, Waltham, Mass.
F. R. Davis, Athol, Mass.	Gideon Wood, New Bedford, Mass.
M. S. Greenough, Boston, Mass.	L. W. Wells, Roxbury, Mass.
Estes Howe, Cambridge, Mass.	*Jas. H. Armington, Providence, R. I.
J. L. Hallett, Springfield, Mass.	Samuel G. Stiness, Pawtucket, R. I.
Edward Jones, Boston, Mass.	William A. Stedman, Newport, R. I.
Milton Jewett, Clinton, Mass.	A. B. Slater, Providence, R. I.
Edward C. Jones, Boston, Mass.	Ogden Gilmor, Norwich, Conn.
H. B. Leach, Taunton, Mass.	John P. Harbison, Hartford, Conn.
Charles D. Lamson, Boston, Mass.	Everett C. Learned, New Britain, Ct.
W. A. Learned, Newton, Mass.	Chas. H. Nettleton, Birmingham, Ct.
David Moore, Salem, Mass.	F. C. Sherman, New Haven, Conn.
A. H. Parker, Bangor, Maine.	H. A. Atwood, Plymouth, Mass.
John Burnham, Boston, Mass.	J. A. Coffin, Gloucester, Mass.
Z. M. Jenks, Woonsocket, R. I.	

NEW MEMBERS.

The Secretary—The following-named gentlemen having made application in due form to be admitted as active members of the Association, their applications were presented to the notice of the Board of Directors, acting as an Executive Committee. The aspirants for membership include Messrs. C. J. R. Humphreys, Lawrence, Mass.; W. A. Wood, Boston, Mass.; A. H. Norton, Nashua, N. H.; A. T. Cooper, Exeter, N. H.; and A. M. Copp, Boston, Mass. They all are possessed of the requisite qualifications for admission to this Association, and in consequence thereof the Executive Committee concur in unanimously recommending the names for affirmative action.

Mr. Stedman—I move that the usual course be taken in regard to the election to active membership of the gentlemen named.

The President—It is moved that the Secretary be authorized to cast the ballot of the Association in favor of electing the applicants for membership reported upon by the Executive Committee.

The motion was agreed to. The Secretary carried out the instructions of the President, and made a verbal report to the Chair, in which it was stated that the applicants for membership had been unanimously elected.

The President—The unanimous ballot of the Association having been cast for the admission to membership of the gentlemen already named, I declare that they have become, and are now, entitled to all the rights and privileges of this body. The Association is very glad to welcome them.

Mr. Harbison—Before the President's Address is presented, permit me to

* Now President of Brooklyn Gas Light Company, New York.

say that there are some gentlemen who are connected with gas interests, some of them being officers and members of associations other than the New England, who are in this city. Now it appears to me that it would be well to extend to these brethren our hospitalities and courtesies while they are here, and in accordance with that idea I move that a committee be appointed to invite these visitors to attend our sessions, so that they may become witnesses of our proceedings.

Mr. Stiness—I second that motion.

The President—It has been moved and seconded that the gentlemen visiting this city, who are officers or members of kindred associations, be invited to attend the sessions of this Association; also that a committee be appointed to invite such visitors to be present.

Mr. Armington—I move, as an amendment, that the names of the gentlemen who are to be invited be placed before the Association previous to their being informed of such action.

Mr. Harbison here explained that he had special reference to Mr. A. C. Wood, of Syracuse, N. Y., and Mr. T. G. Lansden, of St. Louis, Mo. The President suggested that Mr. Harbison's resolution should specify the gentlemen last named by him. Mr. Nettleton intimated that the name of Mr. G. S. Page, of New York, should be included.

The President then spoke as follows: This leads to a matter of interest to this Association that may as well be disposed of now as at any other time. Various things have been said to me (by members) with regard to the invitations which have at times been extended by this Association to gentlemen who are in no way connected with the profession, either as engineers or in any one of the cognate or allied branches of our common industry. I think that nine men out of ten who are properly connected with our profession are always welcomed by every member of the Association; but there are some gentlemen who have been present at various meetings of this Society, with whom some of our members say they do not wish to be associated at these annual gatherings; and now, in short, it is proposed to stop this objectionable attendance. I think you will agree with me in this matter. There is only one way to effect this purpose. The following practice was suggested to me, and I believe it to be a proper one: It is proposed that if any member desires to invite a friend (one in any proper manner identified with the profession) to attend a session of this Association, he should submit the name of that friend to the consideration of the Executive Committee, to the end that that Committee may report such name to the Association; and then, should no objection be made, the gentleman so reported upon may be invited to be present. If any member wishes to object to any outsider's attendance here, I think the objector has the right, and should be granted an opportunity, to speak his mind. I believe we may just as well settle the question now. We certainly do not want to make any inhospitable movement at the present time; but it seems to me, between now and the time set for the afternoon session, members wishing to invite friends to be present at this meeting should hand the names of such gentlemen to the Secretary, to the end that they may be laid before the Executive Committee and be passed upon by that Committee before they are invited to attend our sessions. That appears to me to offer a plan by which the matter may be arranged. I shall be glad to hear from Messrs. Armington, Nettleton, and Harbison if this suggestion meets their views. The remarks I have made express the sentiments of some of the gentlemen with whom I have conversed on this topic. I would like to hear from others.

Mr. Harbison—As a member of the Executive Committee I agree with what has been said by the Chair. I think the course outlined by the President is the proper one to pursue.

The plan proposed by President Greenough having proved entirely acceptable, those members who wished to invite a friend or friends to witness the proceedings handed in to the Secretary the names of those whom they desired to introduce. When the names had been formally forwarded, President Greenough announced the following list as embracing the gentlemen whom various members proposed to invite to the sessions:

W. H. Down, New York city.	F. J. Davis, Boston Mass.
H. H. Fish, Utica, N. Y.	F. W. Floyd, New York city.
C. C. Fry, Lynn, Mass.	C. W. Isbell, New York city.
G. F. Kreischer, New York city.	T. G. Lansden, St. Louis, Mo.
C. H. Newhall, Lynn, Mass.	G. S. Page, New York city.
James Porter, Greenfield, Mass.	I. N. Stanley, Brooklyn, N. Y.
J. M. Tyler, Cambridge, Mass.	A. C. Wood, Syracuse, N. Y.

After the reading was concluded the President inquired if any objections were to be offered to any name on the list.

Mr. Armington—I do not wish to debar any one of those gentlemen from coming in here at the present time; but I will say that I believe our present action is a most business-like proceeding. I think, Mr. President, that either you or I, or any other member, has an undoubted right to say who he would like to have enter his house, either in a social, business, or any other sort of way. This Association has been in existence for a number of years, and, on certain occasions, I think its privileges have suffered abuse.

We know that some other Associations, and with which some of us are also connected, are very (and properly so) strict about these things. This Association was founded for the carrying out of specific purposes, and not for the purpose to which it has been put in times past by certain individuals. My idea in offering the amendment to Mr. Harbison's motion was simply to obviate a repetition of similar schemes. I further hope that the new course of procedure here instituted will be made an imperatively binding rule, so that hereafter no gentleman will think he can enter the door of our meeting-room unless he has been especially invited to do so (after his name has been presented to the Association), and it has been found that no objection exists to the extension of an invitation to him. I am free to say that at least one individual has attended these meetings who will unseat me if the future should continue to admit him here.

The President—The question now is upon the extension of a unanimous invitation to the gentlemen previously named to attend this meeting of the Association. Do I hear a single objection to any name on the list?

No objection having been offered, the Chairman announced that the Association would be very happy to receive the visitors.

The next business in order was the reception of the

PRESIDENT'S ADDRESS.

President M. S. Greenough then delivered the following inaugural message:

Gentlemen of the New England Association:—To expect from me on this occasion a carefully written address would, I think, be almost as unreasonable as to require from the Commandant of the English forces in the Soudan an elegantly compiled disquisition on the "Art of War." You will, I know, bear with me if the press of urgent business has prevented me from giving to this matter the thought and time which it really demands, and now compels me to bring before you the questions on which I desire to speak in such a fashion as I have best been able, but not as I should like to present them.

The history of the gas business throughout New England during the past year, has, in one sense at least, been uneventful. No company's works (so far as I am aware of) has been the scene of any great disaster. No member of our Association (so far as heard from) has, within the past twelvemonth, discovered—for the thousandth time—that process of manufacture which was sure to revolutionize the present methods, and prove a fortune to all concerned. In this part of the country a steady increase in business, and cheapening of first cost, has enabled most of the companies to materially reduce the price to the consumer—a reduction which has been received with that gratitude and appreciation which might, perhaps, have been expected. It would have been impossible to secure stronger petitions than those which have been collected for a new gas company in Boston if the selling price of gas had been \$2.50 instead of \$1.50; and the stories of the enormous profits which we are making, at the latter price, seem to be as readily believed.

The year has been a notable one, however, to the Boston Gas Company in other respects. We have started a set of coal gas works which have differed much from the ordinary works hitherto in use. In building them it was our intention to construct a retort house which should largely be run by machinery. We have been in hope that we should be able to-morrow to invite the Association to visit Commercial Point and there see in operation apparatus which would break, elevate and distribute the coal in bins, in the center of the retort house, from which it would run, by gravity, into a hydraulic charging machine which should put it into the retorts. A Ross discharging machine then draws the coke, so that it falls into the cellar on cars, where it is quenched; the cars are then lifted upon a hydraulic elevator to an appropriate level, where they can either be emptied upon the coke pile, or discharged into other cars whose duty it is to supply the fuel with which the furnaces are to be charged.

I am sorry to say that that expectation cannot be realized. A large portion of the apparatus there being new in design, difficulties have arisen in its use which could not have been anticipated, nor consequently provided against, until they were developed or discovered through the working test of actual experience. The coal elevator and breaker are all right, but the distributor has several times broken at precisely the same place; and now that it has been reconstructed on a new plan, an accident has happened to the engine that runs it. Without the distributor we could not use either the coal bins or the charger, so that all we have to present to your notice at Dorchester is much like what can be seen elsewhere, except as to general plan of arrangement.

I am greatly pleased to be enabled to bring to your attention the satisfactory working of our generator furnaces. We charge them with wetted coke, and also distill a large quantity of steam from the ashpans. The furnaces are cool, but the retorts can be brought to any required heat. We charge each retort, every four hours, with 333 pounds of coal, and make about 9,500 cubic feet of gas to the mouthpiece in twenty-four hours. It takes about 50 bushels of coke a day to work this off. This approximates closely to 22

per cent., by volume, of the coke made; or it means about 15 lbs. of coke to work off 100 lbs. of coal. This, on the whole, is as good work as can be expected without more expensive recuperation than I think would be profitable to enter into; and, in fact, the value of regenerator furnaces in any shape or form must be largely affected and determined by the price of coke in the locality under consideration.

It may be of interest to submit to you an analysis of the gases from the furnace and in the outlet flue:

From Furnace.		Outlet.	
CO ₂	7.29	CO ₂	17.58
CO.....	31.48	O.....	3.56
H.....	9.98	H.....	
N.....	61.25	N.....	78.86

This shows the result of the use of steam in the furnace. In no other analysis which we have made have we ever found free hydrogen.

The outlet gases showed a slight excess of air at the time of the analysis; but this might have varied on other occasions when the coke in the furnace was at a slightly different height. At any rate, the results are satisfactory enough.

The really interesting questions, however, to us in Boston, Massachusetts, are not so much at present involved in the details of the thoroughly skilful management of a gas works; but they are instead—whether we are to continue to transact our business at all, and, if so, under what conditions?

The Association will probably remember that in October last, after the case of the Consumers Company had been apparently settled against its promoters, I offered an order, in my position as Alderman of the city, providing for a petition to the Legislature by the city of Boston asking for the appointment of a Gas Commission. I believed then, and have discovered no reason since to change my mind, that such a Commission would afford the most satisfactory solution of the present unpleasant condition and standing of affairs. In every community in which gas is sold there always exists a certain easily discoverable percentage of dissatisfied consumers. On this number the question of price has no effect. There is as much grumbling in Boston, with gas at \$1.50, as there was in New York with the same commodity at \$2.25. These discontents are not satisfied with any condition of affairs in a business so mysterious as those with which are conducted the operations of gas companies. Nothing can persuade them that the profits of gas companies are not enormous.

A number of years ago my father was sent for by the then Mayor of Boston and told that he had been informed that the profits of gas making were so enormous that the city, by acquiring possession of the gas works, could pay all its running expenses. The worthy mayor was somewhat surprised to learn that his informant was considerably in error, for the gross receipts of the company at that time were not over one-half million of dollars.

If any city in this country (as some municipalities have done) should see fit to purchase the rights and property of existent gas corporations, and would operate them with even a moderate degree of regard for the public good, there is no doubt that in many cases it might prove of public advantage. The most entire publicity would, of course, be given to the business; the public could, at all events, fix its own price, and the city could borrow money at lower rates than any private citizen would be content to risk his capital for. That suspicion of jobbery, however, which haunts the administration of so many public trusts in this country, makes the public unwilling to put into such hands as now hold the reins of power in many cities such a further opportunity for speculation. The management of the Philadelphia (Pa.) Gas Trust has been a standing warning against such a course.

The next best thing to a city's running its own gas works is to have proper supervision exercised over the existing companies; and, as I have said before, a measure looking in that direction is now under consideration by the Legislature of Massachusetts. It comes before them on the petition of the city of Boston, and the order for that purpose was offered by myself, as an Alderman, last year, after the question of competition had been apparently settled in our favor. It could not, of course, have been reasonably anticipated that two members of the Board of Aldermen would eat the words of their own report, and, without any explanation whatever, reverse their previous action. I have yet to hear of any explanation—save one—which could in any way account for such behavior.

As matters stand at present, the interest which the Boston companies have in a Commission is materially lessened. If we are to remain monopolies in our respective districts, we of course have duties corresponding to, and commensurate with, our privileges. The public is right in demanding that it shall be supplied with good gas as cheaply as the circumstances of each company will permit; and it has also the right to know that this is a fact. No company, it seems to me, which is doing a legitimate business, and not exacting an improper price for its gas, can object to such proposal—provided it is accompanied by a due degree of protection. If the protection against competition is withdrawn, there is, of course, no reason why our affairs should be inspected. If the gas business is to be thrown open to all comers, then such investigation of private affairs becomes an impertinence.

As I write at present I do not know what may be in store for us in Boston. If we are to have competition, I take no special interest in the passage of the bill; if we are to be left alone in the possession of our franchise, I hope it will pass, as I know of no other way in which the public and the company can both be so well served and protected. It may, however, be of interest to the members of this Association from the State of Massachusetts to know that the philanthropist who proposes to benefit Boston by competition does not intend to confine himself nor his operations to this locality. He has asked for a capital of five millions of dollars, and asserts that it is for use all over the State. In Boston he has not offered to furnish gas of any specified quality, nor at any stated price. He has simply offered the *benefits* of competition, and his order passed the Board of Aldermen; so that you, gentlemen, can readily see how little protection it may be to you to sell good gas at a low figure when such seductive advocates appear before your City Councils.

The proposal for a Commission is practically this, if amended as proposed by us—that no company which shows its figures, and accedes to the recommendations of the Commissioners, shall be troubled by competition; for the assent of the Commissioners must be given to enable the institution of a rival works, and that permission would not probably be obtained. I should be pleased to have this Association express itself in no uncertain way, and hope some action will be taken at this meeting on the subject.

The fact that any company differs from the position taken by the Boston companies last year, in regard to water gas, need in no way affect his own in this matter; for it is, of course, to the interest of any existing company to preserve its monopoly; and should water gas possess all the attributes that its advocates claim for it, it will be easy to persuade the Commission of its advantages.

This brings me to the question of water gas, and on it I should like to say but a few words. If an advocate of its use says that carbonic oxide is so good a thing in gas that you cannot have too much of it—that all this talk about poisoning is moonshine—then I admit that I am compelled to doubt either the intelligence or the good faith of such a person. If, on the other hand, he says, "I admit what you say about carbonic oxide being a blood poison; I admit that accidents occasionally will happen from its use which would not under similar circumstances have been caused by coal gas; but as an offset to that I can either give you as good light as you are now getting, at a large reduction in cost, or, for the same money, I can give you a light of much greater brightness; gas is made to burn, not to breathe; and a great improvement is rarely introduced into society without subjecting it to some additional risk"—to such a person I am entirely willing to talk; and I consider it a fair presentation of his side of the case. It reduces the question to the simple business basis of "how much risk ought to be taken if a better article can be given"—it having first been proved that there is any advantage in that direction. This last, again, becomes a question of locality, dependent upon the relative cost of the materials from which the two gases are made, and the value of the coal gas residuals—which varies greatly.

Other things being equal—*i. e.*, if the cost of each kind of gas is the same—then I do not consider that a single life should be risked; but if a saving of 15 or 20 cents a thousand can be made—then what is our duty?

As the law of Massachusetts stands at present, it is no more criminal to have 20 per cent. of carbonic oxide in your gas than it is to have 15 grains of ammonia per 100 cubic feet. If it is the poison that it has been claimed to be, then it ought to be more rigidly pronounced against; if not, then it ought to be struck out of the list of impurities. The matter is at present before the Legislature, and the State Board of Health has been requested to report upon it. Their report, which is promised, at least in part, for next week, will be looked for with interest, and the future position on which we all are to stand may be much affected. If in the judgment of the Legislature there should be no restriction on this quality of gas, we shall then be entirely freed from any responsibility in the matter, and can make water gas freely if it seems pecuniarily advisable; but in the present undecided condition of affairs I am loath to recommend any gas which is going to largely increase the percentage of what is known to be a most virulent poison when inhaled.

If the report of the State Board is made, as promised, next week, we shall soon know where to take our stand.

Mr. Stiness—I suppose there is no member of the Association who fails to fully appreciate the position our Chairman has occupied during the past few months. I move that we pass a vote of thanks to him for the paper which he has presented to us to-day; and as there are some recommendations embodied in the message which we will desire to discuss when there is proper opportunity, I also move that the paper be laid upon the table until we shall have leisure to take it up, and give a thorough consideration to the suggestions which he has made.

The President—You have heard the motion made by Mr. Stiness—that the message be laid upon the table, and that it be taken therefrom and discussed at a later hour.

The motion was agreed to.

[To be continued.]

Lecture on Coal Gas, by Prof. Thorpe.

Gas and Water reports that on the evening of Wednesday, February 4th, Prof. Thorpe, F.R.S., of Leeds, England, delivered the second of two popular lectures upon the manufacture of gas and its economical consumption, in the Lecture Hall of the Yorkshire College. Having pointed out that the character of the finished product depended, among other things, upon the nature of the coal used in the manufacture, upon the temperature employed, and upon the care spent in the process of purification, the lecturer went on to explain the chief characteristics of coal gas as it is delivered in the houses of consumers. He might take it that London and Manchester gas fairly represented the quality used in the larger towns of England. As shown upon the diagram which the learned professor referred to, coal gas was substantially a mixture of hydrogen, marsh gas, and carbonic oxide; but the substances to which the true illuminating power of the gas was due were classed under the generic term, olefiant. His audience, he said, would see that the hydrogen was fairly constant, varying from 46 to upwards of 50 per cent. of the volume of the gas. The amount of marsh gas was approximately the same in the three samples on the diagram; the amount of carbonic oxide varied between 5½ and 7¼ per cent., and the amount of olefiant varied from 3½ up to 7¼ per cent. The greatest variation, therefore, was in the class of bodies which were classed together as olefiant. In addition to all these there were varying amounts of nitrogen, carbonic acid, and more or less of sulphuretted hydrogen. Some of these ingredients contributed nothing at all to the illuminating power—indeed, those which were present relatively in the largest proportion, had nothing whatever to do with the light-giving power of gas, but they had a great deal to do with its heat-giving properties, and they served, in addition to that, the useful purpose of being a sort of medium in which the light-giving constituents were suspended and properly burned.

By experiment the speaker demonstrated the non-luminous properties of hydrogen gas, the more luminous power of marsh gas, and the beautiful blue flame of carbonic oxide. Then he took a quantity of olefiant gas which he showed burned with a bright but smoky flame. Under this title he also showed the flame given forth by acetylene—a compound which, he said, was present in every gas, and more especially in gases which had been formed at a high temperature. It burned with a smoky flame, was rather difficult to kindle, and it was highly poisonous to breathe. But in addition to these light-giving constituents there were benzene and certain other hydrocarbons which belonged to the same chemical family. By some authorities it was stated that the greater portion of the light giving power of many gases was due to the diffusion throughout them of the vapors of benzene. By a simple experiment the speaker showed his audience how this vapor, even in the most minute quantity, added to the luminosity of a hydrogen flame. In a bottle to which he had two tubes with burners, he, by means of sulphuric acid and zinc, liberated hydrogen. Through one of the tubes hydrogen alone was allowed to pass, and it burned with a non-luminous flame; but in the other tube the hydrogen had to pass through cotton saturated with benzene, and at this burner, when a light was applied, a highly luminous flame was produced. This experiment showed how hydrogen took up the benzene vapors and carried them to the point of combustion.

The lecturer afterwards drew attention to the deteriorating effect of carbonic acid upon the luminosity of the other constituents of coal gas, and said that a small proportion of it would destroy the illuminating power by many per cents., and for this reason gas manufacturers wanted to get rid of every trace of it. He next directed attention to the different temperatures which were necessary to bring about illumination. Some gases burned at a low and others at a relatively high temperature. There was, in fact, for every gas a specific temperature at which alone it would ignite. Some gases burned when brought into contact with the air, and others required to be heated before chemical combination could be initiated, and the amount of heat varied with each particular gas. He demonstrated this by various experiments, and particularly showed that it was difficult to ignite marsh gas by means of the electric lighter—the temperature of the spark not being sufficiently intense. Dwelling upon this point Professor Thorpe explained to his audience that, in days long anterior to the invention of the Davy lamp, miners excavated coal by means of the feeble rays emitted by bringing a revolving wheel in contact with flint. A series of sparks were thus produced which enabled the miner to pursue his work, and which were yet not so intense as to ignite any marsh gas in the neighborhood.

Putting the facts which he had explained together his audience would see that the different constituents of coal gas did not ignite with the same readiness, and that they did not burn at the same rate. When a light was presented to a gas flame what really occurred was that the hydrogen was ignited, and the high temperature of the burning hydrogen ignited the marsh gas, and so combustion was determined. As they might readily perceive the gases composing the flame could not be all burning at the same rate—some burned faster than the others. Speaking generally, it would be found that

the first to burn was the hydrogen, and then, at a certain stage, the marsh gas was ignited, and the result of the decomposition was watery vapor and carbonic acid. The olefants suffered a number of changes. First they broke up into simpler hydrocarbons, with a separation of carbon, and it was this carbon which contributed most to this luminosity of the flame—the heavier hydrocarbons broke up into simpler hydrocarbons, and finally split up into carbonic acid. A great deal was yet to be discovered with reference to the luminosity of a flame.

Having pointed out that the main facts connected with it were discovered by Sir H. Davy, he went on to show that the light-giving property of a candle was due to the presence in it of solid carbon; that in the process of the distillation of the fatty matter the heavy hydrocarbons were resolved into simpler ones, and that the temperature caused these to radiate light. The idea that the light-giving power of the flame resided simply in solid matter had been controverted in recent times. Dr. Frankland had drawn special attention to facts which, he thought, were inconsistent with the notion that the light-giving power of all flames was solely due to the presence of solid matter. He (the speaker) had only to say that when hydrogen was burned a flame of very little luminiferous value was got; but if it were burned in a stream of highly compressed air a very bright light would be obtained. Now, in this gas there was no suspicion of solid matter, and the resulting product of the combustion was gas. This fact, he mentioned, was inconsistent with the general hypothesis that the light-giving character of the flame was due to the incandescence of solid matter. Dr. Frankland put forth the hypothesis that the light-giving character of the flame was really connected with the density of the gases which were undergoing combustion. Now, the ordinary proofs that there is solid matter in a candle or in a gas flame were that it could be got out of them. Every one knew that when a cold object was brought in contact with a flame there was a deposit of soot. Dr. Frankland, however, had shown that soot was not pure carbon, but that it contained a certain amount of hydrogen—as much, indeed, as was present in certain well-authenticated hydrocarbons. But it was pointed out that a gas flame was transparent. A newspaper could be read through it, and this fact seemed to be inconsistent with the idea that there was solid matter between the eye and the object looked at.

The facts adduced to controvert Dr. Frankland were that if soot was a hydrocarbon existing in the vapors contained in the flame, chemists ought to be able to reconvert it to vapor by heating it to a high temperature; yet no temperature which they had been able to command had been sufficient to vaporize soot. Dr. Frankland supposed that the soot called hydrocarbon was simply due to the reaction consequent upon the introduction of a cold body to the flame; but he (the speaker) had to say that if a hot body instead of a cold one were used a deposit of soot would still be obtained. Then, he argued, the transparency of an object was no test whatever. Looking at any object an impression was got on the retina, and if there was passed between the eye and the object a solid body, at sufficient velocity, the image on the retina would still subsist. But then, again, a candle flame, or any other luminiferous flame which owed its luminosity to the burning of hydrocarbons, threw a shadow if a stronger light, such as the sun, shone upon it; and it would be seen upon observation that the shadow was strongest from those parts of the flame which would give the greatest quantity of soot. This proved that solid matter was present. If it was altogether pure gas there would be nothing to stop the rays of the more powerful light, and consequently there would be no shadow.

At some length the speaker explained the method of calculating the relative value of gas light, and described the various photometers in use for making the tests; and thereafter he dwelt upon the nature of the sulphur impurities which were to be met with in ordinary coal gas. Sulphur existed as sulphuretted hydrogen and as the bisulphide of carbon, and possibly in a third form as a compound which was known to chemists under the name of phynl-sulphocyanide. There was reason to believe that the peculiar smell of coal gas was due to the dissemination of small quantities of this compound. He then explained to the audience the various tests that were made for sulphur compounds as well as for ammonia; and having given an analysis of Leeds gas supplied by Mr. Fairly, the speaker proceeded to remark upon the economical consumption of gas.

Upon this point he said that a gas manager might be at infinite pains to make good gas, and his efforts might be thrown away by ignorant and wasteful burning. His experience was that the cause of complaints as to the quality of gas leveled against gas managers was due rather to the consumer himself. Gas was usually very much better than it was represented to be by those who burned it. He showed from public statistics how much good gas was reduced in value by the use of bad burners, and how necessary it was, therefore, to obtain burners adjusted to the qualities of gas used in different parts of the kingdom. This question, he said, was important, not only on account of the inadequate return for our money in the shape of light, when bad burners were used, but also from a health point of view. The more perfect the combustion of gas in rightly adjusted burners, the

better the light, the fewer the burners required, and the vitiation of the atmosphere would be proportionately reduced.

Through the kindness of Mr. Bray, the lecturer said he was able to show a variety of burners, from the original rat-tail to the most modern slit union and batswing. The construction of the various burners was explained by means of diagrams and sections, and their action was practically illustrated—a splendid effect being produced by lighting one of Bray's 2,000-candle power clusters. The lecturer then went on to say that it had been determined by photometric observations that for each particular burner there was a given pressure of gas, and manufacturers had aimed to regulate their burners to meet specific pressures. Consistent with giving a burner its proper quantity of gas, as low a pressure as possible should be used. This enabled the flame to acquire its proper shape. While he said this he mentioned that there was a good deal of uncertainty as to the conditions under which gas burned. Mr. Bray doubted whether low pressure had anything to do with obtaining the best results. No doubt, under certain circumstances, low pressure meant something; but there must be added to that the relative thickness of the flame, which Mr. Bray thought modified to some extent its light-giving properties. A great deal of information was wanted regarding the physical condition of gas as it issues through the narrow aperture at the point of ignition. Although the gas was at a low or a given pressure before it reached the narrow aperture, it did not follow that it had the same pressure when it emerged to the open air. The lecturer illustrated his point by describing the action of the Bunsen burner. In this burner, when the gas issued from the aperture to enter the upright tube, it expanded very considerably; and in virtue of the low pressure which prevailed, and the upward tendency of the gas, air was dragged in, and both agents were at work. A somewhat similar action prevailed in the ordinary case of gas burning; so that the gas at the point of ignition was not exactly in the degree of tension which existed further to the rear—the particles were relatively at greater distances one from the other. This was the condition which he believed existed, and it had not, apparently, been recognized by people who had discussed the various conditions of luminosity. Whatever might be the theory, suitably constructed modern burners did check the flow of gas. In Mr. Bray's burners, as might be seen from the reports made to the British Association, there was this checking action.

In his concluding observations Professor Thorpe made a brief reference to the use of gas as a fuel, and he showed one of Mr. Wilson's (of Leeds) newest forms of heating stoves in operation.

The lecture was listened to with much interest, and during its delivery Professor Thorpe was frequently applauded.

SPECIAL ENGLISH CORRESPONDENCE.

COMMUNICATED BY NORTON H. HUMPHRYS.

SALISBURY, Feb. 10, 1885.

The report and statement of accounts of the Gas Light and Coke Company for the half year ended, Dec. 31st, 1884, have just been issued to the shareholders in anticipation of the usual half-yearly meeting which is to be held on the 13th inst. This company supplies the principal portion of the city of London—that situated on the north side of the river Thames. The report on this occasion introduces a noticeable innovation, and one that will be generally welcomed as a great improvement. Formerly it consisted simply of a report from the directors, signed by the chairman; but now it comprises four sections, viz., the usual director's report, one from Mr. G. C. Trewby, the constructing and carbonizing engineer-in-chief, respecting his department, a return from the distribution department, by Mr. Robert Harris, distributing engineer, and a brief note as to the products department, by Mr. Thos. Wilton, superintendent of the products works. Having on former occasions observed that this company, in their reports, have scarcely given sufficient prominence to the technical and engineering talent which has mainly been instrumental in building up this colossal undertaking in its present highly prosperous and substantial condition, it is with pleasure that the writer refers to this innovation as one worthy of being followed by all similar undertakings of unusually large extent and importance. The directors' report states that the profit earned from all sources during the six months is £509,261, which will admit of the payment of a dividend at the rate of 12 per cent. per annum, an addition to the reserve fund of £13,606, and will leave a small balance in hand. A reduction of 2d. per 1,000 cubic feet in the price of gas consumed in the public lamps, viz., from 2s. 8d. to 2s. 6d. per 1,000 cubic feet (from 64 to 60 cents) is also announced, the rates to private consumers remaining as before. Perhaps it would be rather uncomplimentary to the local public authorities that this is "throwing a sop to Cerberus;" and the question of the claims of ordinary private consumers as compared with those of local authorities is too complicated to be entered upon here. Mr. Trewby remarks that since the date of his appointment in March last no additions of special importance have been made to the company's plant;

and that during the present winter ample power has been at all times available to meet any probable increase in the consumption of gas. The third paragraph of the report is worthy of special notice. It is as follows: "Particular attention has been given during the half year to allocate as much manufacture as possible to those stations where gas can be most economically produced; or, in other words, the more expensive manufacturing stations have been limited, as far as possible, in their production." Of the dozen or so different stations situated in various parts of the metropolis it is obvious that some must be more favorably situated than others for the economical production of gas, and that on account of several different causes. They may offer better transit facilities for the delivery of the coal to the front of the retort, or for the delivery of coke to the purchaser; or new apparatus on modern principles may have been erected of much greater productive capacity, as compared with the worn-out plant which it has replaced. But few undertakings attain such magnitude as to admit of the application of this principle, which must be regarded as the latest experiment in modern gas engineering.

Some economy is noticeable in the manufacturing charges, probably as the result of applying the above plan. Although 8,125 millions cubic feet have been produced, as compared with 8,001 millions produced during the six months ended Dec. 1883—a respectable increase of 124 millions—the costs of coal, salaries, wages and purification have each been slightly reduced; and an important diminution of over £45,000 has been made in the cost of repairs and maintenance. Mr. Harris has also effected some economy to the extent of four or five per cent. in his department. He reports that the total length of the company's mains is now 1,755 miles; 3,585 new services have been laid; but the net addition to the number of meters is only 1,293. Why there is not a larger increase in respect to meters is not very obvious, since each new service presumably requires a new meter. Perhaps the services also include those laid in place of previously existing but nearly worn out ones, as well as *bona fide* new and additional services. An important increase of no less than 24 per cent. has been effected in the number of gas stoves let on hire, which has now reached the respectable figure of 3,653. This, of course, does not include stoves which are the property of consumers. An increase of 5.2 per cent. in the number of gas engines is recorded, and this now stands at 949. Mr. Harris and his colleagues have evidently been busily employed during the half year.

The working results are satisfactory. The average yield of gas per ton of coal carbonized is about 10,230 cubic feet, equivalent to 4.56 cubic feet per pound of coal; and of the gas made more than 93 per cent. has been duly "brought to book," 1½ per cent. having been used on works, and 5½ per cent. is unaccounted for. To this should be added that the returns of the examiners show that the gas supplied has been well above the standard both in respect to illuminating power and purity.

From the affairs of this enormous concern we will turn, by way of contrast, to those of one of the smallest. This company has a capital of £5,000, and supplies the needs of about 200 consumers in a district of 6,000 inhabitants, and may be taken as a fair example of the working of small gas works in this country. The receipts for gas during the past year are £1,161, and the amounts received for coke, tar, rents, etc., bring the total receipts up to £1,359. The expenditure, in which the item for coals figures as £440, and including £100 set aside for depreciation of works, amounts to £1,047, leaving a balance of £311 available as profit, or rather more than sufficient to pay a dividend of 6 per cent. In this case the proprietors, having an eye to the competition of cheap petroleum, have followed the wise policy of selling gas at a moderate price. Sometimes, in these small undertakings, the price is kept up sufficiently to admit of a larger dividend; but especially remembering that it is not worth while with so small a revenue to go to the expense of obtaining Parliamentary powers, and therefore that the concern is on the same footing as an ordinary tradesman in respect to competition, such a course is likely to produce troublesome results. Perhaps I should explain that the main object of applying for Parliamentary powers is to obtain immunity from competition in respect to a certain defined district—a privilege which Parliament is prepared to grant, subject to the undertaking of certain obligations in return. Passing on to notice the working results; 585 tons of coal were used, and yielded 5,725,000 cubic feet of gas, or 9,800 cubic feet per ton; and of this quantity 89 per cent. was sold, 5 per cent. used on the works (rather an extravagant consumption), and 6 per cent. unaccounted for.

A well-worn humorous anecdote, untrue, but amusing as most of these sayings are, relates that a Scotchman was offered a patent stove that would save one-half of his fuel, and that, after due consideration, he decided to purchase two stoves, so as to *save it all*. And really, judging from the way the introducers of "cheap gas" schemes are going on, the gas producer of the *save it all* description is not far off. The public has been promised gas at 6d., 4d., and even lower rates, per 1,000 cubic feet; but schemes of this mild description are left far in the rear by a recently-issued pamphlet describing the performances of a patent generator capable of producing 100,000 to 200,000 cu-

bic feet of 16-candle power gas per ton of coal—but this is not all—per ton of the smallest and cheapest coal slack; and this gas, it is claimed, can be "profitably sold" at the rate of one penny per 1,000 cubic feet. This might as well have been put as "profitably given away," seeing that the modest penny would scarcely recoup the cost of taking the meter indices, making out the bills, and collecting. Since a ton of coal weighs a ton, and 100,000 cubic feet of gas weighs a ton and a half, it may be presumed that water or air is called in to supply the missing 10 or 11 cwt. It is well said that "truth (!) is stranger than fiction." Many gas engineers, however, will be glad to hear that a demand has arisen for the "smallest and cheapest coal slack," as there will then be not so much probability of a moderate proportion finding its way, in some unaccountable manner, into cargoes sold as screened gas coal.

For an example of the modern Shylock, determined to have his "pound of flesh," commend me to the corporation of the ancient town of Newcastle-on-Tyne; the atmosphere of which is usually so laden with odors of one kind and another from the surrounding chemical factories as to render a few thousandths of a grain of sulphur per cubic foot, more or less, of no possible practical consequence. The Newcastle and Gateshead Gas Company, who have the privilege of supplying the town and district with gas, have admittedly for many years enjoyed the notoriety of supplying gas remarkably cheap, and remarkably pure, in both respects keeping far below the standards imposed by Parliament. But on one day last December, and on one day in last January, the sulphur impurities were found by the corporation gas examiner to exceed the prescribed limit of 20 grains per 100 cubic feet. For this the delinquent company was duly brought before the local magistrates, and, although it was shown in evidence that the cause of the increase in sulphur was not known—Mr. Pattinson, the gas examiner, saying "that he could not account for the impurity of the gas except that the purifying apparatus was not so good as it might be"—they were fined £10 and costs. Indeed, the case having been brought forward and proved, the magistrates had no choice but to administer the law. The excess of impurity was evidently due to unavoidable accident, very possibly to an increased make of gas, since the sulphur compounds always give most trouble just at the period of maximum make. Mr. Pattinson admitted that the purity of the gas during the past few years had been very satisfactory; and yet he thought "the purifying apparatus was not as good as it might be." The English law has always recognized that no person is culpable for the consequence of "unavoidable accident," and accepting this spirit, it follows that the provision under which the Newcastle Gas Company was fined was intended to protect the gas consumers against the consequences of negligence, of which the opinion "that the purifying apparatus is not so good as it might be" is rather a loose definition. The ultimate result of this hair-splitting policy on behalf of the Newcastle corporation, will be the providing of large additional purifying plant on the part of the gas company—and who will have to find the interest on the capital so expended? The gas consumers of London pay one penny to twopence for 1,000 cubic feet more than would otherwise be necessary in order that the gas may be maintained up to a fanciful standard of purity in respect to sulphur compounds; and, thanks to the action of their representatives, it is not unlikely that the gas consumers of Newcastle will eventually follow suit.

A paper entitled "Gas for Light and Work in the Workshop," read before the Manchester Association of Employers, Foremen, and Draughtsmen," by Mr. Thomas Fletcher, F.C.S., of Warrington, a few weeks since, is worthy of passing notice, and, indeed, of something more; for it may be useful to many as a permanent record of almost a distinct branch for the application of gas. Commencing with some practical remarks as to the most economical method of lighting workshops, Mr. Fletcher proceeds to notice the utility of gas blow-pipes, and small gas furnaces. He exhibited a small portable or table forge, by means of which a seven-eighths inch round bar could be raised to welding heat in ten minutes, starting all cold. Mr. Fletcher is well known as the manufacturer and original inventor of many appliances for the purposes above alluded to.

From a Parliamentary return, recently published, I learn that the total amount of capital actually paid up and invested in statutory gas undertakings in the United Kingdom, on the 31st December, 1883, was about 52,000 millions sterling; the numerous array of small undertakings not large enough to incur the expense of obtaining statutory powers, which exist in all parts for the supply of villages, small towns, large factories, etc., are, of course, omitted from the above return. Of this large amount of capital about two-thirds is in the hands of joint stock companies, and the remaining one-third belongs to local authorities. The return also sets forth that the total quantity of coal carbonized was 7,631,304 tons, which produced nearly 77,000 millions cubic feet of gas, of which quantity rather more than 70,000 millions were sold. The total number of consumers is stated to be something over two millions. As the total population is somewhere about 36 millions, it appears that in the British Isles one person in every eighteen enjoys the privilege of periodically paying a gas bill. The number of inhabited houses is

about six millions; so one house in every three is lighted with gas. For the distribution of this quantity of gas there are nearly 20,000 miles of gas mains; and the total number of public lamps is put at 375,536. These figures, of course, cannot be taken as more than a rough approximation to truth; but, as such, they serve to illustrate the importance and the magnitude of the gas industry in the United Kingdom.

The Cleaning of Boilers.

The *Locomotive*, in dealing with the above-named subject, makes the following suggestions:

Following the application of any boiler purger or other substance for loosening scale or deposit upon the shell, heads, or flues of a steam boiler, special care and attention should be given to cleaning out the boiler, with a prompt removal of such loose fragments as may have become detached and fallen down. These particles, if not removed, are often swept about by the various currents within the boiler, and, collecting in a conglomerate mass upon some part of the fire surface, prevent access of water to that particular part, and thereby it is overheated and is bulged—or bagged, as it is sometimes called—often inflicting a dangerous injury to the boiler, and requiring a considerable outlay for new sheets, a patch, or perhaps other expensive repairs. In the use of soda and other preparations used for removal of boiler incrustations that are soluble in water, a separate vessel may be provided, suitably connected to the feed-pipe, so that the preparation, in its proper proportions as recommended, may be first dissolved, and, when properly prepared, fed into the boiler. When there is a heater the solvent may be prepared and emptied into that. Logwood or oak chips, leather clippings, and many other waste products of a manufacturing establishment that contain some useful ingredient, as tannin, soda, or starch, may often be used advantageously when they are recommended and their use directed by an inspector; otherwise serious difficulties may result—perhaps endanger the safety of the boiler. We have known silk fabrics and other delicately-fine articles to be ruined in the dyeing process by the too free use of boiler compounds of which the users were ignorant in two essential particulars—viz., as to their composition and the safe quantity to be used.

The importance of knowing these particulars will be evident when we remember the great tendency of the boiler to foaming when purges are used, and the increased danger at such times of carrying over some of this water mingled with steam to the dye kettles, or wherever it may be used. We should not have a great deal of sympathy with the man who, declining to avail himself of the services and advice of a physician, ruined himself by dosing with all sorts of nostrums of which he was ignorant; but such a man at the worst can but ruin himself, while another who persists in dosing his boiler may not only lose his own life, but he may sacrifice many other lives in the same foolish way. We know of an instance in which a party who had some condemned bacon in his storehouse which he thought to use advantageously in cleansing and lubricating his boiler, he having somewhere read that grease was an excellent thing for the purpose. As he described it afterward, the boiler turned nearly inside out, and he fondly hopes that he may live long enough to get even with the man who recommended it to him. Another case was that of a fireman, whose duty it was, under the direction of the engineer, to fire and keep clean a battery of boilers, who, happening to hear some of his mates say that oil was an excellent thing for softening scale, thought to make a trial of it on his own account. So one Sunday, when cleaning out his boiler, he went through the shops connected with the establishment and gathered up the refuse oil and grease from various drippans, securing in this way two or three gallons, which he poured into one of the boilers, and afterward filled it with water. Soon after the steam was got up the fire-sheets became bagged and beautifully corrugated, and leaked like a sieve.

In boilers under our supervision we have used crude petroleum many times for the purpose of loosening scale, and with the most satisfactory results. We do not approve of the use of grease, and we deem the application of animal oils or fat to the interior of a boiler for that purpose as very hazardous. As a rule, when a boiler is in service, a systematic daily charge of a proper solvent graduated to the capacity of the boiler will be found more efficacious than a larger charge at longer intervals, and is less likely to cause foaming and kindred difficulties. An important matter sometimes overlooked is the need of regular times for it. When about to put a boiler out of service for a thorough cleaning, it will be found an excellent plan to let the boiler cool off gradually and the pressure fall slowly until it has reached about 5 pounds, when the safety-valve may be raised and the remainder blown off. Run off the water and remove the hand-hole plates, when the scale will be found much softened and easily detached, while the deposit can readily be washed off with a hose. We have found this an excellent plan to pursue even in marine boilers using sea water and depositing a very refractory scale, as the waters of the North Atlantic or Gulf of Mexico. Blowing down a boiler between the limits of high and low water—or, in other words,

between the upper and lower gauge-cocks—is often very beneficial, and assists materially in freeing it from the ill effects of scum and other impurities. If, however, this blowing down is not intelligently done, there is a probability of great waste and serious loss; for in blowing out good water at the temperature of the steam pressure and replacing it by other water, perhaps of no better quality, at the much lower temperature of the feed, there is a great loss of heat and consequent waste of fuel. Blowing down a boiler can, however, under no circumstances be depended upon to thoroughly clean the boiler and remove the loose fragments of scale and much of the deposit commonly found. This can only be done by systematic periodical washing out at intervals to be determined by the circumstances of the case.

Compressed Oil Gas Illumination.

Our English contemporary *Iron* avers that in the face of the occasional outbursts of just indignation on the part of the traveling public of this country at the dismally lighted trains by which they are compelled to travel on some railways, it is refreshing to know that progress continues to be made in many quarters towards the establishment of a better state of things. The electric light is said to be promising well on some lines, and on one at least—the Brighton—we believe it is keeping its promise; but we are not in a position to answer for the others. Ordinary coal gas, too, we are informed, is looking up on another line. In the face of all this, however, the use of Pintsch's compressed oil gas system for lighting railway carriages is steadily advancing on our leading lines of railway, it having been adopted on eleven of them. To come to figures, we may state that the Great Eastern Company take the lead with 592 carriages so lighted. The London and South-Western follow, with 553 carriages; the Metropolitan District Railway, with 350; the Metropolitan Railway, with 301; the Glasgow and South-Western, with 250; the Caledonian, with 208; the South-Eastern, with 154; the Midland, with 121; the Mersey Railway, with 56; the Great Western, with 38; the North British closing the list, with 36. This gives a total of 2,659 carriages thus lighted on English railways; but this is only a small proportion of the number of carriages fitted in England and on the Continent inclusive, the grand total being more than 17,500 in all countries, and this is exclusive of a number of locomotives which are fitted with head-lights on Pintsch's system. Satisfactory as this is, it is not all; for the use of gas lighted buoys on this principle continues to increase. Two have recently been despatched to Canada for use on the St. Lawrence, whilst three have been added to the nine already in use on the Clyde. The *Garmoyle* lightship is now being altered from an oil-lighted vessel with a crew to an oil-gas-lighted ship without one, which means a great saving. The light will be one which will burn for six weeks without attention or recharging the gasholder. Beyond this, the company owning Pintsch's patents are working out a plan for placing a light on the Gantoch Rocks. They put up some small gas works for the Trinity House at the South Foreland in connection with the lighthouse experiments there, and which we understand proved very successful, and have formed a special feature in the experiments. On the whole, then, it will be seen that Pintsch's compressed oil gas system, of which we have always written hopefully in the past, fully justifies the confidence we have expressed in it. Having taken root in this country, it is spreading rapidly in all directions; and those railway directors and managers who have not permitted their judgment to be warped by prejudice are to be commended. Only one word of caution would we give to these latter gentlemen, and that is, having a good thing, let them not be stingy, and dole it out to the public in a half-and-half sort of way, as some are wont. They need not be wasteful, but they should not be stingy. There is all the difference in the world between extravagance and penuriousness. We believe the cost leaves a liberal margin for a generous light, which the public have a right to expect, and which it will be to the advantage of railway companies to give them.

Natural Gas and its Uses.

"Rivet," in a recent communication to *Mechanical News*, writes the following:

During a recent visit to Western Pennsylvania I was much interested in the application of natural gas to smelting and heating purposes. At one furnace that I visited the gas was brought in a six-inch cast iron main about 20 miles, and at the place where it was used gave a pressure of about 75 lbs. to the square inch.

For heating purposes, either for making steam or domestic purposes, the ordinary grate is filled nearly full of broken fire brick—the pieces being about the size of egg coal. The gas is admitted to the under side of this grate full of broken brick and ignited on top. The heat produced is very intense, and on its first application has to be watched with great care until the desired flow is secured to produce a uniform heat. One of the peculiarities of the gas is its freedom from odor, hence its use is rather dangerous, and

already several serious explosions have taken place in consequence of imperfect connections in pipes used to bring the gas into buildings for use.

Many manufacturing concerns do not attempt to stop the flow of gas when they have completed their day's work, but turn it into a pipe leading into the open air, and let it burn all night, or until it is wanted again, thus reducing the liability to explosions by permitting it to flow freely into the open air.

It would be almost impossible to tell the number of gas wells in and around Pittsburgh. Besides those already in use as many more are being sunk in hopes of striking a good flow. I am informed that the depths of these wells vary in a large degree, undoubtedly depending much upon location. Those already in use range from 1,500 to 2,800 feet. The well men say you must go deep enough to strike the second layer of sand before a good flow can be secured. The wells are usually sunk to receive a six-inch iron pipe, although several have been put down where an eight-inch pipe has been used. Where this has been done smaller wells have been first made, and the larger ones made to get an increased supply. I understand that the gas company for lighting the city use this natural gas with that which they manufacture, and thereby greatly cheapen the production. Where the natural gas is used for domestic purposes its cost is about one-third less than coal for the same purpose.

One gentleman informed me that he used it in an ordinary cook stove, and said it was perfect in the way of heat. He used the broken fire brick as already described. Having occasion during the cold weather to be absent from his home with his family for several days, he regulated the flow of gas to his stove and went off and left it for three days, to return and find his home as warm and comfortable as when he left. He said the greatest trouble he experienced was a variation in the pressure from what were to him unknown causes. This he said was not general, but applied particularly to the well he was using. Already there had sprung up in Pittsburgh and vicinity the invention and manufacture of gas regulators that would undoubtedly overcome the trouble of variable pressure.

When I asked him what he thought of the duration of the supply, he said no one could tell. There were some wells that had been in use about a year, and he presumed that there were others even longer than that, and still there is no perceptible abatement in the flow.

While on this subject of gas wells I give another one. About seven miles south and east of Mt. Vernon, Ohio, there has been for years a lamp black factory. The lamp black is made from gas from a natural well; and to show you the extent of the business, over 90,000 jets are in use, and the black thus made is of a superior quality, and commands a much higher price in the market. The owner began in a small way, and has by degrees added to his buildings until now he has the largest factory in the world. I understand that the lamp black thus made is used for the best kind of carriage and car painting.

An English Establishment for the Storage of Petroleum.

Engineering, in an article descriptive of the methods employed by the firm of Messrs. Ingall, Phillips & Company (London), in storing the vast quantities of mineral oils constantly arriving at their works, explains that the before-mentioned factors are large storers of petroleum, they having three large establishments, viz., Dudgeon's Wharf, Mellish's Wharf, and Palmer's Wharf, all on the Thames. The former is the most recent addition to their business, and it is also the most extensive and best arranged. Those who remember Dudgeon's shipyard in its prosperous days would scarcely recognize it now converted into an oil storing depot. The front of the slipways has been built in by a broad wall which serves as a landing wharf. The vessels which bring the petroleum generally lie moored in the tier adjacent off Cubitt Town Pier. From there the barrels are transferred to dumb lighters, of which the firm possesses about twenty, and are brought alongside the quay, where are three steam cranes, two of 30 cwt., and one of 3 tons capacity. The barrels are lifted out of the lighters by these and placed on an elevated wooden staging. This is of such a height that the barrels will run over the special railroad provided to the extreme end of the premises without any more labor being expended on them; in fact, when a barrel of oil comes on to the wharf to whatever part of the premises it may have to go the transport is always effected, excepting in very rare instances, by its own gravity. It should be here mentioned that there is an addition to the quay space referred to which is formed by a dock about 200 feet long. This has been lined with a bed of chalk to prevent the flat-bottomed barges from "sucking," as they are apt to do, on the mud, and so not rising with the tide when fully laden.

From the staging mentioned the barrels run on a railroad to the weighing machine which is placed in the middle of the premises. This forms a central junction for the numerous roads laid down throughout the works. The old method of forming the railroad for the barrels to roll on was by means of 3½-inch iron pipe, the different lengths being screwed into sockets.

Two lines of pipe were supported on wooden sleepers, and placed a sufficient distance apart to allow the bilge of the casks to fall between them. There was a serious disadvantage in this arrangement inasmuch as each time the barrel passed over a junction of the two ends of pipe a jar was given to it, and the constant repetition of this soon caused the barrels to leak. The ways are now formed of light tram rails, which are specially rolled for the purpose by the Rhymney Iron Company. They are joined by fish-plates in the ordinary way, and are much stronger than the old pipe roads. There are several elevated roads formed entirely of these rails at Dudgeon's Wharf, and the barrels roll about without attention on the ground or overhead in all parts of the works. The standard gradient is now 3½ in. in 20 ft., which has been found in practice the most suitable; 4 in. in 20 ft. was the gradient used with the old pipe roads. From the weighing machine the majority of the barrels pass on to an automatic elevator on the endless chain principle worked by a 16-horse power gas engine, which lifts them to an upper floor of a large building known as the emptying floor. Here there are nine troughs, about 66 feet long, let into the floor. They are of rectangular section, 12 in. wide by 12 in. deep, and are formed of wrought iron plates riveted together. The barrels are rolled over them, and the bungs being taken out, the oil runs out. The barrels being emptied they roll on, still by gravity, until by a suitable road they are taken to the yard where empties are stored, or else are conveyed back to the barges to be shipped away. The nine troughs in question lead into another large trough placed at right angles to them, and into this the oil flows. From thence it runs through an iron sluice, also used as a footbridge, into the receiving tank, which is, like all the other tanks, made of wrought iron plates riveted together. The receiving tank is cylindrical in form, 16 feet deep and 32 feet 9 in. in diameter, and will hold 2,000 barrels. It is enclosed by a brick wall.

From the receiving tank the oil is pumped into any of the storage tanks, of which there are thirty-two in all. Their collective capacity is 56,000 barrels, there being 40 to 42 gals. to a barrel. The principal group of tanks is placed in a large sunken pit on the old slipways, the ground having been excavated for the purpose. Twelve of these are circular, 32 ft. 9 in. in diameter and 26 ft. deep. Six are rectangular, 13 ft. by 13 ft. by 26 ft. Six more are circular, 7 ft. 6 in. in diameter and 26 ft. deep. There are two other smaller groups in another part of the premises. From these tanks the oil is pumped out into barrels as it is required to be delivered to the owners. The pumps for filling and emptying are seven in number. Four are situated close to the cask elevator referred to, and are driven by the gas engine which works it. They are 3 in. rotary pumps, and are said to give very good results. For emptying or filling the tanks respectively the pumps are simply reversed, the operation being performed by open and crossed belts. Arrangements have been made for a further number of these pumps, and, indeed, the whole work is designed for considerable further extension, the business of Messrs. Ingall & Phillips having been continually and rapidly increasing up to a short time back. The other pumps are of similar construction, but are placed in a separate house near the wharf. They are worked by a vertical steam engine.

For filling the barrels there are two sets of apparatus. The more modern of these is situated on the same level as the emptying floor. The arrangement consists of a pair of rails for the barrels to roll on, between them being a trough to catch waste. The oil is pumped through a service of pipes from the storage tanks, and a nozzle is inserted into the bung-hole by means of a universal joint, as flexible pipe is hardly admissible on account of the penetrative and solvent properties of the oil. It is calculated that this apparatus will fill 1,000 barrels an hour when complete.

A barrier 4 ft. high and 2 ft. 6 in. thick, formed of two walls of brick with puddled clay between, separates the premises from the public road, so that in the event of a sudden rush of oil, say in the case of fire, the neighborhood would not be inundated. There are also other walls of a like nature, as well as banks erected in various parts of the premises, in order to isolate different sections. There are several other elevators in different parts of the works similar to the one we have referred to, and the whole network of roads is laid out in such a manner that whenever a barrel arrives at the lowest part it can be lifted by an elevator so as to be on another falling gradient for transportation back to any part. In this way, and by means of crossings and junctions, a barrel of oil can be conveyed to any part of the works without being rolled by hand. It is needless to say that for filling and emptying the tanks there is a vast service of pipes. These are all of wrought iron, the mains being three inches in diameter. They are connected by ordinary screwed joints. On the whole, it would seem that Messrs. Ingall, Phillips & Co. have studied the question of the storage of mineral oil very carefully, and have brought the system to a great degree of perfection. We trust they may have a renewal of the success which their enterprise and energy should entitle them to. When the tank vessels for carrying the oil from Batoum are run into the Thames, the whole system of conveyance and storage of petroleum will have been greatly simplified and cheapened, a fact which should considerably influence the price of the commodity.

The Petroleum Situation.

Stowell (writing under date of Feb. 20), in reviewing the situation since opening of markets on Jan. 1, 1885, declares that the course of the petroleum trade for the year so far has been as devoid of excitement as it has ever been in the same space of time. While with every succeeding month of the latter half of last year we have had to chronicle the advent of still larger wells than came in during the preceding month, the present year has not brought in as yet a single well which might justly claim the title of "gusher." With this absence of any single large producer, there has been a steady decline in the output of the oil wells, so that we have to register for last month a very much decreased daily average, which by this time is still further diminished, and might be expressed in round numbers as 50,000 barrels.

Throughout January and the early part of the present month the Gantz well, in Washington county, has received a great deal of attention—considerably more, as the result shows, than it has deserved. The well was drilled in December by the Citizens' Fuel Company, of Washington, to a depth of 2,200 feet. A small show of oil was obtained at this depth, when the well was tightly plugged, boarded up, and worked as a mystery. Rumors regarding the condition of the well and the prospects of its being a gusher were rife throughout the weeks that followed, but nothing was done at the well until on Jan. 26 the plug was removed, and the well made a flow which lasted 45 minutes, and which amounted to about 50 barrels. After this brief flow the well stopped, and drilling was recommenced, as reports go; several delays were occasioned by accidents, and little progress was made. A very small flow was made on Feb. 1, which lasted for but five minutes, and after which no more oil could be gotten out of the well. It was then decided to shoot it; and after two charges had been exploded in the well another brief spurt ensued. This ended the production of the well for the present. The owners are at present drilling the well deeper, and will put in a pump; but the chances for a Washington county gusher are not very flattering.

But very slight fluctuations in the market were caused by the variable conduct on the part of the Gantz well. On Jan. 19, however, the market experienced considerable excitement. Grandin well No. 28, in the Balltown district, which has been looked upon as practically dead territory since last summer, came in with a reported production of 400 barrels per day. This arrival in so unexpected a quarter was a decided surprise to the market, and prices were knocked down a couple of cents, but soon recovered their equilibrium when the well settled down to 150 barrels a day.

About January 23 the Macksburg field attracted a little attention, owing to the performance of the Syndicate well, which was at that time putting out 150 barrels of the 800 barrels daily production of that district. Nothing startling was brought to light here, and the trade relapsed into great dullness. The Phillips well No. 1, on the Mnshrush farm, was the only prominent feature in the situation; but the process of development at this well was very slow, and very little excitement was occasioned when it did come in. During the present month the course of trade has been quite monotonous, the only features being the "mystery" work at the Clark & Sutton well on the McLaughlin farm, which at this writing has not yet been brought in, and the flow of Fisher No. 4, on Feb. 4, which broke the market slightly, but which at the present writing is doing but 50 barrels.

The range of prices during the past month and the portion of this month under review has been limited, and, in spite of favorable indications, has shown little disposition to advance. This must necessarily suggest that influences foreign to the questions of supply and demand are being exerted to keep prices at their present level. It is, of course, always possible to do this, and where manipulation exists it is useless to endeavor to forecast the future of the trade from field indications. Hence it can only be held that the situation as regards production and consumption is very favorable, and that, if in any measure set free from extraneous influences, we may expect to see much better prices in the near future.

ITEMS OF INTEREST FROM VARIOUS LOCALITIES.

EXPORTING AMERICAN ENGINES.—A certain evidence that excellence attaches to the Westinghouse Machine Company's product is produced when we mention the fact that these Pittsburgh manufacturers are shipping engines to Europe, such orders principally coming from England and Holland. One of the recent orders comes from the British Admiralty Board, a 15-horse power automatic engine being the class purchased; the South Kensington (London) Museum authorities have also purchased a 9½ x 9 engine, which is intended to actuate the electric lighting dynamos of that institution. The engine is calculated to perform as high a duty as 550 revolutions per minute.

CALLING FOR BIDS FOR THE ERECTION OF GASHOLDERS.—The attention of contractors and builders of gas works plant is called to the advertise-

ment of Mr. F. H. Hambleton, chief-engineer to the Consolidated Gas Light Company of Baltimore, Md., which will be found on page 129 of this issue. Mr. Hambleton therein invites proposals for the construction of two telescopic holders, each of about 87 feet diameter, with 45 feet lift. The date when proposals may be handed in closes with March 20.

GIVING AN ACCOUNT OF HIS STEWARDSHIP.—Mr. Edward L. Wood, who has held the position of Treasurer to the Leviston (Me.) Gas Light Company for nearly eleven years, and who for some time past has been desirous of being relieved from the duties of that office, finally determined to sever his connection with the corporation toward the close of 1884. Prior to handing in his resignation Mr. Wood submitted the following statement, rightly believing that such procedure would most clearly portray the manner in which the interests confided to his care had been handled. It might be said that Mr. Wood assumed the Treasurership of the company at a time when its affairs were not in the brightest possible condition.

Trial Balance, June 2, 1873.

Capital	\$150,000 00	
Notes payable	42,155 66	
Profit and loss	\$45,511 67	
Plant and real estate	130,777 52	
Cash assets	13,966 47	
Taxes due, unpaid	1,900 00	
Totals	\$192,155 66	\$192,155 66

Trial Balance, November 30, 1884.

Capital	\$75,000 00	
Notes payable	6,309 99	
Profit and loss	2,836 51	
Plant and real estate	\$74,703 12	
Cash assets	8,434 38	
Taxes, paid six months in advance	1,000 00	
Totals	\$84,137 50	\$84,137 50

A 3½ per cent. semi-annual dividend, due and paid Jan. 1, 1885, taken out of cash assets, leaving 1884 figures net. The company could also dispose of land valued at \$20,000, and still have sufficient ground area left for all possible future enlargements. We have not been informed as to who was appointed in Mr. Wood's place.

PREDICTIONS VERIFIED.—Several of our city engineers predicted that the arrangements for getting at the carbon points in the arc lamps on the Hell Gate tower would prove of little value during some of our winter storms. The man who attends to the changing of the carbons ascends to the top of the tower in a skeleton car held in place by two steel wire guide ropes, each three-quarters of an inch thick. On three or more occasions during the past winter, owing to the occurrence of sleety storms, when the tower ironwork, and the steel guide ropes as well, became encrusted with ice, the elevator car refused to budge and the lamps remained unlighted. It might be here added that no great catastrophe occurred through the failure of the illumination on those stormy nights; and if the whole truth were told it would not make much difference to the East River and Long Island Sound navigators if the tower arcs remained extinguished on every night.

JUDGE EWING REFUSES TO GRANT THE INJUNCTION.—In our issue for Feb. 16 it was reported that Moritz Wolf and another, residing at McKeesport, Pa., had made application before Judge Ewing for an injunction restraining the National Tube Works Company from proceeding with the laying of a main for the conduction of natural gas underneath the roadway in front of plaintiff's premises. When all the testimony had been submitted Judge Ewing said that, all things considered, he would deny the prayer of the plaintiffs. His Honor said that the case was an important one, and the weight of testimony produced by defendant conclusively proved that the main laying operations were being conducted in accordance with the best approved modern practice. Some interesting expert testimony was developed by the hearing. Mr. W. S. Jarboe gave it as his opinion that the joint employed by the National Tube Works Company on this disputed line of pipe was superior to anything else of the sort that he had ever seen. William E. Russell, Boiler Inspector, Allegheny County, Pa., testified in a similar strain. He thought the joint was so fully re-inforced that the pipe itself would break before the joint would be ruptured. Messrs. Thomas Shelton, John McCaffrey, and R. J. Wilson gave similar evidence.

ROCHESTER ELECTRIC WIRES CAUSE A FIRE.—About 1 a.m. on the morning of Feb. 10, W. J. Savage, night operator at the central telephone office, No. 73 East Main street, Rochester, N. Y., discovered that the tower of the building was on fire. An alarm was sent out, and prompt action by the fire-

men soon put an end to the danger. The fire was caused by the crossing of the electric light and telephone wires—the latter entering the building through the tower. Damage to the amount of \$750 was caused.

FLATBUSH (L. I.) STREET LIGHTING SQUABBLE.—Flatbush is a pretty suburban village and township adjoining the southeastern end of Brooklyn city. It has a population of about 7,000 souls, and is chiefly notable to outsiders as affording a site for the public buildings of Kings County—these latter including the almshouse, nursery, hospital, and lunatic asylum. The burial ground known as the Cemetery of the Holy Cross is also encompassed within the township limits. The place is well laid out, has a plentiful water supply, and boasts of a very “exclusive” set of residents, some of these proclaiming that their ancestry may be traced back to the original Dutch settlers of the year sixteen hundred and something. Another thing of which the “Flatbusher” is very proud is that venerable “Erasmus Hall” (the first regularly incorporated college in the State of New York) still holds open wide its doors for the reception of the student; but the old seat of learning, while yet training the “young idea how to shoot,” has long since degenerated into an ordinary sort of “day school.” The visitor, too, may always count on having pointed out to him the structure, with its stuccoed front and “Dutch” spire, known as the Reformed Church. The aspect of the country is uniformly flat and low, and one might hunt over the rich farming lands of the locality for days at a time without finding the sign of an obtruding rock. We mention some of these things in order to show that not much trouble is encountered by the Flatbush gas man, when it comes down to the question of conduit extensions. Flatbush has a gas company whose operations have extended over a period of many years; and it is rather a model gas plant in its way. Its owners have enjoyed such a “soft thing” of it, though, that they are not inclined to make much exertion in the direction of extending their output by reducing selling prices. Still, if they do not wish to extend their business ramifications, they do desire most ardently to hold on to what they now enjoy—and get the old-time prices for the service. The town authorities recently came to the conclusion that \$35 per annum was a pretty steep price to pay for each public lamp, and so it was determined, shortly before the lighting contract was to be renewed, that an effort should be made to have the charge reduced. The lighting is carried out on the basis of a “moon-table,” and the total number of public lamps is 225. It would strike the average observer that \$35 was a fairly round figure for the service, and might possibly admit of being reduced somewhat without any injustice being done to the gas purveyor. At any rate, the Road Commissioners suggested that \$30 would be a fair figure; but the gas company said “no,” and further intimated that if the Commissioners insisted on the latter terms out would go the lights. After much higgling between the interested parties it was finally decided that the township should pay the sum of \$33 for each of the 225 lamps. The Flatbush gas works proprietors would not stand in need of condolence even did the Commissioners insist on the \$30 rate.

AWARDING THE BROOKLYN (N. Y.) STREET LIGHTING CONTRACTS.—On February 16 the Brooklyn (N. Y.) Board of Aldermen finally determined to authorize the execution of the annual contracts for street lighting for 1885. The city fathers repeated their attempt of last year to get the companies to assent to a reduction on the original bid price, but the scheme, unlike last year's result, came to grief. The companies remained firm in their adherence to the original figures submitted, and the contracts were awarded on that basis. Although the bids have been once published in the JOURNAL, it may possibly be in order to mention the figures over again. The following is a summary:

	Street Lamps.	Public Buildings.
Brooklyn Gas Light Company.....	\$19.80	\$1.50 per M.
Citizens “ “	22.00	1.75 “
Metropolitan “ “	22.00	1.75 “
Nassau “ “	22.00	1.75 “
Peoples “ “	22.00	1.75 “
Williamsb'g “ “	21.75	1.75 “

The cost of lighting, extinguishing, repairing, and cleaning is included. The lamps are to burn all night and every night in the year; and the rates at which the service is performed would seem to be pretty low ones. We have not been informed as to the action taken in regard to the electric lighting propositions, but it is fair to presume that of the \$15,000 voted by the Board of Estimate for the maintenance of a partial system of arc illumination there will not remain a very large “unexpended balance” at the end of the twelvemonth. In 1883 the Aldermanic body of the City of Churches did not award the lighting contracts until well into the summer, and some ugly rumors were circulated as to the cause of the delay. Last year the awards were made during the month of February, and while some greater show of punctuality is being exhibited in attending to the execution of Brooklyn's street lighting contracts, one would be inclined to think that arrangements

for concluding the same might take place at a date much closer to the period from which the actual work of lighting commences—Jan. 1st of each year.

INDIANAPOLIS (IND.) GAS LIGHT COMPANY MAKES A PROGRESSIVE MOVEMENT.—At the meeting of the Indianapolis City Council, held Monday, Feb. 16, the Committee on Public Light handed in a report which brought with it a statement that a new arrangement had been entered into between the city's representatives and the Indianapolis Gas Light Company, by which the price of gas to private consumers was to be reduced from \$2.00 to \$1.80 per thousand, while the public lighting service was to be increased by the addition of 240 hours to the lighting schedule time of each street lamp—the cost of lamps to remain as before—\$25 per post. The consideration given by the city in return for these concessions on the part of the gas company, is the extension of what is known as the “general” contract for the period of ten years from first of March. The “special” contract (the duty of this latter being to define lighting table, size of burners, etc.) was also extended for the period of three years, but the lighting table of same, as before stated, was amended by the addition of 240 hours' service for the lamps; each burner will now perform a total annual duty of 2,740 hours. The “general” contract contains a proviso under which the city can abrogate its working (should the authorities see fit to institute electric lighting, but for no other reason) by giving the gas company a ninety-day notification of that intent. When the report of the committee had been read an ordinance in accordance with the purport of committee's conclusions was introduced; this action brought about a general discussion of the question, and the sentiment of the members was almost unanimous for its ratification. Under a suspension of the rules the ordinance was passed by a vote of 17 to 2—Messrs. Dowling and Thalman alone opposing. Mr. Thalman, in explanation of his vote, said he preferred that the old contract should be allowed to expire by limitation before the new one was entered into—the existing “general” and “special” contracts having some time yet to run. Immediately upon the passage of the ordinance the contracts were awarded, Mr. Dowling alone voting in the negative. Mr. James Somerville, engineer to the Indianapolis Gas Light Company, was among the earliest champions of cheap gas prices in this country, and always “practices what he preaches.” The plant over which he has engineering control is kept abreast of the best lines of modern practice, and with his skilful management it may be counted upon to retain the prominence of its present position. The Indianapolis News, in editorially commenting on the recent action of President Fletcher and Engineer Somerville, says: “The action of the gas company will, we are sure, be duly appreciated and credited. It is in the general line of policy which has guided it for some years; a policy which has wrought a better understanding on all sides, breeding the spirit that the company's interests were identical with the people's, and that advantage to both lay in agreement, not discord. * * * * The city is now well served, and we may confidently look for a maintenance of the course which has brought it about.” Not a bad way to have your neighbors talking about you.

SOMETHING FROM DENVER, COLORADO.—Mr. W. J. Fay, the controlling spirit of the Denver (Colorado) Gas Light Company, writes us that the annual meeting of the stockholders of that corporation was held on Tuesday, January 20th. The various reports submitted gave ample proof that '84 was a prosperous year for the Denver Company. This fact only goes to show the thorough business policy of reducing selling rates—the Denver folks having made a considerable decrease in their charge to consumers during the last year, note being made of the same, at the time of its happening, in the item columns of the JOURNAL. The election of officers for year 1885 resulted in the choice of Mr. G. W. Clayton as President; Mr. W. B. Mills as Secretary; and Mr. W. J. Fay as Vice-President and Superintendent. These were all re-elections, equivalent to a stockholder's verdict of “well done, good and faithful servants!”

CHASING OUT THE ELECTRICAL PROMOTERS.—If ever there was an authentic case on record where the electric folks had, at any one time, complete control of the lighting of a township, that case was exemplified at Cheyenne City, Wyoming Territory. For three or four years the inhabitants of that place were dosed with all sorts and conditions of electrical illumination—arc and incandescent, Brush-Swan storage batteries, etc., to say nothing of the side-shows, which generally consisted in the application and employment of candles, kerosene, torches, and the like, when the “current ceased to flow.” No gas company to plunder the residents, no meters to swear at—although they were hardly necessary as incentives to profanity of the extra-superfluous sort, for the electric medium's eccentricities were always present to furnish impulses of that nature. Some of the more venturesome spirits of the place finally decided that “electricity must go,” and to hasten the time of its exodus set about organizing the Cheyenne City Gas Company. In May, 1884, ground was purchased and the work of building a gas plant was immediately begun. Construction operations were prosecuted with such vigor

that distribution of illuminating gas to consumers was commenced on September 15. So great has been the success of the enterprise that the output during the month of December last averaged over 25,000 cubic feet per diem. So we see that Cheyenne City has reversed the supposed order of things, in so far as the establishment of an electric lighting plant demonstrated a need for the installation of a gas works. Verily, electricity is but "the light of the future."

HOW THE BROTHERS DWELL IN UNITY.—On Feb. 13 suit was begun in the United States Circuit Court, Chicago, Ill., by the great balloonist, Prof. Lowe, acting in conjunction with the "Improvement Company," of Columbus, Ohio, against the Lake Gas Company, of Cook County, Ill., which concern, it appears, has been using apparatus and machinery erected by the "great and only" firm of A. O. Granger & Co., with headquarters at Philadelphia, Pa. Lowe and co-adjutors assert that Granger has no right to erect a particular water gas apparatus without first having obtained a license from the "chief inflator;" and having, as it is asserted in the Cook County instance, failed to secure (presumably to pay for) the Lowe permission, hence these prayers to the Circuit Court. The gas companies throughout the country know just where the JOURNAL stands in regard to the doings of the water gas menagerie; its advice now, as it invariably has been in the past, is to keep clear of all of the parties to the carbonic oxide combination. The less one has to do with them the better he will be off. Let them keep on applying for patents, sending out circulars, and reciting their astonishing stories—these practices harm nobody, and evidently serve to amuse the practitioners. If one may read the signs of the times, it now looks as though the major portion of their cable had been "paid out."

AN ELECTRIC FREAK AT WILLIAMSPORT, PA.—Quinn & Co.'s billiard parlor, located in a building on Willow street, Williamsport, was made the scene of quite a "scare" one evening last February. An incandescent lamp over one of the billiard tables "went off" with "no uncertain sound," and many of the losing billiardists, in explanation of why they were defeated, asserted that the offending lamp upset their nerves. What troubled Quinn & Co. most was the fact that particles of the heated carbon loop destroyed the cloth of a newly covered billiard table. They should burn gas. It is also reported, from the same locality, that on another date in February the town offices were subjected to a similar outbreak. An employee named Albert Wood was rather badly burned, and the ceilings of two of the rooms were scorched. The town authorities had better burn the light of the present.

ONCE MORE IN THE GAS WORKS CONSTRUCTION BUSINESS.—At one time in the history of gas plant construction in the United States the firm of Merrick & Sons was "a power in the land;" but from one cause or another the company drifted out of that particular branch of manufacturing, and devoted its energies to other fields. The old house, originally founded in 1836, afterwards became known as the Southwark Foundry—the Messrs. Merrick still retaining their interest therein. With the beginning of 1885 the proprietors of the Southwark Foundry determined to re-enter the lists of gas works builders, and now formally announce such determination to the gas fraternity of the country. The office address of the company is 430 Washington avenue, Philadelphia, Pa.

PERSONAL.—Mr. T. A. Bates has resigned the superintendency of the Cairo (Ills.) Gas Light Company. John J. Rowe, formerly connected with the Lansing (Mich.) Company, succeeds to the berth vacated by the first-named gentleman.

IT WAS ONLY A HOAX.—Some of the Scotch newspapers recently indulged in a rather precise account and description of the discovery of a new canal field in the Fifeshire district. In fact, from the particulars given (the aforesaid description having been reprinted by several technical journals published in this country) it was supposed that the "discovery" was tantamount to the resuscitation or rejuvenation of a seam of canal which had been "worked out" some years ago, and which had been held in great esteem by the gas makers of the United States. One of our most extensive importers of English canal immediately communicated with Mr. Henry Aitkin, of Falkirk, Scotland, in regard to the Fifeshire "find;" and the response received was of this nature: "The newspaper report of a new field in Fifeshire was a hoax. The account was sent to a Glasgow newspaper for the purpose of teasing two Fife coalmasters; but it appears that the story has since gotten widespread mention in the public prints. It is very amusing." The transaction undoubtedly was possessed of a humorous side; but it was nevertheless rather severe on the "newsgatherers of the press."

THE STACEY MFG. COMPANY WILL BUILD THE HOLDER.—On the 23d of February the contract for building a gasholder, of the dimensions of

138'x36' inner, and 140'x36' outer section, was awarded by the officials of the St. Louis (Mo.) Gas Light Company to the Stacey Manufacturing Company, of Cincinnati, Ohio. The holder will have 12 wrought iron columns.

NOT THE GAS TRUST PLANT.—Late on the afternoon of February 25th word was received at the JOURNAL office that a fire had broken out in the works of the Philadelphia (Pa.) Gas Trust. Subsequent despatches conveyed the news that such was not the case, but explained that the coal tar reduction works of Messrs. M. Ehret & Co., located near the Gas Trust's plant on the Schuylkill River, had been partially destroyed by a conflagration which had been caused by a spark thrown out by a passing railway locomotive. Before the flames were extinguished damage to the amount of \$15,000 was reported to have been incurred.

RECENT PATENTS.

The following list of patents relating to improvements in gas apparatus, etc., granted by the United States Patent Office since February 3, 1885, is specially reported for the JOURNAL by FRANKLIN H. HOUGH, Solicitor of American and Foreign Patents, 925 F Street, N. W., Washington, D. C.

ISSUE OF FEB. 10, 1885.

- 312,106. Gas meter. G. Fajen, Milwaukee, Wis.
311,997. Water gas, method of and apparatus for enriching and burning. C. J. Eames, New York city.
312,193. Gas pipe holder. C. G. Duffly, Utica, N. Y.

ISSUE OF FEB. 17, 1885.

- 312,431. Gas apparatus. W. M. Casler, Columbia City, Ind.
312,279. Gas burner. A. B. Lipsey, West Hoboken, N. J., assignor to W. Bell, New York city.
312,367. Gas burner. B. Martin, East Saginaw, Mich.
312,494—'97, '98. Gas engine. L. H. Nash, Brooklyn, N. Y., assignor to National Meter Company, New York city.
312,499. Gas engine igniter. Same as above.
312,541—'42, '43. Gas mains, detecting leaks in. G. Westinghouse, Jr., Pittsburg, Pa.
312,560. Gas pressure regulator. L. G. Francis, La Grange, Ills.
312,483—'84. Gas regulator, or governor. J. H. Luther, Olean, N. Y.
312,470. Gas under pressure, system for distributing. W. A. Hoeveler and T. J. McTighe, Pittsburg, Pa.
312,565. Hydraulic mains in gas works, discharging tar from. A. Hutchinson, Providence, R. I.

The Market for Gas Securities.

The event of the fortnight was the listing of the stock of Consolidated Gas Company on the boards of the New York Stock Exchange. The Gas Consumers' Association had the assurance to hand in a protest to the Governing Committee of the Exchange urging that favorable action on the listing project be denied. The protest was not even read by the Exchange authorities, and the paper on which it was printed (or written) goes to make up the general collection awaiting the junkman's next call. The Consolidated Company asked to have its entire capital stock (\$39,078,000) placed on the lists; but the Governing Committee refused to list the 36,000 shares reserved for working capital and the retirement of former bond liens and other old indebtedness.

The stock listed (354,300 6-10 shares) was issued in exchange for the old capitals in following proportion: 39,789 shares New York for 75,600 shares; 79,600 shares Manhattan for 119,400 shares; 30,000 Municipal for 66,000 shares; 25,000 shares Metropolitan for 65,000 shares; 39,860 shares Harlem for 28,300 6-10 shares. In the first trading the stock opened strong, and remained firm to time of writing (Feb. 28), closing at 83½ bid, offered at 85. Even should Consolidated go lower (some wisecracks say it will), we believe it to be a purchase at or below present offering noteh. Equitable and Mutual are fairly steady to strong.

Peoples, of Brooklyn, is higher. Auctioneer Jacob Cole, Brooklyn, sold the following securities on date of Feb. 26: \$525 Nassau scrip, at 95-95½; 10 shares Nassau, at 120; 16 shares Brooklyn, at 132½. Chicago (Ills.) gas has advanced 3 points, and will go higher. Business in out-of-town securities, so far as this market is concerned, is dull. Forty shares Little Falls (N. Y.) gas was disposed of on a recent date at the low figure of 26½. Warsaw (N. Y.) gas is firmly held at 95 to 100. Baltimore (Md.) Consolidated gas is stronger; Boston (Mass.) gas does not appear to have been materially, or even noticeably, affected by the Common Council's recent action. We are informed that Mayor O'Brien has signed the Bay State franchise. For regular list of quotations, see page 128.

MAP

showing the Location of the

PLESIO-BOGHEAD CANNEL COLLIERY

NEAR LEITH, SCOTLAND.

PROPRIETORS :

LOCHORE AND CAPLEDRAE CANNEL Co. LIMITED.

GENERAL AGENTS FOR UNITED STATES AND CANADA.

PERKINS & Co.

NEW YORK.



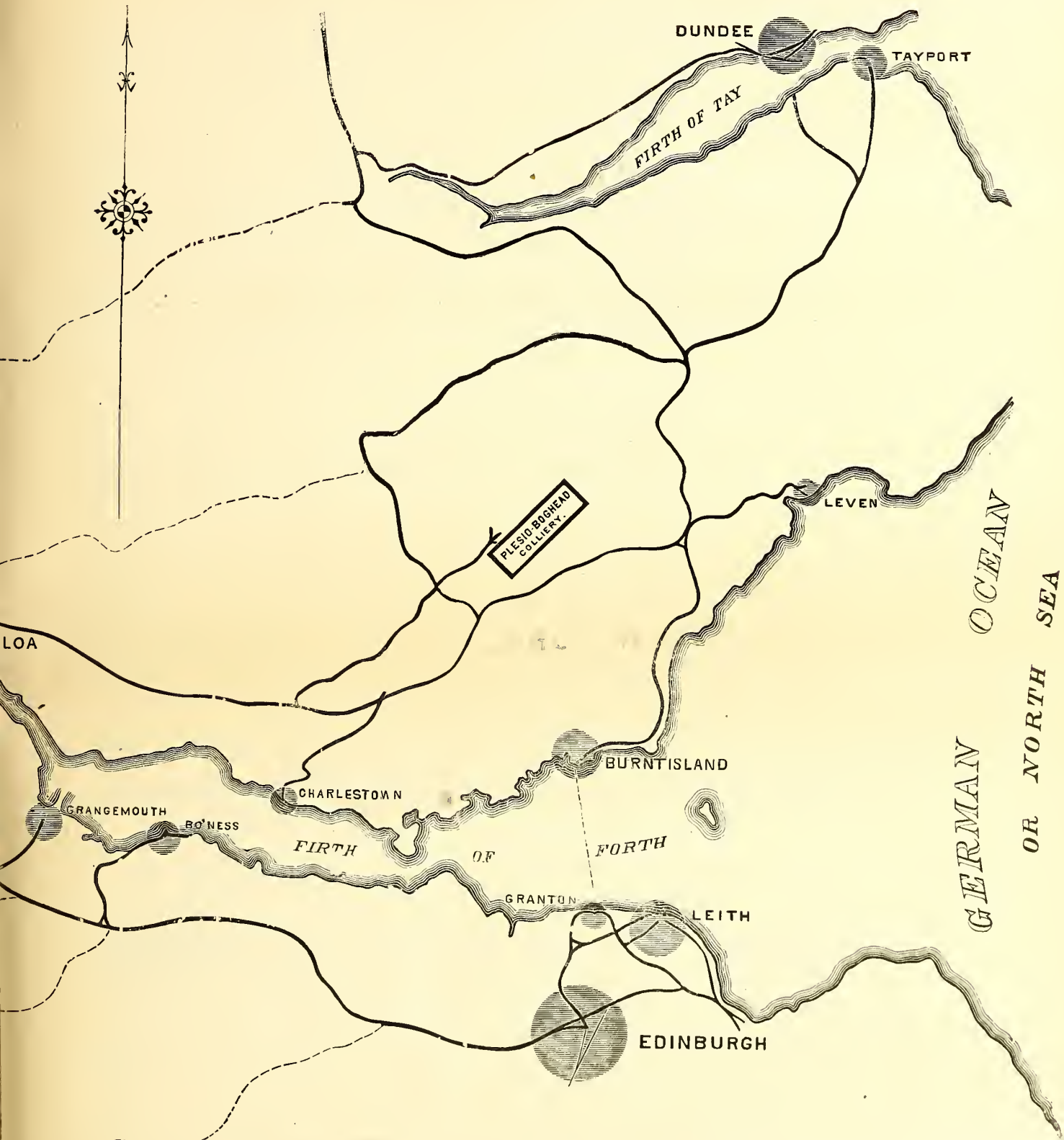

SCALE OF MILES.

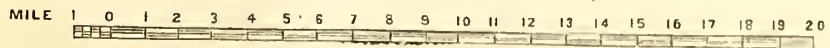

Gas Stocks.

Quotations by Geo. W. Close, Broker and Dealer in Gas Stocks (with A. E. SCOTT & Co.,)

72 BROADWAY, NEW YORK CITY.

MARCH 2.

All communications will receive particular attention. The following quotations are based on the par value of \$100 per share.

	Capital.	Par.	Bid	Asked
Consolidated.....	\$35,430,000	100	83½	85
Central.....	440,000	50	60	—
“ Scrip.....	220,000	—	47	57
Equitable.....	2,000,000	100	95	97
“ Bonds.....	1,000,000	—	102½	103½
Harlem, Bonds.....	170,000	—	—	—
Metropolitan, Bonds....	658,000	—	110	112
Mutual.....	3,500,000	100	120	122
“ Bonds.....	1,500,000	1000	104	106
Municipal, Bonds.....	750,000	—	107	110
Northern.....	125,000	50	—	80
“ Scrip.....	108,000	—	—	—
Gas Co's of Brooklyn.				
Brooklyn.....	2,000,000	25	129	131
Citizens.....	1,200,000	20	84	86
“ S. F. Bonds....	320,000	1000	106	110
Fulton Municipal.....	3,000,000	100	148	150
“ Bonds....	300,000	—	104	108
Peoples.....	1,000,000	10	80	82
“ Bonds.....	290,000	—	105	110
“ “.....	250,000	—	90	95
Metropolitan.....	1,000,000	100	96	—
Nassau.....	1,000,000	25	119	—
“ Cfts.....	700,000	1000	92	94
Williamsburgh.....	1,000,000	50	132	135
“ Bonds... ..	1,000,000	—	106	108
Richmond Co., S. I.	300,000	50	64	75
“ Bonds.....	40,000	—	—	—
Out of Town Gas Companies.				
Buffalo Mutual, N. Y. ...	750,000	100	80	85
“ Bonds... ..	200,000	1000	95	100
Citizens, Newark.....	918,000	50	103	115
“ “ Bonds.	124,000	—	105	110
Chicago Gas Co., Ills. ...	5,000,000	25	128	132
Peoples G. L. & C. Co., Chicago, Ills.....			8	12
Cincinnati G. & C. Co.			180	182
Consolidated, Balt.	6,000,000	100	83	83½
“ Bonds... ..	3,600,000	—	110	111½
Central, S. F., Cal.			—	58
Capital, Sacramento, Cal.			56	—
Hartford, Conn.	750,000	25	123	129
Jersey City.....	750,000	20	124	128
Laclede, St. Louis, Mo. ...	1,600,000	100	88	—
Louisville, Ky.	1,500,000	50	95	100
Montreal, Canada.....	2,000,000	100	181	182½
New Haven, Conn.			25	166
Oakland, Cal.			29	30
Peoples, Jersey City... ..			—	45
“ Bonds... ..			—	—
Paterson, N. J.			25	90
Rochester, N. Y.			50	75
Washington, D. C.	2,000,000	20	190	195
Wilmington, Del.			50	188
Yonkers.....			5	96
St. Louis, Missouri.....	600,000	50	—	—
San Francisco Gas Co.				
San Francisco, Cal.			58	59

Advertisers Index.

	Page
GAS ENGINEERS.	
Jos. R. Thomas, New York City	106
Wm. Henry White, New York City	134
GAS WORKS APPARATUS AND CONSTRUCTION.	
James R. Floyd, New York City	135
T. F. Rowland, Greenpoint, L. I.	135
Deily & Fowler, Phila., Pa.	135
Kerr Murray Mfg. Co., Fort Wayne, Ind.	135
Stacey Mfg. Co., Cincinnati, Ohio.	135
Bartlett, Hayward & Co., Baltimore, Md.	135
Morris, Tasker & Co., Limited, Phila., Pa.	134
Davis & Farnum Mfg Co., Waltham, Mass.	130
Tanner & Delaney Engine Co., Richmond, Va.	128
R. D. Wood & Co., Phila., Pa.	138
Southwark Foundry and Machine Co., Philadelphia, Pa.	123

GAS AND WATER PIPES.

A. H. McNeal, Burlington, N. J.	134
Gloucester Iron Works, Phila., Pa.	134
Warren Foundry and Machine Co., Phillipsburgh, N. J.	134
Mellert Foundry and Machine Co., Reading, Pa.	134
Cincinnati and Newport Iron and Pipe Co., Newport, Ky.	134

SCRUBBERS AND CONDENSERS.

G. Shepard Page, New York City	133
--------------------------------------	-----

REGENERATOR FURNACES.

Charles F. Dieterich, Baltimore, Md.	46
---	----

RETORTS AND FIRE BRICK.

J. H. Gautier & Co., Jersey City, N. J.	132
B. Kreisler & Sons, New York City	132
Adam Weber, New York City	132
Laclede Fire Brick Works, St. Louis, Mo.	132
Brooklyn Retort and Fire Brick Works, Brooklyn, N. Y.	132
Borgner & O'Brien, Phila., Pa.	132
William Gardner & Son, Pittsburgh, Pa.	132
Henry Maurer, New York City	132
Chicago Retort and Fire Brick Works, Chicago, Ills.	132
Baltimore Retort and Fire Brick Co., Baltimore, Md.	132
Standard Gas Retort and Fire Brick Co., Ironton, Ohio.	132
Oakhill Gas Retort and Fire Brick Co., St. Louis, Mo.	132
Cincinnati Gas Retort & Fire Brick Co., Cincinnati, O.	132

GAS STOVES.

American Meter Co., New York and Philadelphia....	79
The Goodwin Gas Stove and Meter Co., Philadelphia, Pa.	140

VALVES.

Ludlow Valve Manufacturing Co., Troy, N. Y.	134
McNab & Harlin Mfg Co., New York City	102
John McLean, New York City	134

GAS METERS.

Harris, Griffin & Co., Phila., Pa.	138
American Meter Co., New York and Philadelphia....	139
The Goodwin Gas Stove and Meter Co., Phila. Pa.	139
Helme & McIlhenny, Phila., Pa.	139
Maryland Meter and Mfg. Co., Baltimore, Md.	138
D. McDonald & Co. Albany, N. Y.	139
Nathaniel Tufts, Boston, Mass.	138

EXHAUSTERS.

P. H. & F. M. Roots, Connersville, Ind.	129
Smith & Sayre Manufacturing Co., New York City	136
Wilbraham Bros., Philadelphia, Pa.	136

GAS COALS.

Penn Gas Coal Co., Phila., Pa.	137
Perkins & Co., New York City	133
Newburgh Orrel Coal Co., Baltimore Md.	137
Despard Coal Co., Baltimore, Md.	137
Chesapeake and Ohio R.R. Coal Agency, N. Y. City	137
Westmoreland Coal Company, Phila., Pa.	137

GAS ENGINES.

Schleicher, Schumm & Co., Phila., Pa.	112
Continental Gas Engine Co. New York City.	102

GAS LAMPS.

Siemens Regenerative Gas Lamp Co., Philadelphia, Pa.	133
G. Shepard Page, New York City	137

GAS KILNS AND OVENS.

Thompson Gas Kiln and Oven Co., New York City.....	129
--	-----

PURIFIER SCREENS.

John Calot, Lawrence, Mass.	102
----------------------------------	-----

STREET LAMPS.

J. G. Miner, Morrisania, New York City	101
Bartlett Street Lamp Mfg Co., New York City.....	129

BURNERS.

G. Gefroer, Phila., Pa.	134
Walter Anderson, New York City	106

PURIFYING MATERIAL.

Connelly & Co., New York City	130
-------------------------------------	-----

STEAM BLOWER FOR BURNING BREASE.

H. E. Parson, New York City	130
-----------------------------------	-----

PIPE COVERINGS.

Chalmers-Spence Company, N. Y. City.....	130
--	-----

GAS FIXTURES.

Mitchell, Vance & Co., New York City.....	130
---	-----

STEAM ENGINES.

Westinghouse Machine Co., Pittsburgh, Pa.	137
--	-----

STEAM PUMPS.

A. S. Cameron Steam Pump Works, N. Y. City.....	129
---	-----

PIPE CUTTING MACHINE.

Pancoast & Maule, Philadelphia, Pa.	129
--	-----

HYDRAULIC ELEVATOR.

Lane & Bodley Company, Cincinnati, Ohio.....	130
--	-----

SHAFTING, PULLEYS, ETC.

A. & F. Brown, New York City.....	130
-----------------------------------	-----

HYDRAULIC MAIN.

A. E. Boardman, Macon, Ga.	129
---------------------------------	-----

NEW GASHOLDERS.

ENGINEER'S OFFICE,
CONSOLIDATED GAS COMPANY,
BALTIMORE, MD.

SEALED PROPOSALS will be received at this office until 12 o'clock, noon, March, 20, 1885, (at which time and place they will be opened), for the building of TWO TELESCOPIC GASHOLDERS, 87 feet diameter and 45 feet lift, at the Spring Gardens Station. Plans and specifications will be ready for examination on and after March 5. Bids will be considered from manufacturers only who have previously executed such work. The right is reserved to reject any and all bids. Envelopes containing proposals should be marked "Proposals for Gasholders," and be addressed to the CONSOLIDATED GAS COMPANY, 19 South Street, Baltimore, Md.

F. H. HAMBLETON, Engineer.

SOUTHWARK FOUNDRY AND MACHINE COMPANY,

Successors to MERRICK & SONS. Established in 1836.

No. 430 Washington Avenue, Philadelphia, Pa.

MANUFACTURERS OF

Single and Telescopic Gasholders,

BENCH CASTINGS,

Washers, Scrubbers, Condensers, Purifiers,

And all apparatus necessary for the construction of improved new gas works and in the extension of established works. Also manufacturers of

Gas Engines, and of all descriptions of Steam and Hydraulic Machinery, and of Boiler and Tank Work. Plans, specifications, and estimates furnished promptly on application.

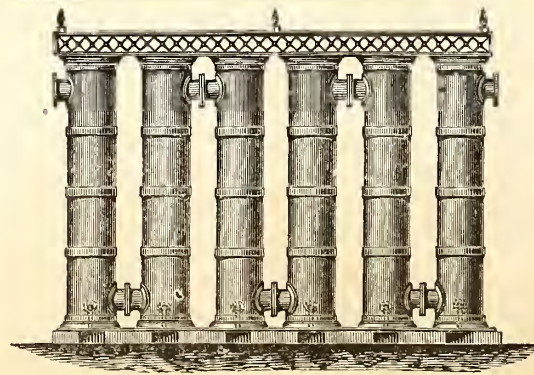

W. E. Tanner, Pres., W. R. Trigg, V.-Pres., A. Delaney, Supt.

Tanner & Delaney Engine Co.
RICHMOND, VA.

Gas Apparatus,

INCLUDING

Condensers of various styles, Scrubbers, Holders, Purifiers, Castings for Retort Houses, Etc.

ALSO STEAM ENGINES AND BOILERS.

Plans, Specifications and Estimates Furnished.

FOR SALE,
The 3 Vols., Bound, of
King's Treatise on Coal Gas.

Almost new. Price, \$21.

Address BOX 305, HAGERSTOWN, MD.

For Sale at a Bargain.

**COMPLETE 4-INCH GAS GEN-
ERATING APPARATUS,**

From our old works. Iron Frame for Roof; Mouthpieces, Stand
Pipes, etc., etc.

Just the thing for adding to capacity of works already in opera-
tion, or for starting a new works. Address

616-8t GAS COMPANY, LIMA, OHIO.

FOR SALE,
100 MINER GLOBE STREET LAMPS.

The lamps have been in use, but only those that are in good
order are offered for sale. For terms, etc., address

THE NEW YORK & NEW JERSEY GLOBE GAS LIGHT CO.,
615-tf No. 1 Park Place, New York City.

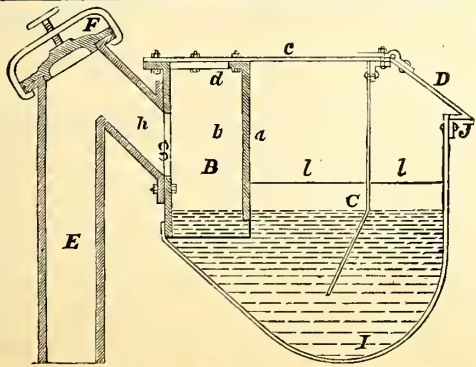

Boardman Hydraulic Main,

Patented October 7, 1884.

For description, see AM. GAS LIGHT JOURNAL of Feb. 2, 1884.
For terms, apply to

A. E. BOARDMAN, Macon, Ga.

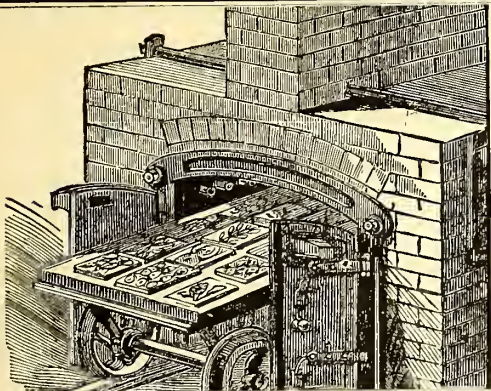

Glass-Staining Gas Kiln.
BAKERS' & CONFECTIONERS' OVENS (PAT.)
Thompson Gas Kiln & Oven Co.

59 Carmine St., N. Y.

Send for Circular by mail.

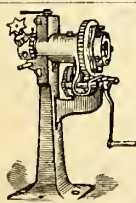

**"ECLIPSE"
HAND PIPE-CUTTING MACHINE.**
Nos. 2 and 3.

Simple, powerful, portable, inex-
pensive. With it one man can easily
cut 6 inch Pipe.

No 2 Cuts and Screws 2 1/2 to 4 in.
No 3 " " " 2 1/2 to 6 in.

PANCOAST & MAULE,
Philadelphia.

WM. FARMER, ENGINEER,
32 Park Place, Room 36, New York.

**THE CHEMIST'S ASSISTANT; OR, KINDERGAR-
TEN SYSTEM OF CHEMISTRY.**

A system by which the elements and their valences are repre-
sented by illustrations and solid bodies.

BOX AND PAMPHLET COMPLETE, \$2.50.

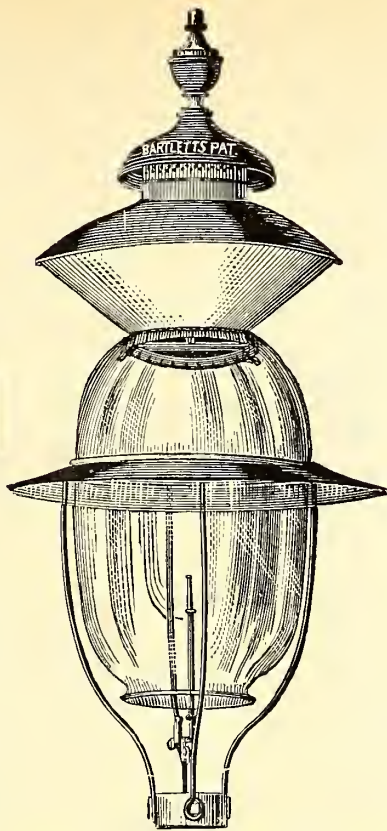

C. BARCALOW, PREST.

J. V. BARCALOW, SEC. & TREAS.

BARTLETT
Street Lamp Mfg. Co.

MANUFACTURERS OF

Bartlett's Patent

GLOBE LAMPS.

FOR

Streets, Parks, Railroad Stations, Public
Buildings, Etc.

LAMP POSTS A SPECIALTY.

Office and Salesroom,

No. 35 Howard Street, N. Y. City.

Gas Companies and others intending to erect lamps and posts
will do well to communicate with us.

F. M. ROOTS.

S. C. ROOTS

D. T. ROOTS.

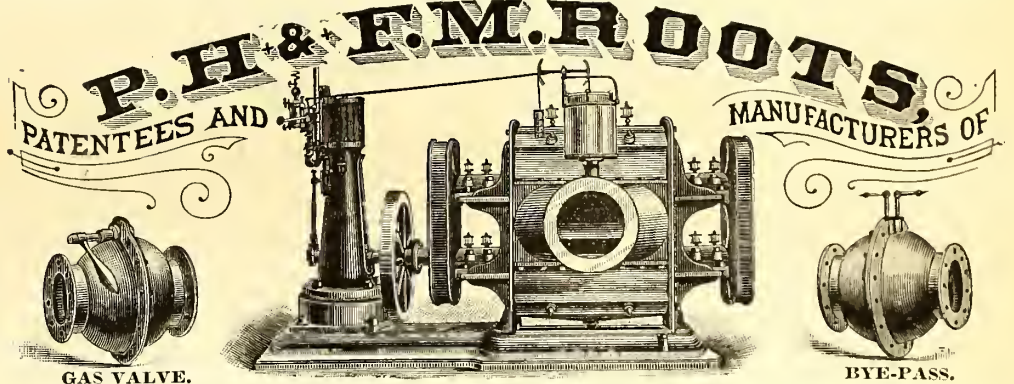

IMPROVED GAS EXHAUSTER,

WITH ENGINE ON SAME BED PLATE, OR WITHOUT.

BYE-PASSES, GAS VALVES, GOVERNORS, ELBOWS, PIPE-FITTINGS, Etc., FURNISHED TO ORDER,

P. H. & F. M. ROOTS, Patentees & Manufacturers, **CONNERSVILLE, IND.**

S. S. TOWNSEND, General Agent, 22 Cortland St. and 9 Dey St., N. Y.

JAS. BEGGS & CO., Selling Agents, 9 Dey St., N. Y.

COOKE & CO., Selling Agents, 22 Cortland St., N. Y.

✽ SEND FOR ILLUSTRATED CATALOGUE AND PRICE LIST. ✽

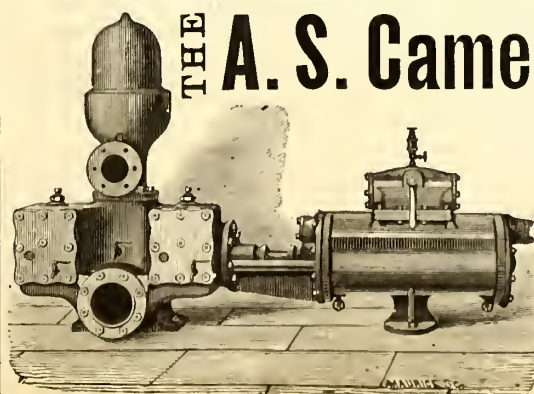

THE A. S. Cameron Steam Pump,

THE STANDARD OF EXCELLENCE.

Upward of 30,000 in Use.

BEST GAS WORKS PUMP

Ever Introduced.

Adapted to Every Possible Duty.

A. S. Cameron Steam Pump Works,

Foot East 23d St., N. Y.

F. J. DAVIS & J. R. FARNUM,
 TRUSTEES AND AGENTS FOR THE
SINUOUS FRICTION CONDENSER.

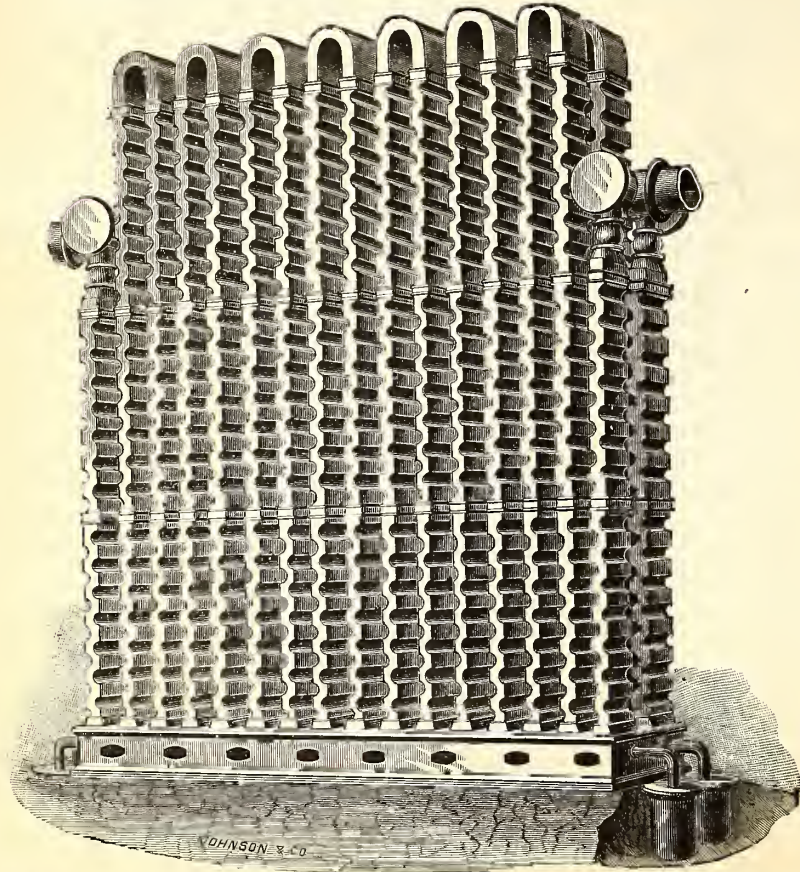

We desire to draw the attention of the gas community to the merits of the **SINUOUS FRICTION CONDENSER**. Companies intending to introduce new condensers into their works will do well to confer with us and examine plans and estimates before contracting for any other pattern. The **FRICTION CONDENSER** is now in use at the gas works located in the following places:

- | | | | |
|--------------------------------|------------------|-------------------------------|---------------------|
| Portland, Me. | Brookline, Mass. | Pawtucket, R. I. | Frederickton, N. B. |
| Newport, R. I. | Chelsea, Mass. | Jamaica Plain, Mass. | St. John, N. B. |
| Gloucester, Mass. | Woburn, Mass. | Attleboro, Mass. | Paterson, N. J. |
| Newton & Water-
town, Mass. | Peoria, Ill. | Calais, Me. | Dover, N. H. |
| | Clinton, Mass. | Fall River, Mass. | Waltham, Mass. |
| | | Nassau Works, Brooklyn, N. Y. | |

DAVIS & FARNUM MFG. CO.

MANUFACTURERS OF

Gas and Water Pipes,

AND

GAS AND WATER MACHINERY

OF THE MOST APPROVED PATTERN.

Also, Gasholders and Iron Roofing.

Orders from Gas and Water Companies promptly attended to.

WALTHAM, MASS.

Boston Office, Room 55, Mason Building, 70 Kilby Street.

OFFICE
 43
 PARK PLACE
 WORKS
 57, 59 AND 61
 LEWIS ST.
 60, 62, 64 & 66
 Cannon
 ST.
 NEW YORK

PROGRESS MACHINE
 WORKS
A. & F. BROWN

**Shafting, Pulleys,
 HANGERS.**

F. Brown's Patent Friction Clutch.

Send for Illustrated Catalogue and Discount Sheet to

A. & F. BROWN,

No. 43 Park Place, New York City.

MITCHELL, VANCE & CO.,

MANUFACTURERS OF

Chandeliers

and every description of

GAS FIXTURES.

Also manufacturers of Fine Gilt Bronzes and Marble Closets warranted best time-keepers. Mantel Ornaments, etc.

Salesrooms, 836 Broadway, N. Y.

Special Designs furnished for Gas Fixtures for Churches, Public Halls, Lodges, etc.

Pipe Coverings.

Fireproof, Non-Conducting Coverings for

**STEAM PIPES, BOILERS,
 And all Hot Surfaces.**

Made in sections three feet long. Easy to apply; light and cheap. Asbestos Materials, Fibre, Braided Packing, and Cement. These goods are used at Continental Works, Bklyn.

CHALMERS-SPENCE COMPANY, 419 & 421 EIGHTH ST., N. Y.

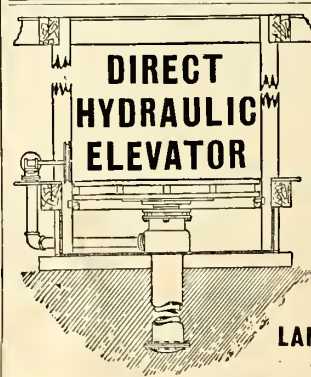

With Iron or Wood Platform.

Largely used by Leading Gas Co.s for Coal and Coke Lifts.

Adapted for use with city service, or special pumping and accumulator system. For prices address the

LANE & BODLEY CO.,
 Cincinnati, O.

Parson's Steam Blower,

FOR IMPROVING BAD DRAUGHT IN BOILERS, AND FOR BURNING BREEZE OR OTHER WASTE MATERIAL.

PARSON'S TAR BURNER,

FOR UTILIZING COAL TAR AS FUEL.

PARSON'S AIR JET TUBE CLEANER,

FOR CLEANING BOILER TUBES.

These devices are all first-class. They will be sent to any responsible party for trial. No sale unless satisfactory. Manufactured by the WATERTOWN STEAM BLOWER COMPANY.

H. E. PARSON, Supt., 42 PINE ST., N. Y.

Iron Sponge,

GAS EXHAUSTERS,

AUTOMATIC GAS GOVERNORS,

CONNELLY & CO., Limited,

No. 407 BROADWAY, NEW YORK CITY.

THE AMERICAN METER COMPANY,

MANUFACTORIES,

512 West Twenty-second Street, N. Y.

Arch and Twenty-second Street, Phila.

Nos. 244 & 246 North Wells Street, Chicago, Ill.

AGENCIES,

No. 177 Elm Street, Cincinnati, Ohio.

Nos. 122 & 124 Sutter Street, San Francisco, Cal.

No. 810 North Second Street, St. Louis, Mo.

ALL SIZES
CONSTANTLY
IN STOCK.

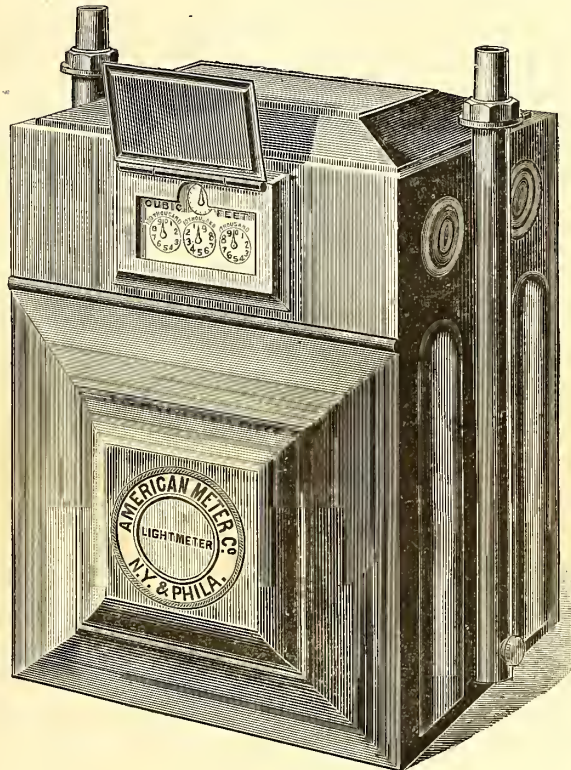

PRICE LISTS
ON
APPLICATION.

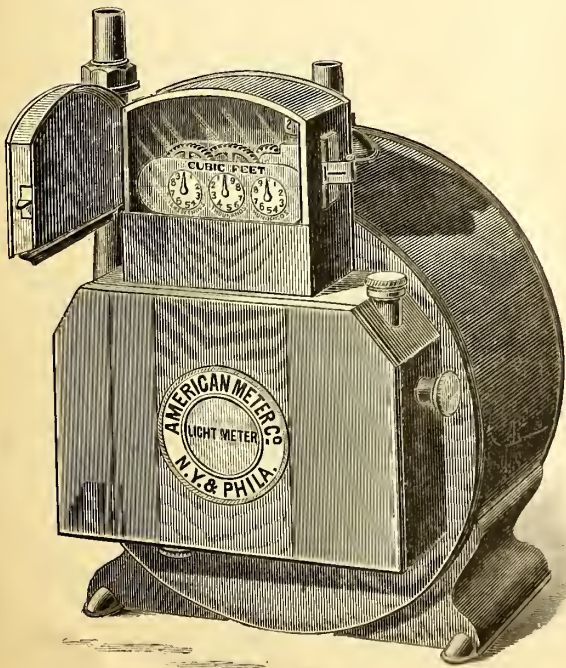

Mfr's of STANDARD WET AND DRY GAS METERS.

J. H. GAUTIER & CO.,
CORNER OF
GREENE AND ESSEX STREETS,
JERSEY CITY, N. J.

MANUFACTURERS OF
**Clay Gas Retorts,
Gas House Tiles,
Fire Bricks, Etc. Etc.**
Ground Clay, Fire Brick and
Fire Sand in Barrels,

J. H. GAUTIER. T. B. GAUTIER.
C. E. GREGORY. C. E. GAUTIER.

BROOKLYN
Clay Retort & Fire Brick Works,
(EDWARD D. WHITE & CO.)
Manufacturers of Clay Retorts, Fire Brick,
Gas House and other Tile.
VAN DYKE, ELIZABETH, RICHARDS & PARTITION STS.
Office, 88 Van Dyke St., Brooklyn, N. Y.

LACLEDE FIRE BRICK MFG. CO.,
MANUFACTURERS OF
Fire Brick, Gas Retorts,

AND
ST. LOUIS STANDARD SEWER PIPE.
Blast Furnace and Cupola Linings, every description of Fire
Clay Material, Fire Clay Flue Linings, Chimney Tops
Dry Milled and Crude Fire Clays, etc.
OFFICE AND DEPOT
901, 903, and 905 Pine Street,
ST. LOUIS, MO.

ESTABLISHED IN 1845.
B. KREISCHER & SONS,
OFFICE FOOT OF HOUSTON ST., E. R., N. Y.
**Gas Retorts,
TILES, FIRE BRICK.**
AND EVERYTHING IN THE FIRE CLAY LINE.

MANHATTAN
FIRE BRICK & ENAMELLED CLAY
RETORT WORKS.
ADAM WEBER.

**CLAY GAS RETORTS
AND RETORT SETTINGS,
FIRE BRICKS, TILES, ETC.,**
Office and Works, 15th Street and Avenue C., N. Y.

Borgner & O'Brien,
MANUFACTURERS OF
**CLAY GAS RETORTS
AND RETORT SETTINGS,
FIRE BRICKS, TILES, ETC.**
23d St., Above Race,
PHILADELPHIA.
TWENTY YEARS' PRACTICAL EXPERIENCE.

JAMES GARDNER, JR.
Works,
LOCKPORT STATION, PA.

—ESTABLISHED 1864.—
WILLIAM GARDNER & SON,
Successor to GARDNER BROTHERS.

WILLIAM GARDNER.
Office, COAL EXCHANGE,
PITTSBURGH, PA., P. O. Box 373.

Fire Clay Goods for Gas Works.

C. H. SPRAGUE, No. 70 KILBY STREET, BOSTON, MASS., Agent for the New England States.

OFFICE, 418 to 422 East 23d St., New York.

ESTABLISHED 1856.

WORKS, PERTH AMBOY, NEW JERSEY.

HENRY MAURER,
Excelsior Fire Brick & Clay Retort Works
CLAY GAS RETORTS, BENCH SETTINGS, FIRE BRICK, TILES, ETC.

STANDARD GAS RETORT AND FIRE BRICK COMPANY,
J. ANDERSON, PRES. & MANG'R. OF IRONTON, OHIO. C. PETERS, SECRETARY.
Clay Gas Retorts, Fire Brick, and Fire Clay Goods of Every Description.
Plans of Livesey-Somerville, McIlhenny, and other Furnaces, and Competent Workmen Supplied.

CHICAGO
Retort & Fire Brick Works,
Office, Factory,
79 Dearborn St., Unity Building. | 45th and Clark Sts.
CHICAGO, ILL.
GEORGE C. HICKS, PRES. PAUL P. AUSTIN, SEC. & TREAS.
STANDARD
**Clay Retorts and Settings.
BLOCKS & TILES**
of every Shape and Size to Order.
Standard Fire Bricks.

CINCINNATI
Gas Retort & Fire Brick Co.,
(ESTABLISHED 1872.)
CINCINNATI, OHIO.
Manufacturers of Gas Retorts, Retort Set-
tings, Fire Brick, Tiles, Etc.

OAKHILL
GAS RETORT & FIRE BRICK
COMPANY.
PARKER, RUSSELL & CO.
City Office, 45th & Clark Sts.,
ST. LOUIS, MO.

Our immense establishment is now employed almost entirely in
the manufacture of
MATERIALS FOR GAS COMPANIES.
We have studied and perfected three important points. Our re-
torts are made to stand changes of temperature, the strongest
heats of the furnace, and the abrasion of feeding and emptying.
Our customers are in almost every State of the Union, to all of
whom we refer.

THOS. SMITH, Prest. AUGUST LAMBLA, Vice-Prest. & Sup
BALTIMORE
RETORT & FIRE BRICK CO.
MANUFACTORY AT
LOCUST POINT, BALTIMORE, MD.
Connection with the City by Telephone.
**Clay Retorts, Blocks & Tiles,
FIRE BRICK, FIRE CLAY,
AND FIRE CEMENT.**

Red and Buff Ornamental Tiles and Chim-
ney Tops. Drain and Sewer Pipe (from
2 to 30 inches). Baker Oven Tiles
12 x 12 x 2 and 10 x 10 x 2.
WALDO BROS., 88 WATER ST., BOSTON, MASS.
Sole Agents for New England States

Siemens's Regenerative Gas Burners, For Lighting and Ventilating.

THE CHEAPEST, PUREST, AND MOST BRILLIANT OF ALL GAS LIGHTS.

Superior to the Electric Light in Economy, Beauty, & Steadiness.

SPECIALLY ADAPTED FOR LIGHTING HALLS, FACTORIES, OPEN SPACES, ETC.

Numerous Tests made by various Gas Companies in the United States show an Efficiency of Ten Candle Power per Cubic Foot of Gas.

General Agents:

- SIEMENS LIGHTING CO., 347 West Main St., Louisville, Ky.
- MEYER, MARSHALL & CO., 528 California St., San Francisco.
- DENNEHY, WOLF & O'BRIEN, 85 & 87 Dearborn St. Chicago, Ill.
- WILCOX & McGEARY, - No. 11 Bissel Block, Pittsburgh, Pa.
- T. T. RAMSDALL & CO., - 20 Swan Street, Buffalo, N. Y.
- SIEMENS GAS ILLUMINATING CO.,
Room 6, No. 157 Broadway, New York City.
- W. D. COLT, - - - - 1420 F Street, Washington, D. C.
- JOHN KIEFER, - - - 344 Lawrence, Street, Denver, Col.

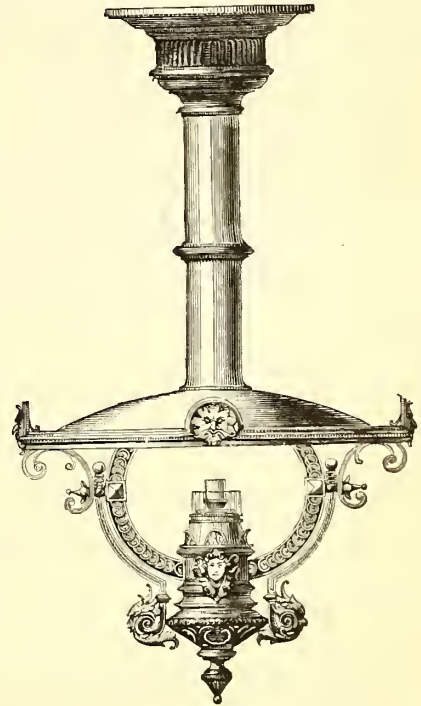
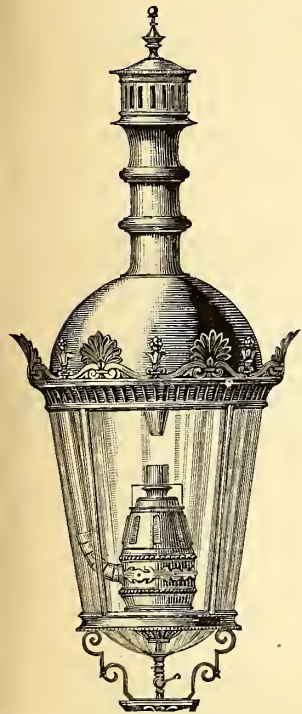

THE SIEMENS REGENERATIVE GAS LAMP COMPANY,

SOLE MAKERS FOR THE UNITED STATES,

N. E. Cor. 21st. St. and Washington Av., Philadelphia, Pa.

THE "STANDARD" WASHER-SCRUBBER,

KIRKHAM, HULETT & CHANDLER'S PATENT.

Total Capacity per 24 Hours of "Standard" Washers Ordered During the Following Years.

1877.....	4,000,000 cubic feet.
1878.....	4,750,000 "
1879.....	24,545,000 "
1880.....	42,907,500 "
1881.....	36,462,500 "
1882.....	39,300,000 "
1883.....	57,735,000 "
1884.....	26,177,500 "
Total.....	235,937,500 cubic feet.

Total Number and Capacity per 24 Hours of "Standard" Washers Erected and in Course of Erection in the Several Countries

	Number.	Cubic Feet per Day.
Great Britain..	151	157,070,000
Western Hemisphere.....	38	39,337,500
Australia.....	18	12,150,000
New Zealand.....	2	650,000
France.....	6	4,550,000
Belgium.....	8	5,420,000
Germany.....	16	8,200,000
Holland.....	4	4,160,000
Denmark.....	1	150,000
Russia.....	2	3,500,000
Spain.....	1	350,000
India.....	1	400,000
Total.....	248	235,937,500

THE CONTINUED POPULARITY Of these Machines

Will be recognized from the following extracts from letters from representatives of some of the companies having them in use:

TOLEDO GAS LIGHT AND COKE CO., }
TOLEDO, OHIO, NOV. 25, 1884. }

GEO. SHEPARD PAGE, Esq.:

Dear Sir—Replying to your kind favor of 21st inst., I would say that the "Standard" Washer-Scrubber is doing work that is entirely satisfactory to us. During the summer I had 12-oz. liquor; but since cool weather commenced I have been having from 18 to 23-oz. liquor, just as we would elect. There is not a trace of ammonia passing the Scrubber that a test of reddened litmus or yellow turmeric paper would indicate. The machine, in my opinion, is all that could be desired as a means for removing all the ammonia from the gas. Very respectfully,

C. R. FABEN, Jr.,

Superintendent.

"Standard" Washers Ordered During the Current Year.

	Cu. Ft. per Day
Anneberg Gas Co.....	200,000
Bombay Gas Co.....	400,000
Brussels Co.....	1,250,000
Chemnitz Gas Co.....	1,000,000
CITIZENS GAS CO., BUFFALO.....	750,000
Coke Works in Zabre, Ober-Schlesien.....	1,500,000
Cokerei der Friedenshutte, Upper Silesia.....	1,000,000
Dumfries Corporation.....	250,000
Dunedin Gas Co., New Zealand.....	400,000
King's Lynn Gas Co.....	300,000
Lelden, Holland.....	600,000
Lincoln Gas Co.....	400,000
Liverpool Gas Co.....	2,000,000
" ".....	3,000,000
LOUISVILLE GAS CO.....	1,500,000
Numea Gas Co.....	100,000
PITTSBURGH GAS CO.....	1,500,000
PORTLAND GAS CO., Oregon.....	502,500
SAN FRANCISCO GAS CO.....	4,000,000
Sheepbridge.....	40,000
ST. LOUIS GAS CO.....	2,000,000
Sydney Gas Co.....	2,500,000
WASHINGTON, D. C. GAS CO.....	2,000,000
Whitechurch Gas Co.....	175,000
Total.....	26,177,500

GEO. SHEPARD PAGE, No. 69 WALL STREET, NEW YORK,

SOLE AGENT FOR THE WESTERN HEMISPHERE.

A. H. M'NEAL,

BURLINGTON, N. J.

Flange-Pipes

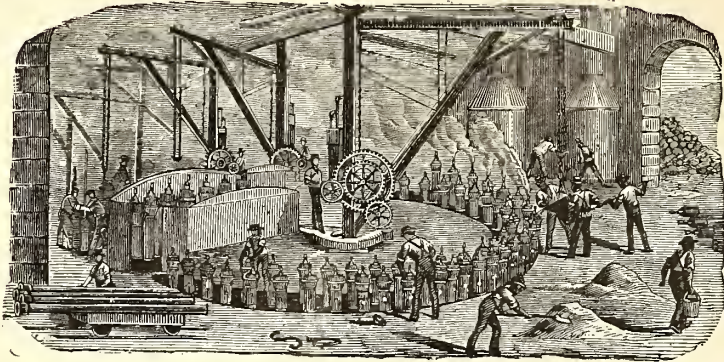

General Foundry Work.

CAST IRON PIPES FOR WATER AND GAS.

JAMES S. MOORE, Pres.
BENJAMIN CHEW, Treas.

JAS. P. MICHELLON, Sec.
WM. SEXTON, Supt.

GLOUCESTER IRON WORKS, GLOUCESTER CITY N. J.

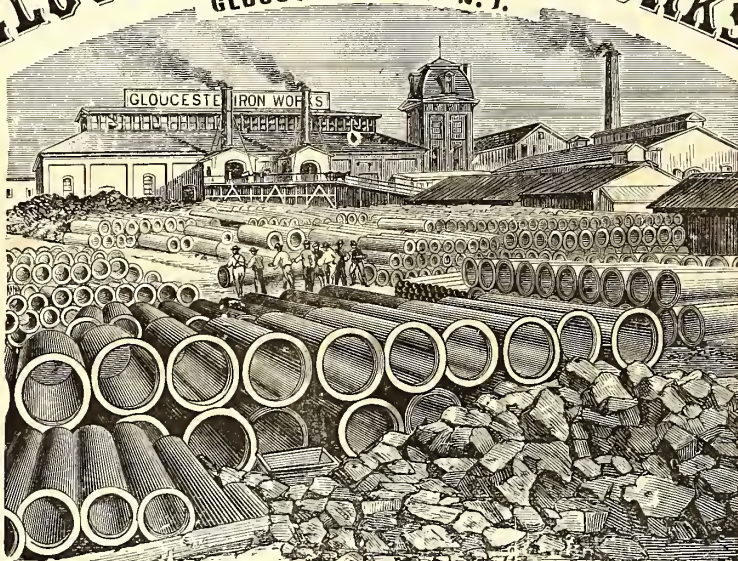

Cast Iron Gas & Water Pipes, Stop Valves, Fire Hydrants, Gasholders, &c.
Office No. 6 North Seventh Street, Philadelphia.

ESTABLISHED 1856.

WARREN FOUNDRY AND MACHINE CO.,

WORKS AT PHILLIPSBURGH, N. J.
NEW YORK OFFICE, 162 BROADWAY.

Cast Iron Water and Gas Pipe

FROM TWO TO FORTY-EIGHT INCHES DIAMETER.
ALSO ALL SIZES OF

FLANGE PIPE for Sugar House and Mine Work.
Branches, Bends, Retorts, Etc., Etc.

MATTHEW ADDY, President.

W. L. DAVIS, Selling Agent.

GEO. P. WILSHIRE, Sec. & Treas.

Cincinnati and Newport Iron and Pipe Company, NEWPORT, KY.

Lamp Posts
AND
BENCH CASTINGS



Branch
AND
SPECIAL CASTINGS

A Specialty.

Large & Heavy Castings for General Work.

FOR GAS & WATER CO'S.

Manufacture Pipe from 2 to 48 inches. All work guaranteed first quality.

Mellert Foundry and Machine Co.

Limited. Established 1848.
MANUFACTURERS OF



Specials—Flange Pipe, Valves and Hydrants,
Lamp Posts, Retorts, etc.
Machinery and castings for Furnaces, Rolling Mills, Grist and
Saw Mills, Mining Pumps, Hoists, etc.

GENERAL OFFICE, - - - READING, PA.

To Gas Companies.

We make to order **CAP BURNERS** to burn any amount
under a stated pressure. Send for samples.
Also, **SERVICE CLEANERS, DRIP PUMPS,** and **STREET
MAIN PROVING APPARATUS.**

C. A. GEFRORER,
248 N. 5th Street, Phila., Pa.

MORRIS, TASKER & CO.,
Limited,
Builders of Gas Works,
PHILADELPHIA, PA.

LUDLOW VALVE MFG. CO

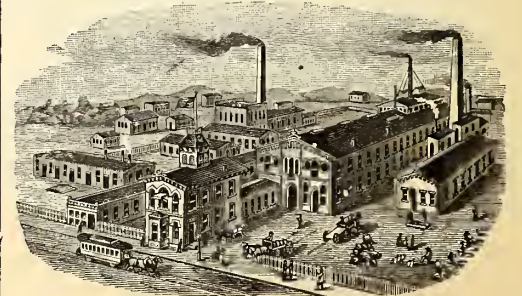

OFFICE AND WORKS,
938 to 954 River Street and 67 to 83 Vail Av.,
TROY, N. Y.

Hydraulic Main Dip Regulators, also
Check Valves, Foot Valves, Yard-
wash and Fire Hydrants.
Send for Circulars.

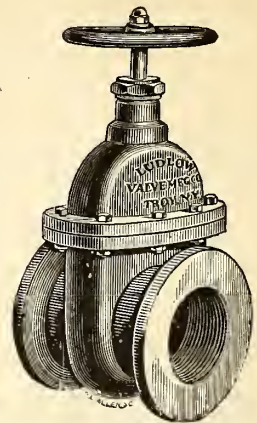

Valves.—Double and Single Gate, 1/2 in. to
48 in., outside and inside Screws. Indica-
tor, etc., for Gas, Water, Steam, and Oil.
Send for Circulars.

John McLean
Man'furer of
**GAS
VALVES.**
298 Monroe Street, N. Y.

WM. HENRY WHITE,

Consulting & Constructing
Gas Engineer & Contractor.

ESTIMATES, PLANS, AND SPECIFICATIONS FURNISHED
FOR NEW WORKS OR EXTENSIONS OF
EXISTING WORKS.

32 Pine St., New York City.

Correspondence solicited.

JAMES R. FLOYD,
 (SUCCESSOR TO HERRING & FLOYD)
Oregon Iron Works,
 531 to 543 West 20th St., N. Y.
Practical Builders of Gas Works,
 MANUFACTURERS OF
ALL KINDS OF CASTINGS
 AND
APPARATUS FOR GAS-WORKS.

BENCH CASTINGS
 from benches of one to six Retorts each.
WASHERS: MULTITUBULAR AND
AIR CONDENSERS; CONDENSERS;
SCRUBBERS
 (wet and dry), and
EXHAUSTERS
 for relieving Retorts from pressure.
BENDS and BRANCHES
 of all sizes and description.
FLOYD'S PATENT
MALLEABLE RETORT LID.
PATENT
SELF-SEALING RETORT LIDS.
FARMER'S
PATENT BYE-PASS DIP-PIPE.
SABBATON'S PATENT
FURNACE DOOR AND FRAME.
BUTLER'S
COKE SCREENING SHOVELS.
GAS GOVERNORS,
 and everything connected with well regulated Gas Works at
 low price, and in complete order.
SELLER'S CEMENT
 for stopping leaks in Retorts.
N. B.—STOP VALVES from three to thirty inches—
 at very low prices.
 Plans, Specifications, and Estimates furnished.

KERR MURRAY MFG. CO.,
 MANUFACTURERS OF
Single Lift and Telescopic
GASHOLDERS.

Built, 1884:

Altoona, Pa	Capacity, 160,000 cubic feet.
Pittsburgh, Pa	250,000 "
"	230,000 "
Bellaire, Ohio	50,000 "
Youngstown, Ohio	60,000 "
Canton, "	60,000 "
Akron, "	80,000 "
Xenia, "	10,000 "
Adrian, Mich.	65,000 "
Ypsilanti, Mich.	25,000 "
Muskegon, "	70,000 "
South Bend, Ind.	70,000 "
Anderson, "	20,000 "
Plainfield, "	10,000 "
Springfield, Illinois	100,000 "
Evanston, "	50,000 "
Freeport, "	35,000 "
Elgin, "	60,000 "
Sheboygan Wis.	20,000 "
Key West Fla.	10,000 "

Plans and estimates furnished for the erection of
 new and the rebuilding of old works. Address
Kerr Murray Mfg. Co.,
FORT WAYNE, IND.

CONTINENTAL WORKS.



T. F. ROWLAND, Proprietor,
GREENPOINT, BROOKLYN, N. Y.
 ENGINEER AND MANUFACTURER OF
GAS-HOLDERS.
CONDENSERS, SCRUBBERS, VALVES,
PURIFIERS, RETORTS, and HY-
DRAULIC MAINS,
 and all other articles connected with the Manufacture
 Distribution of Gas. Plans and Specifications prepared
 and Proposals given for the necessary Plant for Lighting
 Cities, Towns, Mansions, and Manufactories.

GASHOLDERS OF ANY MAGNITUDE.

H. RANSHAW, Prest. & Mangr. WM. STACEY, Vice-Pres. T. H. BIRCH, Asst. Mangr. R. J. TARVIN, Sec. & Treas.

STACEY MFG. CO.,
 MANUFACTURERS OF
Single and Telescopic Gasholders,
IRON ROOFS, BRIDGES, LAMP POSTS,
Water and Oil Tanks, Coal Elevator Cars,
COKE CRUSHERS, BENCH CASTINGS,
 And all kinds of Wrought and Cast Iron Work used in the erection of Coal and Oil Gas Works.
 Rolling Mill Machinery and Heavy Castings a Specialty.

Foundry: 33, 35, 37 & 39 Mill Street. **Wrought Iron Works:** 16, 18, 20, 22, 24 & 26 Ramsey Street.
Cincinnati, Ohio.

BARTLETT, HAYWARD & CO.,
 Office, 24 Light. **BALTIMORE, MD.** Works, Pratt & Sc



PURIFIERS. **Roofs.** **Bench Castings.** **CONDENSERS.** **SCRUBBERS.** **BOILERS.**

GASHOLDERS.
 CONSTRUCTING ENGINEERS AND BUILDERS OF GAS WORKS.

1842. **DEILY & FOWLER,** 1884.
Laurel Iron Works.
 Address, No. 3 Laurel Street, Philadelphia, Pa.
 MANUFACTURERS OF
GASHOLDERS,
 Single or Telescopic, with Cast or Wrought Iron Guide Frames.
Holders Built Since 1880:

Mount Joy, Pa.	West Point, N. Y.	Galveston, Texas (2d.)	Kalamazoo, Mich. (3d.)	Newport, R. I.
Rockaway B'ch, N.Y. (2)	Fitchburg, Mass.	Marlboro, Mass.	Glen Island, N. Y.	Portland, Oregon.
Zanesville, O. (2d.)	New London, Conn.	Denver, Col.	Warren, Ohio.	Allegheny, Pa. (3d.)
Lancaster, O.	Derby, Conn.	Chicago, Ill. (West Side)	Bath, N. Y.	Atlanta, Ga. (2d.)
Blackwell's Island N. Y.	Bridgeport, Conn.	Pittsburgh, Pa. (S. Side)	Lynn, Mass.	N.Y. City (Central Gas Co)
Waltham, Mass. (1st.)	Allegheny, Pa. (1st.)	Pawtucket, R. I.	New Bedford, Mass.	Lynchburg, Va. (2d.)
Dorchester, Mass.	St. Hyaclnth, Can.	Brookline, Mass.	Waterbury, Conn.	Lynchville, R. I.
Wheeling, West Va.	Norwalk, O.	Sherbrooke, Can.	Deseronto, Can.	Rondout, N. Y.
Lansing, Mich.	Waltham, Mass. (2d.)	Burlington, N. J. (2d.)	Hooole Falls, N. Y. (2d.)	Atlantic City, N. J.
Flint, Mich.	West Chester, Pa.	Bridgeton, N. J.	Bethlehem, Pa.	Augusta, Ga.
Galveston, Texas (1st.)	Baltimore, Md.	Bay City, Mich.	Atlanta, Ga. (1st.)	Waltham, Mass. (3d.)
Milton, Pa.	Holidaysburg, Pa.	Erie, Pa.	Savannah, Ga.	
Scranton, Pa.		Jackson, Mich.	Montgomery, Ala	

GAS COALS.

GAS COALS.

GAS COALS.

JAMES D. PERKINS.

PERKINS & CO.,

F. SEAVERN.

General Sales Agents.

THE YOUGHIOGHENY RIVER COAL COMPANY,

Organized August 1, 1882.

MINERS AND SHIPPERS OF THE WELL-KNOWN

Ocean Mine Youghioghenny Gas Coal.

The Coal from the Ocean Mine (recently operated by Messrs. W. L. Scott & Co., of Erie, Pa.,) is now used by all the leading Gas Companies in the United States from Maine to Texas, and is recognized as *the only reliable Youghioghenny Gas Coal.*

Messrs. W. L. Scott & Co. and W. L. Scott, Esq., still retain their interest in the new Company, and the same general policy which has characterized the management of the mine under these gentlemen will be continued by the new Company. With largely increased facilities and *unlimited supply of Coal*, any demand made upon the Colliery will meet with prompt fulfillment.

THE UNDERSIGNED CAN SUPPLY THE FOLLOWING SUPERIOR GRADES OF

GAS CANNELS:**Abram Cannel**, from the Abram Colliery, Wigan, England,**Plesio-Boghead Cannel**, from near the old Boghead Colliery, Scotland.**North Ince Hall Cannel**, from Liverpool, England.

Breckenridge Cannel, from Kentucky. The railroad now being constructed to the Ohio river will open up this superior Cannel deposit, and enable us to deliver it at any required point. See full description of this Cannel, and Map of the Colliery, in the "American Gas Light Journal," April 16, 1883, pages 172 and 173.

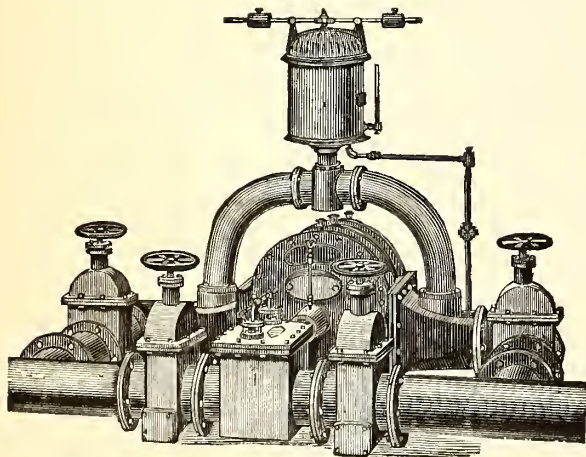
P. O. Box 3695,
New York.**PERKINS & CO., 228 and 229 N. Y. Produce Exchange****BEAVER STREET
ENTRANCE.****SMITH & SAYRE MFG. COMPANY,**

G. G. PORTER, Prest.

245 Broadway, N. Y.

CHAS. W. ISBELL, Sec'y.

Machinery & Apparatus for Gas Works

Drawings, Plans, and Estimates Furnished for the Improvement, Extension, or Alteration of Gas Works, or for the Construction of New Works.

Mackenzie's Patent Rotary and Steam Jet Gas Exhausters, Governors, Compensators, Condensers, Washers, Scrubbers. Isbell's Patent Automatic Street Pressure Governor, Gas and Water Valves, Hydraulic Main Dip Regulator, Bench Castings, etc. Purifying Boxes and "Standard" Scrubbers. Isbell's Patent Self-Sealing Retort Doors.

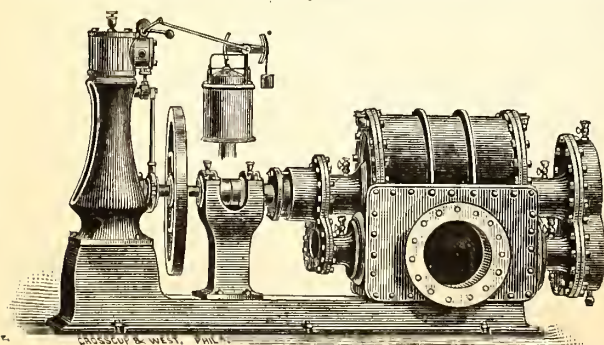
**The Wilbraham Gas Exhauster,**
"BAKER SYSTEM,"

WITH ENGINE ATTACHED, ON SAME BED PLATE OR WITHOUT.

Best, Cheapest and Most Durable Exhauster known.

WILBRAHAM BROS.,

No. 2320 Frankford Avenue, Philadelphia, Pa.

GAS COALS.

GAS COALS.

GAS COALS.

Newburgh Orrel Coal Co.,

MINERS AND SHIPPERS OF

**Newburgh Orrel, Tyrconnell
and Palatine Gas Coals.**

ALSO SHIPPERS OF FOUNDRY COKE.

Mines Situated at

Newburgh, Flemington & Fairmont, W.Va.

HOME OFFICE,

25 S. Gay St., Baltimore.

**CHARLES MACKALL,
MANAGER.**

CHAS. W. HAYS, Agent in New York,

Room 92, WASHINGTON BUILDING, No. 1 Broadway.

Shipping wharves at Locust Point. References furnished when required. Special attention given to chartering vessels.

THE DESPARD COAL COMPANY

OFFER THEIR SUPERIOR

DESPARD COAL

To Gas Light Companies and Manufacturers of Fire Clay Goods
Throughout the Country.

ROUSSEL & HICKS, } AGENIS. { BANGS & HORTON,
71 Broadway, N. Y. } 16 Kilby St., Boston.

Mines in Harrison Co., West Va. Wharves, Locust Point, Balt.

Company's Office, 15 German St., Baltimore, Md.

Among the consumers of Despard Coal we name: Manhattan
Gas Light Co., N. Y.; Metropolitan Gas Light Co., N. Y.; Jersey
City, (N. J.) Gas Light Co.; Washington (D. C.) Gas Light Co.;
Portland (Maine) Gas Light Co. Reference to them is requested.

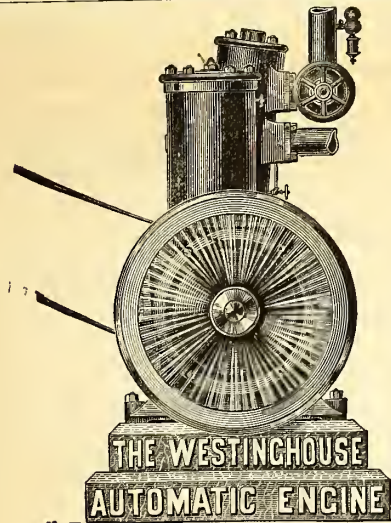

1,300 Engines Now in Use.

40,000 H.P. NOW RUNNING!

Sales, 2,000 H.P. per Month!

SEND FOR ILLUSTRATED CIRCULAR AND REFERENCE LIST.

Westinghouse Machine Co.,

PITTSBURCH, PA.

SALES DEPARTMENT CONDUCTED BY

Westinghouse, Church, Kerr & Co., 17 Cortlandt
Street, New York City.

Fairbanks, Morse & Co., Chicago, Cincinnati, Cleve-
land, Louisville, and St. Paul.

Fairbanks & Co., St. Louis, Indianapolis, and Denver.

Parke & Lacy, San Francisco, and Portland, Or.

Parke, Lacy & Co., Salt Lake City, Utah, and Butte,
Montana.

D. A. Tompkins & Co., Charlotte, N. C.

Keating Implement & Machine Co., Dallas, Texas

Imray & Co., Sydney and Melbourne, Australia.

R. Rogers, 43 Rue Laiffe, Paris.

F. E. Averill, Delft, Holland.

**THE
PENN GAS COAL COMPANY**

OFFER THEIR

COAL, CAREFULLY SCREENED,

AND PREPARED FOR

GAS PURPOSES.

Their Property is located in the Youghiogheny Coal Basin, near Irwin's and Penn Station
in the Pennsylvania Railroad, and on the Youghiogheny River.

OFFICES

No. 209 South Third Street, Phil'a. 90 Wall Street, New York.

PLACES OF SHIPMENT.

Pennsylvania Railroad, Pier No. 2 (Lower Side).

Greenwich Wharves, Delaware River.

366-1y Pier No. 1 (Lower Side), South Amboy, N. J.

Chesapeake & Ohio Railway Coal Agency,

FOR THE SALE OF THE

**Superior Kanawha Gas Coals, Cannelton Cannel,
Also, SPLINT AND STEAM COALS,**

From the Kanawha and New River Regions, on the line of the Chesapeake & Ohio R'way.

C. B. ORCUTT, Sales Agent. | OFFICE, 150 BROADWAY, N. Y.

FRANCIS H. JACKSON, PRESIDENT.

EDMUND H. McCULLOUGH, SEC. & TREAS.

THE WESTMORELAND COAL CO.

Chartered 1854.

Mines situated on the Pennsylvania and the Baltimore
and Ohio Railroads, in Westmoreland County, Penn.

POINTS OF SHIPMENT:

PHILADELPHIA, BALTIMORE, SOUTH AMBOY, N. J.

WATKINS (SENECA LAKE), N. Y.

Since the commencement of operations by this Company its well-known
Coal has been largely used by the Gas Companies of New England and the
Middle States, and its character is established as having no superior in gas-
giving qualities, and in freedom from sulphur and other impurities.

Principal Office, 224 South 3d St., Phila., Pa.

The Bower Gas Lamp.

The Perfected Duplex-Regenerative Gas Burner, under
the combined Patents of Anthony S. Bower,
Geo. S. Grimston, and Thos. Thorp.

The First Gold Medal awarded at the Crystal Palace Exhibition in
London, and two Gold Medals at the Stockport (Eng.) Exhibition of Gas
Appliances. Both in 1883.

GEO. SHEPARD PAGE, JOHN BOWER,
69 Wall Street, N. Y. City.

The Management of Small Gas Works.

By C. J. R. HUMPHREYS. Price, \$1.

A. M. CALLENDER & CO., 42 Pine St., N. Y.



INTERNATIONAL--1876--EXHIBITION.

The U. S. Centennial Commission

HAVE DECREED AN AWARD TO

HARRIS, GRIFFIN & CO.,

12th and Brown Sts., Philadelphia, and 49 Dey St., N. Y., U. S. A.,

FOR THE FOLLOWING REASONS:

The Exhibit consists of a Series of METERS from the Largest Size Station Meters for the use of the MANUFACTURE OF GAS, to those for the use of the ORDINARY CONSUMER. The Instruments are WELL MADE, RELIABLE as to INDICATION, and embody a number of sundry improvements which, with the general character of the Exhibit, entitle the whole to commendation.

Attest—J. L. CAMPBELL,
Secretary, pro-tem.

Signed—A. T. GOSHORN,
Director General

J. R. HAWLEY,
President

CHARLES E. DICKEY.

JAMES B. SMALLWOOD.

CHARLES H. DICKEY.

Maryland Meter and Manufacturing Co.,
DICKEY, TANSLEY & CO.,

Established 1866.

Nos. 22 and 24 Saratoga Street, Baltimore, Md.
No. 46 La Salle St., Chicago, Ill.

MANUFACTURERS OF

DRY GAS METERS, STATION METERS, GLAZED METERS, TEST METERS, METER PROVERS, PRESSURE AND VACUUM REGISTERS, GOVERNORS, INDICATORS, SERVICE AND METER COCKS, AND METER CONNECTIONS.

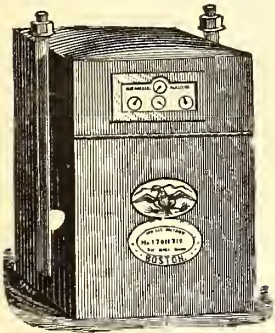

Dry Gas Meter.

With 39 years' experience and the best facilities for manufacturing, is enabled to furnish reliable work and answer orders promptly.

NATHANIEL TUFTS,

No. 153 Franklin Street, Boston, Mass.,

MANUFACTURER OF

DRY GAS METERS.

Station Meters of any Capacity.

Test and Experimental Meters, Pressure Registers, Pressure Gauges, Pressure and Vacuum Gauges.

METER PROVERS, PHOTOMETERS, STREET LANTERNS, ETC., ETC.

Patent Cluster Lanterns for Street Illumination.

R. D. WOOD & CO.,

400 Chestnut Street, Phila., Pa.

Cast Iron Gas & Water Pipe, Water Machinery & Gas Apparatus

Cast Iron Pipe, Fire Hydrants, Eddy Valves, Lamp Posts, Large Loam Castings, Flanged Pipe, Sugar House Work, Iron Roofs and Floors, Wrought & Cast Iron Tanks, Turbine Water Wheels and Pumps.

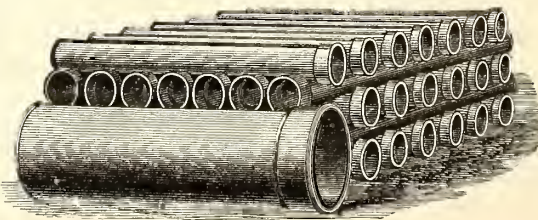

Casholders, Lime Trays, Center Valves, Purifiers, Bench Work, Exhausters, Condensers, Governors, Scrubbers, Gas Valves, Station Meters, Cast Iron Pipe Fittings.

Manufacturers of Heavy Castings and Machinery of Every Description.

ENGINEERS & CONTRACTORS FOR THE ERECTION OF GAS WORKS, & ALL MACHINERY CONNECTED THEREWITH

Estimates and specifications furnished for erection of new works or the extension or alteration of old ones.

Foundries and Works, - - Millville, Florence, and Camden, N. J.

T. C. HOPPER, Pres. G. J. McGOURKEY, Vice-Pres. (New York): WM. N. MILSTED, Gen. Supt. & Treas. (New York). WM. H. DOWN Sec.

AMERICAN METER COMPANY,

WET AND DRY GAS METERS. STATION METERS. EXHAUSTER GOVERNORS. DRY CENTRE VALVES. GOVERNORS FOR GAS WORKS. PRESSURE REGISTERS. PRESSURE & VACUUM REGISTERS. PRESSURE & VACUUM GAUGES. CRESSON GAS REGULATORS. MARSLAND WATER METERS. METER PROVERS. PORTABLE TEST METERS. EXPERIMENTAL METERS. AMMONIA TEST METERS. BAR AND JET PHOTOMETERS.

Manufactories:
512 W. 22d St., N. Y.
Arch & 22d Sts., Phila.

GAS STOVES,
SUGG'S "STANDARD" ARGAND BURNERS,
SUGG'S ILLUMINATING POWER METER,
Wet Meters, with Lizar's "Invariable Measuring" Drum.

Agencies:
177 Elm Street, Cincinnati.
244 & 246 N. Wells Street, Chicago.
810 North Second Street, St. Louis.
122 & 124 Sutter St., San Francisco.

HELME & McILHENNY,

Successors to Harris & Brother.

ESTABLISHED 1848.

PRACTICAL GAS METER MANUFACTURERS,

Continue as heretofore at the OLD ESTABLISHMENT, Nos. 1115 and 1117 Cherry Street, Philadelphia, Pa.

To manufacture Wet and Dry Gas Meters, Station Meters, Experimental Meters, Meter Provers, Centre Seals, Governors, Pressure Registers, Indicators, Photometers, and all kinds of Gas Apparatus; Also furnish all other Articles appertaining to the use of Gas Works.

From our long Practical Experience of the Business (covering a period of 33 years) and from our personal supervision of all Work, we can guarantee all orders to be executed promptly, and in every respect satisfactorily.

WILLIAM HELME.

JOHN McILHENNY.

WM. WALLACE GOODWIN, Pres. and Treas.

WM. H. MERRICK, V.-Pres.

S. L. JONES, Sec.

S. V. MERRICK, Asst. Sec

THE GOODWIN GAS STOVE AND METER COMPANY,

Successors to W. W. GOODWIN & CO.

1012, 1014 and 1016 Filbert St., Phila., Pa. 142 Chambers St., New York.
76 Dearborn St., Chicago, Ill.

WALDO BROS., Agents, 88 Water St., Boston.

MANUFACTURERS OF THE "SUN DIAL" GAS STOVES, FOR COOKING AND HEATING PURPOSES.

Dry and Wet GAS METERS, Station Meters (Square, Cylindrical or in Staves) Glazed Meters, King's and Sugg's Experimental Meters, Lamp Post Meters, Etc., Etc., Meter Provers (sizes 2, 5 and 10 feet), Pressure Guages of all kinds, Pressure Registers, Pressure and Vacuum Registers, Pressure Indicators (sizes 4 inch, 6 inch and 9 inch), King's Pressure and Vacuum Gauges, Dry and Wet Centre Seals, Dry and Wet Governors, Exhauster Governors, Photometers of all descriptions. Letheby's Sulphur and Ammonia Test Apparatus complete—also Testing and Chemical Apparatus of all kinds, and of the most perfect description, for all purposes relating to Gas.

GOODWIN'S IMPROVED LOWE'S JET PHOTOMETER.

Agents for Bray's Patent Gas Burners and Lanterns.

Special attention to repairs of Meters, and all apparatus connected with the business.
All work guaranteed first class in every particular, and orders filled promptly.

G. B. EDWARDS, Mang'r, New York.
E. H. B. TWINING, Mang'r, Chicago.

D. McDONALD & CO., GAS METER MANUFACTURERS.

(Established 1854.)

No. 51 Lancaster Street, Albany. N. Y.

STATION METERS, EXPERIMENTAL METERS, METER PROVERS, PRESSURE & VACUUM REGISTERS, PRESSURE GAUGES, ETC.

Also STAR GAS STOVES, RANGES, and HEATING STOVES.

We use only the very best materials, and employ the most skilled labor, and by our long experience (29 years) and personal supervision of every detail, we feel justified in assuring the public that our goods will give perfect satisfaction. Every Meter emanating from our establishment will bear the State Inspector's BADGE, and will be fully warranted by us. Our Annual and Calendar will be sent to Gas Companies upon application.

KINC'S TREATISE ON COAL GAS.

The most complete work on Coal Gas ever published. Three vols., bound, \$30.

A. M. CALLENDER & CO., No. 42 Pine Street, New York.

THE GOODWIN GAS STOVE AND METER CO.,

Successors to W. W. GOODWIN & CO.,

1012, 1014 & 1016 Filbert St., Phila., 142 Chambers St., N. Y., 76 Dearborn St., Chicago.

Agents, WALDO BROTHERS, 88 Water Street, Boston.

WM. W. GOODWIN, PRES. & TREAS.
W. H. MERRICK, VICE-PRES.
S. LEWIS JONES, SEC.

SOLE MANUFACTURERS OF THE

SAMUEL V. MERRICK, Asst.-Sec.
G. B. EDWARDS, Mang'r, N. Y.
E. H. B. TWINING, Mang'r, Chicago.

"SUN DIAL" GAS STOVES

The Most Economical, Efficient, and Durable Gas Stove Made.

Since 1878, when we began to manufacture these Stoves, we have received 17 Gold, Silver, and Bronze Medals, and 6 Diplomas for Efficiency, Superiority of Workmanship, etc. etc.

ALL FITTINGS ARE NICKEL-PLATED WITHOUT EXTRA CHARGE.

THE OVEN BURNERS ARE CONSTRUCTED TO BURN EITHER PURE GAS OR GAS AND AIR MIXED.

FROM TWENTY-FIVE TO FORTY PER CENT. OF GAS SAVED BY THE USE OF OUR PATENT OVEN LINING.

STOVES THAT WILL COOK FOR ONE PERSON OR ONE THOUSAND PERSONS AT ONE TIME.

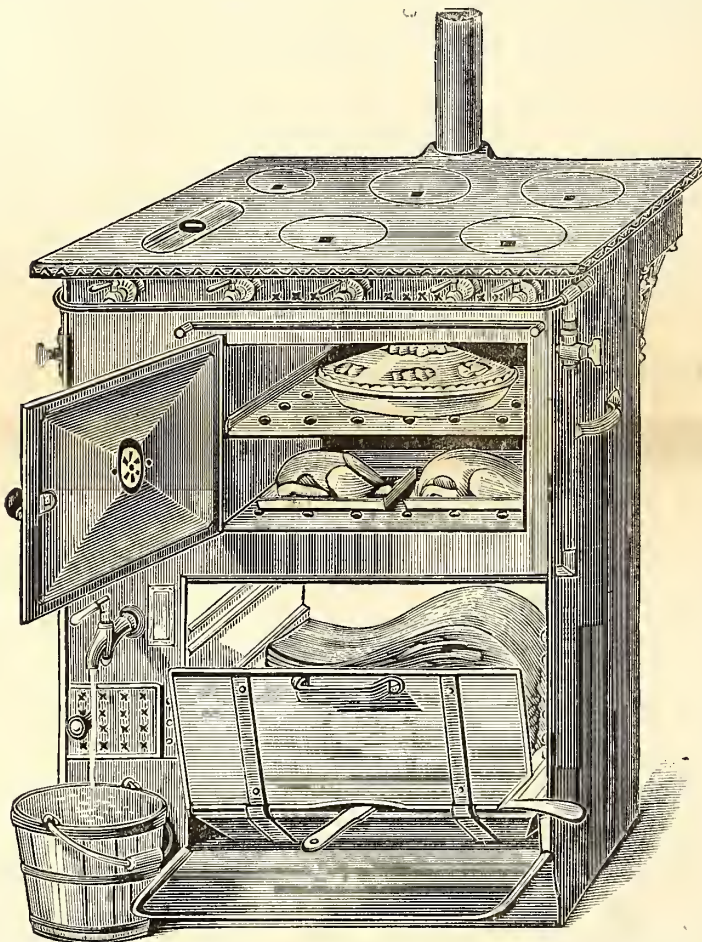

Gas Cooking Stove No. 9A. FITTED WITH OUR PATENT TOP AND OUTLET PIPE FOR CARRYING OFF COMPLETELY ALL THE PRODUCTS OF COMBUSTION FROM, OVEN, ROASTER, AND TOP BURNERS.

STOVES FOR LAUNDRIES, HATTERS, AND TAILORS.

HOT WATER GENERATORS FOR USE IN KITCHENS, BATH ROOMS, ETC., ETC.

BROILING RANGES FOR RESTAURANTS AND HOTELS.

OVER THIRTY-FIVE THOUSAND STOVES OF ALL SIZES SOLD SINCE 1878.

SEND FOR ILLUSTRATED CATALOGUE.

We carry in Stock Nos. 7, 8, and 8A Cooking Stoves fitted with our Patent Tops. See Catalogue and Price List.

We desire to call attention to our IMPROVEMENT IN THE TOP OF THE SUN DIAL GAS STOVE, by means of which all the odors and products of combustion from the ovens and top burners are entirely removed from the room. This is accomplished by channels and flues connected to the pipe shown at back of stove, to which is connected such additional pipe as may be necessary to connect the same with the flue or chimney, thereby producing the same effect in conveying away the products of combustion as is done in the use of the ordinary range, etc. This arrangement fills a want that has long been felt by those who have objected to the use of gas stoves for the reason of there being no adequate means to remove the products of combustion and odors from the roasting chambers, ovens, and boiling burners, all of which is now accomplished. *We have secured the improvement by Letters Patent in this country and Europe, and any attempt at infringement will be prosecuted.*

AGENTS FOR CLERK'S PATENT GAS ENGINE.

THE AMERICAN

GAS LIGHT JOURNAL

PUBLISHING OFFICE No. 42 PINE STREET

DEVOTED TO THE INTERESTS OF ILLUMINATION, VENTILATION, WATER SUPPLY AND DISTRIBUTION, & GENERAL SCIENCE.

VOLUME XLII.—No. 6.
Whole No. 618.

NEW YORK, MONDAY, MARCH 16, 1885.

\$3 PER ANNUM
IN ADVANCE.

A. M. CALLENDER & CO., Proprietors. C. E. SANDERSON, Manager.
JOS. R. THOMAS, C.E., Editor.

ENTERED AT THE POST OFFICE AT NEW YORK, N. Y.,
AS SECOND CLASS MATTER.

Published on the 2d and 16th of each month, at No. 42 Pine Street, N. Y.

Terms of Subscription, Including Postage.—For the United States and Canada, \$3 per annum. European countries, \$3.50 (15 shillings—18 francs). All payments to be made in advance. Single copies, 15 cents.

Remittances should be made either by post-office order, registered letter, or bank draft on New York, payable to the order of A. M. Callender & Co.

Collections are invariably made directly from this office, for subscriptions, advertisements, etc. We have agents to solicit the same, but they are not authorized to receipt for money.

Correspondence.—Wishing to make this JOURNAL a gazette of intelligent discussion to those of our readers who may wish to gain or give information on the subjects to which its columns are devoted, correspondence is solicited for publication from all who make the study of those subjects a pleasure or a profession.

Books.—We will mail, post-paid, at publisher's lowest rates, any book—scientific or otherwise—to any address in the United States or Canada. No books will be sent C. O. D.

The American News Company, Nos. 39 and 41 Chambers street, New York, are agents for this JOURNAL. Newsdealers will send orders to them.

THE MASSACHUSETTS BOARD OF HEALTH GIVES AN OPINION ON THE POISONOUS PROPERTIES OF WATER GAS.

Conformably to our promise of last issue we give, on pages 148-9, of current number, a literal reproduction of a report detailing a series of carefully carried out experiments having for their basis the determination of the "qualities of carbonic oxide as an element in illuminating gas," made by the Massachusetts State Board of Health, etc., in accordance with an "order" of the present legislative assembly of that Commonwealth. The position maintained by the JOURNAL in regard to the venenose nature and true toxic properties of carbonic oxide is well known, and has been steadfastly adhered to, simply because every weight of disinterested chemical authority and experiment goes to support and prove the proposition that CO is an intensely virulent poison. This being admitted, we have taken the further ground that the distribution of an illuminating gas containing an undue or extraordinary proportion of such poison must of necessity be decidedly more inimical to public health and the user's personal safety than would an illuminating gas carrying a lesser quantity of the harmful ingredient. Both of these standpoints have been assailed by the water gas patentees and purveyors—the first one being feebly protested against; while the second proposition has been assaulted with all their vigor. Outside of any other view or purpose the disinterested observer will at once perceive how important a thing it is that the water gas advocates should seek to prevent the public mind from becoming permeated with the idea or knowledge that its personal safety was to be subjected to an additional imperilment from a partial or general introduction of an illuminating vehicle the use of which implied extra precaution and added care. Their zeal in retaining "experts" (chemical and other) to plead their side of the case shows how thoroughly they understand the value of preventing the people at large from arriving at a true conception of the dangers of the situation—indeed none others know so well nor are so thoroughly familiar with the practice of bamboozling the dear public than the American promoters of the water gas system. Yet (and we are told that "familiarity breeds contempt"), through having so often flouted the "professional expert's" opinions before the public notice, the water gas worthies finally reached the point where they threw such precautions aside and boldly proclaimed that it did not matter much whether a few more deaths were caused in consequence of the distribution of their noxious compound, seeing that those who survived were basking in the effulgence of so superior a medium for the illumination of their homes than that which formerly supplied them.

It is a matter of record that certain other "investigations" have been instituted by civil authorities for the purpose of investigating and determining the relative danger, with respect to the public health, of coal and water gas. In the summer of 1883 Prof. Raymond, Health Commissioner to the city of Brooklyn (N. Y.), presented a report, made in compliance with a motion passed by the Board of Aldermen, on date of April 6th of same year, on "the relative dangers of coal and water gas when viewed from a sanitary standpoint." Prof. Raymond, rather than expressing his own opinion on the subject, it appears hired an expert, in the person of Prof. Ira Remsen, of the Hopkins University, of Baltimore, Md., to make the investigation; and the paid expert's determinations were chiefly remarkable for their complete absurdity. For the purpose of the present writing it is only necessary that one of the conclusions made by Remsen be reproduced. He admitted that

CONTENTS.

An Asterisk (*) denotes an illustrated article.

EDITORIALS—

The Massachusetts Board of Health Gives an Opinion on the Poisonous Properties of Water Gas.....	141
Cheap Gas Coal.....	142
English Gas Stocks and other Investments.....	142
Some Recent Happenings.....	142
Fifteenth Annual Meeting of the New England Association of Gas Engineers—Official Report—Continued from page 118.....	143
Treasurer's Report—Report of Executive Committee—Appointment of Nominating Committee—Discussing the President's Address—Mr. Neal Refuses a Re-election—Proposing to Hold Next Annual Meeting at another City than Boston—Afternoon Session—The Gas Commission Resolution—Report of Committee on Nomination of Officers—Election of Officers.	
New Black Lead Paint.....	147
The Venenose Nature of Carbonic Oxide.....	148
Address of General Andrew Hickenlooper to the Members of the Ohio Gas Association.....	149

ITEMS OF INTEREST FROM VARIOUS LOCALITIES..... 151

A Correction—Backing and Filling Over Street Lighting Matters at Newport, R. I.—Personal—A Long Line of Burning Oil—They Cannot Come Back as Knights of Labor—Cheaper Gas for Lowell, Mass.—A Three Years' Contract—Companion Pictures to the Carbonic Oxide Report of the Massachusetts Board of Health—Death No. 5—Case No. 6—Mr. Emerson McMillin Making Matters Plain—They Prefer to Burn Coal Gas—Killed by the Electric Current—The Illuminating Feature was Perfection—Still Quarreling at New Orleans, La.—Personal—Trying to do away with what might be Fruitful of Danger—A New Gas Works.

The Market for Gas Securities.....	152
------------------------------------	-----

the chief dangerous constituent of both gases—*i. e.*, coal and water gas—is carbon monoxide. His analysis of specimens of each gas disclosed the presence of 7.9 per cent. in one, and 28.25 per cent. in the other, and yet gives it as his opinion that he did “not think, however, that the percentage of the monoxide present in the two gases is a matter of any importance from a sanitary standpoint.” It will also be noted as curious, to say the least, that Health Commissioner Raymond failed to express himself either one way or another on the matter referred to him for investigation; but as those who ordered him to do the work were evidently satisfied with his action, since they accepted the findings presented, and took no further steps in the premises, it is presumed they were content with how the Commissioner conducted the transactions—incidentally, however, it might be remarked that the Brooklyn Board of Aldermen were never very particular or precise when engaged in debating or disposing of topics allied to sanitation in any aspect.

Following the action above noted came the agitation of the measure proposed to be enacted whereby it was sought to repeal the “ten per cent. carbonic oxide limit” in illuminating gas previously placed on the statute books of Massachusetts. The hearing in this case, before the joint Committee on Manufactures, to which body the subject of its discussion was referred by the main legislative assembly, was begun on February 6, 1884, and the weight of testimony elicited during the progress of the investigation (final arguments of counsel were not concluded until the latter part of March) was of so positive a nature that the members of the Committee reported against the proposed change of enactment, and this report was afterward ratified by the Massachusetts Legislature on date of May 15, 1884.

While the Massachusetts inquiry was in progress, Assemblyman Smith, of the New York State Assembly, introduced a resolution (afterward passed in a modified form) which instructed the State Board of Health to inquire into the “poisonous nature of water gas.” The State Board of Health deputed a sub-committee to carry out the investigation requested; and when the “report” was submitted we had occasion to characterize the whole proceeding and practice of the examiners as “a farce instead of an investigation.” With the light of another year’s intervention we see no reason why we should now alter that characterization; indeed, the more one reflects upon how the “investigation” was attended to, to say nothing about the “length, depth, and breadth of it,” the more strikingly does its comical feature prevail.

Such lengthly allusion is made to prior cases of civil attention to the relation of carbonic oxide and public health in order to show how different therefrom has been the plan pursued by the Massachusetts Board of Health. The gentlemen signing the document known as “Senate, No. 60,” have not hired “experts” from outside their own State to carry out the investigation ordered, as was the policy of Prof. Raymond, nor did they delegate a sub-committee to visit Boston and institute a sort of star-chamber inquiry, as was the case in New York; no, they preferred to find out actual facts, demonstrated by carefully conducted experiments, in order that they might, by not taking anything for granted, be in position to learn the exact truth, and so report it to those who directed them to consider “the relative poisonous qualities of common illuminating coal gas and the so-called water gas, and on their probable effect upon the public health.”

We do not wish, nor do we think it necessary, to enter into any extended analysis of the findings submitted by Profs. Sedgwick and Nichols, for the conclusions presented by them are so plainly understandable as to make the proverbial task of reading while running an easy one indeed. However, we will call attention to one particularly striking feature of the document, entirely corroborative of the theory advanced by Mr. Eugene Vanderpool, of the Newark (N. J.) Gas Light Company during the reception of his testimony by the joint Committee of Manufactures of the Massachusetts Legislature in 1884. In the printed reports of that hearing Mr. Vanderpool is put down as saying that, taking Prof. Raymond’s enumeration of deaths known to have resulted in the city of Brooklyn from the accidental inhalation of illuminating coal and water gas, and allotting the deaths to the total make of the different sorts of gases, the figures would show that water gas was “eighty times as disastrous as coal gas.” Of course the illustrious Lowe bodyguard was moved to laughter thereat; but their smiles will not broaden much over a perusal of the statements made by the Massachusetts professors. These gentlemen say: “Water gas is therefore not only in itself more poisonous than coal gas, but is also far more likely to produce injurious effects from similar accidental causes. It must not, however, be inferred that a gas containing twice as much carbonic oxide as another is necessarily only twice as dangerous. On the contrary, the danger increases, particularly with certain percentages, much more rapidly than this.”

Another very interesting and important deduction which the investigators, in common with prior European investigators, make is the following: “Our experiments confirm the work of others in proving that carbonic oxide is not a cumulative poison; that is to say, the breathing of certain small quantities for a long time is not equivalent to the breathing of a large quantity for a short time; and this fact has much to do with the difference between the effects of the two gases. For an atmosphere containing a certain small per-

centage of coal gas may be breathed for many hours without serious effects; while an atmosphere containing the same amount of water gas will be injurious and even fatal.”

The frank and honest declarations made by Profs. Sedgwick and Nichols are in queer contrast to those which have emanated so often from the “chemical experts” and others of that ilk, who, in their zeal to earn their “retainers” and fees, have oftentimes resorted to the practices of pettifogging attorneys without regard or respect to the sullyng and smirching which they saw fit to inflict upon the mantle of the science at whose shrine they are supposed to be ever on guard. Let our readers bear in mind that the gentlemen who affix their signatures to the document, “Senate, No. 60,” are neither advocates nor supporters of any special sort of illuminating agent, be it coal gas or water gas. Their duty, in common with the Massachusetts State Board of Health, is to prevent, in so far as they can, the public health from suffering any undue imperilment, arising from no matter what cause or circumstance.

CHEAP GAS COAL.

The price at which the Westmoreland, Penn., and Ocean Mine gas coal companies have agreed to deliver their coal to the Consolidated Gas Light Company, of New York city, during the ensuing year, has been adjusted to the figure of \$4 per ton of 2,240 lbs. This state of affairs affords excellent reason for congratulation, and supplies abundant testimony to the agreeable fact that the coal factors are evincing no desire to stand in the way of, nor in any manner to hamper, the efforts of the gas makers in their determination to sell gas cheaply. Standard gas coals on board wharf in New York city at the above quoted prices are decidedly cheap, and the owners of the mining properties can hardly be charged with a disposition to exact more than a fair profit out of the working of their collieries.

English Gas Stocks and other Investments.

The London *Journal* notes that a curiously instructive article in the current number of *Blackwood's Magazine* treats of the decrease in the value of investments during the past year. The article bears the curt and expressive title: “A Black Year for Investors;” and what is meant by “black” in connection with money it is unnecessary to explain. The writer begins by assuming that trade is bad, and declines to waver in his belief at the bidding of any “cock-sure apostle of the Cobden Club.” He finds his best warrant for this belief—not in Board of Trade returns of exports and imports (which may mean much or little), but in the records of the London Stock Exchange. The year is stated to have found investors poor, and left them poorer. The proof of this is shown by comparison of the closing quotations of stocks for Dec. 31, 1884, with the corresponding prices of the last day of the previous year. The variations of price, being calculated upon the amount of stocks held by the public, show that the aggregate declines reach the solid figure of 123 millions sterling, while the gains are rather more than 52 millions; leaving a net capital depreciation of upwards of 70 millions sterling for the year. Nearly all classes of securities, from Consols to mines, participated, in their degree, in the depreciation. The brightest spot in the gathering gloom is admittedly the increased value of gas stocks, 57 out of 59 of which improved, and only two declined; the balance of gain having been fully 2½ millions sterling.

Then says the writer, “What a moral for the electric light companies, whose own shares have shriveled up into decimal fractions?” The latter class of shares are included by the writer among the “gambling sort,” which cannot be reckoned as wealth, but rather as the “spectres of wealth that has been squandered.” Dividends are unknown in their history; but Capel Court likes to play with them. “The rubbish goes up and it goes down—one fool loses on it and another gains; but, as a national asset it is hardly worth counting.” It is somewhat startling to learn that the total amount of stocks and shares listed by the London Stock Exchange is over 3,437 millions sterling; so that, if investors are “poor,” as the writer maintains, they are not without some solace in their misery. To cure the worst of the evils of joint-stock speculation, the article suggests that a new Act is wanted, which should, among other things, require a director to hold a solid amount of stock, not to be sold or dealt in under any pretence whatever.

SOME RECENT HAPPENINGS.—The Consolidated Gas Co. of New York city, after due consideration, decided to close down the plant formerly known as the Harlem gas works. We understand that the order for such action was issued on Monday, Feb. 16. Inadequate distribution facilities undoubtedly had much to do with the decision arrived at.

It is reported that the Nassau (Brooklyn, N. Y.) Gas Light Company are receiving bids for the construction of a large gasholder. If it was intended by the management to invite competition for the work, it might have been good policy on their part to have followed the course pursued by the Consolidated Company, of Baltimore, Md.

[OFFICIAL REPORT.]

Fifteenth Annual Meeting of the New England Association of Gas Engineers.

HELD AT YOUNG'S HOTEL, BOSTON, MASS., FEB. 18 AND 19, 1885.

FIRST DAY—MORNING SESSION—FEB. 18.

The Secretary called attention to the fact that, at the annual session of 1884, the Association had directed a "question box" to be provided, and placed in proper position on the opening day of meeting. He stated that such box had been placed on the table, and hoped the members would fill it with written queries.

The President—If there is any subject which any member desires to have the Association discuss, he may indicate his wish by placing a written slip within the box provided by the Secretary. After the ordinary regular business of the Association has been transacted the box will be opened and the questions found to have been submitted will be brought forward for discussion.

TREASURER'S REPORT.

Treasurer Neal then read the following report :

Total receipts for year	\$310 19 .
Total expenditures.....	232 36
Balance.....	\$77 83

Permanent fund—

Invested in Charlestown Five Cents Savings Bank.....	\$300 00
“ Warren Institution for Savings	400 00

BOSTON, Feb. 17, 1885. G. B. NEAL, Treasurer.

Messrs. A. M. Norton and John Cabot, of committee appointed to examine accounts of Treasurer, reported that the financial statement just read was correctly rendered and the items properly vouched for. On motion of Mr. Stiness the report, together with findings of committee, were received, recorded, and placed on file.

REPORT OF EXECUTIVE COMMITTEE.

The Secretary—The Executive Committee voted, as a result of their deliberations, to report the following :

“The officers of the Association shall assume office immediately after the close of the meeting at which they are elected.”

This action is proposed because the present laws of the Association contain no provision directly specifying when the newly appointed officers are to assume their duties.

Mr. Stiness moved (seconded by Mr. Cabot) that the Association adopt the proposed regulation, with the understanding that the practice suggested hereafter prevail as a rule of the Association. Carried.

The Executive Committee next recommended that the two papers presented—one by Mr. C. F. Prichard, of Lynn, Mass., on “The Influence of Steam in the Ashpan,” and the other by Mr. Edward C. Jones, Boston, Mass., on “An Experience with Naphthaline Deposits”—be read. They also recommended that yearly membership dues for 1885 be placed at \$3, and initiation fees at \$5.

The President inquired if there was any objection to be offered to the suggestions. Mr. Harbison moved (in order that it might not be necessary to settle the question of yearly membership rates at each annual meeting) an amendment to the recommendation of the Committee in that respect ; he proposing that, until further ordered by the Association, the annual assessment fee be \$3 and initiation fee \$5.

The amendment was agreed to, and the amended resolution adopted.

APPOINTMENT OF NOMINATING COMMITTEE.

The next business in order being the appointment of a committee to nominate officers for ensuing year, Chairman Greenough named Messrs. Sherman, of New Haven, Conn.; Allyn, of Cambridge, Mass.; Hill, of Concord, N. H.; Moore, of Salem, Mass., and Hallett, of Springfield, Mass., to compose such committee. The appointees were instructed to present their report at the afternoon session.

President Greenough announced that general business was in order. Provided no topic of that nature was forthcoming, the reading of papers would be proceeded with.

DISCUSSING THE PRESIDENT'S ADDRESS.

Mr. Harbison—Before we proceed to the reading of papers I would suggest that this is a suitable time to discuss the matters spoken of in Chairman Greenough's annual message. Believing this, I therefore move we take from the table the President's address and consider the suggestions therein made. Agreed to.

Mr. Harbison, continuing, said—The special point I had in mind was the suggestion of the President as to the importance of some concerted action, or expression of opinion, on the part of the Association with reference to the

establishment of a Gas Commission in Massachusetts, and in other States as well. It is a matter of great importance, and I heartily agree with what the Chairman suggested. The company with which I am connected has no special fear from the operations of outside parties who might aspire to the building of an opposition works at Hartford ; perhaps there is a special reason for this—the extremely low price at which we are now selling gas. But if parties are determined to blackmail existing gas companies (and perhaps that practically is what is at the bottom of the whole business), I doubt very much whether a low selling price would absolutely deter them from making the attempt. Massachusetts has now, if I understand it, a law protecting existing railroad corporations from the interference of outsiders. It has a Commission which controls railway affairs, and when parties desirous of establishing parallel and competing roads make their appearance they must get the Commission's assent and consent before they can go to work. That has been found to work well so far as the railroad corporations of Massachusetts are concerned, and I do not know why the same principle would not equally well apply to gas interests. If a Commission, appointed by the Legislature or by the Governor, should have direction in regard to gas companies, our “friends” from outside, who desire to come in and benefit the people of the Commonwealth by establishing competing gas companies, would find it much harder work than now to effect the entering wedge. They would have to show to the public, through the members of the Commission, that a real benefit would accrue to the people of any city or town from the admission of a competing gas company ; and I apprehend there would be much difficulty in making the matter plain. And if a gas company (as I assume, and think I have a right to assume, that all gas companies are) is doing a straightforward, honorable business in the community in which it is located, I cannot see how any such gas company can, in any degree, be injured by having a Commission examine into its affairs, just as the affairs of railroad companies are examined into by the Railroad Commissions. As I look at the matter, there ought not to be in the management of any gas company anything that will not bear inspection by parties who have a right to make the inspection. Understand me that I do not believe any three or four citizens of a city or town have a right to visit your office and go through your books, and so make themselves a nuisance ; but I do think that legally appointed authorities, having simply the common welfare and good of the people at heart, should have that right. We have, in our banking systems, bank examiners whose duty it is to inspect and examine the manner in which a bank transacts its business. It is quite proper, in the interest of the people, that it should be so ; and that such system should be even much more rigorously applied and carried out is evident from the late reports regarding wrongdoing in our banking institutions. I do not believe that anything corrupt exists in the operations or workings of our gas companies ; indeed, I hold it is quite the contrary. Yet I think there has been too much secretiveness practiced—too great a disposition to keep from the people that which really they are entitled to know. I do not think it harmful for any of us to have the people whom we are serving know the rate of dividends we are paying, and convince them that what we do pay is about all that we can earn. It is the duty of a gas manager, for the equal benefit of stockholder and consumer, first of all, to keep the plant in good condition ; then pay a fair return on the capital invested ; and beyond that, keep a small fund in hand ready for contingencies certain to develop themselves at one time or another—that also is his duty. Further than these absolute requirements, I say the people who are served by a gas company have a right to all the benefits resulting from the improvements we can introduce into the management of our business. If they give us exclusive control of the territories in which we are located, we have a bounden duty to perform toward them. I make bold to say that if this matter were fairly considered by both the gas company and the public, gas investments would be very much safer securities to hold, and the management of our business could be carried on far more successfully. I for one should like to hear a pretty generally extended expression of opinion on this subject. Perhaps it would be well, however, to take up one point at a time ; and I hope there will be a thorough ventilation of the opinion of our members in regard to the question.

The President—This question of a Gas Commission is a pretty important one. As said previously in my address, it seems to me that it furnishes the solution of many difficulties under which we are all laboring. You probably have noticed that they have at last taken up the matter in New York ; but are a little slow about going on, as they do not apparently understand the subject. But now that the steed has been stolen they propose to shut the door and prevent any more loading the public with a superfluity of capital. In Boston they are proposing to add to the capital, upon which dividends are eventually to be paid by the public, somewhere from five to seven millions of dollars if the money can be gotten to put in it. Of course, everybody knows that, at some time, the public will probably have to pay the interest on that increased capital. I presume that any further increase can be stopped here if a commission should be appointed. Without a commission the probability is that, if these two companies come in, there may be more ;

and I do not know why, if New York city can stand forty-five or fifty millions of capital, we should not have the privilege of having fifteen or twenty millions here in Boston. I do not think, though, that it is a privilege which would redound to the benefit of the public. The gentleman who is now proposing to benefit us here in Boston names no price for his gas, makes no promises, offers no inducements, puts up no guarantees; but simply states that he is traveling around to benefit the people of this country by giving them competition in gas. But when we objected, as we did at the State House last week, to the fact that five millions of capital was hardly necessary to be added to the business being done in Boston, he spoke up and said (or his lawyer did for him) that he did not propose to confine his attention to Boston, but that his five million dollars were to be used for "going through Massachusetts." Now, when a man makes no promises whatever in regard to price or quality, and gives no guarantees of any sort, but simply proposes to give the various towns in which you gentlemen live the benefit of competition, you can see that it is not at all unlikely that he will pay you a visit before long in your own cities. It is well known that he has already erected a gas works in Chicago, Ills., at a cost of about one million and a quarter, but which has been stocked and bonded at five millions; and I have been informed that works have been erected by him in Jersey City, at a cost of between two and three hundred thousand dollars, but which have been stocked and bonded at sixteen hundred thousand dollars. That sort of thing is not going to be sanctioned by a Commission; and when the inevitable day of reckoning comes, the Commission are going to see to it that the people who have done that sort of business are not to be put on any equality with the people who have got the money actually paid in, and who are doing a legitimate business. So far as we are concerned here in Boston it does not seem to me that the Commission will make very much difference at present. After the public has seen Washington street torn up twice—once by the Consumers' Company, and once by the Bay State Company—the Consumers Company proposing to lay down pipes on each side of the street, and to lay supply pipe to every house as they go by; and the Bay State Company proposing to lay pipe in the middle of the street, and to pipe each house as they go along—I doubt if any more companies are admitted here at once. You gentlemen who are not exactly in that position, however, ought to be active in respect to this question. It is alleged by some gentlemen at the State House that this is wholly a Boston scheme; but really it is for the good of us all. As a matter of fact, I suppose that the Boston companies will have to bear about forty per cent. of the expense of it; but we are perfectly willing to do that so far as our company is concerned. It seems to me that the companies here present to-day, representing the New England Association, ought to take some action, in the form of a resolution or memorial, or something of that sort, which shall show the willingness of the companies represented in this Association to be subjected to any fair examination, provided we can have protection. If we cannot get protection, of course we do not want the Commission. Either the gas business is a public business or it is a private business. If it is a business that stands by itself, like the delivery of water, then it is perfectly fair, if a man's affairs are looked over by the Government, that he should receive protection in the enjoyment of his rights. If, on the other hand, it is a thing that should be free to all competition, then, of course, we are justified in making all that we can, just as Jordan, Marsh & Co., do; and nobody does anything but applaud them when they make a large dividend on the capital invested in their business. If this Association want this thing I hope they will say so to-day. If they do not want it, I hope somebody who proposes to oppose it in the Legislature will get up and say so now. We do not want to push this thing forward in the Legislature, and then have men brought in from our own Association to say that they do not want this thing, or to say that this is a Boston fight, and they do not care anything about it. If the members of the New England Association do not want this Commission, let us have the thing out here to-day; if they conclude that they do want it, I hope some action will be taken in the matter. I should like to hear from Mr. Cabot, of Lawrence, on this question.

Mr. Cabot—Mr. President: It is well known among many of my friends in our Association that I have been in favor of a Commission somewhat similar to this. I do not think this Commission goes quite far enough; but still I have been in favor of such a measure for many years. I have also thought that gas companies were suffering through want of knowledge on the part of the public in regard to them. They are a monopoly, it is true, but they are a different monopoly from that of ordinary corporations, and for the reason that they are confined in respect to their customers—they are limited as to where they shall seek their business. It is, of course, for the benefit of the public that gas should be sold in all the cities and towns at the lowest price at which it can be sold, and, at the same time, yield a fair return on the investment. I know no better way of accomplishing this object, and making the public familiar with the subject, than through a Commission, which shall have power, as provided in the bill now before the Legislature, to state whether a new company is required in a place; and also to regulate

to a certain extent the price of gas by having regard to the earnings of the gas company. If a gas company is earning too large a sum of money, the Commission should have the power to reduce the price at which the gas shall be sold—*i. e.*, as the profits are increased the price of gas shall be reduced, so that, like the English law, the consumers shall have the benefit of the increased profits made by gas companies. I sincerely hope that a law of this kind may be passed. I believe it is for the benefit of all concerned, but yet more greatly to the benefit of the public than for the benefit of gas companies. If there is any way of protecting the public it seems to me that this is the way. We certainly could trust our affairs to a board of gentlemen selected or nominated by the Governor; because then we would be apt to secure competent, fair-minded men. I hope, as has been said here before, that every gentleman will express himself freely on this subject. I think the time has now arrived when, if we want a law of this kind, we should do all we can to procure it.

The President—We would like to hear from Dr. Howe, of Cambridge.

Dr. Howe—I did not come here with the intention of making any remarks; and whatever I may say will be in very crude form. For a long time I have felt that the gas interest in this State (representing as it does fifteen or sixteen million dollars of actual cash paid in—in fact, a considerably greater sum than that) was standing in a position of some danger from the sort of piratical attack which has been commenced in Boston, and which you say is likely to be successful there. If the gas companies themselves will come together and represent the real facts involved in this great interest, they could make the Legislature understand that they have a very large number of constituents who are interested in these companies; and if they could show them, as I have no doubt they can, that to a very large extent this capital has gone into the hands of people who are holding it in trust, and for persons who are not able to take care of it themselves, they would be likely to give the subject the attention it deserves. I looked over my stock ledger the other day and found that very nearly one-half of my stockholders were women; but if I took in all the estates and trusts that were represented, I am quite sure it would be found that one-half of my stockholders are persons entirely incapable of managing their own affairs, and who are obliged to entrust them to other people. I think if the Legislature can be impressed with that fact they will perceive the gas interest to be one large enough to demand for itself the protection of the State; and also that it is not alone the community that needs protection, but that the capital invested, in the interest of the parties owning that capital, should be protected. It is not for the interest of the State that great investments like these should be rendered valueless; and more especially if they are to be rendered valueless by the use of a still larger capital actually invested in unnecessary gas plants. That is just what is proposed to be done. It is proposed here to annihilate capital by capital. If it could be demonstrated to our legislators that where one million is sufficient to do the business, it is a waste of money to put in two millions, and the public are to derive no advantage whatever from the increase; furthermore, that it is very certain the parties interested at present will meet with very material loss because of the increase, I think there would be a pause. As it is now, partly owing to the want of knowledge on the part of the public, due, perhaps, to the inclination of the gas companies themselves to keep their business matters too secret, people have an impression (vague and undefined) that there is a certain underhand style of amassing money possessed by gas companies, and that their ways cannot be understood. When the people get into that train of reasoning they are perfectly willing to say: "Well, anything that will check those fellows and break down this sort of thimble-rigging process which they have is a good thing for us." Now, I claim publicity is a thing more of advantage to our business than anything else at this present moment—publicity as to our processes, and as to our profits. Some years ago I said to my stockholders: "I have paid you good dividends, and every dollar over that fair profit I intend to give the public the benefit of." I am selling gas to-day for less than it cost me to make it ten years ago; and I presume some other gentlemen in this room will say the same thing. My figures distinctly show that it cost me more than two dollars per thousand to manufacture and distribute gas ten years ago, but I am now selling it at \$2, and am making a profit. Of course, if it was not that we are burdened with a large capital we could sell gas considerably cheaper. Our case is a peculiar one. We are in a city in which we have 75 miles of pipe to reach a moderate consumption; and we have a larger capital than any other company in the State, I think, excepting the Boston. They have three times our capital, but they also have twelve times our business. I am just in a situation to show the people how excess of capital may become a burden. It is a burden to us. If we could get rid of half of it I could put down the price of gas fifty cents per thousand, and I should like to do it. But the necessities of our situation compel us to stand in that position. Now, all these things are entirely unknown to our consumers. I think it is for our interest, therefore, to have a Commission which shall examine into this matter carefully. I am satisfied, if the Legislature can be persuaded merely to give us a Commission that will thorough-

ly examine and report upon the subject, even if they do not directly protect us, they will, by that measure alone, give us considerable protection in the end.

The President—I would like to have Col. Armington state how he thinks it would work in New York.

Mr. Armington—I felt somewhat modest about saying anything upon this question, because I inferred from your remarks that this was rather a local issue, and that you only sought an expression of opinion from the people who are directly interested. But, since you have called upon me, I feel constrained to say that I think your move is a good one, and in the right direction. I think if a Gas Commission could be established in every State we would be far better off than we are now. We would not then be troubled with this excess of capital which Dr. Howe has spoken of, and which is not peculiar to his company. There is no question but that if he could go back to the principles that have been laid down in England, and by which English gas companies are governed, he would be very much better off. Now, as I understand it, with respect to the London companies particularly, if they wish to make an extension of any kind in their works, necessitating an increased capital, they are obliged to submit plans and estimates to a commission, or perhaps to one commissioner. If he approve, and the applicants can show that it is necessary to have the proposed addition in order to provide for an increased consumption, then they may go on and issue the additional capital, having, of course, also obtained the right from Parliament to do so. If the commission does not approve, why, they must then get along as best they can. It seems to me that that sort of commission is exactly what is needed here, and is also needed in every State. Then we could go on untroubled by fear of competition. Regarding the details of what those gentlemen could be called upon to do, I think there might be some disagreement. Our friend Harbison speaks about what he terms "fair dividends." It is an actual fact that a large amount of English capital (notably consols) are held there by the people, and which pay a dividend of only 3 per cent. The English gas commission is willing gas companies should pay a certain per cent. (say 10) on the capital which may be invested. So you see there has been a conservative view taken—that while consols (the national debt) may remain right along, and men may invest in them without any fear as to their stability, and for that reason be satisfied with a low rate of interest, yet when it comes to the conduct of a hazardous business, it is admitted capital should be better rewarded. A commission of intelligent men here would probably take a similar view. I was gratified when I heard that a measure of that kind was contemplated; and I believe if it can be carried out here it will result that other States than Massachusetts will adopt the plan, and we shall finally get the benefit of it all over the country. It seems to me it is a subject which we are all very much interested in; and I think you act properly in calling upon your associates here to express themselves upon the subject. I do not understand how any man living in Massachusetts, and hearing the statement made that these people are not going to confine their operations to the city of Boston, but are to pay their attention to other sections of the State, can fail to be interested.

Mr. Slater—With a view of trying to bring out more fully the views of members on this subject, I offer the following resolution:

"Resolved, That this Association of the Gas Engineers of New England heartily approves of the effort, now being made in the State of Massachusetts, to have a gas commission appointed which shall have general supervision and regulation of the business of gas companies in the interest of the public; and recommends that similar action be taken in all the New England States."

Mr. Stiness—I second that resolution.

The President—I have a copy of the bill here as proposed by the City Solicitor, which I will read very briefly. It first provides for the appointment, by the Governor, of three commissioners, for one, two, and three years respectively, and one to be appointed afterward every three years; one of the three to go out of office every year. The third section provides that they shall not "be in any way, directly or indirectly, interested pecuniarily in the manufacture of gas," nor hold stock in gas companies. The fourth and fifth sections provide that they shall have a certain sum of money allowed them for expenses. The sixth section reads:

"SEC. 6. The annual expenses of the commissioners, including salaries, shall be borne by the several gas companies, in proportion to their net earnings, and shall be assessed and recovered in the manner provided for the assessment and recovery of the expenses of the railroad commissioners.

"SEC. 7. Every gas company shall at all times, on request, furnish any statement or information required by the board concerning the condition, management, and operations of the company, and shall comply with all lawful orders of said board."

Of course the board cannot compel the companies to reduce their price; they can merely recommend it.

"SEC. 8. Said board shall have the general supervision of all corporations

engaged in the manufacture and sale of gas for lighting and for fuel; and shall make all necessary examinations and inquiries, and keep themselves informed as to the compliance of the several corporations with the provisions of law."

If a corporation violates the provision of the law at the present time there is nobody to bring it to book. The appointment of this commission would give somebody a right to enforce the laws now standing upon the statute book, with regard to the purity of gas.

"SEC. 9. Upon the complaint, in writing, of the mayor of a city, or the selectmen of a town, in which a gas company is located, or of twenty customers of such company, either of the quality or price of the gas sold and delivered by such company, the board shall notify the company of such complaint by leaving at their office a copy thereof; and shall thereupon, after notice, give a public hearing to such petitioner and such company; and if, after such hearing, any reduction in the price of gas, or improvement in quality thereof, can lawfully be required of the company, they shall pass such orders and take such action as are necessary thereto; and a report of the proceedings and the result thereof shall be included in their annual report to the Legislature."

That is just about the way the railroad commission works at the present time. I do not think the railroad commissioners have ever requested a railroad company to do anything that the company has not done. All complaints about the management of any railroad, instead of being ventilated in the Legislature, are brought before the railroad commission, which consider and report upon the complaints; but have no other power with respect to them except to make recommendations.

"SEC. 10. The board, whenever any such company violates or neglects in any respect to comply with the provisions of any law, or refuses or neglects to comply with any lawful order of the board, shall give notice thereof, in writing, to such corporation and to the attorney-general, who shall take such proceedings thereon as he may deem expedient.

"SEC. 11. Any court having equity jurisdiction in term, time or vacation, may, on the application of said board, by any suitable process or decree in equity, enforce the provisions of this act and the lawful orders of said board.

"SEC. 12. The board shall make an annual report to the Legislature of the doings of the board, with such suggestions as to the condition of affairs or conduct of the gas companies as may be deemed appropriate."

That is the bill as it comes from the City Solicitor. The following amendments to that bill have been proposed:

"SEC.—In any city or town in which a gas company exists in active operation, no other gas company, nor any other persons, shall dig up and open the streets, lanes and highways of such city or town for the purpose of laying gas pipes therein without the consent of the mayor and aldermen or selectmen of such city or town, and the approval, in writing, of the board of commissioners created by this act, after a public hearing before said board of commissioners and notice to all parties interested, by publication or otherwise.

"SEC.—The board shall, from time to time, ascertain with what degree of purity the gas companies can reasonably be required to make and supply gas, and if any change in the existing laws requiring purity of gas shall be, in their opinion, desirable or expedient, they shall so report to the Legislature in their next report."

The last section gives them supervision over the question of what constitutes impurities in coal and water gas. You have heard the resolution offered by Mr. Slater. Are there any further remarks?

Mr. Allyn—It seems to me that the resolution is a little blind, in that it does not signify whether we are to endorse the bill which has been offered by Mr. Baily, or endorse it as amended by yourself. I should oppose the bill as offered by Mr. Baily, unless the amendments were added to it.

Mr. Harbison—Does not that resolution quite explain itself? The bill, as prepared, is for the protection of the people as well as the gas companies. Does not that cover Mr. Allyn's objection?

Mr. Allyn—Mr. Baily's bill does not purport to do that; it protects the people but not the gas company.

Mr. Harbison—This resolution says that efforts are being made with reference to a bill to protect the people as well as the gas companies; it includes the amendments as proposed by the Boston Gas Company.

Mr. Allyn.—My point was that while we wish to express our approval of the appointment of a Commission, we also wish to express the idea that if the people's interests are to be looked after by this Commission, the interests of the gas companies ought also to be.

Mr. Slater—Certainly.

Mr. Stiness—I think the resolution covers it.

The President—It says: "Shall have general supervision and regulation of the business of gas companies, and recommend that similar action be taken in all the New England States."

Mr. Armington—Why confine the passage of resolutions of that kind by

this Association with reference to New England? This, in my opinion, should not be confined to New England. Let us have the words, "New England States" stricken out. Do not make it simply apply to one section of the country.

The President—Why not say: "That such action is the proper policy in all States?"

Mr. Armington—That is it.

The President—And then you might insert something to cover Mr. Allyn's objection, by providing proper protection be given to both the companies and the public. How will that suit you, Mr. Allyn?

Mr. Allyn—That will be perfectly satisfactory.

Mr. Harbison—Will it be quite the proper thing for the New England Association, composed only of members from New England, to make suggestions to our brethren in other States? Will they think it particularly courteous for New England to be modestly intimating to our friends of other States what we think they had better do? When the other Associations meet they can place a minute on their records that will be more general. When the members of the American Association meet next October it will be quite the proper thing for them, if they see fit, to spread such a minute on their record; but it does seem to me that for the New England Association to suggest such a course of procedure to our friends of the West and South, or of any other section outside of New England, will be hardly characteristic of New England modesty. I merely advance this idea in reply to the suggestion of my friend, Mr. Armington.

Mr. Stiness—I must agree with the last speaker that, as we stand here today, representatives of New England, and look upon the stalwarts who come from South of the Hudson, we must admit they are perfectly capable of taking care of themselves.

Mr. Armington—It seems to me that this is a little on the order of bigotry, is it not? (Laughter.) The State of which I have the honor to be a native was one that was founded by the same kind of bigotry. They drove poor old Roger Williams out of the Massachusetts Colony because its founders did not quite agree with all of his ideas; but I thought we had gotten entirely over that sort of thing. As to this expression of friend Harbison about New England "modesty," I must say that I had to grasp my chair to keep from rising when he was using that word. My idea is simply this: We came here to legislate upon matters concerning gas interests all over the country. We have not confined ourselves to seeing what is going on in New England, and what results have been produced in New England, since our President has here this morning alluded to the capital of the Consolidated Company—perhaps not using those very words, but of course we knew what he meant. We have visitors present with us who wish their States would enact similar measures. I think those words ought to be stricken out; instead of speaking for itself alone, in the modest way that our friend Harbison suggests, speak in behalf of other localities, and let us have the good of this thing extend over the whole country. It will do no harm for the members of the various Legislatures throughout the country to read that the assembled wisdom of New England had recommended this thing.

Mr. Stedman—I think it would be presumptuous in this body, representing, as it does, only New England interests, to offer our advice to Legislatures outside of New England. I think we had better confine our influences, as much as possible, to the districts we represent, and the value of the example will not be lost on other Legislatures. No doubt we serve our own interests if we succeed in causing to be passed by the Legislatures of our different States such a system of regulations and defenses of the respective rights and obligations of the public and of the gas companies. If, when this has been established in Massachusetts, and found to work favorably, or if once we establish a system that takes the public into our confidence, and lets them understand that we are doing the honest thing by them (as Mr. Harbison says he has no doubt we all try to do, and as I am sure we have tried to do), I think the beneficial influence of such action would very speedily extend all over the country. It does seem almost incredible that the public in general, and their representatives in particular, should be so hard to educate. You may go before a committee with the plainest statement of facts; you may exert yourself to show your honest intent; you may say to them, and prove by figures, that you have always conducted your business with a due regard to the obligations which your franchise imposed upon you; but when you have gotten through you can have the pleasure of realizing that you have made no more impression than if you had undertaken to whistle down a Boston northeast wind. The answers that you get, perhaps, if you ask a man if he understands or if he coincides with your views, will convince you that he has not any appreciation whatever, and that his power of obtuseness decidedly exceeds your power of penetration. Now, as we cannot get at the public ourselves—as it is impossible to convince the ordinary gas consumer that we have his interest at heart (for he generally thinks we are after the whole of his principal as well as his interest)—it seems to me that the only thing we can do is to have a commission appointed by the public, in the public interest, designed to represent that interest, and incidentally to give

protection to the gas companies. Because if we could once convince an intelligent body of men that it is for the interest of the public that the least possible capital should be invested in a certain business, in order that the public should have the benefit of a low interest charge, which should be added to the cost of the production of any article of comfort or of necessity which they require; if we could once convince an intelligent body like that, that that was the true policy, I think we would have no difficulty in finding all adequate protection that any company would need, in the fact of the possession of that knowledge by such a body. That is what the public can not appreciate and cannot understand. You cannot make the public, nor the ordinary board of aldermen, nor the ordinary legislator, understand that an additional capital to do a fixed amount of business is going to be a detriment to that business and to the public. The idea of competition in business has so permeated the public mind that the old maxim which says "competition is the life of business" is universally accepted as a truism; but anybody who regards the present crisis in business affairs throughout this country knows pretty well that competition has been the death of almost all kinds of business. Nevertheless the average mind, the average man, takes in that old proverb, and thereon dwells with entire satisfaction. The ordinary consumer believes if he had two or three gas companies in his town, to either of which he could go when he did not find full satisfaction in his dealings with the other, he would be greatly benefited thereby. It would be an impossibility to educate each individual up to the point of seeing that he had better not pay interest on any more capital than is absolutely necessary. Now, with all the efforts which have been made by the Legislatures of different States, and with all the publicity that has been given to the unanswerable arguments which have been adduced before those Legislatures, the public fail to perceive that it is better for them to have a regulated monopoly than to have half a dozen unregulated ones. When once you put before them the fact that a monopoly is an absolute necessity in gas manufacture, and that if they do not have one monopoly they must have two or three; that the history of the gas business shows that the monopoly is either a monopoly of one company or a monopoly of half-a-dozen, and temporary opposition always ended by division or consolidation; I say that when once you have thoroughly shown this to the people they will begin to appreciate the fact that additional capital added to a business which is strictly limited to a certain territory must be an injury to the public interest. Now, they do not appreciate that fact at all; and the reason is because of a blind prejudice against gas companies. They believe that the gas business has been a bonanza; and there is always a feeling on the part of the public (a remnant of the old brute feeling) that when a dog has got a good piece of meat the other dog will get it away from him by force if he can, even though he has already had all that he needs, and so cannot eat it himself—the old feeling that they should take who have the power, and they should keep who can. That idea is to-day, and under cover of law, just as prevalent as it was in the olden times when force took the place of law. It is so in all businesses; but it is particularly so in the gas business, which is comparatively unprotected from raids, and comparatively open to such raids, because of the very prejudices held against it by the communities in which it operates. I am perfectly willing to open our books to the public, and to invite them into our confidence. I would like to show them there is not a dollar in our capital that did not represent more than an honest dollar of value behind it. I would like to show them that we have repeatedly made our reductions, amounting to seven in the last ten years, coming down from \$3.50 (the price ten years ago) to our selling price of \$1.70 to-day; that we have made these reductions in strict regard to the rights of consumers, and to the obligations that we imposed upon ourselves when we accepted the franchise from the public which allowed us to dig up the streets. If we had in Rhode Island a body of commissioners (whom the people would believe in, and whom they would trust as being in their interest either exclusively or primarily, whose duty it was to make these things clear), why, the public might be made to see; but if we say to them we have done that, they hold there is some ulterior design in all we assert, and that we have not done all these things with any motive of regard for them, but have been forced to do so from motives of policy, and with regard strictly to our own interest. I should welcome in our State the advent of just such a commission; and I believe that it would be eventually better for the public that such legislation should be inaugurated as speedily as possible, and that we should have a commission as well as in Massachusetts. Still, such a commission should be based upon the broad principle of the English enactments, in that all the rights of the companies, as well as their obligations, should be fully defined. I sincerely endorse this resolution, and hope that it will be passed; and I would, if language can possibly make it so, have a still stronger expression of our endorsement of such proposed legislative action.

The President—Why would it not be a good thing to have this resolution put in a little better shape, and reported at an adjourned meeting of the Association this afternoon?

Mr. Stedman—I move that the resolution be laid over until the afternoon session, in order to allow the mover to re-write it, or to improve upon it if he would like to. I think, perhaps, as these amendments have been embodied in it from time to time, the phraseology of it may be made more striking if it is carefully looked over.

Mr. Stedman's motion was agreed to, and further discussion of the resolution postponed until the afternoon session.

MR. NEAL REFUSES A RE-ELECTION.

Mr. Neal—Before the Committee on Nominations report I wish to say a word with regard to the nomination of a Secretary and Treasurer. I have held the office for the past fourteen years, or at a date commencing with the organization of the Association. Of late years I have said, before the nominations were made, that I was perfectly willing to retire from the office; and I am to-day not only willing but desirous of retiring. No one will welcome my successor in office more cordially than I shall; I wish the Committee to understand just how I am placed and how I feel about the matter. I wish to express myself very strongly on this matter; I shall be very happy to retire from office, and hope the Committee will, in making the nominations, consider my present statement.

PROPOSING TO HOLD NEXT ANNUAL MEETING AT ANOTHER CITY THAN BOSTON.

Mr. Harbison stated that the Executive Committee had been discussing the question as to the advisability of holding the annual meetings at cities other than Boston. He pointed out that no provision in the Constitution of Association directed the meetings to be held at Boston (although hitherto Boston had been annually chosen), and he himself thought a change in the practice would be desirable. To test the views of the members Mr. Harbison offered a resolution empowering the Chair to appoint a committee of three to name a place for holding next annual meeting; and that the committee be instructed to pay due heed to the advisability of naming another city than Boston. The motion was agreed to, and the Chair named Messrs. Harbison, Cushing and Stiness as such committee.

Mr. Thomas—As this is the dual occasion of the meeting of the oldest and youngest Associations of American Gas Engineers, I would suggest that the congratulations of this Association (the oldest) be sent to the newly-born organization (the Ohio Gas Association) now in session at the Burnett House, Cincinnati, Ohio. I will bring it before your consideration in the shape of a formal motion. Mr. Harbison seconded the motion; it was put by the President, and carried unanimously. The following telegram was then sent:

"To GEN. A. HICKENLOOPER, President Ohio Gas Association, Burnett House, Cincinnati, Ohio:—The New England Gas Association, the oldest in the country, wishes to extend to you, the last born, congratulations upon the formation of your Association, and tenders to you the right hand of fellowship.
M. S. GREENOUGH, President."

The Association then adjourned to reconvene at 3 P. M.

FIRST DAY—AFTERNOON SESSION.

THE GAS COMMISSION RESOLUTION.

When the members were called to order President Greenough announced that he would take from the table the resolution submitted by Mr. A. B. Slater on the subject of the Gas Commission. Mr. Slater explained that the resolution had been reworded with the object of incorporating the special points urged by members during the previous discussion. The altered wording made it read as follows:

"Resolved, That this New England Association of Gas Engineers heartily approves of the effort, now being made in the State of Massachusetts, to have appointed a Gas Commission which shall have the general supervision and regulation of the business of the gas companies, believing that it is the proper policy to be pursued, and that it will result in important advantages to both the gas consumers and gas companies, provided that due regard and proper protection is accorded both parties."

The resolution, without debate, was adopted unanimously.

REPORT OF COMMITTEE ON NOMINATION OF OFFICERS.

Mr. Sherman, of Committee on Nomination of officers for ensuing year, reported the Committee recommended the selection of the following gentlemen to fill the positions as assigned:

For President—M. S. Greenough.

For Vice-Presidents—John P. Harbison, and A. M. Norton.

For Directors—Wm. A. Stedman, Geo. B. Neal, Robt. B. Taber, Wm. York, C. L. Gerould.

For Secretary and Treasurer—Charles H. Nettleton.

The President—Gentlemen, I think the Association must see that it is a rather difficult position in which I stand and am placed by the courtesy of this Nominating Committee. It is perfectly well known that I have advocated and recommended that the President should be annually changed, as I

believe that there are plenty of people in this Association who could fill the position acceptably; and that so long as Presidents could be brought forward for re-election it was impossible for the gentleman in that office to avoid feeling slighted in case he was not re-chosen. I thought we had settled that thing last year. I shall only consent to have this list of officers go before the Association to be voted for on the distinct understanding that this question of re-election be clinched this year, at all events, so that the matter may be placed in the position where it belongs. I wish to say to you that I am very much obliged for your courtesy; but I do not think that a retiring officer ought to be eligible for re-election.

Mr. Sherman—The matter of re-electing a President was brought up in Committee Meeting; and the impression of the members was that a vote had been passed to the effect that a new President should be chosen every year. A search over the record proved that if any such vote was passed it was not recorded.

Mr. Stiness moved that a committee of one be appointed to cast the ballot of the Association in favor of the election of the gentlemen named in report of Nominating Committee. The motion was agreed to, and Mr. Stiness, being named as the one to cast the ballot for election, performed that duty, and thereupon reported the result of vote as a unanimous selection to office of the gentlemen above named.

The President—You have heard the report made by Mr. Stiness. I can only say, as one of the officers chosen, that we shall of course endeavor to do our best to satisfy you. Personally, I feel very much obliged to you for the courtesy which you have shown in my re-election. I do not know whether Mr. Nettleton [Mr. Nettleton had just entered the room] is aware of the fact that he has been elected Secretary and Treasurer.

Mr. Nettleton—Gentlemen, I sincerely thank you for the honor you have done me in electing me as your Secretary; and while I cannot hope to do all that you will expect from the one who occupies that office, yet I assure you I shall do everything in my power to make the meetings successful.

Mr. Stiness—In consideration of the fact that Mr. George B. Neal has been Secretary and Treasurer of this Association for the past fourteen years, and that, as all well know, he has done his duty faithfully, I now move the thanks of the Association be tendered to him. We can all appreciate that Mr. Neal feels to-day the increasing cares of business (which indeed press upon us all), and the increasing years which bring with them desire for leisure—the wish to be relieved from all unnecessary duties, cares, and anxieties. We also know that one who faithfully performs the duties of Secretary of an association of this character has no slight task. I feel it to be due to him and to us that, as an Association, we tender to Mr. Geo. B. Neal our sincere thanks for his services as Secretary and Treasurer for the past fourteen years.

Mr. Harbison seconded the motion; and the Chairman, in placing the question before the members, gave testimony to the pleasure which the opportunity afforded him. When the Chairman announced the unanimous action of the members in regard to passage of the vote of thanks, Mr. Neal, with much emotion, spoke as follows:

Mr. President and Gentlemen: For this significant evidence of your appreciation of my humble services as Secretary during the fourteen years this Association has been in existence, I beg to express my heartfelt thanks. I commenced with the Association in 1871, when the first meeting (in the office of the Boston Gas Light Company) was held, at which a constitution was adopted and officers elected. Several of those who were present at that meeting have passed away. Having held the office for so long a term, for the last two or three years I have often thought of positively declining the position, because I am connected, as director, manager, or otherwise, with so many other organizations, as to make it almost impossible to properly discharge my duties in connection with these various trusts and reserve any time to myself. I most gladly yield up my mantle to brother Charles H. Nettleton. He is comparatively a young man, and is an earnest, active worker. It seems to me that a new Secretary may devise methods by which our meetings may be rendered still more profitable and interesting. Again thanking you, gentlemen, for your kindness and courtesy, I shall be most happy to resign my charge with the termination of this meeting.

[To be continued.]

Now Black Lead Paint.

An Englishman named Andrew French has taken out a patent for preparing a new black paint by converting the "fume" from condensers of lead smelting works into sulphide of lead, by digesting it with an alkaline sulphide. The resulting sulphide of lead is to be filtered, washed, and dried, and crushed ready for use. *Engineering* thereupon is moved to state that "fume," simply taken from the flue and ground with oil and black pigment, would make a better and cheaper paint than the one obtained by French's patent. The same authority also wonders why it is that such a paint (remarkably efficacious for covering exposed ironwork) is not more extensively employed.

The Venenose Nature of Carbonic Oxide.

[The following official documents, known to and described on the Legislative Records of the Commonwealth of Massachusetts as "Senate; No. 60," carry with them their own explanation. They are presented in the following shape in order that the official style of publication may be adhered to as closely as possible.]

SENATE No. 60.

COMMONWEALTH OF MASSACHUSETTS.

STATE BOARD OF HEALTH, LUNACY, AND CHARITY,
CLERK'S OFFICE, STATE HOUSE, BOSTON, Feb. 24, 1885.

To the Honorable the Senate and House of Representatives in General Court assembled.

The Board, in reply to the order of the Legislature for the result of such investigations as they have made in relation to the qualities of carbonic oxide as an element in illuminating gas, herewith transmit a copy of the preliminary report of Professors Sedgwick and Nichols of their experiments in the matter, made under the instruction and direction of the Board, and comprehending all the information which the Board have as the result of their investigations now in progress.

JOHN D. WELLS, Clerk.

COMMONWEALTH OF MASSACHUSETTS.

In the Year One Thousand Eight Hundred and Eighty-five.

REPORT.

To the Board of Health, Lunacy, and Charity of Massachusetts:

In presenting a preliminary report on the relative poisonous qualities of common illuminating coal gas and the so-called water gas, and on their probable effect upon the public health, we desire to say that, while certain points necessary to the completeness of the investigation still remain to be elucidated, our experiments have already enabled us to form a decided opinion with reference to the matter.

It is generally admitted that, while the other ingredients of illuminating gas are not without their physiological effects, when breathed with air, in a mixture of which they form a large proportion, nevertheless the only ingredient possessed of really toxic properties is carbonic oxide [CO]. Of this the intensely poisonous properties are well known, and they have been so long undisputed that they now belong to the common stock of science, and no longer require discussion.

The effects upon animals confined in small space, of mixtures of this gas with air in known proportions, have also been sufficiently and carefully studied.

It has seemed, therefore, to us, that the problems set before us would be solved best, especially from a practical point of view, not by further work in these well-occupied fields, but by experiments conducted, as nearly as possible, under conditions likely to occur in the actual everyday use of illuminating gas.

In making this preliminary report, we shall give briefly the general results of our investigations, going into details only far enough to show the convincing character of the evidence upon which our conclusions are based. We have experimented with several of the higher animals; viz., dogs, cats, rabbits, guinea pigs, and pigeons,—and we have, also, as will be mentioned farther on, observed something of the direct effects of illuminating gas upon man himself. The experiments have been conducted at Newton, Mass., Middletown, Conn., and Athol, Mass. In each case gas was taken directly from the pipes of the local company, and our analyses have shown the coal gas distributed in Newton to contain about seven per cent. of carbonic oxide, while the water gas supplied in Middletown and Athol contains about thirty per cent.

The conclusions to which our experiments have led us are as follows:—

1. Water gas is decidedly more poisonous than coal gas.
2. Our experiments confirm the work of others in proving that carbonic oxide is not a cumulative poison; that is to say, the breathing of certain small quantities for a long time is not equivalent to the breathing of a large quantity for a short time; and this fact has much to do with the difference between the effects of the two gases. For an atmosphere containing a certain small percentage of coal gas may be breathed for many hours without serious effects, while an atmosphere containing the same amount of water gas will be injurious and even fatal.
3. In order to produce distinctly poisonous effects by means of either coal gas or water gas, it is necessary that the percentage of carbonic oxide in the mixture of gas and air shall reach a certain amount, and to accomplish this

with coal gas in an ordinary room is a matter of some difficulty, as we have found, because the natural ventilation which is all the time going on through the walls, ceiling, and floor, and through the cracks about the doors and windows, permits of so much diffusion, that this, combined with the moderate amount of carbonic oxide present in the inflowing gas, does not allow the danger line to be easily reached. If it were not for this fact, accidents from the use of coal gas would be much more frequent than they actually are. With water gas, on the other hand, it is not at all difficult to reach the danger line; *i. e.*, to obtain, in an ordinary apartment, a dangerous percentage of carbonic oxide. This is not, as some suppose, on account of the somewhat higher specific gravity of the water gas as a whole, for this fact would influence but slightly the diffusion of the dangerous ingredient,—carbonic oxide; but rather on account of the larger proportion of this poisonous ingredient which water gas contains.

Water gas is therefore not only in itself more poisonous than coal gas, but is also far more likely to produce injurious effects from similar accidental causes.

It must not, however, be inferred that a gas containing twice as much carbonic oxide as another, is necessarily only twice as dangerous. On the contrary, the danger increases, particularly with certain percentages, much more rapidly than this.

4. Dogs, cats, rabbits, and pigeons do not show any symptoms of poisoning after exposure for many hours to an atmosphere containing one per cent. of ordinary coal gas, being apparently able to resist it almost indefinitely; and in one case animals were exposed for twenty-four hours to an atmosphere containing, the greater part of the time, as much as two per cent. of this gas, without showing symptoms of anything worse than discomfort and drowsiness.

On the other hand, dogs, cats, rabbits, and pigeons, when exposed to an atmosphere containing from one-half to one per cent. of the water gas (with which we have experimented in Middletown, Conn., and Athol, Mass.), have invariably, by the end of an hour and a half, shown serious symptoms of poisoning,—such as anxiety, salivation, vomiting, delirium, loss of muscular control, etc.; and death has generally resulted after five to eight hours' exposure to an atmosphere containing not over one per cent.

5. If, instead of comparing the effects of the same percentage of the two gases, we consider the *time* necessary to cause poisoning by the use of the same quantities of gas under the same conditions, we find a contrast not less striking.

One of our most recent experiments is especially instructive in this connection, and also from a practical point of view.

By means of partitions, two rooms—one in Newton and one in Athol—were made as much alike as possible, both as to shape and cubic space. Each room had a capacity of about 700 cubic feet, which was somewhat larger than a room in Middletown in which a fatal case of poisoning from water gas actually occurred. Three dogs, two cats and two rabbits, all apparently healthy and strong, were placed in the room in Athol, and the water gas in use there, containing about thirty per cent. of carbonic oxide, was allowed to flow in from a single ordinary burner, at the rate of six feet per hour. The experiment began at 11.15 A.M., and at 12.45 P.M. vomiting, delirium, convulsions, etc., had already been noted. Half an hour later, all the animals were unconscious, or apparently so, failing to respond to vigorous knocks and calls. At 2.30 P.M., or about three hours from the start, the two cats were dead, and the other animals were prone and quite unconscious. The dogs died at 3, 4, and 6.30 o'clock respectively,—the rabbits, also, at 6.30. In a word, symptoms of poisoning were well developed in an hour and a half. Deaths began to occur in a little more than three hours, and all were dead within eight hours. This experiment was witnessed by members of your Board.

In the corresponding experiment at Newton, made with coal gas, containing about seven per cent. of carbonic oxide, two dogs, two cats, two rabbits and two pigeons were placed in the room, and the gas was introduced from an ordinary burner, as before, and at the same rate,—six feet per hour. The experiment began at 8 A.M., and for three and one-half hours no symptoms of consequence were observed, and then only drowsiness and general anxiety, with salivation in one case. At 4 P.M., *i. e.*, after eight hours, nothing more than a gradual exaggeration of these symptoms had occurred. Recovery would apparently have still been possible, and even easy, at this time.

After twenty-four hours, *i. e.*, at 8 A.M. of the next day, one cat and one rabbit were dead, but the others were not even unconscious, being still responsive to knocks and calls.

It was thought to be desirable to employ different kinds of animals in these experiments, in order to ascertain whether or not the effect of these illuminating gases are so general that an inference may be safely drawn as to their effects upon human beings. We have observed slight difference in susceptibility among the animals used; but differences, nevertheless, practically unimportant. Incidentally we have been enabled to note the primary effects upon man himself, for, while we have frequently entered rooms

charged with coal gas, and, in some cases, have remained comparatively long, the effects have never been more than disagreeable. Oppression and headache have not seldom resulted from entering in the same way rooms charged with water gas; and in one instance exposure for a total of one hundred and ten seconds to an atmosphere containing two and a half per cent. of water gas produced anxiety, trembling, partial loss of muscular control, slight nausea, and an after headache of the severest character, lasting for several hours.

In conclusion, we may say that our opinion, based upon experiments, is decidedly averse to the general distribution of the so-called water gas, containing, as it does, a large proportion of carbonic oxide. This opinion has been strengthened by our visits to Middletown, Conn., where that gas has been for some time in use. But as the Health Officer of your Board has himself visited that city, we do not feel it necessary to rehearse the facts there ascertained.

Respectfully submitted,

(Signed) WM. T. SEDGWICK.

(Signed) WM. RIPLEY NICHOLS.

Address of General Andrew Hickenlooper to the Members of the Ohio Gas Association.

[Owing to an unavoidable delay in preparation of stenographer's minutes of the Cincinnati Meeting of Ohio Gas Light Association (held at Burnett House, Cincinnati, Ohio, last February), we are unable to commence our detailed "Official Report" of proceedings with the present number. We are constrained, therefore, to publish (out of its regular order) the following address of President Hickenlooper read before the members on the morning of first day.]

To the Members of the Ohio Gas Light Association:

Gentlemen—For the compliment of being called upon to preside over the deliberations of the first regular meeting of the Ohio Gas Light Association my thanks are certainly due, and most gratefully tendered; and it now affords me pleasure to take advantage of this my first opportunity of expressing my hearty approval of the action taken by the gentlemen who have inaugurated the movement, and who have thus given assurances of being in full sympathy with that spirit of progress which has, for several years, been slowly but surely wiping out the record of former exclusiveness, secrecy, and even mystery, which for many years marked and marred the history of gas lighting, and blocked the way to progress and improvement.

The old-time managers who, like oysters, lay glued to their plants, eyeless and earless, but with mouths wide extended, waiting to take in only what fortune's tide might force their way, have gradually transferred their trusts to men having a higher appreciation of the constantly changing conditions created by the discoveries and advances made in artificial illumination, and which have recently forced upon even our most advanced thinkers the realization that, regardless of personal qualifications and opportunities, perfection in practical knowledge cannot be attained within the limited sphere of one's own individual action, and that there must now be a more general and complete recognition of mutual dependence and the advantages to be derived from a more frequent inter-exchange of thoughts, experiences, and acquired information.

The establishment of an association which will furnish this much needed channel of communication, and which has for its object the dissemination of information calculated to increase your own professional usefulness, and bestow upon the community at large the benefits and advantages which, in any calling, invariably follow the triumph of brains over muscle, cannot but receive the hearty approval of all.

In view of the existence of the American, New England, and Western Gas Light Associations, some may have doubted the wisdom of forming another Association having a more restricted field of operations; but when we realize that you have within yourselves all the elements necessary to a thorough consideration of subjects affecting local interests; that the people of each State have in a greater or less degree their own distinctive peculiarities; that the character of the crude materials used and methods of manufacture are not identical; that the sources of supply are more or less remote; and last, but not least, that the laws and ordinances under which we are called upon to act are essentially different in almost every State of the Union, it appears to me that yours is the true basis for an effective working organization, which can be afterwards united in friendly alliance with similar organizations in other States, whenever it may appear necessary or advisable, for the consideration of questions having a wider scope and bearing.

I very much regret that you cannot properly be congratulated upon the general commercial and industrial prosperity of the country with which our business interests are so peculiarly and closely identified. The past has been a year of universal business depression, marked mainly by the general shrinkage of values, curtailment in production, lowering of prices, decrease in the value of residuals, enforced economies, and the organization and ad-

vancement of blackmailing and raiding schemes, which, unless soon checked by wise and prudent legislation, will lead to effects irreparably detrimental to the best interests of the communities which thoughtlessly tolerate such pernicious practices. But as surely as daylight follows darkness, returning confidence and renewed prosperity will follow this period of depression; and while there may be little consolation in the knowledge that other countries are laboring under equally depressing conditions, it certainly shows that our misfortunes are not due to exceptional causes. Already the improved business of our railways, decrease in mercantile failures, and increased employment of workmen, give promise of a brighter future.

It is, therefore, but the part of wisdom to now take advantage of the abundance of labor and cheapness of material to place your works in a condition to meet the demands which at no very distant day will be made upon your carbonizing capacity. In pursuance of this policy, coupled with other no less important considerations, the Cincinnati Gas Light and Coke Company has recently built the "East End Station," which, we believe, you will, on inspection, pronounce one of the most compact, best arranged and judiciously constructed gas works ever built in this or any other country.

For your information and entertainment I have caused these photographs to be placed on exhibition, showing the monthly progress of the work; and as this is your first official visit, and your Executive Committee has provided that about one-fourth your time shall be devoted to the inspection of the plant, it appears but proper that I should now, even at the risk of being a little prosy—but with the hope that it may possess some historic interest and value—briefly review the history and progress of gas lighting in Cincinnati, and couple with it a condensed description of the new station.

The first movement toward furnishing a supply of gas to the city of Cincinnati was based upon a communication received from John Towne, at that time a citizen of Pittsburg, Pa., dated September 5th, 1827—just seven years after the first introduction of gas into the United States—in which he agreed to furnish gas to the public lamps at an expense of 15 per cent. less than the cost of oil.

This proposition elicited considerable discussion in the municipal Council, and was only accepted upon condition that he would guarantee that it would not injure the health nor endanger the property of the citizens in a greater degree than the use of oil for the same purpose. As no further action was taken by Mr. Towne, it is presumed that he was unwilling to assume such grave responsibilities, or, upon more mature reflection, he concluded that the population, which at that date was but 15,540, was not sufficient to justify the establishment of a manufacturing business about which so little was then known.

Two years later Warner Hatch and his associates, John McCormack, Peyton S. Simms, and W. R. Griffith, petitioned for the privilege of erecting works, which privilege was granted upon condition that the expense of the public lamps should not exceed one-half that of oil, and that the works should be erected within eighteen months after the grant was made.

As these gentlemen expressed an unwillingness to be hampered by such conditions, further negotiations were abandoned.

In July, 1831, negotiations with the city were renewed by some gentlemen acting under the title of, "The Gas Light Company," and kept up for several years, resulting, in 1834, in an open proposition by the city to grant the exclusive privilege of the use of the streets for a period of 25 years to any person or persons who would comply with the following conditions:

- 1st. Subscribe stock and advance funds to extent of \$30,000.
- 2d. Commence works at once, and lay 4,000 feet of main pipe within one year.
- 3d. Supply lamps with same style of burner as those used in New York or Baltimore, and light during dark nights for one-half the cost of oil.

No one being found willing to comply with those conditions, the project died a natural death; but from its ashes arose a *paper* organization composed of the following named gentlemen, all prominently identified with the early history of our city: Warner Hatch, John McCormack, Peyton S. Simms, Wm. S. Hatch, M. S. Williams, E. D. Mansfield, and Benjamin Drake, to whom the State Legislature, on the 3d of July, 1837, granted a charter under the title of "The Cincinnati Gas Light and Coke Company."

On the 25th of September, 1839, the City Council passed an ordinance authorizing the organization of the "Cincinnati Gas Light and Coke Company," substantially on the Philadelphia (Pa.) plan.

The capital stock was placed at \$150,000, of which the City Treasurer was authorized to subscribe \$50,000, and issue 6 per cent. bonds for the amount. The control of the company was to be vested in a Board of Trustees composed of nine citizens of the city, six of whom were to be stockholders, and all to be elected by the City Council. Public lamps to be supplied at two-thirds the price charged private consumers, and all monies arising from the sale of gas to be paid into the City Treasury. Objections being raised to the required form of organization, the ordinance was afterward amended so as to provide for the election by Council of but three trustees, and the remaining six by the stockholders. Notwithstanding the fact that for over two years

the most strenuous efforts were made to induce private capitalists to join in the enterprise, none could be induced to do so, and the project was abandoned.

On the 27th of May, 1841, Mr. Griffin presented to the City Council a communication from James F. Conover upon the subject of lighting the city with gas, which finally resulted in the passage of an ordinance, on the 16th of June, 1841 (just 14 years after the subject was first considered by Council), granting to said Conover and his associates the exclusive privilege of furnishing gas to the city and citizens for a period of 25 years, and thereafter until the city should elect to purchase the property of said company. This ordinance being accepted by Conover, forms the basis of the contract under which the Cincinnati Gas Light and Coke Company has since been operated. He at once acquired the old charter granted to Warner Hatch and associates, organized a company on a basis of \$100,000 capital, and invited capitalists to join him in the new enterprise; but as none could be induced to do so, and being a man of limited means, he experienced considerable difficulty in raising sufficient funds to make a start; still he went bravely to work on the 21st of October, 1841, and during the following two months expended about \$3,000; but finding it would require more money than he could command, on the 14th of January, 1842, he disposed of one-half his interest to James H. Caldwell, receiving in payment a brick house and lot on corner of 3d street and Broadway, and two certain promissory notes for \$5,000 each.

With the proceeds of this property, and some additional money furnished by Caldwell, the work was resumed and pushed forward with renewed energy; and in just one year thereafter gas was turned into about four miles of street mains, ranging from 2 inches to 8 inches in diameter, and on which there were but 22 consumers. For several years they derived no profit from their investments, were hard pressed for funds with which to carry on the enterprise, and were, in addition, subjected to all sorts of annoying municipal interference and obstructions. Mr. Conover's health had suffered during this trying period, and these annoyances no doubt hastened his death, which occurred but two and a half years afterward at Bedford Springs, Pa. His surviving partner, J. H. Caldwell, who was at the time in New Orleans, La., arrived in Cincinnati Aug. 16th, and assumed personal control of the company's affairs. At this period the company had in use about six miles of main pipe, and were supplying 192 public lamps, and 546 private consumers.

As the city was growing rapidly, and carrying with it a corresponding increase in consumption, Mr. Caldwell was successful in inducing Reuben R. Springer and other local capitalists to take an interest. This gave the enterprise commercial and financial standing, and ensured its final and complete success.

From this time forward the prosperity of the company kept pace with the growth of the city, until it now covers nearly 12 square miles of territory, supplies 6,000 public lamps, and 16,000 private consumers, from two works—the West End Station, built upon the site originally selected, and the East End Station but recently completed, which occupies a tract of about six acres, between Main and Spencer streets, and extending back from Eastern avenue to the Ohio River. This tract of land, known to the older residents of Cincinnati as "Sportsman's Hall," and more recently as the "East End Garden," was purchased by the company, April 22d, 1875, with the ultimate view of erecting thereon a works possessing all the modern improvements, and freed from the risks of fire and flood.

The design and general arrangement of the buildings and machinery, and selection of the material to be used, were determined upon by the executive officer of the gas company.

The detailed drawings were prepared by Wm. Mooney, of New York, and the work executed under the immediate supervision of Clinton Bunten, Supt. of Construction, assisted by John Fullager, Engineer, who had special charge of interior fittings and bench construction.

The main building fronts 408 feet on Eastern avenue, with wings extending back 125½ feet on Main street and Spencer street.

The center portion is 50 feet square, occupied as Superintendent's room, office, governor and valve room, draughtman's office, photometer room, tower scrubber rooms, and Superintendent's residence rooms. Next adjoining, on the west, comes the exhauster room, washer-scrubber room, store-room, and lime purifiers. The wings covering the lime room, oxide purifiers, and oxide room.

East from the center building are located the condensers, station meters, and high water boiler; and, adjoining, an exact duplicate of purifying apparatus in Main street wing.

Immediately south of this building, and partially within the court, are located two telescopic holders, each 124 feet in diameter, with thirty feet lifts, giving a storage capacity of about one and one-half millions cubic feet.

East of the holders on Spencer street will be found the boiler house, in which are located two Babcock and Wilcox boilers, giving 240-horse power, with upper room to be hereafter used as a carpenter shop.

West of the holders, on Main street, will be found the blacksmith shop, machine shop, and room for fittings. Between the holders and these buildings passes an inclined roadway, having a grade of 7 feet in 100 feet, by which communication is maintained within the enclosure between the upper and lower levels.

Immediately south of the holders and the adjoining roadway will be found the retort house, extending east and west from Main to Spencer streets, 385 feet in length by 90 feet in width.

South of and adjoining the retort house are located six hydraulic elevators, which are all operated by water conducted from an artesian well 6 inches in diameter, and 1,600 feet in depth, which gives a constant supply of clear sulpho-saline water, under a pressure of fifty-two pounds per square inch.

Two of these are short-lifts, to be used in delivering material from yard to retort house floor; two 37-foot direct lifts, for delivering coal from the yard to level of trackways running over the retort house coal bins; and two—one opposite each end tower—are to be used in elevating the coke to be deposited in coke bins; the space between these bins will be used for coal storage. About 110 feet south of the center tower will be built the main or steam elevator building, 25' x 37', the basement of which will be used as a store-room; in the first story will be placed two tubular Butman boilers, and immediately above will be located the engines and elevating machinery. From this building will run the river incline, at a grade of 53½ feet in 100, under the north end of which will be located the pump well, 9 feet in diameter and 30 feet deep, in which will be placed a Gordon & Maxwell 11-inch pump, having a working capacity of 17,000 gallons per hour.

Inside the retort house will be found two ranges, each containing fourteen arches, holding eight through oval retorts, 15' x 22" x 22' 6" from face to face of mouthpieces; the whole being equivalent to 448 single 9½ feet retorts, and having a total maximum carbonizing capacity of four millions cubic feet. In the basement, and immediately under the benches, are located the generator furnaces, into which is fed the hot coke discharged from the center two retorts, being 25 per cent. of the production, which is found to be ample. Running east and west, on each side of the ranges, are located the trackways on which move the Ross steam stokers, of which we have three pairs in position, ready for use.

In the towers, at each end, are located the "stables," in which will be kept the reserve machines, ready at any moment to be run out to take the place of a machine temporarily disabled.

It has been demonstrated, over and over again, that, taking single retorts at a time, these machines are capable of continuously discharging and charging 80 retorts per hour. With the settings and retorts arranged as they are here, we have practically demonstrated the ability of these machines to discharge three retorts with one movement, or at the rate of 240 retorts per hour.

Along the inside of the building, north and south of the ranges, are located the coal bins, over which run the trackways carrying the cars bringing the coal direct from the river, or from the elevators, on which it has been raised from the yard level.

In the basement, close up to the face of benches, will be located the coke trackways carrying the cars into which the hot coke falls as discharged from the retorts above, and in which it is quenched by water sprays. These cars will then be run out by hand to the coke elevators, elevated, and contents dumped into the bins ready for delivery into the contractors' wagons.

Thus the coal to be carbonized will be loaded into cars direct from the barge, drawn up the incline, run into the retort house, and discharged into the bins.

The discharging machine will commence at one end, and first discharge the center retorts into the furnace, then, returning, will discharge the coke from the side retorts into the cars on trackway in basement, followed, of course, as rapidly as it moves, by the charging machine, the receiver of which is run back, by a simple mechanical contrivance, under the lip of the bin; the gate being raised, the coal moves by gravity into the three compartments of the hopper. When filled, it is run forward a few inches into the mouthpiece of the upper retort, and a few quick blasts of dry steam projects the entire contents of one compartment into the retort, depositing it as evenly and nicely as can be done by shovel or scoop, and thus the operation is repeated until all are charged.

Thus it will be seen that neither the coal nor resultant coke will be touched by hand or shovel from the time it leaves the barge in the river until the coke is delivered at the door of the consumer, miles away from the place of production.

While it has been our aim and effort to so construct these works as to produce the very best quality of coal gas at a minimum cost, none of us are infallible, and it is therefore not improbable that, after being subjected to the critical inspection of so many gentlemen of experience and ability, you will be able to suggest many improvements and betterments of which we will be only too glad to avail ourselves.

ITEMS OF INTEREST FROM VARIOUS LOCALITIES.

A CORRECTION.—In our report of inaugural address delivered by President M. S. Greenough, before the New England Association of Gas Engineers, as given in issue of March 2d, the speaker goes on record as having said "that an analysis of the gases from the furnace" showed the presence of 31.48 per cent. CO. The error is so obvious that formal correction of it may seem superfluous; still it is only just to Mr. Greenough that we should shoulder responsibility for it ourselves. The gentleman distinctly informed his hearers that analysis of the furnace gases disclosed the presence of but 21.48 per cent. CO.

BACKING AND FILLING OVER STREET LIGHTING MATTERS AT NEWPORT, R. I.—The fame of sturdy, ocean-beaten Newport as an attractive and invigorating spot, much sought after by those who seek shelter from the too fierce rays that prevail with provoking persistence in less favored locations during the heated term, is deservedly great "nobody can deny." Now, with all these pleasant peculiarities and decided advantages one would be disposed to hope that the controlling spirits of its municipal councils were animated with a fixedness of purpose that would become all the more striking when placed in contrast with the vacillation and weakness usually displayed by the general run of urban (suburban might also be included) councilmen. But Newport varies not from the prevailing style in this important particular, and its perforce content to put up with the whims and vagaries of her erratic rulers; and possibly may set up as an excuse for her leniency towards her city fathers that, having been so long listening to the crooning of the "sad sea waves," they have, insensibly it may be, become so habituated to such musings as to cause their veriest humdrum business impulses to be actuated by a regularly harmonious ebbing and flowing mentality. This queer possibility is suggested to the disinterested observer from a consideration of Newport's latest Councilmanic action in regard to public street lighting. During the early progress of the electric lighting "boom" the city fathers' mentality "ebbed" to the depth of ordering the streets to be illuminated in accordance with the electric plan. It was carried out, and the "improved system" (the city was lit about one-half as well as it was before, when the gas lamps were employed) cost the taxpayers in the near neighborhood of an additional ten thousand dollars per annum. With 1885 a "flow of mentality" arose in the spirit of the Councilmen, who concluded that the "ten thousand" might as well be saved, and to that end voted that the proposition of the Newport Gas Light Company be accepted. Before the contract was signed, however, the "ebb" again set in, the influence of the "moonshiners" having been brought into play in the shape of a petition presented, bearing the signatures of about a fourth portion of the entire taxpaying body, which prayed that the Council recall its action as to substituting gas for electricity, and asked that the arc lights be retained. The prayer of the remonstrants was heeded, and accordingly will Newport be only half lighted for another year. If the writer understands the case thoroughly the signing taxpayers embraced the richer section of Newport's denizens, and consequently do we find further evidence in support of the statement made some time since that electricity is but the light of the rich. We need not remind the gas makers that their democratic product is content to hold out its light-giving properties "to all sorts and conditions of men."

PERSONAL.—Mr. P. T. Burtis, who, as is well known to the fraternity, gave the best of his years to the service and advancement of the interests of the Chicago (Ills.) Gas Light Company, is at present making his home at Mt. Holly, N. J. Those wishing to communicate with him are requested to make note of the above fact.

A LONG LINE OF BURNING OIL.—A despatch from Lebanon, Pa., dated March 4th, brought the news that at a late hour on the previous night an 8-inch pipe line, conveying oil from the wells to the seaboard, became fractured at a point where it passed through the lands of one Abraham Kreider, a Wrightsville farmer. The escaping oil flooded the neighboring fields, and was speedily set on fire from sparks thrown out by a passing locomotive. It is stated at one time the accumulation of oil reached a depth of several feet, and was spread over several acres of ground. The sight presented was a magnificent one. The farmers in the vicinity turned out in force and threw up an embankment, thus confining the flood to a comparatively limited area. The blaze lasted through 36 hours, the feed to fractured main not having been shut off until late on March 4. It is reported that 10,000 barrels of crude oil were destroyed.

THEY CANNOT COME BACK AS KNIGHTS OF LABOR.—Some short time ago we had occasion to put on record the fact that a few of the hands employed by the Goodwin Gas Stove and Meter Company, of Philadelphia, Pa., had attempted to dictate to Mr. Goodwin in certain respects as to how that gentleman should manage the details of his business; and we also stated that

Mr. G. had an idea that he could attend to such things himself. Having always treated his employees with due consideration and fairness, when the men conceived that they had a grievance, Mr. Goodwin announced his willingness to investigate the grounds for complaint urged by his helpers, and to rectify anything having the appearance of error; he also informed them that he would not treat with any organized labor association, nor its representatives, but only with individual employees. He instituted the investigation, and determined that the "strikers" demand in regard to pay be acceded to. The "Knights of Labor," however, did not think it compatible with their dignity to let the "strikers" resume work until Mr. Goodwin recognized the organization; as a consequence the men are "still out," and there they will stay unless the "Knights" come back to a sufficient knowledge of the fact that daily labor is, and will be, governed by the inexorable law of supply and demand. In the meantime the Filbert street shops do not appear to have gathered any moss; but, then, moss always shows to best advantage in places quite unlike those afforded within or near the location of a thriving manufacturing establishment.

CHEAPER GAS FOR LOWELL MASS.—Our friend, Mr. O. E. Cushing, of the Lowell (Mass.) Gas Light Company, is one of those who seem to manage to make money out of cheap gas. Pretty nearly every one thought that, when his company made the \$1.50 rate, it would be quite a while before another reduction would be announced; still it seems that sort of calculation was unfounded, for "here they are again" out with a further "declaration of intention." With the commencement of March it was decided to insert an advertisement in the Lowell daily papers that, "on and after April 1st, the price of gas will be reduced from the rate of \$1.50 per 1,000 cubic feet to \$1.40 per 1,000 cubic feet, such reduction to apply only to accounts settled on or before the 5th day of each month." Brother Cushing thinks evidently that "keeping the rascals out" is much preferable to buying them out. So it is, cheaper and cleaner. Dividend checks are rather different in their nature to subsidy checks. The Lowell Daily Courier, in mentioning the reduction, says: "No one can complain of such terms. The reduction was made voluntarily. Few, if any places, certainly none so far away from the coal mines, enjoy such cheap gas." In one respect the Courier man is wrong. Addicks, Frost, and the other fry in their respective wakes, "cry out aloud" against such practices. Poor things!

A THREE YEARS' CONTRACT.—The Adrian (Mich.) Board of Aldermen, by a vote of 6 to 1, recently granted the Adrian Gas Light Company the exclusive right to light the streets and public buildings of the city for the term of three years. Will Mr. C. H. Raynor kindly forward us the particulars as to prices, etc?

COMPANION PICTURES TO THE CARBONIC OXIDE REPORT OF THE MASSACHUSETTS BOARD OF HEALTH.—In other columns of this issue will be found a report handed into the Legislature of Massachusetts concerning the venenose nature of carbonic oxide. From a perusal of same it will be noted that Profs. Sedgwick and Nichols, in the course of their experiments, brought to a rather sudden termination the lives of sundry small birds and some fair-sized animals; and then had the recklessness to assert that such termination was chiefly attributable to the presence of a large proportion of carbonic oxide in the illuminating gas with which the air of the experimenting rooms had been contaminated. Our readers will perhaps pardon the temerity of the Massachusetts professors, and will likely endorse all the testimony so offered, since scarce a number of the JOURNAL is published which does not convey the news that ordinary commercial water gas has succeeded in making an increase to the death list with which it had been previously charged. While Profs. Sedgwick and Nichols report the deaths of pigeons, cats, etc., it has been our sad and unwilling duty to chronicle the deaths of men and women; and all because the owners of pretended patent rights may amass wealth, even though the riches be secured at the expense of an untimely taking-off of a greater or lesser number of the "ignorant class"—as they have so often and so feelingly expressed it. The latest addition to the carbonic oxide death roll is here appended, the accounts of the happenings being reprinted from the columns of the New York Daily Tribune, dates of March 4th and 5th.

"A man who registered at the Eastern Hotel, at Whitehall and South streets (N. Y. city), on Monday night (Mar. 2) as Samuel Brewster, of Ogden, N. Y., was found unconscious in his room yesterday morning (Mar. 3) and taken to the Chambers Street Hospital, where he died at 6 p.m. From papers found in his pockets it was evident that he had registered under an assumed name. One of the chambermaids, at 7 p.m., told Mr. Betz, the hotel keeper, she thought gas was escaping on the first floor. Mr. Betz opened the door of the room occupied by his lodger, and found him unconscious. The gas was turned on full. In the man's pockets were discovered \$63 in bills, \$15 in gold, a note for \$275, and a receipt for \$400. The receipt and note were signed by Wm. Curren, Houtzdale, Pa. The note was made payable to John Ackard, of the same place. The receipt bore Ackard's

name also. A prescription found in the man's pocketbook had written across its face 'John Ackard, Houtzdale, Pa.' It is presumed that upon retiring he blew out the gas and fell asleep."

This is the next account: "BALTIMORE, March 4.—In a little room in the third story of Bartolo Violi's sailor's boarding house, No. 14 Fell street, the dead bodies of three men were found at an early hour this morning. They were Eugene B. Blob, Knut K. Foorten, and Joseph Jahanel, all lodgers in the house. Blob and Jahanel occupied one bed, Foorten sleeping alone. The last-named was a sailor on the German steamer *Prince Leopold*, lying at Cantou Wharf, from which he deserted on Monday (Mar. 2) and came to board with Violi. The other men were oyster dredgers, and were well known in the neighborhood. They came to Violi's last night (Mar. 3), and were assigned to the room occupied by Foorten, which is supplied with four beds. They retired at about 12 o'clock, and the keeper of the house said they were all perfectly sober. They did not get up this morning as early as usual with men of their calling, and at 7:30 o'clock Charles Culson, a boarder in the house, went to their room to call them. Before opening the door he detected a strong odor of gas, and on entering discovered that the room was full of it, and that it was still escaping from the burner. All three of the inmates were dead. They appeared to have suffered greatly before death, their faces wearing an agonized expression. The general opinion is that the gas was blown out."

The above "items" are called to the attention of the *Tribune's* jumping jack attendant upon the Senate Committee's sessions at the Morton House, this city (the members whereof are supposed to be engaged in "sifting out" the past extortions of our metropolitan gas light companies), one C. H. Bottsford, who, during an airy "attempt at public speaking" before the Gas Consumers' Association, announced the fact that "certain old-fogy gas makers of New York, who had learned the principles of their business under Murdock," were standing out against water gas simply because they knew nothing about the system. The old-fogies value human life at a much higher rate than to allow themselves, through any cause or circumstance, to become identified with a movement bringing in its train an added danger to those already threatening public safety.

DEATH No. 5.—Charles Mette, of Toledo, Ohio, put up at the Cosmopolitan Hotel, 129 Chambers street, this city, on the night of March 10th. He intended to sail for Europe by steamer leaving port on following day. Early on morning of 11th an escape of gas was traced to the room occupied by him, and further investigation developed the fact that the unfortunate man had lost his life through the inhalation of illuminating gas. The burner in apartment had not been shut off.

CASE No. 6.—W. P. Demarest, doing business at 16 Spruce street, this city, but a resident of Plainfield, N. J., had occasion to stop at Paterson, N. J., on night of March 12th. He put up at the United States Hotel, and next morning he was found in bed in an unconscious condition. The room was filled with gas that had escaped from a turned-on burner. The physician summoned to attend the sufferer said the patient could not recover.

MR. EMERSON McMILLIN MAKING MATTERS PLAIN.—Brother McMillin, of Columbus, Ohio, includes among his many affiliations a certificate of active membership in the Columbus Board of Trade, and it therefore is understood that, like his usual course in connection with whatever sort of duty he undertakes, his membership therein means something more than the mere fact of paying dues and benefiting by the exertions of his fellow members without giving in exchange a suitable *quid pro quo*. At the meeting of Columbus Board of Trade, held on evening of March 3d, "Mac," in response to a prior suggestion made by the Society, smilingly "mounted the rostrum" and delivered himself of a most interesting lecture, couched in his usual clear and precise style, occupying about one hour's time in the recital. The Ohio State *Journal* paid him the deserved compliment of publishing a verbatim report of the lecture in its columns, and it is safe to say that many a Columbus gas consumer will hereafter "haul in his horns," and be less disposed to dispute with the cashier of the Columbus Gas Light Company when engaged in the settlement of "those awful gas bills."

THEY PREFER TO BURN COAL GAS.—A recent issue of the Louisville (Ky.) *Commercial*, while reporting the result of an interview between one of its reporters and a well-known Louisville business man, the matter under discussion being the Louisville gas war, states that the speaker gave it as his opinion the people of Louisville ought to profit by the experience of the Lake City gas consumers, gained under exactly similar conditions to those now obtaining in Kentucky's biggest city. After explaining how the water gas manipulators induced large consumers to make time contracts, and noting that the Palmer House and the Chicago *Tribune* newspaper proprietors were among those signing such contracts, the gentleman went on to say: "Now, after trying the water gas for about a year, the Palmer House, the Chicago *Tribune* and some 800 other consumers of the newly-introduced

gas, despite that they had contracted with the new company, have refused to take the gas any longer, and have returned to the coal gas company." The reasons given for this refusal to burn water gas include the following: "It gives an unsatisfactory light, services and burners are constantly clogging up, and the bad odor from the gas permeates the carpets, bedclothing, furniture, etc." The speaker, in concluding his remarks, which were continued at some length, said: "I would not jeopardize the health and comfort of my family by allowing water gas to be employed in the lighting or heating of my house." Boston hotel keepers, particularly those whose hostleries are liable to be frequented by the "ignorant classes," had better take notice.

KILLED BY THE ELECTRIC CURRENT.—On the evening of March 9th, a workman named Joseph Bohlman, while attending to some repairs being made on the roof of the Gibson House, Cincinnati, Ohio, thoughtlessly seized hold of an electric lighting wire, and was instantly killed.

THE ILLUMINATING FEATURE WAS PERFECTION.—The accounts contained in the papers of date of March 5th, regarding the "Inauguration Ball," all agree in according great praise to the perfect duty performed by the Siemens lamps. The N. Y. *Tribune* correspondent asserts, "The illuminating feature was a perfection." Pity 'tis that the coming successor of Clegg, Hughes, Richards, Newbigging and King, Mister Charles Hull Bottsford (rather wormy sort of a name that), was not there to "write it up."

STILL QUARRELING AT NEW ORLEANS, LA.—It is asserted that, owing to failure to agree upon prices for public lighting, the New Orleans Gas Company, on or about March 8th, shut off the supply to lamp post services. Perhaps the city authorities are in quest of cogent "reasons." They do act that way sometimes in this neighborhood,

PERSONAL.—The fraternity will rejoice with us at learning the news that Mrs. A. W. Littleton, the estimable wife of the Secretary of the Western Gas Association, is on the high road to recovery from the dangerous illness which so suddenly attacked her.

TRYING TO DO AWAY WITH WHAT MIGHT BE FRUITFUL OF DANGER.—The latest move in the tactics of the creatures of the Standard Oil Company, comprising the water gas ring which so successfully plundered, and are now plundering, certain gas companies of Brooklyn, N. Y., to ensure as far as possible the safety of their position, crops out in the shape of a suit, nominally brought by the "People of the State," to annul a charter granted in 1874 to the projectors of a corporation known as the Equity Gas Light Company, of Williamsburgh. C. W. Blodgett, ostensibly the Secretary of the Williamsburgh Gas Light Company, was the tool selected to make the necessary affidavits before the Attorney General of the State, in order that that official might institute the proceedings so bombastically designated as "The People of the State of New York vs.," etc. We do not believe in opposition charters, nor in opposition gas companies; and one reason (a leading one also) for such belief is because we have yet failed to learn of a single case where such opposition in the end did not directly harm the "people," and consequently hope the Equity grant will be revoked. We have no pity, however, for the controlling managers of the old Brooklyn companies, on account of the position in which they now find themselves; since if it were not for their arrant stupidity and abject cowardice they would not be paying tribute to one of the greediest and most conscienceless corporations that ever cursed this country. They having almost complete control of the business of gas making in the city on the eastern bank of the East river—the Nassau's district is tolerably clear of them—we beg to submit an amended and truthful title to the present legal proceedings—that of "The Standard Oil Company vs. Equity Gas Light Company." The initial hearing was at Special Term, Supreme Court, Friday, March 6, before Judge Pratt. Blodgett and another witness were examined, when further argument and testimony was postponed to March 13.

A NEW GAS WORKS.—Los Gatos, California, is to build a gas works.

The Market for Gas Securities.

The weather during the first 14 days of March has been remarkably bad, and a temperature of only 9 degrees above zero (that figure was recorded on Friday, March 13), with the accompaniment of a blustering northwest wind, is enough to make one shiver and exclaim against the cold. Even as it was with the atmospheric conditions, so was it with the financial temperature that demoralized the bears on Consolidated gas stock. On March 2d the quotations were 84½ to 85, with quite a number of transactions; prices steadily advanced until close of market on date of March 10th, when the figures had advanced to 95½. From this extreme there was a slight reaction, on 11th, which has continued up to time of writing (noon of 14th), when 93½ was bid, with offerings at 94. During the fortnight about 6,000 shares changed hands. The assertion is made that certificates bearing the names of Messrs. Leary and Stebbins have made their appearance on the "street." We need not recall our prediction that the stock was cheap at or below 85, and we do not think it is at excessive figures yet.

Gas Stocks.

Quotations by Geo. W. Close, Broker and Dealer in Gas Stocks (with A. E. SCOTT & Co.)

72 BROADWAY, NEW YORK CITY.

MARCH 16.

All communications will receive particular attention. The following quotations are based on the par value of \$100 per share.

	Capital.	Par.	Bid	Asked
Consolidated.....	\$35,430,000	100	93½	94
Central.....	440,000	50	60	—
“ Serip.....	220,000	—	47	57
Equitable.....	2,000,000	100	98	100
“ Bonds.....	1,000,000	—	102½	103½

Position Wanted,

As Superintendent or Assistant Superintendent

Of a gas works. Has had experience in the manufacture and distribution of gas, laying of mains and services, care of meters, and repair of same. Any company in want of a temperate, industrious man, address “W. T. W.,” care this Journal.

Position Wanted.

A suitable position, in either a large or small gas works, is desired by a man who has had 12 years' experience in the manufacture and distribution of gas. Can furnish best of references. Is capable, willing, and energetic. Address

618-1t “GAS MAN,” care this Journal.

Appointment Desired,

By a graduate of the School of Mines of Columbia College, in a **Water Gas Works**

In or near New York city. Speaks English and German. Age, 22 years. Address O. BODELSEN, 1072 Tenth Avenue, N. Y. City.

TO

Builders of Gas Works AND GAS ENGINEERS.

THE CITIZENS GAS LIGHT COMPANY, OF JACKSON, TENN., are contemplating the enlargement of their works, and the changing of their process of manufacture to some one of the later and improved methods, and desire correspondence with parties who would contract for the work. Address

618-2t J. W. ALLISON, President, Jackson, Tennessee.

For Sale at a Bargain.

COMPLETE 4-INCH GAS GENERATING APPARATUS,

From our old works. Iron Frame for Roof; Mouthpieces, Stand Pipes, etc., etc.

Just the thing for adding to capacity of works already in operation, or for starting a new works. Address

616-8t GAS COMPANY, LIMA, OHIO.

Gas Works, Hempstead, Long Island.

Wanted at once—Working Manager for these works. Make, under 2,000,000 cubic feet per annum. House and fuel found. Apply, stating salary, to

618-1t STEPHEN POWELL, Superintendent, Main Street, Hempstead.

FOR SALE,

100 MINER GLOBE STREET LAMPS.

The lamps have been in use, but only those that are in good order are offered for sale. For terms, etc., address

615-1f THE NEW YORK & NEW JERSEY GLOBE GAS LIGHT CO., No. 1 Park Place, New York City.

NEW GASHOLDERS.

ENGINEER'S OFFICE, CONSOLIDATED GAS COMPANY, BALTIMORE, MD.

SEALED PROPOSALS will be received at this office until 12 o'clock, noon, March, 20, 1885, (at which time and place they will be opened), for the building of **TWO TELESCOPIC GASHOLDERS**, 87 feet diameter and 45 feet lift, at the Spring Gardens Station. Plans and specifications will be ready for examination on and after March 5. Bids will be considered from manufacturers only who have previously executed such work. The right is reserved to reject any and all bids. Envelopes containing proposals should be marked “Proposals for Gasholders,” and be addressed to the CONSOLIDATED GAS COMPANY, 19 South Street, Baltimore, Md.

F. H. HAMBLETON, Engineer.

SOUTHWARK FOUNDRY AND MACHINE COMPANY,

Successors to MERRICK & SONS. Established in 1836.

No. 430 Washington Avenue, Philadelphia, Pa.

MANUFACTURERS OF

Single and Telescopic Gasholders,

BENCH CASTINGS,

Washers, Scrubbers, Condensers, Purifiers,

And all apparatus necessary for the construction of improved new gas works and in the extension of established works. Also manufacturers of

Gas Engines, and of all descriptions of Steam and Hydraulic Machinery, and of Boiler and Tank Work.

Plans, specifications, and estimates furnished promptly on application.

CHURCH'S REVERSIBLE SCREEN FOR GAS PURIFIERS

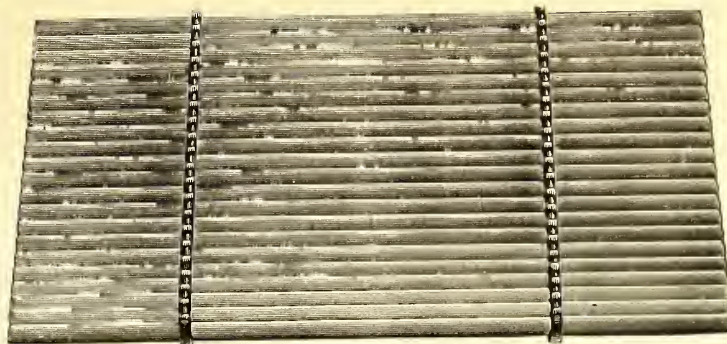

PATENTED JULY 9, 1878.

References in all parts of the country. Send for circular and list of companies who now have the Screen in use.

Very Durable Easily Repaired.

Oval Slats, with Malleable Iron Cross Bars.

Apply to

JOHN CABOT, LAWRENCE, MASS.

THE CONTINENTAL GAS ENGINE COMPANY.

MANUFACTURERS OF

GAS ENGINES,

UNDER THE

GAUME AND OTHER PATENTS,

HAVE READY

Engines of ½, 1 and 1½ H.P.

Arranged for power or for pumping. 1-horse power will pump 1,000 gals. water 100 ft. high with 85 ft. of gas; ½-horse power will pump 500 gals. 100 ft. high per hour with 25 ft. of gas.

Each Engine Tested by Indicator and Meter.

SIMPLE, ECONOMICAL, SAFE, AND SUBSTANTIAL.

Call and see engines in operation, or address for circulars and prices.

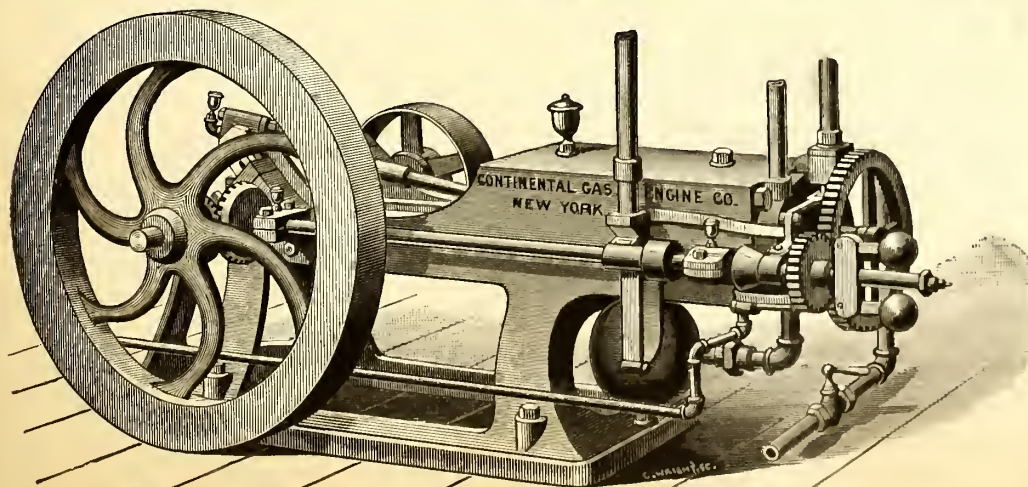

Office, No. 231 Broadway, N. Y. City.

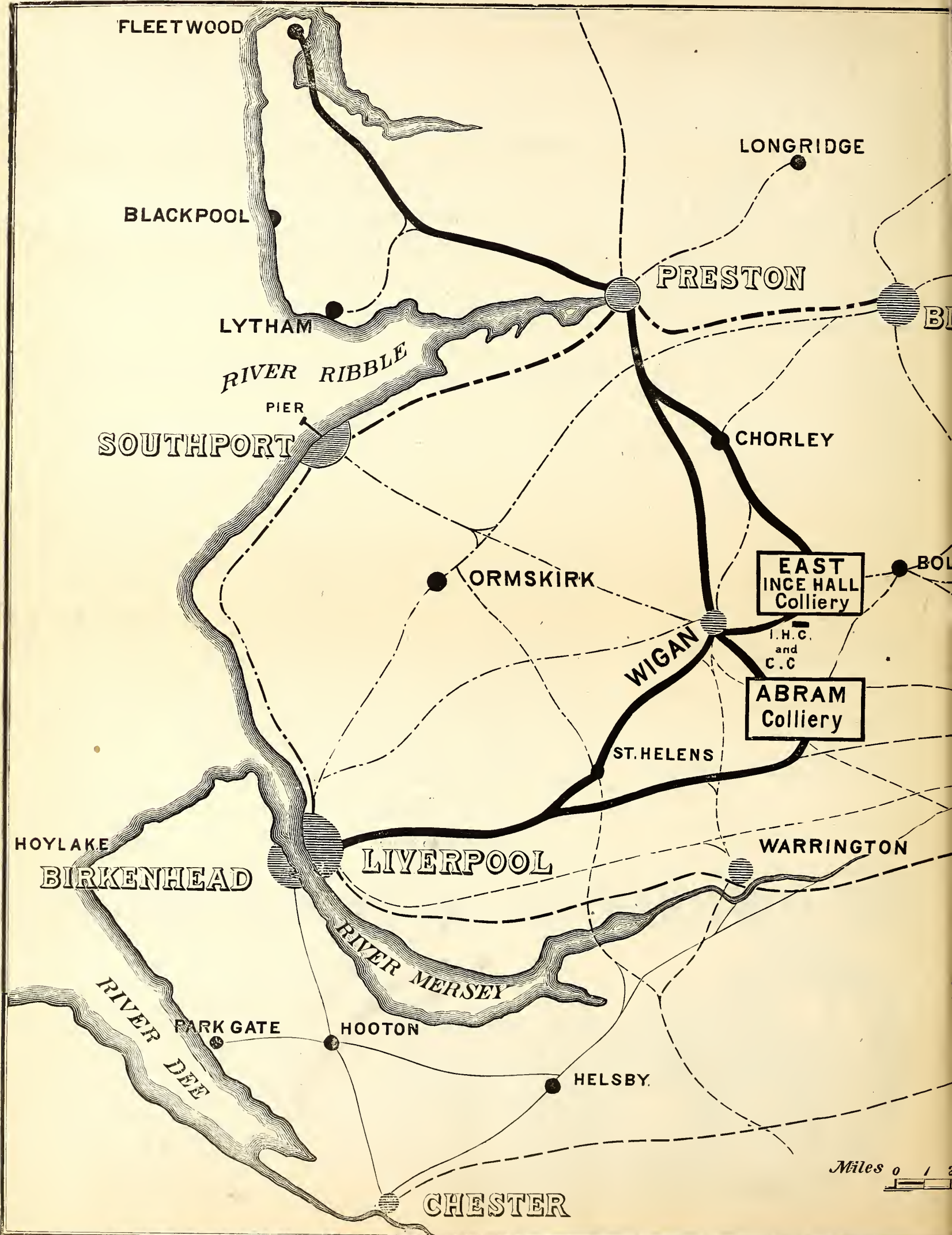

MAP OF THE WIGAN COAL DISTRICT

SHOWING THE LOCATION OF THE

ABRAM CANNEL COLLIERY

ALSO THE

EAST INCE HALL HOUSE CANNEL COLLIERY

MONTAGUE HIGGINSON & C^o, AGENTS, LIVERPOOL, ENGLAND.

SHIPPING DOCKS AT LIVERPOOL AND FLEETWOOD ENGLAND.

REPRESENTED BY

PERKINS & CO., NEW YORK.

HEROE

BURN

SFORD

ROCHDALE

BURY

OLDHAM

HUDDERSFIELD

BRANSLEY

MANCHESTER

ALTRINGHAM

STOCKPORT

SHEFFIELD

MACCLESFIELD

SCALE OF MILES.

10

15 Miles

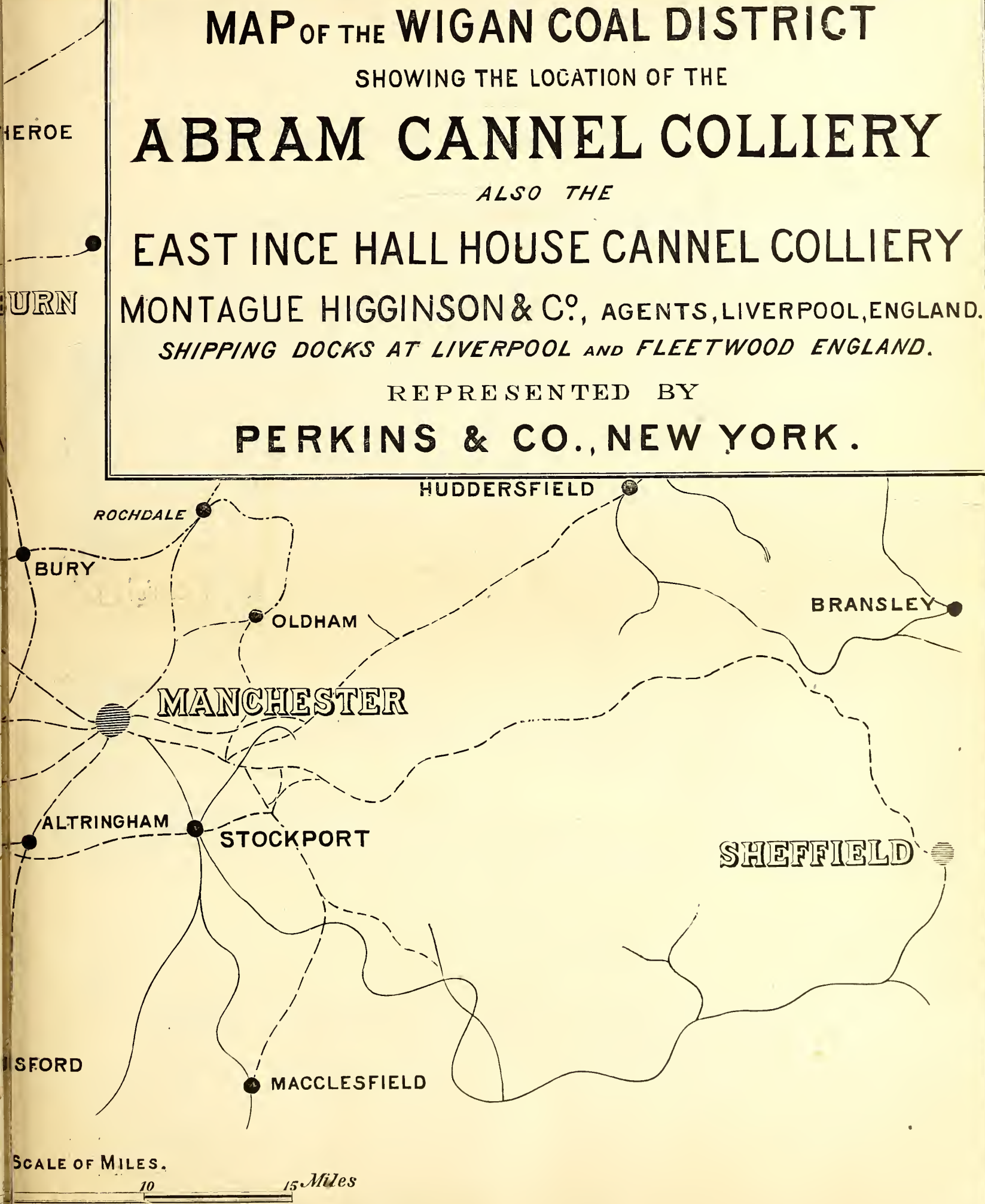

“VICE VERSA” RANGES,

With Sheldon's Patent Interchangeable Oven and Damper Gas Cock, which will burn Gas of any Candle Power and Density, at any Pressure.

FOR COAL OR GAS.

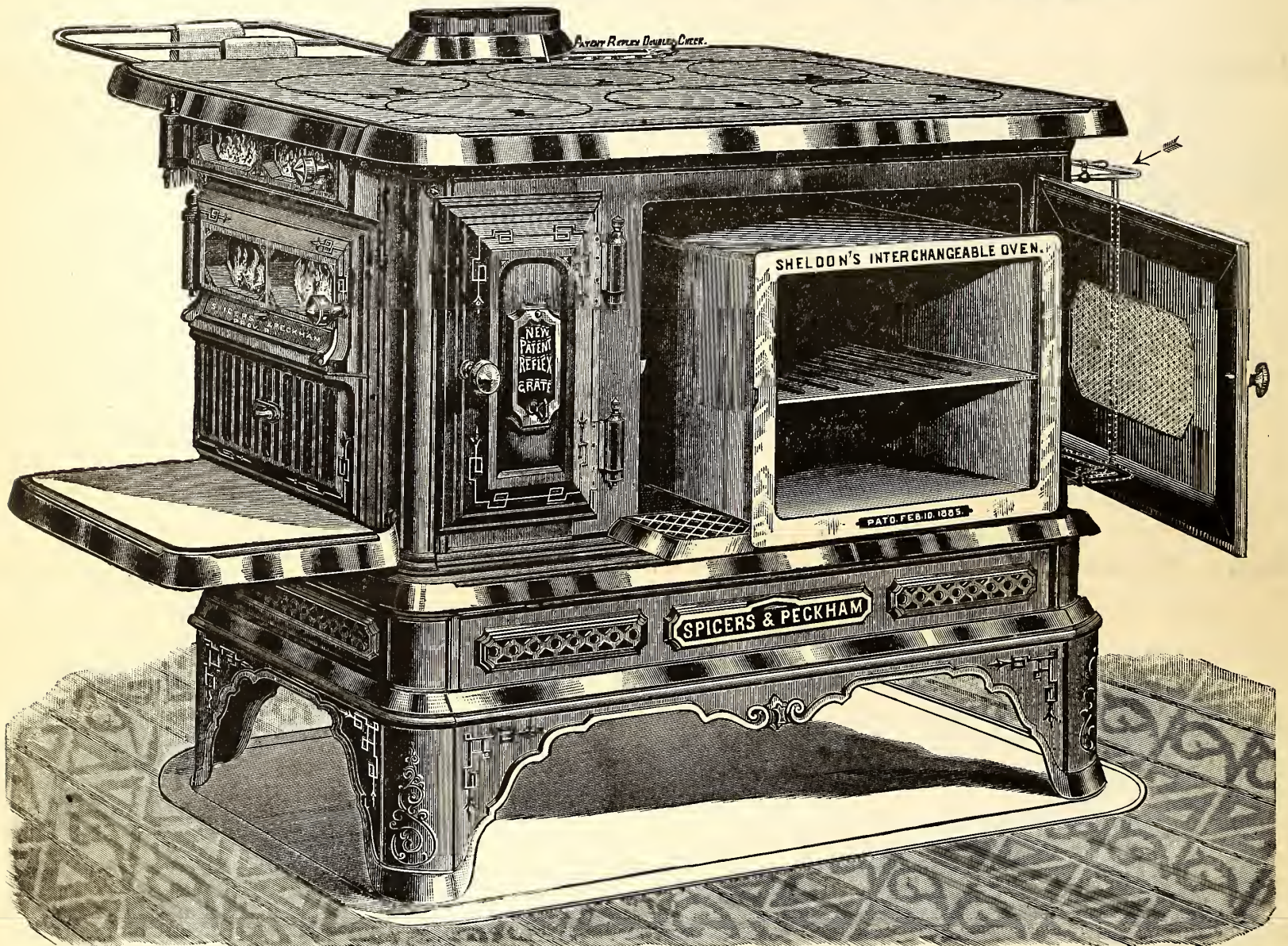

A NEW DEPARTURE.

Introducing a removable Oven in all Coal-Burning Ranges, in combination with suitably arranged gas burners and dampers, whereby they are converted into complete Gas-Burning Ranges, with comparatively slight expense, and possessing all their culinary advantages. The “Vice Versa” Range can be had of the following-named Manufacturers, who have adopted our Oven Attachment. We expect to have it on all first-class Ranges this Season.

SPICER & PECKHAM, Providence, R. I.
BARSTOW STOVE CO., Providence, R. I.

SMITH & ANTHONY STOVE CO., Boston, Mass.
O. G. THOMAS, Taunton, Mass.

MR. H. H. SHELDON, Pawtucket, R. I.—

PROVIDENCE, R. I., Jan. 31, 1885.

Dear Sir:—We take pleasure in congratulating you upon the success of the exhibition of the Model “Vice Versa” Ranges, using either coal or gas with equally good results. It certainly demonstrates the practical utility of your valuable invention, and must effect a revolution in the gas stove trade. No one will buy an expensive and cumbersome gas stove, for summer use, when by applying your interchangeable Oven Attachment he can secure all its convenience in his family coal range. Your invention appears to have successfully solved all the difficulties, and must prove of great value to stove manufacturers. We have already made the necessary changes in our famous Model Ranges, as per arrangements made with you, and expect to have them in the market in a few weeks.

Very respectfully yours,

SPICER & PECKHAM.

SHELDON MANUFACTURING CO.,

No. 18 West Twenty-third Street, New York City.

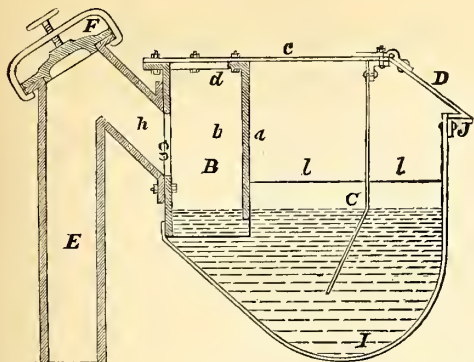

Boardman Hydraulic Main,
Patented October 7, 1884.

For description, see AM. GAS LIGHT JOURNAL of Feb. 2, 1884.
For terms, apply to

A. E. BOARDMAN, Macon, Ga.

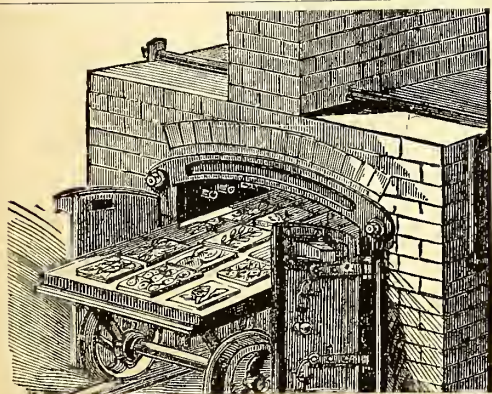

Glass-Staining Gas Kiln.

BAKERS' & CONFECTIONERS' OVENS (PAT.)

Thompson Gas Kiln & Oven Co.

59 Carmine St., N. Y.
Send for Circular by mail.

"ECLIPSE" HAND PIPE-CUTTING MACHINE.
No. 1.

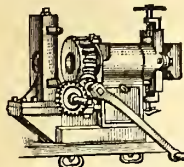

Powerful, inexpensive, simple in construction; can be attached to any bench or plank in a few moments. Cuts and Screws Pipes 1/4 to 2 in. Address for Prices, PANCOAST & MAULE, Philadelphia, Pa. [Mention this Paper.]

WM. FARMER, ENGINEER,
32 Park Place, Room 36, New York.

THE CHEMIST'S ASSISTANT; OR, KINDERGARTEN SYSTEM OF CHEMISTRY.

A system by which the elements and their valences are represented by illustrations and solid bodies. BOX AND PAMPHLET COMPLETE, \$2.50.

THE GLOBE STREET LAMP.



MINER'S PATENT STREET LAMPS.

Are adapted for use of Streets, Parks, Depots, Ferries, & Private Grounds.

WITH POSTS OR BRACKETS.

Jacob G. Miner,
MORRISANIA, N. Y. CITY.

C. BARCALOW, PREST.

J. V. BARCALOW, SEC. & TREAS.

BARTLETT Street Lamp Mfg. Co.

MANUFACTURERS OF

Bartlett's Patent

GLOBE LAMPS.

FOR

Streets, Parks, Railroad Stations, Public Buildings, Etc.

LAMP POSTS A SPECIALTY.

Office and Salesroom,

No. 35 Howard Street, N. Y. City.

Gas Companies and others intending to erect lamps and posts will do well to communicate with us.

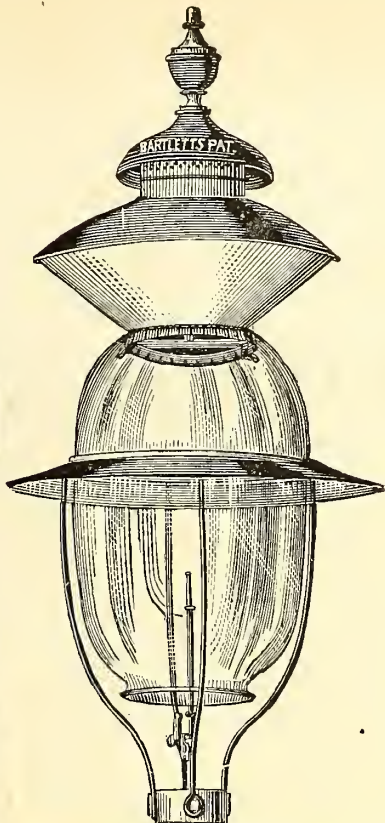

F. M. ROOTS.

S. C. ROOTS

D. T. ROOTS.

P. H. & F. M. ROOTS,
PATENTEES AND MANUFACTURERS OF

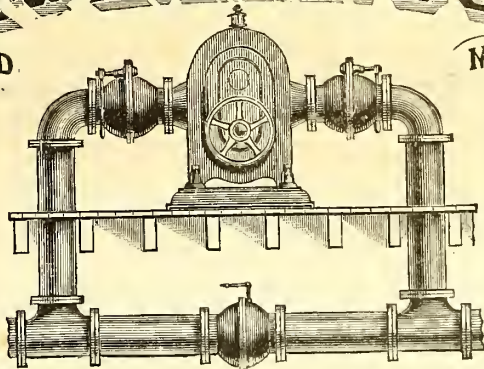
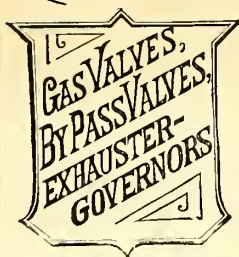

IMPROVED GAS EXHAUSTER,

WITH ENGINE ON SAME BED PLATE, OR WITHOUT.

BYE-PASSES, GAS VALVES, GOVERNORS, ELBOWS, PIPE-FITTINGS, Etc., FURNISHED TO ORDER,

P. H. & F. M. ROOTS, Patentees & Manufacturers, CONNERSVILLE, IND.

S. S. TOWNSEND, General Agent, 22 Cortland St. and 9 Dey St., N. Y.

JAS. BEGGS & CO., Selling Agents, 9 Dey St., N. Y.

COOKE & CO., Selling Agents, 22 Cortland St., N. Y.

✽ SEND FOR ILLUSTRATED CATALOGUE AND PRICE LIST. ✽

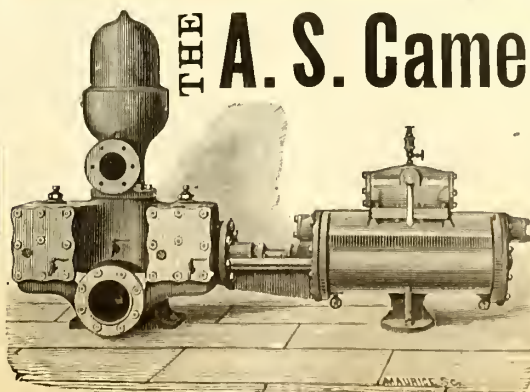

THE A. S. Cameron Steam Pump,

THE STANDARD OF EXCELLENCE.

Upward of 30,000 in Use.

BEST GAS WORKS PUMP

Ever Introduced.

Adapted to Every Possible Duty.

A. S. Cameron Steam Pump Works,

Foot East 23d St., N. Y.

Chas. F. Dieterich's Regenerator Furnace.

CAN BE ADAPTED TO ANY BENCH WITHOUT DISTURBING THE ORDINARY SETTINGS.

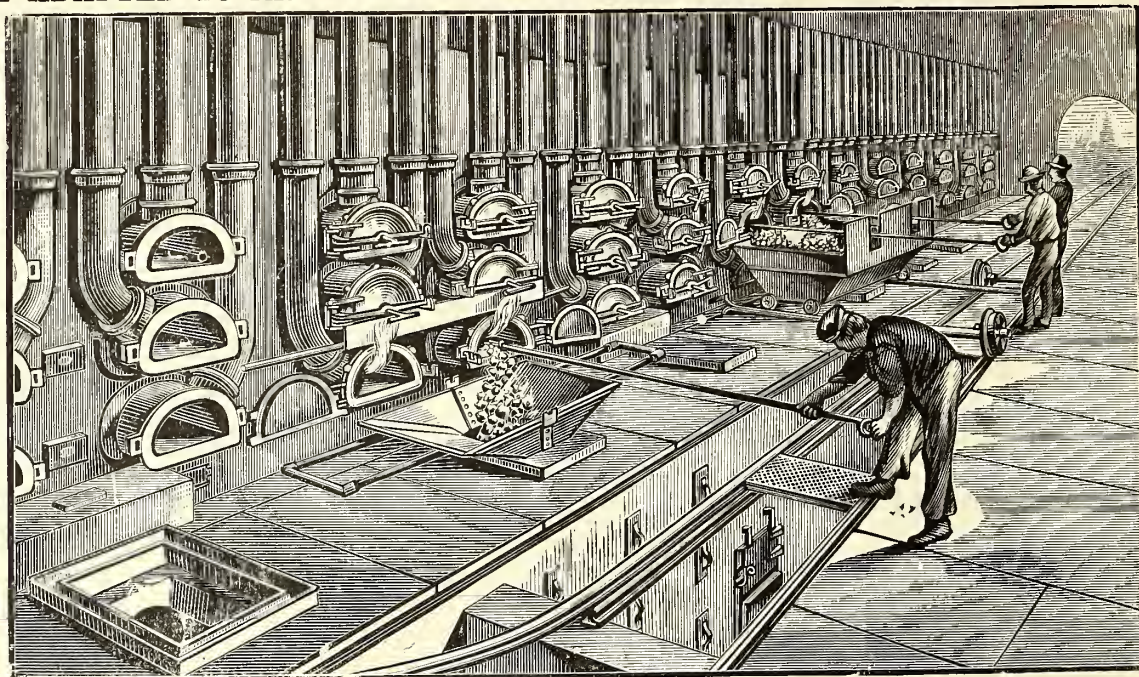

These Furnaces have been in operation at the works of the People's Gas Company, Baltimore, since June, 1878. A bench of sixes, with retorts 20 in. by 12 in. by 8 ft. 6 in. will burn off 1,350 pounds of coal in 3 hours. Twenty-five per cent. of the coke is sufficient to thoroughly burn off the charges.

We refer by permission to the following Companies who are using these Furnaces:

A. B. SLATER, Providence Gas Co. S. G. STINESS, Pawtucket Gas Co. JAS. H. ARMINGTON, Brooklyn Gas Lt. Co.
State, city, and factory rights granted on reasonable terms. For full particulars apply to

CHAS. F. DIETERICH, Engineer P. O. Box 512. BALTIMORE. MD.

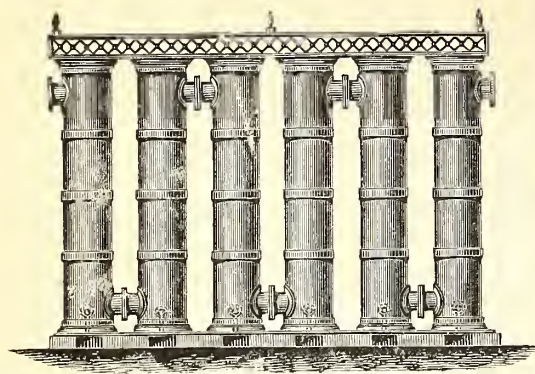

W. E. Tanner, Pres., W. R. Trigg, V.-Pres., A. Delaney, Supt.

Tanner & Delaney Engine Co.
RICHMOND, VA.

Gas Apparatus,

INCLUDING

Condensers of various styles, Scrubbers, Holders, Purifiers, Castings for Retort Houses, Etc.

ALSO STEAM ENGINES AND BOILERS.
Plans, Specifications and Estimates Furnished.

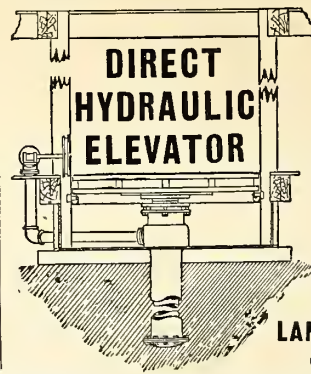

With Iron or Wood Platform.

Largely used by Leading Gas Co.s for Coal and Coke Lifts.

Adapted for use with city service, or special pumping and accumulator system. For prices address the

LANE & BODLEY CO.,
Cincinnati, O.

R. D. WOOD & CO.,

400 Chestnut Street, Phila., Pa.

Cast Iron Gas & Water Pipe, Water Machinery & Gas Apparatus

Cast Iron Pipe, Fire Hydrants, Eddy Valves, Lamp Posts, Large Loam Castings, Flanged Pipe, Sugar House Work, Iron Roofs and Floors, Wrought & Cast Iron Tanks, Turbine Water Wheels and Pumps.

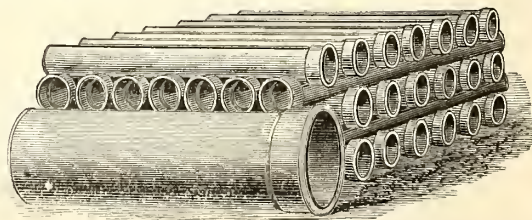

Casholders, Lime Trays, Center Valves, Purifiers, Bench Work, Exhausters, Condensers, Governors, Scrubbers, Gas Valves Station Meters, Cast Iron Pipe Fittings.

Manufacturers of Heavy Castings and Machinery of Every Description.

ENGINEERS & CONTRACTORS FOR THE ERECTION OF GAS WORKS, & ALL MACHINERY CONNECTED THEREWITH

Estimates and specifications furnished for erection of new works or the extension or alteration of old ones.

Foundries and Works, - - Millville, Florence, and Camden, N. J.

THE AMERICAN METER COMPANY,

MANUFACTORIES,

512 West Twenty-second Street, N. Y. Arch and Twenty-second Street, Phila.
Nos. 244 & 246 North Wells Street, Chicago, Ill.

AGENCIES,

No. 177 Elm Street, Cincinnati, Ohio. Nos. 122 & 124 Sutter Street, San Francisco, Cal.
No. 810 North Second Street, St. Louis, Mo.

ALL SIZES
CONSTANTLY
IN STOCK.

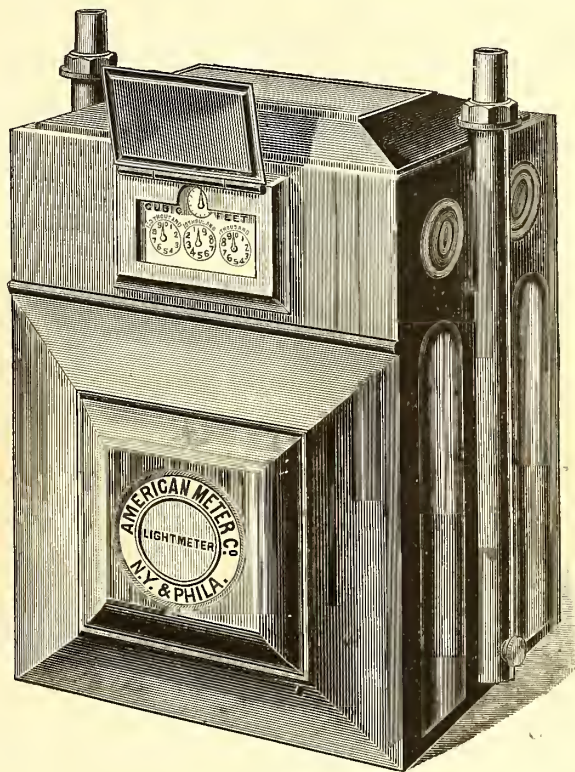

PRICE LISTS
ON
APPLICATION.

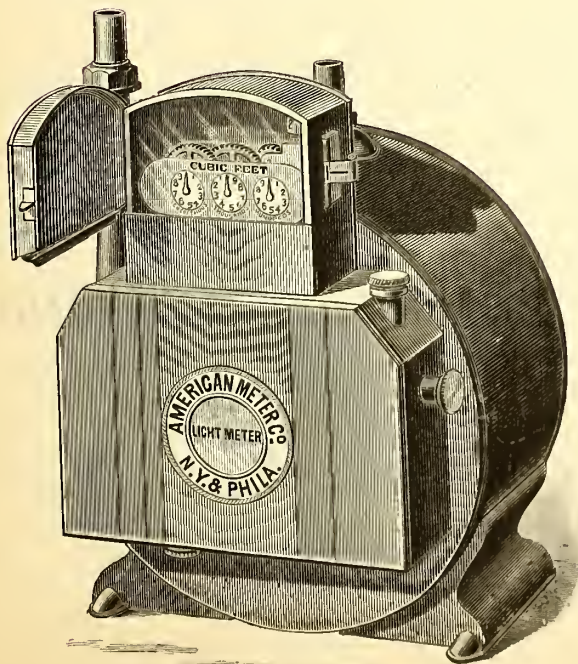

Mfr's of STANDARD WET AND DRY GAS METERS.

J. H. GAUTIER & CO..

CORNER OF
GREENE AND ESSEX STREETS,
JERSEY CITY, N. J.

MANUFACTURERS OF

Clay Gas Retorts,
Gas House Tiles,
Fire Bricks, Etc. Etc.

Ground Clay, Fire Brick and
Fire Sand in Barrels,

J. H. GAUTIER. T. B. GAUTIER.
C. E. GREGORY. C. E. GAUTIER.

BROOKLYN

Clay Retort & Fire Brick Works,
(EDWARD D. WHITE & CO.)

Manufacturers of Clay Retorts, Fire Brick,
Gas House and other Tile.
VAN DYKE, ELIZABETH, RICHARDS & PARTITION STS.
Office, 88 Van Dyke St., Brooklyn, N. Y.

LACLEDE FIRE BRICK MFG. CO.,

MANUFACTURERS OF

Fire Brick, Gas Retorts,

AND

ST. LOUIS STANDARD SEWER PIPE.

Blast Furnace and Cupola Linings, every description of Fire
Clay Material, Fire Clay Flue Linings, Chimney Tops
Dry Milled and Crude Fire Clays, etc.

OFFICE AND DEPOT

901, 903, and 905 Pine Street,
ST. LOUIS, MO.

ESTABLISHED IN 1845.

B. KREISCHER & SONS,

OFFICE FOOT OF HOUSTON ST., E.R., N.Y.

Gas Retorts,

TILES, FIRE BRICK.

AND EVERYTHING IN THE FIRE CLAY LINE.

MANHATTAN

FIRE BRICK & ENAMELLED CLAY

RETORT WORKS.

ADAM WEBER.

CLAY GAS RETORTS
AND RETORT SETTINGS,
FIRE BRICKS, TILES, ETC.,

Office and Works, 15th Street and Avenue C., N. Y.

CHICAGO

Retort & Fire Brick Works,

OFFICE AND FACTORY,

Clark, Forty-Fifth, and La Salle Streets,

CHICAGO, ILL.

GEORGE C. HICKS, PRES. PAUL P. AUSTIN, SEC. & TREAS.

STANDARD

Clay Retorts and Settings.

BLOCKS & TILES

of every Shape and Size to Order.

Standard Fire Bricks.

JAMES GARDNER, JR.

Works,
LOCKPORT STATION, PA.

—ESTABLISHED 1864.—

WILLIAM GARDNER & SON,

Successor to GARDNER BROTHERS.

WILLIAM GARDNER.

Office, COAL EXCHANGE,
PITTSBURGH, PA., P. O. Box 373.

Fire Clay Goods for Gas Works.

C. H. SPRAGUE, No. 70 KILBY STREET, BOSTON, MASS., Agent for the New England States.

OFFICE, 418 to 422 East 23d St., New York.

ESTABLISHED 1856.

WORKS, PERTH AMBOY, NEW JERSEY.

HENRY MAURER,

Excelsior Fire Brick & Clay Retort Works

CLAY GAS RETORTS, BENCH SETTINGS, FIRE BRICK, TILES, ETC.

STANDARD GAS RETORT AND FIRE BRICK COMPANY,

J. ANDERSON, PRES. & MANG'R.

OF IRONTON, OHIO.

C. PETERS, SECRETARY.

Clay Gas Retorts, Fire Brick, and Fire Clay Goods of Every Description.

Plans of Livesey-Somerville, McIlhenny, and other Furnaces, and Competent Workmen Supplied.



CINCINNATI

Gas Retort & Fire Brick Co.,

(ESTABLISHED 1872.)

CINCINNATI, OHIO.

Manufacturers of Gas Retorts, Retort Settings, Fire Brick, Tiles, Etc.

OAKHILL

GAS RETORT & FIRE BRICK

COMPANY.

PARKER, RUSSELL & CO.

City Office, 711 Pine Street,

ST. LOUIS, MO.

Our immense establishment is now employed almost entirely in
the manufacture of

MATERIALS FOR GAS COMPANIES.

We have studied and perfected three important points. Our retorts are made to stand changes of temperature, the strongest heats of the furnace, and the abrasion of feeding and emptying. Our customers are in almost every State of the Union, to all of whom we refer.

THOS. SMITH, Prest. AUGUST LAMBLA, Vice-Prest. & Sup.

BALTIMORE

RETORT & FIRE BRICK CO.

MANUFACTORY AT

LOCUST POINT, BALTIMORE, MD.

Connection with the City by Telephone.

Clay Retorts, Blocks & Tiles,

FIRE BRICK, FIRE CLAY,
AND FIRE CEMENT.

Red and Buff Ornamental Tiles and Chimney
Tops. Drain and Sewer Pipe (from
2 to 30 inches). Baker Oven Tiles
12x12x2 and 10x10x2.

WALDO BROS., 88 WATER ST., BOSTON, MASS.

Sole Agents for New England States

Siemens's Regenerative Gas Burners, For Lighting and Ventilating.

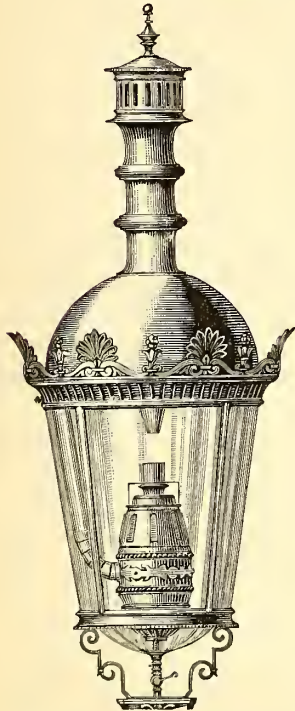

THE CHEAPEST, PUREST, AND MOST BRILLIANT OF ALL GAS LIGHTS.

Superior to the Electric Light in Economy, Beauty, & Steadiness.

SPECIALLY ADAPTED FOR LIGHTING HALLS, FACTORIES, OPEN SPACES, ETC.

Numerous Tests made by various Gas Companies in the United States show an Efficiency of Ten Candle Power per Cubic Foot of Gas.

General Agents:

SIEMENS LIGHTING CO., 347 West Main St., Louisville, Ky.
 MEYER, MARSHALL & CO., 528 California St., San Francisco.
 DENNEHY, WOLF & O'BRIEN, 85 & 87 Dearborn St. Chicago, Ill.
 WILCOX & McCEARY, - No. 11 Bissel Block, Pittsburgh, Pa.
 T. T. RAMSDALL & CO., - 20 Swan Street, Buffalo, N. Y.
 SIEMENS GAS ILLUMINATING CO.,
 Room 6, No. 157 Broadway, New York City.
 W. D. COLT, - - - - 1420 F Street, Washington, D. C.
 JOHN KIEFER, - - - 344 Lawrence, Street, Denver, Col.

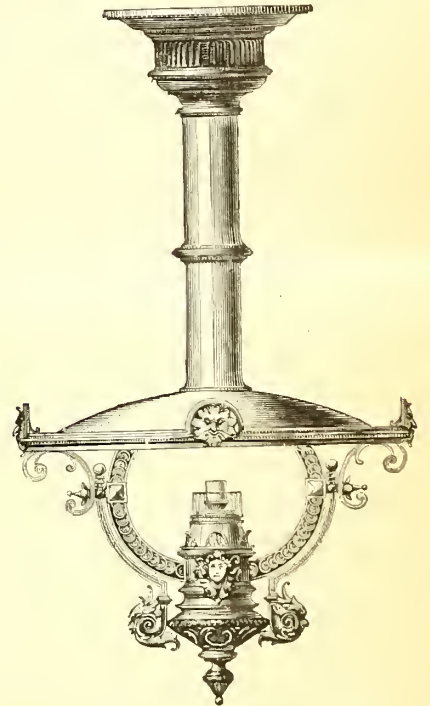

THE SIEMENS REGENERATIVE GAS LAMP COMPANY,

SOLE MAKERS FOR THE UNITED STATES,

N. E. Cor. 21st. St. and Washington Av., Philadelphia. Pa.

THE "STANDARD" WASHER-SCRUBBER,

KIRKHAM, HULETT & CHANDLER'S PATENT.

Total Capacity per 24 Hours of "Standard" Washers Ordered During the Following Years.

1877.....	4,000,000	cubic feet.
1878.....	4,750,000	"
1879.....	24,545,000	"
1880.....	42,967,500	"
1881.....	36,462,500	"
1882.....	39,300,000	"
1883.....	57,735,000	"
1884.....	28,177,500	"
Total.....	235,937,500	cubic feet.

Total Number and Capacity per 24 Hours of "Standard" Washers Erected and in Course of Erection in the Several Countries

	Number.	Cubic Feet per Day.
Great Britain..	151	157,070,000
Western Hemisphere.....	38	39,337,500
Australia.....	18	12,150,000
New Zealand.....	2	650,000
France.....	6	4,550,000
Belgium.....	8	5,420,000
Germany.....	16	8,200,000
Holland.....	4	4,160,000
Denmark.....	1	150,000
Russia.....	2	3,500,000
Spain.....	1	350,000
India.....	1	400,000
Total.....	248	235,937,500

**THE CONTINUED POPULARITY
Of these Machines**

Will be recognized from the following extracts from letters from representatives of some of the companies having them in use:

TOLEDO GAS LIGHT AND COKE CO., }
 TOLEDO, OHIO, NOV. 25, 1884. }

GEO. SHEPARD PAGE, Esq.:

Dear Sir—Replying to your kind favor of 21st inst., I would say that the "Standard" Washer-Scrubber is doing work that is entirely satisfactory to us. During the summer I had 12-oz. liquor; but since cool weather commenced I have been having from 18 to 23-oz. liquor, just as we would elect. There is not a trace of ammonia passing the Scrubber that a test of reddened litmus or yellow turmeric paper would indicate. The machine, in my opinion, is all that could be desired as a means for removing all the ammonia from the gas.

Very respectfully,
 C. R. FABEN, Jr.,

Superintendent.

"Standard" Washers Ordered During the Current Year.

	Cu. Ft. per Day
Auneberg Gas Co.....	200,000
Bombay Gas Co.....	400,000
Brussels Co.....	1,250,000
Chemnitz Gas Co.....	1,000,000
CITIZENS GAS CO., BUFFALO.....	750,000
Coke Works in Zabre, Ober-Schlesien.....	1,500,000
Cokerel der Friedensmitte, Upper Silesia.....	500,000
Dunfries Corporation.....	250,000
Dunedin Gas Co., New Zealand.....	400,000
Klug's Lynn Gas Co.....	300,000
Leiden, Holland.....	600,000
Lincoln Gas Co.....	400,000
Liverpool Gas Co.....	2,000,000
" ".....	3,000,000
LOUISVILLE GAS CO.....	1,500,000
Numea Gas Co.....	400,000
PITTSBURGH GAS CO.....	1,500,000
PORTLAND GAS CO., OREGON.....	562,500
SAN FRANCISCO GAS CO.....	4,000,000
Sheepbridge.....	10,000
ST. LOUIS GAS CO.....	2,000,000
Sydney Gas Co.....	2,500,000
WASHINGTON, D. C. GAS CO.....	2,000,000
Whitechurch Gas Co.....	175,000
Total.....	26,177,500

GEO. SHEPARD PAGE, No. 69 WALL STREET, NEW YORK,

SOLE AGENT FOR THE WESTERN HEMISPHERE.

A. H. M'NEAL,

BURLINGTON, N. J.

Flange-Pipes

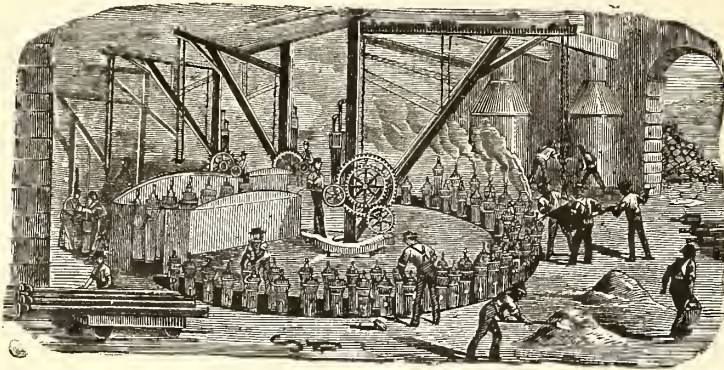

General Foundry Work.

CAST IRON PIPES FOR WATER AND GAS.

JAMES S. MOORE, Pres.
BENJAMIN CHEW, Treas.

JAS. P. MICHELLON, Sec.
WM. SEXTON, Supt.

GLOUCESTER IRON WORKS, GLOUCESTER CITY N. J.

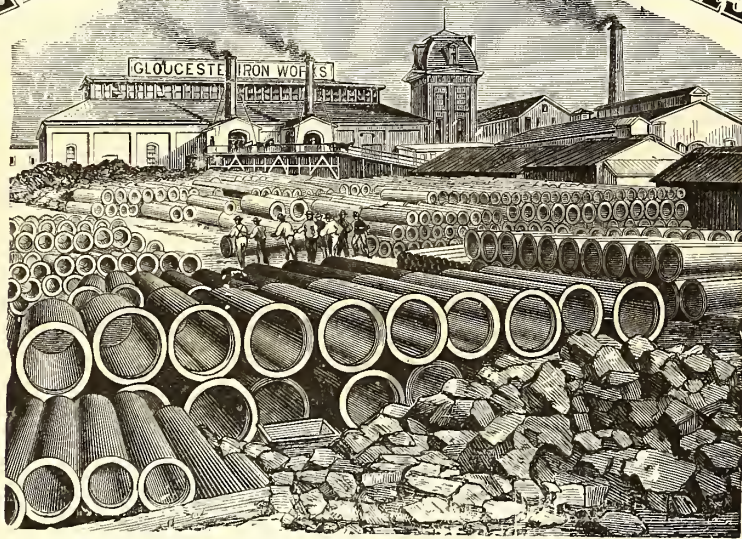

Cast Iron Gas & Water Pipes, Stop Valves, Fire Hydrants, Gasholders. &c.
Office No. 6 North Seventh Street, Philadelphia.

ESTABLISHED 1856.

WARREN FOUNDRY AND MACHINE CO.,

WORKS AT PHILLIPSBURGH, N. J.
NEW YORK OFFICE, 162 BROADWAY.

Cast Iron Water and Gas Pipe

FROM TWO TO FORTY-EIGHT INCHES DIAMETER.
ALSO ALL SIZES OF

FLANGE PIPE for Sugar House and Mine Work.
Branches, Bends, Retorts, Etc., Etc.

436-1

MATTHEW ADDY, President.

W. L. DAVIS, Selling Agent.

GEO. P. WILSHIRE, Sec. & Treas.

Cincinnati and Newport Iron and Pipe Company,

NEWPORT, KY.

Lamp Posts
AND
BENCH CASTINGS

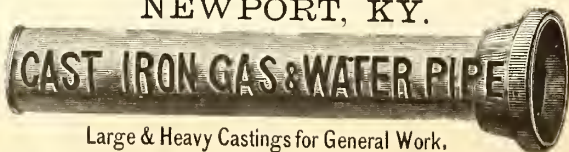

Branch
AND
SPECIAL CASTINGS

A Specialty.

Large & Heavy Castings for General Work.

FOR GAS & WATER CO'S.

Manufacture Pipe from 2 to 48 inches. All work guaranteed first quality.

Mellert Foundry and Machine Co. Limited. Established 1848.

MANUFACTURERS OF



Specials—Flange Pipe, Valves and Hydrants,
Lamp Posts, Retorts, etc.
Machinery and castings for Furnaces, Rolling Mills, Grist and
Saw Mills, Mining Pumps, Hoists, etc.

GENERAL OFFICE, - - - READING, PA.

To Gas Companies.

We make to order **CAP BURNERS** to burn any amount
under a stated pressure. Send for samples.

Also, **SERVICE CLEANERS, DRIP PUMPS,** and **STREET
MAIN PROVING APPARATUS.**

C. A. GEFROER,
248 N. 5th Street, Phila., Pa.

MORRIS, TASKER & CO., Limited,

Builders of Gas Works,
PHILADELPHIA, PA.

LUDLOW VALVE MFG. CO



OFFICE AND WORKS,

938 to 954 River Street and 67 to 83 Vail Av.,

TROY, N. Y.

Hydraulic Main Dip Regulators, also
Check Valves, Foot Valves, Yard-
wash and Fire Hydrants.
Send for Circulars.

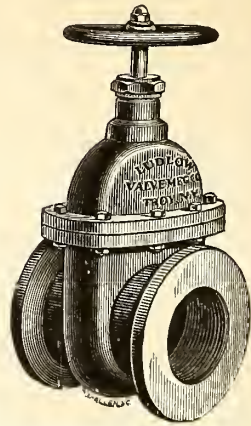

Valves.—Double and Single Gate, ½ in. to
48 in., outside and inside Screws. Indica-
tor, etc., for Gas, Water, Steam, and Oil.
and for Circulars.

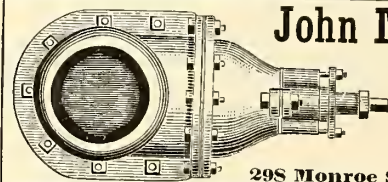

John McLean

Man'facturer of

**GAS
VALVES.**

298 Monroe Street, N. Y.

WM. HENRY WHITE,

Consulting & Constructing
Gas Engineer & Contractor.

ESTIMATES, PLANS, AND SPECIFICATIONS FURNISHED
FOR NEW WORKS OR EXTENSIONS OF
EXISTING WORKS.

32 Pine St., New York City.

Correspondence solicited.

JAMES R. FLOYD,
 (SUCCESSOR TO HERRING & FLOYD)
Oregon Iron Works,
 531 to 543 West 20th St., N. Y.
Practical Builders of Gas Works,
 MANUFACTURERS OF
ALL KINDS OF CASTINGS
 AND
APPARATUS FOR GAS-WORKS.

BENCH CASTINGS
 from benches of one to six Retorts each.
WASHERS: MULTITUBULAR AND
AIR CONDENSERS; CONDENSERS: SCRUBBERS
 (wet and dry), and
EXHAUSTERS
 for relieving Retorts from pressure.
BENDS and BRANCHES
 of all sizes and description.
FLOYD'S PATENT
MALLEABLE RETORT LID.
PATENT
SELF-SEALING RETORT LIDS.
FARMER'S
PATENT BYE-PASS DIP-PIPE.
SABBATON'S PATENT
FURNACE DOOR AND FRAME.
BUTLER'S
COKE SCREENING SHOVELS.

GAS GOVERNORS,
 and everything connected with well regulated Gas Works at low price, and in complete order.

SELLER'S CEMENT
 for stopping leaks in Retorts.
N. B.—STOP VALVES from three to thirty inches—at very low prices.
 Plans, Specifications, and Estimates furnished.

KERR MURRAY MFG. CO.,
 MANUFACTURERS OF
Single Lift and Telescopic
GASHOLDERS.

Built, 1884:

Altoona, Pa	Capacity, 160,000 cubic feet.
Pittsburgh, Pa.....	250,000 "
" ".....	230,000 "
Bellaire, Ohio.....	50,000 "
Youngstown, Ohio.....	60,000 "
Canton, ".....	60,000 "
Akron, ".....	80,000 "
Xenia, ".....	10,000 "
Adrian, Mich.....	65,000 "
Ypsilanti, Mich.....	25,000 "
Muskegon, ".....	70,000 "
South Bend, Ind.....	70,000 "
Anderson, ".....	20,000 "
Plainfield, ".....	10,000 "
Springfield, Illinois.....	100,000 "
Evanston, ".....	50,000 "
Freeport, ".....	35,000 "
Elgin, ".....	60,000 "
Sheboygan Wis.....	20,000 "
Key West Fla.....	10,000 "

Plans and estimates furnished for the erection of new and the rebuilding of old works. Address

Kerr Murray Mfg. Co.,
FORT WAYNE, IND.

CONTINENTAL WORKS.

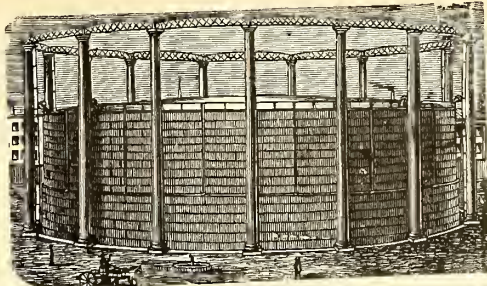

GASHOLDERS OF ANY MAGNITUDE.

T. F. ROWLAND, Proprietor,
GREENPOINT, BROOKLYN, N. Y.
 ENGINEER AND MANUFACTURER OF
GAS-HOLDERS.
CONDENSERS, SCRUBBERS, VALVES,
PURIFIERS, RETORTS, and HY-
DRAULIC MAINS,
 and all other articles connected with the Manufacture
 Distribution of Gas. Plans and Specifications prepared
 and Proposals given for the necessary Plant for Lighting
 Cities, Towns, Mansions, and Manfactories.

H. RANSHAW, Prest. & Mangr. Wm. STACEY, Vice-Pres. T. H. BIRCH, Asst. Mangr. R. J. TARVIN, Sec. & Treas.

STACEY MFG. CO.,

MANUFACTURERS OF

Single and Telescopic Gasholders,

IRON ROOFS, BRIDGES, LAMP POSTS,

Water and Oil Tanks, Coal Elevator Cars,
COKE CRUSHERS, BENCH CASTINGS,

And all kinds of Wrought and Cast Iron Work used in the erection of Coal and Oil Gas Works.
 Rolling Mill Machinery and Heavy Castings a Specialty.

Foundry: 33, 35, 37 & 39 Mill Street. **Wrought Iron Works:** 16, 18, 20, 22, 24 & 26 Ramsey Street.

Cincinnati, Ohio.

BARTLETT, HAYWARD & CO.,

BALTIMORE, MD.

Works, Pratt & Scott.

Office, 24 Light.

PURIFIERS.
 Roofs.
 Bench Castings.

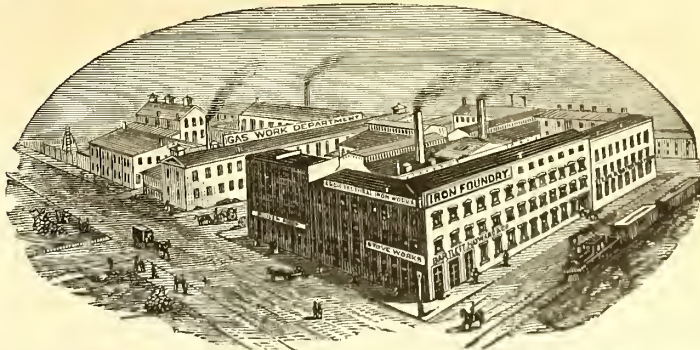

CONDENSERS.
 BOILERS.
SCRUBBERS.

GASHOLDERS.

CONSTRUCTING ENGINEERS AND BUILDERS OF GAS WORKS.

1842. DEILY & FOWLER, 1884.

Laurel Iron Works.

Address, No. 39 Laurel Street, Philadelphia, Pa.

MANUFACTURERS OF

GASHOLDERS,

Single or Telescopic, with Cast or Wrought Iron Guide Frames.

Holders Built Since 1880:

Mount Joy, Pa.	West Point, N. Y.	Galveston, Texas (2d.)	Kalamazoo, Mich. (3d.)	Newport, R. I.
Rockaway B'ch, N.Y. (2)	Fitchburg, Mass.	Marlboro, Mass.	Glen Island, N. Y.	Portland, Oregon.
Zanesville, O. (2d.)	New London, Conn.	Denver, Col.	Warren, Ohio.	Allegheny, Pa. (2d.)
Lancaster, O.	Derby, Conn.	Chicago, Ill. (West Side).	Bath, N. Y.	Atlanta, Ga. (2d.)
Blackwell's Island N. Y.	Bridgeport, Conn.	Pittsburgh, Pa. (S. Side).	Lynn, Mass.	N. Y. City (Central Gas Co)
Waltham, Mass., (1st.)	Allegheeny, Pa. (1st.)	Paytucket, R. I.	New Bedford, Mass.	Lynchburg, Va. (2d.)
Dorchester, Mass.	St. Hyacinth, Can.	Brookline, Mass.	Waterbury, Conn.	Saylesville, R. I.
Wheeling, West Va.	Norwalk, O.	Sherbrooke, Can.	Deseronto, Can.	Rondout, N. Y.
Lansing, Mich.	Brattleboro, Vt.	Burlington, N. J. (2d.)	Hoosic Falls, N. Y. (2d.)	Atlantic City, N. J.
Flint, Mich.	Waltham, Mass (2d.)	Baltimore, Md.	Bethlehem, Pa.	Augusta, Ga.
Galveston, Texas (1st.)	West Chester, Pa.	Bay City, Mich.	Atlanta, Ga. (1st.)	Waltham, Mass. (3d.)
Milton, Pa.	Baltimore, Md.	Erie, Pa.	Savannah, Ga.	
Scranton, Pa.	Holidaysburg, Pa.	Jackson, Mich.	Montgomery, Ala.	

GAS COALS.

GAS COALS.

GAS COALS.

JAMES D. PERKINS.

PERKINS & CO.,

F. SEAVERNS.

General Sales Agents.

THE YOUGHIOGHENY RIVER COAL COMPANY,

Organized August 1, 1882.

MINERS AND SHIPPERS OF THE WELL-KNOWN

Ocean Mine Youghioghenny Gas Coal.

The Coal from the Ocean Mine (recently operated by Messrs. W. L. Scott & Co., of Erie, Pa.,) is now used by all the leading Gas Companies in the United States from Maine to Texas, and is recognized as *the only reliable Youghioghenny Gas Coal.* (See Map on p. 87 of this Journal, Feb. 16, 1885.)

Messrs. W. L. Scott & Co. and W. L. Scott, Esq., still retain their interest in the new Company, and the same general policy which has characterized the management of the mine under these gentlemen will be continued by the new Company. With largely increased facilities and *unlimited supply of Coal*, any demand made upon the Colliery will meet with prompt fulfillment.

THE UNDERSIGNED CAN SUPPLY THE FOLLOWING SUPERIOR GRADES OF

GAS CANNELS:

Abram Cannel, from the Abram Colliery, Wigan, England, (See Map on pp. 154-5 of this Journal, Mar. 16, 1885.)

Plesio-Boghead Cannel, from near the old Boghead Colliery, Scotland. (See Map on pp. 126-7 of this Journal, Mar. 2, 1885.)

Llong Cannel, from Wales. The sale of this Cannel for the United States has been placed in our hands, and we are now prepared to execute orders for it. The product of this Colliery is quite limited, and it will be necessary for us to forward orders early to ensure delivery the coming season.

P. O. Box 3695,
New York.

PERKINS & CO., 228 and 229 N. Y. Produce Exchange BEAVER STREET ENTRANCE.

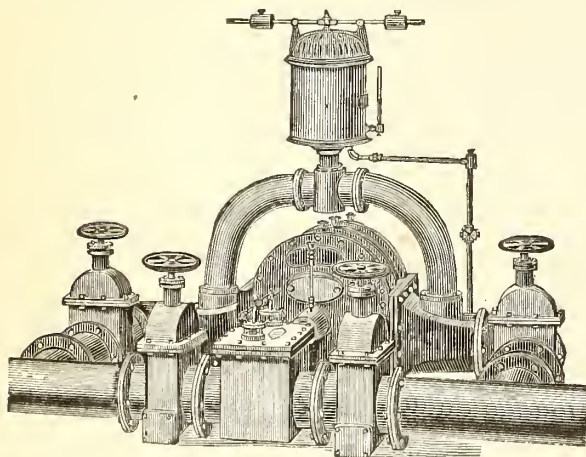
**SMITH & SAYRE MFG. COMPANY,**

G. G. PORTER, Prest.

245 Broadway, N. Y. CHAS. W. ISBELL, Sec'y.

Machinery & Apparatus for Gas Works

Drawings, Plans, and Estimates Furnished for the Improvement, Extension, or Alteration of Gas Works or for the Construction of New Works.

Mackenzie's Patent Rotary and Steam Jet Gas Exhausters, Governors, Compensators, Condensers, Washers, Scrubbers. Isbell's Patent Automatic Street Pressure Governor, Gas and Water Valves, Hydraulic Main Dip Regulator, Bench Castings, etc. Purifying Boxes and "Standard" Scrubbers. Isbell's Patent Self-Sealing Retort Doors.

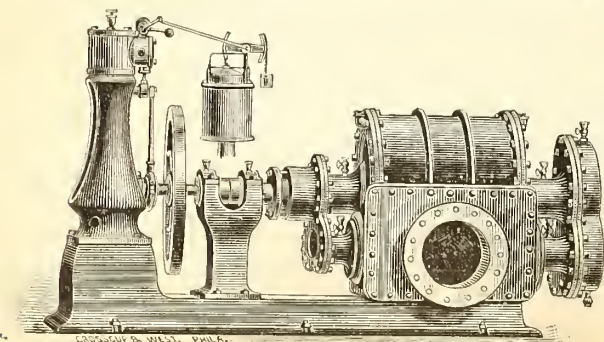
**The Wilbraham Gas Exhauster,**
"BAKER SYSTEM,"

WITH ENGINE ATTACHED, ON SAME BED PLATE OR WITHOUT.
Best, Cheapest and Most Durable Exhauster known.

WILBRAHAM BROS.,

No. 2320 Frankford Avenue, Philadelphia, Pa.

GAS COALS.

GAS COALS.

GAS COALS,

Newburgh Orrel Coal Co.,

MINERS AND SHIPPERS OF

Newburgh Orrel, Tyrconnell and Palatine Gas Coals.

ALSO SHIPPERS OF FOUNDRY COKE.

Mines Situated at

Newburgh, Flemington & Fairmont, W. Va.

HOME OFFICE,

25 S. Gay St., Baltimore.

CHARLES MACKALL,
MANAGER.

CHAS. W. HAYS, Agent in New York,

Room 92, WASHINGTON BUILDING, No. 1 Broadway.

Shipping wharves at Locust Point. References furnished when required. Special attention given to chartering vessels.

THE DESPARD COAL COMPANY

OFFER THEIR SUPERIOR

DESPARD COAL

To Gas Light Companies and Manufacturers of Fire Clay Goods Throughout the Country.

ROUSSEL & HICKS, } AGENTS. { BANGS & HORTON,
71 Broadway, N. Y. } 16 Kilby St., Boston.

Mines in Harrison Co., West Va. Wharves, Locust Point, Balt.

Company's Office, 15 German St., Baltimore, Md.

Among the consumers of Despard Coal we name: Manhattan Gas Light Co., N. Y.; Metropolitan Gas Light Co., N. Y.; Jersey City, (N. J.) Gas Light Co.; Washington (D. C.) Gas Light Co.; Portland (Maine) Gas Light Co. Reference to them is requested.

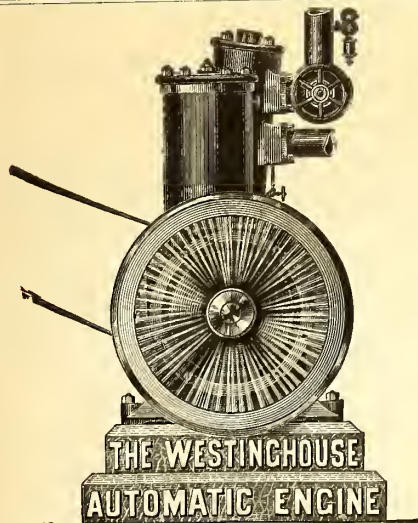

1,300 Engines Now in Use.

40,000 H.P. NOW RUNNING!

Sales, 2,000 H.P. per Month!

SEND FOR ILLUSTRATED CIRCULAR AND REFERENCE LIST.

Westinghouse Machine Co.,

PITTSBURGH, PA.

SALES DEPARTMENT CONDUCTED BY

Westinghouse, Church, Kerr & Co., 17 Cortlandt Street, New York City.

Fairbanks, Morse & Co., Chicago, Cincinnati, Cleveland, Louisville, and St. Paul.

Fairbanks & Co., St. Louis, Indianapolis, and Denver.

Parke & Lacy, San Francisco, and Portland, Or.

Parke, Lacy & Co., Salt Lake City, Utah, and Butte, Montana.

D. A. Tompkins & Co., Charlotte, N. C.

Keating Implement & Machine Co., Dallas, Texas

Imray & Co., Sydney and Melbourne, Australia.

R. Rogers, 43 Rue Laftte, Paris.

F. E. Averill, Delft, Holland.

THE PENN GAS COAL COMPANY

OFFER THEIR
COAL, CAREFULLY SCREENED,
AND PREPARED FOR
GAS PURPOSES.

Their Property is located in the Youghiogheny Coal Basin, near Irwin's and Penn Station on the Pennsylvania Railroad, and on the Youghiogheny River.

OFFICES

No. 209 South Third Street, Phil'a. 90 Wall Street, New York.

PLACES OF SHIPMENT.

Pennsylvania Railroad, Pier No. 2 (Lower Side).

Greenwich Wharves, Delaware River.

366-1y

Pier No. 1 (Lower Side), South Amboy, N. J.

Chesapeake & Ohio Railway Coal Agency,

FOR THE SALE OF THE

Superior Kanawha Gas Coals, Cannelton Cannel, Also, SPLINT AND STEAM COALS.

From the Kanawha and New River Regions, on the line of the Chesapeake & Ohio R'way.

C. B. ORCUTT, Sales Agent. | OFFICE, 150 BROADWAY, N. Y.

FRANCIS H. JACKSON, PRESIDENT.

EDMUND H. MCCULLOUGH, SEC. & TREAS.

THE WESTMORELAND COAL CO.

Chartered 1854.

Mines situated on the Pennsylvania and the Baltimore and Ohio Railroads, in Westmoreland County, Penn.

POINTS OF SHIPMENT:

PHILADELPHIA, BALTIMORE, SOUTH AMBOY, N. J.

WATKINS (SENECA LAKE), N. Y.

Since the commencement of operations by this Company its well-known Coal has been largely used by the Gas Companies of New England and the Middle States, and its character is established as having no superior in gas-giving qualities, and in freedom from sulphur and other impurities.

Principal Office, 224 South 3d St., Phila., Pa.

The Bower Gas Lamp.

The Perfected Duplex-Regenerative Gas Burner, under the combined Patents of Anthony S. Bower, Geo. S. Grimston, and Thos. Thorp.

The First Gold Medal awarded at the Crystal Palace Exhibition in London, and two Gold Medals at the Stockport (Eng.) Exhibition of Gas Appliances. Both in 1883.

GEO. SHEPARD PAGE, JOHN BOWER,
69 Wall Street, N. Y. City.

The Management of Small Gas Works.

By C. J. R. HUMPHREYS. Price, \$1.

A. M. CALLENDER & CO., 42 Pine St., N. Y.



INTERNATIONAL--1876--EXHIBITION.



The U. S. Centennial Commission

HAVE DECREED AN AWARD TO

HARRIS, GRIFFIN & CO.,

12th and Brown Sts., Philadelphia, and 49 Dey St., N. Y., U. S. A.,

FOR THE FOLLOWING REASONS :

The Exhibit consists of a Series of METERS from the Largest Size Station Meters for the use of the MANUFACTURE OF GAS, to those for the use of the ORDINARY CONSUMER. The Instruments are WELL MADE, RELIABLE as to INDICATION, and embody a number of sundry improvements which, with the general character of the Exhibit, entitle the whole to commendation.

Attest—J. L. CAMPBELL,
Secretary, pro-tem.

Signed—A. T. GOSHORN,
Director General

J. R. HAWLEY,
President

CHARLES E. DICKEY.

JAMES B. SMALLWOOD.

CHARLES H. DICKEY.

Maryland Meter and Manufacturing Co.,
DICKEY, TANSLEY & CO.,

Established 1866.

Nos. 22 and 24 Saratoga Street, Baltimore, Md.
No. 46 La Salle St., Chicago, Ill.

MANUFACTURERS OF

DRY GAS METERS, STATION METERS, GLAZED METERS, TEST METERS, METER PROVERS, PRESSURE AND VACUUM REGISTERS, GOVERNORS, INDICATORS, SERVICE AND METER COCKS, AND METER CONNECTIONS.

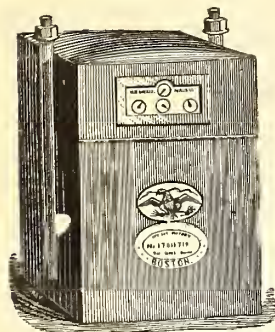

Dry Gas Meter.

With 39 years' experience and the best facilities for manufacturing, is enabled to furnish reliable work and answer orders promptly.

NATHANIEL TUFTS,

No. 153 Franklin Street, Boston, Mass.,

MANUFACTURER OF

DRY GAS METERS.

Station Meters of any Capacity.

Test and Experimental Meters, Pressure Registers, Pressure Gauges, Pressure and Vacuum Gauges.

METER PROVERS, PHOTOMETERS, STREET LANTERNS, ETC., ETC.

Patent Cluster Lanterns for Street Illumination.



Shafting, Pulleys,
HANGERS.

F. Brown's Patent Friction Clutch.

Send for Illustrated Catalogue and Discount Sheet to

A. & F. BROWN,

No. 43 Park Place, New York City.

MITCHELL. VANCE & CO.,

MANUFACTURERS OF

Chandeliers

and every description of

GAS FIXTURES.

Also manufacturers of Fine Gilt Bronzes and Marble Clock warranted best time-keepers. Mantel Ornaments, etc.

Salesrooms, 836 Broadway, N. Y.

Special Designs furnished for Gas Fixtures for Churches, Public Halls, Lodges, etc.

Pipe Coverings.

Fireproof, Non-Conducting Coverings for

STEAM PIPES, BOILERS,
And all Hot Surfaces.

Made in sections three feet long. Easy to apply; light and cheap.

Asbestos Materials, Fibre, Braided Packing, and Cement. These goods are used at Continental Works, Br'klyn.

CHALMERS-SPENCE COMPANY, 419 & 421 EIGHTH ST., N. Y.



Iron Sponge,
GAS EXHAUSTERS,

AUTOMATIC GAS GOVERNORS,

CONNELLY & CO., Limited,

No. 407 BROADWAY, NEW YORK CITY.

T. C. HOPPER, Pres. G. J. McGOURKEY, Vice-Pres. (New York). WM. N. MILSTED, Gen. Supt. & Treas. (New York). WM. H. DOWN Sec.

AMERICAN METER COMPANY,

WET AND DRY GAS METERS.
STATION METERS.
EXHAUSTER GOVERNORS.
DRY CENTRE VALVES.
GOVERNORS FOR GAS WORKS.

PRESSURE REGISTERS.
PRESSURE & VACUUM REGISTERS.
PRESSURE & VACUUM GAUGES.
CRESSION GAS REGULATORS.
MARSLAND WATER METERS.

METER PROVERS.
PORTABLE TEST METERS.
EXPERIMENTAL METERS.
AMMONIA TEST METERS.
BAR AND JET PHOTOMETERS.

Manufactories:
512 W. 22d St., N. Y.
Arch & 22d Sts., Phila.

GAS STOVES,
SUGG'S "STANDARD" ARGAND BURNERS,
SUGG'S ILLUMINATING POWER METER,
Wet Meters, with Lizar's "Invariable Measuring" Drum.

Agencies:
177 Elm Street, Cincinnati.
244 & 246 N. Wells Street, Chicago.
810 North Second Street, St. Louis.
122 & 124 Sutter St., San Francisco.

HELME & McILHENNY.

Successors to Harris & Brother.

ESTABLISHED 1848.

PRACTICAL GAS METER MANUFACTURERS,

Continue as heretofore at the OLD ESTABLISHMENT, Nos. 1115 and 1117 Cherry Street, Philadelphia, Pa.

To manufacture Wet and Dry Gas Meters, Station Meters, Experimental Meters, Meter Provers, Centre Seals, Governors, Pressure Registers, Indicators, Photometers, and all kinds of Gas Apparatus; Also furnish all other Articles appertaining to the use of Gas Works.

From our long Practical Experience of the Business (covering a period of 33 years) and from our personal supervision of all Work, we can guarantee all orders to be executed promptly, and in every respect satisfactorily.

WILLIAM HELME.

JOHN McILHENNY.

WM. WALLACE GOODWIN, Pres. and Treas.

WM. H. MERRICK, V.-Pres.

S. L. JONES, Sec.

S. V. MERRICK, Supt.

THE GOODWIN GAS STOVE AND METER COMPANY,

Successors to W. W. GOODWIN & CO.

1012, 1014 and 1016 Filbert St., Phila., Pa. 142 Chambers St., New York.
76 Dearborn St., Chicago, Ill.

WALDO BROS., Agents, 88 Water St., Boston.

MANUFACTURERS OF THE "SUN DIAL" GAS STOVES, FOR COOKING AND HEATING PURPOSES.

Dry and Wet GAS METERS, Station Meters (Square, Cylindrical or in Staves) Glazed Meters, King's and Sugg's Experimental Meters, Lamp Post Meters, Etc., Etc., Meter Provers (sizes 2, 5 and 10 feet), Pressure Gauges of all kinds, Pressure Registers, Pressure and Vacuum Registers, Pressure Indicators (sizes 4 inch, 6 inch and 9 inch), King's Pressure and Vacuum Gauges, Dry and Wet Centre Seals, Dry and Wet Governors, Exhauster Governors, Photometers of all descriptions. Letheby's Sulphur and Ammonia Test Apparatus complete—also Testing and Chemical Apparatus of all kinds, and of the most perfect description, for all purposes relating to Gas.

GOODWIN'S IMPROVED LOWE'S JET PHOTOMETER.

Agents for Bray's Patent Gas Burners and Lanterns.

Special attention to repairs of Meters, and all apparatus connected with the business.
All work guaranteed first class in every particular, and orders filled promptly.

G. B. EDWARDS, Mang'r, New York.
E. H. B. TWINING, Mang'r, Chicago.

D. McDONALD & CO., GAS METER MANUFACTURERS.

(Established 1854.)

No. 51 Lancaster Street, Albany, N. Y.

STATION METERS, EXPERIMENTAL METERS, METER PROVERS, PRESSURE & VACUUM REGISTERS, PRESSURE GAUGES, ETC.
Also STAR GAS STOVES, RANGES, and HEATING STOVES.

We use only the very best materials, and employ the most skilled labor, and by our long experience (29 years) and personal supervision of every detail, we feel justified in assuring the public that our goods will give perfect satisfaction. Every Meter emanating from our establishment will bear the State Inspector's BADGE, and will be fully warranted by us. Our Annual and Calendar will be sent to Gas Companies upon application.

KING'S TREATISE ON COAL GAS.

The most complete work on Coal Gas ever published. Three vols., bound, \$30.

A. M. CALLENDER & CO., No. 42 Pine Street, New York.

THE "OTTO" GAS ENGINE.

Guaranteed to Consume 25 to 75
Per Cent. LESS GAS than ANY OTHER GAS ENGINE
PER BRAKE HORSE POWER.

TWIN ENGINES Impulse every revolution.
THE STEADIEST RUNNING GAS ENGINE YET MADE.

ENCINES AND PUMPS COMBINED,
For Hydraulic Elevators, Town Water Supply, or Railway Service.

Special Engines for Electric Light Work.

OVER 15,000
IN USE.

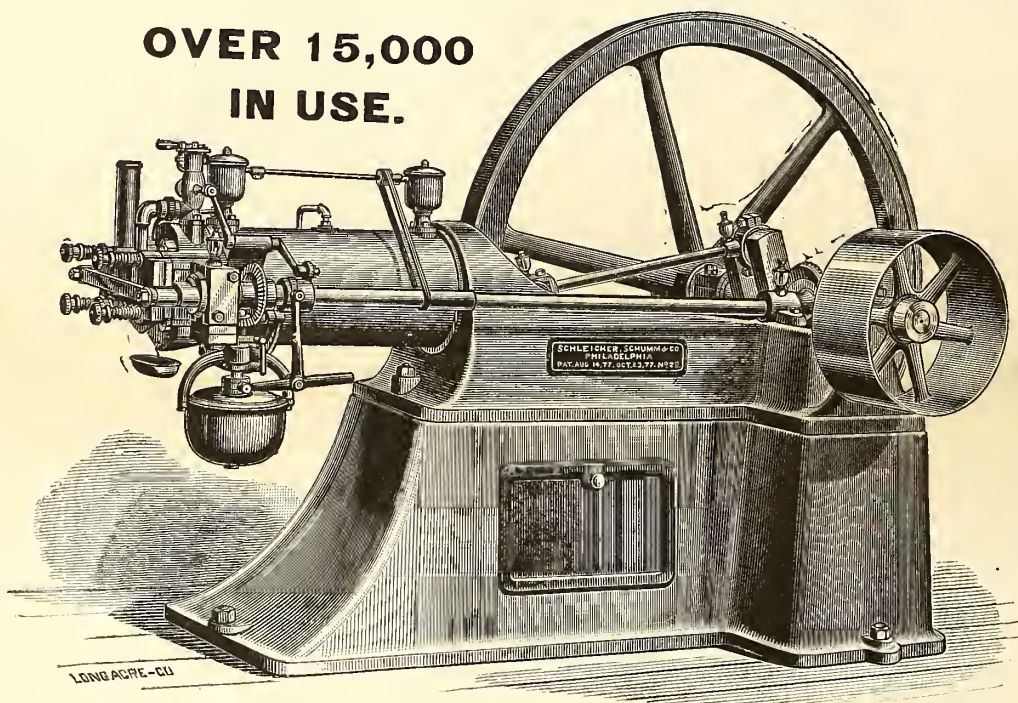

The Otto Gas Engine is now consuming, at a moderate computation, 2000 millions cubic feet of gas per year, nearly all of which is furnished during day time only.

**THE ONLY HIGHEST AWARD, ONLY GOLD MEDAL,
AT ELECTRICAL EXHIBITION, PARIS, 1881.**

MADE IN SIZES FROM 1 TO 25 HP. INDICATED.

FOR PARTICULARS, PRICES, ETC., APPLY TO

SCHLEICHER, SCHUMM & CO.,

Works:

N. E. Cor. 33d & Walnut Sts., Phila., Pa.

Branch Office:

214 Randolph Street, Chicago, Ill.

THE AMERICAN

GAS LIGHT JOURNAL

PUBLISHING OFFICE No. 42 PINE STREET

DEVOTED TO THE INTERESTS OF ILLUMINATION, VENTILATION, WATER SUPPLY AND DISTRIBUTION, & GENERAL SCIENCE.

VOLUME XLII.—No. 7.
Whole No. 619.

NEW YORK, THURSDAY, APRIL 2, 1885.

\$3 PER ANNUM
IN ADVANCE.

A. M. CALLENDER & CO., Proprietors. C. E. SANDERSON, Manager.
JOS. R. THOMAS, C.E., Editor.

ENTERED AT THE POST OFFICE AT NEW YORK, N. Y.,
AS SECOND CLASS MATTER.

Published on the 2d and 16th of each month, at No. 42 Pine Street, N. Y.

Terms of Subscription, Including Postage.—For the United States and Canada, \$3 per annum. European countries, \$3.50 (15 shillings—18 francs). All payments to be made in advance. Single copies, 15 cents.

Remittances should be made either by post-office order, registered letter, or bank draft on New York, payable to the order of A. M. Callender & Co.

Collections are invariably made directly from this office, for subscriptions, advertisements, etc. We have agents to solicit the same, but they are not authorized to receipt for money.

Correspondence.—Wishing to make this JOURNAL a gazette of intelligent discussion to those of our readers who may wish to gain or give information on the subjects to which its columns are devoted, correspondence is solicited for publication from all who make the study of those subjects a pleasure or a profession.

Books.—We will mail, post-paid, at publisher's lowest rates, any book—scientific or otherwise—to any address in the United States or Canada. No books will be sent C. O. D.

The American News Company, Nos. 39 and 41 Chambers street, New York, are agents for this JOURNAL. Newsdealers will send orders to them.

CONTENTS.

An Asterisk (*) denotes an illustrated article.

OFFICIAL CIRCULAR—

Annual Meeting of the Western Gas Association..... 169

EDITORIALS—

Annual Meeting of the Guild of Gas Managers..... 169

Messrs. Gibbs and Van Steenberg Take a Trip to Troy, New York..... 170

Syracuse (N. Y.) Gas Company Reduces Price of Gas..... 170

The Market for Gas Securities..... 170

Fifteenth Annual Meeting of the New England Association of Gas Engineers—Official Report—Continued from page 147..... 171

The Influence of Steam in the Ashpan, by C. F. Pritchard—Discussion.

Papers Read before the First Annual Meeting of the Ohio Gas Light Association, with Discussions on Same—Official Report..... 174

First Day, Morning Session—The Use of Gas Stoves as a Means of Increasing the Consumption of Gas, by Jos. Bate—Discussion—Membership List.

The Dangers of Water Gas..... 177

Petroleum and its Residuals—By Wm. Farmer. C.E..... 178

Special English Correspondence..... 179

ITEMS OF INTEREST FROM VARIOUS LOCALITIES..... 181

It was not of Much Account after all—Something from Louisville, Ky.—Chronicle Several Changes—Cheaper Gas for Troy, N. Y.—Bartlett, Hayward & Co. to Build the Holder—Election of Directors—Cheaper Gas for Sioux City, Iowa—Making the New Orleans (La.) Taxpayers Sweat—When His Term Expires—A Reduction—Striking Gas Coal Miners—The Equitable (N. Y.) Gas Company's Officers for Ensuing Year—Suing a Gas Company on the Ground that an Escape of Gas Caused the Death of Shade Trees—Now it is the Edison Meter—Reducing the Price of Gas in Kingston, Canada—A Narrow Escape.

[OFFICIAL CIRCULAR.]

ANNUAL MEETING WESTERN GAS ASSOCIATION.

SECRETARY'S OFFICE WESTERN GAS ASSOCIATION, {
QUINCY, ILLS., March 20, 1885.

The Eighth Annual Meeting of the Western Gas Association will be held at Chicago, Ills., on the 13th, 14th and 15th days of May. The Committee of Arrangements, Messrs. E. L. Brown, P. T. Burtis, and Henry Pratt, have spared no pains to secure for our accommodation the best quarters for our purpose obtainable. Those who attended our last reunion at St. Louis will remember but too well that the chief, and perhaps the only, drawback to an entirely successful meeting was the character of the room in which were conducted the business sessions of our Association. Owing to our late unfortunate experience in this particular, you are all aware that it is a matter of the highest importance that the acoustic property of the hall in which we are to assemble should be as excellent as it is possible to secure. Bearing this point well in mind, the Committee, after having carefully examined the assembly rooms of every first-class hotel in Chicago, arrived at the unanimous conclusion that the Tremont House, of that city, came nearer meeting our requirements, in all essential particulars, than any of the others, and accordingly have secured it for our Eighth Annual Meeting. This hotel, although not so large as some of the others, is strictly first-class in all its appointments, and admirably well adapted to our needs. Liberal concessions from the regular rates were secured by the Committee, and the prices to our members will range from \$2.50 per day upwards, according to the size and location of rooms. Apartments can be secured, at any time before the date of the meeting, by those who will communicate with the proprietors of the hotel, or with your Secretary; but the members must in all cases give notice, in their requests, of the rates which they desire to pay.

I am very anxious to be informed as soon as possible of the titles of the papers to be presented, and earnestly request their authors to favor me with this information at their earliest convenience.

Copies of our Constitution and By-Laws, blank forms of application for membership, or any other information that may be desired, will be promptly furnished if you will but make your wants known to, Yours very truly,

A. W. LITTLETON, Secretary.

Secretary Littleton has also mailed a copy of the following letter to each member whose name appears on the Association's rolls:

"I am very anxious that you should favor our Association with a paper on the occasion of its Eighth Annual Meeting, to be held at Chicago (Ills.) on the 13th, 14th and 15th days of May. Will you kindly do so?"

"I am somewhat afraid that the presentation of papers may not be as generous as we all might wish; and am therefore specially desirous that you should contribute in this way to the prosperous issue of our meeting which will be, beyond question, entirely successful in all other respects. An early reply will be greatly esteemed."

ANNUAL MEETING OF THE GUILD OF GAS MANAGERS.

The Fifth Annual Meeting of the "Guild of Gas Managers," of New England, was held at 12 o'clock noon of Saturday, March 14, at the rooms of the Society, in Mason Building, Boston, Mass. The Secretary distributed to the members in attendance a copy of the tabulated statistics (compiled by direction of the Guild) for last six months of year 1884. He also read an arti-

ele, contained in columns of *Boston Medical and Surgical Journal*,* entitled, "The Dangers of Water Gas."

The Treasurer read his annual report, the document being devoted to a recital of receipts and expenditures for year 1884. When the statement of accounts had been duly audited, the report was accepted and ordered to be spread upon the Society's records.

With a view to enhance the interest in the monthly meetings, the Guild voted that two papers, upon subjects connected with the manufacture and distribution of gas, should be prepared and presented at each of the regular sessions of the Society. A special committee was appointed with instructions to make an assignment among the members as to the months in which the different gentlemen would be called upon for their papers. The President (after committee had reported) announced that the drawing had resulted in the following allotment:

April, Messrs. Humphreys and Cushing; May, Messrs. Rogers and Smith; June, Messrs. Slater and Spalding; July, Messrs. Bill and Perry; August, Messrs. L. P. Gerould and Richardson; September, Messrs. Rollins and Stedman; October, Messrs. Andrew and Leach; November, Messrs. Yorke and Tarbell; December, Messrs. Neal and Pratt; January, Messrs. Geo. D. Cabot and C. L. Gerould; February, Messrs. Prichard and Durfee; March, Messrs. Taber and Stiness.

The Guild then proceeded to an election of officers for ensuing year. The following named gentlemen were chosen:

President—A. B. Slater, of Providence, R. I.

Vice-President—R. B. Taber, of New Bedford, Mass.

Treasurer—Jno. Andrew, of Chelsea, Mass.

Secretary—E. G. Pratt, of North Attleboro, Mass.

After the remaining routine business had been transacted, the guests and members of the Guild partook of the annual banquet, covers for which had been laid, and the feast served, in the Society's rooms. A social hour or two was passed in a thoroughly enjoyable manner, and when adjournment took place the members separated with the mutually gratifying knowledge that the Guild meetings have resulted in a great improvement and addition to their fund of practical information. The best testimony to such advance is shown in the practical results gained at their several works.

The Guild now carries on its rolls the names of one honorary and twenty-five active members, and it is our pleasant necessity to chronicle its increased usefulness as evidenced with each added year of its history.

MESSRS. GIBBS AND VAN STEENBERGH TAKE A TRIP TO TROY, N. Y.

That eminent disciple of disinterestedness, Mr. L. S. Gibbs, whose latter-day travels have been directed to those localities where he can best alleviate "the woes and sufferings of a people who have been ground into the dust by the iron heel of the oppressor," which oppressor (iron heel and all) always takes the form, when crossing the field of vision enjoyed by Messrs. Gibbs and associates, of a gas company, has in due course of time arrived at the city of Troy, N. Y. That other eminently erratic traveler, for an account of whose mysterious peregrinations and their gruesome results the world is indebted (or not indebted, according to the impression of the reader), to the fanciful pen of Eugene Sue, is reported on one occasion as having sorrowed mightily over the direness and cruelty of the fate that hurried him on to bring dismay, disaster and death to the people of the gay French capital. Now one cannot help wondering whether Mr. Gibbs, ere he boldly marched on to the goodly city of Troy, tarried for a moment on the hilltop at its eastern confine in order that he might bemoan the sad necessity so relentlessly urging him forward in an endeavor to "smite" the property of the Troy and Citizens Gas Light Companies. While believing ourselves that Mr. Gibbs preferred the easier and simpler method of "running into Troy" while safely and comfortably ensconced in a "parlor car," and also think he would be much more sensible in following out that plan than should be the case did he spend an hour or two wandering or crooning about the hilltops on a day or night so cold as was the 18th of last March—Mr. Gibbs and associates appeared before the Troy Common Council on evening of March 18. He could bemoan himself just as well and just as completely on board the parlor car as did the Wandering Jew from the lofty eminence that afforded him a complete bird's-eye-view of Paris. And as Sue's hero extracted comfort from the fact that although through his entry was Paris to suffer great loss, yet after her suffering would come the knowledge that she had been "purified," so also may we take it that Mr. G. solaced his perturbed mind with the reflection that the Troy Gas Company was reputed to be the possessor of a large surplus; and would not the stockholders be benefited if someone else succeeded in relieving them of the embarrassment and risk involved in the caring for "so much money."

Apart from the above problems, which, of course, Mr. Gibbs can alone

authoritatively dispose of, it is matter of record that he, with B. Van Steenberg and others, made application to Streets and Alleys Committee of Troy Common Council (March 18th) for a franchise to use the mains of defunct Troy Steam Heating Company as conduits for the distribution of a water gas, *a la* Van Steenberg; also to lay extra conduits, and perform all the avocations belonging to a thoroughly (more or less) equipped gas plant. If these requests were granted the petitioners agreed to supply gas to consumers at a figure not exceeding \$2 per thousand. Representatives from Troy and Citizens Companies were on hand to defend their interests, in the persons of Messrs. Sabbaton and Shields. Now, if we remember rightly, Gibbs' "man Friday" (Van Steenberg) is the "engineer" who, on date of March 4th last, testified before the Senate Committee during one of the famous Morton House sessions, that he could manufacture an excellent article of illuminating (30-candle power) gas for 26 cents per 1,000 cubic feet. He also said that he had "just entered into a contract to put in a plant with a capacity of 350,000 cubic feet per day, for the sum of \$180,000. There were to be ten miles of pipe, 1,000 meters, and two holders, each of a capacity of 175,000 cubic feet." He said the city in which he was to build the proposed plant had a population of 60,000, and that 31 cents per 1,000 would cover cost of distribution. Putting these statements together, and bearing in mind that Troy has about the stated number of inhabitants, it looks as though Van's contract had reference to the home of the Trojans. But as "the best laid plans of mice and men gang aft a-glee," it might be just possible, in view of the fact that the Troy Council has not yet sanctioned the scheme, that Mr. Van's contract, so glibly spoken of as already made at a date as early as March 4th, might hereafter be chronicled as having "gang aft."

In the argument that ensued before Committee Mr. Sabbaton read a letter, which he had received from the Superintendent of the Chuctanunda (Amsterdam, N. Y.) Gas Light Company, in regard to his experience with Van Steenberg and his process. The Amsterdam Company allowed the "inventor" to put in his system, and Mr. Ward asserted that it was a most complete and thorough failure. Quoting Mr. Ward's own words, he concluded his letter to Mr. Sabbaton with the statement, "They were to make, with each generator, 5,000 feet per hour of 24-candle gas, with a consumption of 5 gallons of naphtha and 50 lbs. of coal. They could but make 4,000 feet with two generators; and that product was only obtained at an expenditure of 10 gallons of naphtha and 300 lbs. of coal." Amsterdam had enough of the experiment, and Van's traps were relegated to the seclusion which the Goshen Foundry (Mr. V.'s manufacturing center) "grants." As it was at Amsterdam so is it likely to be at Troy. Having (up to time of writing) received no further details of Committee's action it is fair to presume that Mr. Gibbs' project still "hangs fire." We would request of Mr. Sabbaton that he keep us informed as to the progress made concerning the latest attempt at the "siege of Troy."

SYRACUSE (N. Y.) GAS COMPANY REDUCES PRICE OF GAS.—Brother Wood's company keeps moving right along. On Friday, March 27th, Secretary Babcock was authorized by his board of directors to announce that from and after June 1st the price of gas would be reduced to \$1.60 per 1,000. All of which means cheap gas, good management, and skilful engineering.

The Market for Gas Securities.

Consolidated gas has experienced a continued spell of depression during last fortnight, and there undoubtedly has been much manipulation indulged in. At time of writing (morning, March 31,) the stock is offered at 84, best bid price being 83½. The total sales, since our last report was given, foot up 6,914 shares at figures varying between limits of 92½ to 84. The Senate Committee appointed to "investigate" the New York city gas companies handed in a report, together with a draft of the legislation proposed, on the evening of March 30th. It was not to be supposed, judging from the *personnel* of the Committee, and making due note of the parties who appeared to be in charge of the Morton House *seances*, that the scheme or arrangement whereby consumer and company were to be alike protected would be of any value, or savor in any respect of fairness. The synopsis of bill, as presented in morning papers, bears out such suppositions; and probably the most noteworthy feature of the plan is the charmingly liberal manner in which the funds of the Consolidated Company are to be distributed amongst the lucky politicians, who will, if the scheme goes through, secure a berth on the "Board of Lighting Commissioners," or even a Secretaryship to that august body. Three Commissioners are provided for, each to be reimbursed in the annual sum of \$6,000, and the Secretary is to draw the modest stipend of \$3,000—"lame ducks" will not have much chance in that "hunt." The "specifications" limit the annual expenses, etc., of Commission to \$40,000. Extended comment is reserved until certified copy of bill comes to hand. Equitable is very strong, 63 shares, sold at auction, brought 107½. The company is building a new holder.

On March 24th articles incorporating the Chesapeake Gas Company were filed at Baltimore, Md. Among the directors we note the names of Messrs. Tag, Dickerson, Benedict, and Jerzmanowski, all connected with Equitable (N. Y.) Company. Consolidated stock, in consequence, dropped 27 points—or from 79 to 52—in just ten days. Certain New York parties, who are on the inside, made large profits on the "short" side. In old times another word than "profits" would be employed to designate the transaction. For regular list see page 183.

* See page 177, current issue.

[OFFICIAL REPORT—CONTINUED FROM PAGE 147.]

Fifteenth Annual Meeting of the New England Association of Gas Engineers.

HELD AT YOUNG'S HOTEL, BOSTON, MASS., FEB. 18 AND 19, 1885.

FIRST DAY—AFTERNOON SESSION—FEB. 18.

President Greenough announced the regular order to be the presentation of papers, and called upon Mr. C. F. Prichard, of Lynn, Mass., to read his communication entitled,

THE INFLUENCE OF STEAM IN THE ASHPAN.

In accordance with the invitation, Mr. Prichard read as follows :

One of the chief advantages usually claimed for the use of steam under the grate bars, or what is substantially the same thing, water in the ashpan, is economy of heat; and hence of fuel. The ground here taken is that instead of their being any economy the reverse is true; and a positive waste of heat, and consequently of fuel, results.

When a body enters a fire at a certain temperature, and leaves the chimney at a higher temperature, it has evidently obtained its increased temperature from the fire, and has accordingly occasioned a loss of heat, and consequently a waste of fuel.

When the nitrogen of the air enters a fire and passes from the chimney in the same condition as when it entered, except that it has attained a higher temperature, heat is lost; but it is unavoidable. If steam of 212° enters the fire and leaves the chimney at 600 to 1,500° temperature, it has obviously withdrawn heat from the furnace. The fact that it has decomposed and recombined has nothing to do with the loss of heat. For the purpose of calculation it is the same steam that entered the bars; and it has increased in temperature just as the nitrogen did; but, perhaps, the waste thus caused is not justifiable.

A simple experiment makes this waste visible—if you have short chimneys, give a vigorous shake to the bars over an ashpan full of water; in a moment a column of flame is produced, shooting up far above the chimney top. No one supposes for an instant that this simple action has increased the heat of the furnace; it has, only for the time, transferred the combustion which should take place in the furnace to the chimney top. So a small amount of steam is continually transferring combustion from the furnace to a point further on where it is not so much needed, while the unnecessary gases thus introduced are continually drawing heat from the furnace and delivering it to the outside air. In an experiment lasting some time it was found impossible to produce any flame on the chimney top, when there was no water in the ashpan, while the fire was very white and next to impossible to face; the heat on the retorts was as good and perhaps better, while the amount of fuel was noticeably less, and the bars and bearing bars suffered no deterioration that we could notice. The clinker, however, showed a decided increase, but was very soft and inclined to run. A deposit of clinker from a tar fire, which had defied all efforts to remove, softened and was taken out easily. In running the ordinary way this bench used up from 650 to 750 lbs. of water each 24 hours, and the amount of heat passed out of the chimney, exclusive of that which entered with the steam, was not far from 2 per cent. of the total heat produced in the furnace.

If an evaporation of one pound of water for each pound of fuel is reached, and the fact considered that much of the water carried in must inevitably be carried in as mechanically suspended particles, which absorb the latent heat of steam, as well as that due to the increase of temperature, it is not impossible that there is a waste of fuel amounting to nearly four per cent.

The increase in the products would amount to nearly 15 per cent., and would be no slight drawback to a bench whose flues are perhaps already overcrowded.

Whether there is an increase of temperature actually obtained is a matter which will admit of considerable discussion. It is sometimes erroneously argued that when steam is admitted to a fire, and decomposed into its elements, hydrogen and oxygen, the oxygen would unite with the carbon of the fuel, and make it possible to do with a smaller supply of air, thus reducing the amount of heat-absorbing nitrogen and making it possible to obtain a higher temperature. Unfortunately for this reasoning the hydrogen, the remaining element of the decomposition, has been neglected; and, in the nature of things, must be consumed to the original amount of water by combining with oxygen, and having no source for O but the air, it becomes necessary to introduce just as much air to supply this O as was spared before. Thus no permanent reduction of the air supply is effected; and consequently no economy from the reduction of nitrogen. In fact the reverse is true, since a certain amount of heat is lost in every change of form which a body undergoes, and since the combustion of every particle of H cannot be expected in practical working, unless there is a large excess of air supplied.

Sometimes it is argued that the steam of itself carries heat to the furnace

to its advantage. It is but few years since that a scientific gentleman attempted, in the columns of the AMERICAN GAS LIGHT JOURNAL, to demonstrate perpetual motion, in a chemical form, by claiming a gain of heat; because the dissociated hydrogen and oxygen formed new chemical compounds with the carbon of the furnace, whose combustion increased the total heat. Rankine, Tyndall, Maxwell and others make the statement, in various forms, that when H and O are present in the fuel, in the proportions to form water, they unite as such, and do not increase the total heat of combustion. From such testimony it must be admitted that no surplus heat can be expected from the decomposition and recombination of the steam; while, as seen before, although the steam carries into the furnace 212 heat units due to its temperature, and 966 due to its latent heat, for each pound of water, yet it also carries out of the furnace from 600 to 1,500 heat units due to temperature, plus 966 due to latent heat.

Statements are often made that the hydrogen flame is the most intense flame; and a well-known treatise states that the decomposition of steam produces hydrogen, a combustible of the highest order, and oxygen, a supporter of combustion, leaving us to infer that by the simple introduction of H a gain in intensity was made, while a still further gain resulted from the oxygen thus produced. We have already seen how much benefit can be expected from the O, since it does not reduce the supply of air, while the former, we contend, is not right—H not being hotter than carbonic oxide produced in regenerative furnaces, burdened as it is with the unnecessary, but unavoidable, N of primary combustion, while it is several hundred degrees cooler than the flame of pure carbonic oxide. The statement that H flame temperature is lower than CO conflicts with many authorities who cite H as the hotter; but if one cares to make the calculation, let him bear in mind that the total heat of combustion of H is not developed in the flame, for the 9 lbs. of water resulting from the combustion carries away 966 heat units, its latent heat, for every pound, which must be deducted in all calculations of flame temperature.

In the furnace, however, a different order of things exists. There the CO is burdened with the necessity of heating up the N of primary combustion, spreading its heat over a larger volume, and reducing its intensity. While the H, passing into the furnace as steam of 212°, and carrying 966 units latent heat, starts its combustion from a higher level than ordinary H, and reaches a higher temperature.

So we say that the superiority of H over CO in our furnaces is not due to the high flame temperature of H, as so many state; but rather from burning H, already partially heated up, as against CO adulterated with N. Were this radiant heat from the under part of the fire caught by the entering supply of air, and thus returned to the fire, the result would be as good, while the waste of heat already pointed out would be avoided.

Although it seems possible that, theoretically, an increase of temperature may result from this reasoning, there are other things to be considered. Steam is introduced below boilers to cause a long flame, and to give each tube an opportunity to do its share in transmitting heat to the water, by prolonging the combustion. This is departing from the instructions of Tyndall, who directs us to concentrate to obtain intensity. And as time and space are prime factors in obtaining intensity, can we expect that one pound of H, occupying 188 cubic feet of space, can compete with one pound of CO occupying but 13 feet? The increase in the products of combustion, the waste of heat already shown, and the effect of dissociation, about which so little is known, all combine to reduce this theoretical difference of a few hundred degrees, until it is doubtful if, in practice, any gain of intensity is produced by the use of steam.

The saving of the bars is claimed as a minor matter, but it is of slight importance; and within a month an English patent, in one of its claims, proposes to preserve the grates by keeping them away from contact with the steam.

The prevention of clinker is a matter of more importance. This is to be brought about by the reduction of the intensity of the fire, which causes the clinker to fuse. Whether we are justified in reducing the intensity of the ordinary furnace by causing a waste of fuel is a debatable question. In a regenerative furnace, where it would seem the combustion might be controlled by other means, water is often used to reduce intensity, while the primary air is often heated to promote intensity.

On motion of Mr. Thomas, a vote of thanks was tendered to Mr. Prichard.

Discussion.

The President—We have heard a most interesting paper, and it is one of the sort that we like to have presented at our meetings, since it runs somewhat counter to generally accepted views. Considering that so many of us have been working on the problem of how to get steam into the furnaces, I think Mr. Prichard's arguments should provoke a lively discussion. I would like to hear from Mr. Stedman on the subject.

Mr. Stedman—We have used considerable steam in our regenerator fur-

naces, not with an idea that we were thereby increasing the total yield of heat from the fuel, but simply that we might transfer the heat from a point where it was only destructive to a point where it was beneficial. At the close of Mr. Prichard's paper he calls attention to the fact that those using regenerator furnaces introduce steam to control the intensity of the combustion, and heat the primary air for the purpose of increasing the intensity of the combustion. Those two operations carried on together seem almost paradoxical; but at the same time I can see why there is a pretty good reason in doing the two things together. I think the gentleman is perfectly right in his statement that there is no increase of temperature, but on the contrary, rather a slight loss of fuel occasioned by the introduction of the steam. As he states, the transference of energy from one point to another is generally accompanied with more or less loss; and the decomposition and recomposition of the same elements are undoubtedly accompanied with some loss of energy. As we have sometimes in our experiments evaporated somewhere near a pound of water to a pound of coke in the furnace, we imagine that the oxygen from the steam does really enable us to use a less quantity of primary air. We heat that primary air for the purpose of promoting the energy of the fire and aiding in the decomposition of the steam, and so that we can decompose as much steam as is necessary to effect our object without tearing the furnace to pieces by the great destructiveness of the heat at the point of greatest energy. Just here I have a good mind to bring in my old illustration of a zone of intensity which I believe our friend from Brooklyn criticised a few years ago. There is a zone, or area, of intense combustion, about a foot above the furnace bars; and there is the point where I think everybody who has used regenerator furnaces has mostly found difficulty with clinkers. Above that the heat is maintained at a moderate temperature, owing to the fact that the decomposition of the carbonic acid which is formed at the intense point is a reducing process, and reduces the intensity of the heat above that zone. I cannot say, from my experience, that much loss of energy would be due to the fact that we decompose the steam. I am very well aware we could get up a much more intense fire without the steam; but the question is still debatable whether it pays to do it, or whether, on the whole, it is better to save a small amount of fuel, and be subject to the destruction of grate bars and the annoyance of clinkers, or to use a little more fuel for combustion and control the energy at the point where it is most destructive, and then transfer that energy to where it is more useful. I might have said, in connection with other annoyances of intense heat, that at certain points it wears through the lining of the furnace pretty rapidly. Of course, when the steam is decomposed we get as a product the free oxygen and carbonic oxide due to the association of the oxygen of the steam with the carbon. The gentleman is perfectly right in assuming that we do not save in the total bulk of nitrogen, because we have to re-supply oxygen to the hydrogen to effect the combustion; and of course the carbonic oxide from a pound of steam necessitates just as much air to consume it as the carbonic oxide made from the air originally. The point is, I think, to determine whether, on the whole, the loss of energy (which the gentleman admits is slight) is enough to warrant us in dispensing with the steam, using a more intense heat throughout the whole body of the coke. I am under the impression that the control of energy at the point of greatest combustion diminishes the amount of carbonic acid produced by the fire, so that there will be a greater proportion of resulting gases which will be combustible. I may not be right about it, but I think perhaps that is one of the results. As to the loss of heat from the mechanically suspended particles of water which may come in with the steam, but which have not in them the developed latent heat of steam—I think that is a fallacy, because in our furnace, where the primary air comes in with considerable elevation of temperature, it is sometimes a little above the normal temperature of steam. Thus the latter, instead of being decomposed, or having any contained watery particles, is a genuine steam, having all the heat of steam, together with all the latent heat which has been produced by the evaporation of the water. When we look through the front door of the furnace without letting in any air (as we can do by removing a slide and putting in a piece of glass), it is almost impossible to perceive any steam. The moment the door is opened, however, the particles of moisture are condensed, and the steam becomes visible. I suppose it would be a matter of calculation as to whether the specific heat of steam in its relation to the specific heat of air—of nitrogen particularly—would be any disadvantage as to the bulk, as the bulk of gases in the furnace, after complete combustion, would be a little greater by using the steam than by the use of air alone. In that respect the result might figure out a trifle less on account of additional bulk which would have to be raised to the temperature of the furnace. In regard to the hydrogen (as we do not claim any result from that, other than that there is no loss, theoretically, from the decomposition and reburning of the hydrogen above) it is hardly worth while to consider it, except in respect to its bulk, and the intensity of the volume of combustion. The loss of 966 units of heat in a pound of water would be comparatively small, when we consider that the combustion of a pound of hydrogen yields 62,000 heat units. I am rather

doubtful as to the suggestion that the radiant heat from the bottom of the fire (in case the steam was withdrawn altogether) could be utilized in heating the incoming air, since the radiant heat is transmitted through the pure air without having any effect upon it. It is only upon coming in contact with a body previously heated that the air is heated; or it is heated slightly by radiant heat, after coming in contact with the impurities in the air, and which are suspended as solid substances. There was suggested the idea of controlling the intensity of the energy of combustion by other means. I suppose if we could build a furnace large enough we could so control the introduction of air as to have a proper quantity diffused over a very large surface, or so that the energy of combustion, at any particular point, could be very much reduced—possibly reduced to that point where clinker would be of very little consequence. If it were possible to get furnaces large enough to get such a result, and to obtain a supply of air without the addition of steam, I confess I should be rather inclined to believe that that would be a superior furnace. It is hardly possible, in an ordinary stack, to build furnaces of that size, especially if you have to put in recuperative work with it. The more I see of the effects of recuperation the more I am inclined to believe that it is worth all it costs in its economy of fuel, in the energy of combustion which results, and in the high heats which can be produced therefrom. I do not know of any other point that I can make a note of. I do not see but that generally the gentleman's position is a sound one, and I am not inclined to cavil at it; but I think it is a debatable question (and one I would like to hear more about) as to whether the slight loss of energy (for it must be very slight) in using steam under the bars of regenerative furnaces is important. I am not now speaking of the effect of its use in ordinary furnaces, since the resulting gases from ordinary furnaces are almost in a complete state of combustion—in fact I may say that they are complete—because in ordinary furnaces we use probably two volumes of air for every one required, and such use is necessary in order to produce carbonic oxide and not have carbonic acid. In the regenerative furnace I confess I do not see how we can reduce the energy of combustion to a point where it is practically harmless on the walls of the furnace, and where it results in reducing the amount of clinker without the use of steam, without making the furnace very large indeed. I am inclined to think, on the whole, from our practice, that steam has been very advantageous. We have run our furnaces sometimes three weeks, sometimes a month, without clinkering at all, other than to shake the bars once in four or six hours; and from time to time run a bar into the fire. No clinker accumulates, other than that which can be shaken down through the bars. After a time, depending upon the driving of the fire, and the kind of fuel used in it, the clinkers accumulate on the bars to that degree that it is desirable to take the bars out and let the clinker which accumulates on them fall down into the ashpan, as it cannot fall out between the bars. On the whole I am very well satisfied with the result of using steam, both in the ease with which the furnaces are managed, and as to the fuel account, which with us has been reasonably small.

Mr. Prichard—I think the amount of mechanically suspended water carried from an ashpan full of water is overlooked. Considering the small distance between the water and the bars, and the rush of entering air and steam, one-half the amount evaporated must be carried into the fire in the shape of mechanically suspended particles. It seems to me it would not have time to reach the state of steam. Col. Stedman made a statement with regard to the amount of latent heat deducted from one pound of hydrogen. The hydrogen furnishes 62,000 heat units, and he deducts the latent heat of one pound of water; but in fact there are nine pounds of water formed from one pound of hydrogen, and you must multiply 960 by 9, which makes very nearly 9,000 heat units to be deducted from the total heat which should result from one pound of hydrogen; and reduces the flame temperature of the hydrogen from 5,700 degrees, as given by Haswell and others, to a temperature, as I calculate it, of 4,800 degrees. The fact that there is nine pounds of water there instead of one is a fact very often overlooked in the calculations. We speak of the slight bulk of the steam if we succeed in evaporating one pound of water with one pound of fuel; but instead of its being slight, it amounts to nearly 15 per cent. of the bulk of the products of combustion. I have often thought that the introduction of water under a regenerative furnace was perhaps a needless waste; for we know, from the results of the water gas people, who run a blast under the regenerator, that they do produce a vast amount of carbonic oxide with a comparatively small amount of clinker.

The President—I hope this discussion will not stop here. The question before the meeting is a practical one, notwithstanding the theories which have been advanced. Narrowed down, the real question is, "What is the effect of putting steam in regenerative furnaces?" I think, in so far as that is concerned, we have had some experience which leads us to agree with Col. Stedman rather than with Mr. Prichard. Last year we imported from Germany some settings of eights, with what are called open hearth furnaces—these having no grate bars in them. The coke ran right down into the bottom. I found, as matter of fact, that we could not keep the furnace from

clinkering up on the middle unless we put steam into it. When we used steam we found we could run the thing perfectly well; but without the employment of something to cool the "zone of intensity" we got a clinker deposit in the middle that took all the intensity out of the heat in the arch, and we have been obliged to run steam underneath, in small quantities, ever since. In respect to those furnaces which we are running at Commercial Point, I want to call your attention to the analyses. We found out there just what others have found out elsewhere. In putting steam into the water of the ashpan we caused a large quantity of steam to be evolved. The practice has greatly lessened the quantity of labor required in clinkering, and it has kept the furnaces cool. I have no doubt a certain quantity of heat is theoretically lost; and if you decompose steam in the first place, and then burn it up afterwards, you do not get back all that you start with; but, as matter of fact, you take heat out of the furnace and put it somewhere else where you want it a great deal more than in the furnace. I think it is the experience of most people who have handled regenerative systems that they are willing to occasionally dispense with a little heat in their furnaces, and would be glad if they could control their heat rather than increase it. As far as the effect of water on the grate bars goes—if water under the furnace or in the ashpan does not do any good to grate bars, then I do not know what it is there for. I would be glad to have some gentleman, who is a more practical gas maker than I am, say something about that thing. I always supposed it was a necessary part of the fitting out of gas works that you should have an ashpan containing water underneath the grate bars; and that it was necessary to have water there in order that the grate bars might be kept cool. Now we are told that there is no necessity for the water there; that the bars are better without it. I hope the Association will not permit such contradiction of an ordinary custom to pass unchallenged.

Mr. Armington—I have listened carefully to the reading of the paper, and I heard a statement made by which I understand the author to claim a loss of 2 per cent. of all the heat for each 4 per cent. of fuel consumed. It strikes me that that must be radically wrong. Perhaps I have misunderstood him. It seems to me we must be getting very little result from the amount of carbon we are burning, when we lose 2 per cent. of heat for each 4 per cent. of fuel burned.

Mr. Prichard—You have got two statements confounded. I said, if you evaporated a pound of water for every pound of fuel, and admitted that one-half of the water went in as mechanically suspended particles, you lose nearly 4 per cent. of all the heat produced. Two per cent. did not come in any connection with the 4 per cent. I said that in an experiment, running in the ordinary way, a bench used up from 650 to 750 pounds of water each 24 hours; and that the amount of heat which passed out of the chimney, exclusive of that which entered with the steam, was not far from 2 per cent. of the total heat produced in the furnace.

Mr. Armington—In the next paragraph you speak of 4 per cent.

Mr. Prichard—I said, "If an evaporation of one pound of water for each pound of fuel is reached, and the fact considered that much of the water carried in must invariably be carried in as mechanically suspended particles, which absorb the latent heat of steam as well as that due to the increase of temperature, it is not impossible that there is a waste of fuel amounting to nearly 4 per cent."

Mr. Armington—I confess I do not precisely see that yet. I shall have to take the paper and read it through carefully. It seems to me that the one paragraph qualifies the other.

Mr. Prichard—One relates to an ordinary furnace, and the other relates to a furnace evaporating one pound of water to one pound of fuel.

The President—That is a pretty large evaporation. Do you mean to have these remarks in your paper apply to ordinary furnaces chiefly?

Mr. Prichard—Chiefly to ordinary furnaces.

Mr. Armington—I ought to say further, in connection with this paper, I think myself there is a great deal to be learned with regard to the management of these furnaces. A short while ago, in talking with a very intelligent German, he made me quite angry with myself to think that we had totally lost sight of one important fact in combustion, but still one they had been applying in that country for thirty years. It was in regard to what is termed the drop-flue boiler. When we began to economize fuel, in respect to the making of steam, we were taking our heat, in the first place, and putting it through the large flues of the boiler, letting it then gradually ascend the flues until it discharged into the smokestack. After a while we became convinced there was a waste of heat in this practice to which we should not be subjected. From this we started out with what has since become known as the drop-flue boiler, or one in which the flame passes directly from the furnace into the back connection, rises at once to the top, and from thence is gradually forced down through each tube, being finally taken out at the bottom. We have entirely lost sight of that principle in heating retorts. Until very lately, as you quite well know, we have built our chimneys right on top of our benches; have allowed the heat to ascend and pass right

out, without paying any attention to it. If we had at that time adopted the plan of heating retorts as we heat boilers, our fuel account would have cost us much less than it did. I think it is the duty of every man who is heating a bench of retorts (if he cannot get along in any other way) to try the drop-flue principle by closing in his damper, so that when the sight-hole is opened the flame will just appear there, showing there is pressure at that point. Applying the principle to regenerative furnaces, you will be sure that your combustion is perfect, because there is no imperfectly consumed carbon which would otherwise pass out into the flues. As far as this paper is concerned, I think it is a very valuable one, and I believe that any engineer who has tried this experiment should pass an hour or two in carefully reading the paper and making notes upon it. I hope we shall have the paper published in full.

The President—It has been suggested to me that Mr. Nettleton has made some experiments with regard to steam. Is that so?

Mr. Nettleton—For the past year I have been using steam under the grate bars in addition to that evaporated from the water in the ashpan, and have found it a very decided advantage. The clinker produced now is very much less in quantity than before the steam was used; and what there is is very easily removed. The furnace walls burn away much more slowly; also, the labor of clinkering is very much lessened. Where formerly the grate bars were driven four times in 24 hours, and the furnace clinkered, now they are never driven; and instead the grate bars are shaken four times every day, and once in nine or ten weeks the furnace is entirely emptied, and the clinker broken down on top. The saving in iron for supplemental grate bars alone amounts with me to fully two tons a year, and that with but three benches in use in winter and two in summer.

Mr. Armington—if we take this paper as literally true, what our friend Nettleton says he does is to save a certain amount of iron which he used for grate bars—in so doing used from 2 to 4 per cent. of fuel which escaped up the chimney. Now which is the more valuable—the grate bars that he saves or the fuel that he uses?

Mr. Nettleton—I may add that since using steam I am making 75 to 100 feet more of gas per bushel of coke consumed in the furnace than I did before.

Mr. Prichard—It is hardly fair to attribute that to steam. That benefit comes from the better running of the furnace which he is using, and not from the steam alone. Perhaps if he did not use steam he could do better still. If he devised a sort of furnace by which he could do away with the use of steam entirely, and heat by the air admitted, he might claim that saving and 2 to 4 per cent. additional.

Mr. Nettleton—I presume that, theoretically, I could save some fuel by not using steam; practically, I am sure I could not. Occasionally in some furnace the steam is shut off—perhaps through the carelessness of the men—and immediately the furnace commences to clinker; and with me the formation of clinker means the destruction of the furnace. I am confident I could not hope to make a furnace last so long without steam as I can with it.

Mr. Sherman—What kind of furnace is Mr. Nettleton using?

Mr. Nettleton—It is the Dieterich furnace, enlarged. The original Dieterich furnace was 14 by 36 inches, and 3 feet deep. Those that I am now using are 24 by 36 inches, and 5 feet deep.

Mr. Sherman—Other members are using Dieterich furnaces; we would like to hear what they are doing.

The President—I think we can learn something about it from Mr. Stiess.

Mr. Stiess—I can say that my experience with the Dieterich furnace, in regard to burning up the grate bars, was not to the extent recounted by Mr. Nettleton, although in our practice we decompose a great deal of water in the ashpan. When we drive the secondary grate bars (twice in 24 hours) we have never experienced any very great trouble with clinker. Acting under the advice of Col. Stedman, I tried the experiment with steam in a crude way; but it did not give me the benefit I expected to derive, nor the benefit which my adviser derives from the peculiar way he uses steam in his furnaces. While I did not obtain any marked advantage from the manner in which I used the steam, still, while I did use it, it decreased the intensity of the flame at the very point of combustion. There are benefits to be derived from the use of a regenerative furnace, independent of the item of expense of grate bars. I do not think I have used more than a ton's weight of them in a year and a half; but still there is that trouble in regard to the burning up of the secondary grate bars. We use water in the ashpan, and I think I have to-day the same lower grate bars (those directly above the ashpan) that I had when we started the furnace—a year ago last August. It is only the secondary grate bars which are a source of expense. At the time that I used the steam we were not troubled with clinker at all; but in my experiments I found that the benefits to be derived by the intense heat which I could obtain in carbonizing the amount of coal which I could work off in the retorts, more than compensated for the expense of the secondary grate bars. I believe that Mr. Prichard is correct when his remarks are applied to the common furnace; but I do believe that if he were to ex-

periment with a regenerative furnace—either with the Stedman or the Dieterich—he would change some of his ideas with regard to using steam as a means of increasing the heat and the products of combustion. I have two furnaces now on the Dieterich plan, which have been in constant daily use for eighteen months; and were it not for the retorts in the benches which I must let down with the coming spring, I think they would continue for two years. I am ready to say that from the time the benches started for every day in the year and a half (not counting the missed charges, nor, in fact, any of the “outs” that you may name which are common and constant in gas works) that I have been able to produce over 9,000 cubic feet of gas per retort; and I consider the accruing benefits gained by use of the regenerative furnace will more than compensate for the extra expense of grate bar renewals.

Mr. Nettleton—Can we not hear from Mr. Wood, of Syracuse?

The President—Mr. Wood, we would like to hear from you.

Mr. Wood—I have paid but little attention to the theory of the matter which is the subject of this paper. At our works they do not give us much time for theorizing. Reverting to the common furnace, and to the dispensing with water in the ashpan, my opinion is that such practice is of very great benefit, and that we gain in fuel instead of losing it. The reader of the paper illustrates his argument by stating that shaking up the grate bars and thus depositing the hot ashes in the ashpan, causes a large volume of flame to issue from the chimney. That is always the case, and is but an indication that the momentary heat and fire is beyond the chimney capacity for carrying it off for the time being. If the experimenter will examine among his retorts, or in the fire-place at the same time, he will find very large and great increase of heat. In the ordinary furnace I think he will find it almost utterly impossible to keep up his heat without the presence of the water. From observation it would seem as if that water were decomposed and turned into hydrogen, or water gas, and consumed in the more intense heat in upper part of furnace. I do not agree with him that there can be a loss, but believe there is an actual gain. So far as regenerative furnaces are concerned, we have had but little experience with them. We have used the Stedman furnace for about two months, and I must say that the results thus far are satisfactory. We have had no destruction of grate bars, nor of the furnace; but very little clinker has accumulated; we have had only to clinker the furnace once in three or four weeks. Running it on a four weeks stretch we have found a trifling collection of clinker at about a foot above grate bars; but the accumulation was so soft that it could be easily dislodged. Clinkering once in three weeks we find little, if any, trouble from the accumulation above mentioned. The weight of water evaporated, according to the statement made by Mr. Stedman, when on his December visit to Syracuse, was about the quantity he has here mentioned—about one pound of water to the pound of fuel burned. This evaporation figure I give from memory. It appears that, upon introduction of the steam at the place noted, it is decomposed and does act somewhat towards reduction of heat intensity at zone of greatest combustion; but, then, if I may so say, having been converted into water gas, it is immediately consumed beneath upper portion of a body of intensely heated fuel, and a large addition to working heats is thereby gained. From a practical point of view, that desirable result appears to be secured. I think gentlemen who are operating with even common furnaces would be justified in asserting that there is actually a gain by burning this water gas in that way. I think it is the best way to use water gas. (Applause.)

The President—Mr. Slater, in your absence from the room the Association has debated the question of steam in furnaces, the effect of steam upon grate bars, and upon the heat produced. I think the Association would be glad to hear what has been your experience in these matters.

Mr. Slater—We have not used steam in our furnaces at all. We do use water in the ashpan.

[To be continued.]

[OFFICIAL REPORT.]

Papers Read before the First Annual Meeting of the Ohio Gas Light Association, with Discussions on Same.

FIRST DAY—WEDNESDAY, FEB. 18.—MORNING SESSION.

The first paper read was presented by Mr. Jos. Bate, of Tiffin, Ohio. It was entitled:

THE USE OF GAS STOVES AS A MEANS OF INCREASING THE CONSUMPTION OF GAS.

The author read as follows:

In response to the request of the Executive Committee, that I prepare a short paper on some subject, I have endeavored to show in the following lines how gas and gas stoves should be managed in order to best produce the result which is the subject of this paper.

It is within my remembrance as a gas man that gas stoves were considered a great novelty. Now there is no question but that they are an actual necessity in almost every household. Of course their use is limited to those peo-

ple living close to lines of gas mains; and it is the duty of every live gas superintendent to see that all those within the reach of gas have their attention called to the fact that gas is the cheapest and best fuel to use for cooking; and further, under certain circumstances, it can be used economically for heating.

This latter is the hardest point to prove, and can only be done where the gas companies are willing to sell gas for the lowest figure commensurate with a little profit. To introduce gas as a fuel the companies must proceed in an energetic and practical manner. Theory will not do here. The Superintendent is the man who should have this particular branch of gas distribution under his special control. He is the one who stands between the company and its consumers. He is the one (in small towns at least) whom everybody knows. He is looked upon as the authority in all matters pertaining to a supply of light, and (in this case) heat.

The consumer seldom comes in contact with the company, and to successfully introduce and push the use of gas as fuel the Superintendent should be a man of fair business address, and vested with full power to make rates according to the necessities of the case in hand. He should have the power to procure the best quality of stoves, and should take care to thoroughly test each style and make of gas stove in the market. Care should be taken to select stoves that are not only durable in material but tasteful in design; stoves should not be purchased at random. The various styles of burners should be carefully examined. The ovens should be especially looked after, as to proper size and capacity for retaining heat, and should be the most economical in consumption of gas. I am not advertising any make of stove; but there is a material difference in the various sorts now made and offered to gas companies. Having decided which is the best sort of stove (and there are several kinds equally good, though differing somewhat in style), the Superintendent should next exercise a little judgment as to those of his customers he shall first approach on the subject. He must be able to prove to them that a gas stove has a much larger capacity for cooking, and takes up less floor space, than the ordinary coal, wood, or gasoline stove. If a reasonable price can be fixed for gas, the Superintendent can safely assure his customer that it is cheaper than coal or wood; much cleaner, more easily managed, and “altogether lovely, and not likely to fade away.” As to a comparison in cost of running against a gasoline stove, he may find himself at fault, if he assert gas is the cheapest simply in dollars and cents; but the difference in safety, cleanliness and smell, more than makes up for the slight difference in cost. Having made this impression on the mind of the average housekeeper, he must next be able and willing to set up the stove, in a convenient position, at the least possible cost for fitting.

This latter must always be done by the gas company at about net cost. It will never do to intrust this matter to the resident gas fitters doing business independently of the company. The work must be done neatly, and in such manner that leakage is next to impossible. The connection immediately at the stove must be a nice piece of lead pipe of sufficient length to enable the housekeeper to move the stove enough to get at the floor underneath when desirable. Care should be taken to have this lead connection of such size as will admit a full and free supply of gas to the stove— $\frac{3}{4}$ -inch to $\frac{1}{2}$ -inch pipe will answer for a good-sized stove, or one such as will do the cooking for a family of 20 people. A “No. 9 Economy” stove, or “No. 8 B, Goodwin” make, will easily do this. A stopcock should also be placed on the connection within easy reach of the person operating the stove; this to be independent of the regular stops on the stove burners.

After setting the stove care and patience should be exercised in instructing the consumer how to use it. And at any time the Superintendent or his assistant should answer calls personally when complaints are made of any trouble connected with the use of stove.

I will say here that in all cases the air chambers of stove burners must be kept clean and open. I have known great complaint to be made of excellent stoves because the user was ignorant of the fact that the air in passing to burners had drawn in the dust and lint from carpet sweepings, thus obstructing the free passage of air to the gas, and causing it to smoke in burning. But once shown carefully, and the principle properly explained to them, the users of stoves seldom make a second complaint from same cause as before shown. So much for the stove.

The Superintendent must also have the power to sell the stove (after proper trial in all cases) for but slight advance, if any, over net cost. It is not worth while to try to make a profit on the sale of a stove. Once in use and satisfaction given, the gas stove becomes a most excellent promoter of the consumption of gas, and a consequent steadily increasing sale of gas with reasonable profit is the result to the company.

Where large use is made of stoves a proper system of discounts on the special rates already given is very beneficial, and the gas companies need have no fear of consequences in this case.

Let a consumer understand that you are really offering a cheap and excellent fuel, and he or she will use it freely. We need not confine our attention solely to cooking stoves. In the office of the gas company there should be

proper samples on exhibition of heaters for bedrooms, bath and office use. If care is exercised in the selection of these they can be as readily sold as cookers. Also tailoring iron heaters are very salable; and once in use in the shop they will never be discontinued.

The summer consumption of many consumers can thus be made to overrun the winter use of gas, in the majority of cases, where it is only used for lighting purposes.

Soldering furnaces and laundry rollers are easily sold; hatters' and dress-makers' irons are easily and well heated by placing on any sort of small gas furnace.

The time has passed for gas companies to sell their product for illuminating purposes only. Power, by the use of gas engines, can be easily and cheaply produced. Still, this latter source of consumption is not so easily introduced in many small towns, on account of the apparently high price charged by makers of this class of machinery. If they would endeavor to supply these proportionately as cheap as the stove makers offer their goods, the work of introducing them would be greatly facilitated. Still, once in use, the gas engine becomes a fixture. The foregoing, with exception of engine use, is written from personal experience. Four years ago it was considered by our company as hardly worth the trial to place gas stoves before our customers.

It was also believed that these articles would meet with readier sale if handled by the regular stove and tinware dealers of our town. An effort to induce these persons to carry and offer for sale a supply of gas stoves soon proved the fallacy of such reasoning. The gas company then took hold in earnest, and to-day have no cause to regret their action.

Our receipts have increased in a very healthy degree, and the demand for stoves is steadily growing. But we would suggest to our brother gas men—be careful and buy only the best and proper sized article. A gasoline stove of three burners, with portable oven, sells in stove stores for the same price that gas companies can offer their consumers a gas stove of twice the working capacity. You should also remember that an old gasoline stove can be readily refitted with gas burners; I have done this frequently, though I always endeavor first to sell a regular stove, because it is in the end the cheapest.

Our method has been to sell for net cost at start; and having fairly established the business, we can now sell at a little profit. Though this latter fact is due mainly on account of the stove makers having, during the last season, improved their wares considerably, and also lowered their prices.

Our friends—the electric light men—have kindly conceded to us the right to occupy this field, and in our own case at first did a little talking for us. They felt that having so long occupied the place as illuminators, we should not be entirely driven out of existence, because, as they declared, gas had some uses, and spoke of it, like the immortal *Toodes* denominated his wife's "coffin," "As a handy thing to have around the house."

Well, experience has proved the truth of this belief—for during the times when the great "light of the future" takes an occasional rest, the old-fashioned gas jet renders the darkness visible, and even disturbs the belief or faith some folks have in the wonderful radiance of the Edison 16-candle power incandescent lamp.

In closing this paper I would repeat—those of you who have not yet operated in this field should at once turn your attention to it; and you will not withdraw from it so long as a housekeeper can be found whose temper and pocket alike are sorely strained by using any other than a first-class gas stove.

Discussion.

Mr. E. McMillin—I will ask the gentleman if he has made any estimate as to what the probable increase of business has been from the use of gas stoves.

Mr. Bate—I have no exact figures to give in that respect. In our town, with about 380 consumers, we now have about 100 gas stoves in use. In all cases the gas accounts of those using the stoves have been increased from 100 to 200 per cent. With us the domestic use of gas reaches to almost one-third of our total consumption. At first the company was loath to consider the matter of introducing gas stoves. I found it was impossible to place them and charge the full rate of \$2.50 for the gas consumed. Then I offered gas for domestic purposes at \$2.25. I omitted to say that I expected a reasonable amount of gas would be used for fuel, and soon found that quite a number of people imposed on me by purchasing stoves, but their returns on meter showed little, if any, use of gas for fuel. After three or four months of this experience I made out their bills at the full price per thousand. Then disputes arose. In reply to their expostulations I said, "When I sold you that stove at cost I expected you to use it." Oftentimes the reply would be made, "I will use the stove or not, just as I see fit." This bickering went on for some time; but at the beginning of the next year I wrote out a little "dodger," which our collector distributed with monthly statement of gas consumed. The "dodger" stated that 1,000 feet monthly must be used to entitle the consumer to the discount—this in the meantime had been in-

creased to 50 cents, or a net rate of \$2 per thousand. I told the consumers that if they wanted cheap gas they must increase their use of it, so that we could afford to sell at low rates. The third year we allowed a still heavier discount to large consumers of gas for fuel. The plan has induced parties to use from 5,000 to 6,000 feet where 2,000 to 3,000 was formerly used. One man's account ran up to 8,500 feet. He said he was bound to get the highest discount that we allowed.

Gen. Hickenlooper inquired whether the consumer could not go on increasing his consumption to the point where he would get his gas for nothing. (Laughter.)

Mr. Bate said he drew the line at \$1.50—the rate for a monthly cooking stove consumption of 5,000 feet. Those using gas for illuminating purposes only were charged \$2.

Mr. Dittmar—I would like to ask Mr. Bate what sort of stove his company prefers to place in the houses of consumers.

Mr. Bate—That brings us face to face with our stove manufacturers. I speak honestly when I say my experience has led me to believe that the "Economy" is probably the most substantial stove, and the top burners are excellent; but I think the oven space is rather too small. Housekeepers have often said to me, "I like this stove, except that the oven is too small. I can bake only two pies at one time." I then had some extra trays made, in order to show that there was oven room enough for three pies. That pleased many; but in several cases complaint was made that the oven would not contain a pan large enough to bake extra bread loaves. I think the "Sun Dial" stove is about the same as the "Economy." A handsome new pattern of the "Sun Dial" has lately been brought out, and the listed price of same has been reduced. I have tried the "Retort" and "Sheldon" stoves, but do not find as ready a sale for them. The trouble with them is that the trivets on top of stove are apt to slip and upset. The Goodwin Company has latterly introduced still another new stove—one having an extra shelf in each top section, which adds materially to the size.

Mr. Dittmar—What stove gives the most general satisfaction?

Mr. Bate—I would not like to make a positive statement in regard to that. The "Economy" and "Sun Dial" run about alike. A good feature in the latter is the packing around the oven, by which the heat is materially retained.

Mr. Dittmar—You have never tested between those stoves to see which would consume the most gas?

Mr. Bate—I think the Goodwin stove is a trifle the more economical; but, as I said, the "Economy" and the "Sun Dial" are closely together.

Mr. Enfield—How did Mr. Bate introduce his stoves—by personal solicitation, by advertising, or both?

Mr. Bate—I do not believe much in the principle of advertising as applied to gas stoves—that is, in the daily or weekly papers—because in country towns the majority of papers circulate among farmers. In the daily papers I occasionally insert a squib calling attention to the gas stove; but I doubt whether it does much good. I have printed on the backs of the bills a notice that we have at our office a full assortment of gas stoves always on hand. The best advertising medium is afforded by the users themselves; when consumers have stoves set up in their houses they call in all the neighbors to make an inspection. I would talk to the ladies about the merits of the gas stove rather than to the men, because the lady folks are apt to understand the situation better.

Mr. Converse—I have had considerable experience in the matter of introducing gas stoves, and my acquaintance with the subject corresponds to that of Mr. Bate. In 1879 we commenced their introduction, and that year placed 135 of them. I loaded an express wagon with gas stoves; went to the houses of our customers, and requested the privilege of putting up a gas cooker. I said the stoves were not for sale; we only wanted a trial of them made; and our success was such that I do not think we had to take back half-a-dozen of the 135 so placed. Now, the gas stove business is uppermost in my mind. At present we have, in our small town, 245 stoves in use. Our customers are all well satisfied with them. We find that all the cooking, ironing and washing requisite in a family of 5 or 6 persons can be accomplished with a monthly consumption of about 2,500 cubic feet. We have set the "Economy," the "Retort," and one or two "Sheldon" stoves. I think they are all giving very good satisfaction. The "Economy" and "Retort" stoves do excellent work.

Mr. Reinmund—Do you scale your gas prices?

Mr. Converse—Our rate is uniform, at \$2 per 1,000. This has been a dull year, yet I found we had secured a very material increase of consumption (comparing months of June, July and August) over the preceding year. On the other hand (making comparison between the winter months of same years), the consumption showed a slight falling off. I firmly believe gas cooking stoves will in the future still more greatly increase our summer consumption.

Mr. Enfield said his experience went to show that it paid a gas company to advertise. He (Mr. Enfield) had always endeavored to connect his stoves

direct from meter by carrying the pipe along the joists of cellar top over to the kitchen. In all cases, where possible, he himself ran a straight half-inch pipe from meter. For all this fitting his company charged net cost.

Mr. Bate—I would like to ask Mr. Converse what size of stove he finds most acceptable to consumers?

Mr. Converse—We generally sell "Economy"—Nos. 6 and 7 Economy, and the No. 8 "Sheldon."

Mr. Bate—That is, as a rule, 3-burner stoves. When we began the sale of stoves I tried the "Economy," having two burners on top, with oven and roasting chamber. I thought they would meet with ready sale, since they had a greater capacity than the 3-burner gasoline stoves; but when people came to look at them they would not purchase because they were too small. We did sell a number of the 3-burner size, but afterwards we secured a quantity of American Meter Company's "No. 8" 4-hole stoves. In several cases people who had the small stoves exchanged them for the others. Now we purchase only the 4-hole stove. Their cost averages about \$25, and I find they sell more readily than any other.

Mr. Coverdale stated that all requisite cooking for his family (six persons) was done on a "No. 5," or "No. 6, Economy." One difficulty in the way of introducing stoves appeared to be that people did not know what they could accomplish with a small gas cooker.

Mr. Bate—A familiar complaint made by our consumers was that a large batch of bread could not be made on account of size of oven. Our company have adopted the plan, as to all new houses, of laying on especial pipe for gas stove supply, whether or not the householders desired to use the gas stoves. We put in a lead connection because people may want to scrub the floor space under the stove, and thus move it a trifle. Let them once know they can move it and probably they will never touch it; but when a stove is stiffly coupled they are always worrying because they cannot move it. Formerly most stoves had legs, but now some descriptions are made so as to stand squarely on the floor.

Mr. Thompson—I would like to say a word or two, as an individual, on the gas stove question. My family have been using a "No. 7 Economy" for a year. A point I desire to make about them is in regard to the comparative cheapness of their operation. Our bill for 1884, less ten days during the February floods, was \$22.50. That expense covered the entire culinary work of our family, which is small. My coal bills for same average length of time, when employing an ordinary coal-heated cooker, to do the same amount of work, varied between \$30 and \$35 per year. Now, that comparison is largely in favor of gas as against coal. The other comparisons, as to cleanliness, etc., you, of course, know. Sometimes I am told, speaking of suburban places, gas stoves cannot be sold, because consumers do not get gas at as cheap rates as those of Cincinnati. Now, as a general rule, where gas is cheap coal is also cheap, but dear coal also means high priced gas, making matters equal as to localities.

Mr. Bate agreed with Mr. Thompson, and said the average monthly consumption of a household for cooking purposes would be about 2,000 cubic feet. He found the people of his town said they could not have bought enough wood to do the requisite work for the price they paid for gas.

Mr. McLean stated that his company had a number of consumers who used gas for cooking purposes only.

Mr. Allison said that three years ago his company hired a long and narrow office room on the first floor of a building and used it as a storeroom. This room was then partitioned off into three apartments; a good cook—a woman—was employed and put in charge of the establishment. Her first move was to invite her lady friends to a lunch which was cooked on the gas stoves. Day after day she would thus entertain several parties. The women all went off pleased, talked to their husbands about the affair, and so got them interested. Every time our cook (she was saleslady too) induced a masculine visitor to partake of a lunch, prepared before him on one of the stoves, a sale was almost sure to be effected. We still keep the practice up.

Mr. Enfield said his experience with reference to connecting gas stoves had been the same as that of Mr. Bate. He found, to ensure a good supply of gas, direct connection must be made with the meter. He had sometimes connected a stove to a bracket. Remembered, for instance, where he had placed stoves in adjoining houses that were occupied by sisters. The houses were exact duplicates as to construction, etc. At first a stove was placed in one building merely as an experiment. A direct service pipe was run from the meter, and the apparatus gave very great satisfaction. The occupants of other house then desired to try one. It was put in without a direct supply pipe, and the folks could not get enough gas to maintain one burner, much less two. A distinct supply pipe remedied every difficulty. He remembered other instances in which like complaints ensued, and which were similarly quieted.

Mr. Bate—The reason why, in every instance, the service should be run to the meter is that, no matter how good a workman the gasfitter may be, he will probably have allowed some accumulation of red lead obstruction in the coupling or fitting. I have had to take down new gas fixtures within a few

days after they were put up. I told the fitters the trouble was simply that the gas could not find its way through the results of their negligence, and have received the reply, "Oh, no; it could not have been that; it was bad gas or a poor meter that was at the bottom of it." In some cases the sockets were cemented over with red lead.

Mr. Salter inquired what pressure Mr. Bate's works carried.

Mr. Bate—I never carry less than a 2-inch pressure. Selling gas stoves, I am bound to have pressure whenever people may need it. If I were to drop down to an inch pressure it might be done just at the time some house-keeper was engaged in her cooking, and dissatisfaction would arise. I believe in carrying just as high a pressure for gas stove use as for illuminating supply.

Mr. Coverdale—I would like to give my experience with gas stoves. I was interested in a gas plant in the South, and it was my opinion that the people there would not use gas stoves at all. My son-in-law was in charge of the works, and tried to convince me the South was just the place to introduce the gas cooker. At first I would not listen to it. Finally I said, "Go ahead, and try." He ordered specimens of different makes of stoves—the "Economy," the "McDonald," and the "Sheldon." On a certain date an advertisement was inserted in the newspapers to the effect that there would be a lunch at the gas office at a certain hour on such a day, and a general invitation was extended. I came on to witness the proceedings. A couple dozen spring chickens, and a goodly stock of other eatables, were purchased. On the day set for the "feast" my daughter was pressed into service; she set to work with a will—made and cooked jelly-cake, pies, etc., on the gas stoves. During that day, at one time, we had six 4-holed stoves at work, and at same time had fourteen lady visitors in the store, and not a single person objected to the heat. With the close of day we had disposed of fourteen ranges. Since then we have twice ordered stoves, until now we have out about 40. We have never taken a single stove out, unless perhaps it was to make the exchange of replacing a small one with a larger size. Our price for gas is \$2, both for cooking and lighting purposes. One month we carried a pressure of 24 tenths. I found our leakage account swelled too rapidly. They tried to convince me that it was necessary to have 24 tenths pressure; I said, then we had better not encourage the use of gas stoves. I advised keeping the pressure down, and noting what difference was so made. We decreased the pressure to about 12 tenths, and never received a complaint from users of stoves. We have consumers employing gas cookers who do not burn any gas for illumination. All that is required to encourage the employment of gas cookers is a reasonable effort on the part of the fraternity. Success is certain. I believe advertising, while good and beneficial, will not be as successful in this matter (speaking as to small towns) as personal effort made by solicitation. In very large towns you could not, of course, follow out the latter practice very well. Of course we all know that day consumption is a great thing for small gas works. I think the gas stove business is sure to be one of the best means for increasing the gas consumption of our lesser towns. We keep all sorts of gas stoves on hand, and have never had occasion to remove one from the house in which it was put up. Among our consumers a good argument for the gas stove is this: In the South a coal cooking stove, on account of the heat it throws off, is located in that part of the kitchen as remote from the dining and sitting rooms as is possible; consequently the mistress of the household does not see it very often, and she allows the cook to "run the kitchen." Now, I can say to the mistress, "If you put in a gas stove you can save (owing to personal supervision over the 'help,' made possible and easy by the absence of fatiguing heat) the cost of the gas that will be consumed by it;" closing the argument by saying that I can put up the gas stove, should she see fit, just as well in her sitting room as in the kitchen, and that its presence need never be offensive. We should do everything we can to encourage this stove business; and I believe we should talk freely here among ourselves as to the merits of the various stoves now in the market; to the end that we may determine which sort is the best for our companies to purchase, to say nothing about the fact that the description best liked by ourselves will be best appreciated by and most beneficial to our consumers.

Mr. Robinson—In view of what has been said about gas stoves, I would like to say a word or two about our experience while introducing them at Columbus, Ohio. I think our President (Mr. P. W. Huntington) is a pioneer in the matter of introducing a gas stove into his kitchen. For a long time it seemed as though our efforts would be fruitless. I advised all my personal friends as to the advantages of gas cookers, and let them know that the company carried a most varied assortment of sizes and styles. I further advised purchasers to procure a large sized stove. Why? Because if the cook only wanted to make tea, she need light but one burner; if she desired to cook dinner for a number of persons, the large apparatus afforded opportunity to do the work satisfactorily. After a while we were quite successful in the matter of inducing our consumers to buy gas cookers. With reference to point of supply and size of pipe, I told our gasfitters they should always run a ¾-inch pipe direct from meter to stove. This instruction was given

because we do not run under a high pressure in daytime, and we did not want to be required to overcome any friction as to delivering gas to stove burners. I claim that if you have a good diameter to supply pipes you are certain to get a sufficient pressure. I think if Mr. Bate will put in $\frac{3}{4}$ -inch instead of $\frac{1}{2}$ -inch pipe he can work under $1\frac{1}{2}$ inch pressure instead of 2 inch, and so lessen his leakage—if he has any; and most gas companies do. I make large connections; it costs but little more. I am an advocate of large stoves and ample connections.

Mr. Bate—I spoke about a two-inch pressure. In our town we are differently situated from many others. We have a larger mileage of mains than obtains in most places of similar size, owing to numerous extensions supplying street lamps only. We have 14 miles of mains; and our town has but a population of 10,000 inhabitants. In isolated instances an occasional gas stove will come into use at a point where $1\frac{1}{2}$ -inch pressure would perhaps not give a good result. When I set up a gas stove I want no failure to be made with it.

Mr. McMillin—I would suggest that this question of pressure might be overcome by putting on an automatic governor—one which will put the pressure on when it is needed and take it off when not needed.

Mr. Connelly—There is a difference of opinion as to the pressure absolutely necessary in order to get satisfaction from gas stoves. Some say twenty-tenths is required at their works, and again the statement is made that, at other places, ten or twelve-tenths is sufficient. From the fact that in many localities perfect satisfaction accrues from the lesser pressure, I incline to the idea that most works now carrying 20 to 24-tenths could obtain satisfactory results from ten-tenths, urging the fact, in support of that idea, that the mains are not taxed during the day, and taking for granted the supply pipes from meter to stove are sufficiently ample. I would like to hear from some of the gentlemen who have made experiments in that connection.

Mr. Fullager stated he had obtained perfect satisfaction from an initial pressure from the works of twelve-tenths.

Mr. Coverdale's experience coincided with that of Mr. Fullager.

Mr. Converse said thirteen-tenths was ample in his case.

Mr. Enfield said his experience had been that an average of fifteen-tenths was quite sufficient. He thought most stoves were designed to work under ten-tenths; but if such a low initial pressure were carried by a works, he feared that too considerable friction would have to be overcome. It must be remembered that the conduits in many towns had insufficient diameters for the carrying duty exacted from them. Did they carry only ten-tenths they were running the risk of giving an insufficient supply. He had known consumers to complain they could not cook quickly enough with their gas stoves—that it would take too long to broil a steak, etc. He had found by carrying fifteen-tenths he could get sufficient pressure, no matter where the stove was located.

Mr. McMillin thought that it would not be possible to establish a rule that would apply to all places. The day consumption in Columbus was occasionally as great as the night consumption. If ten-tenths were satisfactory at Columbus, it did not follow that a like pressure would do in other places. In Columbus they carried from fourteen to fifteen-tenths, sometimes getting along with thirteen.

Mr. Huntington, speaking now as a gas consumer, said for about five years every pound of food cooked in his house had been cooked on gas stoves. From his experience he knew that the gas stove saved dirt, time, and dollars.

Gen. Hickenlooper—It may be proper for me to say something about our experience in Cincinnati, Ohio, where we have put out between 2,200 and 2,300 stoves. We adopted the policy of advertising their merits on the backs of our bills. The character of the advertisement was the certificate of indorsement of the parties who were using, or had been using, the stoves. We obtained from the users a certificate setting forth the advantages of the stove, together with their opinions as to the merits and economy of gas cookers. Without a single exception I believe these were favorable. We compiled the opinions in proper shape, and would publish a series of them, perhaps half-a-dozen each month, keeping on as long as the list lasted. We advertised in the public prints to some extent, often embellishing the "ads" with "cuts" of the stove. On one occasion we simply said: "Refer to the following parties," giving a column of names of parties who were using the cookers. In the matter of selling stoves we deem it better policy to encourage the opening of a separate and independent store in the city where can be found anything in that line. Our agent also adopted a system similar to that practiced by sewing machine agents; that is, purchased a horse, harnessed it into a nice carriage, and employed a clever woman, who was instructed to call at the residences of the ladies who had purchased stoves, and inquire whether the cookers were performing satisfactorily; if they were not working properly, she would name a time to suit their convenience when she should call and make investigation of the trouble. At the appointed hour she would be present and do that which she was certainly capable of doing—demonstrate that the stove would do all that had been represented it would do.

The pressure given by the Cincinnati company is about 2 inches. I do not know that we have had many complaints as to lack of gas supply; but wherever complaint did arise it could, no doubt, be traced to the fittings. In such cases an independent line, run from the meter, ought to remedy the trouble. I know of but two cases in Cincinnati where consumers use gas in cooking apparatus, and do not use gas for illumination.

MEMBERSHIP LIST OHIO GAS ASSOCIATION.

Honorary Member.

Prof. S. H. Douglas, Ann Arbor, Mich.

Charter Members.

- *J. Anderson, Columbus.
- *W. T. Bowers, Hillsboro.
- *A. S. Bushnell, Springfield.
- *C. M. Converse, Delaware.
- *E. S. Funnell, Albany, N. Y.
- *John Fullager, Cincinnati.
- *R. P. Green, Columbus.
- *A. Hickenlooper, Cincinnati.
- *P. W. Huntington, Columbus.
- J. A. Harris, Philadelphia, Pa.
- R. Lee, Piqua.
- M. McMillin, Marietta.
- W. A. McDonald, Albany, N. Y.
- *E. McMillin, Columbus.
- *W. W. Prichard, Ironton.
- J. A. Reynolds, Canton.
- *H. Ranshaw, Cincinnati.
- F. A. Stacey, Chillicothe.
- D. C. Spinney, Dayton.
- *H. C. Thompson, Cincinnati.
- *C. H. Welch, Athens.
- *M. C. Allison, Xenia.
- *Jos. Bate, Tiffin.
- *R. T. Coverdale, Cincinnati.
- *J. S. Connelly, Pittsburgh, Pa.
- F. Fabing, Fremont.
- T. W. Foley, London.
- *E. Gwynne, Springfield.
- *G. S. Harris, Mansfield.
- *E. W. Hamlin, Wilmington.
- Jos. Light, Dayton.
- *J. McCann, Portsmouth.
- *J. M. McLean, Washington, C. H.
- E. D. Moore, Circleville.
- *E. Printz, Zanesville.
- *A. B. Robinson, Columbus.
- *H. J. Reinmund, Lancaster.
- *J. B. Smallwood, Baltimore, Md.
- *G. H. Tayler, Warren.
- J. H. Walker, jr., St. Louis, Mo.
- *H. Wilkiemeyer, Lancaster.
- T. Wood, Sandusky.

Members admitted at First Annual Meeting.

- *F. Bate, Galion.
- *I. Butterworth, Columbus.
- M. Coombs, Youngstown.
- *T. E. Connelly, Pittsburgh, Pa.
- *J. Dell, St. Louis, Mo.
- *W. Enfield, Columbus.
- *J. J. Griffin, Philadelphia, Pa.
- *J. Gwynne, Fostoria.
- *N. Kinsman, Springfield.
- T. Kates, Cincinnati.
- J. H. Phillips, Cincinnati.
- *D. T. Roots, Connersville, Ind.
- A. B. Stannard, Philadelphia, Pa.
- *R. Salter, Covington, Ky.
- *G. Turner, jr., Cincinnati.
- *W. Blinks, M. City, Ind.
- T. Burch, Cincinnati.
- *A. D. Cressler, Ft. Wayne, Ind.
- *R. H. Canby, Bellefontaine.
- R. R. Dickey, Dayton.
- *R. A. Dittmar, Troy.
- *H. Felt, Cincinnati.
- *M. A. Germunder, Columbus.
- *J. L. Kelly, Middletown.
- N. G. Keenan, Cincinnati.
- W. A. Ross, Kenton.
- *W. S. Stacey, Cincinnati.
- *J. Salter, Covington, Ky.
- *J. S. Thomas, Wilmington.
- C. Taylor, Cincinnati.

* Those whose names are marked with an asterisk were present at Cincinnati meeting.

[To be Continued.]

The Dangers of Water Gas.

[A recent issue of the *Boston Medical and Surgical Journal* contains the following editorial comments on the conclusions so far arrived at by Profs. Sedgwick and Nichols in regard to their experiments on the death-doing capacity of water gas. It seems almost superfluous to call attention to the high standing enjoyed by the *Medical and Surgical Journal* among the scientific men of the Eastern States.]

"Considered as a sanitary matter, the manufacture and use of water gas for domestic purposes cannot be defended for a moment. On the contrary, every consideration of safety is opposed to the introduction of this dangerous agent into dwelling houses and public buildings. The source of the danger lies in the relatively great amount of carbonic oxide which is left in the product of the process of converting steam into gas by its exposure to incandescent anthracite. As is well known, carbonic oxide is of all gaseous poisons the most lethal; it kills as surely, if not as quickly, as hydrocyanic acid; and to admit it to inhabited rooms as an illuminating agent, under even more than ordinary safeguards against leakage, is an experiment the risk of which cannot be denied.

"These are trite sayings. Yet the energetic agents of speculative enterprises, eager to place their 'plant' and to make money out of the dear public, will declare that there is no danger in water gas worth mentioning. They catch the attention by emphasizing the economic side of the case, and by reiterating how cheaply they can supply the new article. They wish all statutory restrictions removed, so that, in the name of economy, they may make and send through our streets and into our houses an illuminating gas containing 30 per cent., more or less, of carbonic oxide. They grow hilari-

ous when their attention is called to the record of deaths by the accidental inhalation of the 'improved' gas in cities which have surrendered to their persuasive overtures. They declare that the coal gas ordinarily used for illuminating purposes contains carbonic oxide like their water gas, but that no one thinks of going back to whale oil or tallow candles through any apprehensions on that account. In short, they sneer at all the cautions which unprejudiced and unpurchased sanitary chemists have uttered since the composition of water gas was first appreciated, and they, in effect, ask the people to take a catamount or lioness into their laps to caress in place of the familiar domesticated animal which gives its name to the whole feline family. Sensible persons will hesitate before they try the experiment, and will choose rather to endure the gas they have than to fly to other gas four or five times more dangerous to life.

"These reflections are suggested by a report of recent investigations made under the instructions and direction of the Massachusetts Board of Health, Lunacy, and Charity, by Professors Sedgwick and Nichols, of the Institute of Technology, in accordance with an order of the Massachusetts Legislature. The report, though only preliminary to a fuller exposition of the subject after further experiments have been made by the authors, is very convincing. After a general statement of the nature and composition of illuminating gas, of which 'the only ingredient possessed of really toxic properties is carbonic oxide,' this being 'intensely poisonous,' the report presents a summary of the conclusions to which the authors have been led by their experiments. Of these we give a condensed abstract:

"1. Water gas is decidedly more poisonous than coal gas.

"2. An atmosphere containing a small percentage of coal gas may be breathed many hours without serious effect, while an atmosphere containing the same amount of water gas will be injurious and even fatal.

"3. On account of natural ventilation constantly going on in the rooms, thus permitting considerable diffusion, ordinary coal gas, containing about 7 per cent. of carbonic oxide, is not a source of serious danger; with water gas, on the other hand, on account of the large proportion (30 per cent.) of carbonic oxide, the danger line is easy to reach. And it must not be inferred that a gas containing twice as much carbonic oxide as another is necessarily only twice as dangerous. Water gas is not only in itself more poisonous than coal gas, but is also far more likely to produce injurious effects from similar accidental causes.

"4. Dogs, cats, rabbits, and pigeons did not show any symptoms of poisoning after exposure for many hours to an atmosphere containing one per cent. of coal gas, being apparently able to resist it almost indefinitely; but the same animals and birds when exposed, under the same conditions, to an atmosphere containing from one-half to one per cent. of the water gas invariably showed marked symptoms of poisoning at the end of an hour and a half, and death generally resulted after from five to eight hours of exposure to an atmosphere containing not more than one per cent.

"5. If, instead of comparing the effects of the same percentage of the two gases, we consider the *time* necessary to cause poisoning by the use of the same quantities of gas under the same conditions, we find a contrast not less striking. With water gas let into a chamber of known capacity (700 cubic feet) at the rate of six feet per hour, the animals under observation showed well-developed symptoms of poisoning in an hour and a half, and were all dead within eight hours. In a corresponding experiment with coal gas, a similar set of animals presented symptoms from which recovery would have been possible, and even easy, had they been set free; after twenty-four hours of continuous exposure, one cat and one rabbit were dead, but the other animals (dogs, cats, and rabbits) were not even unconscious.

"It cannot excite surprise that, after these results, the report should contain these words in its closing paragraph: 'Our opinion, based upon experiments, is decidedly averse to the general distribution of the so-called water gas.' Earnestly solicitous to promote all measures for public health and to oppose the advance, insidious or open, of all projects having a contrary tendency, we commend these independent and trustworthy observations of Professors Sedgwick and Nichols to the attention of our Legislatures, and hope none of them will be tempted by false doctrines or other considerations to rescind the wise provision which forbids the manufacture of gas containing more than ten per cent. of carbonic oxide."

[A Paper read before the Society of Gas Lighting.]

Petroleum and its Residuals.

By WM. FARMER, C.E.

During the year 1868 the writer was requested by Mr. Jos. Sabbaton, the Engineer of the Manhattan Gas Light Company, of New York city, to make a series of experiments on the coal and oil process, which was introduced by Mr. McKenzie, of Scotland. In this process a small proportion of the coal has to be pulverized for the purpose of absorbing the oil, and a certain proportion of the mixture is then mixed with the ordinary caking coal.

RESIDUUM AND CAKING COAL.

The caking coal which we used in the two following experiments was first tested, and the illuminating power of the gas therefrom was found to be 12 candles. The specific gravity of the residuum was 0.930; and accordingly one gallon of the residuum weighed 7.75 pounds. The gases were tested on the old Birmingham 15-hole Argand burner.

First Test.—With a mixture composed of 200 pounds of the coal and 10 pounds of the residuum, we obtained, with a dull cherry-red heat, in 3 hours and 30 minutes, 933 cubic feet of gas; or, in other words, one pound of the mixture produced 4.44 cubic feet of gas. The illuminating power of the gas therefrom, when consumed at the rate of 5 cubic feet per hour, was 17 candles. The illuminating power of the gas from the residuum may be now easily determined by the old rule of alligation, as follows:

	Pounds.		Candles.		Candle Feet.
Caking coal.....	200	×	12	=	2,400
Residuum.....	10	×	<i>x</i>	=	10 <i>x</i>
	210				10 <i>x</i> + 2,400
And	$\frac{10x + 2,400}{210}$		= 17 candles.		
			$10x + 2400 = 3570.$		
			$10x = 3570 - 2400 = 1170.$		
			$x = \frac{1170}{10} = 117$ candles.		

Accordingly, with a yield of 4.44 cubic feet per pound, the illuminating power of the gas from the residuum was 117 candles; and one pound of the residuum produced 4.44 × 117 = 519.48 candle feet. And one gallon (231 cubic inches) of the residuum produced 34.41 cubic feet of 117 candle gas.

Equivalents.

At 5 cubic feet per pound of residuum.....	101.89 candles.
" 6 " " "	86.58 "
" 7 " " "	74.21 "
" 8 " " "	64.93 "
" 9 " " "	57.72 "
" 10 " " "	51.94 "

These results would have been 12 per cent. higher if we had tested the gases on the burners used at the present time (1885); and still higher if we had used an exhauster.

Second Test.—With a mixture composed of 190 pounds of the coal and 10 pounds of the residuum, we obtained, with a cherry-red heat, 906 cubic feet of gas, or 4.53 cubic feet per pound of the mixture. The illuminating power of the gas therefrom, when consumed at the rate of 5 cubic feet per hour, was 16.70 candles. And the illuminating power of the gas from the residuum, when calculated as before, was 106 candles. Consequently we obtained 480.18 candle feet from one pound of the residuum.

Equivalents.

At 5 cubic feet per pound of residuum.....	96.03 candles.
" 6 " " "	80.03 "
" 7 " " "	68.59 "
" 8 " " "	60.02 "
" 9 " " "	53.35 "
" 10 " " "	48.06 "

As the illuminating power of the gas from the residuum was so very much higher than that recorded in the books of the Manhattan Gas Light Company, or in any other books, Mr. Sabbaton and I were very much surprised. As Mr. Sabbaton could hardly believe it, he laid the report before Prof. Torrey and Dr. Carl Schultz, for the purpose of getting their opinion on the methods by which these results were obtained, and they decided that the methods were correct.

CRUDE PETROLEUM.

During the year 1870 Mr. C. V. Smith, the late Engineer of the Manhattan Gas Light Company, and the writer made the following experiments with crude petroleum having a specific gravity of 0.800, and accordingly one gallon (231 cubic inches) of the oil weighed 6.37 pounds. The gas was tested on the Sugg standard Argand burner. In the three next experiments the crude oil was delivered through a wrought iron pipe into the rear end of the retort. In the following calculations the candle power of air is represented by the negative quantity —50; that of hydrogen and carbonic oxide by the negative —4.

First Test.—Three gallons, or 20 pounds, of the crude oil produced 283 cubic feet of gas (or 14.15 cubic feet per pound) in one hour with a cherry-red heat. With 50 per cent. of hydrogen gas, the illuminating power of the mixture was 25 candles; and the illuminating power of the gas from the crude petroleum was as follows:

	Cubic Feet.		Candles.		Candle Feet.
Oil gas.....	50	×	<i>x</i>	=	50 <i>x</i>
Hydrogen.....	50	×	-4	=	-200
	100				50 <i>x</i> - 200

And $\frac{50x - 200}{100} = 25$ candles.

50*x* - 200 = 2500.

50*x* - 2500 + 200 = 2700.

$x = \frac{2700}{50} = 54$ candles.

Accordingly, with a yield of 14.15 cubic feet per pound of the oil, the illuminating power of the gas therefrom was 54 candles. And one pound of the crude oil produced 764.10 candle feet.

Equivalents.

At 5 cubic feet per pound of oil.....	152.82	candles.
" 6 " " "	127.35	"
" 7 " " "	109.15	"
" 8 " " "	95.51	"
" 9 " " "	84.90	"
" 10 " " "	76.41	"
" 11 " " "	69.46	"
" 12 " " "	63.67	"

Second Test.—Three gallons, or 20 pounds, of the crude petroleum produced 186 cubic feet of gas, with a dull cherry-red heat, in one hour, which was equivalent to 9.30 cubic feet per pound. When 50 per cent. of air was mixed with the oil gas the illuminating power of the mixture was 21.95 candles. And the illuminating power of the gas from the oil was as follows:

	Cubic Feet.		Candles.		Candle Feet.
Oil gas.....	50	×	<i>x</i>	=	50 <i>x</i>
Air.....	50	×	-50	=	-2500
	100				50 <i>x</i> - 2500

And $\frac{50x - 2500}{100} = 21.95$ candles.

50*x* - 2500 = 2195.

50*x* = 2195 + 2500 = 4695.

$x = \frac{4695}{50} = 93.90$ candles.

Accordingly, with a yield of 9.30 cubic feet per pound of oil, the illuminating power of the gas was 93.90 candles; and one pound of the petroleum produced 873.27 candle feet.

Equivalents.

At 5 cubic feet per pound of oil.....	174.65	candles.
" 6 " " "	145.54	"
" 7 " " "	124.75	"
" 8 " " "	109.15	"
" 9 " " "	97.03	"
" 10 " " "	87.32	"

When 80 per cent. of hydrogen gas was mixed with the oil gas the illuminating power of the mixture was 15.64 candles; and the illuminating power of the gas from the petroleum, when calculated as per rule used for hydrogen before, was 94.20 candles. Accordingly, with a yield of 9.30 cubic feet per pound of oil, the illuminating power of the gas from the oil was 94.20 candles. And one pound of the oil produced 876.06 candle feet.

Equivalents.

At 5 cubic feet per pound of oil.....	175.21	candles.
" 6 " " "	146.01	"
" 7 " " "	125.15	"
" 8 " " "	109.50	"
" 9 " " "	97.34	"
" 10 " " "	87.60	"

Third Test.—Three gallons, or 20 pounds, of the oil produced 270 cubic feet of gas in 50 minutes, with a bright orange heat, or 13.50 cubic feet per pound. When 50 per cent. of hydrogen was mixed with the oil gas the illuminating power of the mixture was 16.89 candles; and the illuminating power of the gas obtained from the oil, when calculated by the rule as before given for hydrogen, was 37.78 candles. Accordingly, with a yield of 13.50 cubic feet per pound of oil, the illuminating power of the gas therefrom was 37.78 candles; and one pound of the oil produced only 510 candle feet. The heat in this case was too great for the supply of oil; and consequently there would be a great deposit of lampblack.

For the following test we increased the length of the pipe in retort, so that the oil would be exposed to about twice the length of that used in the previous tests before it reached the rear end of the retort.

Fourth Test.—Three gallons, or 20 pounds, of the crude oil produced 197 cubic feet of gas in one hour, with a dull cherry-red heat, or 9.85 cubic feet per pound. When 50 per cent. of hydrogen gas was mixed with the oil gas the illuminating power of the mixture was 25 candles; and the illuminating power of the gas obtained from the oil, when calculated by the rule before used for hydrogen, was 100 candles. Accordingly, with a yield of 9.85 cubic feet of gas from one pound of the oil, the illuminating power of the gas therefrom was 100 candles; and one pound of the oil produced 985 candle feet.

Equivalents.

At 5 cubic feet per pound of the oil.....	197.00	candles.
" 6 " " "	164.16	"
" 7 " " "	140.71	"
" 8 " " "	123.12	"
" 9 " " "	109.44	"
" 10 " " "	98.50	"

These results are 12.43 per cent. higher than those of the second test with shorter pipe.

NAPHTHA.

As I have never made any experiments with naphtha, I will take the reports of the water gas engineers of this city. They claim that 5½ gallons, or 30.18 pounds, of naphtha in every 1,000 cubic feet of the commercial gas is generally sufficient to raise the illuminating power of the water gas to about 28 candles. Consequently, at a yield of 10 cubic feet per gallon of 5.75 pounds, the yield from 5½ gallons will be 301.8 cubic feet. On this basis the illuminating power of the gas from naphtha, when calculated as per rule before given for hydrogen mixtures, is 102.24 candles. And accordingly one pound of naphtha will yield 10 cubic feet of 102.24 candle gas, or 1,022.40 candle feet.

Equivalents.

At 5 cubic feet per pound of naphtha.....	204.48	cubic feet.
" 6 " " "	170.40	"
" 7 " " "	146.04	"
" 8 " " "	127.80	"
" 9 " " "	113.60	"
" 10 " " "	102.24	"
" 11 " " "	92.94	"
" 12 " " "	85.20	"
" 13 " " "	78.64	"
" 14 " " "	73.02	"
" 15 " " "	68.16	"

These results are just 3.79 per cent. higher than those which we obtained in the fourth test from crude petroleum. This difference may be accounted for in two ways—viz., the naphtha may give a greater yield than that obtained from crude petroleum, or the process which they use may produce a greater yield than that which we used in the experiments.

CONCLUSIONS.

1. That 1,000 candle feet may be readily obtained from one pound of good naphtha.
2. That naphtha, at the present time, is the cheapest enricher that can be obtained in the market.
3. That naphtha may be converted into a fixed gas without depositing any of its carbon.
4. That naphtha should be distilled in very long retorts, or a series of them, where the heat is gradually increased from a very low heat to a very high one.
5. That the inferior gas, whether it be made from coal, wood, or water and carbon, should be run through the naphtha benches with the oil gas.

SPECIAL ENGLISH CORRESPONDENCE.

COMMUNICATED BY NORTON H. HUMPHRYS.

SHERBORNE, March 10, 1885.

The removal of Mr. G. Ernest Stevenson to the distant locality of Buenos Ayres is an event possessing more than a mere local interest. He has been Engineer, and latterly Engineer and Secretary, to the Peterborough Gas Company for some years, and the severance of these ties has been observed, in the usual manner, by the holding of a farewell dinner and the presentation of a handsome testimonial. In his departure to the well-known capital of the Argentine Republic, however, Mr. Stevenson leaves a vacancy that will extend much further than the surroundings of the Peterborough Gas Company, for he was a familiar figure at the meetings of the "Gas Institute," being a frequent contributor of papers, and a spirited participator in the discussions. His papers and speeches in connection with the subject of regenerative firing have particularly attracted attention. He was also President (for last year) of the Midland Association of Gas Managers. So his tempo-

rary exile will be regretted by a large number of friends and acquaintances, who will not fail to miss his familiar presence at our meetings of gas engineers; and will hope for the time when he will again return to take his place amongst us—I was going to say, a millionaire, but recollected in time how little chance we poor gas engineers have of attaining so enviable a position. The literal meaning of the name of the town selected for his new sphere of labor, I am told, is “pure air;” and it may be safely prophesied that during the time of his sojourn there the inhabitants will also enjoy the possibly less important, but by no means insignificant, advantage of “pure gas.”

The Metropolitan Board of Works, always peculiarly “fussy” over the various matters that come before them, and energetic in the interests they represent, having possibly become weary of costly electric lighting experiments, have now hit upon the pleasing recreation afforded by a portable photometer, with which to perambulate the streets and test the gas as supplied to the public at any consumer's house that may be selected. Since a regular system, controlled by the Gas Referees, a body appointed expressly for the purpose, exists with the object of daily examining the gas supplied from the various gas works in the metropolis; and as these gentlemen have under their supervision about a score of testing rooms, the various situations of which have been selected by themselves with a view of securing a fair average result, and from which returns are daily received, the necessity of the itinerant photometer is not very obvious. The gas companies of London may well think that no further extension of the gas testing system is needed; seeing that the sum that they have been called upon to pay during the past year for the expenses of the “official officers,” as Mr. Thompson Nash calls them—the gas referees who test the illuminating power, and the official auditor who examines the accounts—approach towards the substantial sum of £4,000. The advantage afforded by the peripatetic system of gas testing, as compared with the testing station situated as nearly as possible in the center of the various districts, is not very obvious to the professional gas engineer; though possibly it is very simple to that superior form of genius, conspicuous for glaring errors in respect to elementary details, which, emanating from the columns of the daily press and from the meetings of local authorities, so frequently aspires to direct the professional engineer as to the management of his own business.

At a recent meeting of the Metropolitan Board of Works the Special Referees and Sanitary Committee presented a report, setting forth that out of 55 examinations made with the portable photometer, in 24 cases the gas was found to be below the standard prescribed. And this portable apparatus is constructed and used, as far as possible, in accordance with the apparatus and method prescribed by the Gas Referees. Yet, at the period during which the above results were obtained, the Gas Referees were daily reporting that the gas was up to and usually well above the standard. It is also remarkable to notice that the 24 deficiencies are distributed, with tolerable impartiality, amongst the three gas companies supplying the metropolis. Two theories are available for accounting for this remarkable discrepancy. The first is, that continual trundling about the streets disturbs that sensitive condition of the photometrical appliances so necessary to the securing of accurate results; and the second, that peculiarly unfavorable localities were selected for some of the tests; such as taking the gas after it had passed through tortuous and long lengths of small pipes exposed to cold and damp, which might cause condensation and depreciation in quality. At present no advantage can follow from these results, because the portable photometer is not a legal instrument. But this new system, which may for distinction be called the “hole and corner” system of gas testing, finds favor with the committee; they consider it affords a better guarantee to the consumer than the system of fixed testing places. It certainly affords much greater facilities for finding fault with the gas companies. And so steps are to be taken to obtain the sanction of Parliament for adding the new plan to the existing legal tests. The variations afforded by the tests named in the report are noticeable; in respect to each company a range of two to three candles is recorded. No corresponding variation appears in the official returns.

From the above it appears that the portable photometer sometimes shows deficiency of some 10 per cent. or so against the gas; but this is nothing compared with what it does for the electric light. At the meeting of the Gas Institute, London, 1882, Mr. W. Sugg gave in the course of a paper entitled: “The Application of Gas to the Lighting of Open Spaces and Large Buildings,” some interesting results of observations with a portable photometer on the various electric lights then in use in the city of London, taken *in situ*, and these results showed that only a portion of the nominal illuminating power was actually given out in practice, a nominal 2,000-candle light only actually furnishing 400 or 500 candles, and so on. Mr. C. E. Jones, of Chesterfield, recently read, before the Midland Association, an interesting paper on “Progress in Developing the Illuminating Power of Gas,” and he included the results of observations *in situ* on some reputed 2,000-candle arc lights. The best result obtainable was 386 candles; others gave 289, 215, and 195 candles respectively. So it is much to be regretted that the Metropolitan Board had not obtained their portable photometer at the time when

the electric lights were about, as it appears that the results of a few observations on “the light of the future,” taken *in situ*, would have been interesting.

A report on the application for Parliamentary powers, in respect to gas and water supply, and to electric lighting, which will be brought before Parliament during the ensuing session, has just been issued by the Board of Trade. It sets forth that 45 bills and 17 applications for provisional orders, relative to gas and water supply, have been presented. There is only one application under the Electric Lighting Act, and this is from the Chelsea Vestry, who desire to raise and expend £66,000 in carrying out the necessary works for supplying electricity in their parish. The falling off in respect to electric lighting is instructive. In 1883 there were 106 applications, involving a capital of no less than two and three-quarters millions sterling; last year there were only four, with a capital of £60,000; and this year there is only the Chelsea Vestry, who evidently desire to experimentalize on a very extensive scale. They had better put their £66,000 in a safe place at moderate interest, and it will suffice to pay their gas bills for lighting the streets for many years to come.

But I do not know whether the fate of the Colchester installation may influence the Chelsea vestryman at all, since, before applying for the above powers, their surveyor (Mr. G. H. Slayton, Assoc. Mem. Inst. C.E.) visited Colchester for the purpose of examining and reporting upon the state of affairs after a three months' trial of the light, and also as to its future prospects; and that gentleman presented a succinct report stating that the practicability of house to house electric lighting had been successfully demonstrated, and that the light might reasonably be deemed a luxury, seeing that at the price at which it was supplied ($\frac{3}{4}$ d. per lamp per hour) the price was equivalent to 33 per cent. more than the gas. As the price of gas at Colchester is 4s. 6d. per 1,000 cubic feet, this would be equivalent to about 6s. per 1,000 cubic feet for gas. The illuminating power of the ordinary incandescent lamp ranges (in my judgment) from 10 to 16 candles; so, to allow a liberal margin, we may reckon one lamp for one hour as equivalent to 3 cubic feet of gas; and at the rate of 3 cubic feet for $\frac{3}{4}$ d. the cost of 1,000 cubic feet of gas would be about 14s. So it appears that the Chelsea gentleman would have been nearer the mark if he had added another 3, and said, “the price is equivalent to 333 per cent. more than the gas.” But as I might be considered a prejudiced witness, it will be better to quote from the *Electrical Review*, and that paper says: “It appears that the electric light experiment has turned out an utter failure. This causes us no surprise, for we have on several occasions remarked that scarcely any other result could be expected from an installation in which the number of lamps probably never amounted to 500, while less than 2,000 cannot pay.” The next paragraph touches the real cause of the failure, viz., the price; it is as follows: “The lamps used never apparently illuminated any other portion of the buildings supplied than the shops, the rate of supply, $\frac{3}{4}$ d. per lamp per hour, not being sufficiently tempting.” From an account recently presented at a meeting of shareholders in the Electric Light Company, it appears that the capital invested in the Colchester undertaking was £7,400, the working expenditure, not including depreciation, was £1,218, and the receipts £395. The system used involved the use of storage batteries and incandescent lamps, so the wear and tear must have been large; and the actual cost of providing the light, without including the interest on capital, cannot be put at much less than £2,000. It was estimated that if the whole of the 250 houses included in the district supplied took a reasonable number of lamps, a profit of 14 $\frac{1}{2}$ per cent. would have been earned; but how could any reasonable business man expect that any householder would be prepared to have the electric light all over his house at such a price. As it is, the company appear to have given up hopes of obtaining remunerative business, and are talking of winding up.

Some interesting information as to the cost of public lighting in some south coast towns was included in a report presented at a recent meeting of the Margate Town Council. In Margate there are 16 miles of streets, and these are lighted by 356 lamps, at an average distance of 80 yards apart, the average consumption per lamp being 5 cubic feet per hour, and the annual cost £1,382. Folkestone, with 26 miles of streets, has 704 lamps, which average 40 yards apart, and the annual cost is £2,841. Ramsgate has 29 miles of streets, lighted by 683 lamps, averaging 57 yards apart, at an annual cost of £2,080. There are 20 miles of streets at Eastbourne, and 700 lamps; the average distance apart is 50 yards, and the annual cost £3,757. In Hastings the lamps are 49 yards apart, 900 lamps being used to light 25 miles of streets, at an annual cost of £4,000. In the west end of London the average distance from lamp to lamp is 35 yards, and in the suburbs 44 yards. The towns above named are supplied with gas of about 16-candle power, at the following prices per 1,000 cubic feet: Ramsgate, 3s. 6d.; Folkestone, 3s. 3d.; Eastbourne, 3s. 9d.; Hastings, 4s.; Margate, 3s. 2d. It is only to be expected that statistics of the above character will differ considerably. The distance from lamp to lamp will be affected in a great measure by the total widths of the roads including footways; and also to some extent by the con-

tour of the roads, whether curved or straight, and by the number of crossings, etc. But after allowing for these, anyone who has casually visited several of our towns after nightfall will have recognized that a very great diversity of opinion appears to prevail as to the quantity of light requisite for the efficient illumination of a thoroughfare.

The gas stock and share market continues in a satisfactory position. Things appear to be quiet on the Stock Exchange, but prices are well maintained; at recent sales in the provinces the shares of provincial gas undertakings have without exception sold well, considerably over 200 per cent. having on many occasions been realized for shares entitled to 10 per cent. dividend. The products market continues very dull. There appears to be a better demand for sulphate, as indeed is usually the case at this season of the year, but prices keep about the same, viz., something less than £12 per ton. The market for tar seems to be in a similar condition, these being affected by the general quietness of trade in the country. But, as regards our main object, the demand for gas, I hear more satisfactory news. An increased demand appears to have been the general experience during the last two months, and, as a natural consequence, we may expect to see several important extensions carried out during the course of next summer. Already, at this early period of the year, gas exhibitions have been held in various towns, and others are announced; so this undoubtedly successful method of increasing the use of gas for cooking and heating may be expected to be as much in vogue during the forthcoming season as it was in 1884.

ITEMS OF INTEREST FROM VARIOUS LOCALITIES.

IT WAS NOT OF MUCH ACCOUNT AFTER ALL.—The daily press correspondents amused themselves, on a certain date toward the middle of last month, by formulating accounts of how the people of Decatur, Ill., were obliged to do without gas illumination during two entire nights, and assigned as a reason therefor that a very serious explosion had occurred at the plant of the Decatur Gas Light and Coke Company. Of course it would be a serious matter to the Decaturites were they obliged to dwell in a night illumination consisting of the brilliancy supplied either by "Standard water-white" or "eight to the pound superfine, hard tallow;" and they would undoubtedly be fit subjects for sympathy on the part of those who were enjoying the rays emitted from a well-regulated burner in its combustion of carburetted hydrogen. However, we communicated with Mr. J. W. Butman, Superintendent of the Decatur Company, in regard to the extent of the supposed disaster at his plant, and his response thereto informed us that the story was made up out of the fact that, after midnight of the date reported, one of the purifiers "blew out." On account of the lateness of the hour the valves to city supply were closed—simply because Mr. Butman knew that many of the inhabitants (especially the storekeepers) allowed one or more jets to be kept burning during the night and early morning. No damage was done to anyone or anything.

SOMETHING FROM LOUISVILLE, KY.—The opposition gas company at Louisville, Ky., began the delivery of gas to consumers with the first week in March. The old Louisville Company's alterations and extensions to plant have been completed and accepted, and the Board of Directors complimented the contractors upon the excellence of the manner in which the details of construction were carried out.

CHRONICLING SEVERAL CHANGES.—We have been advised of the following changes in Superintendency, etc., of the works named: Mr. N. W. Moore, formerly Superintendent of the Fairfield (Iowa) works, resigned that charge to take a similar berth at the Wyandotte (Kansas) Company's plant. Mr. Frank E. McMillin (nephew of E. McMillin) goes to Fairfield. Mr. C. D. Shreve resigned the Superintendency of the Sioux City (Iowa) works, and Mr. L. L. Kellogg, formerly Superintendent and Treasurer of Nebraska City plant, becomes Mr. Shreve's successor. Mr. John M. Murphy, late Treasurer of Sioux City Gas Company, becomes Superintendent and Treasurer at Nebraska City (Neb.) gas works.

CHEAPER GAS FOR TROY, N. Y.—The Troy Gas Light Company (Mr. F. A. Sabbaton, Engineer,) has made a reduction of 50 cents per thousand cubic feet in selling price. The reduction took effect on consumption registered on and after April 1st. New net rate is \$2.25 per thousand.

BARTLETT, HAYWARD & Co. TO BUILD THE HOLDER.—Messrs. Bartlett, Hayward & Co., of Baltimore, Md., are to build the new holder (152 ft. 6 in. diam.) to be erected by the Nassau (Brooklyn, N. Y.) Gas Light Company. Messrs. Freel and McNamee are to do the tank construction.

ELECTION OF DIRECTORS.—At a meeting of stockholders of Equitable Gas Light Company, of New York city, held Tuesday, March 17, the following gentlemen were elected to serve on the Board of Directors: Messrs. Eugene Kelly, Jacob D. Vermilye, R. M. C. Graham, E. J. Jerzmanowski, E. N.

Dickerson, jr., E. C. Benedict, J. Sloane, W. H. Gebhard, Jacob Bertschmann, Jerome B. Wheeler, Chas. F. Tag, Chas. M. Fry, and Samuel W. Boocock. Messrs. Fry and Boocock are new men in the Board.

CHEAPER GAS FOR SIOUX CITY, IOWA.—In a paragraph given above it is stated that Mr. L. L. Kellogg had recently assumed charge of the superintendency and treasurership of the Sioux City (Iowa) Gas Works; and he had hardly placed himself in working harness before the proprietors of the company enabled him to issue the following inaugural to the gas consumers of that city:

"In assuming the management of the gas works of this city I do it with the full hope that my dealings with you will be pleasant, agreeable, and mutually profitable. All complaints will have prompt attention, and it shall be the aim of both myself and the company I represent to give the citizens of this city the best possible service for the least possible money. Perhaps no other commodity that figures in your daily expenses has been so much reduced in price, during the last four years, as has been that of gas. The price is now much below that of many places in the State where the consumption is much larger. It is the intention of the gas company to rebuild a portion of the works this year, and to largely extend the lines of main pipe. Now, with a view of inducing a larger consumption of gas, and of affording more general consumption, the President of the company has authorized me to publish the following schedule of prices which will apply to all gas consumed from April 1st, 1885:

"For gas consumed, per 1,000 cubic feet, in any one calendar month:—All consumption under 1,000 \$2.70; 1,000 but under 2,000, \$2.60; 2,000 but under 3,000, \$2.50; 3,000 but under 4,000, \$2.40; 4,000 but under 5,000, \$2.30; 5,000 but under 10,000, \$2.25; 10,000 but under 25,000, \$2.20; 25,000 but under 50,000, \$2.10; when consumption equals 50,000 feet and over, \$2.

"The gross price will remain at \$3 per 1,000, and discounts will be made to the above prices when bills are paid upon presentation."

Pretty good sort of people you are with, Brother Kellogg, when they allow you to "inaugurate" after the above fashion, and loudly proclaim the establishment of a "tariff for revenue only." When Mr. Emerson McMillin obtained a controlling interest in the Sioux City Company (which that gentleman did in 1881) gas was selling, or rather the gentlemen previously in charge were trying to sell it, at \$4 per 1,000. "Mac" has not experienced any very great difficulty in running the consumption up to a point where it has become an imperative necessity to increase the capacity of the plant. That he is a firm believer in selling gas cheaply is best borne out by pointing to the prevailing rates at Columbus, Ohio, where he also "rules the roost." Then attention might further be called to other points where he acts as the "man at the helm."

MAKING THE NEW ORLEANS (LA.) TAXPAYERS SWEAT.—New Orleans usually basks in a temperature pretty near akin to that of perpetual summer, and bearing this in mind, one would not be apt to wonder that its residents should look upon an occasional outbreak of perspiration with rather an indifferent state of feeling. Still that is not the sort of "sweating" which is alluded to in this "item's" headline. Far from being in a moist condition as to the physical pores is the present condition of the New Orleans ratepayer to be attributed. His wallet is "sweating"—or being reduced in substance—all on account of the fact that he has chosen to represent him in the City Council about as graceless a set of scamps as was ever gotten together. In the first place, the Council has been itching for about a year to put through some sort of a general electric street lighting scheme. Its members have time and again broken faith with the New Orleans Gas Light Company; the provisions of the contract between the city and the company have been grossly violated, and, to cap the climax, they would not pay the company for the services that it had performed. All this wretched business, looking at it in a perfectly fair light, would seem to have been carried on simply for the purpose of forcing the gas company to shut off the supply to the city, and thus enable the Councilmen, under cover of the ill feeling so engendered, to achieve the electric lighting job they have so pertinaciously clung to. So far their scheme has succeeded. The New Orleans Company refused to furnish gas, and the city was left in darkness—at least such is the information we get from what appears to be a trustworthy source—and now the city is to be lit with electricity. As a sample of what these Councilmen may be trusted to accomplish before the end is reached we might just here state that they promised to light the outlying districts of the city (or the sections hitherto illuminated with oil lamps) at the same cost as before obtained. The amount available for oil lighting, according to balance in yearly budget, was about \$17,000; but the "representatives" have already located 34 towers, the maintenance of which will involve the certain expenditure of \$34,000, while it may also be asserted that the "locating" has but now rightly commenced. The New Orleans *Picayune*, in adverting to this matter, says: "Our readers can now comprehend more fully the real motive which actuated

many members of the Council in carrying on the contest with the gas company to a point which has left the city in darkness, and our people at the mercy of thieves, burglars and footpads." Will Mr. Victor Vallois, Secretary of New Orleans Gas Light Company, do us the favor of forwarding positive information in regard to this matter?

WHEN HIS TERM EXPIRES.—The term of office of Mr. F. Erhardt, now "New York State Inspector of Gas Meters," expires with midnight of April 18. Already are the political heelers "hot on the scent" for the position. It is not likely that anything we could say on the question will alter the determination that the politicians will arrive at; but we will take the opportunity to remind Governor Hill and the Senate confirming power that, while a man may be pretty well posted in the matter of bulldozing voters, it does not follow that he would make a good meter inspector. Perhaps the "Gas Consumers Association" could be induced to represent the importance of this matter before the Governor, although it is well nigh useless to expect the members of that "august assemblage" to take any steps which would be of real value to anybody.

A REDUCTION.—The Warsaw (N. Y.) Gas Light Company recently reduced its selling rates. We have not been advised as to the schedule made.

STRIKING GAS COAL MINERS.—The miners operating pits of the New York and Cleveland Gas Coal Company demanded that their remuneration be increased to three cents per bushel. The Company refused to accede to the request, and the mines were shut down on March 23.

THE EQUITABLE (N. Y.) GAS COMPANY'S OFFICERS FOR ENSUING YEAR.—In completion of the "item" (see forward) recounting election of Equitable Directors, it is noted that the Board organized with the selection of R. M. C. Graham as President; E. J. Jerzmanowski, Vice-President; J. D. Vermilye, Treasurer. The new Executive Committee includes Messrs. Kelly, Vermilye, Sloane, Benedict, and Boocock.

SUING A GAS COMPANY ON THE GROUND THAT AN ESCAPE OF GAS CAUSED THE DEATH OF SHADE TREES.—Mrs. Sarah King, who resides in the premises known as 385 Cumberland street, a very aristocratic locality in the "City of Churches," on date of March 11th brought suit against the Brooklyn (N. Y.) Gas Light Company to recover damages in \$50. The plaintiff asserted that company's employees, while engaged in laying a gas main, passing in front of her premises, had performed the operation with such negligence that the conduit, when put to the test of distribution, allowed gas to escape and permeate the soil to such an extent as to destroy two valuable shade trees, in the possession and observation of which she had often extracted much comfort. Judge Courtney, the clever judicial gentleman before whom the case was tried, was rather staggered when the testimony was "all in;" and well he might be after the examination of Mr. Henry Botcher (can't help wondering if he is related to Bottsford) had been concluded. Mr. Botcher, as an "expert" gardener, testified (he was "retained" by Mrs. King) that no one except the owner of the premises could put a value on the trees. Intrinsically he admitted that they were worth "about" \$10, but the real value was known only to Mrs. King—and, "by our faith," she put it high enough. Fifty dollars for ten dollars' "worth of trees" must have made Judge Courtney and President Armington incline to the view that the lady was seeking after "exemplary damages." Counsel for company moved for a dismissal on the point that the trees grew on a public thoroughfare and were public property. Decision was reserved for one or two days, at the end of which time Judge Courtney made short work of Mrs. King's arborical case by promulgating an opinion that while "she proved that the trees were dead, and that gas was escaping from the street main, she failed to prove that the leakage of gas had killed them."

NOW IT IS THE EDISON METER.—Much amusement has recently been caused in gas circles in New York city over a complaint made by the proprietors of a banking and brokerage firm doing business at 64 Broadway. Having been "robbed" by the New York Gas Light Company (so the head of the banking firm pleasantly put the case in the summer of 1884) long enough, he determined to save money by putting in the Edison light. August last the connections were made, and the electric illumination cost about \$5 for the first month's trial. That was a trifle less than the gas formerly cost. October's bill was "bigger by a dollar;" November beat October by a dollar; December outpaced November; January account was \$8.21; February, \$8.67. Too high for the banker. He said that all the movable Edison lamps were removed one day after receipt of February statement, and gas was again laid on to the premises. At about the right date in March along came a bill from the Edison Company (from Feb. 18 to March 19), amounting to \$9.29; and the financier naturally enough refused to pay it. We have heard so many "tough" stories told about gas meters and gas bills, and with not a particle of truth in them, that we will not say much about

this particular case—closing our reference to it by stating that the gas company is now doing the lighting at 64 Broadway. But we will mention a circumstance that does not speak volumes in favor of Mr. Edison's "patent meter," the truth whereof we can vouch to. A jobber in druggists' glass-ware and sundries, in the person of Mr. William Cagger, does business at No. 100 William street, this city. Mr. Cagger's storerooms are situated on second and third floors of this building. It is one of the old style of construction; the floor space is long and narrow, and the ceilings are low. There is no light shaft, and the only natural lighting means provided is that gained through narrow windows at front and rear. As a consequence artificial illumination must be more or less resorted to during the entire length of business hours. In the summer season the constant burning of one or two six feet per hour gas flames is not a particularly desirable practice to follow, having reference solely to the personal comfort of those whose duties compel them to remain in places like unto those above described. Mr. Cagger thought that he would make a trial of the Edison light, and the connections were made, lamps were put up, a meter was put in, and the lights were turned on. While he confessed that the illumination was not so good as that formerly obtained from the gas, he was inclined to believe that the temperature conditions were ameliorated. When the Edison company's agent was asked to supply the light he (the agent) made inquiry as to the number of lights that would probably be used, and the length of time they would be employed, etc. It seems to be a chronic failing with purchasers of artificial light to assert that their theoretical needs are far below their practical requirements, and Mr. Cagger proved no exception. His estimate of the number of hours of burning was put at a very modest figure. At the end of the first month, after the meter had been taken, the bill came in, and it rather proved to the delighted dealer in druggists' sundries that electric illumination was very, very cheap. The second month's bill was equally reasonable; but the collector inquired from Mr. Cagger whether (two lamps were in action) he "kept those burners agoing all through the day." Mr. Cagger answered: "Oh! not altogether." Two days therefrom Mr. Cagger was a trifle surprised at the conduct of a visitor to his storerooms. The stranger ran up the stairs, opened the half-glass door leading to the main room, poked his head in, gave a hurried look at the electric lamps (they were doing duty), and vanished. In a couple of days the same thing happened; and was repeated on a third and fourth occasion. At the fourth outset Mr. Cagger, being near the door when the "inspector" happened along, interrupted his departure with a shout of, "Say! what do you want?" In response he was greeted with, "Never mind; I have *seen* all that I *want*." Mr. Cagger's next bill for electric illumination was about 12 per cent. higher than the average run of the gas company's prior charges. Now we submit it looks as though this case does not offer much evidence as to the reliability of that famous measuring instrument devised by the erstwhile wizard of Menlo Park.

REDUCING THE PRICE OF GAS IN KINGSTON, CANADA.—Mr. John Kerr, Manager of the City of Kingston Gas Light Company, on date of March 25, 1885, was authorized by his Board of Directors to give notice to the consumers that on and after date of April 1st the following net prices would prevail:

A consumption under 5,000 feet per quarter.....	\$2.50 per M.
" between 5,000 and 10,000 feet per quarter.....	2.40 "
" " 10,000 and 15,000 " "	2.30 "
" " 15,000 and 25,000 " "	2.20 "
" " 25,000 and 40,000 " "	2.10 "
" upward of 40,000 feet per quarter.....	2.00 "

We believe the prior net rate was \$3 per thousand, and the above schedule will be noted as granting a good round concession to all classes of consumers. The gentlemen who have invested capital in the Kingston Company have been satisfied for years back with the low return of 5 per cent. for the use of their money, and so the charge of "excessive dividends" can hardly be urged against them by the "oppressed consumer." One most unfavorable circumstance connected with the company's operations is the fact that main excavations have to be made, to a very great extent, through solid rock. If the increased output ensuing as a consequence of this reduction be such as to justify the step, Mr. Kerr promises to attempt more experiments of a like nature.

A NARROW ESCAPE.—J. McLean, a lineman in the employ of the Toronto Electric Light Company, had an agonizing experience at an early hour on the morning of March 24. While another employee of company was lowering the lamp at corner of King and Princess streets to replace the carbons, the hoist rope broke and the apparatus fell to the ground. The conduit wire was severed, and all the lights on the circuit were extinguished. News was sent to shops of company, and McLean was detailed to repair the damage. Arriving at the wreck McLean seized the ends of the severed wire, and was instantly thrown to the ground. He was badly burned about the hands, and remained for several hours in an unconscious condition. He will recover. The accident was explained by the fact that after the current had been shut off from ruptured circuit some blunderer at the dynamo station re-established the connection.



A. M. CALLENDER & CO., PROPRIETORS.

Editor—JOS. R. THOMAS, C.E. Manager—C. E. SANDERSON.

THURSDAY, APRIL 2, 1885.

Gas Stocks.

Quotations by Geo. W. Close, Broker and Dealer in Gas Stocks (with A. E. SCOTT & Co.)

72 BROADWAY, NEW YORK CITY.

APRIL 2.

All communications will receive particular attention.

The following quotations are based on the par value of \$100 per share.

Table of Gas Stocks with columns for Capital, Par, Bid, and Asked prices for various companies like Consolidated, Central, Equitable, etc.

Advertisers Index.

Index listing various categories like GAS ENGINEERS, GAS WORKS APPARATUS AND CONSTRUCTION, GAS AND WATER PIPES, etc., with corresponding page numbers.

Index listing STEAM PUMPS, HYDRAULIC ELEVATOR, SHAFTING, PULLEYS, ETC., and HYDRAULIC MAIN.

Situation Wanted As Gas Manager.

Thoroughly experienced in the manufacture and distribution of gas. Unquestionable testimonials. Apply to "S. S.," 619 1t 833 North Rohey Street, Chicago, Ill.

SITUATION WANTED,

As Superintendent of a Gas Works.

A non-paying works preferred. Present position, foreman of a works making 60 million cubic feet per annum. Address 619 1t "G. W.," care this Journal.

WANTED, Second-Hand

Gas Works Apparatus.

Hydraulic Main, Dip, Bridge, and Stand Pipes for a bench of sixes; Four Purifying Boxes, with either 6 or 8 inch seal and connections. The material must be in good condition. Address 619-1f E. McMILLIN, Columbus, Ohio.

FOR SALE, One Station Meter,

Capacity, 500,000 feet. Four Purifiers, 16 ft. by 16 ft. by 4 ft., with trays, covers, carriages, and 10 in. connections complete.

One Dry 10-inch Center Seal, 10-inch Gas Valves, and Cast Iron Pipe.

All in good condition. Address E. McMILLIN, Columbus, Ohio.

WANTED AT ONCE,

A Second-Hand

Station Meter.

To register from 175,000 to 200,000 cubic feet per day; inlet nozzle not less than 8 inches; must be in good order. State price delivered in New York. State name of maker and length of time the meter has been in use. Address P. O. Box No. 24, STATION G., BROOKLYN, N. Y.

Appointment Desired,

By a graduate of the School of Mines of Columbia College, in a Water Gas Works

In or near New York city. Speaks English and German. Age, 22 years. Address O. BODELSEN, 618-4t 1072 Tenth Avenue, N. Y. City.

TO Builders of Gas Works AND GAS ENGINEERS.

THE CITIZENS GAS LIGHT COMPANY, OF JACKSON, TENN., are contemplating the enlargement of their works, and the changing of their process of manufacture to some one of the later and improved methods, and desire correspondence with parties who would contract for the work. Address J. W. ALLISON, President, 618-2t Jackson, Tennessee.

For Sale at a Bargain.

COMPLETE 4-INCH GAS GENERATING APPARATUS,

From our old works. Iron Frame for Roof; Mouthpieces, Stand Pipes, etc., etc.

Just the thing for adding to capacity of works already in operation, or for starting a new works. Address 616-8t GAS COMPANY, LIMA, OHIO.

FOR SALE,

100 MINER GLOBE STREET LAMPS.

The lamps have been in use, but only those that are in good order are offered for sale. For terms, etc., address
 THE NEW YORK & NEW JERSEY GLOBE GAS LIGHT CO.,
 615-4f No. 1 Park Place, New York City.

WM. FARMER, ENGINEER,
 32 Park Place, Room 36, New York.

THE CHEMIST'S ASSISTANT; OR, KINDERGARTEN SYSTEM OF CHEMISTRY.
 A system by which the elements and their valences are represented by illustrations and solid bodies.
 BOX AND PAMPHLET COMPLETE, \$2.50.

MITCHELL, VANCE & CO.,

MANUFACTURERS OF

Chandeliers

and every description of

GAS FIXTURES.

Also manufacturers of Fine Gilt Bronzes and Marble Clock warranted best time-keepers. Mantel Ornaments, etc.

Salesrooms, 836 Broadway, N. Y.

Special Designs furnished for Gas Fixtures for Churches, Public Halls, Lodges, etc.

Iron Sponge,

GAS EXHAUSTERS,
 AUTOMATIC GAS GOVERNORS,

CONNELLY & CO., Limited,
 No. 407 BROADWAY, NEW YORK CITY.

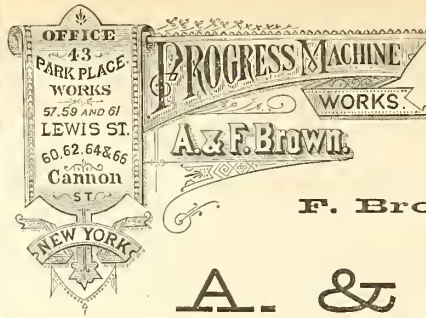

Shafting, Pulleys, HANGERS.

F. Brown's Patent Friction Clutch.
 Send for Illustrated Catalogue and Discount Sheet to

A. & F. BROWN,
 No. 43 Park Place, New York City.

Pipe Coverings.

Fireproof, Non-Conducting Coverings for
STEAM PIPES, BOILERS,
 And all Hot Surfaces.



Made in sections three feet long. Easy to apply; light and cheap.
 Asbestos Materials, Fibre, Braided Packing, and Cement. These goods are used at Continental Works, Br'klyn.
CHALMERS-SPENCE COMPANY, 419 & 421 EIGHTH ST., N. Y.

Parson's Steam Blower,

FOR IMPROVING BAD DRAUGHT IN BOILERS, AND FOR BURNING BREEZE OR OTHER WASTE MATERIAL.

PARSON'S TAR BURNER,
 FOR UTILIZING COAL TAR AS FUEL.

PARSON'S AIR JET TUBE CLEANER,
 FOR CLEANING BOILER TUBES.

These devices are all first-class. They will be sent to any responsible party for trial. No sale unless satisfactory. Manufactured by the WATERTOWN STEAM BLOWER COMPANY.

H. E. PARSON, Supt., 42 PINE ST., N. Y.

F. J. DAVIS & J. R. FARNUM,

TRUSTEES AND AGENTS FOR THE

SINUOUS FRICTION CONDENSER.

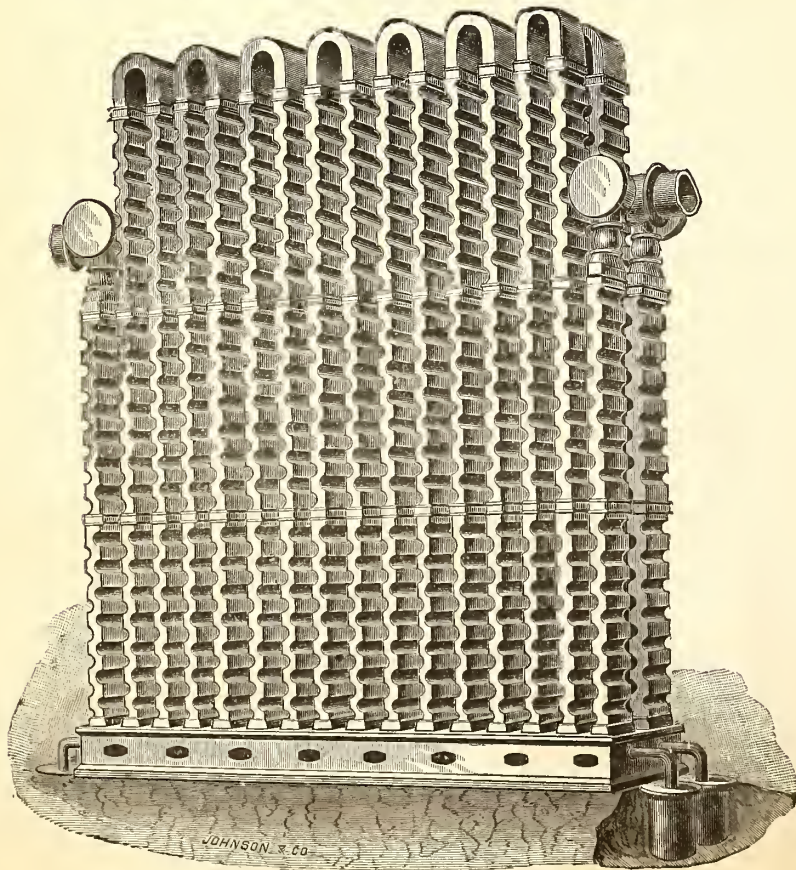

We desire to draw the attention of the gas community to the merits of the SINUOUS FRICTION CONDENSER. Companies intending to introduce new condensers into their works will do well to confer with us and examine plans and estimates before contracting for any other pattern. The FRICTION CONDENSER is now in use at the gas works located in the following places:

- | | | | |
|----------------------------|------------------|-------------------------------|---------------------|
| Portland, Me. | Brookline, Mass. | Pawtucket, R. I. | Frederickton, N. B. |
| Newport, R. I. | Chelsea, Mass. | Jamaica Plain, Mass. | St. John, N. B. |
| Gloucester, Mass. | Wohurn, Mass. | Attleboro, Mass. | Paterson, N. J. |
| Newton & Water-town, Mass. | Peoria, Ill. | Calais, Me. | Dover, N. H. |
| | Clinton, Mass. | Fall River, Mass. | Waltham, Mass. |
| | | Nassau Works, Brooklyn, N. Y. | |

DAVIS & FARNUM MFG. CO.

MANUFACTURERS OF

Gas and Water Pipes,

AND

GAS AND WATER MACHINERY

OF THE MOST APPROVED PATTERN.

Also, Gasholders and Iron Roofing.

Orders from Gas and Water Companies promptly attended to.

WALTHAM, MASS.

Boston Office, Room 55, Mason Building, 70 Kilby Street.

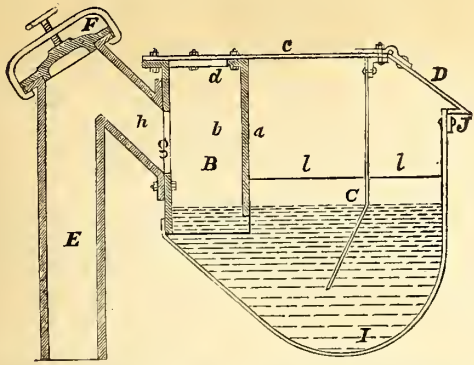

Boardman Hydraulic Main,
Patented October 7, 1884.

For description, see AM. GAS LIGHT JOURNAL of Feb. 2, 1884.
For terms, apply to

A. E. BOARDMAN, Macon, Ga.

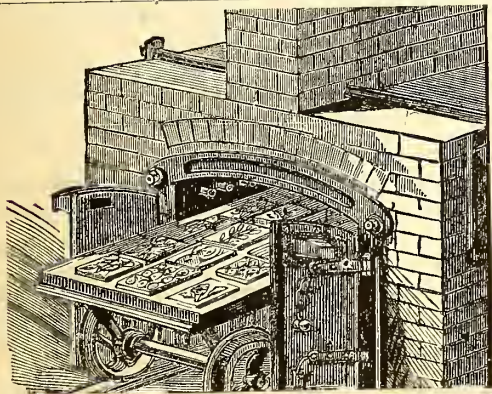

Glass-Staining Gas Kiln.
BAKERS' & CONFECTIONERS' OVENS (PAT.)
Thompson Gas Kiln & Oven Co.
59 Carmine St., N. Y.
Send for Circular by mail.

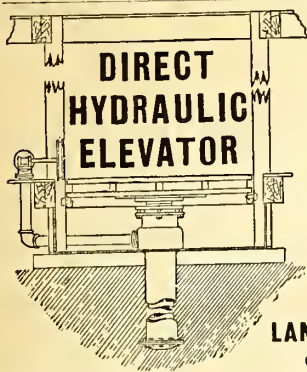

With Iron or Wood Platform.

Largely used by Leading Gas Co.s for Coal and Coke Lifts.

Adapted for use with city service, or special pumping and accumulator system. For prices address the

LANE & BODLEY CO.,
Cincinnati, O.

JOS. R. THOMAS, C.E.,

May be Consulted on all Matters Relating to Gas Works and Gas Manufacture.

ADDRESS THIS OFFICE.

The Management of Small Gas Works.

BY C. J. R. HUMPHREYS.

Price, \$1.

Orders to be sent to **A. M. CALLENDER & CO.,**
42 PINE STREET, NEW YORK.

C. BARCALOW, PREST.

J. V. BARCALOW, SEC. & TREAS.

BARTLETT
Street Lamp Mfg. Co.

MANUFACTURERS OF

Bartlett's Patent

GLOBE LAMPS.

FOR

Streets, Parks, Railroad Stations, Public Buildings, Etc.

LAMP POSTS A SPECIALTY.

Office and Salesroom,

No. 35 Howard Street, N. Y. City.

Gas Companies and others intending to erect lamps and posts will do well to communicate with us.

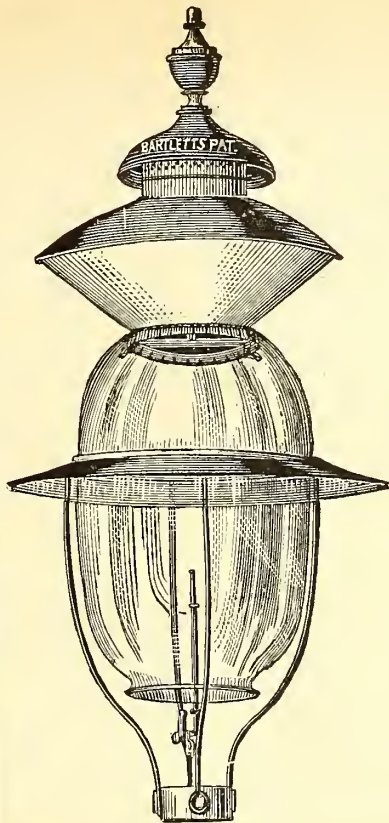

F. M. ROOTS.

S. C. ROOTS

D. T. ROOTS.

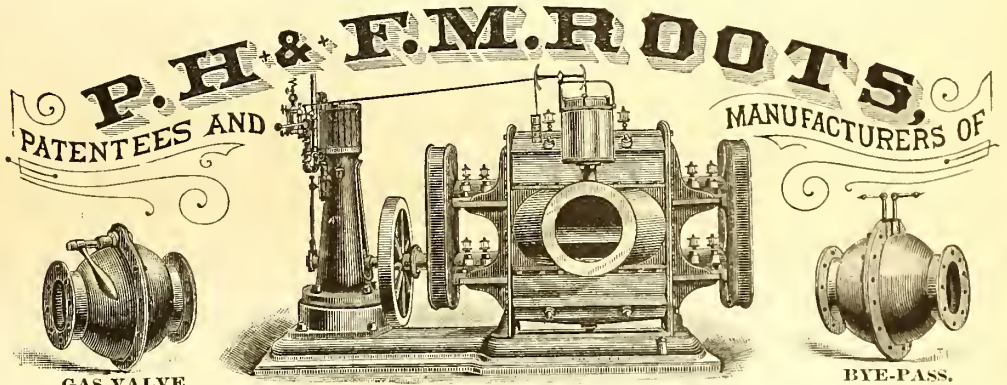

IMPROVED GAS EXHAUSTER,

WITH ENGINE ON SAME BED PLATE, OR WITHOUT.

BYE-PASSES, GAS VALVES, GOVERNORS, ELBOWS, PIPE-FITTINGS, Etc., FURNISHED TO ORDER.

P. H. & F. M. ROOTS, Patentees & Manufacturers, **CONNERSVILLE, IND.**

S. S. TOWNSEND, General Agent, 22 Cortland St. and 9 Dey St., N. Y.

JAS. BEGGS & CO., Selling Agents, 9 Dey St., N. Y.

COOKE & CO., Selling Agents, 22 Cortland St., N. Y.

❖ SEND FOR ILLUSTRATED CATALOGUE AND PRICE LIST. ❖

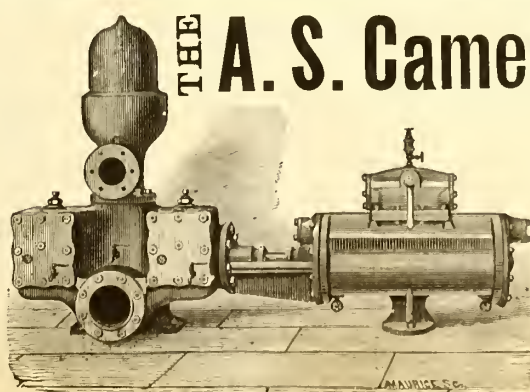

THE A. S. Cameron Steam Pump,

THE STANDARD OF EXCELLENCE.

Upward of 30,000 in Use.

BEST GAS WORKS PUMP
Ever Introduced.

Adapted to Every Possible Duty.

A.S. Cameron Steam Pump Works,
Foot East 23d St., N. Y.

J. H. GAUTIER & CO..
CORNER OF
GREENE AND ESSEX STREETS,
JERSEY CITY, N. J.
MANUFACTURERS OF

Clay Gas Retorts,
Gas House Tiles,
Fire Bricks, Etc. Etc.
Ground Clay, Fire Brick and
Fire Sand in Barrels,
J. H. GAUTIER. T. B. GAUTIER.
C. E. GREGORY. C. E. GAUTIER.

BROOKLYN
Clay Retort & Fire Brick Works,
(EDWARD D. WHITE & CO.)
Manufacturers of Clay Retorts, Fire Brick,
Gas House and other Tile.
VAN DYKE, ELIZABETH, RICHARDS & PARTITION STS.
Office, 88 Van Dyke St., Brooklyn, N. Y.

LACLEDE FIRE BRICK MFG. CO.,
MANUFACTURERS OF
Fire Brick, Gas Retorts,
AND
ST. LOUIS STANDARD SEWER PIPE.
Blast Furnace and Cupola Linings, every description of Fire
Clay Material, Fire Clay Flue Linings, Chimney Tops
Dry Milled and Crude Fire Clays, etc.
OFFICE AND DEPOT
901, 903, and 905 Pine Street,
ST. LOUIS, MO.

ESTABLISHED IN 1845.
B. KREISCHER & SONS,
OFFICE FOOT OF HOUSTON ST., E.R., N. Y.

Gas Retorts,
TILES, FIRE BRICK.
AND EVERYTHING IN THE FIRE CLAY LINE.

MANHATTAN
FIRE BRICK & ENAMELLED CLAY
RETORT WORKS.
ADAM WEBER.
CLAY GAS RETORTS
AND RETORT SETTINGS,
FIRE BRICKS, TILES, ETC.,
Office and Works, 15th Street and Avenue C., N. Y.

CHICAGO
Retort & Fire Brick Works,
OFFICE AND FACTORY,
Clark, Forty-Fifth, and La Salle Streets,
CHICAGO, ILL.
GEORGE C. HICKS, PRES. PAUL P. AUSTIN, SEC. & TREAS.
STANDARD
Clay Retorts and Settings.
BLOCKS & TILES
Of every Shape and Size to Order.
Standard Fire Bricks.

JAMES GARDNER, JR.
Works,
LOCKPORT STATION, PA.

—ESTABLISHED 1864.—
WILLIAM GARDNER & SON,
Successor to GARDNER BROTHERS.

WILLIAM GARDNER.
Office, COAL EXCHANGE,
PITTSBURGH, PA., P. O. Box 373.

Fire Clay Goods for Gas Works.

C. H. SPRAGUE, No. 70 KILBY STREET, BOSTON, MASS., Agent for the New England States.

OFFICE, 418 to 422 East 23d St., New York.

ESTABLISHED 1856.

WORKS, PERTH AMBOY, NEW JERSEY.

HENRY MAURER,
Excelsior Fire Brick & Clay Retort Works
CLAY GAS RETORTS, BENCH SETTINGS, FIRE BRICK, TILES, ETC.

STANDARD GAS RETORT AND FIRE BRICK COMPANY,
J. ANDERSON, Pres. & Mang'r. OF IRONTON, OHIO. C. PETERS, SECRETARY.
Clay Gas Retorts, Fire Brick, and Fire Clay Goods of Every Description.
Plans of Livesey-Somerville, McIlhenny, and other Furnaces, and Competent Workmen Supplied.



CINCINNATI
Gas Retort & Fire Brick Co.,
(ESTABLISHED 1872.)
CINCINNATI, OHIO.
Manufacturers of Gas Retorts, Retort Set-
tings, Fire Brick, Tiles, Etc.

OAKHILL
GAS RETORT & FIRE BRICK
COMPANY.
PARKER, RUSSELL & CO.
City Office, 711 Pine Street,
ST. LOUIS, MO.

Our immense establishment is now employed almost entirely in
the manufacture of
MATERIALS FOR GAS COMPANIES.
We have studied and perfected three important points. Our re-
torts are made to stand changes of temperature, the strongest
heats of the furnace, and the abrasion of feeding and emptying.
Our customers are in almost every State of the Union, to all of
whom we refer.

THOS. SMITH, Prest. AUGUST LAMBLA, Vice-Prest. & Sup
BALTIMORE
RETORT & FIRE BRICK CO.
MANUFACTORY AT
LOCUST POINT, BALTIMORE, MD.
Connection with the City by Telephone.
Clay Retorts, Blocks & Tiles,
FIRE BRICK, FIRE CLAY,
AND FIRE CEMENT.

Red and Buff Ornamental Tiles and Chim-
ney Tops. Drain and Sewer Pipe (from
2 to 30 inches). Baker Oven Tiles
12 x 12 x 2 and 10 x 10 x 2.
WALDO BROS., 88 WATER ST., BOSTON, MASS.
Sole Agents for New England States

THE AMERICAN METER COMPANY,

MANUFACTORIES,

512 West Twenty-second Street, N. Y. Arch and Twenty-second Street, Phila.
Nos. 244 & 246 North Wells Street, Chicago, Ill.

AGENCIES,

No. 177 Elm Street, Cincinnati, Ohio. Nos. 122 & 124 Sutter Street, San Francisco, Cal.
No. 810 North Second Street, St. Louis, Mo.

ALL SIZES
CONSTANTLY
IN STOCK.

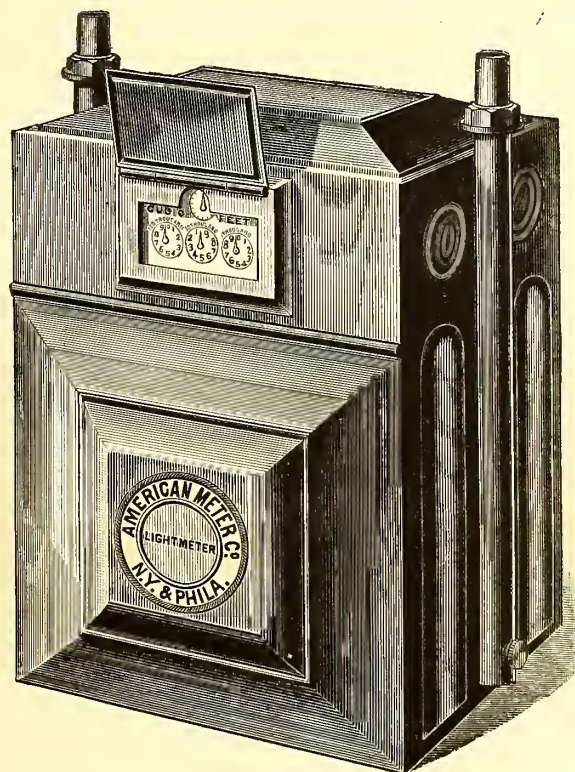

PRICE LISTS
ON
APPLICATION.

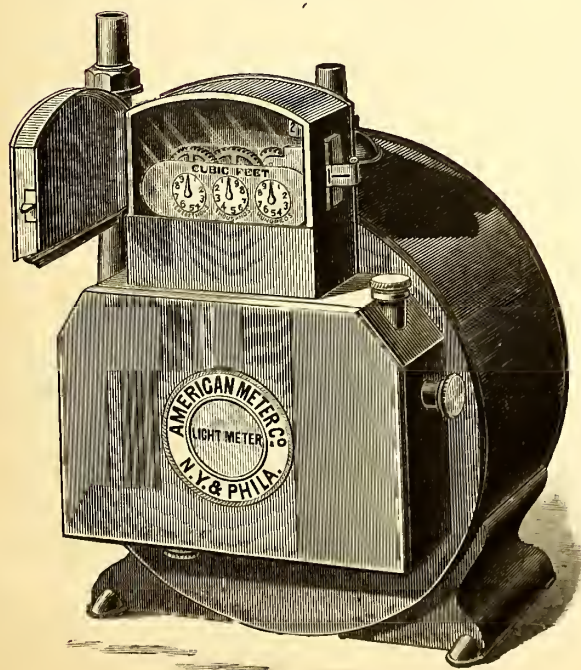

Mfr's of STANDARD WET AND DRY GAS METERS.

A. H. M'NEAL,

BURLINGTON, N. J.

Flange-Pipes

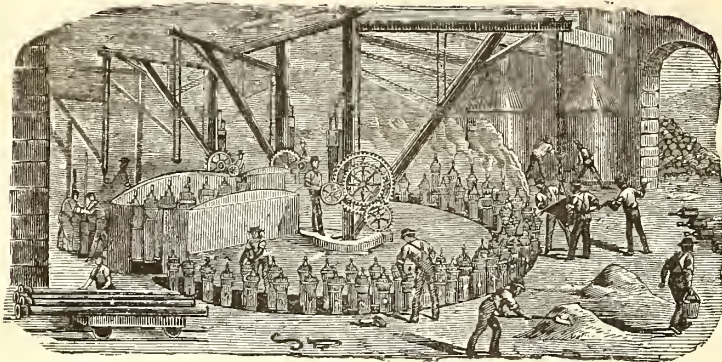

General Foundry Work.

CAST IRON PIPES FOR WATER AND GAS.

JAMES S. MOORE, Pres.
BENJAMIN CHEW, Treas.

JAS. P. MICHELLON, Sec.
WM. SEXTON, Supt.

GLOUCESTER IRON WORKS, GLOUCESTER CITY, N. J.

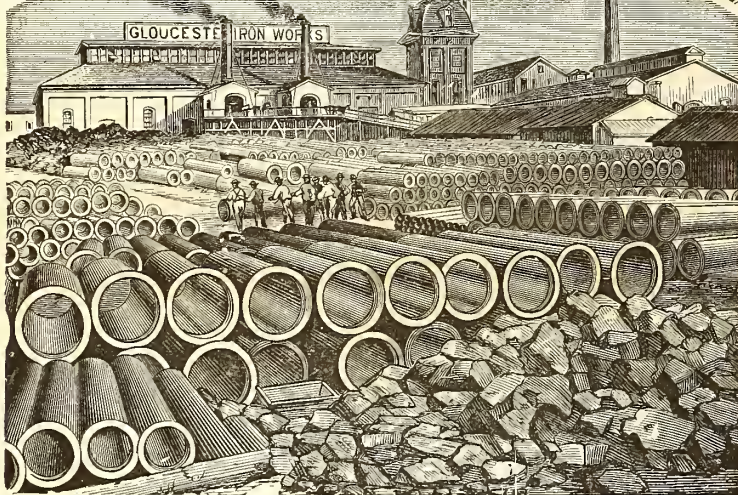

Cast Iron Gas & Water Pipes, Stop Valves, Fire Hydrants, Gasholders, &c.
Office No. 6 North Seventh Street, Philadelphia.

ESTABLISHED 1856.

WARREN FOUNDRY AND MACHINE CO.,

WORKS AT PHILLIPSBURGH, N. J.
NEW YORK OFFICE, 162 BROADWAY.

Cast Iron Water and Gas Pipe

FROM TWO TO FORTY-EIGHT INCHES DIAMETER.
ALSO ALL SIZES OF

FLANGE PIPE for Sugar House and Mine Work.
Branches, Bends, Retorts, Etc., Etc.

436-1

MATTHEW ADDY, President.

W. L. DAVIS, Selling Agent.

GEO. P. WILSHIRE, Sec. & Treas.

Cincinnati and Newport Iron and Pipe Company,

NEWPORT, KY.

Lamp Posts
AND
BENCH CASTINGS

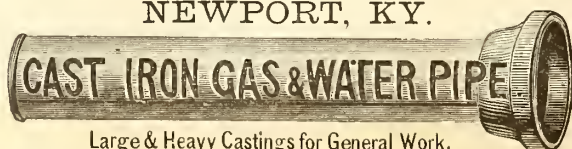

Branch
AND
SPECIAL CASTINGS

A Specialty.

Large & Heavy Castings for General Work.

FOR GAS & WATER CO'S.

Manufacture Pipe from 2 to 48 inches. All work guaranteed first quality.

Mellert Foundry and Machine Co. Limited. Established 1848. MANUFACTURERS OF



Specials—Flange Pipe, Valves and Hydrants,
Lamp Posts, Retorts, etc.
Machinery and castings for Furnaces, Rolling Mills, Grist and
Saw Mills, Mining Pumps, Hoists, etc.

GENERAL OFFICE, - - - READING, PA.

LUDLOW VALVE MFG. CO.

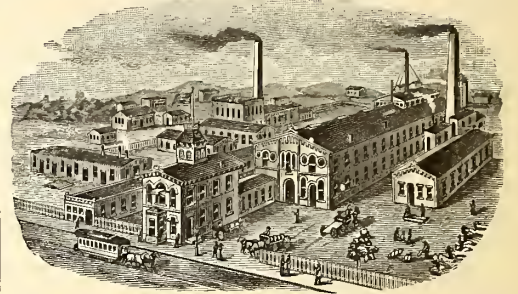

OFFICE AND WORKS,

93S to 954 River Street and 67 to 83 Vail Av.,

TROY, N. Y.

Hydraulic Main Dip Regulators, also
Check Valves, Foot Valves, Yard-
wash and Fire Hydrants.
Send for Circulars.

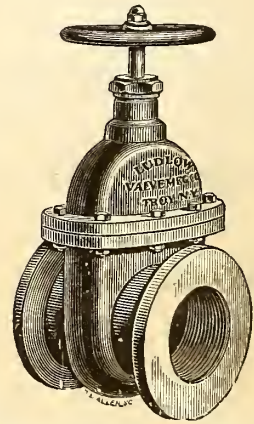

Valves.—Double and Single Gate, 1/2 in. to
48 in., outside and inside Screws. Indica-
tor, etc., for Gas, Water, Steam, and Oil.
Send for Circulars.

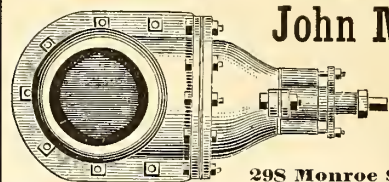

John McLean

Manufacturer of

**GAS
VALVES.**

29S Monroe Street, N. Y.

PRESERVE

The Journal

BY THE USE OF

THE STRAP FILE.

Advantages of the Strap File.

- 1st. It is simple, strong, and easily used.
- 2d. Preserves papers without punching holes.
- 3d. Will always lie flat open.
- 4th. Allows any paper on file to be taken off without disturbing the others.

Price, \$1.25. Sent either by express or mail, at directed. By mail the postage will be 20 cents, which will be added to the price of the Binder.

A. M. CALLENDER & Co., 42 PINE ST., N. Y.

Siemens's Regenerative Gas Burners, For Lighting and Ventilating.

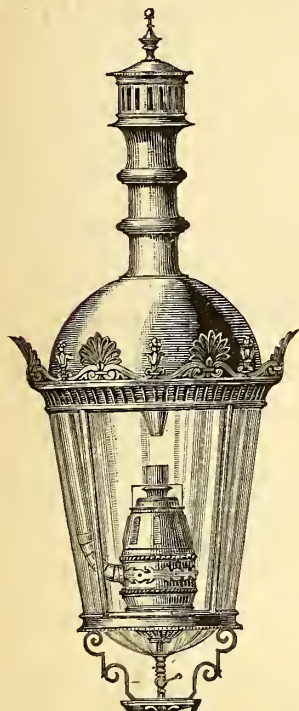

THE CHEAPEST, PUREST, AND MOST BRILLIANT OF ALL GAS LIGHTS.

Superior to the Electric Light in Economy, Beauty, & Steadiness.

SPECIALLY ADAPTED FOR LIGHTING HALLS, FACTORIES, OPEN SPACES, ETC.

Numerous Tests made by various Gas Companies in the United States show an Efficiency of Ten Candle Power per Cubic Foot of Gas.

General Agents:

- SIEMENS LIGHTING CO., 347 West Main St., Louisville, Ky.
- MEYER, MARSHALL & CO., 528 California St., San Francisco.
- DENNEHY, WOLF & O'BRIEN, 85 & 87 Dearborn St. Chicago, Ill.
- WILCOX & McGEARY, - No. 11 Bissel Block, Pittsburgh, Pa.
- T. T. RAMSDALL & CO., - 20 Swan Street, Buffalo, N. Y.
- SIEMENS GAS ILLUMINATING CO.,
Room 6, No. 157 Broadway, New York City.
- W. D. COLT, - - - - 1420 F Street, Washington, D. C.
- JOHN KIEFER, - - - 344 Lawrence, Street, Denver, Col.

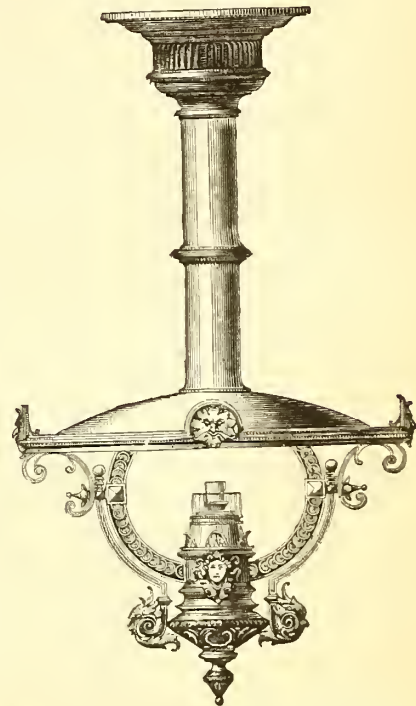

THE SIEMENS REGENERATIVE GAS LAMP COMPANY,
SOLE MAKERS FOR THE UNITED STATES,
N. E. Cor. 21st. St. and Washington Av.. Philadelphia, Pa.

THE "STANDARD" WASHER-SCRUBBER, KIRKHAM, HULETT & CHANDLER'S PATENT.

Total Capacity per 24 Hours of "Standard" Washers Ordered During the Following Years.

1877.....	4,000,000	cubic feet.
1878.....	4,750,000	"
1879.....	24,545,000	"
1880.....	42,967,500	"
1881.....	36,462,500	"
1882.....	39,300,000	"
1883.....	57,735,000	"
1884.....	28,177,500	"
Total.....	235,937,500	cubic feet.

Total Number and Capacity per 24 Hours of "Standard" Washers Erected and in Course of Erection in the Several Countries

	Number.	Cubic Feet per Day.
Great Britain..	151	157,070,000
Western Hemisphere.....	38	39,337,500
Australia.....	18	12,150,000
New Zealand.....	2	650,000
France.....	6	4,550,000
Belgium.....	8	5,420,000
Germany.....	16	8,200,000
Holland.....	4	4,160,000
Denmark.....	1	150,000
Russia.....	2	3,500,000
Spain.....	1	350,000
India.....	1	400,000
Total.....	248	235,937,500

THE CONTINUED POPULARITY

Of these Machines

Will be recognized from the following extracts from letters from representatives of some of the companies having them in use:

TOLEDO GAS LIGHT AND COKE CO., }
TOLEDO, OHIO, Nov. 25, 1884. }

GEO. SHEPARD PAGE, Esq.:

Dear Sir—Replying to your kind favor of 21st inst., I would say that the "Standard" Washer-Scrubber is doing work that is entirely satisfactory to us. During the summer I had 12-oz. liquor; but since cool weather commenced I have been having from 18 to 23-oz. liquor, just as we would elect. There is not a trace of ammonia passing the Scrubber that a test of reddened litmus or yellow turmeric paper would indicate. The machine, in my opinion, is all that could be desired as a means for removing all the ammonia from the gas.

Very respectfully,
C. R. FABEN, Jr.,
Superintendent.

"Standard" Washers Ordered During the Current Year.

	Cu. Ft. per Day
Anneberg Gas Co.....	200,000
Bombay Gas Co.....	400,000
Brussels Co.....	1,250,000
Chemnitz Gas Co.....	1,000,000
CITIZENS GAS CO., BUFFALO.....	750,000
Coke Works in Zabre, Ober-Schlesien.....	1,500,000
Cokerel der Friedenshutte, Upper Silesia.....	500,000
Dunfries Corporation.....	250,000
Dunedin Gas Co., New Zealand.....	400,000
King's Lynn Gas Co.....	300,000
Leiden, Holland.....	600,000
Lincoln Gas Co.....	400,000
Liverpool Gas Co.....	2,000,000
".....	3,000,000
LOUISVILLE GAS CO.....	1,500,000
Nimeca Gas Co.....	100,000
PITTSBURGH GAS CO.....	1,500,000
PORTLAND GAS CO., Oregon.....	562,500
SAN FRANCISCO GAS CO.....	4,000,000
Sheepbridge.....	10,000
ST. LOUIS GAS CO.....	2,000,000
Sydney Gas Co.....	2,500,000
WASHINGTON, D. C. GAS CO.....	2,000,000
Whitechurch Gas Co.....	175,000
Total.....	26,177,500

GEO. SHEPARD PAGE, No. 69 WALL STREET, NEW YORK,
SOLE AGENT FOR THE WESTERN HEMISPHERE.

R. D. WOOD & CO.,

400 Chestnut Street, Phila., Pa.

Cast Iron Gas & Water Pipe, Water Machinery & Gas Apparatus

Cast Iron Pipe, Fire Hydrants, Eddy Valves, Lamp Posts, Large Loam Castings, Flanged Pipe, Sugar House Work, Iron Roofs and Floors, Wrought & Cast Iron Tanks, Turbine Water Wheels and Pumps.

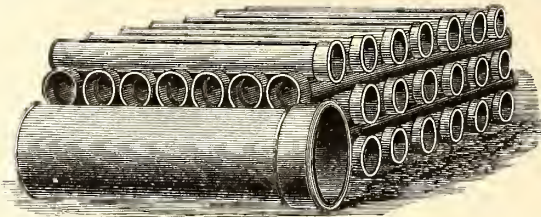

Casholders, Lime Trays, Center Valves, Purifiers, Bench Work, Exhausters, Condensers, Governors, Scrubbers, Gas Valves, Station Meters, Cast Iron Pipe Fittings.

Manufacturers of Heavy Castings and Machinery of Every Description.

ENGINEERS & CONTRACTORS FOR THE ERECTION OF GAS WORKS, & ALL MACHINERY CONNECTED THEREWITH

Estimates and specifications furnished for erection of new works or the extension or alteration of old ones.

Foundries and Works, - - Millville, Florence, and Camden, N. J.

SMITH & SAYRE MFG. COMPANY,

G. G. PORTER, Prest.

245 Broadway, N. Y.

CHAS. W. ISBELL, Sec'y.

Machinery & Apparatus for Gas Works

Drawings, Plans, and Estimates Furnished for the Improvement, Extension, or Alteration of Gas Works, or for the Construction of New Works.

Mackenzie's Patent Rotary and Steam Jet Gas Exhausters, Governors, Compensators, Condensers, Washers, Scrubbers, Isbell's Patent Automatic Street Pressure Governor, Gas and Water Valves, Hydraulic Main Dip Regulator, Bench Castings, etc. Purifying Boxes and "Standard" Scrubbers. Isbell's Patent Self-Sealing Retort Doors.

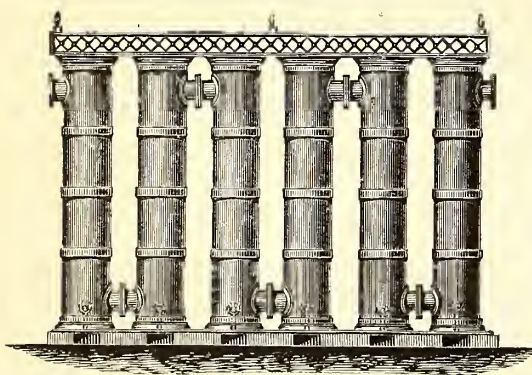
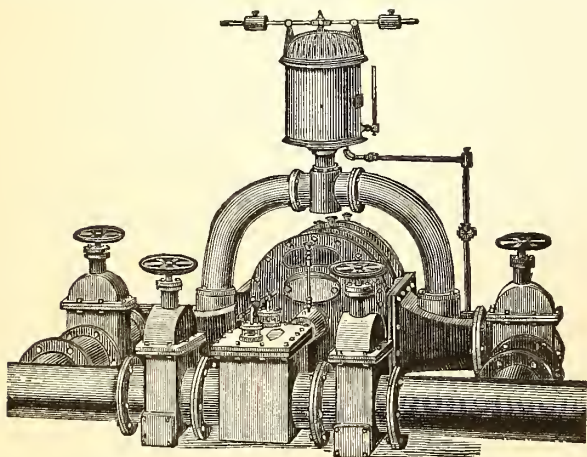

W. E. Tanner, Pres., W. R. Trigg, V.-Pres., A. Delaney, Supt.

Tanner & Delaney Engine Co.
RICHMOND, VA.

Gas Apparatus,

INCLUDING

Condensers of various styles, Scrubbers, Holders, Purifiers, Castings for Retort Houses, Etc.

ALSO STEAM ENGINES AND BOILERS.
Plans, Specifications and Estimates Furnished.

SOUTHWARK FOUNDRY AND MACHINE COMPANY,

Successors to MERRICK & SONS. Established in 1836.

No. 430 Washington Avenue, Philadelphia, Pa.

MANUFACTURERS OF

Single and Telescopic Gasholders,

BENCH CASTINGS,

Washers, Scrubbers, Condensers, Purifiers,

And all apparatus necessary for the construction of improved new gas works and in the extension of established works. Also manufacturers of

Gas Engines, and of all descriptions of Steam and Hydraulic Machinery, and of Boiler and Tank Work.

Plans, specifications, and estimates furnished promptly on application.

MORRIS, TASKER & CO.,

Limited,

Builders of Gas Works,
PHILADELPHIA, PA.

To Gas Companies.

We make to order **CAP BURNERS** to burn any amount under a stated pressure. Send for samples.

Also, **SERVICE CLEANERS, DRIP PUMPS, and STREET MAIN PROVING APPARATUS.**

C. A. GEFROER,

248 N. 5th Street, Phila., Pa.

WM. HENRY WHITE,

Consulting & Constructing

Gas Engineer & Contractor.

ESTIMATES, PLANS, AND SPECIFICATIONS FURNISHED FOR NEW WORKS OR EXTENSIONS OF EXISTING WORKS.

32 Pine St., New York City.

Correspondence solicited.

JAMES R. FLOYD,
 (SUCCESSOR TO HERRING & FLOYD)
Oregon Iron Works,
 531 to 543 West 20th St., N. Y.
Practical Builders of Gas Works,
 MANUFACTURERS OF
ALL KINDS OF CASTINGS
 AND
APPARATUS FOR GAS-WORKS.

BENCH CASTINGS
 from benches of one to six Retorts each.
WASHERS: MULTITUBULAR AND
AIR CONDENSERS; CONDENSERS; SCRUBBERS
 (wet and dry), and
EXHAUSTERS
 for relieving Retorts from pressure.
BENDS and BRANCHES
 of all sizes and description.
FLOYD'S PATENT
MALLEABLE RETORT LID.
PATENT
SELF-SEALING RETORT LIDS.
FARMER'S
PATENT BYE-PASS DIP-PIPE.
SABBATON'S PATENT
FURNACE DOOR AND FRAME.
BUTLER'S
COKE SCREENING SHOVELS.

GAS GOVERNORS,
 and everything connected with well regulated Gas Works at
 low price, and in complete order.

SELLER'S CEMENT
 for stopping leaks in Retorts.
N. B.—STOP VALVES from three to thirty inches—
 at very low prices.
 Plans, Specifications, and Estimates furnished.

KERR MURRAY MFG. CO.,
 MANUFACTURERS OF
Single Lift and Telescopic
GASHOLDERS.

Built, 1884:

Altoona, Pa.	Capacity, 160,000 cubic feet.
Pittsburgh, Pa.	250,000 "
"	220,000 "
Bellaire, Ohio	50,000 "
Youngstown, Ohio	60,000 "
Canton, "	60,000 "
Akron, "	80,000 "
Xenia, "	10,000 "
Adrian, Mich.	65,000 "
Ypsilanti, Mich.	25,000 "
Muskegon, "	70,000 "
South Bend, Ind.	70,000 "
Anderson, "	20,000 "
Plainfield, "	10,000 "
Springfield, Illinois	100,000 "
Evanston, "	50,000 "
Freeport, "	35,000 "
Elgin, "	60,000 "
Sheboygan Wis.	20,000 "
Key West Fla.	10,000 "

Plans and estimates furnished for the erection of
 new and the rebuilding of old works. Address

Kerr Murray Mfg. Co.,
FORT WAYNE, IND.

CONTINENTAL WORKS.

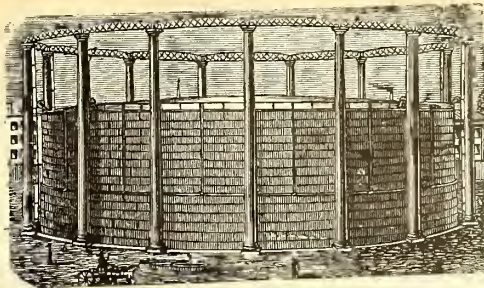

GASHOLDERS OF ANY MAGNITUDE.

T. F. ROWLAND, Proprietor,
GREENPOINT, BROOKLYN, N. Y.
 ENGINEER AND MANUFACTURER OF
GAS-HOLDERS.
CONDENSERS, SCRUBBERS, VALVES,
PURIFIERS, RETORTS, and HY-
DRAULIC MAINS,
 and all other articles connected with the Manufacture
 Distribution of Gas. Plans and Specifications prepared
 and Proposals given for the necessary Plant for Lighting
 Cities, Towns, Mansions, and Manufactories.

H. RANSHAW, Prest. & Mangr. WM. STACEY, Vice-Pres. T. L. BIRCH, Asst. Mangr. R. J. TARVIN, Sec. & Treas.

STACEY MFG. CO.,

MANUFACTURERS OF

Single and Telescopic Gasholders,

IRON ROOFS, BRIDGES, LAMP POSTS,

Water and Oil Tanks, Coal Elevator Cars,
COKE CRUSHERS, BENCH CASTINGS,

And all kinds of Wrought and Cast Iron Work used in the erection of Coal and Oil Gas Works.
 Rolling Mill Machinery and Heavy Castings a Specialty.

Foundry: 33, 35, 37 & 39 Mill Street. **Wrought Iron Works:** 16, 18, 20, 22, 24 & 26 Ramsey Street.

Cincinnati, Ohio.

BARTLETT, HAYWARD & CO.,

BALTIMORE, MD.

Office, 24 Light.

Works, Pratt & Scott.

PURIFIERS.
 Roofs.
 Bench Castings.

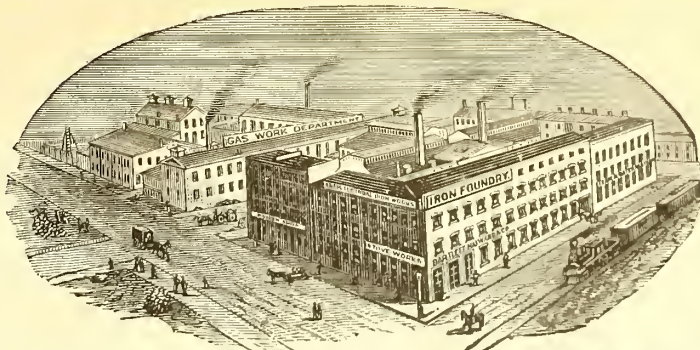

CONDENSERS.
 BOILERS.
SCRUBBERS.

GASHOLDERS.

CONSTRUCTING ENGINEERS AND BUILDERS OF GAS WORKS.

1842. **DEILY & FOWLER, 1884.**

Laurel Iron Works.

Address, No. 39 Laurel Street, Philadelphia, Pa.

MANUFACTURERS OF

GASHOLDERS,

Single or Telescopic, with Cast or Wrought Iron Guide Frames.

Holders Built Since 1880:

Mount Joy, Pa.	West Point, N. Y.	Galveston, Texas (2d.)	Kalamazoo, Mich. (3d.)	Newport, R. I.
Rockaway B'ch, N. Y. (2)	Fitchburgh, Mass.	Marlboro, Mass.	Glou Island, N. Y.	Portland, Oregon.
Zanesville, O. (2d.)	New London, Conn.	Denver, Col.	Warren, Ohio.	Allegheny, Pa. (2d.)
Lancaster, O.	Derby, Conn.	Chicago, Ill. (West Side).	Bath, N. Y.	Atlanta, Ga. (2d.)
Blackwell's Island N. Y.	Bridgport, Conn.	Pittsburgh, Pa. (S. Side).	Lynn, Mass.	N.Y. City (Central Gas Co)
Waltham, Mass., (1st.)	Allegheny, Pa. (1st.)	Pawtucket, R. I.	New Bedford, Mass.	Lynchburg, Va. (2d.)
Dorchester, Mass.	St. Hyacinth, Can.	Brookline, Mass.	Waterbury, Conn.	Savoyville, R. I.
Wheeling, West Va.	Norwalk, O.	Shorbrooke, Can.	Deseronto, Can.	Round, N. Y.
Lansing, Mich.	Brattleboro, Vt.	Burlington, N. J. (2d.)	Hosie Falls, N. Y. (2d.)	Atlantic City, N. J.
Flint, Mich.	Waltham, Mass (2d.)	Bridgeton, N. J.	Bethlehem, Pa.	Augusta, Ga.
Galveston, Texas (1st.)	West Chester, Pa.	Bay City, Mich.	Atlanta, Ga. (1st.)	Waltham, Mass. (3d.)
Milton, Pa.	Baltimore, Md.	Eric, Pa.	Savannah, Ga.	
Scranton, Pa.	Holidaysburg, Pa.	Jackson, Mich.	Montgomery, Ala.	

GAS COALS.

GAS COALS.

GAS COALS.

JAMES D. PERKINS.

PERKINS & CO.,

F. SEAVERNS.

General Sales Agents.

THE YOUGHIOGHENY RIVER COAL COMPANY,

Organized August 1, 1882.

MINERS AND SHIPPERS OF THE WELL-KNOWN

Ocean Mine Youghioghenny Gas Coal.

The Coal from the Ocean Mine (recently operated by Messrs. W. L. Scott & Co., of Erie, Pa.,) is now used by all the leading Gas Companies in the United States from Maine to Texas, and is recognized as *the only reliable Youghioghenny Gas Coal.* (See Map on p. 87 of this Journal, Feb. 16, 1885.)

Messrs. W. L. Scott & Co. and W. L. Scott, Esq., still retain their interest in the new Company, and the same general policy which has characterized the management of the mine under these gentlemen will be continued by the new Company. With largely increased facilities and *unlimited supply of Coal*, any demand made upon the Colliery will meet with prompt fulfillment.

THE UNDERSIGNED CAN SUPPLY THE FOLLOWING SUPERIOR GRADES OF

GAS CANNELS:

Abram Cannel, from the Abram Colliery, Wigan, England,
(See Map on pp. 154-5 of this Journal, Mar. 16, 1885.)

Plesio-Boghead Cannel, from near the old Boghead Colliery, Scotland. (See Map on pp. 126-7 of this Journal, Mar. 2, 1885.)

Llong Cannel, from Wales. The sale of this Cannel for the United States has been placed in our hands, and we are now prepared to execute orders for it. The product of this Colliery is quite limited, and it will be necessary for us to forward orders early to ensure delivery the coming season.

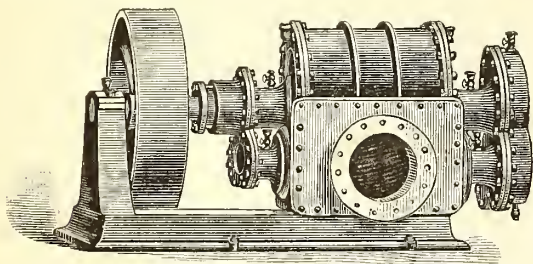
P. O. Box 3695,
New York.**PERKINS & CO., 228 and 229 N. Y. Produce Exchange****BEAVER STREET
ENTRANCE.**

Gas Exhauster Driven by Belt.

The Wilbraham Gas Exhauster,

"BAKER SYSTEM,"

WITH ENGINE ATTACHED, ON SAME BED PLATE OR WITHOUT.

Best, Cheapest and Most Durable Exhauster known.

WILBRAHAM BROS.,

No. 2320 Frankford Avenue, Philadelphia, Pa.

**CATHELL'S
Gas Consumer's Manual.**

Enables every gas consumer to ascertain at a glance, without any previous knowledge of the gas meter, the quantity and money value of the gas consumed. Also the best method of obtaining on gas the largest amount of its light. It will be to the advantage of Gas Companies to supply their consumers with one of these Guides, as a means of preventing complaint arising from their want of knowledge in regard to the registration of meters.

A. M. CALLENDER & CO., 42 Pine St., N. Y.

**AMERICAN
GAS LIGHT JOURNAL.**

\$3.00 per Annum.

A. M. CALLENDER & CO.,
42 Pine Street, N. Y. City.**King's Treatise on Coal Gas.**

The most complete work on Coal Gas ever published.

Three Vols. Bound, \$30.

A. M. CALLENDER & CO., 42 Pine St., N. Y.

**NEWBIGGING'S
Gas Manager's Handbook.**

Price, \$4.80.

EVERY GAS MAN SHOULD HAVE ONE.

Orders may be sent to this Office.

BOOKS.DISTILLATION OF COAL TAR AND
AMMONIACAL LIQUOR.

By GEORGE LUNGE. Price \$8.50.

A TREATISE ON THE COMPARATIVE
COMMERCIAL VALUES OF GAS
COALS AND CANNELS.

By DAVID A. GRAHAM. 8vo., Cloth. Price \$3.

Orders for these books may be sent to this office.

A. M. CALLENDER & CO.,
42 PINE ST., N. Y. CITY.

GAS COALS.

GAS COALS.

GAS COALS,

Newburgh Orrel Coal Co.,

MINERS AND SHIPPERS OF

**Newburgh Orrel, Tyrconnell
and Palatine Gas Coals.**

ALSO SHIPPERS OF FOUNDRY COKE.

Mines situated at

Newburgh, Flemington & Fairmont, W.Va.

HOME OFFICE,

25 S. Gay St., Baltimore.

CHARLES MACKALL,
MANAGER.

CHAS. W. HAYS, Agent in New York.

Room 92, WASHINGTON BUILDING, No. 1 Broadway.

Shipping wharves at Locust Point. References furnished when required. Special attention given to chartering vessels.

THE DESPARD COAL COMPANY

OFFER THEIR SUPERIOR

DESPARD COAL

To Gas Light Companies and Manufacturers of Fire Clay Goods
Throughout the Country.

ROUSEL & HICKS, } AGENTS. { BANGS & HORTON,
71 Broadway, N. Y. } 16 Kilby St., Boston.

Mines in Harrison Co., West Va. Wharves, Locust Point, Balt.
Company's Office, 15 German St., Baltimore, Md.

Among the consumers of Despard Coal we name: Manhattan
Gas Light Co., N. Y.; Metropolitan Gas Light Co., N. Y.; Jersey
City, (N. J.) Gas Light Co.; Washington (D. C.) Gas Light Co.;
Portland (Maine) Gas Light Co. Reference to them is requested.

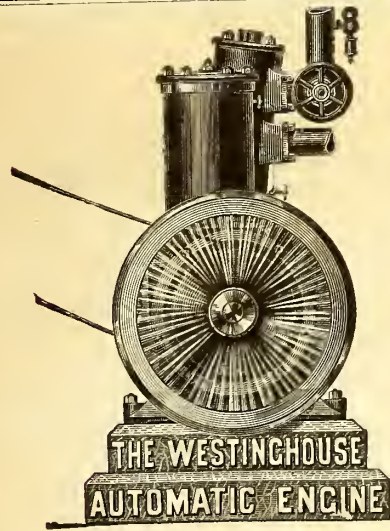

1,500 Engines Now in Use.

Our capacity being now equal to 100 Engines per
month, we shall hereafter keep in stock for immediate
shipment all sizes from 4 to 200 H.P.

SEND FOR ILLUSTRATED CIRCULAR AND REFERENCE LIST.

Westinghouse Machine Co.,
PITTSBURCH, PA.

SALES DEPARTMENT CONDUCTED BY

Westinghouse, Church, Kerr & Co., 17 Cortlandt
Street, New York City.

Fairbanks, Morse & Co., Chicago, Cincinnati, Cleve-
land, Louisville, and St. Paul.

Fairbanks & Co., St. Louis, Indianapolis, and Denver.

Parke & Lacy, San Francisco, and Portland, Or.

Parke, Lacy & Co., Salt Lake City, Utah, and Butte,
Montana.

D. A. Tompkins & Co., Charlotte, N. C.

Keating Implement & Machine Co., Dallas, Texas

Imray & Co., Sydney and Melbourne, Australia.

Robert Middleton, Mobile, Ala.

H. Dudley Coleman, 9 Perdido St., New Orleans, La.

R. Rogers, 43 Rue Laffitte, Paris.

**THE
PENN GAS COAL COMPANY**

OFFER THEIR

COAL, CAREFULLY SCREENED,

AND PREPARED FOR

GAS PURPOSES.

Their Property is located in the Youghiogheny Coal Basin, near Irwin's and Penn Station
on the Pennsylvania Railroad, and on the Youghiogheny River.

OFFICES

No. 209 South Third Street, Phil'a. 90 Wall Street, New York.

PLACES OF SHIPMENT.

Pennsylvania Railroad, Pier No. 2 (Lower Side).

Greenwich Wharves, Delaware River.

366-1y

Pier No. 1 (Lower Side), South Amboy, N. J.

Chesapeake & Ohio Railway Coal Agency,

FOR THE SALE OF THE

**Superior Kanawha Gas Coals, Cannelton Cannel,
Also, SPLINT AND STEAM COALS.**

From the Kanawha and New River Regions, on the line of the Chesapeake & Ohio R'way.

C. B. ORCUTT, Sales Agent. | OFFICE, 150 BROADWAY, N. Y.

FRANCIS H. JACKSON, PRESIDENT.

EDMUND H. McCULLOUGH, SEC. & TREAS.

THE WESTMORELAND COAL CO.

Chartered 1854.

**Mines situated on the Pennsylvania and the Baltimore
and Ohio Railroads, in Westmoreland County, Penn.**

POINTS OF SHIPMENT:

PHILADELPHIA, BALTIMORE, SOUTH AMBOY, N. J.
WATKINS (SENECA LAKE), N. Y.

Since the commencement of operations by this Company its well-known
Coal has been largely used by the Gas Companies of New England and the
Middle States, and its character is established as having no superior in gas-
giving qualities, and in freedom from sulphur and other impurities.

Principal Office, 224 South 3d St., Phila., Pa.

The Bower Gas Lamp.

**The Perfected Duplex-Regenerative Gas Burner, under
the combined Patents of Anthony S. Bower,
Geo. S. Grimston, and Thos. Thorp.**

The First Gold Medal awarded at the Crystal Palace Exhibition in
London, and two Gold Medals at the Stockport (Eng.) Exhibition of Gas
Appliances. Both in 1883.

GEO. SHEPARD PAGE, JOHN BOWER,
69 Wall Street, N. Y. City.

The Management of Small Gas Works.

By C. J. R. HUMPHREYS. Price, \$1.

A. M. CALLENDER & CO., 42 Pine St., N. Y.



INTERNATIONAL--1876--EXHIBITION.

The U. S. Centennial Commission.

HAVE DECREED AN AWARD TO

HARRIS, GRIFFIN & CO.,

12th and Brown Sts., Philadelphia, and 49 Dey St., N. Y., U. S. A.,

FOR THE FOLLOWING REASONS:

The Exhibit consists of a Series of METERS from the Largest Size Station Meters for the use of the MANUFACTURE OF GAS, to those for the use of the ORDINARY CONSUMER. The Instruments are WELL MADE, RELIABLE as to INDICATION, and embody a number of sundry improvements which, with the general character of the Exhibit, entitle the whole to commendation.

Attest—J. L. CAMPBELL,
Secretary, pro-tem.Signed—A. T. GOSHORN,
Director GeneralJ. R. HAWLEY,
President

CHARLES E. DICKEY.

JAMES B. SMALLWOOD.

CHARLES H. DICKEY.

Maryland Meter and Manufacturing Co.,**DICKEY, TANSLEY & CO.,**

Established 1866.

Nos. 22 and 24 Saratoga Street, Baltimore, Md.

No. 46 La Salle St., Chicago, Ill.

MANUFACTURERS OF

DRY GAS METERS, STATION METERS, GLAZED METERS, TEST METERS, METER PROVERS, PRESSURE AND VACUUM REGISTERS, GOVERNORS, INDICATORS, SERVICE AND METER COCKS, AND METER CONNECTIONS.

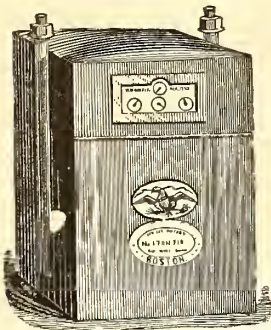

Dry Gas Meter.

With 39 years' experience and the best facilities for manufacturing, is enabled to furnish reliable work and answer orders promptly.

NATHANIEL TUFTS,

No. 153 Franklin Street, Boston, Mass.,

MANUFACTURER OF

DRY GAS METERS.

Station Meters of any Capacity.

Test and Experimental Meters, Pressure Registers, Pressure Gauges, Pressure and Vacuum Gauges.

METER PROVERS, PHOTOMETERS, STREET LANTERNS, ETC., ETC.

Patent Cluster Lanterns for Street Illumination.

SCIENTIFIC BOOKS.

We are prepared to furnish to Gas Managers, and others interested in the topics treated of, the following books, at prices named:

KING'S TREATISE ON THE MANUFACTURE OF COAL GAS. Three vols.; \$10 per vol.	GAS CONSUMER'S MANUAL, by E. S. CATHELS, C.E. 10 cts.	A PRACTICAL TREATISE ON GAS AND VENTILATION, with Special Relation to Illuminating, Heating, and Cooking by Gas, by E. E. PERKINS. \$1.25.
GAS MANUFACTURE, by WILLIAM RICHARDS. 4to., with numerous Engravings and Plates, in Cloth binding. \$12.	PRACTICAL TREATISE ON HEAT, by THOMAS BOX. Second edition. \$5.	PURIFICATION OF COAL GAS, by R. P. SPICE. 8vo. \$3.
THE GAS ANALYST'S MANUAL, by F. W. HARTLEY. \$2.50.	GAS WORKS—THEIR ARRANGEMENT, CONSTRUCTION, PLANT, AND MACHINERY. \$8.	HOW TO MANAGE GAS, by F. WILKINS. Paper. 20 cents.
ANALYSIS, TECHNICAL VALUATION, PURIFICATION, and USE OF COAL GAS, by REV. W. R. BOWDITCH, M.A.; with Engravings; 8vo., Cloth. \$4.50.	COAL; ITS HISTORY AND USE, by PROF. THORPE. \$3.50.	THE GAS MANAGER IN THE LABORATORY, by a Practical Student. 8vo., Cloth. \$1.50.
MEASUREMENT AND GAS METER TESTING by F. W. HARTLEY. \$1.60	THE GAS WORKS OF LONDON, by COLBURN. 60 cents.	THE DOMESTIC USES OF COAL GAS, AS APPLIED TO LIGHTING, by W. SUGG. \$1.40.
GAS CONSUMER'S HANDBOOK, by WILLIAM RICHARDS, C.E.; 18mo., Sewed. 20 cents.	THE GAS FITTER'S GUIDE, Showing the Principles and Practice of Lighting with Coal Gas, by JOHN ELDREDGE. 40 cents.	DISTILLATION OF COAL TAR AND AMMONIACAL LIQUOR, by GEO. LUNGE. \$8.50.
	GAS WORKS, AND MANUFACTURING COAL GAS, HUGHES. \$1.80.	A TREATISE ON THE COMPARATIVE COMMERCIAL VALUES OF GAS COALS AND CANNELS, by D. A. GRAHAM. 8vo., Cloth. \$3.
	THE MANAGEMENT OF SMALL GAS WORKS, by C. J. R. HUMPHREYS. \$1.	

The above will be forwarded by express, upon receipt of price. We take especial pains in securing and forwarding any other Works that may be desired, upon receipt of order. All remittances should be made by check, draft, or post office money order.

A. M. CALLENDER & CO., No. 42 Pine Street, New York.

T. C. HOPPER, Pres. G. J. McGOURKEY, Vice-Pres. (New York). WM. N. MILSTED, Gen. Supt. & Treas. (New York). WM. H. DOWN Sec.

AMERICAN METER COMPANY,

WET AND DRY GAS METERS. PRESSURE REGISTERS. METER PROVERS.
 STATION METERS. PRESSURE & VACUUM REGISTERS. PORTABLE TEST METERS.
 EXHAUSTER GOVERNORS. PRESSURE & VACUUM GAUGES. EXPERIMENTAL METERS.
 DRY CENTRE VALVES. CRESSON GAS REGULATORS. AMMONIA TEST METERS.
 GOVERNORS FOR GAS WORKS. MARSLAND WATER METERS. BAR AND JET PHOTOMETERS.

Manufactories:
 512 W. 22d St., N. Y.
 Arch & 22d Sts., Phila.

GAS STOVES,
 SUGG'S "STANDARD" ARGAND BURNERS,
 SUGG'S ILLUMINATING POWER METER,
 Wet Meters, with Lizar's "Invariable Measuring" Drum.

Agencies:
 177 Elm Street, Cincinnati.
 244 & 246 N. Wells Street, Chicago.
 810 North Second Street, St. Louis.
 122 & 124 Sutter St., San Francisco.

HELME & McILHENNY,

(Successors to Harris & Brother. Established 1848.)

GAS METER MANUFACTURERS,

CONTINUE AS HERETOFORE AT THE OLD ESTABLISHMENT,

Nos. 1115 and 1117 Cherry Street, Philadelphia, Pa.,

To Manufacture Wet and Dry Gas Meters, Station Meters, Experimental Meters, Meter Provers, Center Seals, Pressure Registers, GOVERNORS, INDICATORS, PHOTOMETERS, & ALL OTHER KINDS OF APPARATUS FOR USE IN GAS WORKS.
 From our long practical experience of the business, and from our personal supervision of all work, we can guarantee all orders to be executed promptly, and in every respect satisfactorily.

WM. WALLACE GOODWIN, Prest. and Treas.

WM. H. MERRICK, V.-Prest.

S. L. JONES, Sec.

S. V. MERRICK, Supt.

THE GOODWIN GAS STOVE AND METER COMPANY,

Successors to W. W. GOODWIN & CO.

1012, 1014 and 1016 Filbert St., Phila., Pa. 142 Chambers St., New York.
 76 Dearborn St., Chicago, Ill.

WALDO BROS., Agents, 88 Water St., Boston.

MANUFACTURERS OF THE "SUN DIAL" GAS STOVES, FOR COOKING AND HEATING PURPOSES.

Dry and Wet GAS METERS, Station Meters (Square, Cylindrical or in Staves) Glazed Meters, King's and Sugg's Experimental Meters, Lamp Post Meters, Etc., Etc., Meter Provers (sizes 2, 5 and 10 feet), Pressure Gauges of all kinds, Pressure Registers, Pressure and Vacuum Registers, Pressure Indicators (sizes 4 inch, 6 inch and 9 inch), King's Pressure and Vacuum Gauges, Dry and Wet Centre Seals, Dry and Wet Governors, Exhauster Governors, Photometers of all descriptions. Letheby's Sulphur and Ammonia Test Apparatus complete—also Testing and Chemical Apparatus of all kinds, and of the most perfect description, for all purposes relating to Gas.

GOODWIN'S IMPROVED LOWE'S JET PHOTOMETER.

Agents for Bray's Patent Gas Burners and Lanterns.

Special attention to repairs of Meters, and all apparatus connected with the business.
 All work guaranteed first class in every particular, and orders filled promptly.

G. B. EDWARDS, Mang'r, New York.
 E. H. B. TWINING, Mang'r, Chicago.
 A. B. STANNARD, Agent.

D. McDONALD & CO., GAS METER MANUFACTURERS.

(Established 1854.)

No. 51 Lancaster Street, Albany, N. Y.

STATION METERS, EXPERIMENTAL METERS, METER PROVERS, PRESSURE & VACUUM REGISTERS, PRESSURE GAUGES, ETC.
 Also STAR GAS STOVES, RANGES, and HEATING STOVES.

We use only the very best materials, and employ the most skilled labor, and by our long experience (29 years) and personal supervision of every detail, we feel justified in assuring the public that our goods will give perfect satisfaction. Every Meter emanating from our establishment will bear the State Inspector's BADGE, and will be fully warranted by us. Our Annual and Calendar will be sent to Gas Companies upon application.

KING'S TREATISE ON COAL GAS.

The most complete work on Coal Gas ever published. Three vols., bound, \$30.

A. M. CALLENDER & CO., No. 42 Pine Street, New York.

THE GOODWIN GAS STOVE AND METER CO.,

Successors to W. W. GOODWIN & CO.,

1012, 1014 & 1016 Filbert St., Phila., 142 Chambers St., N. Y., 76 Dearborn St., Chicago.

Agents, WALDO BROTHERS, 88 Water Street, Boston.

WM. W. GOODWIN, PRES. & TREAS.
W. H. MERRICK, VICE-PRES.
S. LEWIS JONES, SEC.

SOLE MANUFACTURERS OF THE

SAMUEL V. MERRICK, SUPT.
G. B. EDWARDS, Mang'r, N. Y.
E. H. B. TWINING, Mang'r, Chicago.

"SUN DIAL" GAS STOVES

The Most Economical, Efficient, and Durable Gas Stove Made.

Since 1878, when we began to manufacture these Stoves, we have received 17 Gold, Silver, and Bronze Medals, and 6 Diplomas for Efficiency, Superiority of Workmanship, etc. etc.

ALL FITTINGS ARE NICKEL-PLATED WITHOUT EXTRA CHARGE.

THE OVEN BURNERS ARE CONSTRUCTED TO BURN EITHER PURE GAS OR GAS AND AIR MIXED.

FROM TWENTY-FIVE TO FORTY PER CENT. OF GAS SAVED BY THE USE OF OUR PATENT OVEN LINING.

STOVES THAT WILL COOK FOR ONE PERSON OR ONE THOUSAND PERSONS AT ONE TIME.

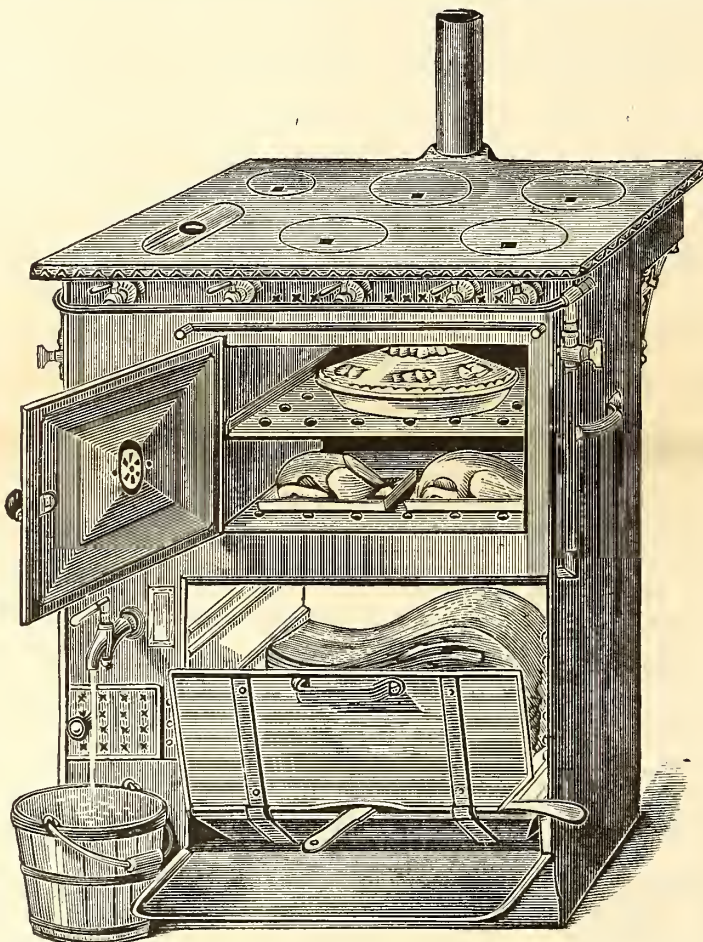

Gas Cooking Stove No. 9A. FITTED WITH OUR PATENT TOP AND OUTLET PIPE FOR CARRYING OFF COMPLETELY ALL THE PRODUCTS OF COMBUSTION FROM, OVEN, ROASTER, AND TOP BURNERS.

STOVES FOR LAUNDRIES, HATTERS, AND TAILORS.

HOT WATER GENERATORS FOR USE IN KITCHENS, BATH ROOMS, ETC., ETC.

BROILING RANGES FOR RESTAURANTS AND HOTELS.

OVER THIRTY-FIVE THOUSAND STOVES OF ALL SIZES SOLD SINCE 1878.

SEND FOR ILLUSTRATED CATALOGUE.

We carry in Stock Nos. 7, 8, and 8A Cooking Stoves fitted with our Patent Tops. See Catalogue and Price List.

We desire to call attention to our IMPROVEMENT IN THE TOP OF THE SUN DIAL GAS STOVE, by means of which all the odors and products of combustion from the ovens and top burners are entirely removed from the room. This is accomplished by channels and flues connected to the pipe shown at back of stove, to which is connected such additional pipe as may be necessary to connect the same with the flue or chimney, thereby producing the same effect in conveying away the products of combustion as is done in the use of the ordinary range, etc. This arrangement fills a want that has long been felt by those who have objected to the use of gas stoves for the reason of there being no adequate means to remove the products of combustion and odors from the roasting chambers, ovens, and boiling burners, all of which is now accomplished. *We have secured the improvement by Letters Patent in this country and Europe, and any attempt at infringement will be prosecuted.*

AGENTS FOR CLERK'S PATENT GAS ENGINE.

THE AMERICAN

GAS LIGHT JOURNAL

ROHMAN & KENNY, N.Y.

PUBLISHING OFFICE No. 42 PINE STREET

DEVOTED TO THE INTERESTS OF ILLUMINATION, VENTILATION, WATER SUPPLY AND DISTRIBUTION, & GENERAL SCIENCE.

VOLUME XLII.—No. 8.
Whole No. 620.

NEW YORK, THURSDAY, APRIL 16, 1885.

{ \$3 PER ANNUM
IN ADVANCE.

A. M. CALLENDER & CO., Proprietors. C. E. SANDERSON, Manager.
JOS. R. THOMAS, C.E., Editor.

ENTERED AT THE POST OFFICE AT NEW YORK, N. Y.,
AS SECOND CLASS MATTER.

Published on the 2d and 16th of each month, at No. 42 Pine Street, N. Y.
Terms of Subscription, including Postage.—For the United States and
Canada, \$3 per annum. European countries, \$3.50 (15 shillings—18 francs).
All payments to be made in advance. Single copies, 15 cents.
Remittances should be made either by post-office order, registered letter, or
bank draft on New York, payable to the order of A. M. Callender & Co.
Collections are invariably made directly from this office, for subscriptions, ad-
vertisements, etc. We have agents to solicit the same, but they are not
authorized to receipt for money.
Correspondence.—Wishing to make this JOURNAL a gazette of intelligent dis-
cussion to those of our readers who may wish to gain or give information on
the subjects to which its columns are devoted, correspondence is solicited for
publication from all who make the study of those subjects a pleasure or a
profession.
Books.—We will mail, post-paid, at publisher's lowest rates, any book—scien-
tific or otherwise—to any address in the United States or Canada. No books
will be sent C. O. D.

CONTENTS.

An Asterisk (*) denotes an illustrated article.

OFFICIAL CIRCULAR—	
Annual Meeting of the Western Gas Association.....	197
EDITORIALS—	
Obituary—Mr. Thomas Butterworth.....	197
The Proposed Gas Commission for New York City.....	198
Fifteenth Annual Meeting of the New England Association of Gas Engineers—Official Report—Continued from page 174.....	199
An Experience with Naphthaline Deposits, by Edward C. Jones—Disussion —Naming Place Wherein to Hold Next Annual Meeting—Proposing to Limit the Term of Presidential Office—Taking Up the Question—Box—The Questions Discussed were, "What advances have been made in electric lighting during the past year?"—"What is the effect of atmospheric change upon the candle power of gas—especially a low barometrical pressure?"—"Is a pipe around the rotort house, between the hydraulic and condenser, of any practical value?"—"What candle power coal gas can be maintained by enriching with naphtha introduced into a return of the ordinary setting?"—"Which is the best method to use oil as an enricher, and the kind to be used?"	
Papers Read before the First Annual Meeting of the Ohio Gas Light Association, with Discussions on Same—Official Report— Continued from page 177.....	203
Papers, by Messrs. E. McMilla and J. Light, on the subject of, The Preven- tion of Naphthaline as a Deposit in Gas Works Plant—Discussion—First Day, Afternoon Session—Natural Gas; what is it, and can it become a Competitor of Coal Gas as an Illuminating Agent? by I. Butterworth—Discussion.	
The New Gasholders Built to the Order of "The Gas Light and Coke Company," at the Horseferry Road Station.....	207
Improvement of the Locomotive Engine.....	208
One or Two Figures.....	208
ITEMS OF INTEREST FROM VARIOUS LOCALITIES.....	208
To Take Charge of the El Paso (Texas) Plant—Removing Hard Tar from Hy- draulic, and Freeing Dip and Ascension Pipes—He Came to Grief—East End Gas Company (Pittsburgh, Pa.) Reduces Price of Gas—An Additional List of Victims—Case No. 3—American Water Works Association—A Few of the Consumers who Will Not Have the Chicago Water Gas—Thought it was a Joke—"Incorporating" Themselves—Turning on the Gas—Obituary Note—A Change in Superintendency at Montgomery (Ala.) Works—Personal —Heating the Newly-Built "Insurance Exchange" and "Traders' Building." —Heating the Newly-Built "Insurance Exchange" and "Traders' Building." of Chicago, Ills., with Gas—The Audience Left in Darkness—Reducing Price of Gas at Utica, N. Y.—From Present Appearances, We Think "No" An- swers the Conundrum—Rockland (Me.) Gas Light Company Reduces Price of Gas—He was Told to "Go on"—The Nassau Company's New Plant.	
CORRESPONDENCE—	
The "Knights of Labor" Speak Their Mind.....	210
The Market for Gas Securities.....	211

[OFFICIAL CIRCULAR.]

ANNUAL MEETING WESTERN GAS ASSOCIATION.

SECRETARY'S OFFICE WESTERN GAS ASSOCIATION, }
QUINCY, ILLS., March 20, 1885. }

The Eighth Annual Meeting of the Western Gas Association will be held
at Chicago, Ills., on the 13th, 14th and 15th days of May. The Committee
of Arrangements, Messrs. E. L. Brown, P. T. Burtis, and Henry Pratt, have
spared no pains to secure for our accommodation the best quarters for our
purpose obtainable. Those who attended our last reunion at St. Louis will
remember but too well that the chief, and perhaps the only, drawback to an
entirely successful meeting was the character of the room in which were con-
ducted the business sessions of our Association. Owing to our late unfor-
tunate experience in this particular, you are all aware that it is a matter of
the highest importance that the acoustic property of the hall in which we are
to assemble should be as excellent as it is possible to secure. Bearing this
point well in mind, the Committee, after having carefully examined the as-
sembly rooms of every first class hotel in Chicago, arrived at the unanimous
conclusion that the Tremont House, of that city, came nearer meeting our
requirements, in all essential particulars, than any of the others, and accord-
ingly have secured it for our Eighth Annual Meeting. This hotel, although
not so large as some of the others, is strictly first-class in all its appoint-
ments, and admirably well adapted to our needs. Liberal concessions from
the regular rates were secured by the Committee, and the prices to our
members will range from \$2.50 per day upwards, according to the size and
location of rooms. Apartments can be secured, at any time before the date
of the meeting, by those who will communicate with the proprietors of the
hotel, or with your Secretary; but the members must in all cases give notice,
in their requests, of the rates which they desire to pay.

I am very anxious to be informed as soon as possible of the titles of the
papers to be presented, and earnestly request their authors to favor me with
this information at their earliest convenience.

Copies of our Constitution and By-Laws, blank forms of application for
membership, or any other information that may be desired, will be promptly
furnished if you will but make your wants known to,
Yours very truly,
A. W. LITTLETON, Secretary

OBITUARY.—MR. THOMAS BUTTERWORTH.

Once more do we find ourselves called upon to chronicle the demise of one
who had always been looked upon as a leader in the ranks of the gas fraternity
of the United States; and most sincerely do we deplore the occasion that
compels us to announce the decease of Mr. Thomas Butterworth, late of
Rockford, Illinois. Mr. Butterworth's physical condition had not been of
the most rugged sort during the last two or three years, and while on a visit
to this city last October the gentleman acknowledged to us that in order to
escape the importunities of his political friends, who were extremely anxious
he should contest the Rockford district with a view to representing the peo-
ple of that section in the next Federal Congress, he was obliged to come
East at an earlier period than he would naturally have selected to be in at-
tendance at the Twelfth Annual Meeting of the American Gas Light Associ-
ation. He explained that his health had been so poor that he feared to
incur the excitement and fatigue consequent upon a protracted political cam-
paign. Indeed his caution was well founded, for the jolting and discomfort

inseparable from a railway journey between Rockford (Ills.) and New York city had so far enervated him that he was completely prostrated upon his arrival at the Metropolis. During a ten days' sojourn at the Westminster Hotel he complained greatly; but the care and attention with which he was surrounded enabled him to recuperate to such a degree that his kindly face and genial presence brought pleasure to his brother members during the Association's 1884 Washington sessions.

Shortly after his return to Rockford the symptoms of his peculiar malady had made such ravages and vigorous progress that, acting under the urgent advice of his medical attendants, joined to the affectionate persistence of his wife and children, Mr. Butterworth determined to seek a milder climate than that of his home, and journeyed along by easy stages until the chosen spot (Asheville, North Carolina,) was reached. Accompanied on this Southern trip by his wife and two of his children, the afflicted gentleman, although ministered to by the careful attention of earnest, zealous hands, and solaced and upheld by the warmest and most tender affection, death's progress could at best be but delayed. Despite every art known to medical science, and every care that loving hearts could bestow upon the object of their affection, Mr. Butterworth succumbed to the scythe of the reaper on the morning of Sunday, April 5th. A note received at Rockford by one of deceased's friends, and from the pen of a witness at the death bed, says: "The end has come—mouths of weary, patient suffering reached their end in the solemn silence of death! Hoping against all hope; with not a ray of light amid the somber shadows hovering over his death-bed, the family and friends of Thomas Butterworth would not believe that the stern enemy had marked him for his own. At a time of life when the faithful body and tired mind might take relief from toil and care; when the prospect of a cheerful home, a comfortable living, a devoted family, and a freedom from the heavier burdens of life offered the brightest prospects, the happiest solace, for his declining years, it seemed more than hard that fate should be so pitiless. He had worked early and late—tireless, unceasing, undaunted, amid all the vexations and hindrances which would have borne a weaker spirit to the earth—his vigorous strife had but reached the hour of its richest earthly reward; yet such is the end. The mind rebels at the sad blow, and yet it cannot be thrust aside."

Mr. Butterworth was in all respects a self-made and a self-reliant man, as indeed the following briefly-stated chronologic recital will show. Born at Manchester, England, on the sixth day of September, 1827, the limited resources of his parents did not permit his attendance upon the studies of a day-school after his eleventh birthday anniversary had been attained. From thenceforward he had to rely upon his own resources, and face the stern necessity of making his way through life. He served a seven years' apprenticeship to an English firm of house builders, and at 18 years of age had mastered the bricklayer's craft. If he could not pursue a regular course of study during the daytime he had ambition enough to turn his evening hours of leisure to good account, and in this way he managed to secure a perfect insight into the principles underlying applied mechanics. He became united in marriage with his first wife when in his 19th year, and about a year afterwards the youthful couple embarked for America, taking passage in the sailing vessel *General Taylor*. After a voyage that lasted over six weeks the port of New Orleans, La., was reached; and on December 21st, 1848, the youthful emigrants stepped on ground that was fairly dotted with the newly-made graves of those who had yielded to the frightful yellow fever scourge of that year. In an old Bible in possession of the Butterworth family appears the following record in reference thereto: "Found the city almost deserted on account of the yellow fever raging—there being no frost until after Jan. 1st, 1849." Mr. Butterworth's means at the period were so limited that, in order to procure funds to land himself and wife at Cincinnati, Ohio, he was compelled to dispose of nearly all his personal effects—the sacrifice including his engineering and mechanical text-books. Arriving at Cincinnati, it was not long before he secured employment with Stacey and Company, which at that period was largely engaged in the construction of public buildings—such as churches, etc. It was while in the employ of this Cincinnati firm, afterwards so closely identified with the growth of the gas industry in the west, that Mr. Butterworth became an adept in the principles of gas manufacture and distribution, and furnishes an explanation as to how his skilful management placed the Rockford plant on such a firm footing. The Messrs. Stacey, in 1854, despatched Mr. Butterworth to make extensive repairs to the Rockford works, owned at the time by Lane, Sanford & Company. These gentlemen became so impressed with the methods employed that Mr. Butterworth was offered an interest in the plant, and asked to remain in the management of its future fortunes. With his family he decided to make Rockford his permanent home; and for a time the Butterworth homestead was located in some rooms at the rear of the gas works. His careful habits and unflagging industry were such that at his death, and for quite a while before, he was sole proprietor of the Rockford works. At one period he was largely interested in the Freeport (Ills.) works.

The deceased gentleman was a firm believer in the benefits to be derived

from connection with gas engineering associations. The Rockford Company endorsed and became a subscriber to the rules governing what has since become known as the American Gas Light Association, but then designated by the title of "The Gas Light Association of the United States," on the occasion of the first annual meeting, held in New York city, October, 1873. The deceased gentleman was chosen a member of the American Association's Executive Committee at 1882 meeting; chosen third vice-president at 11th assembly; the Washington meeting, in 1884, beholding him elected to the chair of second vice-president. He became affiliated with the Western Gas Association at First Annual meeting, held at Tremont House, Chicago, Ills., May 14th, 1879, being at the time chosen as second vice-president of that body. He was elevated to the presidency of Western Gas Association at Indianapolis meeting, and held the occupancy of the Chair during two straight terms, or up to the full limit prescribed by the by-laws of the organization. He was a faithful attendant at the annual meetings of both associations, and ever ready to impart to his fellow members information regarding the gas maker's craft. No other man in the Western country excelled him in the possession of knowledge connected with our business, and the record of his operations at Rockford is pointed to in confirmation of the assertion.

Mr. Butterworth represented his district in the lower house of the Illinois State Legislature in the year 1878; was popular with his neighboring citizens, and his voice was ever uplifted in their behalf. It was through his efforts that the attempts of a certain unscrupulous ring of political tricksters to light the State House at Springfield, with a specially constructed gas works, were brought to grief. The features of the scheme were so cleverly brought to light, through Mr. Butterworth's investigations, that the concoctors of the measure were covered with discredit.

Mr. Butterworth, after the death of his second wife (which occurred in the year 1862, we think), made a second matrimonial venture in 1866. This lady survives him, as also do seven children, three of whom are the surviving fruit of his first marriage. One of these became the wife of Mr. Paul F. Schuster, who has contributed much in later years toward relieving Mr. Butterworth's mind of many burdensome details connected with the management of the Rockford works. Deceased was one of Rockford's most generous citizens, and no public beneficence or private charity ever appealed to him in vain. His family relations were of the happiest, tenderest character. He was a good man, in the highest and truest sense of the term; and the memory of his straightforward career, and sturdy, honest application to the principles and practice of true benevolence, now robs his death of much of its poignancy. May his "sons their father's fading footsteps see," and may his intimates in our common business harken to the echoes of his counsel, and emulate his professional career.

The funeral services, attended with all Masonic honors (of which craft deceased was a prominent and valued member), took place from his former residence, No. 203 North Main street, Rockford, at 3 P.M. of Wednesday, April 8th.

THE PROPOSED GAS COMMISSION FOR NEW YORK CITY.

The result of the "labor" indulged in by the gas reformers before and after the sessions of the Senate Investigating Committee, who did not discover any of those dreadfully heinous practices which common rumor has for years past attributed to those in charge of the gas supply of New York city, is the appearance before the New York legislators of about as neat a hybrid sort of measure as one could well imagine. The hybrid appears on the Senate calendar as "No. 315," its official baptismal title being, "An Act to establish the Board of Lighting Commissioners for the city of New York." On date of April 8th the Senate made the measure a "special order," and rushed the three readings through with racehorse speed. Only one amendment was made to the measure, and that was of the most trifling description. The vote by which it was passed was, yeas, 20; nays, 1. As it now goes to the consideration of the Assembly, we will wait for the action of the lower house before making any criticism of its features, further than asserting that it is an attempt at legislation which, if its merits were to be tested before a suitable judicial tribunal, would be at once thrown aside as unconstitutional. If the legislators of this State seriously desire that gas company and consumer be adequately protected, let them appoint a preliminary commission (and pay good salaries to commissioners, if the right men can only be secured in that way) whose duty it shall be to determine what that protection shall consist of. The principles underlying the matter are too complex to admit of their disposal in the summary fashion adopted by Sherwood, Thurber and their associates. It took years for the Englishmen to arrive at the present London standard; and we would respectfully submit that that plan is on the far side of perfection even now. And although Mr. Livesey (who should obtain the largest meed of credit for the shaping of the English statutes) is a gas man, we would like to back him at "odds on" for integrity and purity of purpose as against the most shining light of the associated New York covele of professional gas reformers.

[OFFICIAL REPORT—CONTINUED FROM PAGE 174.]

Fifteenth Annual Meeting of the New England Association of Gas Engineers.

HELD AT YOUNG'S HOTEL, BOSTON, MASS., FEB. 18 AND 19, 1885.

FIRST DAY—AFTERNOON SESSION—FEB. 18.

Upon conclusion of the discussion evoked by the topic presented by Mr. Prichard, Chairman Greenough announced that the Association was in readiness to hear the paper submitted by Mr. Edward C. Jones, of South Boston, Mass., on the subject of

AN EXPERIENCE WITH NAPHTHALINE DEPOSITS.

Mr. Jones read as follows:

Our experience at South Boston with naphthaline has been large and varied, ranging from ordinary stoppages of service pipes to the closing up of a 14-inch outlet from a gasholder. Recognizing the value of naphtha, or benzine vapor, as a solvent and vehicle for taking up and carrying off naphthaline vapor, we have made a study of how best to mingle a small quantity of the naphtha with the gas.

Upon receiving a number of reports of poor light from any one locality, it has been the custom to put naphtha into the mains through the riser pipes of the street lamps, and this practice, for the time, remedied the trouble; but still the relief thus afforded was only local, and the difficulty would often appear in another portion of the district.

A 3-inch main, where it crosses a bridge, was a source of great vexation, at times becoming entirely filled with the naphthaline deposit; and again the outlet to the holder at the works became stopped, from time to time, at a point above the level of the water inside the tank—a difficult place to reach with steam or naphtha, and often for hours resisting the utmost efforts to clear it.

In September last we started a new and modern works at South Boston, equipped with large purifiers and connections; and among other happenings under the new order of affairs, my attention was called to the amount of gas lost by blowing out a purifier after it had been put into operation. This amounted to 624 feet every time we changed, and was caused evidently by the amount of gas required to displace the air in the third purifier. If the air is not blown out of the purifier box and connections, but is allowed to pass on into the holder, its presence will materially deteriorate the gas. I have known of instances where this air has organized in a body and marched boldly the entire length of the main street at lighting time, causing the lights to go down and burn with a blue flame, and then come slowly up in quick succession as it passed by. This is most apt to occur in small works, where the cubic contents of a purifier box is larger in proportion to the amount of gas on hand than in a large works. Again, it is more or less dangerous to attempt to blow out all of the air in a purifier. No stated time being allowed for the operation, at one period the air is only half displaced, and again it is more than all expelled, thus causing an extra waste of gas.

Now the question arose, how best to carburet this air, so that it should have a commercial value, and thus make partial amends for the enormous amount of gas lost during the year, and utilize the naphtha vapor as a solvent of naphthaline. About October 1st we commenced using naphtha for this purpose. We raised the cover of the purifier about to be put on, sprinkled the naphtha on the upper tier of lime, and then replaced the cover. This mode of distributing the naphtha was not satisfactory; yet some benefit was realized from it—our reports of poor light diminishing noticeably.

Finding it required a great deal of time and labor to raise and replace the cover, and that the odor of vaporized naphtha was present in all parts of the purifying room, showing a great loss and some danger from handling so volatile a substance, I devised an injector for distributing the naphtha over the lime, inserting it through the plug-hole in the cover.

This device consists of a galvanized iron can (holding about 20 gallons) with a conical top, at the apex of which is a brass cap, through which passes the suction pipe of a small force pump; on the discharge of this pump is attached a rubber hose three or four feet long, with an L-shaped pipe on the end, having a brass spray nozzle capable of dividing the naphtha into a very fine spray, or almost a vapor. The L-shaped pipe is so formed that it may be easily passed through a small hole in the cover of the purifier, and direct the spray of naphthaline over the lime instead of into it.

The can is also furnished with a suitable vent, with a cap to be screwed on when not in use. By removing the plug from the cover of the purifier and inserting the L-shaped pipe, a few minutes' pumping will distribute the naphtha evenly over the lime without disturbing its level surface; and after replacing the plug the purifier is ready to be changed. No naphtha is wasted, there is no odor of naphtha vapor in the purifying room, no air to be blown out of the purifier to be put on, and no deteriorating effect upon

the gas in the holder; and, last but not least, the reports of naphthaline stoppages cease almost entirely.

The quantity of naphtha required to carburet the air in a purifying box and connections is one gallon to each 30 cubic feet, or about one gallon to each 12 square feet of purifier. This will mix with an 18-candle gas, at 60° F., without perceptibly reducing the quality. At South Boston we use a less quantity; with purifiers 14 by 18 feet we use, with good results, 15 gallons of naphtha to each change.

As evidence that our naphthaline trouble is comparatively at an end, I may say that in the fall of 1883 we had continuous vexation from stopped services; but during the time we have, as described, used naphtha in the purifiers, we have had no trouble from naphthaline deposits in service pipes or street mains, and the outlet pipe from the holder at the works has shown no indication of its presence.

From October 7th to December 7th, 1883, there were 72 notifications of poor light; and during the corresponding months of 1884 there were but 42—a difference of 30 cases, or 41.6 per cent. less than in 1883. These notifications included the usual reports of "sags" in connections, bad burners, small fittings, etc., entirely independent from and not in any manner attributable to naphthaline stoppages.

On motion of Mr. Armington a vote of thanks was tendered to Mr. Jones.

Discussion.

The President—Gentlemen, you have just listened to a most practical and interesting paper—one which we all appreciate the advantage of. Personally, I know that about every other year we are obliged to "make a row" at our works because the men in charge of the purifying house will insist upon putting on a fresh purifier just about the hour the city is lighting up. It is rather singular how quickly that air travels uptown, and how speedily the people come hurrying into the office anxious to know what is the matter with the gas. When these hurried visits are made it occurs to me that the purifiers have been changed at about 4:30 P.M. Then I "raise the row," and have that changing system stopped. If we can remedy the difficulty at the expense of four gallons of naphtha, it is well worth considering. I hope the discussion will be general.

Mr. Armington—I would like to have the author explain more clearly how the naphtha is distributed. I believe he claims that he gets distribution over the whole of his lime. I do not understand how that can be accomplished unless he employs pipes lying inside or underneath the cover.

Mr. Jones—The paper explains that an injector, entering the box from a plug-hole in the cover, distributes the naphtha over the lime.

The President—The plug-hole is at one corner of the cover?

Mr. Jones—Yes, sir. The pump which forces in the naphtha is worked at a pressure sufficient to throw the naphtha spray over the lime.

Mr. Sherman—How do you direct its course?

Mr. Jones—By turning the pipe in any direction over the quadrant.

Mr. Armington—Do you think you get at the whole surface of the boxes?

Mr. Jones—I know it. I marked out a space in the yard equal in size to one of the purifiers we have in use, and I found that the naphtha was distributed over the entire oblong square—14 by 18 feet.

Mr. Armington—But you had a free atmosphere in the one instance and a confined atmosphere in the other.

Mr. Jones—Suppose it does not reach every part of the purifier?

Mr. Armington—The pressure was all off the purifier?

Mr. Jones—Yes, the pressure was all off; but we could put enough pressure on the pump to overcome any resistance inside the boxes.

Mr. Armington—Did much gas escape through this pipe in the plug-hole?

Mr. Jones—The purifier was off at the time.

Mr. Armington—But the boxes contained either air or gas?

Mr. Jones—Air was present in them.

Mr. Armington—Did the air escape through plug-hole when you were forcing the naphtha in? If you put 15 gallons of naphtha into a purifier already filled with lime and air, something must be displaced.

Mr. Jones—It will be the air; but to what extent I cannot say.

Mr. Allyn—What grade or gravity of naphtha do you use?

Mr. Jones—We have used the refined naphtha. It can be obtained from any refiner of petroleum, and it costs us 10 cents per gallon. I think the crude naphtha is fully as good; but at present we cannot obtain crude naphtha without purchasing a large quantity. We do not care to store it.

Mr. Allyn—My object was to find out what grade of naphtha gave you the best result. What is ordinarily called 60 gravity naphtha can be purchased at about one-fourth the price charged for that of 80 gravity. If 60 gravity answers the purpose as well, of course its employment would mean a very material saving.

Mr. Jones—I did not make any experiments with the different grades of naphtha. Ours is probably the 80 gravity.

Mr. Sherman—Years ago I remember seeing Mr. Wells, in the Roxbury (Mass.) works, sprinkling naphtha (using a watering can) over his purifiers

previous to letting down the cover. If Mr. Wells is present we would like to hear from him.

The President—He does not appear to be here just now.

Mr. Stiness—When we had the center-seal at our old works, we were of course troubled sometimes by this strata of air passing to the town lights. One of the advantages which may be claimed for the valve system, now in use in our purifiers at the new works at Pawtucket, I can best explain in the following manner: Last Friday (Feb. 13) we changed and cleansed a box; it was filled with lime the following day (Saturday). On Saturday night the back pressure on outlet from No. 4 was opened; the inlet, of course, being closed, the gas passing on to No. 4 purifier may remain until such time as we choose to open the box and put it into working order. With us it often so remains for two or three days; and when finally the confined gas is passed out, it is utterly impossible to detect the presence of any air going along with it. That is one of the advantages which I claim for the system of valves over the common center-seal.

A Member—What do you claim happens to the air?

Mr. Stiness—It mixes with the gas and passes off in such infinitesimal quantities that its presence is almost immaterial.

The President—Mr. Wells is now here; perhaps he can tell us whether he still distributes naphtha in his boxes with a watering pot.

Mr. Wells—We are still using naphtha, and still pouring it over the lime with a watering pot. We have been doing so for five or six years.

The President—What quantity do you use?

Mr. Wells—About twenty gallons each time we change. Our purifiers are 12 by 20 feet.

The President—You put it on before placing the cover?

Mr. Wells—Yes; before dropping the cover.

The President—And the air goes right into use?

Mr. Wells—That is the case.

Mr. Stiness—Do you find any condensation of naphtha in your service pipes?

Mr. Wells—I have never noticed any.

Mr. Sherman—Are you troubled with naphthaline?

Mr. Wells—Not at all.

Mr. Armington—What grade of naphtha do you prefer?

Mr. Wells—One of about 60 gravity.

The discussion herewith terminated, and the President asked if there were any routine matters to be disposed of before taking up the "question box."

NAMING PLACE WHEREIN TO HOLD NEXT ANNUAL MEETING.

Mr. Harbison, speaking for Committee appointed to name a place for holding Sixteenth Annual Meeting, reported that Providence, R. I., had been selected. He explained that the vote in Committee had been unanimous. The report of Committee, after a short discussion, was endorsed by a vote of 20 for to 10 against. On motion of Mr. Harbison, President Greenough appointed Messrs. Slater and Stiness as a local committee of arrangements in connection with the Providence meeting. It was understood that Secretary Nettleton was also to act as a member of the committee. The members of Finance Committee were instructed, on motion of Mr. Stiness, to transfer the books of retiring Secretary and Treasurer to his successor in office (Mr. C. H. Nettleton) immediately after final adjournment.

PROPOSING TO LIMIT THE TERM OF PRESIDENTIAL OFFICE.

Mr. Stedman—It was the understanding of quite a number of our members that the matter which I am about to introduce was acted upon at the last annual meeting. It certainly was discussed at a previous meeting, and the impression is quite prevalent among the members that the matter had been formally acted upon and decided. The records fail to show any such action on the part of the Association; and I desire now to introduce a resolution which will settle the point.

Resolved, That any member elected as President shall not be eligible to a re-election for a period of three years from and after the expiration of his term of office."

The President—You hear the motion of Mr. Stedman. I will say, for myself, that it certainly ought to have been acted upon last year. I thought it had been; but if not I think it had better be disposed of now. Is there anything to be said on this question?

Mr. Stiness—I know this subject has had previous discussion; but I feel, as stated by me in the past, that this Association had prospered under its existing plan of management, and I am satisfied with the course pursued heretofore. I will briefly state my reasons for opposing this motion. It is a plain, practical question. We are not here, as is the case with the American Association, gathered from all quarters of the Continent, and all of whose members it is almost impossible to gather at any given meeting. Therefore a short official term is perhaps a matter of good policy in that Association; although I believe it would be better for the American Association if that clause had not been placed in its constitution. I say to you, gentlemen,

that he who occupies the Chair of this Association to-day can do more and better work for us after having served one term. We may find hereafter, as we did find to-day, that we owe it to ourselves to approve and endorse the position of our President by honoring him with re-election. Mr. Greenough—standing in the position he occupies at present before the citizens of Boston—is entitled to receive an endorsement at our hands—an endorsement justly his due. In time to come we may have others who will occupy a like position, and we may feel it to be then due to ourselves that we pursue a course similar to the one taken to-day; but if you pass the proposed resolution our hands would be tied, and we should find ourselves powerless to stand by our standard bearer. Earnestly do I hope that the motion will not prevail.

Mr. Stedman—I am not tenacious about this matter, and I am not clear in my mind as to whether it would be our best policy to adopt this resolution; still it is one that represents quite a prevalent sentiment as expressed here last evening in an informal discussion of the topic. Disappointment was expressed that the matter had not been disposed of at a previous meeting; and many members supposed it had been definitely settled. The President also spoke this morning in favor of the measure. I do not mean to argue about the expediency of the resolution; but it is simply left for your decision to determine whether the proposed rule would subservise the best interests of the Association. Our membership is large, and, as remarked this morning by our President, we have in our ranks numbers of men competent to assume the duties of the Chairmanship. It would seem rather invidious, remembering it has been our custom to continue a President in office for two terms, to single out any one individual and refuse to name him as his own successor, be the cause for such action what it may. This resolution would do away with that trouble, and would offer quite an extensive chance to our members to obtain the "perquisites" and "emoluments" of the office.

Mr. Nettleton—I am very sorry to differ from Mr. Stiness, and it seems to me the resolution ought to pass. We have been very fortunate in having good Presidents up to the present time (laughter); but we cannot always hope to be equally fortunate. Now, as Col. Stedman says, it has become a custom of this Association to re-elect each president at least once, and if ever we should be so unfortunate as to have a man in the Chair whom we would wish out, and should not re-elect him at the end of his first year, he would feel very much hurt, and the Association would be annoyed unnecessarily. By passing this resolution it does not become a part of our By-Laws; and if for any reason it becomes desirable hereafter to re-elect a President, this motion can be rescinded and the present custom can be re-established. I hope the motion will pass.

The President—You have heard the case properly argued. Those in favor of the passage of the resolution, "That any member elected to the position of President shall not be eligible for re-election for a period of three years from and after the expiration of his term of office," will say, "Aye." Those opposed, "No." The Chair is in doubt. Those in favor of the passage of the resolution will rise from their seats. [A count developed a tie vote—14 in favor, 14 against.]

A short resumption of discussion ensued. Mr. Stiness hoped that all the members would vote on the question. He re-affirmed his belief that the best interests of the Association would not be served by its passage. Mr. Hill believed that the Association should not tie itself up by any such procedure.

The President announced that a second rising vote would be taken. When the preliminaries of same were concluded the Secretary reported that 14 were against and 12 in favor of the passage of the resolution. The President declared the resolution not passed.

TAKING UP THE QUESTION-BOX.

The President said the next business in order would be a discussion upon the queries taken from the question-box. The first question taken therefrom was entitled,

"What advances have been made in electric lighting during the past year?"

Mr. H. H. Fish, Treasurer of the Utica (N. Y.) Gas Light Company, was called upon to express his views on this matter. Mr. Fish responded as follows:

Gentlemen, while thanking you for the courtesy of your invitation, I must acknowledge that I am not in any practical sense entitled to the distinctive appellation of "gas engineer," as my connection with your industry was only arrived at after having spent many years of life in mercantile and commercial channels. Not being even a practical gas man, and much less an electrician, how can you then expect me to mention anything worth recounting in regard to that more subtle illuminant whose progress during the past twelvemonth you propose to discuss. Fifty years ago, on my first visit to New York city, the most striking thing that claimed my attention was the operation of a gas plant. Before I ate my first meal in the metropolis I had

paid a visit to the works of the only gas light company then existing in the city of New York; and I presume the entire money investment at that works did not exceed \$30,000. When I reflect what steps have been taken in the short space of fifty years towards the development, progress and enjoyment of artificial illumination I may honestly assert that the gas maker's business stands second to no other one of those great industries which owe their creation and importance to the direct needs of the people of civilized countries. It was many years after that visit when I became identified with your craft, but still at a period sufficiently remote to be entirely conversant with the benches of three iron retorts, which would produce but about 6,000 cubic feet from the distillation of a ton of good Piedmont coal. You gentlemen understand much better than I do the approximate steps by which we have emerged from those humble conditions of working with iron retorts, at poor heats, etc. I may claim that I was among the first of those to try the clay retort—having imported a few from Belgium; and, as I remember, the importation was a cause of grave annoyance to my board of directors, composed as it was of lawyers and professional men. Step by step have we advanced until now we have the most approved forms of regenerator furnaces for heating benches of fours, sixes and eights. Indeed, since my visit here, I have inspected a plan for a setting of nines, which, I am assured, can be made to yield 90,000 cubic feet every 24 hours. In every other department of our business there has been registered a corresponding progress. From humble beginnings and high prices we have been enabled to reach that point where we are now furnishing an artificial light almost as cheap as sunlight. Having explained that I am not a trained gas engineer, and that my connection with the Utica Company has chiefly been but to look out after the pecuniary results of our operation, I have still always welcomed a trial of what purported to be an improvement, and so have thrown the Utica plant open—many of the fraternity think unwisely—frequently to the experiments of "adventurers," in the persons of men who claimed to have what they really had not. Among other experiences, ten years ago we extended to Mr. Lowe this privilege, who said that he could produce certain results with the agency of that process which we now call the "Lowe process." I told him I would not discuss the question with him, but he could come to Utica and make practical demonstration of his promises. I put our plant under his command for the space of time he specified, and I must say he made a most conspicuous failure of his attempt. He presided in person over the trial; and those who gave him financial backing lost their money. In the course of his experiment certain things were developed which looked to us as if they might, with proper handling, be turned to useful account. Another party took up the hints thus given, and with the result that ten years ago our city was lighted with what is called water or oil gas. We lighted our city (containing about 35,000 people) with it exclusively, using a very imperfectly constructed apparatus (one which had been very hastily improvised), for accomplishing the end in view. This apparatus became destroyed by fire, and then we returned to the old methods. Recently (or about two years ago) we ordered what is known as the "Granger Process," or the "Granger" style of apparatus for making what is familiarly known as water gas. Since last March we have been supplying our city exclusively with this gas; and very satisfactorily to our people too. Now, while all of you will sympathize with me when I say that we are not in the habit of getting more than is due to us from the journals of our neighborhood, on the morning I left home our daily paper published a list of ninety gas light companies in various parts of the United States, with a statement of candle power, and prices at which gas was furnished; and I had the great felicity of having my own paper (not over-generous in such matters) proclaim to its readers that our company stood at the head of the list, excepting only those who were located in the heart of the coal country.

In carrying out (where we could without prejudice) this principle of admitting a trial of improvements of any kind, I have also had, during the last three years, an electric plant in connection with our gas business. In the first place we got together a small plant, erected poles and wires, and allowed the different electric companies to experiment on what they could do. They could put on their own apparatus, lanterns, and dynamos; and, in fine, attempt to produce the results which they claimed for their systems. We paid the expense of plant, and they paid the expense for power. We went on in that way for eighteen months; and finally I became satisfied as to what was then the best system, as proved by a half dozen or more different ones experimented upon. We purchased that plant, and have been lighting a portion of our city with the arc system of electrical illumination. Now, so far as my experience goes concerning the question whether arc lighting is capable of doing injury to gas lighting, as exemplified in the "trial" portion of our city, the shopkeepers of that district are continually calling for more gas; and all because it certainly would not do for their stores to be less illuminated than the streets outside. Instead of lessening the sale of gas, it has largely increased it. I give you this as matter of actual practical experience, and I have had no reason to regret the experiment. There is no money in electric lighting. It cannot compete, single-

handed and alone (at present prices), with gas for lighting purposes. It makes a brilliant show, but in my judgment it never will come in competition for the great bulk of lighting now enjoyed and controlled by gas, unless it is vastly improved over what is the case with it now, and especially unless its expensiveness is greatly reduced. The question is one of economy merely. The incandescent light is certainly a very handsome one, but it is vastly more expensive than is gas. I must say that I have seen incandescent electric lights which, for excellence, comfort to the eye, and steadiness, were such that we might do well to attempt to reach their standard.

I am greatly obliged to you for the courtesy you have extended to me. I am sorry I am (owing to the effects of a recent dental operation) in so dilapidated a physical condition as to make me unable to respond more fluently to your polite invitation.

The President—Which electric system did you prefer and finally select?

Mr. Fish—I purchased what is known as the Thompson-Houston.

The President—I would like to say that the last improvement I have seen in electric lighting employs a very large incandescent burner. One of the first of these large burners was put up this winter in a Boston book store. It gives a light of about 100 candles, and it is the best illuminant for a store that I ever saw—more steady than the steadiest of gas lights—and gave out no heat to speak of.

Mr. Craft—I would like to inquire as to the relative expense of running the incandescent light (which the President has referred to) and that of gas. The President—I do not really know that. I think the gentleman who had it told me he paid forty cents a night for it.

Mr. Craft—In your judgment, how much gas would furnish the same amount of light?

The President—I think we could supply the same amount of light fully as cheaply with gas. There is no question about it, but the incandescent light was the better light. I suppose the price at which it was put in was not a remunerative one to the electric company. This company was trying to introduce them. The Electric Company, of Boston, as I understand it, have made no money at the prices at which they are supplying light.

Mr. Stiness—If I understand Mr. Greenough aright, the same quantity of light could be furnished at a rate which would pay a nice dividend to the gas company; while the electric light was furnished at a price that paid no dividend.

The President—Probably. I am not prepared, however, to make that statement. I had never before seen an incandescent burner which gave a light of over fifteen or sixteen candles. This had a loop, perhaps six or eight inches long, and certainly gave a very beautiful light, and without affecting the atmosphere of the shop in the same way that a large gas burner would have done.

Mr. Stedman—I would like to call the attention of the Chairman to the application of the Siemens light as made on the Sound steamers. All the Newport and Fall River line boats that formerly were lighted by gas, are now lighted by electricity; and, in every case, the convenience of the light, and the possibility of manufacturing it on board, makes it a very desirable one. I believe it is a great boon to the traveling public. The cost, however, I am told by the supervising engineer, who lives at Newport, is greatly in excess of the former cost of gas. He said it was more expensive than gas; but it was such a great convenience, and so far in advance of any other system of lighting, they were prepared to pay the additional expense, and were very glad to get it even at that advance.

Mr. Stiness—In case of accident to the steamer, would the steamer have any light?

Mr. Stedman—They keep candles and oil lamps. (Laughter.) They have one or two of the large incandescent burners on the upper deck—not so large, though, as the one that has been described by the President.

THE CONGRATULATORY TELEGRAM ANSWERED.

The President—In accordance with the suggestion of the Association, I telegraphed Gen. Andrew Hickenlooper this morning our congratulations on the birth of the new gas Association of Ohio; and in response thereto I have received this answer:

"M. S. Greenough, President New England Association of Gas Engineers, Boston, Mass.—Accept thanks for your congratulatory telegram. We appreciate the tender of fellowship from the mother to her last-born child. A. Hickenlooper, President Ohio Gas Association."

SECOND DAY—MORNING SESSION—FEB. 19.

The Association reconvened at hour named when adjourning. The President announced that the question-box queries and answers would be proceeded with. Question No. 2 was,

"What is the effect of atmospheric change upon the candle power of gas—especially a low barometrical pressure?"

Mr. Prichard—According to some authorities reduction of the barometrical pressure increases the bulk, and consequently reduces the candle power of each foot of the gas. Although the candle power would be the same fo-

the whole original foot, yet the foot is larger—if I may so express it. I also found that when the barometrical pressure was high, the air was more dense, and a more vivid combustion was produced—that the slight increase of intensity increased the candle power.

Mr. Boynton—That question was suggested by my experience during the past winter. I found that on certain days it was very difficult to keep my candle power up to standard, and to keep the gas up to a constant pitch. There was to my mind no clear reason for this failing. I had to resort to extra amounts of enricher to keep up the usual quality. I found, from a comparison of dates with reports of the Signal Service, that it always occurred on days when there was a low barometer. The first impression would be if the barometer is high that the gas would burn easier—that any gaseous matter would rise through the atmosphere more readily; but that is not according to the facts. In the morning we frequently see the smoke from chimneys hugging the ground, and people say the air is heavy; yet the contrary is the fact. On the other hand, when there is a high barometer, you see the smoke rising out of the chimneys in a straight column and ascending upwards into the air. Take a chimney that is sometimes troublesome because of its "smoking." When is it the worst? When there is a high barometer, or when there is a low barometer? It is always the most bothersome at a low barometer. When the barometer is high the dense, heavy atmosphere will permit the smoke to ascend freely and the chimney will cause no trouble. Frankland may be quoted to the effect that with low barometer a better flame is given. It seems to me that that is not the fact. I put the question into the box thinking other members of the Association might have had an experience similar to mine. It seems to me the correct principle is that the lower the barometer the poorer your gas light will be. I found that it affected my gas (ordinarily 17½-candle power) to the extent of half a candle.

The President—I think we may consider that question as having been answered. The next query is—

"Is a pipe around the retort house, between the hydraulic and exhaustor, of any practical value?"

That of course must refer to the relations between hot tar and gas. Some of the gentlemen have been building new works, and have probably considered the matter. We would like to hear Mr. Stiness' judgment about it.

Mr. Stiness—It would seem, perhaps, that question, in its "fullness," might go a little further. Under certain conditions, and under certain circumstances, a pipe running around the retort house might be of benefit, as a means of condensation, provided the other apparatus was not sufficient. In the new works which I built I looked into the matter of an English patent, an account of which was published in a recent number of the AMERICAN GAS LIGHT JOURNAL,* in which the patentee, Mr. H. Aitken, speaks of the great benefit of keeping gas in contact with hot tar. In my particular case, I think that I have accomplished results equally as good as those he describes, and without the application of the machinery which he employs on top of his benches. I have no doubt that, if a condensing apparatus were insufficient, his plan would afford a means for condensing. If there is any value in his statement that, by keeping the gas in contact with the hot tar, you thereby retain the naphthaline, then his plan is beneficial; but in our particular case we thought it was not best to cool the gas off too quickly. I think the peculiar circumstances and conditions of particular works must be taken into account before the matter can be decided in any set instance.

Mr. Slater—We have had a little experience bearing on this point. You will recollect, some two or three years ago, when we first started the Dieterich furnaces, I made the statement that shortly after firing up those furnaces our candle power began to increase, and we kept reducing the cannell until we got down to one or two per cent., finally abandoning the enricher altogether, and yet maintained the original candle power. Starting in at that time with the Dieterich furnaces, it was supposed their working had much to do with the gain in illuminating value so suddenly experienced. The retort house, as originally constructed, had the take-off to the condenser house in the center of the house; at one end of the retort house was a stack of 20 benches of sixes, and at the other end was one of 24 benches. In reconstructing the retort house we divided up the two long stacks, and built two stacks of eight benches each on either side. When we fired up the Dieterich furnaces we started the stack next to the take-off that went over to the condenser house; and when we had abandoned that stack, and started the one on the extreme end of the house (or at a point where the take-off had to run the whole distance of that side of the house to make connection with take-off going over to condenser house), of course a much longer pipe was traveled in the transit. We found that we had to use 7, 8, or 10 per cent. of cannell to maintain the candle power that we had under similar conditions with the first stack. Finally we came to the conclusion that this long take-off line had something to do with it. In that view, we covered this take-off, from stack on extreme end of house, with hair-felt and asbestos cloth; and since

that time we have found that we could maintain the same candle power with much less cannell—thus showing that the hydrocarbon vapors were largely condensed in the long pipe, which was exposed to considerable cold.

The President—Instead of taking anything up from the gas, you actually increased the candle power.

Mr. Slater—Exactly.

Mr. Stiness—You cooled it too quickly before?

Mr. Slater—Yes.

The President—Here are two questions which can be taken together. The first is—

"What candle power coal gas can be maintained by enriching with naphtha introduced with steam into a retort of the ordinary setting?"

The second is—

"Which is the best method to use oil as an enricher, and the kind to be used?"

Those two questions can be considered at the same time. Perhaps Mr. Jones, of South Boston, will give the results of the way in which he uses oil.

Mr. Jones—At the South Boston works we use petroleum residuum for the enriching of our gas, or the heavy oil from the bottom of petroleum stills. We mix it with breeze, or saturate the breeze with the residuum, and put it on top of the charge of coal. The men who charge the retort throw in a shovelful of this mixture. The breeze is employed simply as a vehicle for holding the residuum; we find it to be better than fine coal, and have made experiments with almost everything. We use about 2½ gallons of this heavy oil to the ton of coal carbonized, and maintain from 18 to 18½ candle power gas.

Mr. Neal—I have, acting upon a suggestion from Mr. Jones, used that method for quite a length of time, following his plan very accurately; but I do not get as good results as those obtained by that gentleman. Indeed, the method failed to exert any beneficial effect upon the candle power. Nevertheless, though satisfied as to its non-influence upon the illuminating value of the gas, I continued the system in the hope of preventing naphthaline deposits. Defeat also met this endeavor. After a visit made by our superintendent to a New York gas plant, we adopted a very simple process which he saw in use there. It consisted of injecting naphtha with steam into the retorts. Mr. Prichard has tried this plan very thoroughly at the Lynn works, and I think if called upon he will explain the method.

Mr. Prichard—We were using the residuum at the time the matter came up, but were dissatisfied with the results produced. It seemed to me that we were introducing oil just at the very time of the charge when we were producing the richest gas; consequently we did not produce carrying gases enough to carry it along, and possibly left it in the hydraulic main. We looked around for something else, and as a result of several inspections of different processes we placed in the retort a steam injector, and injected the oil by the aid of steam, making it travel three or four times the length of the retort. Any means can be adopted which will accomplish that end. The steam seems to keep the temperature of the retort at just the point needed to produce the best results from the oil. The consequence is that we have been able to get along very well. As the result of three months' use we increased our candle power by one candle; and the average expense for the three months was only \$28. Of course we used a greater value of oil than that, but deducted from its cost that of the coal which we did not use, owing to increased yield.

The President—What quantity of oil was that per thousand feet of gas, or how much oil per ton of coal?

Mr. Prichard—We used all the way from one-quarter to three-quarters of a gallon to the thousand feet of gas, according to the temperature. We are using now about 5 gallons to the ton of coal.

Mr. Neal—I think that up to within a month at Charlestown we used about half a gallon per ton of coal. Our candle power was brought to as high a point as 18½. We are using iron sponge in purification, and the employment of this material is said to cause perhaps a depreciation of one-half candle in illuminating power; but still, even with the use of the iron sponge, our candle power has been increased. I consider it the very best manner of enriching. We did employ a superheater—an iron pipe for the steam running through the lower tube and under the bottom of the retort. It was very difficult to keep that pipe from being destroyed by the heat; and so we are now working without superheating the steam at all. At my works the boiler is some distance from the retorts, and the steam pipe runs quite a length in the yard. It is true that it is covered with an asbestos jacket; still, although considerable water goes over, I find our results are nearly as good as the best.

Mr. Harbison—At what time of the charge is the naphtha put in?

Mr. Neal—It is put in a retort by itself, and this retort is kept in action constantly. Steam must be kept continually passing through the pipes in order to prevent them from melting down.

Mr. Stiness—Before Mr. Prichard described to me his method of working

* See JOURNAL, Vol. XLII., Feb. 2, 1885, p. 68.

I was using oil as an enricher under the common injection plan. After he spoke to me I set apart the lower retort of a bed of sixes, and have been running along in that style now for about two months. I must say that I consider it one of the very best arrangements I have ever seen for this use of oil. A $\frac{3}{4}$ -inch pipe runs inside of a 2-inch pipe; then it passes back through a 6-inch pipe; then passes up through the retort, and out through the stand pipe in the usual form. There is no coal used in that retort; its duty is to carbonize the oil for enriching. The steam is kept continually passing through. I have a plug-hole in the mouthpiece by which I can tell the heat of the retort at any time. We have never made any lampblack; and we know from the tap which we have upon the stand pipe as to the quality of the gas that we are making. If any member desires to use oil, and will consult with Mr. Prichard, he will give him a description of the process; and I would advise every member of the Association who is desirous of using either oil or naphtha for enriching purposes to adopt Mr. Prichard's method of working. The oil we use is of 55 density.

Mr. Geronld—We use the same quality at Manchester; but the size of pipe running into retort is smaller than that spoken of by Mr. Stiness. We run it in with a $\frac{3}{4}$ -inch pipe, bring it back with a 2-inch, and then it flows out into the retort. We use about 50 gallons of naphtha in sending out a daily average of 360,000 cubic feet of 18-candle gas.

Mr. Learned—I would like to ask Mr. Prichard if he finds any increase in the carbonic acid caused by injection of steam.

Mr. Prichard—At one time I drew off some of the gas and tested it for carbonic acid and carbonic oxide, and found about 2 per cent. of the former and about 8 per cent. of the latter in the mixture. This proved that the steam did make a trifle of water gas, and did combine with the oil to a certain limited extent. We cannot tell just how greatly it increases the carbonic acid, because we use iron sponge entirely, and fear we lead the New England Association in the amount of carbonic acid gas contained in our product.

The President—The question after all is, "which is the cheaper way of enriching gas—whether with naphtha or with cannel?" Mr. Slater has enriched with both these materials, and we would like to hear his opinion.

Mr. Slater—We are now using cannel entirely. Our experience with that use of naphtha was rather crude. At the works (the former opposition plant) where naphtha was employed, they followed the practice of placing an iron pan in the retort, and injecting the naphtha with the aid of air pressure. It was supposed to be driven nearly to back end of retort, and then converted into gas on coming back again to standpipe; but, as matter of fact, little of the naphtha was converted into gas. It was found more or less in the drips, and was discovered even throughout the main pipes.

The President—I would like to ask some of those gentlemen who have been using naphtha what, as the result of their experiments, they think the value of naphtha really is. I propose the query for this reason: We have been making some experiments in that direction with the idea of determining, all things considered, what would prove the most economical form of enricher. We tried the method of injecting naphtha into the retort, afterwards collecting the naphtha gas to arrive at the volume and the candle power it possessed. About the best we could do per gallon was to obtain somewhere between sixty and seventy feet of 50 or 60-candle gas. If we carried the yield up any greater we found a shrinkage in candle power. When you convert the yield into candle feet, or convert it into water gas, it would seem as though a good deal more candle power ought to be got out of a gallon of naphtha than we succeeded in obtaining. Possibly this may come from the higher temperature of the flame which is given for carbonic oxide. If any gentleman here can secure from naphtha a yield of sixty feet of sixty-candle gas, or eighty feet of fifty-candle gas, I would like to have him say so. What is Mr. Geronld's experience?

Mr. Geronld—We have not experimented in that direction. We have only noticed the illuminating power of our gas when working under the injection plan, and using 150 or 200 gallons of the "gas oil," would approximate to 17½ candles. Since using naphtha in the way described the candle power has run up to 18½.

The President—Then the oil you employed before was not naphtha?

Mr. Geronld—No; it was a regular "gas oil."

The President—And you think naphtha is very much better?

Mr. Geronld—Yes, sir.

The President—What do you get from the naphtha, Mr. Prichard?

Mr. Prichard—About sixty feet. I believe in using the lighter oil. We tried the residuum, afterwards tried the "gas oil," and finally the naphtha; but we found that the lighter the naphtha was the better were the results we obtained. My idea is that you have not got so much carbon to deposit, and you can make a permanent gas much easier.

Mr. Geronld—We have tried the plan of injecting oil, and we found that lampblack was deposited in the retort. We could not get rid of it. We used steam without superheating, and still got the lampblack; but with naphtha we did not get it at all.

Mr. Sherman—Some of the gentlemen may have seen the paper which was

read before the American Association at Pittsburgh.* The writer of that paper had an extended experience in the distillation of naphtha for gas purposes; and he stated that sixty feet of 80-candle (or eighty feet of 60-candle) gas was about the product on and illuminating value of a gallon of naphtha. According to his figuring the quantity of gas weighed as much as the oil; and that was "the cat and the skin." (Laughter.)

Mr. Neal—Although I like the Prichard process, and while making five feet of gas to the pound, I have carried up the candle power higher than we ever did at the Charlestown works; still, if I could get a moderately small cargo of Cannelton coal I should use it in preference to the naphtha for enriching. Cannelton cannel yields a fair quantity of good coke; but the difficulty with us is in getting a small cargo brought to our works.

Mr. Nettleton—I would like to ask the gentlemen who recommend the use of naphtha if they have any complaint to make as to the gas smelling of the oil. We used naphtha for enriching some years ago, and, so far as I know, the people were not aware of the fact; yet I had some complaints brought in that the gas smelled like kerosene. As a consequence I felt compelled to stop using it.

Mr. Prichard—If the gentleman makes oil vapor the gas will smell of oil; but if he makes a fixed naphtha gas, where enriching with it, there is no reason why the resultant gas should smell of oil. How could it when the oil has been thoroughly decomposed?

Mr. Stiness—I use three gallons of oil to the ton of coal. I have a cock placed upon the stand pipe by which I can always tell exactly how I am working. If at any time I find that the heat of the retort has gone down I instantly shut the steam off. We send out an 18 or 19-candle gas. Working in this manner you can bring your illuminating value up very quickly.

Mr. Stedman—What did the gentleman consider as his chief object in using steam? Was it for the injecting of the naphtha, for the purpose of keeping the retort at the necessary temperature, or with the object of effecting chemical combination of the products resulting from the decomposition of the naphtha?

Mr. Stiness—Injecting naphtha and reducing heat.

Mr. Prichard—I believe Mr. Stedman was not in the room when I first spoke. My notion of such use of steam is that, in the first place, it is useful as an injector, and that it forms a sort of vehicle to carry off the particles of carbon. You can control the temperature of your retort by the steam; in fact it serves a number of very useful purposes.

The President—I will say the result of the experiments made by us, although we did not push them very far, point to the conclusion that if we were desirous of making 20 or 21-candle gas that illuminating value could be secured at a less expense with naphtha than with cannel coal; on the other hand no money can be saved in using naphtha enricher when sending out 18-candle gas. I have yet to hear of any works where cannel is easily obtained that abandoned its use and substituted naphtha therefor. There are disadvantages connected with the employment of naphtha as an enricher which do not admit of solution, and on the score of economy too. How is it with you, Col. Stedman; do you not use cannel?

Mr. Stedman—Yes; we rather prefer it to naphtha.

[To be Continued.]

[OFFICIAL REPORT.—Continued from page 177.]

Papers Read before the First Annual Meeting of the Ohio Gas Light Association, with Discussions on Same.

FIRST DAY—WEDNESDAY, FEB. 18.—MORNING SESSION.

The discussion on Mr. Bate's paper having terminated, President Hickenlooper announced that two gentlemen had presented communications on the topic next to be considered; he suggested that the authors be in turn requested to read their papers, so that contents of both might be discussed conjointly. This course was agreed to, and General Hickenlooper introduced Mr. E. McMillin, of Columbus, Ohio, who read the following paper on

THE PREVENTION OF NAPHTHALINE AS A DEPOSIT IN GAS WORKS PLANT.

This subject, fruitful of so much annoyance, has not been fruitful of much literature. "King's Treatise" barely mentions it; gives us no light on the question of its production, nor tells us how to prevent its crystallization and consequent deposition. Bowditch discusses it, but not so exhaustively as the importance of the question would seem to demand.

Its symbol is $C_{10}H_8$. You will observe from its composition that it is very heavy—4½ times as heavy as air. It is not surprising, therefore, that it is deposited at inconvenient places about the works, in the mains and services, and in the consumers' meters. When chemically pure it solidifies in the form of beautifully white crystals. When found about the scrubbers it is

*See Vol. XXXVII., No. 11, pp. 252-255, Issue Dec. 2, 1882.

generally dark-gray, or almost black—made so by the intermixing of foreign substances. When found on top of your fouled oxide boxes, where it has dropped from the sides and top of box covers, it is thin, and clear almost to transparency. When blown out of service pipes it is found mostly resembling flakes of polished steel.

Naphthaline is probably formed during two stages of the carbonizing period. First, when the heats are greatly reduced by the introduction of the fresh charge of coal; and, second, toward the close of the period of carbonization, when the heats are very high.

During the first stage it is drawn off probably as it bursts from the solid coal; and, being surrounded by or dissolved in other rich hydrocarbons of less density and more stability, it is carried along through the works and gives the manufacturer no trouble, at least until it has passed through the gasholder.

During the second stage, or that of high heats, it is formed by the decomposition of the lower hydrocarbons—possibly, and indeed probably, that of CH_4 . It seems strange that at this stage of the process it should be possible to have decompositions occurring diametrically opposed, or apparently so. We usually attribute the formation of pure carbon to the decomposition of hydrocarbons, setting free the hydrogen and depositing the carbon; and at any rate leaving the gas heavier in carbon than before. But experiments have demonstrated that at this same stage hydrocarbons are broken up, hydrogen set free, and a richer hydrocarbon (naphthaline) formed. My own idea is that the opposing results are brought about, not by the decomposition of similar hydrocarbons, but of compounds belonging to different series.

We are probably more interested in how to be rid of its annoyance than in knowing how it is formed. All coal gas works make it. The question is, "Can we carry it in a gaseous state to the tip of the consumers' burners, and with it there add brilliancy to the light?" It is generally conceded that sudden cooling tends to augment the deposition of naphthaline; but we must not confuse the idea of low temperature with sudden change. To quickly cool gas from 140°F . to 80°F . would probably give more trouble from naphthaline deposit than would the slow cooling of the gas from 80° to 10° below zero; though in the latter instance the total change is much greater than in the former.

Suddenly cooling your gas not only affects the naphthaline directly, but also incidentally it causes the deposition of the carriers of this heavy gas, condenses the solvents, and lets fall the naphthaline, as it were, of its own weight.

I would therefore suggest the advisability of cooling your gas slowly; use the least possible quantity of water; do not use lime for sulphur purification (and thus necessitate the throwing away every day of large quantities of rich hydrocarbons); keep your gas up to 18 candles; lay your mains below frost; and, if possible, have no service pipes passing through areas at the sidewalk unprotected.

If all these conditions are observed you will experience little annoyance, and even secure great benefit, from the formation of naphthaline. Five grains of naphthaline is said to be worth, as an illuminant, 140 grains of common coal gas. If this be true, it should be regarded as a friend rather than an enemy of the gas man.

Bowditch tells us that naphthaline chemically combines with the coal gas at warm temperatures, but that the union is so feeble that it is broken when the temperature is much reduced. I cannot believe that there is any chemical union; I think it is carried along as is water vapor, and that sudden cooling compresses the gases and condenses the naphthaline—squeezes it out of the gas.

The second paper on this subject was written by Mr. Joseph Light, of Dayton, Ohio. Mr. Light was unable to attend the meeting, and forwarded his communication to the Secretary. When Mr. McMillin had concluded his presentation of the topic, the Secretary submitted the following as Mr. Light's views upon the matter—

Mr. President and Gentlemen: I think that our worthy Secretary has made a mistake in asking me to read a paper on the subject of, "The Prevention of Naphthaline as a Deposit in Gas Works Plant." My experience with that pest of gas managers is luckily rather limited, and there are other brethren here who have had more extended knowledge upon that question than the writer, and consequently are better fitted to do the subject justice. What little trouble I have had has been almost altogether encountered in my street mains and service pipes. I will, however, state what has come under my observation with reference to it.

In the spring of 1883 we purchased one year's supply of coal. Our coal house not being sufficiently large to contain it all, we were compelled to stack a goodly portion of it outside the sheds, or where it was exposed to the weather. Knowing that I would have to use this outside coal every day, if I wanted to absorb it all before the rough weather set in, we took the coal, wet and dry, just as we found it. During the latter part of the summer and through the fall season complaints were made at our office by our consumers

about want of pressure. Sometimes the complaints came from the west side, or low part; and next complainants would appear from the east or high part of the city; and so the trouble went on. In our investigations I at one time found a 2-inch main filled so completely that no gas would pass through it. I resorted to naphtha to dissolve it.

Our trouble continued in a varying sort of way until cold weather set in; then with winter's arrival the naphthaline disappeared, and so we experienced no further bother from it. In 1884 I concluded I would make a slight change, inasmuch as I determined not to carbonize any damp or wet coal during the summer months. When we could not get any dry coal from the heap not stored, I used the coal that was put in the sheds. I am pleased to say my experience was such that complaints of naphthaline deposition were few and far between.

The coals used in 1883 and '84 were of about the same grade, coming from the "second pool" of the Youghiogheny River. Our mode of working in summer of '84 was just the same as that of the previous year. Our heats were, if anything, a trifle higher during 1884. Our only change, in fact, was in carbonizing only the dry coal; but I may say, acting under the advice of a friend, I covered the water inside of my gasholders with a light crude oil of about 45 gravity. I also put some of it in the drip boxes, which had a beneficial tendency.

Discussion.

President Hickenlooper hoped all the members would have something to say in regard to topic treated of by Messrs. McMillin and Light.

Mr. Bate said he had some experience with naphthaline deposits. At the September meeting he made the remark (one he had often heard others make before) that he did not know what naphthaline was. Some one at the time suggested that when he (Mr. Bate) went home he might find plenty of it. After his arrival at Tiffin he did "find" it. When the naphthaline bother was first encountered by him he did not really know what was causing the stoppages at his works; but he did know that suddenly the plant (it was on night watch) had been completely "choked off." He instituted search for the cause, and upon opening the coke scrubbers found a dirty, greasy oil deposited in them. He also found considerable accumulation in inlet connection to the purifiers, and also in the boxes. At the first onset no deposits were found at points beyond the purifiers. On the second discovery of its presence the deposits were found at inlet of holders. He procured ten gallons of 74° naphtha, lifted up the purifier covers, and thoroughly wetted the lime; then turned the gas on again, and had no more trouble for that time. He, as said before, experienced other attacks from the same enemy, but the naphtha application put it to rout. Mr. Light offered the theory that wet coal causes naphthaline deposit. Mr. Bate happened to be carbonizing the driest sort of coal at the time he first encountered the trouble; and he might also say that during last January his coalmaster had been delivering very wet coal to the Tiffin works, yet not even a trace of naphthaline had so far manifested itself. He might justly claim as his opinion that the wet coal argument was not sound. He was using a steam jet exhauster; and he found that at times, in consequence of carelessness or inattention to its working conditions the men would allow everything to become completely overheated. Under these circumstances permitting a cold stream of water to enter the coke washer and strike the overheated gas, led him to believe was the real cause of his naphthaline trouble.

Mr. McMillin noticed that Mr. Light attributed the formation of naphthaline to wet coal; and the speaker failed to penetrate either the philosophy or chemistry of the statement. Mr. Light had trouble when carbonizing wet coal; but the author of the paper would probably discover that a great many gentlemen were there present who had had the same trouble when working with dry coal; but, on the other hand, did not encounter naphthaline at time of using wet coal. He thought the wet *vs.* dry coal theory was not apt to be of much account.

Mr. Converse asked what would be the effect on naphthaline when using oxide of iron in the purifiers? He understood the oxide would destroy any greasy or tarry matters so deposited.

Mr. McMillin did not think such was the case.

Mr. Hamlin said his experience with naphthaline was quite similar to that recounted by Mr. Bate. He hardly knew what it was; but during a conversation, in which he heard the characteristic features of naphthaline spoken of some time ago, he then recollected (and had solved the reason therefor) a stoppage that occurred some five years since at his works—which were on a small scale. On that occasion he found the outlet from the condenser completely choked up with a thin, scaly substance, brown in color, and vile in smell. The brownish tint, he concluded, was owing to tar admixture. When the flakes were carried into the open air and exposed to the light they dissolved. That was the extent of his trouble with naphthaline deposit. All portions of his apparatus were free and clear of its presence. He used a steam jet exhauster, and he made it a point during cold weather, at the periods when not making gas, to keep a small jet of steam passing through to keep the pipes and scrubber warm. His idea in having a spray of steam

constantly playing on the coke in scrubber was to prevent the coke from becoming very cold, so that when the gas was turned on to the vessel it might pass freely through the coke filling—for undoubtedly the gas would find a quicker passage through the interstices when the coke was properly warmed than would be the case if the filling material were allowed to become very cold. It was a very small jet—not sufficient to cause any overheating; in fact, of just the dimension to accomplish the object sought after.

Mr. Bate thought that Mr. Hamlin's scrubber differed from the speaker's. Mr. Bate's scrubbers were located in the purifying house, and consequently were never allowed to become cold. Some years ago a method followed by a friend was described to him. This friend explained that he inserted a jet of steam into the coke scrubber, and he did so with the purpose of keeping the coke free of tar—by thus warming it up. He (Mr. Bate) did not believe in that plan; for when he attempted a similar policy the tar became cooked into such a solid mass that the works were completely shut up from it.

Mr. Hamlin explained that his way of passing steam neither overheated the scrubbers nor cooked up the tar. The small jet of steam was only turned on when they were not making gas.

President Hickenlooper gave a hint or two as to the naphthaline experiences at the Cincinnati works. He did not think any of the previous speakers had assigned a good reason for naphthaline formations. He believed the causes at work in Cincinnati must be unique, inasmuch as they could tell when it would appear and depart. They could expect it on the first of November, and it remained with them for fifteen days; the second visit would be made on March 1st, the spring visit equaling in duration that noted in the fall.

Mr. Dittmar agreed with President Hickenlooper. A great many theories had been suggested. One superintendent claimed one thing, while a second advanced a different theory, and so it went on; but as for himself, he failed to find a theorist yet who had offered any substantial argument that would explain his hypothesis. Mr. Dittmar's worst naphthaline trials were sure to take place in the fall of the year. During October his works were often completely blocked up. Upon being freed they might choke up again or they might not; he never could tell when he was safe. Some years ago, before he had had any prior experience with it, he was hastily called to the works. He found the gas blowing out through the purifiers—not a foot going on to the holder. He was at a loss to account for it. He disconnected the purifier outlet, and found it to be entirely closed with a grayish-brown colored scaly substance. He tried several solvents, and found that a light oil would cut it out more quickly than anything else. He cleaned out the pipes, and for quite a while thereafter filled the lower trays of the purifiers with saw-dust saturated with oil. This plan gave every satisfaction.

Mr. Gwynn asked if any of the members present had ever experienced trouble from naphthaline while using canal coal.

Several affirmative responses were received to the query.

Mr. Coverdale—I would like to mention my Des Moines (Iowa) experience with naphthaline. These works had been newly constructed, and were running quite smoothly, when, without the slightest warning, we were unable to deliver a foot of gas. We "steamed" out the plant, and it operated all right for about a week—then came another enforced cessation. We could not assign a reason for the stoppages, but finally reached the conclusion that the trouble arose from the manner in which we had connected the machinery together. For instance, pipes leading from the hydraulic main went underneath the cellar, then came up and entered the tower scrubber; and from that we had a pipe which conveyed away all condensation from the steam jet exhauster to the tar well. We could not assign any other reason than that we extracted (at an improper period) too great a quantity of ammonia from the gas—that there was not enough ammonia left to keep the machinery clean, or prevent this naphthaline forming. As an experiment I had a box filled with ammonia and fitted with connection for pipe placed in cellar of condenser room. From that out we never had a stoppage in the works; and I believe they have never had one there since. My theory was that a sufficiency of the ammonia contained in the box was vaporized and carried along with the gas in traversing the rest of the plant, the tendency of the ammonia vapor being to keep the connections clean, if I may so speak. At any rate, that is all we ever did to eradicate the naphthaline trouble; and it seemed to have been efficacious.

Mr. Fullagar—I have had a by far too extended acquaintance with naphthaline deposit, and allow me to say that your theories are at best but fancies. We have worked under high heats and low heats; we have carbonized canal coal and bituminous coal; used wet coal and dry coal—the ill-smelling flakes flourish and make no note of the conditions. The first place it troubles us is in the stand pipes of the holders. We place a barrel of oil in every holder on about the first of each November, and we have found the practice affords us a great help. I believe the principal cause of naphthaline stoppages in the machinery of a gas works is carelessness in the matter of keeping the pipes clean. The only place we find naphthaline in the oxide of iron purifiers is where the gas strikes the sides and top of the box covers.

With a sudden fall in temperature (and continuing say for 3 or 4 days) of 15 or 20 degrees, we sometimes find flakes lying on the top of the oxide. With a temperature of 50° or 52° we have plenty of naphthaline deposit. Remove the upper layer of oxide and no trace of naphthaline deposit is discoverable; and now I submit that it proves the scales are formed from contact with the not over-smooth covers of the boxes. We never discover naphthaline in any of our pipes until the stand pipes in gasholders are reached. I think you will find all cures amount to the same thing. Go back to the old system of making gas that prevailed in 1850, and you will not know what naphthaline is; work at low heats, send out a high candle illuminant, and your naphthaline troubles will cease.

Mr. Salter—About three years ago we were troubled with naphthaline to such an extent that our works were stopped up. We then changed to the use of a steam-jet exhauster, to determine whether the fault was traceable to the Mackenzie exhauster we had been operating with at the time of the "blockade." We ran along for probably three weeks; but the change did not seem to make any difference. We had just as much naphthaline as before—indeed it was deposited to a greater extent. I should not, perhaps, say it was naphthaline, for the scales consisted partly of soot. We continued to use the steam-jet exhauster, and after a while the deposits ceased forming. We yet find some traces at different points, but these are not worth mentioning, as they never cause us any annoyance.

Mr. McMillin—I think there is no mystery at all about how naphthaline is formed. I think it is formed just as stated in my paper; it is driven off from coal at low heats, and it is formed by the deposition of hydrocarbons at very high heats. Unquestionably the worst trouble with it occurs always in the fall and spring of the year, but particularly in the fall. It is, however, formed more or less every day in a gas works plant. It is formed a great deal more at high carbonizing heats than at low ones. That which is formed with high heats is produced when you are making very poor gas, and there is nothing to carry it or hold it in suspension. Why it should be deposited more in the fall than in the spring of the year I do not know. Of course, it is simply owing to the changes in temperature. It is possible that the cooling to which gas is subjected in our holders may cause it to settle in the tanks. In October, at midday the sun shines warm, while the nights are quite cool; but in the winter season the temperature falls so low as to cause to be deposited whatever cannot be carried out by the gas before it enters the mains.

The President—Suppose you reverse that proposition, and take summer time?

Mr. McMillin—I know it is a poor rule that fails to work both ways. Doubtless the same rule will apply, then, too; but I would like time to figure that out. It is simply the change of temperature in those two seasons—the difference between the temperature of the earth and the temperature of the holders.

Mr. Fullagar—At the new Cincinnati works the gas passes through a long hydraulic main, and by the time it reaches the hot scrubber its temperature is in the neighborhood of 60°. It passes out through a 20-inch pipe, then enters a 24-inch one, and traverses a distance of about 600 feet before it reaches the condenser. A few days ago we found great pressure on the condenser, and discovered that it was completely stopped in the bottom of the tubes. Why should it deposit itself at that point and not in the pipes?

The President—But Mr. Fullagar ought also to state, in the same connection, that some two or three weeks before, the deposit passed the point just noted and formed 40 or 50 feet further on, or in the inlet to the washer-scrubber.

FIRST DAY.—AFTERNOON SESSION.

The proceedings of afternoon session of first day were commenced by Mr. Irvin Butterworth, of Columbus, Ohio, who read the following paper on the subject of

NATURAL GAS; WHAT IS IT, AND CAN IT BECOME A COMPETITOR OF COAL GAS AS AN ILLUMINATING AGENT?

Considering that this subject is one in which gas men of this State ought to be interested, comparatively little is yet known concerning it. Not being an original investigator myself, however, I would, at the outset, forestall any expectations that the aggregate stock of knowledge possessed by the fraternity on the subject will be augmented by this paper.

Under these circumstances I will not be so presumptuous as to occupy much time, but will simply give a few facts that I have been able to gather from the meager sources I have had at command concerning the probable origin of natural gas, its composition and properties, its geographical and geological location, adding thereto a few thoughts as to the likelihood of its becoming a formidable rival of coal gas as an illuminant.

As to the origin of natural gas, there seems to be little doubt that it has been generated by the slow distillation, during past ages (and continuing at present), of bituminous matter buried in the earth's crust; and, furthermore, that in this section of the country this bituminous matter is contained in the

formation geologically known as the "Huron" or black shale. This black shale contains from 8 to 20 per cent. of carbonaceous matter, and in substantiation of the theory that natural gas derives its origin from it, we can, in our laboratories, easily generate from this shale a gas exactly identical with that which issues from the ground as natural gas, and also the oil with which it is always associated.

The origin of this bituminous matter itself is a subject of more interest to the geologist than as a question of practical importance to the gas man. An interesting theory, advanced by Professor Newberry, is that it comes from seaweed, which grew abundantly in the oceans of the Devonian age. Whenever this shale exists natural gas is found; or, rather, wherever natural gas is found this bituminous shale exists. This statement is true with reference to this section of the country. Other formations in different parts of the world produce natural gas.

This formation of black shale extends from Central New York westward and southward through western Pennsylvania and into West Virginia. In western Pennsylvania it is buried many hundreds of feet under overlying sand rock and other later formations, gradually rising to the surface as we come west, until it finally outcrops in Central Ohio, where it is 300 feet in thickness.

It must not be understood that in boring for gas the drill must penetrate this shale. The formation is simply nature's great retort, where the gas is generated; the holder is the superincumbent porous sand rock, which takes up the gas as generated, as a sponge absorbs water; and the presence of this porous rock is just as essential to the existence of a productive gas well as is the bituminous shale itself. In western Pennsylvania the geological conditions for the existence of natural gas wells are the most favorable. There, in addition to and overlying the bituminous shale (which is probably thicker here than it is further west), are found three great series of gas rocks, aggregating a thickness of 3,000 feet. As we travel further west these formations rapidly become thinner, until the shale itself when it obtrudes at the surface in central Ohio, is only 300 feet thick, while the sand rock has but a feeble and fitful development, except in the northeastern corner of the same State. All these geological indications are verified by the facts. Gas wells are strongest and most abundant in western Pennsylvania, and become weaker and fewer as we come west, ceasing altogether with the terminus of the bituminous shale in central Ohio. The only exception to this, so far as I know, is the well recently opened at Findlay, Ohio. This city is beyond the western limits of the gas-bearing region, and the existence of natural gas at that point is as yet an unexplained anomaly. Last August natural gas was also found at Crestline, Ohio; but this city is situated on the outcrop of the bituminous shale, which extends in a belt from 10 to 20 miles in width, reaching from the mouth of the Huron river, on Lake Erie, to the mouth of the Scioto. Gas is now being bored for at Logan and Ironton. These cities are both within or near the belt of outcrop; but it is by no means certain that gas will be found there in paying or permanent quantities. Natural gas has in past years been found in different parts of the eastern part of the State, while boring for salt, with which, as well as with oil, it is always associated; but in no case has the supply been uniform and permanent.

With regard to the chemical composition of natural gas, the only analyses I have been able to find were those given in the AMERICAN GAS LIGHT JOURNAL of November 17, 1884. From these it would seem that natural gas varies somewhat in chemical composition, according to the locality in which it is found. An average analysis of the gas from the region of Erie, Pa., would show, according to this authority, about the following composition: CO₂, .35 per cent.; CO, .50 per cent.; H, 5 per cent.; hydrocarbons of the marsh gas series, 95 per cent. I believe some authorities put the quantity of CO₂ considerably greater than that given in the analysis quoted. We see that the gas is composed almost entirely of the light hydrocarbons of the marsh gas series, thus accounting for its inferior illuminating power, which varies from 8 to 24 candles—the latter power being obtained only by the use of the Argand burner. The specific gravity is almost double that of coal gas, and the calorific value one-third greater. Natural gas, as a rule, has no odor—at least not a disagreeable one. A noteworthy exception to this is that "freak of nature" before referred to—the natural gas at Findlay—which has an odor that is most disgusting and offensive.

The question as to whether natural gas will ever become a formidable rival of coal gas as an illuminant is, of course, of more practical importance to gas men than any other connected with this subject. That it can be answered in the negative, as far as the central and western portions of this State are concerned at least, would seem to be the prevailing opinion of those who have given it the most thorough consideration. It is well known that natural gas, as it issues from the ground, is inferior in illuminating power to coal gas. Whether it can be profitably enriched and its illuminating power increased remains to be seen. The dangers attending its use in dwellings are familiar to all. The absence of any odor by which to detect its presence, taken in connection with the fact that the pressure is always very great—ranging from one atmosphere to 550 pounds when confined, thus increasing the liability of leakages—causes its use to be attended with great

danger from explosions. Indeed, these have been of so frequent occurrence of late that it is said a Pittsburgh daily newspaper keeps constantly standing in type, ready for insertion in every issue, the stereotyped heading and opening lines—"A terrific explosion of natural gas occurred," etc. However, this danger may be lessened, and no doubt will be, by the use of automatic valves and governors to regulate and control the pressure; by improving the pipes; and possibly by the introduction into the gas of some material to give it an odor. But there is one essential thing that the use of all these expedients will not insure—and that is a constant and permanent supply of the gas. The average length of life of a gas well is stated by one authority to be about 11 years.

In western Pennsylvania, and in different parts of Ohio, wells that a few years ago emitted a large and constant volume of gas have heaved their last sigh and expired; and when the gas ceases to flow, automatic valves and governors and low prices will not bring it to the surface again. The porous sand rock has been exhausted of its supply; and although the distillation from the shale below may still be going on, it is so slow that it may require generations, or even ages, to again "raise the holder."

Again, as far as Ohio is concerned (and this subject has been treated rather from an Ohio standpoint), the geographical distribution of this shale and sand rock is not such as to warrant the expectation that natural gas will be found to exist in any considerable quantity throughout the greater portion of her area; and it is not likely that it will ever be profitable to conduct it in pipes from more prolific regions without her borders.

In the western part of Pennsylvania natural gas is so abundant and so cheap (being now delivered at from 12½ to 30 cents per thousand), that it there may become a competitor of coal gas as an illuminant. In fact, in many parts of that section, it has already driven coal gas from the field; and future discoveries of natural gas, and further improvements in the methods of its distribution, may enable it to rival and supplant coal gas in other localities. For heating purposes natural gas, owing to its greater calorific power, is much superior to coal gas. For burning brick or lime, and melting glass, iron and steel, there is no other fuel to equal it. For manufacturing purposes, and for heating dwellings, natural gas, where it is abundant, bids fair to become, for a while at least, not only a supplanter of coal gas, but also a strong competitor of coal itself.

After all, the principal ground for hope and encouragement to those who are likely to suffer from the encroachments of natural gas, in the fields of both illuminating and heating, is the uncertainty of a constant and permanent supply.

Discussion.

The President called upon Mr. McMillin to give his experience as to what had been done in boring for natural gas at Ironton.

Mr. McMillin—Natural gas was found at Ironton, though not in quantity to possess any economic value. I take issue with Mr. Butterworth in regard to his statement that the overlying porous sandstone formation is comparatively insignificant in the southern portion of this State. At Ironton it was found to have a thickness of 108 feet. This reservoir is much thicker there than at many other points in Ohio, and the shale was also very heavy; but after reaching the shale they had very little hope of getting gas, as it is generally in the overlying sandstone that the gas is found. The well at Findlay, Ohio, is an anomaly. There is less than half, perhaps not more than two-fifths of the territory in this State where the Huron shale is found, and in not more than one-quarter of the State is the Huron shale sufficiently covered with an overlying strata to prevent the gases from escaping. If natural gas can be obtained at depths below the Huron shale, then even Cincinnati is in danger. I learn that it was in the Cincinnati limestone group that they tapped the gas vein at Findlay. Heretofore drillers have not been successful in discovering natural gas in those shales; and geologists consider it rather remarkable it should be found in the Findlay instance. Yet it seems to me no real cause for such surprise exists, as the exploiters hitherto had not been drilling to such depths. The Findlay region has not been known as favorable to the discovery of an oil or a salt bearing strata, as is the case in other parts of Ohio and Pennsylvania where bore-holes for oil or salt wells are frequently drilled, and where perhaps to ten holes drilled gas is found but once. Heretofore geologists have considered a man as quite stupid who would drill in the Niagara limestone, or even anywhere below the Huron shale, in the expectation of striking a gas vein. Two flowing wells have been found at Findlay, and the estimated outsend from each is placed at about 250,000 cubic feet per day—I could readily believe the product of them is much in excess of that estimate. The wells are probably one and a half miles apart, and in sinking the drills passed through a shale between 500 and 600 feet thick. I know of no reason why natural gas should not be found in other regions of that strata, which extends all over Ohio. The Findlay gas carries less than one per cent. of carbolic acid. It can, for violence of odor, compete with, and even excel in that respect, the foulest sample of unpurified coal gas; and one most striking circumstance brought to my notice was developed through the removal of an ordinary one-inch

L-shaped branch. Its inside was found lined all over with pure flower of sulphur. Now I have often heard the meter man laughed at for saying somebody's gas was bad—that it deposited sulphur in the meter. The laugh is now on the other side, I think. Sulphuretted hydrogen may be decomposed—it was decomposed in that instance. At Findlay the street lamps are kept lighted day and night. The natural gas is used for lighting, heating and cooking. I did not test its illuminating power. I am told it shows only about one-half per cent. of illuminants; yet, consumed in an argand burner, it gives a very fair sort of light. The first gas vein was struck at a depth of 1,092 feet below the surface; the second bore-hole made contact at 1,200 feet. I think, however, they were really at about the same level, owing to difference in surface height of points at which boring was commenced. The Findlay Gas Company folks, from sinking that second drill, rather think they have struck an elephant; for should they charge more than 25 cents per thousand, many consumers could afford to put down drills on their own account. If they sell all their gas output at 25 cents per 1,000 they would receive only \$62 per day. They were rather in a quandary as to whether they had any use for the second well after they had bored it. I do not know what conclusion they have arrived at by this time; and most assuredly they will not be able to sell the gas for a much longer period unless they purify it—although they were sending it out in a crude state up to a few days ago.

Mr. Thompson—I would like to ask Mr. McMillin to explain why it is that natural gas only has a good illuminating value when burned through an argand burner? Judging from the view I had of it at Liverpool, Ohio, it has an abominable appearance when consumed in an ordinary burner.

Mr. McMillin—I think if the Findlay gas were purified the consumers would be pretty well satisfied with it. Using an argand burner, and with gas costing but 25 cents, they could afford to burn two lights instead of one. This gas does not seem to be a producer of very intense heat. Mr. Butterworth states that it far exceeds coal gas in its calorific power; now that may be true when speaking of quantity; but it is the very reverse of true, so far as intensity is concerned. If you burn it through an argand lamp, and thus exclude the cold air from the hot air passing through the chimney, the temperature becomes sufficiently high to produce the very fair light given by it under that method of burning it. I am not quite sure but this would be a situation where the water-gas man might take hold and be of some real use to the world—put two poor gases together, and thus possibly make one good one as a result of the union.

Mr. Hamlin—I wish to ask Mr. McMillin whether ordinary street mains will retain the natural gas? At the time of the Pittsburgh explosions it was explained that iron was too porous to resist the "searching" qualities of the natural gas product.

Mr. McMillin—This I should say, speaking from a purely theoretical standpoint, is true; but practically it is not. Cast iron pipe of half-inch thickness will retain it. Explosions are frequent, but I think they are results of the loose manner in which the pipes were laid, and consequently ought not to be attributed to the "searching" nature of the gas. It ought not to leak, under the same pressure, as freely as coal gas would, because its specific gravity is greater. I do not think purveyors of natural gas would experience any trouble at all, working under pressures similar to those carried by us; but, on the contrary, they would then have a great deal less leakage than we experience with our coal gas.

Mr. Salter stated that the Hemingray Glass Company, at Covington, Ky., were boring for gas. They had struck two or three veins at varying depths, and were going still deeper. He understood they had secured a flow equal to about 3,000 feet. He had seen it burning as it issued from the mouth of tube at well, but had not perceived it burning under ordinary everyday lighting conditions. One of the Messrs. Hemingray told him that the first vein was struck at 350 feet; the second at 500 feet; and the third at about 750 feet depth. They were now down to about 1,000 feet without having encountered an additional vein. They proposed sinking to a depth of 2,500 feet.

The discussion thereupon terminated.

[To be continued.]

The New Gasholders Built to the Order of "The Gas Light and Coke Company" at the Horseferry Road Station.

The London *Journal* publishes the following particulars in regard to the latest additions made to the storage plant of the above-named Company's works. The article points out that in the course of his report on the construction and carbonizing departments of The Gas Light and Coke Company during the past half year Mr. G. C. Trewby stated that since his appointment, in March last year, the only additions of importance to the Company's manufacturing plant were some purifiers at Nine Elms, and "the erection of two large gasholders, just completed and brought into successful operation on the Company's vacant land at Horseferry Road."

These holders are telescopic (two-lift), and have each an available capacity of 1,900,000 cubic feet. The total height of the holders is 67 ft. 9 in. from the under side of the curb to the top of the curb of the upper holder. The lower lift is 192 ft. 8 in. diameter by 35 ft. high; and the upper lift 190 ft. diameter by 34 ft. 3 in. high. The crown has a rise of 8 ft. at the center from the curb line. Both holders and framing are composed essentially of wrought iron, cast iron being only employed for the ornamental work and bases of the standards. The larger rollers are of cast steel, and the smaller ones formed from wrought iron. The specified test of the wrought iron was 22 tons per square inch, with no permanent elongation up to 10 tons per square inch.

The outer lifts of the holders have a bottom curb of two 7 in. by $\frac{3}{4}$ in. flats, placed horizontally 12 inches apart, and strengthened by two angles $3\frac{1}{2}$ in. by $3\frac{1}{2}$ in. by $\frac{1}{2}$ in. The grip is formed by a horizontal plate 16 in. by $\frac{3}{4}$ in., with two angles 3 in. by 3 in. by $\frac{3}{4}$ in., connecting it to the $\frac{1}{4}$ in. thick pendant plate of the grip and to the side of the holder respectively; the grip and also the cup of the inner vessel being 18 in. deep and $10\frac{1}{2}$ in. wide. On the outer edge of the grip the top plate overhangs, and covers the top of the 20 vertical stays, which are each composed of two 7 in. by $\frac{3}{4}$ in. flats, connected to the sides by angle irons. On the inside of the holder, opposite each vertical stay, a 12 in. by $\frac{3}{4}$ in. flat bar runs the whole height of the side, forming a roller path. The top and bottom rows of sheets in the outer lift are $\frac{1}{4}$ in. thick. A vertical plate opposite each vertical stay is 1 ft. 6 in. wide and $\frac{1}{4}$ in. thick, the remaining sheets being $\frac{1}{2}$ in. thick. Two 6 in. by $\frac{3}{4}$ in. flat iron belts are carried horizontally round the holder inside, connected to the plates at the back of the posts on either side of the roller paths.

The inner lifts of the holders have a cup formed by a 16 in. by $\frac{3}{4}$ in. bottom plate, with angles and $\frac{1}{4}$ in. vertical plate as for the grip. The 16 in. plate extends on the inside of the holder, and forms a connection with the 20 vertical stays, which are of a girder section, with 18 in. by $\frac{1}{2}$ in. web, and four angles; the two inner ones being 4 in. by 3 in. by $\frac{3}{4}$ in., and the outer ones 3 in. by 3 in. by $\frac{3}{4}$ in. The top curbs are curved in section to a radius of 3 ft., and consist of two $\frac{3}{4}$ in. plates, each 2 ft. wide, having planed edges; the butt joints being covered on both sides, and double riveted. The vertical posts before mentioned are fitted under the curb plates, and connected by lattice trussing 10 ft. deep to the main rafters.

The crowns are each trussed by ten main rafters 3 ft. 6 in. deep at the curbs, reduced to 3 ft. at the center, having four flange angles 4 in. by 5 in. by $\frac{3}{4}$ in., and lattices 4 in. by $\frac{3}{4}$ in. Six of these rafters are connected at the center, the others being secured between two crown plates 9 ft. in diameter and $\frac{1}{2}$ in. thick. Between the main rafters is a ring of concentric purlins, of a similar section to the rafters, but with a $\frac{1}{4}$ in. web instead of lattice bars. The ten secondary rafters have flange angles 4 in. by 4 in. by $\frac{3}{4}$ in., and lattices 4 in. by $\frac{3}{4}$ in. These extend from the curbs to the concentric purlin girders mentioned above. Below the main and secondary rafters are three rows of concentric purlin lattice girders, of 3 in. by 3 in. by 5-16ths. in. angle flanges and $4\frac{1}{2}$ in. by $\frac{3}{4}$ in. lattice bars, and these carry the T-iron bracket bars which are placed to support the sheets at distances of about 8 ft. radially. Immediately below the lattice trussing to the main rafters the vertical stays are connected by two rings of 5 in. by $\frac{3}{4}$ in. flat iron 1 ft. 2 in. apart, braced by flat bars, which give additional stiffness to the sides. The top and bottom rows of sheeting next to the cup and curb are 2 ft. 8 in. wide by $\frac{1}{4}$ in. thick. With the exception of the 18 in. by $\frac{1}{4}$ in. vertical plates at the back of the posts, the remaining side sheets are all $\frac{1}{2}$ in. thick. The rows of plates adjoining the top curb and the crown plates, and those on the main purlins, are 3 ft. 2 in. wide by $\frac{1}{4}$ in. The other crown sheets are all $\frac{1}{4}$ in. thick. All the crown plates exceeding $\frac{1}{2}$ in. thick are riveted to rafters and ring purlins; the others are only supported by, not attached to, the trussing.

The top carriages on both lifts have cast steel turned and bored pulleys, which work in wrought iron carriages. The axles are fitted with a special arrangement by means of which they can be adjusted exactly to the guide rails, and are then secured by a screw and nuts, which prevent any lateral movement, and dispense with the usual slotted holes and loose packings. The carriages on the cup and the bottom curb have solid wrought iron rollers turned and bored. A handrail 3 ft. 6 in. high is fixed round the top curb of each holder.

The guide framing to each holder consists of 20 wrought iron standards, each 68 ft. 6 in. high from the base stone to the under side of the top girders, and two tiers of girders. The standards are rectangular in section, formed of four 6 in. by 6 in. by $\frac{3}{4}$ in. angle irons and two 6 in. by 3 in. by $\frac{3}{4}$ in. tees, with T-iron diagonals 5 in. by 5 in. by $\frac{3}{4}$ in. At the junction of the diagonals they are strengthened by a solid angle frame 4 in. by 4 in. by $\frac{3}{4}$ in. At the base the standards are 6 ft. by 3 ft. 3 in., tapering to 3 ft. by 3 ft. 3 in. at the top. The base plate is cast iron, 6 ft. 9 in. by 4 ft. 9 in. by 1 ft. 4 in. deep, faced on the upper surface, to which the standards are bolted. A steel rail, 80 lbs. per yard, with fished joints, forms the guide for the rollers. The top of each standard has an ornamental cast iron finial; and seven moulded

panels are fixed on each of them at intervals of the height. The girders (of which there are two tiers) are of lattice work, 3 ft. deep, consisting of four flange angles 5 in. by 4 in. by $\frac{3}{8}$ in., with 5 in. by $\frac{3}{8}$ in. lattices. The angles are turned round and welded at the ends, forming solid frames. The framing is strengthened by two tiers of diagonal bracing between each pair of standards. The whole of the connections of the girders and standards are riveted. Each standard is secured by four holding-down bolts $2\frac{1}{2}$ in. diameter and 10 ft. long, with 12 in. by $\frac{3}{8}$ in. holding-down plates built into the tank piers.

Inlet and outlet pipes and boxes, 24 in. and 30 in. diameter respectively, of wrought iron, are fixed in each tank. These were all tested by hydraulic pressure to 50 lbs. per square inch at the works. The holders were proved with air; and, after sealing the inlet and outlet pipes with water, remained inflated for three days without movement, allowance being made for differences of temperature and barometrical pressure.

A special feature in connection with the erection of the guide framing arose from the fact that, owing to the space outside the tanks being so limited (2 ft. only at the back of the standard bases), no guys could be used outside the tank for the hoisting tackle. This difficulty was overcome by working the sheer-legs inside and from the bottom of the tank, making them, of course, high enough to overtop the top of the standards, with sufficient margin for the lifting blocks. At about two-thirds of the height of the legs a back leg or strut was connected to them and carried to the dumping in the tank, wire guy ropes being taken from the top of the legs to the opposite side of the tank; the whole thus forming a perfectly steady hoist. The hoisting itself was done by a steam winch, also working inside the tank, and by this means a column and the connecting girders could be hoisted in a day.

The total weight of all wrought iron and steel in the two holders, including the inlet and outlet pipes and holding-down bolts, was 1,150 tons, the cast iron being 180 tons. The holders, when fully inflated with gas, give a pressure of 7 inches of water.

The time originally specified for the completion of the holders was: No. 1, by October 1, 1884; No. 2, by October 1, 1885. But both holders were completed by November 15, 1884. The contract price for each holder was £14,492 8s. The whole of the work was carried out and fixed by the Horseley Company, Limited, of Tipton, from the designs and under the superintendence of the Company's Engineer, Mr. Alfred Kitt, Assoc. M. Inst. C.E.

Improvement of the Locomotive Engine.

Engineering, in discussing the subject of the grate surface of locomotives, says the demand in American locomotive engines is still for greater steaming capacity to enable them to make time with heavier loads. Since the boiler shells are limited in practice by the gauge of railroad to 54 in. or 55 in. in diameter, while the length is determined by the length of the tubes, which do not exceed 12 ft. 6 in. in length, this has thus far limited the extent of heating surface in the boiler. But this is not the main difficulty. The fire-boxes, located between the wheels and frames, limiting the grate area, except in the Wootton form, to about 15 square feet, the fires have thus to be forced to an extraordinary degree, the rate of combustion frequently being 120 lbs. to 140 lbs. of coal per square foot of grate per hour. The result of this state of things is a low evaporative efficiency; the American engines doing heavy work averaging not more than 5 lbs. to 6 lbs. of water to a pound of coal consumed. The only possible relief seems to be in an extension of the grate surface and the corresponding heating surface. By using slab frames, 1 $\frac{1}{2}$ in. thick, or by modifying the customary American design of the frames and the fire-box so as to allow the latter to extend over the frames to within an inch or so of the driving wheels, would enable the grate surface to be increased by some three or four square feet. The length of fire-box is now limited by the distance between the main and back pairs of driving wheels or the rigid wheel base of the engine, but more particularly by the distance the fireman can easily throw the coal so as to keep the grate well covered and avoid bare places for the admission of currents of cold air. This limit is for bituminous coal burners about 6 ft. If slab frames are used it then becomes necessary to underhang the springs and equalizing beam beneath the frame and fire-box, as is usual in this country. It is very evident that the grate surface of engines will have to be increased at no distant day, and it would seem as though inventive genius might profitably be employed in studying practicable means for this end. The subject is one of the most important ones relating to the improvement of the locomotive engine, and the increase of its efficiency and consequent economy of working, and is already being given serious attention.

ONE OR TWO FIGURES.—According to the annual report of Mr. J. H. Knowles, Superintendent Richmond (Va.) City Gas Works, that corporation owns a conduit system 53 miles in extent. The total number of meters set is 4,630.

ITEMS OF INTEREST FROM VARIOUS LOCALITIES.

TO TAKE CHARGE OF THE EL PASO (TEXAS) PLANT.—Mr. M. L. Hickey, formerly in charge at Dallas, Texas, has assumed the duties of Manager and Superintendent at the works of the El Paso Gas, Coal and Coke Company. Mr. H. S. Potts was his predecessor at El Paso.

REMOVING HARD TAR FROM HYDRAULIC, AND FREEING DIP AND ASCENSION PIPES.—Mr. B. F. Leete, Secretary of the Reno (Nevada) Gas Company, says that the following practice, adopted with a view to the dislodgment of hard tarry accumulations in hydraulic, and keeping dip and ascension pipes free from obstructive deposits, has been found to answer every desired purpose: Once a month the stopple of dip pipe is removed, and a jet of steam is directed into bottom of hydraulic main, by dropping steam pipe down through dip pipe. The steam is allowed to enter until tar in main is brought to boiling point, when it is easily discharged, and hydraulic and dips are rendered perfectly clear.

HE CAME TO GRIEF.—A person named Chas. F. Lyon, 30 years of age, and a resident of Brooklyn, N. Y., has for quite a while been in the employment of the Mutual Gas Light Company, of this city, as a bookkeeper. Lyon had charge of the accounts and made out the bills for a certain section of the Mutual Company's output in the down-town business district of the metropolis. The collector for the district was a man named O'Brien. With the commencement of 1885 O'Brien resigned his berth, and a notice that a new collector would present the monthly statements was mailed to the consumers. Lyon, seeing his opportunity, made out a number of accounts and handed them to as many of the consumers as he could call upon within the space of two days. During that period he managed to collect the sum of \$1,100, and with that amount safe in his pockets he resigned from the company's service, alleging as cause therefor that he had been hastily summoned to make a visit to San Francisco. He could not have been well out of New York city before his peculations were discovered, and Mr. Kennedy speedily reported the facts in the case to the officials at Police Headquarters. Inspector Byrnes had Lyon's description telegraphed to the police of every large city in the West and South. The fugitive was finally discovered at Raleigh, N. C., where he attracted attention through his lavish outlay of money. The Raleigh authorities returned him to New York, and upon his arrival here he was consigned to the care of Warden Finn. The specific charge made against Lyon was that of fraudulently obtaining from Messrs. Powell and Campbell, wholesale shoe dealers, doing business at Church and Duane streets, the sum of \$50.25 in settlement of their gas bill. Lyon will have a chance now to earn much more than that sum for the State through his labors in the shoe shops of Sing Sing. When arrested at Raleigh he had \$500 left.

EAST END GAS COMPANY (PITTSBURGH, PA.) REDUCES PRICE OF GAS.—Mr. W. H. Denniston, Secretary of the East End Gas Company, under date of March 31st, has published a notice to his consumers that from and after May 1st, 1885, the price of gas to users of over 1,000 cubic feet per month will be at the rate of \$2 per M., with a 20 per cent. discount granted on the face of all accounts settled within ten days from the date of their presentation. This is a virtual fixing of the price at \$1.60 per 1,000. The East End is a suburban company, and possesses and operates no less than 32 miles of mains, a fact that shows distribution charges must be rather heavy items. The Union Railway Depot at Pittsburgh proper probably consumes more gas than that absorbed by any twenty of the East End's patrons. Looked at in this light the \$1.60 figure is just as reasonable as the seemingly lower figure charged by its nearer neighbors operating within the business limits of the "Smoky City." Mr. Denniston proposes to deal with those who are inclined to dispute the correctness of the meter's figures in the following manner, as per the words of the circular distributed to the consumers: "If there is any dissatisfaction about bills, it must be reported to the company's office at once so that the quantity registered may be inquired into. If the registry is correct and you still think the bill too large, or that the meter is inaccurate, you will at once notify the official gas inspector, as per his rules. If you want the benefit of the 20 per cent. off, you will in any event pay before the tenth day has expired; but if the gas inspector condemns the meter, the company will refund any overcharge, put in a new meter, and pay all the expenses incurred in the testing. If this regulation does not meet your approval will expect your order to remove meter; we will do so at once, but with reluctance and regret. Hereafter the meter must determine all differences as to gas accounts, and no personal appeals will be considered at the office of the company. This latter plan has been tried, and under its working it has been impossible to arrive at satisfactory decision between consumer and company. If the meter, when shown to be correct, registers a certain quantity as having passed through it, the company wants to be paid for that quantity or cease furnishing gas. The reduction in price, it is hoped, will

will warrant a still further reduction in the future." Well said, Brother Denniston; and the only parties squirming beneath the effect of reduced gas prices are the "professors" and erratic travelers who have carbonic oxide death-traps "for sale cheap."

AN ADDITIONAL LIST OF VICTIMS.—The following deaths are to be attributed to the venenose nature of carbonic oxide: Herman Ahrens (a man about 26 years of age) has been boarding for some time past at the Bull's Head Hotel, located at corner of Third avenue and Twenty-fourth street this city. Before retiring on night of Saturday, April 4th, it is said that he blew out the gas. The following morning he was found dead in his bed. The gas was escaping through a partly turned off burner.

CASE No. 2.—A "special" to the newspapers, dated Wilkes-Barre, Pa., April 5th, says that a large gas pipe running under sidewalk in front of Henry C. Engelke's house, on South River street, burst, and the gas escaped in large quantities into the cellar and thence through the house. There were in the house at the time Mr. Engelke, his wife and daughter, also a servant named Kate Schlessinger. All were overcome before they could give an alarm, and all would have perished were it not for a neighbor, a Mrs. Dietrick, who discovered their condition, and at once summoned medical aid. Drs. Mayer and Miner put forth their utmost efforts to rouse the sufferers from their death-like condition, and soon had the satisfaction of restoring Mr. Engelke and daughter to consciousness. Mrs. Engelke hovered between life and death, and it is as yet an even thing whether or not her case will terminate fatally. The servant girl never regained consciousness, and died in about an hour from time of discovery. There being only two doctors in attendance upon the four patients, it is fair to presume that the servant was the last of the sufferers to receive medical assistance. Her demise goes to show how swiftly fatal CO is in the performance of its veneficial potency. All the despatches in relation to the Wilkes-Barre case explained that water gas was much more dangerous than coal gas, and that water gas only was manufactured there.

CASE No. 3.—Francis Rodgers, probably 24 years of age, and hailing from Kansas City, Mo., on an early date in April reached Baltimore, Md., in which city he intended making a sojourn for a few days before starting for New York, it having been his intention, upon arriving at this port, to take passage for Ireland on one of the outward bound steamers. He took temporary lodgings in a Baltimore boarding-house, and on morning of April 8th was discovered in his bed in an unconscious condition. The gas burner in room had not been turned off. Two doctors labored over him for several hours, but with no beneficial effect, as the patient died on the 9th.

AMERICAN WATER WORKS ASSOCIATION.—Mr. J. H. Decker, Secretary and Treasurer of the American Water Works Association, informs us that the Fifth Annual Meeting of the Association will be held in Boston, Mass., on the 21st, 22d and 23d days of April. Headquarters will be at Youngs' Hotel. This Association was organized on the 29th day of March, 1881, initial meeting taking place at St. Louis, Mo. Mr. Decker has been unremitting in his exertions on behalf of the body; and so well have his efforts been responded to that the Society now has a total membership of 150, with a comfortable financial standing amply ensured. Mr. Decker is well known to the gas fraternity through his long and honorable connection with the Hannibal (Mo.) Gas Light Company.

A FEW OF THE CONSUMERS WHO WILL NOT HAVE THE CHICAGO WATER GAS.—As a sample of the dissatisfaction that exists amongst people who have been taking gas from the mains of the Chicago (Ills.) Consumers Gas Fuel and Light Company, but who have gone back to the old Chicago Gas Light and Coke Company, we may mention the prominent cases of the proprietors and owners of the Palmer and Madison Houses, and the *Tribune* and *Inter-Ocean* newspapers. The Palmer House managers have made a five year contract with the Chicago Company, on the basis of \$1 per thousand for the consumption of '85 and '86; an additional 25 cents per thousand to be charged during '87, '88, and '89. So desperate has the Consumers' situation become that its officials were driven to the expedient of compiling a list that must contain about all the patrons possessed by the Company in the business portion of the city. The circular list starts off with the announcement, "We, the undersigned, take pleasure in assuring the public that the 'Consumers Gas Fuel and Light Company' have furnished us for some time a gas of a superior quality, giving entire satisfaction," etc. The italics are ours, and we are prompted to exclaim, "How long, Oh Lord; how long!" In the meantime, to show the sort of impress that Mr. Forstall is making upon the Chicagoans, it is only needed to say that the increased output of the Chicago Company, during the first 20 days of March, as compared with same days of '84, reached a total of 17,000,000 cubic feet, or at the rate of 35½ per cent. No need for "circulars" in the neighborhood of that establishment.

A NEW METHOD OF RENDERING HARMLESS THE CURRENTS FROM A HIGH TENSION DYNAMO STATION.—The only trouble with the process, though, is that the circuit is broken. The discoverer in this branch of applied science were made known to fame and secured to the arms of Justice by the researches of Police Officer Cook, who happened to discover Charles Tierney and Albert A. Noll, in a yard in front of a house situated on West 17th street, this city, in the act of coiling up about 200 pounds of copper wire. The aforesaid "scientists" had, in broad daylight, climbed up the poles (belonging to the United States Electric Illuminating Company) on which are strung the "arc" light conductors that run through Gansevoort street. Altogether they managed to cut down the wire lengths that stretched between 14 poles.

THOUGHT IT WAS A JOB.—At a meeting of the Allegheny (Pa.) Streets and Sewers Committee Supt. Young, of the Allegheny Gas Company, asked that the Allegheny Heating Company be allowed to proceed on the work of laying pipes for the Gas Company. Some time ago the latter corporation was granted an ordinance permitting it to lay conduits through certain streets, and now the Heating Company (it supplies natural gas only) asks for these franchises. The Committeemen appeared disposed to infer that the Heating Company had bought the Gas Company out. Supt. Young denied the truth of the inference. The request was finally granted; but, for all that, the grantors still retained suspicions about the application. That shows the innate working of the Allegheny Conncilor's mind. He did not care so much about the fact that there might be a "job" concealed in the request as he regretted the circumstance that he was not one of the "jobbers."

"INCORPORATING" THEMSELVES.—On date of April 4th the "Gas Consumers Association of the State of New York" filed a certificate of incorporation at Albany. The avowed object of the organization is to protect consumers from extortion by gas companies. 'Ere is your true circle of philanthropists who compose the Board of Trustees: Messrs. J. H. Sherwood, J. S. Schnltz, W. H. Wood, T. Moss, R. H. Strebeigh, F. H. Thurber, W. D. Garrison, S. Shook, H. Cranston, H. M. Smith, F. S. Gardiner. The idea of some of these people assuming the garb of philanthropy! Motes and beams are at a discount in our day.

TURNING ON THE GAS.—Last fall the Pacific Construction Company broke ground (with a view to the erection of a gas works) at Olympia, Washington Territory. On Friday, March 27th, gas was turned on to the mains, and its appearance at the burner tips was hailed with much rejoicing. Olympia is the capital of Thurston county, and is located at the head of steam navigation on Pnget Sound, about 150 miles from Pacific Ocean. Fifteen years ago Olympia had but 600 inhabitants; now it has a population sufficient to support a gas plant.

OBITUARY NOTE.—Mr. H. D. Green, the founder and chief owner of the gas and water systems supplying Portland, Oregon, died quite suddenly on evening of April 5th. The deceased gentleman was on a visit to the East, and his demise occurred at the Fifth Avenue Hotel, this city. Mr. Green was in the 58th year of his age, and was one of Oregon's wealthiest citizens.

A CHANGE IN SUPERINTENDENCY AT MONTGOMERY (ALA.) GAS WORKS.—The board of directors of Montgomery Gas Light Company have appointed Mr. Peter Young, formerly of Pittsburgh, Pa., to the Superintendency of their thriving Southern plant.

A TELEPHONE WIRE CARRIED ALONG A GAS MAIN.—The Consolidated Gas Company, New York city, is engaged on the work of connecting the holders of the Knickerbocker and Harlem stations with a 20-inch cast iron conduit. This conduit carries, close to its inner top section, a private telephone wire for maintaining oral communication between the two stations. The pipe is laid along the west side of First avenue, and its total length embraces the distance between 99th and 111th streets. An 8-inch consumers' main is laid in the same trench.

PERSONAL.—In our issue of March 2d we explained that Mr. T. A. Bates had resigned the position formerly occupied by him at the Cairo (Ills.) works. That action was taken by him so that he might take charge of the Los Angeles (Cal.) plant.

HEATING THE NEWLY-BUILT "INSURANCE EXCHANGE" AND "TRADERS' BUILDING," OF CHICAGO, ILLS., WITH GAS.—Mr. E. H. B. Twining, the enterprising Chicago agent of the Goodwin Gas Stove and Meter Company, of Philadelphia, Pa., has achieved a noteworthy victory in causing the owners of the newly-constructed and elegant office buildings (known as the Insurance Exchange and Traders' Building, both located on Pacific avenue) to employ gas heat as a method of warming the interior of the structures. In lieu of the ordinary fireplaces elegantly-designed gas grates are employed. The mountings of grates in Insurance Exchange were constructed from specially-

prepared designs, and will not be duplicated for employment in any other Chicago building. The ornamentation is, according to the *Inter-Ocean*, "rich, artistic and satisfactory." This new departure from the beaten track pursued by Chicago architects in making provision for heating office structures is well worthy of notice. Messrs. Goodwin and Twining are quite elated over the matter, and the Chicago "gas men" are also inclined to "jubilate" in regard thereto.

THE AUDIENCE LEFT IN DARKNESS.—During a recent performance of "Die Walküre," at the Stuttgart Theater, the newly-installed electric lighting appliances got out of order, and for several minutes the stage and auditorium were plunged into Egyptian (or rather "Dutch") darkness.

REDUCING PRICE OF GAS AT UTICA, N. Y.—On March 23 the directors of the Utica (N. Y.) Gas Light Company informed the consumers of that city that all consumption of gas registered on meters from March 1st would be reduced from \$2.25 to \$2 per 1,000. The discounts to consumers of largest quantities was fixed at 40 cents, and smallest consumption 25 cents, per thousand respectively—or net rates of \$1.60 and \$1.75 per thousand cubic feet.

FROM PRESENT APPEARANCES, WE THINK "NO" ANSWERS THE CONUNDRUM.—At the March (1884) meeting of the Society of Gas Lighting, Mr. William Farmer read a paper* on the "Chamberlain Gas Process," and in explaining the details of same the writer withheld himself from expressing his own views as to the value of Mr. Chamberlain's claims. Mr. Farmer closed his presentation of the process with the remark, "Gentlemen, is this to be the gas of the future or not?" Since no one seems as yet to have replied to the conundrum then propounded, the writer takes to himself the liberty of replying, "No, sir; it would seem not." And the reply is based upon the outcome of certain experiments lately made at the works of the Laclede (St. Louis, Mo.) Gas Company.

ROCKLAND AND THOMASTON (ME.) GAS LIGHT COMPANY REDUCES PRICE OF GAS.—Mr. Austin M. Copp, agent of the above-named company, and acting under authority of the board of directors, issued the following to the consumers, under date of April 6th: "We take pleasure in informing the public that the price of gas has been reduced from four to three dollars per thousand cubic feet, and that to all customers who pay their bills on or before the 25th day of month in which they become due, a discount of 25 cents per thousand will be allowed. At the net price of \$2.75 per M. gas is being sold at a lower price than in any other town in this State where inhabitants burn an equal quantity with that consumed here. In fact, the only places in the State where lower prices obtain are the large cities of Portland and Bangor." Superintendent Chas. T. Frost, in the same circular, offers to freely impart any desired information relative to the use of gas cookers and heaters; and explains that the company will furnish stoves and burners at first cost. The annual output of the Rockland Company reaches to a total of about three millions, and the \$2.75 rate is therefore a very reasonable one. By the end of present year the excellent result of Mr. Copp's liberal policy may be trusted to manifest itself in the most convincing manner.

HE WAS TOLD TO "GO ON."—In the last number of the *JOURNAL* we gave some few particulars concerning a certain trip taken to Troy, N. Y., by a "wanderer" (L. H. Gibbs) who wanted a franchise, said wanderer having been accompanied by a "contractor" (B. Van Steenberg) who claimed to have a contract for building a gas plant in a city suspiciously like unto the measure of Troy—at least so the great Goshen foundryman testified before the Gibbs-Thomas-Daly Senate combination during the now historical Morton House sessions in this city. We left Messrs. Gibbs and Van Steenberg uttering their plaintive pleadings in the ears of the members of streets and alleys committee of Troy Council; and from the testimony that had been presented at committee's session we gave it as our opinion that Gibbs' project would "hang fire." The subsequent action of Council verified the correctness of that prediction; for Mr. Mead, of street and alleys committee, at full meeting of Council, held Thursday, April 2, reported adversely on the scheme proposed by the erratic traveler and his associates. The Council accepted the report—and again poor Gibbs "goes on," and Van Steenberg's contract becomes woefully contracted. Sue tells us (and we are obliged to confess that he is not generally accepted as sound authority) that the cholera followed in the wake of the Wandering Jew; and, strange to say, when Gibbs got ready to test the springiness of the roads leading out of Troy, the Councilors made trouble for the Troy Gas Company in the shape of passing a resolution authorizing the city to contract with the electric lighting folks for the erection and maintenance of ten or more arc lights along the streets and roadways—location and situation of same being specified. Price of each arc to be 45 cents per night. Councilman Cridge made a determined effort to prevent the scheme from succeeding, but all to no purpose, even though he

did point out that the tax rolls would have to be greatly increased in consequence of the difference in cost between "arc" lights and gas lamps. The resolution was carried by a vote of 17 for to 7 against. [Later news conveys the information that the electric scheme may yet be defeated.]

THE NASSAU COMPANY'S NEW PLANT.—The Nassau Company's (Brooklyn, N. Y.) new holder is to be located on Rutledge street, 100 feet west of Wythe avenue. The tank is to be 152'6" in diameter, and 33 feet deep, as learned upon inquiry at Department of Buildings. The estimated cost of excavation, tank walls, etc., together with monies to be expended in erecting boiler and valve houses, is placed at \$67,400. If memory may be relied upon the surface ground at that point is less than ten feet above tide-water mark.

Correspondence

[The *JOURNAL* is not responsible for the opinions expressed by correspondents.]

The "Knights of Labor" Speak Their Mind.

PHILADELPHIA, PA., March 29, 1885.

To the Editor AMERICAN GAS LIGHT JOURNAL:

In your issue of March 16th appeared an article the terms of which we think unjustly reflect upon the former employees of the Goodwin Manufacturing Company, of this city. According to that view of the case we request you, in the interest of fairness and justice, to publish this statement.

The plain facts in this matter are the following: After remaining idle for about nine days, at commencement of present year, we received notice to resume work, and accordingly reported at the shop. As each employee was allotted his complement he also received a price list fixing the rate to be paid for the several styles of work to be done, and as the slip was handed him the admonition to "keep the prices to himself" was also administered. A week's time elapsed before all the men had received notice of the several rates to be paid. When the reduced scale became generally known the men quite naturally determined to resist a change—from the lowest prices paid by any other meter making firm in this city—to such an unjust schedule.

This action of the men was resolved upon—first; because the newly-adjusted prices were manifestly unfair. Second; there was no real necessity for the reduction, and this statement is borne out and proved by the hasty action taken by the Goodwin Company in restoring the rates when they found their employees unwilling to submit to the "docking" process. Third; the manner in which the reduction was offered proved that the company's position was unwarranted and unjustly assumed, as they hoped that, owing to the attempted reduction of the men *in detail*, there would be no concerted resistance offered, and felt they could easily coerce individuals.

We assert that resistance to oppression in any form or shape is just, and cannot, through any process of reasoning, be construed in the light of dictation as to the "running" of an employer's business. We claim that the fixing of our rates of pay is a question in which we are interested; and as far as this may be a part of an employer's business, we have a *right* to a voice in its adjustment.

We claim the right (one which appears to be conceded to capital) to associate or combine for our advancement or benefit; and, also, that the reward which labor secures directly interests all who work in our (as well as in any other) line of industry. We fail, then, to see how a committee from our company, or organization, should not be competent to act for us in the capacity of arbitrators with a meter manufacturing company or organization.

The refusal on the part of that company to treat with us, and insisting that the men shall apply in detail for work, is but a repetition of the former methods adopted in the attempt to enforce the reduction.

As to the law of supply and demand spoken of by yourself, in the article alluded to, we submit that it does not apply to the case in question. No reduction of force was contemplated; and the law quoted did not demand a necessitated reduction, as admitted by the subsequent action of the Goodwin Company.

We, as wage-earners, have a sufficient knowledge of such a law, and propose, by all honorable means, to regulate, as far as possible, its operations.

CHAS. A. THERTON,
JOS. F. FEENEY,
GEO. HOBELL, Sr., } Committee.
EDWARD CLAYTON,
EDWARD MAGUIRE. }

[The "bold knight" who penned the above screed did not have time probably to append any of the forms generally adopted at the closing of a correspondence. Hence we are obliged to insert the communication bereft of the formal winding up that varies so greatly between the extremes of "Fondly yours," in the case of warm friendship, to that of the irate party, who, after conveying the information that he is about to sue you, precedes his signature with, "I am, sir, etc." Now, Messrs. Knights, the *JOURNAL* has no good reason to take back a single word that appeared in its columns of March 16th, and, furthermore, it does not. Should the Goodwin Manufacturing Company see fit to make any reply to the above-given "arguments" of the "regulators," an opportunity will be so afforded in our columns, and then we will consider the matter as at an end.]

* See *JOURNAL*, issue April 2d, 1884.



A. M. CALLENDER & CO.,
PROPRIETORS.

Editor—JOS. R. THOMAS, C.E.
Manager—C. E. SANDERSON.

PUBLISHED ON THE 2ND AND 16TH OF EACH MONTH
At No. 42 Pine Street, New York.

This is a recognized official organ of—
LIGHT, HEAT, STEAM, WATER-SUPPLY,
VENTILATION, SANITARY IMPROVEMENT,
AND GENERAL SCIENCE.

TERMS

SUBSCRIPTION—Three Dollars per annum, in advance.

AGENTS

NEW YORK—AMERICAN NEWS Co. 39 and 41 Chambers St.
BOSTON—S. M. PETTINGILL & Co., 6 State Street.
PHILADELPHIA—PRATT & Co., Corner 9th and Arch Streets.
England—C. W. HASTINGS, 22 Buckingham St., London, W. C.
Germany—B. WESTERMANN & Co., of New York

THURSDAY, APRIL 16, 1885.

The Market for Gas Securities.

The depression in Consolidated, noted at time of last writing, has ruled throughout the fortnight. Dealings were on a smaller scale, the footing of transactions showing that up to close on Saturday, April 11th, 183½ shares had been disposed of on Stock Exchange. The price ranged between the extremes of 85 and 82½, bulk of transfers being made in neighborhood of 84. The bid price at opening to-day (Tuesday, April 14th) was 83, sellers holding out for 84. The Commission measure will have a hearing in Assembly at Albany this afternoon. Present advices point to higher prices for Consolidated before end of month, and we are inclined to think this would be a good time to purchase. Mutual paid a quarterly dividend of 2½ per cent on April 10th. Equitable is strong, and it is asserted that the Company will pay a dividend on or before June 1st. It figures this year as a bidder for street lighting, offering to light city lamps at rate of \$12 per annum. Should it get an award the managers would not add much to their surplus account at the proposed price. Baltimore Con. is weak and lower; it is said the Chesapeake opposition corporation means business. Fulton Municipal (Brooklyn) pays a dividend of 3 per cent, on April 16th. Washington (D. C.) is up to 212½; New Haven (Conn.) is also held at advancing figures.

Gas Stocks.

Quotations by Geo. W. Close, Broker and Dealer in Gas Stocks,

16 WALL ST., NEW YORK CITY.

APRIL 16.

All communications will receive particular attention.
The following quotations are based on the par value of \$100 per share.

	Capital.	Par.	Bid	Asked
Consolidated.....	\$35,430,000	100	83	84
Central.....	440,000	50	60	—
“ Scrip.....	220,000	—	47	57
Equitable.....	2,000,000	100	107	109
“ Bonds.....	1,000,000	—	106	108
Harlem, Bonds.....	170,000	—	—	—

Metropolitan, Bonds....	658,000	—	112	113
Mutual.....	3,500,000	100	124	125x
“ Bonds.....	1,500,000	1000	104	106
Municipal, Bonds.....	750,000	—	107	110
Northern.....	125,000	50	—	80
“ Scrip.....	108,000	—	—	—
Gas Co's of Brooklyn.				
Brooklyn.....	2,000,000	25	131	133
Citizens.....	1,200,000	20	84	86
“ S. F. Bonds....	320,000	1000	106	110
Fulton Municipal.....	3,000,000	100	147½	149x
“ Bonds.....	300,000	—	104	108
Peoples.....	1,000,000	10	79	80
“ Bonds.....	290,000	—	105	110
“ “.....	250,000	—	90	95
Metropolitan.....	1,000,000	100	96	—
Nassau.....	1,000,000	25	121	123
“ Cfts.....	700,000	1000	92	94
Williamsburgh.....	1,000,000	50	132	135
“ Bonds... ..	1,000,000	—	106	108
Richmond Co., S. L.	300,000	50	64	75
“ Bonds.....	40,000	—	—	—
Out of Town Gas Companies.				
Buffalo Mutual, N. Y.	750,000	100	80	85
“ Bonds... ..	200,000	1000	95	100
Citizens, Newark.....	918,000	50	103	115
“ “ Bonds.	124,000	—	105	110
Chicago Gas Co., Ills... ..	5,000,000	25	128	132
Peoples G. L. & C. Co., Chicago, Ills.....			8	12
Cincinnati G. & C. Co.			180	182
Consolidated, Balt.....	6,000,000	100	54¾	55
“ Bonds.....	3,600,000	—	107	107½
Central, S. F., Cal.....			—	58
Capital, Sacramento, Cal.			56	—
Hartford, Conn.....	750,000	25	123	129
Jersey City.....	750,000	20	145	—
Laclede, St. Louis, Mo.	1,600,000	100	88	—
Louisville, Ky.....	1,500,000	50	95	100
Montreal, Canada.....	2,000,000	100	181	182½
New Haven, Conn.....		25	166	170
Oakland, Cal.....			29	30
Peoples, Jersey City... ..			—	45
“ “ Bonds.. ..			—	—
Paterson, N. J.....		25	90	—
Rochester, N. Y.....		50	75	80
Washington, D. C.....	2,000,000	20	172½	—
Wilmington, Del.....		50	199	210
Yonkers.....		50	90	92
St. Louis, Missouri.....	600,000	50	—	—
San Francisco Gas Co.				
San Francisco, Cal....			56¾	57½
Havana (Cuba) Gas Co.	3,000,000	100	8	—
“ Bonds.....	550,000	—	—	—

Advertisers Index.

	Page
GAS ENGINEERS.	
Jos. R. Thomas, New York City	213
Wm. Henry White, New York City.....	218
GAS WORKS APPARATUS AND CONSTRUCTION.	
James R. Floyd, New York City	219
T. F. Rowland, Greenpoint, L. I.....	219
Deily & Fowler, Phila., Pa.....	219
Kerr Murray Mfg. Co., Fort Wayne, Ind.....	219
Stacey Mfg. Co., Cincinnati, Ohio.....	219
Bartlett, Hayward & Co., Baltimore, Md.....	219
Morris, Tasker & Co., Limited, Phila., Pa.....	218
Davis & Farnum Mfg. Co., Waltham, Mass.....	181
Tanner & Delaney Engine Co., Richmond, Va.....	218
R. D. Wood & Co., Phila., Pa.....	218
Southwark Foundry and Machine Co., Philadelphia, Pa.....	218
GAS AND WATER PIPES.	
A. H. McNeal, Burlington, N. J.....	216
Gloucester Iron Works, Phila., Pa.....	216
Warren Foundry and Machine Co., Phillipsburgh, N. J.....	216
Mellert Foundry and Machine Co., Reading, Pa.....	216
Cincinnati and Newport Iron and Pipe Co., Newport, Ky.....	216
PIPE JOINTS.	
Pancoast & Maule, Philadelphia, Pa.....	212
Rollstone Machine Company, Fitchburg, Mass.....	212
SCRUBBERS AND CONDENSERS.	
G. Shepard Page, New York City.....	217

REGENERATOR FURNACES.	
Charles F. Dieterich, Baltimore, Md.....	158
GAS ENGINES.	
Schleicher, Schumm & Co., Phila., Pa.....	224
Continental Gas Engine Co., New York City.....	220
RETORTS AND FIRE BRICK.	
J. H. Gautier & Co., Jersey City, N. J.....	214
B. Kreischer & Sons, New York City.....	214
Adam Weber, New York City.....	214
Laclede Fire Brick Works, St. Louis, Mo.....	214
Brooklyn Retort and Fire Brick Works, Brooklyn, N. Y.....	214
Borgner & O'Brien, Phila., Pa.....	214
William Gardner & Son, Pittsburgh, Pa.....	214
Henry Maurer, New York City.....	214
Chicago Retort and Fire Brick Works, Chicago, Ills.....	214
Baltimore Retort and Fire Brick Co., Baltimore, Md.....	214
Standard Gas Retort and Fire Brick Co., Ironton, Ohio.....	214
Oakhill Gas Retort and Fire Brick Co., St. Louis, Mo.....	214
Cincinnati Gas Retort & Fire Brick Co., Cincinnati, O.....	214
GAS STOVES.	
American Meter Co., New York and Philadelphia.....	215
The Goodwin Gas Stove and Meter Co., Philadelphia, Pa.....	196
VALVES.	
Ludlow Valve Manufacturing Co., Troy, N. Y.....	216
John McLean, New York City.....	216
GAS METERS.	
Harris, Griffin & Co., Phila., Pa.....	222
American Meter Co., New York and Philadelphia.....	223
The Goodwin Gas Stove and Meter Co., Phila. Pa.....	223
Helme & McIlhenny, Phila., Pa.....	223
Maryland Meter and Mfg. Co., Baltimore, Md.....	222
D. McDonald & Co., Albany, N. Y.....	223
Nathaniel Tufts, Boston, Mass.....	222
EXHAUSTERS.	
P. H. & F. M. Roots, Connersville, Ind.....	213
Smith & Sayre Manufacturing Co., New York City.....	218
Wilbraham Bros., Philadelphia, Pa.....	220
GAS COALS.	
Penn Gas Coal Co., Phila., Pa.....	221
Perkins & Co., New York City.....	220
Newburgh Orrel Coal Co., Baltimore Md.....	221
Despard Coal Co., Baltimore, Md.....	221
Chesapeake and Ohio R.R. Coal Agency, N. Y. City.....	221
Westmoreland Coal Company, Phila., Pa.....	221
GAS LAMPS.	
Siemens Regenerative Gas Lamp Co., Philadelphia, Pa.....	217
G. Shepard Page, New York City.....	221
GAS KILNS AND OVENS.	
Thompson Gas Kiln and Oven Co., New York City.....	213
PURIFIER SCREENS.	
John Catot, Lawrence, Mass.....	212
STREET LAMPS.	
J. G. Miner, Morrisania, New York City.....	212
Bartlett Street Lamp Mfg Co., New York City.....	213
BURNERS.	
G. Geffroyer, Phila., Pa.....	218
PURIFYING MATERIAL.	
Connelly & Co., New York City.....	212
STEAM BLOWER FOR BURNING BREASE.	
H. E. Parson, New York City.....	184
PIPE COVERINGS.	
Chalmers-Spence Company, N. Y. City.....	212
GAS FIXTURES.	
Mitchell, Vance & Co., New York City.....	212
STEAM ENGINES.	
Westinghouse Machine Co., Pittsburg, Pa.....	221
STEAM PUMPS.	
A. S. Cameron Steam Pump Works, N. Y. City.....	213
HYDRAULIC ELEVATOR.	
Lane & Bodley Company, Cincinnati, Ohio.....	213
SHAFTING, PULLEYS, ETC.	
A. & F. Brown, New York City.....	212
HYDRAULIC MAIN.	
A. E. Boardman, Macon, Ga.....	213

Position Wanted,

As Superintendent, Assistant Superintendent, or Foreman
In a large works. Has had 15 years' practical experience in the erection and management of gas works. Can lay mains, do gas fitting, and has a thorough knowledge of the practical workings of gas works. Is capable, willing, and energetic. Address
C20-11 "W. C. H." Selma Gas Co., Selma, Ala.

**Situation Wanted
As Gas Manager.**

Thoroughly experienced in the manufacture and distribution of coal gas. Large experience in England. Has had the management of works making 250,000,000 cu. ft. per year. Unquestionable testimonials. Apply to "S. S.," 620 It 843 North Robey Street, Chicago, Ill.

Situation Wanted

As Superintendent of a Small Works.

Does his own mechanical work in all branches when needed. Has had several years' experience. Good references. Address 620-It "A. Y.," care this Journal.

Appointment Desired,

By a graduate of the School of Mines of Columbia College, in a **Water Gas Works** in or near New York city. Speaks English and German. Age, 22 years. Address O. BODELSEN, 618-It 1072 Tenth Avenue, N. Y. City.

**WANTED,
Second-Hand**

Gas Works Apparatus.

Hydraulic Main, Dip, Bridge, and Stand Pipes for a hench of sixes; Four Purifying Boxes, with either 6 or 8 inch seal and connections. The material must be in good condition. Address 619-It E. McMILLIN, Columbus, Ohio.

**FOR SALE,
One Station Meter,**

Capacity, 500,000 feet.

Four Purifiers,

16 ft. by 16 ft. by 4 ft., with trays, covers, carriages, and 10 in. connections complete.

One Dry 10-inch Center Seal, 10-inch Gas Valves, and Cast Iron Pipe.

All in good condition. Address E. McMILLIN, Columbus, Ohio.

FOR SALE,

100 MINER GLOBE STREET LAMPS.

The lamps have been in use, but only those that are in good order are offered for sale. For terms, etc., address

THE NEW YORK & NEW JERSEY GLOBE GAS LIGHT CO., 615-It No. 1 Park Place, New York City.

It will "Pay the Piper,"

If he aims to pipe well for STEAM, WATER, GAS, ACIDS, OILS, AMMONIA, &c., to examine this UNION, which requires no packing, but is always ready for instant use. When you next order Fittings of any Dealer, ask for a sample American Union to come with them, and it will tell you the whole story, or we will, if you write us for particulars.

PANCOAST & MAULE, PHILADELPHIA, PA.

HODGE'S UNIVERSAL ANGLE UNION, Pat'd

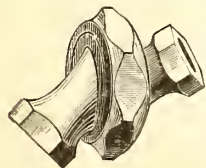

A new and important Pipe Fitting for Steam, Water, or Gas. Combining a variable angle or elbow and a union. Saves pipe, saves time, decreases friction and radiation, gives a union joint at every angle, and can be set at any angle at which it is desired to run the pipe.

HODGE'S SWIVEL FLANGE,

A common sense article, designed to save time and money.

MANUFACTURERS AND WHOLESALE AGENTS,

ROLLSTONE MACHINE CO.,

142 Water St., Fitchburg, Mass.

For Sale at a Bargain.

COMPLETE 4-INCH GAS GENERATING APPARATUS,

From our old works. Iron Frame for Roof; Mouthpieces, Stand Pipes, etc., etc.

Just the thing for adding to capacity of works already in operation, or for starting a new works. Address

616-St GAS COMPANY, LIMA, OHIO.

THE GLOBE STREET LAMP.

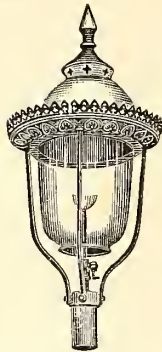

MINER'S PATENT STREET LAMPS.

Are adapted for use of Streets, Parks, Depots, Ferries, & Private Grounds.

WITH POSTS OR BRACKETS.

Jacob G. Miner,

MORRISANIA, N. Y. CITY.



Shafting, Pulleys, HANGERS.

F. Brown's Patent Friction Clutch.

Send for Illustrated Catalogue and Discount Sheet to

A. & F. BROWN,

No. 43 Park Place, New York City.

Pipe Coverings.

Fireproof, Non-Conducting Coverings for **STEAM PIPES, BOILERS, And all Hot Surfaces.**

Made in sections three feet long. Easy to apply; light and cheap. Asbestos Materials, Fibre, Braided Packing, and Cement. These goods are used at Continental Works, Br'klyn. **CHALMERS-SPENCE COMPANY, 419 & 421 EIGHTH ST., N. Y.**

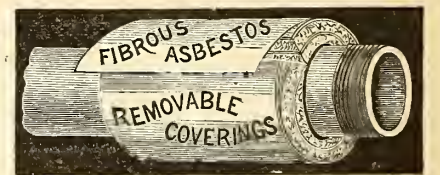

CHURCH'S REVERSIBLE SCREEN FOR GAS PURIFIERS

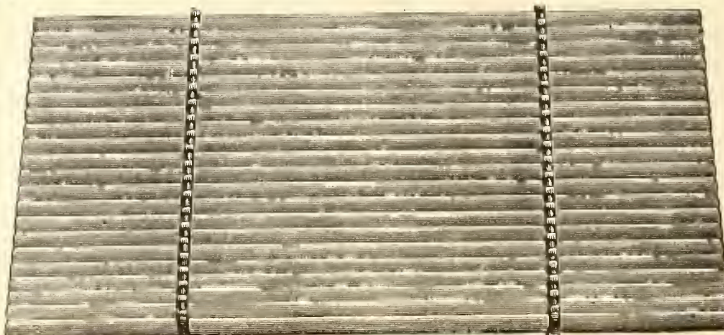

Very Durable Easily Repaired.

Oval Slats, with Malleable Iron Cross Bars.

Apply to

JOHN CABOT,

LAWRENCE, MASS.

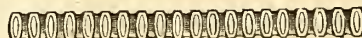

PATENTED JULY 9, 1878.

References in all parts of the country. Send for circular and list of companies who now have the Screen in use.

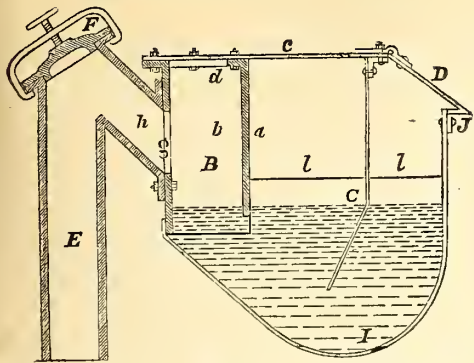

Boardman Hydraulic Main,

Patented October 7, 1884.

For description, see AM. GAS LIGHT JOURNAL of Feb. 2, 1884.
For terms, apply to

A. E. BOARDMAN, Macon, Ga.

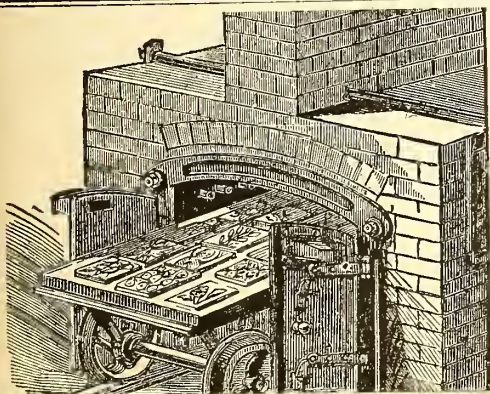

Glass-Staining Gas Kiln.

BAKERS' & CONFECTIONERS' OVENS (PAT.)

Thompson Gas Kiln & Oven Co.

59 Carmine St., N. Y.
Send for Circular by mail.

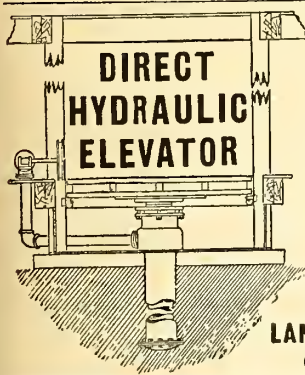

DIRECT HYDRAULIC ELEVATOR

With Iron or Wood Platform.

Largely used by Leading Gas Co.s for Coal and Coke Lifts.

Adapted for use with city service, or special pumping and accumulation system. For prices address the

LANE & BODLEY CO., Cincinnati, O.

JOS. R. THOMAS, C.E.,

May be Consulted on all Matters Relating to Gas Works and Gas Manufacture.

ADDRESS THIS OFFICE.

The Management of Small Gas Works.

BY C. J. R. HUMPHREYS.

Price, \$1.

Orders to be sent to **A. M. CALLENDER & CO.,**
42 PINE STREET, NEW YORK.

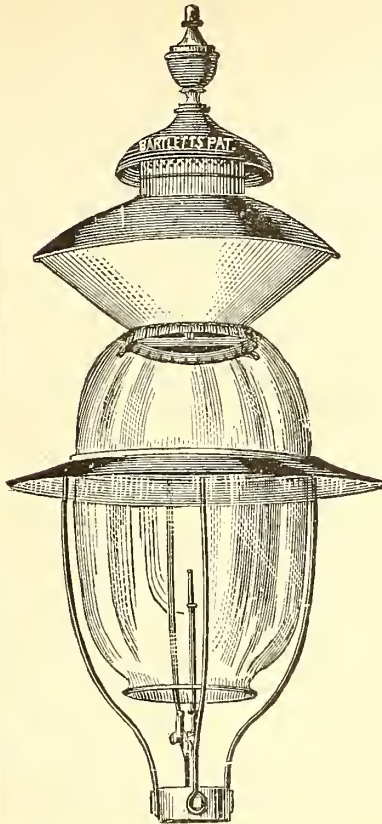

C. BARCALOW, PREST.

J. V. BARCALOW, SEC. & TREAS.

BARTLETT Street Lamp Mfg. Co.

MANUFACTURERS OF

Bartlett's Patent

GLOBE LAMPS.

FOR

Streets, Parks, Railroad Stations, Public Buildings, Etc.

LAMP POSTS A SPECIALTY.

Office and Salesroom,

No. 35 Howard Street, N. Y. City.

Gas Companies and others intending to erect lamps and posts will do well to communicate with us.

F. M. ROOTS.

S. C. ROOTS

D. T. ROOTS.

P. H. & F. M. ROOTS
PATENTEES AND MANUFACTURERS OF

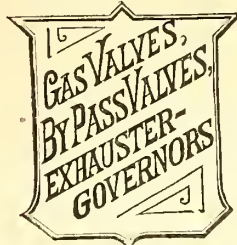

GAS VALVES, BY-PASS VALVES, EXHAUSTOR GOVERNORS

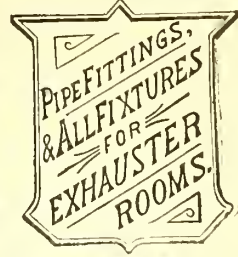
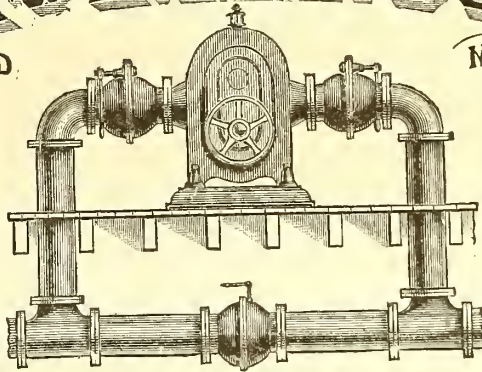

PIPE FITTINGS, & ALL FIXTURES FOR EXHAUSTOR ROOMS.

IMPROVED GAS EXHAUSTER,

WITH ENGINE ON SAME BED PLATE, OR WITHOUT.

BYE-PASSES, GAS VALVES, GOVERNORS, ELBOWS, PIPE-FITTINGS, Etc., FURNISHED TO ORDER,

P. H. & F. M. ROOTS, Patentees & Manufacturers, **CONNERSVILLE, IND.**

S. S. TOWNSEND, General Agent, 22 Cortland St. and 9 Dey St., N. Y.

JAS. BEGGS & CO., Selling Agents, 9 Dey St., N. Y.

COOKE & CO., Selling Agents, 22 Cortland St., N. Y.

SEND FOR ILLUSTRATED CATALOGUE AND PRICE LIST.

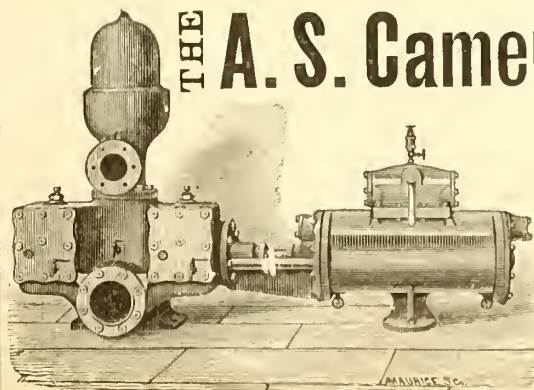

THE A. S. Cameron Steam Pump,

THE STANDARD OF EXCELLENCE.

Upward of 30,000 in Use.

BEST GAS WORKS PUMP

Ever Introduced.

Adapted to Every Possible Duty.

A.S. Cameron Steam Pump Works,

Foot East 23d St., N. Y.

J. H. GAUTIER & CO.,
CORNER OF
GREENE AND ESSEX STREETS,
JERSEY CITY, N. J.

MANUFACTURERS OF
**Clay Gas Retorts,
Gas House Tiles,
Fire Bricks, Etc. Etc.**

Ground Clay, Fire Brick and
Fire Sand in Barrels,

J. H. GAUTIER. T. B. GAUTIER.
C. E. GREGORY. C. E. GAUTIER.

BROOKLYN
Clay Retort & Fire Brick Works,
(EDWARD D. WHITE & CO.)
Manufacturers of Clay Retorts, Fire Brick,
Gas House and other Tile.
VAN DYKE, ELIZABETH, RICHARDS & PARTITION STS.
Office, 88 Van Dyke St., Brooklyn, N. Y.

LACLEDE FIRE BRICK MFG. CO.,
MANUFACTURERS OF
Fire Brick, Gas Retorts,

AND
ST. LOUIS STANDARD SEWER PIPE.
Blast Furnace and Cupola Linings, every description of Fire
Clay Material, Fire Clay Flue Linings, Chimney Tops
Dry Milled and Crude Fire Clays, etc.

OFFICE AND DEPOT
901, 903, and 905 Pine Street,
ST. LOUIS, MO.

ESTABLISHED IN 1845.

B. KREISCHER & SONS,
OFFICE FOOT OF HOUSTON ST., E. R., N. Y.

**Gas Retorts,
TILES, FIRE BRICK.**
AND EVERYTHING IN THE FIRE CLAY LINE.

MANHATTAN
FIRE BRICK & ENAMELLED CLAY
RETORT WORKS.
ADAM WEBER.

**CLAY GAS RETORTS
AND RETORT SETTINGS,
FIRE BRICKS, TILES, ETC.,**
Office and Works, 15th Street and Avenue C., N. Y.

CHICAGO
Retort & Fire Brick Works,
OFFICE AND FACTORY,
Clark, Forty-Fifth, and La Salle Streets,
CHICAGO, ILL.
GEORGE C. HICKS, PRES. PAUL P. AUSTIN, SEC. & TREAS.
STANDARD
Clay Retorts and Settings.
BLOCKS & TILES
Of every Shape and Size to Order.
Standard Fire Bricks.

JAMES GARDNER, JR.
Works,
LOCKPORT STATION, PA.

—ESTABLISHED 1864.—
WILLIAM GARDNER & SON,
Successor to GARDNER BROTHERS.

WILLIAM GARDNER.
Office, COAL EXCHANGE,
PITTSBURGH, PA., P. O. Box 373.

Fire Clay Goods for Gas Works.

C. H. SPRAGUE, No. 70 KILBY STREET, BOSTON, MASS., Agent for the New England States.

OFFICE, 418 to 422 East 23d St., New York.

ESTABLISHED 1856.

WORKS, PERTH AMBOY, NEW JERSEY.

HENRY MAURER,
Excelsior Fire Brick & Clay Retort Works
CLAY GAS RETORTS, BENCH SETTINGS, FIRE BRICK, TILES, ETC.

STANDARD GAS RETORT AND FIRE BRICK COMPANY,
J. ANDERSON, PRES. & MANG'R. OF IRONTON, OHIO. C. PETERS, SECRETARY.
Clay Gas Retorts, Fire Brick, and Fire Clay Goods of Every Description.
Plans of Livescy-Somerville, McIlhenny, and other Furnaces, and Competent Workmen Supplied.



CINCINNATI
Gas Retort & Fire Brick Co.,
(ESTABLISHED 1872.)
CINCINNATI, OHIO.
Manufacturers of Gas Retorts, Retort Settings, Fire Brick, Tiles, Etc.

OAKHILL
GAS RETORT & FIRE BRICK
COMPANY.
PARKER, RUSSELL & CO.
City Office, 711 Pine Street,
ST. LOUIS, MO.

Our immense establishment is now employed almost entirely in the manufacture of
MATERIALS FOR GAS COMPANIES.
We have studied and perfected three important points. Our retorts are made to stand changes of temperature, the strongest heats of the furnace, and the abrasion of feeding and emptying. Our customers are in almost every State of the Union, to all of whom we refer.

THOS. SMITH, Prest. AUGUST LAMBLA, Vice-Prest. & Sup
BALTIMORE
RETORT & FIRE BRICK CO.
MANUFACTORY AT
LOCUST POINT, BALTIMORE, MD.
Connection with the City by Telephone.
**Clay Retorts, Blocks & Tiles,
FIRE BRICK, FIRE CLAY,
AND FIRE CEMENT.**
Red and Buff Ornamental Tiles and Chimney Tops. Drain and Sewer Pipe (from 2 to 30 inches). Baker Oven Tiles 12x12x2 and 10x10x2.
WALDO BROS., 88 WATER ST., BOSTON, MASS.
Solo Agents for New England States

THE AMERICAN METER CO.,

MANUFACTORIES,

512 West Twenty-second Street, N. Y. Arch and Twenty-second Street, Phila.
Nos. 244 & 246 North Wells Street, Chicago, Ill.

AGENCIES,

No. 177 Elm Street, Cincinnati, Ohio. Nos. 122 & 124 Sutter Street, San Francisco, Cal.
No. 810 North Second Street, St. Louis, Mo.

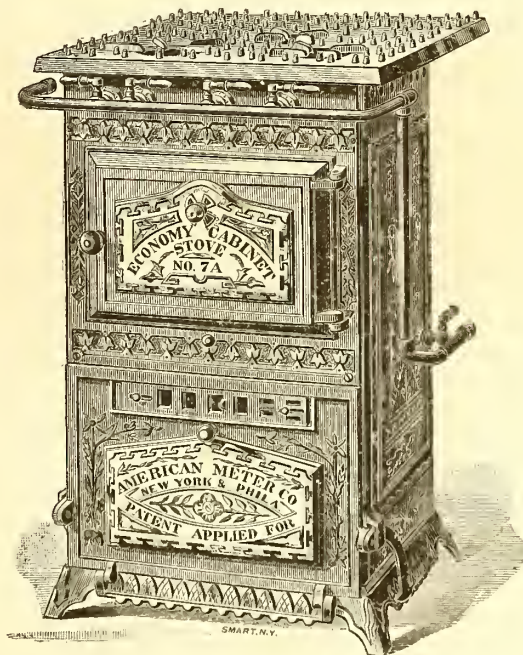

NEW DESIGN STOVES MADE IN CAST IRON, WITH EITHER OPEN OR CLOSED TOPS.

In presenting our "Economy" Gas Cooking Stoves and Ranges for the Season of 1885, we have the pleasure to inform our patrons that the increasing demand for these Stoves has encouraged us to make entirely new patterns, of HIGHLY ORNAMENTAL DESIGNS, for the popular sizes. We have also embraced the opportunity to increase the size of these Stoves, giving greater TOP PLATE AND OVEN capacity.

Full Lists and Catalogues are in preparation, and large stocks of Stoves will be kept at our Manufactories and Agencies for prompt shipment.

AMERICAN METER CO.

A. H. M'NEAL,

BURLINGTON, N. J.

Flange-Pipes

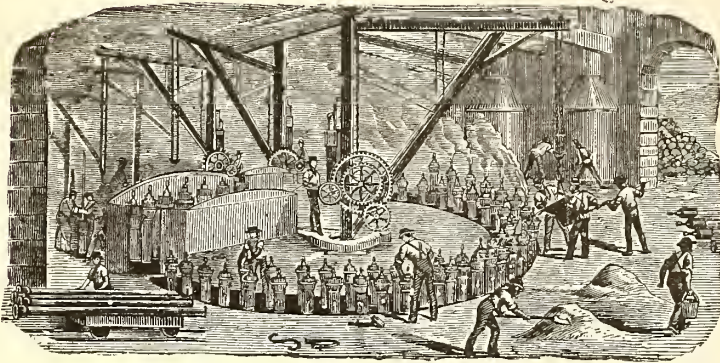

General Foundry Work.

CAST IRON PIPES FOR WATER AND GAS.

JAMES S. MOORE, Pres.
BENJAMIN CHEW, Treas.

JAS. P. MICHELON, Sec.
WM. SEXTON, Supt.

GLOUCESTER IRON WORKS, GLOUCESTER CITY, N. J.

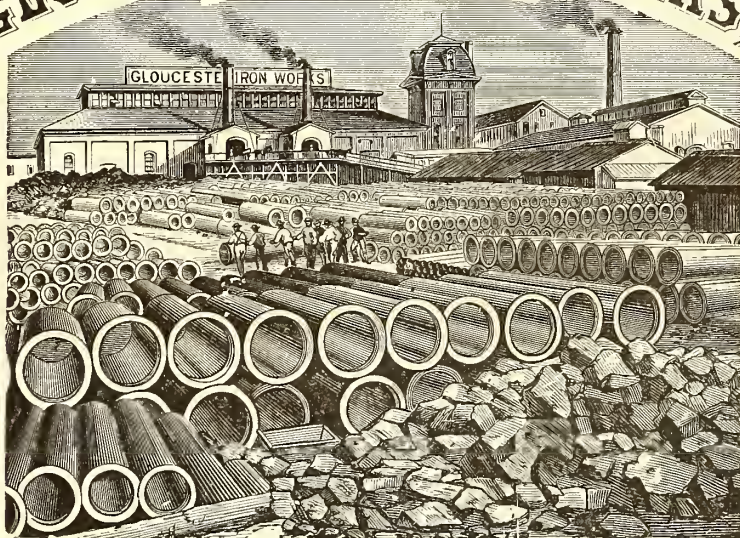

Cast Iron Gas & Water Pipes, Stop Valves, Fire Hydrants, Gasholders. &c.
Office No. 6 North Seventh Street, Philadelphia.

ESTABLISHED 1856.

WARREN FOUNDRY AND MACHINE CO.,
WORKS AT PHILLIPSBURGH, N. J.
NEW YORK OFFICE, 162 BROADWAY.

Cast Iron Water and Gas Pipe

FROM TWO TO FORTY-EIGHT INCHES DIAMETER.
ALSO ALL SIZES OF

FLANGE PIPE for Sugar House and Mine Work.
Branches, Bends, Retorts, Etc., Etc.

436-1

MATTHEW ADDY, President

W. L. DAVIS, Selling Agent.

GEO. P. WILSHIRE, Sec. & Treas.

Cincinnati and Newport Iron and Pipe Company,

NEWPORT, KY.

Lamp Posts

AND

BENCH CASTINGS

A Specialty.



Branch

AND

SPECIAL CASTINGS

FOR GAS & WATER CO'S.

Large & Heavy Castings for General Work.

Manufacture Pipe from 2 to 48 inches. All work guaranteed first quality.

Mellert Foundry and Machine Co.

Limited. Established 1848.
MANUFACTURERS OF



Specials—Flange Pipe, Valves and Hydrants,
Lamp Posts, Retorts, etc.
Machinery and castings for Furnaces, Rolling Mills, Grist and
Saw Mills, Mining Pumps, Hoists, etc.

GENERAL OFFICE, - - - READING, PA.

LUDLOW VALVE MFG. CO.

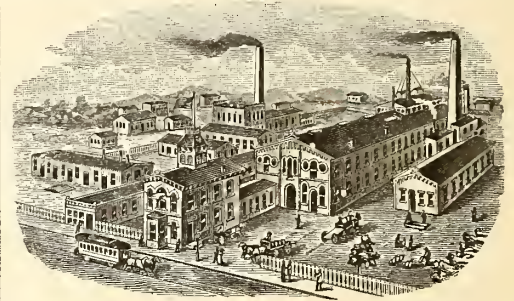

OFFICE AND WORKS,

938 to 954 River Street and 67 to 83 Vail Av.,
TROY, N. Y.

Hydraulic Main Dip Regulators, also
Check Valves, Foot Valves, Yard-
wash and Fire Hydrants.
Send for Circulars.

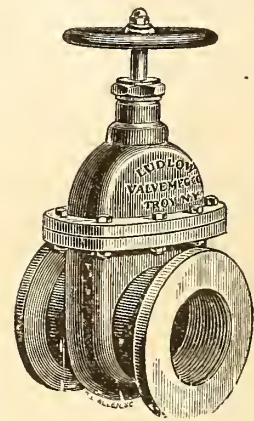

Valves.—Double and Single Gate, 1/2 in. to
48 in., outside and inside Screws. Indica-
tor, etc., for Gas, Water, Steam, and Oil.
Send for Circulars.

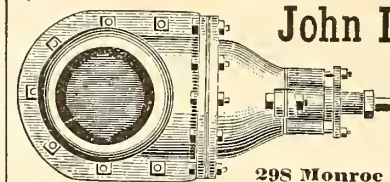

John McLean

Manufacturer of

GAS VALVES.

298 Monroe Street, N. Y.

PRESERVE

The Journal

BY THE USE OF

THE STRAP FILE.

Advantages of the Strap File.

- 1st. It is simple, strong, and easily used.
- 2d. Preserves papers without punching holes.
- 3d. Will always lie flat open.
- 4th. Allows any paper on file to be taken off without disturbing the others.

Price, \$1.25. Sent either by express or mail, at directed. By mail the postage will be 20 cts., which will be added to the price of the Binder.

A. M. CALLENDER & CO., 42 PINE ST., N. Y.

Siemens's Regenerative Gas Burners, For Lighting and Ventilating.

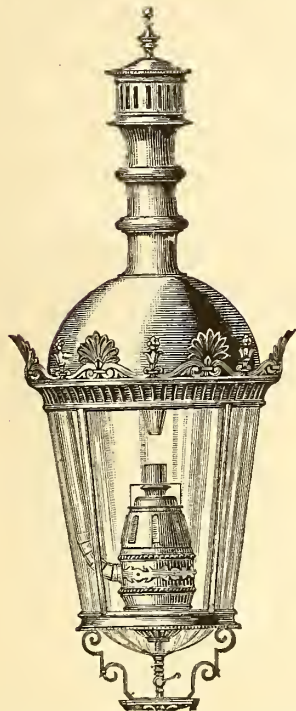

THE CHEAPEST, PUREST, AND MOST BRILLIANT OF ALL GAS LIGHTS.

Superior to the Electric Light in Economy, Beauty, & Steadiness.

SPECIALLY ADAPTED FOR LIGHTING HALLS, FACTORIES, OPEN SPACES, ETC.

Numerous Tests made by various Gas Companies in the United States show an Efficiency of Ten Candle Power per Cubic Foot of Gas.

General Agents:

- SIEMENS LIGHTING CO., 347 West Main St., Louisville, Ky.
- MEYER, MARSHALL & CO., 528 California St., San Francisco.
- DENNEHY, WOLF & O'BRIEN, 85 & 87 Dearborn St. Chicago, Ill.
- WILCOX & McGEARY, - No. 11 Bissel Block, Pittsburgh, Pa.
- T. T. RAMSDALL & CO., - 20 Swan Street, Buffalo, N. Y.
- SIEMENS GAS ILLUMINATING CO.,
Room 6, No. 157 Broadway, New York City.
- W. D. COLT, - - - - 1420 F Street, Washington, D. C.
- JOHN KIEFER, - - - 344 Lawrence, Street, Denver, Col.

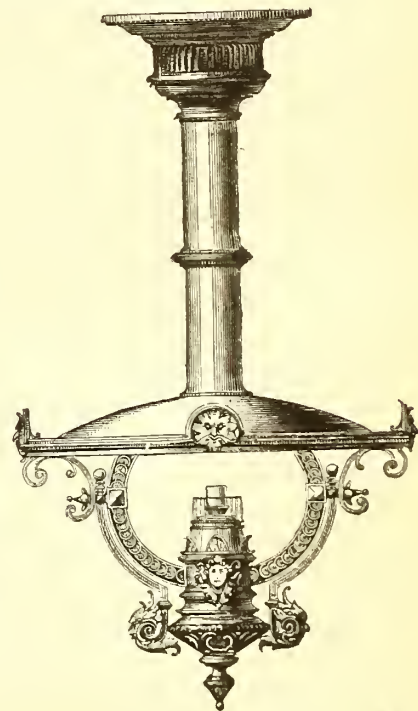

THE SIEMENS REGENERATIVE GAS LAMP COMPANY.

SOLE MAKERS FOR THE UNITED STATES,

N. E. Cor. 21st. St. and Washington Av., Philadelphia. Pa.

THE "STANDARD" WASHER-SCRUBBER,

KIRKHAM, HULETT & CHANDLER'S PATENT.

Total Capacity per 24 Hours of "Standard" Washers Ordered During the Following Years.

1877.....	4,000,000 cubic feet.
1878.....	4,750,000 "
1879.....	24,545,000 "
1880.....	42,067,500 "
1881.....	36,462,500 "
1882.....	37,300,000 "
1883.....	57,735,000 "
1884.....	26,177,500 "
Total.....	235,937,500 cubic feet.

Total Number and Capacity per 24 Hours of "Standard" Washers Erected and in Course of Erection in the Several Countries

	Number.	Cubic Feet per Day.
Great Britain ..	151	157,070,000
Western Hemisphere.....	38	39,337,500
Australia	18	12,150,000
New Zealand	2	650,000
France	6	4,550,000
Belgium.....	8	5,420,000
Germany	16	8,200,000
Holland.....	4	4,160,000
Denmark.....	1	150,000
Russia	2	3,500,000
Spain	1	350,000
India.....	1	400,000
Total.....	218	235,937,500

**THE CONTINUED POPULARITY
Of these Machines**

Will be recognized from the following extracts from letters from representatives of some of the companies having them in use:

TOLEDO GAS LIGHT AND COKE CO., {
TOLEDO, OHIO, NOV. 25, 1884. }

GEO. SHEPARD PAGE, Esq.:

Dear Sir—Replying to your kind favor of 21st inst., I would say that the "Standard" Washer-Scrubber is doing work that is entirely satisfactory to us. During the summer I had 12-oz. liquor; but since cool weather commenced I have been having from 18 to 23-oz. liquor, just as we would expect. There is not a trace of ammonia passing the Scrubber that a test of reddened litmus or yellow turmeric paper would indicate. The machine, in my opinion, is all that could be desired as a means for removing all the ammonia from the gas. Very respectfully,

C. R. FABEN, Jr.,

Superintendent.

"Standard" Washers Ordered During the Current Year.

	Cu. Ft. per Day
Anneberg Gas Co.....	200,000
Bombay Gas Co.....	400,000
Brussels Co.....	1,250,000
Chemnitz Gas Co	1,000,000
CITIZENS GAS CO., BUFFALO.....	750,000
Coke Works in Zabre, Ober-Schlesien.....	1,500,000
Cokerei der Friedenshutte, Upper Silesia.	100,000
Dumfries Corporation.....	250,000
Dunedin Gas Co., New Zealand	400,000
King's Lynn Gas Co.....	300,000
Leiden, Holland.....	600,000
Lincoln Gas Co.....	400,000
Liverpool Gas Co.....	2,000,000
" "	3,000,000
LOUISVILLE GAS CO.....	1,500,000
Numea Gas Co.....	100,000
PITTSBURGH GAS CO.....	1,500,000
PORTLAND GAS CO., Oregon	562,500
SAN FRANCISCO GAS CO.....	4,000,000
Sheepbridge	40,000
ST. LOUIS GAS CO.	2,000,000
Sydney Gas Co.....	2,500,000
WASHINGTON, D. C. GAS CO.....	2,000,000
Whitechurch Gas Co	175,000
Total.....	26,177,500

**GEO. SHEPARD PAGE, No. 69 WALL STREET, NEW YORK,
SOLE AGENT FOR THE WESTERN HEMISPHERE.**

R. D. WOOD & CO.,

400 Chestnut Street, Phila., Pa.

Cast Iron Gas & Water Pipe, Water Machinery & Gas Apparatus

Cast Iron Pipe, Fire Hydrants, Eddy Valves, Lamp Posts, Large Loam Castings, Flanged Pipe, Sugar House Work, Iron Roofs and Floors, Wrought & Cast Iron Tanks, Turbine Water Wheels and Pumps.

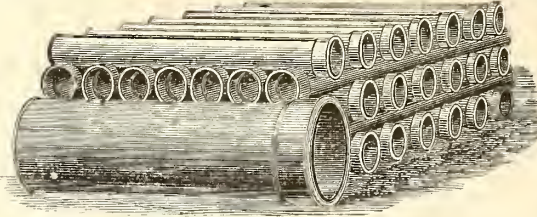

Casholders, Lime Trays, Center Valves, Purifiers, Bench Work, Exhausters, Condensers, Governors, Scrubbers, Gas Valves, Station Meters, Cast Iron Pipe Fittings.

Manufacturers of Heavy Castings and Machinery of Every Description.

ENGINEERS & CONTRACTORS FOR THE ERECTION OF GAS WORKS, & ALL MACHINERY CONNECTED THEREWITH

Estimates and specifications furnished for erection of new works or the extension or alteration of old ones.

Foundries and Works. - - Millville, Florence, and Camden, N. J.

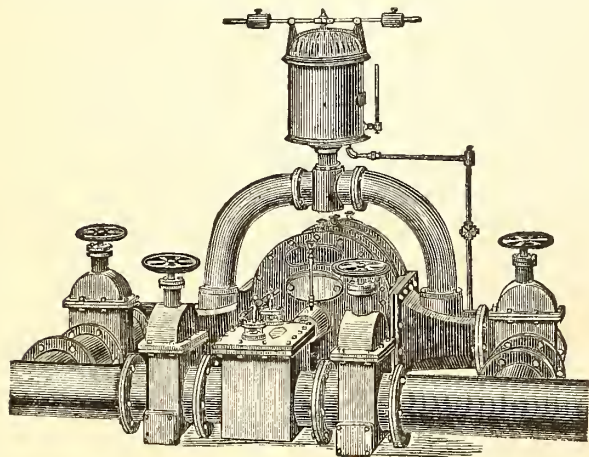
**SMITH & SAYRE MFG. COMPANY,**

G. G. PORTER, Prest.

245 Broadway, N. Y.

CHAS. W. ISBELL, Sec'y.

Machinery & Apparatus for Gas Works

Drawings, Plans, and Estimates Furnished for the Improvement, Extension, or Alteration of Gas Works, or for the Construction of New Works.

Mackenzie's Patent Rotary and Steam Jet Gas Exhausters, Governors, Compensators, Condensers, Washers, Scrubbers. Isbell's Patent Automatic Street Pressure Governor, Gas and Water Valves, Hydraulic Main Dip Regulator, Bench Castings, etc. Purifying Boxes and "Standard" Scrubbers. Isbell's Patent Self-Sealing Retort Doors.

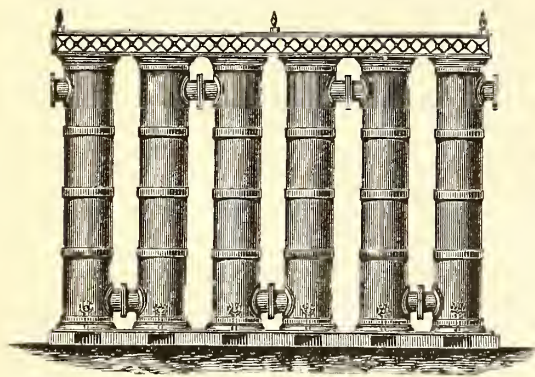

W. E. Tanner, Pres., W. R. Trigg, V.-Pres., A. Delaney, Supt.

Tanner & Delaney Engine Co.
RICHMOND, VA.**Gas Apparatus,**

INCLUDING

Condensers of various styles, Scrubbers, Holders, Purifiers, Castings for Retort Houses, Etc.

ALSO STEAM ENGINES AND BOILERS.

Plans, Specifications and Estimates Furnished.

MORRIS, TASKER & CO.,
Limited,

Builders of Gas Works,
PHILADELPHIA, PA.

To Gas Companies.

We make to order **CAP BURNERS** to burn any amount under a stated pressure. Send for samples.

Also, **SERVICE CLEANERS, DRIP PUMPS, and STREET MAIN PROVING APPARATUS.**

C. A. GEFRORER,
248 N. 8th Street, Phila., Pa.

SOUTHWARK FOUNDRY AND MACHINE COMPANY,

Successors to **MERRICK & SONS.** Established in 1836.

No. 430 Washington Avenue, Philadelphia, Pa.

MANUFACTURERS OF

Single and Telescopic Gasholders,

BENCH CASTINGS,

Washers, Scrubbers, Condensers, Purifiers,

And all apparatus necessary for the construction of improved new gas works and in the extension of established works. Also manufacturers of

Gas Engines, and of all descriptions of Steam and Hydraulic Machinery, and of Boiler and Tank Work.

Plans, specifications, and estimates furnished promptly on application.

WM. HENRY WHITE,

Consulting & Constructing

Gas Engineer & Contractor.

ESTIMATES, PLANS, AND SPECIFICATIONS FURNISHED
FOR NEW WORKS OR EXTENSIONS OF
EXISTING WORKS.

32 Pine St., New York City.

Correspondence solicited.

JAMES R. FLOYD,

(SUCCESSOR TO HERRING & FLOYD)

Oregon Iron Works,

531 to 543 West 20th St., N. Y.

Practical Builders of Gas Works,

MANUFACTURERS OF

**ALL KINDS OF CASTINGS
AND
APPARATUS FOR GAS-WORKS.**

BENCH CASTINGS

from benches of one to six Retorts each.

**WASHERS: MULTITUBULAR AND
AIR CONDENSERS; CONDENSERS;
SCRUBBERS**

(wet and dry), and

EXHAUSTERS

for relieving Retorts from pressure.

BENDS and BRANCHES

of all sizes and description.

FLOYD'S PATENT

MALLEABLE RETORT LID.

PATENT

SELF-SEALING RETORT LIDS.

FARMER'S

PATENT BYE-PASS DIP-PIPE.

SABBATON'S PATENT

FURNACE DOOR AND FRAME.

BUTLER'S

COKE SCREENING SHOVELS.

GAS GOVERNORS,

and everything connected with well regulated Gas Works at low price, and in complete order.

SELLER'S CEMENT

for stopping leaks in Retorts.

N. R.—STOP VALVES from three to thirty inches—
at very low prices.

Plans, Specifications, and Estimates furnished.

KERR MURRAY MFG. CO.,

MANUFACTURERS OF

Single Lift and Telescopic

GASHOLDERS.

Built, 1884:

Altoona, Pa	Capacity, 160,000 cubic feet.
Pittsburgh, Pa	" 250,000 "
" "	" 230,000 "
Bellaire, Ohio	" 50,000 "
Youngstown, Ohio	" 60,000 "
Canton, "	" 60,000 "
Akron, "	" 80,000 "
Xenia, "	" 10,000 "
Adrian, Mich	" 65,000 "
Ypsilanti, Mich	" 25,000 "
Muskegon, "	" 70,000 "
South Bend, Ind	" 70,000 "
Anderson, "	" 20,000 "
Plainfield, "	" 10,000 "
Springfield, Illinois	" 100,000 "
Evanston, "	" 50,000 "
Freeport, "	" 35,000 "
Elgin, "	" 60,000 "
Sheboygan Wis	" 20,000 "
Key West Fla	" 10,000 "

Plans and estimates furnished for the erection of new and the rebuilding of old works. Address

Kerr Murray Mfg. Co.,

FORT WAYNE, IND.

CONTINENTAL WORKS.

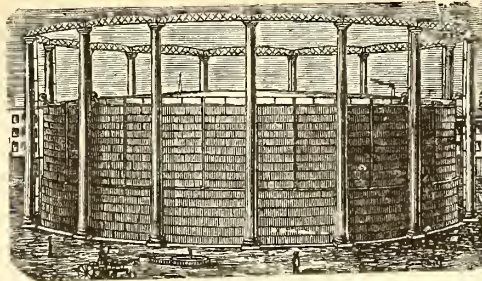

GASHOLDERS OF ANY MAGNITUDE.

T. F. ROWLAND, Proprietor,

GREENPOINT, BROOKLYN, N. Y.

ENGINEER AND MANUFACTURER OF

GAS-HOLDERS.

CONDENSERS, SCRUBBERS, VALVES,

PURIFIERS, RETORTS, and HY-

DR AULIC MAINS,

and all other articles connected with the Manufacture
Distribution of Gas. Plans and Specifications prepared
and Proposals given for the necessary Plant for Lighting
Cities, Towns, Mansions, and Manufactories.

H. RANSHAW, Prest. & Mangr. WM. STACEY, Vice-Pres. T. U. BIRCH, Asst. Mangr. R. J. TARVIN, Sec. & Treas.

STACEY MFG. CO.,

MANUFACTURERS OF

Single and Telescopic Gasholders,

IRON ROOFS, BRIDGES, LAMP POSTS,

Water and Oil Tanks, Coal Elevator Cars,

COKE CRUSHERS, BENCH CASTINGS,

And all kinds of Wrought and Cast Iron Work used in the erection of Coal and Oil Gas Works.
Rolling Mill Machinery and Heavy Castings a Specialty.

Foundry:

33, 35, 37 & 39 Mill Street.

Wrought Iron Works:

16, 18, 20, 22, 24 & 26 Ramsey Street.

Cincinnati, Ohio.

BARTLETT, HAYWARD & CO.,

Office, 24 Light.

BALTIMORE, MD.

Works, Pratt & Co.

PURIFIERS.
Roofs.
Bench Castings.

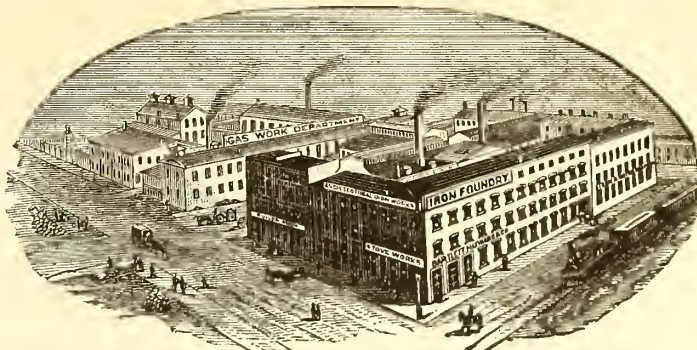

CONDENSERS.
BOILERS.
SCRUBBERS.

GASHOLDERS.

CONSTRUCTING ENGINEERS AND BUILDERS OF GAS WORKS.

1842. DEILY & FOWLER, 1884.

Laurel Iron Works.

Address, No. 39 Laurel Street, Philadelphia, Pa.

MANUFACTURERS OF

GASHOLDERS,

Single or Telescopic, with Cast or Wrought Iron Guide Frames.

Holders Built Since 1880:

Mount Joy, Pa.	West Point, N. Y.	Galveston, Texas (2d.)	Kalamazoo, Mich. (3d.)	Newport, R. I.
Rockaway B'ch, N.Y. (2)	Fitchburgh, Mass.	Marlboro, Mass.	Glen Island, N. Y.	Portland, Oregon.
Zanesville, O. (2d.)	New London, Conn.	Denver, Col.	Warren, Ohio.	Allegheny, Pa. (2d.)
Lancaster, O.	Derby, Conn.	Chicago, Ill. (West Side).	Bath, N. Y.	Atlanta, Ga. (2d.)
Blackwell's Island N. Y.	Bridgeport, Conn.	Pittsburgh, Pa. (S. Side).	Lynn, Mass.	N.Y. City (Central Gas Co)
Waltham, Mass. (1st.)	Allegheny, Pa. (1st.)	Pawtucket, R. I.	New Bedford, Mass.	Lynchburg, Va. (2d.)
Dorchester, Mass.	St. Hyacinth, Can.	Brookline, Mass.	Waterbury, Conn.	Rondout, N. Y.
Wheeling, West Va.	Norwalk, O.	Sherbrooke, Can.	Deseronto, Can.	Saylesville, R. I.
Lansing, Mich.	Brattleboro, Vt.	Burlington, N. J. (2d.)	Hoosle Falls, N. Y. (2d.)	Atlanta City, N. J.
Flint, Mich.	Waltham, Mass (2d.)	Bridgeton, N. J.	Bethlehem, Pa.	Augusta, Ga.
Galveston, Texas (1st.)	West Chester, Pa.	Bay City, Mich.	Atlanta, Ga. (1st.)	Waltham, Mass. (2d.)
Milton, Pa.	Baltimore, Md.	Erie, Pa.	Savannah, Ga.	
Scranton, Pa.	Holidaysburg, Pa.	Jackson, Mich.	Montgomery, Ala.	

GAS COALS.

GAS COALS.

GAS COALS.

JAMES D. PERKINS.

PERKINS & CO.,

F. SEAVERN.

General Sales Agents for

The Youghioghenny River Coal Company's**OCEAN MINE YOUGHIOGHENY GAS COAL.**

The Coal from the Ocean Mine (recently operated by Messrs. W. L. Scott & Co., of Erie, Pa.,) is now used by all the leading Gas Companies in the United States from Maine to Texas, and is recognized as *the only reliable Youghioghenny Gas Coal.* (See Map on p. 87 of this Journal, Feb. 16, 1885.)

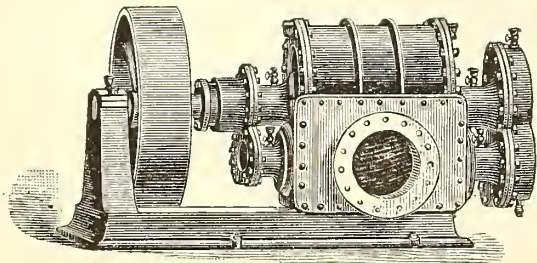
P. O. Box 3695,
New York.**PERKINS & CO., 228 and 229 N. Y. Produce Exchange****BEAVER STREET
ENTRANCE.**

Gas Exhauster Driven by Belt.

The Wilbraham Gas Exhauster,

"BAKER SYSTEM,"

WITH ENGINE ATTACHED, ON SAME BED PLATE OR WITHOUT.

Best, Cheapest and Most Durable Exhauster known.

WILBRAHAM BROS.,

No. 2320 Frankford Avenue, Philadelphia, Pa.

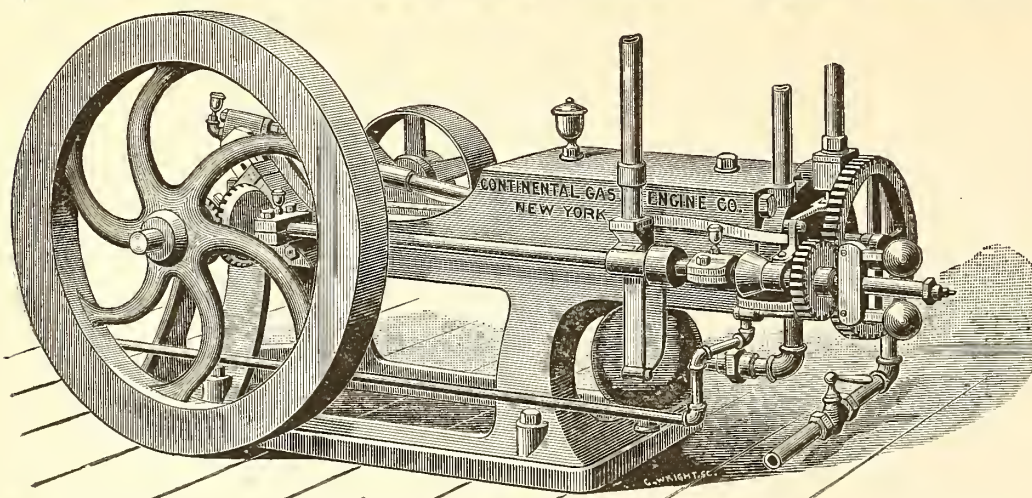
THE CONTINENTAL GAS ENGINE COMPANY.

MANUFACTURERS OF

GAS ENGINES,

UNDER THE

GAUME AND OTHER PATENTS,

HAVE READY

Engines of ½, 1 and 1½ H.P.

Arranged for power or for pumping, 1-horse power will pump 1,000 gals. water 100 ft. high with 75 ft. of gas; ½-horse power will pump 500 gals. 100 ft. high per hour with 25 ft. of gas.

Each Engine Tested by Indicator and Meter.

SIMPLE, ECONOMICAL, SAFE, AND SUBSTANTIAL.

Call and see engines in operation, or address for circulars and prices.

Office, No. 231 Broadway, N. Y. City.**CATHELL'S
Gas Consumer's Manual.**

Enables every gas consumer to ascertain at a glance, without any previous knowledge of the gas meter, the quantity and money value of the gas consumed. Also the best method of obtaining from gas the largest amount of its light. It will be to the advantage of Gas Companies to supply their consumers with one of these Guides, as a means of preventing complaint arising from their want of knowledge in regard to the registration of meters.

A. M. CALLENDER & CO., 42 Pine St., N. Y.

**AMERICAN
GAS LIGHT JOURNAL.**

\$3.00 per Annum.

A. M. CALLENDER & CO.,
42 Pine Street, N. Y. City.**King's Treatise on Coal Gas.**

The most complete work on Coal Gas ever published.

Three Vols. Bound, \$30.

A. M. CALLENDER & CO., 42 Pine St., N. Y.

**NEWBIGGING'S
Gas Manager's Handbook.**

Price, \$4.80.

EVERY GAS MAN SHOULD HAVE ONE.

Orders may be sent to this Office.

BOOKS.**DISTILLATION OF COAL TAR AND
AMMONIACAL LIQUOR.**

By GEORGE LUNGE. Price \$8.50.

**A TREATISE ON THE COMPARATIVE
COMMERCIAL VALUES OF GAS
COALS AND CANNELS.**

By DAVID A. GRAHAM. 8vo., Cloth. Price \$3.

Orders for these books may be sent to this office.

A. M. CALLENDER & CO.,

42 PINE ST., N. Y. CITY.

GAS COALS.

GAS COALS.

GAS COALS.

Newburgh Orrel Coal Co.,
MINERS AND SHIPPERS OF

**Newburgh Orrel, Tyrconnell
and Palatine Gas Coals.**

ALSO SHIPPERS OF FOUNDRY COKE.

Mines Situated at
Newburgh, Flemington & Fairmont, W.Va.

HOME OFFICE,
25 S. Gay St., Baltimore.

CHARLES MACKALL,
MANAGER.

CHAS. W. HAYS, Agent in New York,
Room 92, WASHINGTON BUILDING, No. 1 Broadway.
Shipping wharves at Locust Point. References furnished when
required. Special attention given to chartering vessels.

THE DESPARD COAL COMPANY

OFFER THEIR SUPERIOR

DESPARD COAL

To Gas Light Companies and Manufacturers of Fire Clay Goods
Throughout the Country.

ROUSSEL & HICKS, } AGENTS. { BANGS & HORTON,
71 Broadway, N. Y. } 15 Kilby St., Boston.

Mines in Harrison Co., West Va. Wharves, Locust Point, Balt.
Company's Office, 15 German St., Baltimore, Md.

Among the consumers of Despard Coal we name: Manhattan
Gas Light Co., N. Y.; Metropolitan Gas Light Co., N. Y.; Jersey
City, (N. J.) Gas Light Co.; Washington (D. C.) Gas Light Co.;
Portland (Maine) Gas Light Co. Reference to them is requested.

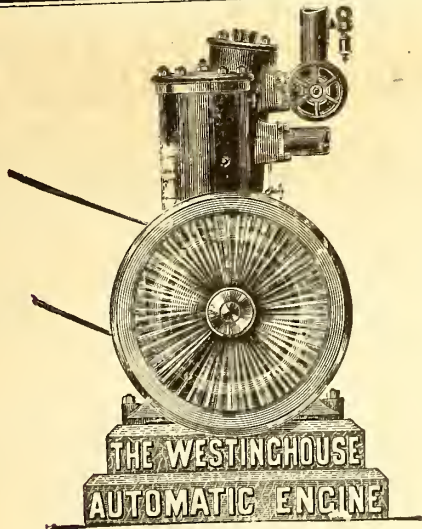

1,500 Engines Now in Use.

Our capacity being now equal to 100 Engines per
month, we shall hereafter keep in stock for immediate
shipment all sizes from 4 to 200 H.P.

SEND FOR ILLUSTRATED CIRCULAR AND REFERENCE LIST.

Westinghouse Machine Co.,
PITTSBURCH, PA.

SALES DEPARTMENT CONDUCTED BY

- Westinghouse, Church, Kerr & Co., 17 Cortlandt
Street, New York City.
- Fairbanks, Morse & Co., Chicago, Cincinnati, Cleve-
land, Louisville, and St. Paul.
- Fairbanks & Co., St. Louis, Indianapolis, and Denver.
- Parke & Lacy, San Francisco, and Portland, Or.
- Parke, Lacy & Co., Salt Lake City, Utah, and Butte,
Montana.
- D. A. Tompkins & Co., Charlotte, N. C.
- Kenting Implement & Machine Co., Dallas, Texas
- Inray & Co., Sydney and Melbourne, Australia.
- Robert Middleton, Mobile, Ala.
- H. Dudley Coleman, 9 Perdido St., New Orleans, La.
- R. Rogers, 43 Rue Laflitte, Paris.

**THE
PENN GAS COAL COMPANY**
OFFER THEIR
COAL, CAREFULLY SCREENED,
AND PREPARED FOR
GAS PURPOSES.

Their Property is located in the Youghiogheny Coal Basin, near Irwin's and Penn Station
in the Pennsylvania Railroad, and on the Youghiogheny River.

OFFICES

No. 209 South Third Street, Phil'a. 90 Wall Street, New York.

PLACES OF SHIPMENT.

Pennsylvania Railroad, Pier No. 2 (Lower Side).
Greenwich Wharves, Delaware River.

Pier No. 1 (Lower Side), South Amboy, N. J.

366-1y

Chesapeake & Ohio Railway Coal Agency,
FOR THE SALE OF THE

Superior Kanawha Gas Coals, Cannelton Cannel,
Also, **SPLINT AND STEAM COALS.**

From the Kanawha and New River Regions, on the line of the Chesapeake & Ohio R'way.

C. B. ORCUTT, Sales Agent. | OFFICE, 150 BROADWAY, N. Y.

FRANCIS H. JACKSON, PRESIDENT.

EDMUND H. MCCULLOUGH, SEC. & TREAS.

THE WESTMORELAND COAL CO.

Chartered 1854.

Mines situated on the Pennsylvania and the Baltimore
and Ohio Railroads, in Westmoreland County, Penn.

POINTS OF SHIPMENT:

PHILADELPHIA, BALTIMORE, SOUTH AMBOY, N. J.
WATKINS (SENECA LAKE), N. Y.

Since the commencement of operations by this Company its well-known
Coal has been largely used by the Gas Companies of New England and the
Middle States, and its character is established as having no superior in gas-
giving qualities, and in freedom from sulphur and other impurities.

Principal Office, 224 South 3d St., Phila., Pa.

The Bower Gas Lamp.

The Perfected Duplex-Regenerative Gas Burner, under
the combined Patents of Anthony S. Bower,
Geo. S. Grimston, and Thos. Thorp.

The First Gold Medal awarded at the Crystal Palace Exhibition in
London, and two Gold Medals at the Stockport (Eng.) Exhibition of Gas
Appliances. Both in 1883.

GEO. SHEPARD PAGE, JOHN BOWER,
69 Wall Street, N. Y. City.

The Management of Small Gas Works.

By C. J. R. HUMPHREYS. Price, \$1.
A. M. CALLENDER & CO., 42 Pine St., N. Y.



INTERNATIONAL--1876--EXHIBITION.

The U. S. Centennial Commission

HAVE DECREED AN AWARD TO

HARRIS, GRIFFIN & CO.,

12th and Brown Sts., Philadelphia, and 49 Dey St., N. Y., U. S. A.,

FOR THE FOLLOWING REASONS :

The Exhibit consists of a Series of METERS from the Largest Size Station Meters for the use of the MANUFACTURE OF GAS, to those for the use of the ORDINARY CONSUMER. The Instruments are WELL MADE, RELIABLE as to INDICATION, and embody a number of sundry improvements which, with the general character of the Exhibit, entitle the whole to commendation.

Attest—J. L. CAMPBELL,
Secretary, pro-tem.

Signed—A. T. GOSHORN,
Director General

J. B. HAWLEY,
President

CHARLES E. DICKEY.

JAMES B. SMALLWOOD.

CHARLES H. DICKEY.

Maryland Meter and Manufacturing Co.,
DICKEY, TANSLEY & CO.,
Established 1866.

Nos. 22 and 24 Saratoga Street, Baltimore, Md.
No. 46 La Salle St., Chicago, Ill.

MANUFACTURERS OF

DRY GAS METERS, STATION METERS, GLAZED METERS, TEST METERS, METER PROVERS, PRESSURE AND VACUUM REGISTERS, GOVERNORS, INDICATORS, SERVICE AND METER COCKS, AND METER CONNECTIONS.

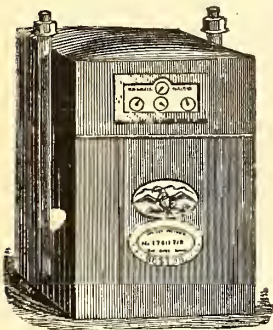

Dry Gas Meter.

With 39 years' experience and the best facilities for manufacturing, is enabled to furnish reliable work and answer orders promptly.

NATHANIEL TUFTS,

No. 153 Franklin Street, Boston, Mass.,

MANUFACTURER OF

DRY GAS METERS.

Station Meters of any Capacity.

Test and Experimental Meters, Pressure Registers, Pressure Gauges, Pressure and Vacuum Gauges.

METER PROVERS, PHOTOMETERS, STREET LANTERNS, ETC., ETC.

Patent Cluster Lanterns for Street Illumination.

SCIENTIFIC BOOKS.

We are prepared to furnish to Gas Managers, and others interested in the topics treated of, the following books, at prices named:

KING'S TREATISE ON THE MANUFACTURE OF COAL GAS. Three vols.; \$10 per vol.	GAS CONSUMER'S MANUAL, by E. S. CATHELS, C.E. 10 cts.	A PRACTICAL TREATISE ON GAS AND VENTILATION, with Special Relation to Illuminating, Heating, and Cooking by Gas, by E. E. PERKINS. \$1.25.
GAS MANUFACTURE, by WILLIAM RICHARDS. 4to., with numerous Engravings and Plates, in Cloth binding. \$12.	PRACTICAL TREATISE ON HEAT, by THOMAS BOX. Second edition. \$5.	PURIFICATION OF COAL GAS, by R. P. SPICE. 8vo. \$3.
THE GAS ANALYST'S MANUAL, by F. W. HARTLEY. \$2.50.	GAS WORKS - THEIR ARRANGEMENT, CONSTRUCTION, PLANT, AND MACHINERY. \$8.	HOW TO MANAGE GAS, by F. WILKINS. Paper. 20 cents.
ANALYSIS, TECHNICAL VALUATION, PURIFICATION, and USE OF COAL GAS, by REV. W. R. BOWDITCH, M.A.; with Engravings; 8vo., Cloth. \$4.50.	COAL; ITS HISTORY AND USE, by PROF. THORPE. \$3.50.	THE GAS MANAGER IN THE LABORATORY, by a Practical Student. 8vo., Cloth. \$1.50.
GAS MEASUREMENT AND GAS METER TESTING by F. W. HARTLEY. \$1.60	THE GAS WORKS OF LONDON, by COLBURN. 60 cents.	THE DOMESTIC USES OF COAL GAS, AS APPLIED TO LIGHTING, by W. SUGG. \$1.40.
GAS CONSUMER'S HANDBOOK, by WILLIAM RICHARDS, C.E.; 18mo., Sewed. 20 cents.	THE GAS FITTER'S GUIDE, Showing the Principles and Practice of Lighting with Coal Gas, by JOHN ELDRIDGE. 40 cents.	DISTILLATION OF COAL TAR AND AMMONIACAL LIQUOR, by GEO. LUNGE. \$8.50.
	GAS WORKS, AND MANUFACTURING COAL GAS, HUGHES. \$1.80.	A TREATISE ON THE COMPARATIVE COMMERCIAL VALUES OF GAS COALS AND CANNELS, by D. A. GRAHAM. 8vo., Cloth. \$3.
	THE MANAGEMENT OF SMALL GAS WORKS, by C. J. R. HUMPHREYS. \$1.	

The above will be forwarded by express, upon receipt of price. We take especial pains in securing and forwarding any other Works that may be desired, upon receipt of order. All remittances should be made by check, draft, or post office money order.

A. M. CALLENDER & CO., No. 42 Pine Street, New York.

T. C. HOPPER, Pres. G. J. McGOURKEY, Vice-Pres. (New York). WM. N. MILSTED, Gen. Supt. & Treas. (New York). WM. H. DOWN Sec.

AMERICAN METER COMPANY,

WET AND DRY GAS METERS. STATION METERS. EXHAUSTER GOVERNORS. DRY CENTRE VALVES. GOVERNORS FOR GAS WORKS. PRESSURE REGISTERS. PRESSURE & VACUUM REGISTERS. PRESSURE & VACUUM GAUGES. CRESSON GAS REGULATORS. MARSLAND WATER METERS. METER PROVERS. PORTABLE TEST METERS. EXPERIMENTAL METERS. AMMONIA TEST METERS. BAR AND JET PHOTOMETERS.

<p>Manufactories: 512 W. 22d St., N. Y. Arch & 22d Sts., Phila.</p>	<p>GAS STOVES, SUGG'S "STANDARD" ARGAND BURNERS, SUGG'S ILLUMINATING POWER METER, Wet Meters, with Lizar's "Invariable Measuring" Drum.</p>	<p>Agencies: 177 Elm Street, Cincinnati. 244 & 246 N. Wells Street, Chicago. 810 North Second Street, St. Louis. 122 & 124 Sutter St., San Francisco.</p>
--	--	--

HELME & McILHENNY,

(Successors to Harris & Brother. Established 1848)

GAS METER MANUFACTURERS,

CONTINUE AS HERETOFORE AT THE OLD ESTABLISHMENT,

Nos. 1115 and 1117 Cherry Street, Philadelphia, Pa.,

To Manufacture Wet and Dry Gas Meters, Station Meters, Experimental Meters, Meter Provers, Center Seals, Pressure Registers, GOVERNORS, INDICATORS, PHOTOMETERS, & ALL OTHER KINDS OF APPARATUS FOR USE IN GAS WORKS.

From our long practical experience of the business, and from our personal supervision of all work, we can guarantee all orders to be executed promptly, and in every respect satisfactorily.

WM. WALLACE GOODWIN, Prest. and Treas. WM. H. MERRICK, V.-Prest. S. L. JONES, Sec. S. V. MERRICK, Supt.

THE GOODWIN GAS STOVE AND METER COMPANY,

Successors to W. W. GOODWIN & CO.

1012, 1014 and 1016 Filbert St., Phila., Pa. 142 Chambers St., New York.
76 Dearborn St., Chicago, Ill.

WALDO BROS., Agents, 88 Water St., Boston.

MANUFACTURERS OF THE "SUN DIAL" GAS STOVES, FOR COOKING AND HEATING PURPOSES.

Dry and Wet GAS METERS, Station Meters (Square, Cylindrical or in Staves) Glazed Meters, King's and Sugg's Experimental Meters, Lamp Post Meters, Etc., Etc., Meter Provers (sizes 2, 5 and 10 feet), Pressure Guages of all kinds, Pressure Registers, Pressure and Vacuum Registers, Pressure Indicators (sizes 4 inch, 6 inch and 9 inch), King's Pressure and Vacuum Gauges, Dry and Wet Centre Seals, Dry and Wet Governors, Exhauster Governors, Photometers of all descriptions. Lethby's Sulphur and Ammonia Test Apparatus complete—also Testing and Chemical Apparatus of all kinds, and of the most perfect description, for all purposes relating to Gas.

GOODWIN'S IMPROVED LOWE'S JET PHOTOMETER.

Agents for Bray's Patent Gas Burners and Lanterns.

Special attention to repairs of Meters, and all apparatus connected with the business.
All work guaranteed first class in every particular, and orders filled promptly.

G. B. EDWARDS, Mang'r, New York.
E. H. B. TWINING, Mang'r, Chicago.
A. B. STANNARD, Agent.

D. McDONALD & CO.,

GAS METER MANUFACTURERS.

(Established 1854.)

No. 51 Lancaster Street, Albany, N. Y.

STATION METERS, EXPERIMENTAL METERS, METER PROVING, PRESSURE & VACUUM REGISTERS, PRESSURE GAUGES, ETC.

Also STAR GAS STOVES, RANGES, and HEATING STOVES.

We use only the very best materials, and employ the most skilled labor, and by our long experience (29 years) and personal supervision of every detail, we feel justified in assuring the public that our goods will give perfect satisfaction. Every Meter emanating from our establishment will bear the State Inspector's BADGE, and will be fully warranted by us. Our Annual and Calendar will be sent to Gas Companies upon application.

KING'S TREATISE ON COAL GAS.

The most complete work on Coal Gas ever published. Three vols., bound, \$30.

A. M. CALLENDER & CO., No. 42 Pine Street, New York.

THE "OTTO" GAS ENGINE.

Guaranteed to Consume 25 to 75
Per Cent. LESS GAS than **ANY** OTHER GAS ENGINE
PER BRAKE HORSE POWER.

TWIN ENGINES Impulse every revolution.
THE STEADIEST RUNNING GAS ENGINE YET MADE.

ENGINES AND PUMPS COMBINED,

For Hydraulic Elevators, Town Water Supply, or Railway Service.

Special Engines for Electric Light Work.

OVER 15,000
IN USE.

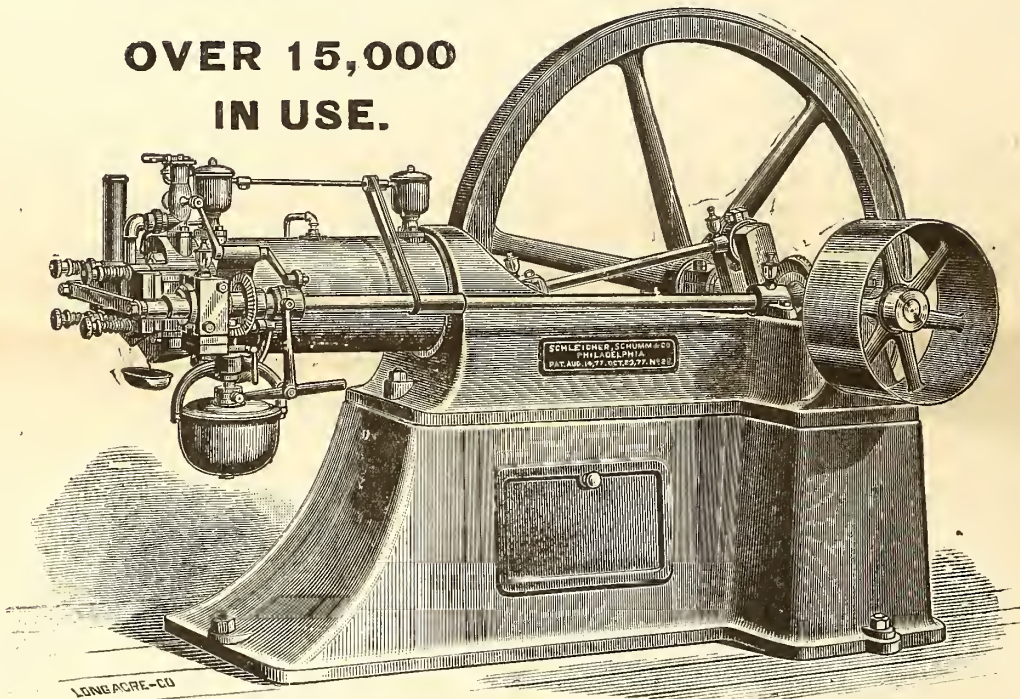

The Otto Gas Engine is now consuming, at a moderate computation, 2000 millions cubic feet of gas per year, nearly all of which is furnished during day time only.

**THE ONLY HIGHEST AWARD, ONLY GOLD MEDAL,
AT ELECTRICAL EXHIBITION, PARIS, 1881.**

MADE IN SIZES FROM 1 TO 25 HP. INDICATED.

FOR PARTICULARS, PRICES, ETC., APPLY TO

SCHLEICHER, SCHUMM & CO.,

Works:

N. E. Cor. 33d & Walnut Sts., Phila., Pa.

Branch Office:

214 Randolph Street, Chicago, Ill.

THE AMERICAN

GAS LIGHT JOURNAL

RODMAN KENNY, N. Y.

PUBLISHING OFFICE NO. 42 PINE STREET

DEVOTED TO THE INTERESTS OF ILLUMINATION, VENTILATION, WATER SUPPLY AND DISTRIBUTION, & GENERAL SCIENCE.

VOLUME XLII.—No. 9.
Whole No. 621.

NEW YORK, SATURDAY, MAY 2, 1885.

{ \$3 PER ANNUM
IN ADVANCE.

A. M. CALLENDER & CO., Proprietors. C. E. SANDERSON, Manager.
JOS. R. THOMAS, C.E., Editor.

ENTERED AT THE POST OFFICE AT NEW YORK, N. Y.,
AS SECOND CLASS MATTER.

Published on the 2d and 16th of each month, at No. 42 Pine Street, N. Y.

Terms of Subscription, Including Postage.—For the United States and Canada, \$3 per annum. European countries, \$3.50 (15 shillings—18 francs). All payments to be made in advance. Single copies, 15 cents.

Remittances should be made either by post-office order, registered letter, or bank draft on New York, payable to the order of A. M. Callender & Co.

Collections are invariably made directly from this office, for subscriptions, advertisements, etc. We have agents to solicit the same, but they are not authorized to receipt for money.

Correspondence.—Wishing to make this JOURNAL a gazette of intelligent discussion to those of our readers who may wish to gain or give information on the subjects to which its columns are devoted, correspondence is solicited for publication from all who make the study of those subjects a pleasure or a profession.

The American News Company, Nos. 39 and 41 Chambers street, New York, are agents for this JOURNAL. Newsdealers will send orders to them.

Books.—We will mail, post-paid, at publisher's lowest rates, any book—scientific or otherwise—to any address in the United States or Canada. No books will be sent C. O. D.

CONTENTS.

An Asterisk (*) denotes an illustrated article.

OFFICIAL CIRCULAR—

Annual Meeting Western Gas Association..... 225

EDITORIALS—

Obituary—Mr. George Cornell..... 226

The Siemens Burner Wins Again..... 226

How They do Business at Troy, N. Y..... 226

The Striking Miners Resume Work..... 226

Fifteenth Annual Meeting of the New England Association of Gas

Engineers—Official Report—Continued from page 203..... 227

Continuation of Question-Box Discussion—"Will carbon deposit form as fast, or be as difficult of removal, with a degree of heat necessary for three-hour charges as under a heat requiring five hours to carbonize the same weight, other things being equal?"—"Is it cheaper and better to use iron sponge, and allow the carbonic acid to remain in the gas, and make up the deficiency by using oil, or to use lime purification?"—"What is the effect of wet coal upon the illuminating power of the gas made from it?"

Papers Read before the First Annual Meeting of the Ohio Gas

Light Association, with Discussions on Same—Official Report—

Continued from page 207..... 231

Do We Gain Heat, or Save Fuel, by Passing Steam Through Our Grate Bars? by E. McMillin—Discussion—Does it Pay to Use any Lime in Connection with Oxide of Iron? by J. Fullagar—Discussion—How Much Coke is Lost as Screenings, after being Crushed; and What Advance Must be Added to Price of Crushed Coke to Make it Equally Profitable to Sell by Gas Companies? by J. Light—Discussion.

The Gas Question at St. Louis, Mo..... 235

Special English Correspondence..... 236

ITEMS OF INTEREST FROM VARIOUS LOCALITIES..... 237

A Chapter from Morristown (N. J.) Gas Records—Spontaneous Combustion Destroys a Pile of Gas Coal—An Acknowledgment—It must be a Joke—Hannibal (Mo.) Gas Light Company Reduces Selling Rates—Killed by the Electric Current—Toronto (Ont.) to Have Cheaper Gas—Trying to Fix Gas Prices at San Francisco, Cal.—Extending Mains at Long Branch, N. J.—Huntsville (Ala.) Gas Company at the Same Work—Its Epitaph Written—Trying to Induce the Poughkeepsie Common Council to Try Electric Street Lighting—Another Reduction in Gas Rates at North Adams, Mass.—Milwaukee (Wis.) Heard from—The Death Roll; Case No. 1—Case No. 2—Case No. 3—Case No. 4 is a Surprise—She Recovered—What Electric Street Lighting May Cost New York City.

The Market for Gas Securities..... 239

[OFFICIAL CIRCULAR.]

ANNUAL MEETING WESTERN GAS ASSOCIATION.

SECRETARY'S OFFICE WESTERN GAS ASSOCIATION,
QUINCY, ILLS., April 28, 1885.

This notification will be the last formal statement or appeal that can be made by your Secretary through the columns of the JOURNAL with respect to the Eighth Annual Meeting of the Western Gas Association, and therefore would I once more urge upon your attention the importance and value of united effort and concerted action, so that when the hour of final adjournment arrives we can all congratulate ourselves that the '85 session had been productive of even greater good to the fraternity than that which has resulted as a consequence of our former deliberations. With perfect sincerity I may put forward the claim that our Eighth Annual Meeting will be an entirely successful and harmonious gathering. Every present and presumptive evidence tends to prove the pleasant prediction advanced; but, keeping in view the fact that success admits of no restrictive limit, it is well to bear in mind that as the greater is our success the larger will be the margin afforded for future congratulation.

Let every member, then, make the journey to Chicago, Ills., primed with the consciousness that he is going to be a factor in the proceedings, and determined that he shall contribute his due share to the value thereof. The Committee of Arrangements have made every preparation for the personal comfort of those who shall visit the Tremont House on the 13th, 14th, and 15th days of May; and your Secretary would once more request that intending participants in the Eighth Annual sessions apply to Committee, in advance, for rooms, etc. As explained in previous notices, special rates have been made for the occasion by the Tremont House proprietors; the prices for guests ranging upward from the figure of \$2.50 per day. Size and locations of apartments determine the scale of cost. Prudent men, to say nothing of wary travelers, whenever possible, make provision for such things as creature comforts in advance. And since "a hint to the wise is sufficient," enough has been said on the score just discussed.

I know that I but give expression to the united voice of the members of our Western Gas Association when I say that one of the most thoroughly enjoyable features of the St. Louis meeting of 1884 was the presence of the Eastern brethren who honored us with their attendance. We want them again, and most heartily do we extend a cordial invitation to them to repeat the visit of a year ago. This invitation is meant to embrace the fraternity of all kindred gas associations; and those who will accept of our summons to hospitality will find the latchstring in its proper place.

I am enabled to present the following list of papers to be read at the coming meeting:

- The Steam Jet Exhauster and Naphthaline, by Mr. J. B. Howard.
- Stoppages in Small Works, by Mr. V. L. Elbert.
- Pressure of Gas in Street Mains, by G. A. Hyde, sr.
- Gas Bills versus Gas Light, by B. E. Chollar.
- The Proper Location of the Gas Meter, by J. G. Miller.
- The Utilization of Waste Heat from the Benches, by J. W. Dunbar.
- Cooper Coal Liming Process, by Geo. Shepard Page.

In addition to the above, essays on subjects, still untitled, have been promised by Prof. S. H. Douglass, Messrs. E. H. Jenkins, E. J. King, and E. Lindsley, while still others may be expected.

Now, gentlemen, it is only fair to assume that by your presence you will testify to an appreciation of the labors of the members who will so generously contribute to your fund of information by their presentation of especially prepared papers on the subjects set forth. Let there be a general closing up of the ranks, and there can be only one result.

Yours sincerely, A. W. LITTLETON, Secretary.

OBITUARY—MR. GEORGE CORNELL.

The hand of death has once more pressed heavily upon the Western brotherhood, and the gas fraternity is called upon, all too speedily after the striking down of Mr. Butterworth, to lament the decease of Dr. Geo. Cornell, late Secretary and Treasurer of the Youngstown (Ohio) Gas Light Company, whose demise occurred, on the evening of Wednesday, April 22d, at his former home on East Rayen avenue, Youngstown. The Doctor had been for years a sufferer from marasmus, owing its origin to malarial poison introduced into his system while pursuing the duties of a surgeon to the army encamped before Vicksburg, Miss., during the now famous and memorable siege of that city in the late war of the rebellion.

The deceased was born on the 22d day of October, 1832, in the village of Rensselaerville, Albany county, N. Y., and was the youngest son of Mr. Gideon Cornell. He received a rudimentary education at the village academy, prosecuted his first studies in medicine at the office of the local physician, and afterwards at Cairo, N. Y., paying his way by teaching school through the winter season. He attended a series of lectures at the Castleton (Vt.) Medical College, finally graduating as a physician, from the medical department of the University of New York, in 1854. Four years thereafter Mr. Cornell visited Youngstown, and determined upon making that place his future home. Shortly after the breaking out of the war of the rebellion he went out with a company from the Western Reserve College. The company was ordered to go down the Ohio river as far as Vicksburg in charge of prisoners who were to be "exchanged;" and this duty accomplished, Mr. Cornell employed his medical skill and talent in alleviating the sufferings of disabled soldiers. It was at this period of service that he contracted a low malarial fever, the seeds of which finally undermined and destroyed what was naturally a robust health. Leaving Vicksburg, Mr. Cornell was appointed a surgeon in the United States volunteer service, later on being made contract surgeon at Camp Chase, Columbus, Ohio. When peace was restored he returned to Youngstown and devoted himself to the ordinary practice of his profession. In 1867 he was elected Secretary and Treasurer of the Youngstown Gas Company, which corporation had been organized by Mr. A. B. Cornell (brother of deceased) in 1866. In 1872 he married Miss Mary Bushnell. As issue of this marriage there were three sons and one daughter. Wife and children survive him.

The Youngstown Gas Light Company became a member of the Gas Light Association of the United States (now the American Association) at the first annual meeting held in New York city, Oct. 15th and 16th, 1873; and Mr. Cornell, who, like unto Mr. Butterworth, fully believed in the value of the annual meetings, was a member of that body in fact as well as in name. His last appearance at the sessions was made at New York city meeting of 1883. The Youngstown Company is also represented on the rolls of the Western Gas Association through the membership of Supt. Coombs, an evidence that Mr. Cornell thought that "what was good for the master was good for the man." Mr. Cornell was the real executive head of the Youngstown Company; and his thoroughly business-like policy, fairness and integrity obliged the citizens of his city to concede that even a gas man might be honest. His exemplary life gained for him the respect of his associates; and his kind, indulgent, winning nature ensured to him the confidence and affection of his family and friends. We are truly sorry to announce his demise; but we are pleased to record our testimony to his many shining qualities, so that the brightness of his memory may not be dimmed by the shadows of forgetfulness.

The funeral services were held in the First Presbyterian Church, Youngstown, at 10:30 o'clock, morning of Saturday, April 25th.

THE SIEMENS BURNER WINS AGAIN.

In these desert days of electric lighting schemes and schemers, when the ratepaying factors of our communities appear to be utterly lost sight of, or rather when not the slightest consideration is paid by the municipal authorities to the manner in which they are so recklessly plundering the people whose tax contributions are being constantly enlarged, by abnormal expenditure of public funds for the maintenance or prosecution of criminally extravagant experiments in public lighting, it becomes rather refreshing to behold an occasional oasis appearing on the arid sands of official prodigality. Before going on with the development of the oasis, it might be quite pertinent in connection with the above lines to mention a case in illustration of just how the New York taxpayers are suffering at the hands of the redoubt-

able worthies known in the Metropolis as the Gas Commission. On South street, taking the straight stretch of roadway commencing a trifle to the north of South Ferry and running thence northerly to the Fulton Ferry—in all a distance of certainly not over 1,000 yards, and in all likelihood much less—may be counted no less than 12 arc lights, each costing the city at the rate of \$255.50, or a round sum of \$3,066 for the twelvemonth. Now we do not pretend to claim that the spectacle afforded is not a brilliant one, but, on the contrary, freely admit it to be quite dazzling and picturesque. On one side of the roadway is the usual stretch of New York city store and office structures; on the other may be noted vessels of all shapes and sizes lying moored at their wharves. The positions of the arcs alternate—you encounter this one on the land side, the alternate lamp being located on the wharf. Undoubtedly the effect is both brilliant and spectacular; but what is its cost as compared with the lighting service really needed? To place 60 ordinary gas lamp posts at 16½ yards apart along that 1,000 yards of South street surface would cost, at the rate of \$17.50 each, the annual sum of \$1,050. The streetway, wharves, and bulkheads would be supplied with every requisite illumination need, and the taxpayers would be the gainers in the sum of just \$2,016. About as had a state of affairs prevails in other quarters of the city now exposed to the spluttering moons which, when not suffering from either partial or total eclipse, shed their ghostly pallor at the uniform rate of over one-quarter thousand dollars each per annum.

But to return to the Siemens Company. The success that attended the lighting of the Pension Building, Washington, D. C., on the occasion of the Cleveland inauguration ball was such that the supervising architect (the building is not yet completed) determined that the structure should not be permanently lighted by electricity, as was originally intended; but that high power Siemens Regenerative lamps be substituted therefor. The specifications for the gas fitting arrangements have been sent out to the bidders for plumbing work, and in these articles it is especially stipulated that the outlets are to be arranged so as to provide for the proper working of the Siemens burner lamps. An inspection of the plans develops the fact that it will take pretty nearly 300 burners to supply the requirements of the building. This really marks a new era in public lighting in this country, even although Boston, Mass., and Philadelphia, Pa., have already tried the experiment, to some extent, on the public thoroughfares. But the Washington case was only won, and the endorsement of the Supervising Architect secured, after practical test made in the building itself, and under most trying conditions—*i. e.*, at the Inauguration Ball of last March. That the Siemens Regenerative Gas Lamp Company is a busy firm we might note that the managers have been obliged to remove their offices from the factory, at 21st street and Washington avenue, to No. 721 Chestnut street, Philadelphia, Pa., the workshops remaining as before.

HOW THEY DO BUSINESS AT TROY, N. Y.

In the last issue of the JOURNAL it was stated that the Troy (N. Y.) Council was inclined to light either a part or the whole of the streets with electricity. Bids were asked for 100 (more or less) arc lights, and the "Contracting Board" were somewhat astonished to find that proposals were also submitted by the Troy and Citizens Gas Light Companies. The figures handed in developed the following state of affairs:

Troy Electric Light Company,	45 cents per light per night.
Troy Gas Light Company,	39 " " "
Citizens " " "	36 " " "

The Common Council threw out the lowest bid on the ground that the Citizens Gas Company was in default as to its franchise, because it had failed to "lay two pipes in each of the streets of the city." The Council then awarded the contract to the Troy Electric Company, at the price proposed by the Citizens Gas Company, and ordered the "Contracting Board" to draw up the agreement, the work of lighting to be commenced within ten days after the contract was signed. This plain statement carries its own interpretation; and we defy even the murkiest of other Council records to equal the Troy proceedings for plain, unvarnished rascality. We trust the Troy Electric Lighting Company will be called upon to furnish "more" than "less" in regard to the 100 lamps.

The Striking Miners Resume Work.

The striking coal miners in the Pennsylvania gas coal district, or in any event those engaged in the shafts of the Ocean Mine, are no longer to remain in their self-assumed position of "walking gentlemen." Mr. J. F. Hosack, Superintendent of Ocean Mine collieries, telegraphed the New York agents, morning of April 30th: "Miners go to work to-day." Work was resumed on the basis of 2½ cents per bushel—or agreeably to the terms proposed by Mr. Scott during last February. Later despatches convey the news that the Penn and Westmoreland miners have also agreed to the Companies' terms.

[OFFICIAL REPORT—CONTINUED FROM PAGE 203.]

Fifteenth Annual Meeting of the New England Association of Gas Engineers.

HELD AT YOUNG'S HOTEL, BOSTON, MASS., FEB. 18 AND 19, 1885.

SECOND DAY—MORNING SESSION—FEB. 19.

CONTINUATION OF QUESTION-BOX DISCUSSION.

The President announced that the sixth question was,

"Will carbon deposit form as fast, or be as difficult of removal, with a degree of heat necessary for three-hour charges as under a heat requiring five hours to carbonize the same weight, other things being equal?"

The President—I do not know that many of the gentlemen present have run on three-hour charges. I think that Mr. Slater can give us some information in reply to the question.

Mr. Slater—I cannot claim we have discovered any special difference in that respect. If there is a difference it is too slight to be noticeable.

The President—Of course the heat at which your retorts are operated is higher than it would be if you were working with four or five hour charges?

Mr. Slater—I think, were we running four or five-hour charges, the retorts would, at times, be hotter than if three-hour charges were being followed—*i. e.*, the variation would be greater. We maintain a more uniform heat in running three-hour charges with the Dieterich furnaces than we would in running four or five-hour charges with the old furnaces.

The President—According to my recollection, we made carbon pretty fast. Will Mr. Lamson give the result of our experiments with the Dieterich furnace?

Mr. Lamson—The deposit of carbon was very large; but the prime trouble was with the pitch. My own belief is that the deposit depends less on the high heats, and more on the pressures maintained in the retorts, and the space allowed (over the coal) for the gas to pass off. We all know that more carbon will form under high heats than would form under excessively low heats; but I believe, as said before, and speaking generally, that the deposit is owing chiefly to pressure conditions in retorts.

The President—We would like to hear from any gentleman who has tried three-hour charges; or from any one who has run five-hour charges.

Mr. Harbison—Mr. Slater says that he uses three-hour charges in operating the Dieterich furnace. Is that the usual custom with those who are using the Dieterich or the Stedman furnaces?

The President—Mr. Nettleton is using the Dieterich furnace; what does he say?

Mr. Nettleton—We run four-hour charges.

The President—You did use three-hour charges, did you not?

Mr. Nettleton—We did; but only for a very few days.

Mr. Slater—What is Col. Stedman's practice?

Mr. Stedman—We employ four-hour charges.

The President—So far as our own experience at Boston goes, I may say that we abandoned the use of three-hour charges, and have never run anything less than four-hour charges since. We ran three hours when we were first operating the Dieterich furnace, and were working then at a very high heat. Afterwards, even at a low heat, we found that we were much more liable to have stoppages from pitch in our standpipes with three-hour charges than we were when working off a greater quantity of coal in four-hour charges. This may have come from some local difficulty, possibly; but it was the fact that, even with comparatively low heats, we stopped our standpipes with pitch on three-hour charges, when the retorts which were right alongside of them, with four-hour charges, did not become stopped. We experienced no difficulty afterwards in running much higher heats and charging every four hours. As far as the deposit of carbon goes, I do not think it made much difference. With the furnaces which we have in operation to-day we have never run less than four-hour charges. Although Mr. Slater's experiments show what can be done under certain circumstances, I think that most people are opposed to the practice. I know that Mr. Forstall, of Chicago, Ills., has abandoned it, and so has Mr. McIlhenny, of Washington, D. C., although both of these gentlemen were assiduous in their efforts to make the thing a practical success. They found that it cost more to keep their standpipes and mains clean than was saved in labor.

Mr. Harbison—Will the distance of the standpipe from the face of the bench, or of the hydraulic main from the top of the brickwork, have anything to do with the deposit of carbon?

Mr. Stiness—Not a bit.

The President—Yet I have no doubt this nearness has much to do with pitch. I think that the closer the hydraulic main is to the bench the more trouble you will have from the accumulation of pitch in its bottom section. I

am inclined to think flat mains are not very beneficial; and that it is a very good plan to have considerable quantity of water and less tar in bottom of hydraulic. That, at least, was the result of our experiments; and they led us to abandon the flat main which we had at one time put in.

Mr. Slater—I think that Mr. Sherman might give us the benefit of his experience with regard to position of the main.

Mr. Sherman—I will say, with respect to this matter, that all we did was to raise the main 20 inches over top of arch. We have had no trouble with pitch since; but before so doing, or when the main was only six inches from top of arch, we were very much annoyed with pitchy accumulation.

Mr. Harbison—What is the thickness of the brickwork on top of the arch?

Mr. Sherman—Twenty inches.

The President—And the hydraulic main was located three inches above that?

Mr. Sherman—No; we raised it 20 inches from top of bench.

The President—What was it before?

Mr. Sherman—Only two courses of bricks over firebrick arch.

The President—Is it not hot under your main now?

Mr. Sherman—No; and we do not have any more of the pitch that we had before the main was raised.

Mr. Harbison—You have 20 inches of air space between your brickwork and the top of the main?

Mr. Sherman—No; the air space is about six inches. There is 20 inches of brickwork which covers the whole stack.

Mr. Stiness—I think Mr. Greenough expresses my belief exactly when he says it is much better to have water than tar in the hydraulic main. I am now having built, and shall erect during the coming season, two sections of an inclined hydraulic main, from which, as I claim, all of the tar will be taken directly out, leaving nothing but water for the gas to encounter upon its entrance from the dip pipe. In the common flat main, with all the tar remaining therein, as it must, it so thickens and hardens as to make it almost impossible to pass the gas from the stand and dip pipes into the hydraulic. Under such a state of affairs the pressure thus caused upon the retorts produces the carbon which Mr. Lamson speaks about. I really believe this step of taking the tar away is a progressive move. Whether we have arrived at the full solution of the problem I am not ready to say; but I think that it is a movement in the nature of progress, and that it promises good success. I believe that in a year from to-day I shall be able to demonstrate to the members of the New England Association that my hydraulic main will be found to contain but a trifling tarry deposit, its other content being ammoniacal liquor. I believe that an inclined main can be made automatic in its action; or so that (as against the usual state of affairs now) its contents need not be drawn off once in 24 hours.

Mr. Lamson—I would like to ask Mr. Stiness what is the difference in level at the bottom.

Mr. Stiness—Four inches in a section of nine feet.

Mr. Lamson—In one bench?

Mr. Stiness—Yes; they are nine feet sections, four inches in each section; three sections in a stack, and inclined both ways. The stack of six benches will incline both ways to each end of the bench—standing the highest in the center.

Mr. Lamson—Then the stack is made of only two benches?

Mr. Stiness—No; I say it is a stack of six benches; and one portion (or of three benches) will incline in one way, and the other three benches will incline in the other direction. The difference in level will be fourteen inches.

Mr. Lamson—Then there will be fourteen more inches of liquid at one end than there is at the other?

Mr. Stiness—Yes.

Mr. Lamson—What depth of liquid is there at the shallow end?

Mr. Stiness—Seven inches of water at the shallow end—six inches of water and one inch seal. The level in the hydraulic main is the same. There is the same distance from the top of dip pipe to bottom of the hydraulic main seal that there is in any ordinary main. It is the bottom of the main which is made to incline. Each section inclines four inches, and two inches on the bonnet of the main.

The President—I suppose Mr. Sherman has very little deposit of carbon now, as a consequence of using valves instead of dip-seals?

Mr. Sherman—Nevertheless, I have more than I want.

The President—I was under the impression that those gentlemen who used valves on their dips did not have any carbon to speak of. I would like to ask those who have been using valves whether they have any carbon deposited.

Mr. Neal—I speak for the Charlestown Company; and we get a deposit of carbon in our retorts.

The President—How often is it necessary, and how long does it take, to burn out the retorts?

Mr. Neal—We use steam, which takes it out quite rapidly. We often allow our retorts to go five or six months without burning them out. Sometimes, though, we burn them out three times in the course of a year.

Mr. Sherman—I have to burn out every month. Mr. Edge, from whom I purchased the right to use his patented plan for removing carbon, said that he removed it every thirty days.

The President—How much oftener do you suppose you would have to burn the retorts out if you did not use valves?

Mr. Sherman—I would not have to burn them out any oftener, but I would have a much larger deposit to remove; or, instead of being able to burn out in eight hours, it would take thirty-six hours to do the work. The valve is not a specific remedy for the prevention of carbon deposit; but its advantage is that the formation is materially retarded.

Mr. Stedman—How long does it take you, Mr. Neal, to “burn off,” when you “burn off” at such infrequent intervals?

Mr. Neal—It takes less than five hours, performing the operation once in three months.

Mr. Sherman—At New Haven we burn out once a month; and it takes us twelve hours to do it.

Mr. Lamson—This brings up some old questions that we discussed years ago. I always took the ground that valves were of very little benefit, except to remove the pressure. Mr. Sherman says the only value he sees in the valve is that it prevents the accumulation of carbon. We burn out about once in six weeks. The operation takes anywhere from six to twelve hours; and we have no valves. I do not see but that we can do it better without valves than we could with them. The only question is as to how much pressure we shall put on. If you had your retorts set in short sections, so that your main could be kept at a level, and so that you did not feel any risk in running with a very light seal, your accumulation of carbon would be small, no matter whether you used valves or not.

Mr. Sherman—I find a very great difference of opinion among superintendents with regard to the necessity of keeping the retorts free from carbon. Some allow their retorts to fill up for a goodly portion of their entire length. I have seen pieces of carbon taken out of retorts that certainly must have reduced their capacity two-thirds. I do not make gas in that way. It takes just as much fuel and labor to run a retort when two-thirds filled as it does when it is kept clean. I intend to keep our retorts free. Of course I could let them run for three months, or for six months; but it is not policy to do so.

Mr. Nettleton—I am glad that Mr. Lamson made the statement that he did in regard to the time required to burn out retorts. I have heard friends of mine say that it took from 12 to 24 hours to burn out a retort with steam, and I never could understand it. My retorts are burned out once in two or three months, and the operation occupies from five to eight hours. It never takes longer than that. The quantity of carbon is not large, and valves are not used. I believe that Mr. Yorke, of Portland, has had a large experience with valves; and I understand that he makes no carbon whatever.

Mr. Yorke—I have been able to hear but a little of the debate, but I understand that the question before the Association is as to the cause of deposit in retorts.

The President—The question before the Association now is, “How much carbon you have in your works at Portland?” We understand that you use valves, and that you have very little carbon deposited; is that so?

Mr. Yorke—Yes. I use an arrangement quite similar in principle to the valve. I cannot state the proportion of carbon; but it is very small. I am satisfied that the causes of the deposit of carbon are high heats and pressure. I have no deposit of carbon, no matter how high the heats may be. The quantity of carbon deposited is, I should think, partly owing to the material carbonized. If it be very rich in carbon, with the same heat and the same pressure, the greater will be the deposit of fixed carbon. If it be very poor coal, the deposit will be less. We use paraffine oil as an enricher for our gas. As a usual thing the pressure on our retorts will be a trifle less than one-tenth of an inch. In the retorts that we use the oil in, the deposit of carbon is much greater than where the oil is not used. A year or two ago I ran for several months with no pressure on my retorts. They were perfectly sound, so that I could risk running them in that way. The result was that I had not the slightest deposit at the back end of retorts. This satisfied me, beyond a doubt, that the cause of deposit was pressure. A short time since I was surprised to read about a discussion on this matter, taking place, I think, before the American Association, in which a certain gentleman gave it as his opinion that pressure in the retorts had very little to do with the quantity of gas obtained per pound of coal. I had always thought very highly of that gentleman's opinion, but that assertion changed my views regarding him. The greater the proportion of carbon deposited, of course the poorer the gas will be. The quality of the gas is deteriorated by just the amount of carbon thrown down in the retorts. There can be no doubt about it.

Mr. Harbison—How often does Mr. Yorke have to burn the carbon out of his retorts? How long does it take him to do it? And how does he do it?

Mr. Yorke—We have about one-tenth pressure on the retorts; and we have had to burn them out once in three or four months.

The President—How long does it take you to do it?

Mr. Yorke—We generally consume from 36 to 48 hours; and we do it by the old process—that of putting in air pipes. I should say the average time was 36 hours.

The President—The next question is,

“Is it cheaper and better to use iron sponge, and allow the carbonic acid to remain in the gas, and make up the deficiency by using oil, or to use lime purification?”

I have no doubt the Association has a pretty strong opinion, either one side or the other, on this question. I hope the members will be prompt to express that opinion. Let us first hear from some of the gentlemen who use iron sponge. I believe Mr. Prichard has said that he employs the sponge.

Mr. Prichard—We use the iron sponge entirely; and perhaps we lead the Association in the amount of carbonic acid contained in our gas. It is a question to my mind whether it is cheaper to let that carbonic acid remain and afterwards enrich the gas, or to use lime and remove the impurity. We are able to produce a very high candle power. From report of the State Inspector for last six months, we ran considerably over 18-candle power; and yet we have two per cent. of carbonic acid. When we can buy naphtha very cheaply, and lime for purification costs us three times the price of iron sponge, it really becomes a serious question as to which is the cheaper. Some figures made by me some time ago showed the cost of purification with iron sponge (figuring all the labor, and one-fourth of the cost of the material for six months' use,) to be eight-tenths of a cent per thousand feet. It would cost me, I think, one cent more to take out the carbonic acid. Now I can run the candle power up to a value that will offset all the carbonic acid deterioration, and at a less cost for the enricher than would be the case did I extract the ingredient with lime purification.

The President—You have two per cent. of carbonic acid at the outlet?

Mr. Prichard—Very nearly; it is 1.78, I believe.

Mr. Neal—I use iron sponge; and do so since I find the practice profitable. Even if I thought the candle power was very much diminished by the use of iron sponge, and found it necessary to add a larger quantity of naphtha for enriching, I should still employ the sponge. I think that the State Inspector, in his report on the testing of our gas, places the contained carbonic acid at about 1.3 per cent. I do not think the presence of carbonic acid diminishes the candle power of gas to as great an extent as is generally supposed. Theoretically the diminution is considerable; but practically the deterioration is slight. Our candle power, as brought up by the use of naphtha in the manner previously described by me, has been very much improved during the past six months. The cost of iron sponge is comparatively small, because it is good for at least two years of duty; and in its use there is no extra expense for labor. When our purifiers are changed the men from the retort house are quite able to perform the task.

Mr. Sherman—I would like to ask Mr. Prichard what he considers to be the depreciation in candle power resulting from the two per cent. of carbonic acid contained in his finished gas?

Mr. Prichard—The assertion made by our State Inspector (whom we all recognize as high authority in such matters) is that two per cent. of carbonic acid will reduce the illuminating value of an eighteen candle gas by one candle. In passing the gas through a lime purifier all the increase I could obtain by that purification was one-half a candle. From that it would seem as though there were a discrepancy of one-half a candle between the practical result of my experiment and the theoretical statement of State Inspector Hinman.

The President—Was the gas clean when it came out of the lime purifier?

Mr. Prichard—It was as clean as any one could make it by passing it through lime.

Mr. Sherman—It was the theory of Mr. Hinman's predecessor that the percentage of carbonic acid contained was an index to the percentage of loss in candle power—that is, two per cent. of carbonic acid would indicate a loss of two candle power.

Mr. Prichard—Mr. Hinman says, in his report of last year, that two per cent. produces a reduction of one candle.

Mr. Learned—I think that depends upon whether you do or do not test the gas with an argand burner. The other day I made some calculations on this subject. Assuming that you have an eighteen candle gas, and that its power was reduced by half a candle through the fact of the presence of carbonic acid, then the question is, “What will be the cost of the oil needed to increase the value of a thousand feet of gas from seventeen and a half to eighteen candles?” I calculated that it would take (assuming that a gallon of oil would make sixty feet of sixty candle gas) twelve-sixtieths, or one-fifth of a gallon to do the work. With naphtha at five cents, the cost would be

one cent. Mr. Prichard says that his iron purification (including labor and material) costs him about eight-tenths of a cent. Now, that would be equivalent to one and eight-tenths of a cent (assuming that he used oil) with iron purification. There was a time when we used lime for purification altogether. We now employ half sponge and half lime. Exclusive purification with lime cost us in the neighborhood of three cents for both labor and material. It seems to me, under Mr. Prichard's conditions, it is cheaper for him to use iron sponge, and then make up the deficiency by the use of oil.

The President—I think that Mr. Sherman, when he was at Worcester, had some experience with iron purification.

Mr. Sherman—I have had no experience with the iron sponge. I used the Cartwright preparation when at Worcester; and I there found if we attempted to remove the carbonic acid it took as much lime to remove that as it did the sulphur in combination with it. In other words, if you wanted to remove the carbonic acid there was no object in using the Cartwright preparation. You have got to use as much lime to remove the carbonic acid as you would have to use to remove the sulphur.

The President—What effect did that have on the candle power?

Mr. Sherman—The State Inspector (Mr. Stimpson) claimed that it reduced our candle power by 2 candles. I made it about 1½ candles.

The President—If it takes out 1½ candles, then the question is, "How much does it take to put that 1½ candles back again, as compared to the cost of purification?"

Mr. Sherman—If the gentleman was restricted to an 18-candle gas, I think it would make very little difference to him. If that is to be the standard, I fail to see any material loss in using iron sponge.

Mr. Learned—I do not think there is as much carbonic acid in the gas as the gentleman speaks of. According to the State Inspector's report our gas at Newton, as shown in one analysis, had 1.24; had 1.8 on another occasion; and contained 1.7 in still another. In some other analyses, made for the detection of carbonic acid, I believe the highest I have ever seen was not over 2 per cent.

The President—For the Boston gas the analysis showed 1.08.

Mr. Sherman—I remember that a very eminent engineer figured it in such a way to me as would cast out the iron sponge at once. He stated (and almost convinced me) that he had reduced the price of gas to consumers 50 cents by raising the candle power from 14 to 16. He did it in this way: He was selling gas at \$3.50, which he said was 25 cents for each candle power; and, raising the power 2 candles, he claimed that he had reduced the price to consumers by 50 cents. (Laughter.)

The President—Some of the gentlemen who have been building new gas works must have been giving this subject considerable attention. We would like to know what Mr. Wood, of Syracuse, N. Y., thinks about iron sponge.

Mr. Wood—I have had no experience with iron sponge. We are in a section favored with an abundance of the best sort of stone lime. We succeed very well with that. We get it delivered at our works, just as it comes from the kilns, at 10 cents per bushel; and each bushel of it that we purchase will slack out to about 2½ bushels of hydrate of lime. We purify from 18,000 to 20,000 feet per bushel of lime. Last year our lime purification cost us, including labor, 1.2 cents per thousand feet.

The President—Mr. Stiness, did you consider the question of the use of iron sponge in your purifiers?

Mr. Stiness—Yes; we did. While I had many friends who were using it, still I failed to get from them a satisfactory answer to some questions which I put to them. I have always been rather positive in my opinions on this question, and my past and present practice is in accordance with that pursued by Mr. Wood. For the year 1884 the lime purification, independent of the labor of changing the purifiers, cost 1½ cents per thousand cubic feet of gas made. I have always felt that when it did not cost over 2 cents per thousand feet to purify the gas I could better devote the few remaining years of my life to the benefit of my company in directions where we could save more than 2 cents per thousand; and I believe the right place to make that investigation is in the retort house. I never yet found an engineer who could give thoroughly satisfactory answers to my questions with regard to the use of iron sponge. I employed it years ago and abandoned it. I now adhere to the old custom—that of using shavings and lime.

The President—Does the iron sponge possess any value after ceasing to be useful for purification?

Mr. Neal—I have used it, but when spent I have never found any value in it except perhaps to fill in a wall. It is quite useful for that—quite as good as the clinkers.

The President—What is the cost, per thousand cubic feet of gas, of iron purification? At what do you figure the cost of iron purification?

Mr. Neal—The iron sponge cost us, last year, \$250 for a quantity sufficient to purify between 60 and 70 million feet. There is no more labor with it than there is with lime.

The President—And how much was that?

Mr. Neal—Not any; we used the labor of the same men who changed the purifiers.

Mr. Prichard—With us the cost for the last two years was four-tenths of a cent for the iron alone, and the labor would be about the same; or a cost for material and labor of eight-tenths of one cent. When we used lime it cost us 3 cents.

The President—You calculate something over 2 cents as the total cost of it?

Mr. Prichard—That is the total cost of it, as I have to enrich the gas with something else in order to make up for the carbonic acid.

Mr. Sherman—At the price we paid (\$4.35) for Westmoreland and Penn coal, and obtaining a 16-candle gas, the cost would be about 27 cents per candle power. If you then had to bring the candle power up, you would then have to add say 6 per cent. of enriching material to it; and this would make the candle power cost 4 cents more. In that light I do not see that there is any saving gained by the use of the sponge. The cost of the finished product is 27 cents per candle power; and it is what you can get at same cost from Westmoreland coal. Even to the latter you would have to add enricher enough to bring its cost up to 30 cents, so as to get the proper candle power, provided the carbonic acid was present.

Mr. Prichard—If you produce such candle power from coal alone it might cost that; but when you introduce naphtha, with the yield you can obtain from it, and the heat which you get with it (which indirectly brings additional candle power), then, of course, it will not work out that way.

The President—The next question is—

"What is the effect of wet coal upon the illuminating power of the gas made from it?"

I suppose everybody present possesses some general notion about that. Col. Stedman, what do you consider to be the effect of wet coal on gas?

Mr. Stedman—I am sure that I have not thought enough upon the subject to give an opinion about it. We generally store our coal very carefully under cover, in order to prevent it from being wet when used. We regard it as a matter of economy to use dry coal in the retorts. I have never looked for the chemical effects at all.

The President—We have a mine of wealth with us which we have not tapped as yet. We would like to hear what Mr. Thomas has to say on this subject.

Mr. Thomas—I have always considered it a great disadvantage to carbonize wet coal. I have always found it advantageous to have the coal stored so that it might be kept thoroughly dry. I claim that the drier the coal is when put into the retorts the better are the carbonization results obtained. Some years ago we were put to the necessity of allowing a portion of our coal supply to remain exposed to the influence of atmospheric change—owing to inadequate shed capacity—and the result was that the yield (making a comparison between the same grade of coal when wet and dry) ran down by one-half foot per pound. The yield from the coal when wet would be 4.25; when dry, 4.75. In the winter season we would take in a good deal of ice with the coal; and with so much water added we could not expect to produce the average yield per pound. I think it is an advantage, in every respect, to use dry coal; and further, there is no doubt at all in my mind that the sooner coal is used after its extraction from the mines the larger will its producing qualities be found. Take freshly mined coal and carbonize it, and you will secure a much better yield than can be obtained from the same coal kept stored for two or three months. I once made some experiments on this last named point, and their outcome was entirely in accordance with the assertions just made. If perfectly dry coal will deteriorate simply by lying in storehouse, it will certainly deteriorate much faster if wet. I think the drier the coal is the better result you will get—you will certainly get a better result in working the retorts, and you will get better gas.

The President—Suppose you contracted for the delivery of a cargo of dry coal, but when the vessel came alongside the shipment was delivered in a wet state; would you consider a damage of 10 per cent. had been done to the coal?

Mr. Thomas—It would depend upon how wet it was. I have taken coal and evaporated from it 5 per cent. of water; but still that was undoubtedly an abnormal case. The contained moisture will vary between 2 and 5 per cent. Now, if you pay for from 2 to 5 per cent. of water you throw away just so much money.

Mr. Slater—I think that Mr. Humphreys has made some experiments bearing on this subject—more particularly with regard to fine coal. Perhaps he has also inquired into the subject of wet coal.

Mr. Humphreys—I do not remember to have made any experiments with regard to wet coal. I have tested the fine coal as against lump coal, but I do not remember my exact figures.* I found that the lump coal was much better, but just how much better I do not know. In testing wet coal against

* See JOURNAL, Vol. XXI., pp. 171-2.

dry coal, I do not remember that I have ever made any such test as would enable me to give the figures from memory. Of course, if the coal is delivered to you wet, the loss will depend greatly upon whether it is lump coal or fine coal. I know that I had some fine coal which was delivered to me when it was quite wet; the portion I was obliged to use while in the wet state certainly gave me results 15 per cent. poorer than those obtained from the same coal when it was dry.

The President—We have had some wet coal sent out to us during the last year. It formed, I think, a portion of two cargoes; and according to my recollection the make fell off about two-tenths of a foot each time. Using the dry coal from the shed in some benches, and making a comparison with other benches charged with the wet coal as taken directly from the vessel (making the test several times), we found that the make fell off about two-tenths of a foot per pound of coal. This, of course, means the loss of a large quantity of gas. I do not believe the candle power is very greatly affected. The loss is in the shrinkage of yield.

Mr. Snow—A year ago this winter we had a cargo of wet coal delivered at our works, and we found that the yield ran down from 4.9 to 4.7, and also brought the candle power down from 17 to 15.

The President—Then you fell off two-tenths of a foot, or just about as we did.

Mr. Yorke—I would ask the gentleman whether, in taking the weight of the coal, he allowed anything for the weight of the water?

Mr. Snow—No; we weighed it up wet, the same as if it were dry.

Mr. Yorke—The yield per pound of coal will certainly vary according to the amount of contained water. One particularly bad feature is that the wetter the coal the greater will it reduce the heat of the retort. If you have 5 per cent. of water in your coal, and make allowance for that extra weight—or, say, weigh out 105 pounds of the wet coal, and call it but 100 pounds—the yield would probably be about the same, if you also make due note of the reduction in the heats.

The President—Then, if you have a cargo of coal which is wet, it would fall of about 5 per cent.?

Mr. Yorke—The falling off would of course be determined by the amount of water in the coal. I think I should allow, generally speaking, about 5 per cent. On one or two occasions when we have received wet coal, we have weighed the wet material and then have dried it, so as to ascertain the weight of contained water, and in order to have the shippers grant us the proper allowance. We have had this weight to vary from 3 to 6 per cent., and on fine coal it was really a trifle more than 6 per cent. But, of course, if we weigh the water as coal our production per pound would naturally fall off.

The President—You would hardly weigh in 5 per cent. of water if your coal was lump.

Mr. Wood—We have occasionally used wet coal, and I have always found that at such times of carbonization our candle power would depreciate, as would also the quantity of gas obtained. I do not know that this has been the general observation; but such has been my unvarying experience.

The President—As a rule, what would be the loss in candle power?

Mr. Wood—From 1 to 1½ candles, varying with the amount of water in the coal.

The President—The statements here made by one or two gentlemen are to the effect that the candle power and make fall off between 5 and 10 per cent. I think these facts are valuable, because there is not one in attendance here but who, one time or another, has had to ask from his coal shippers a rebate on wet cargoes. If it be true that the candle power falls off 10 per cent. and the yield shrinks by about 5 per cent., the wet coal question assumes a most serious phase; for a loss of 10 per cent. in candle power and 5 per cent. in yield would make a difference of at least 50 cents per ton in the value of a coal. If there is a coal shipper in the room we would like to hear what he has to say about it.

Mr. Copp—I would like to ask the President what his experience was with coal shipped to him in steamers—if it did not come to him finer? If I remember rightly he had some coal which was shipped in steamers to the Boston works, and that the coal was dried out to such an extent that it became pulverized on the voyage. Was it not, although perfectly dry, thereby very much decreased in value?

The President—Mr. Lamson was Superintendent of the works at the time, and possibly he can give you the information.

Mr. Lamson—I understand, Mr. Copp, that in your judgment some of the value of that coal was distilled out of it by being so very dry.

Mr. Copp—I believe that it was considered to have been somewhat damaged.

Mr. Lamson—There was a discussion as to the value of certain coal, and in the discussion between the coal factors and the gas management the argument was brought forward that the coal had been rendered fine in transit on account of the heat of the steamers. I never believed that in any way, shape or manner, I did not place any credence in that claim then, and do not to-

day. I believe that the argument had no reasonable foundation. In order to prove to the people who had been arguing on that side of the question, and to show that the heat would not disintegrate the coal in such a short period of time as that taken up by the voyage, I had the coal put into a carefully-prepared receptacle—taking lumps as large as one's fist, and being careful to pick it all over so as to have only lumps—and placed it on top of the retort stack, keeping it there during ten times as long a period as it would have taken to make the voyage in the steamer. The test proved that the heat did not affect it a particle. The damage, in my opinion, was not caused by the disintegration as a consequence of excessive heat experienced on the voyage, but was merely a result of some peculiarities having their origin in the different shafts of the collieries from which the coals were mined.

Mr. Sherman—I once saw a report that an engineer made to his board of directors with regard to the value of different coals, and in it he figured up that a coal which would make two thousand feet more per ton than another coal, was worth the price at which the gas was sold per thousand feet—in his case it was worth \$8 per ton more. If that principle should be applied to our method of settling with our coal friends in our damage arbitrations about wet coal, I think they would owe us something.

Mr. Copp—I had no pecuniary interest in the cargo of coal of which I spoke; but I knew that there was some discussion had as to the condition of the coal which came by steamers, as compared with the condition of the coal received from sailing vessels.

Mr. Lamson—But, when the thing was worked out, it came down to the question of what shafts the coal came from. The question whether it had come by steamer or by sailing vessel was proved to be practically of no importance; and the question about heating the coal and disintegrating it I believed to be just about as unimportant. The whole thing came down to the point that the difference in the coal was due to the fact that it came from different shafts.

Mr. Copp—It may be possible that the difference was owing to the fact that coal from one shaft was more friable than that which came from another shaft.

Mr. Lamson—I always took the ground, and I feel as clear about it now as I did then, that there is no visible effect or difference exerted upon coal as between that which comes by steamer or by sailing vessel. I do not believe that the heat of the sun upon the coal carried on the deck of a vessel, or the heat of the boilers in a steamer, would have any appreciable effect upon the value of a coal.

The President—Do I understand Mr. Copp to contend that he considers it rather a good thing to have the coal wet?

Mr. Copp—From which standpoint am I to answer—in my position as a coal man or a gas man? As a gas man I would rather prefer to have dry coal.

Mr. Taber—Would not the matter of wet coal be somewhat dependent upon the character of the contained water? If the coal is wet from sea water undoubtedly it will be poor stuff to carbonize. There can be no question about that. If, however, the coal has been wetted only with rain water, or that which has fallen during the time of transit—whether or not it is thereby greatly injured—may be a subject for discussion. There is no question at all with regard to the deleterious effect of sea water on the coal.

Mr. Lamson—In that case the coal would be worse if it came in a sailing vessel than if it came in a steamer; because in a steamer no water gets into the coal.

Mr. Taber—Sometimes sailing vessels will wet the coal down in order to make the tonnage greater.

Mr. Copp—Is it not the fact that the Boston Gas Light Company have always kept their richest coal out of doors?

The President—We used to keep it out of doors.

Mr. Copp—Because you thought that the water would help it?

The President—Because we did not think it worth while to put a shed over it. As the coal had been paid for when dry, it did not make much difference. Now that we are using a larger percentage of cannel coal than we formerly did, we have seriously considered the damage which was done to that cannel from being kept out in the open air; and have debated whether it would not pay to put a shed over it. We have no doubt that the snow which falls on to the coal and the ice which forms on it in the winter does have an effect upon the yield; and if for no other reason because it has an effect upon the temperature of the retorts. Some coals will take up water just like a sponge. As an example of the way that the Albert coal will hold water (we have not purchased any for some years, but have once or twice changed the position of our present stock), we do not know yet how much we will make on the transaction; but my impression is that we have some four hundred tons of Albert coal that will not stand us in anything. We estimate that we have got six hundred tons of coal in one pile, while it stands on our books as only one hundred and fifty tons.

[To be Continued.]

[OFFICIAL REPORT.—Continued from page 207.]

Papers Read before the First Annual Meeting of the Ohio Gas Light Association, with Discussions on Same.

FIRST DAY.—AFTERNOON SESSION.

With the close of discussion on Mr. Butterworth's paper on natural gas, President Hickenlooper said that Mr. Emerson McMillin would claim the attention of the Association. The latter gentleman then read the following paper on the question of—

DO WE GAIN HEAT, OR SAVE FUEL, BY PASSING STEAM THROUGH OUR GRATE BARS?

Evaporating water from the ashpans of furnaces, and passing the steam therefrom through the grate bars certainly is a practice as old as is the gas business itself. This being a fact, it seems strange that it should be thought necessary to propound the question contained in the title of this paper.

I take it that, directly or indirectly, advantage is gained by such use of steam; or, otherwise, the practice would be abandoned. The importance of the subject is only realized when we undertake to prove either an affirmative or negative answer to the question asked.

The quantity of water evaporated from the ashpan of an ordinary fire, heating six retorts, will vary from 300 to 600 pounds per 24 hours. The quantity will be largely influenced by the height of grate bars above the surface of the water. The average will be about 500 pounds. This same furnace will consume probably 40 per cent. of the coke made in the retorts heated by it; or, say, 2,000 pounds of carbon, which gives the ratio of one of water to four of carbon.

My attention was first called to this subject by Mr. C. F. Prichard, Engineer and Superintendent to the Lynn (Mass.) Gas Light Company. He questioned the propriety of using water; and asserted that it resulted in adding neither intensity nor quantity of heat to the retorts.

I believed he was wrong as to intensity, but probably right as to quantity. A friendly exchange of letters soon convinced me that prior to the inception of the correspondence I had no right conception of the magnitude and importance of the question. I am now, however, satisfied that neither intensity nor quantity of heat is added to the fire of the ordinary coke furnace, but, on the contrary, that both are reduced by the use of water vapor. Nevertheless the loss seems to be necessary, as, without the use of steam, the fires become clogged with clinker.

In the combustion chamber of a gas furnace, however, the loss, if any, will not be so great as with the coke furnace; and indeed I think I can show a positive gain. I designate as "coke furnace" the old manner of firing; and by "gas furnace" mean the system of generating carbonic oxide with the coke, and heating retorts by secondary combustion.

The system of firing that does not attempt to utilize the heat of primary combustion in heating retorts, and that evaporates the water by the waste heat from the escape flues, will sustain less loss, or, possibly, it would be better to say, derives more benefit from the use of steam than will other modes of firing. That is true, I think, for this reason: The quantity and intensity of heat generated by secondary combustion is much greater when steam is used than when it is not, though the total heat of primary and secondary combustion will be less as the quantity of water used is increased.

If I rightly understand the construction of the furnaces at the Boston (Mass.) Gas Works, I think they will derive more benefit from the use of steam than would be gained by the use of steam in the Cincinnati (Ohio) furnace plan; yet I believe the Cincinnati arrangement to be the better and more economical.

Col. W. A. Stedman, at the New York meeting of the American Gas Light Association, held in October, 1883, gave us more detailed data respecting the working of the gas furnace than I have been able to find elsewhere. I will, therefore, place myself under obligation to him by using the data so given in my effort to throw light upon the subject of this paper.

Col. Stedman, in a seven days' experiment, used or consumed an average of 7.42 bushels of coke per ton (2,240 pounds) of coal carbonized. This equals 11.6 pounds per 100 pounds of coal—the coke weighed, when hot, 35 pounds to the bushel. This weight (11.6 pounds) of coke would equal about 10.5 pounds of pure carbon per 100 pounds of coal carbonized. The average charge per retort during the experiment was 330 pounds. This equals 11,880 pounds coal for a run of 24 hours, in a bench of sixes, charging every four hours. Now if he used 10.5 pounds carbon for each 100 pounds of coal, he would consume a total of 1,247.4 pounds; or say, 1,250 pounds carbon in 24 hours. The quantity of water evaporated was 80 pounds per hour, which equals 1,920 pounds in 24 hours, or more than 1.5 of water to one of carbon. Yet Col. Stedman thinks that more water (during the heavy charging) could have been used to advantage.

From the data given by Col. Stedman I calculate that there was entering his furnaces, for primary combustion, about 80,000 feet of air, or about 1,400 pounds of oxygen per 24 hours, which would convert 1,050 pounds carbon t

CO; and if no carbonic acid was formed, there would be 200 pounds of carbon remaining to be consumed by the oxygen of the water. This would require only 300 pounds of the water to supply the requisite quantity (267 pounds) of oxygen. If this be true, what becomes of the remaining 1,620 pounds of water? Is it possible that it can pass through four feet of incandescent coke and not be decomposed? Or, is it more probable that a large part of the oxygen of the air passes through the hot mass of carbon and escapes combination?

The water would furnish 1,707 pounds of oxygen, which would combine with 1,280 pounds of carbon (to form CO) which is 30 pounds more than the total carbon used. Therefore, if enough oxygen of the air is united with the carbon to maintain the proper heat in the furnace, it is impossible for even half of the water to be decomposed. There is too much water if the oxygen of the air sent in is utilized, and too much air if but half the water is decomposed.

I think, however, it is possible that less air entered for primary combustion than Col. Stedman supposes, and my own experience with a similar furnace leads me to this conclusion. It is possible to set the openings for the ingress of air for secondary combustion so as to give a fixed quantity. Not so with the primary supply. The velocity will be constantly changing. Immediately after the ashes are shaken out of the furnace the velocity will be great; but will be continually decreasing until the operation of stirring out the ashes is repeated.

Experiments recorded in "Percy's Fuel" show the following results obtained from passing steam through red-hot coke; and in connection with these experiments it is asserted that the depth of the coke did not materially influence results; gas obtained in volume—hydrogen, 54.22; light carbon-retted hydrogen, 1.62; carbonic oxide, 31.86; carbonic acid, 12.30; total, 100. This shows that nearly 27 per cent. of the carbon taken up was in the form of carbonic acid. This is a much greater loss than is popularly supposed to be sustained; and I think more than double what the loss would be in a furnace of the form, and with the depth of coke, used by Stedman.

In my investigation of this subject I shall therefore assume that not more than ten per cent. of the carbon is consumed to carbonic acid in the producer, the remaining ninety per cent. uniting with oxygen to form carbonic oxide. Upon this basis of calculation, if all the water vapor sent into the furnace (1,920 pounds) should be decomposed, this vapor alone would give up oxygen enough to consume 1,155 pounds of the 1,250 pounds of carbon used. But could this be accomplished and the heats be maintained high enough for decomposition?

The heat lost by the decomposition of 1,920 pounds of water will be equal to the heat produced by the oxidation of the quantity of hydrogen (213 pounds) contained in 1,920 pounds of steam. The calculation will then stand thus: $213 \times 62,500 = 13,312,500$ units of heat lost by the decomposition. From the figures showing the loss, however, must be deducted the heat produced by the union of oxygen with the carbon in the process of dissociation, the heat carried in by the steam, and the heat produced by the union of oxygen from the air used in the conversion of the 95 pounds of carbon not required for the decomposition of the water vapor.

	Units.
Carried in by 1,920 pounds of steam, $1,920 \times (966 + 212) = \dots$	2,261,760
Produced by the union of 1,374 pounds oxygen from the water, with 1,125 pounds carbon to form CO, $1,125 \times 4,200 = \dots$	4,725,000
Ninety-five pounds carbon uniting with oxygen of the air, $95 \times 4,200 = \dots$	399,000
Three hundred and thirty-three pounds oxygen of the water uniting with 125 pounds carbon to form carbonic acid, $125 \times 14,000 = \dots$	1,750,000

Giving a total heat produced, and carried in by steam, of \dots 9,135,760

This sum deducted from loss by decomposition shows the net loss to be 4,176,740 units of heat; thus clearly showing that not all nor even one-half of the steam could have been decomposed. It would require an additional 299 pounds of carbon to be consumed to carbonic acid to produce heat equal to the loss of decomposition; to say nothing of the large additional quantity that would be required to heat the resulting products to the temperature necessary for the decomposition of steam—say to 1,200° or 1,500° F.

Then, instead of Col. Stedman being able to use more than 80 pounds of water per hour to advantage, he should have reduced the quantity he was using to not more than 25 pounds per hour; and even less than that quantity would be still better.

Now, if I am right in my conjecture that not more than a total of 25 pounds weight of water per hour was being decomposed, then to raise the other 55 pounds (1,320 pounds in 24 hours) from 212° to the temperature of the combustion chamber—say 2,500° F.—required 17.25 per cent. of the total fuel used. Was this expenditure of fuel necessary to prevent the formation of clinker? I think not. The temperature of the furnace may be kept as low as desired, and yet pass no water vapor through the furnace undecomposed.

I will now present the work of another furnace, using 600 pounds of water per day of 24 hours; and as the furnace we have been considering gave results much above the average, I take one that gives more nearly average results—one using 25 per cent. of its coke, or say 1,500 pounds of carbon. The ratio would then be 2.5 of carbon to one of water. I will assume that 10 per cent. of the carbon is consumed to carbonic acid, 90 per cent. being converted into carbonic oxide, in the producer or furnace proper, or the same as was done in preceding calculation.

The 600 pounds of water represents 533 pounds of oxygen and 67 pounds of hydrogen. The oxygen will combine with 400 pounds of carbon to form 933 pounds of CO; 150 pounds (or 10 per cent.) of the carbon will unite with 400 pounds of oxygen of the air to form 550 pounds of carbonic acid; and the remaining 950 pounds of carbon will unite with 1,267 pounds oxygen of the air to form 2,217 pounds CO. This introduces 5,837 pounds of nitrogen. The total heat of the producer, or furnace, now stands thus:

	Units.
Heat of steam.....(212 + 966) × 600 pounds =	706,800
Carbon to CO.....1,350 pounds × 4,200 =	5,670,000
Carbon to carbonic acid.....150 pounds × 14,000 =	2,100,000
Heat of air.....7,500 pounds × 60° × .238 =	107,100
Total quantity of heat.....	8,583,900
From this must be deducted loss of water dissociation. The 600 pounds water contained, hydrogen.....67 pounds × 62,500 =	4,187,500
Leaving net quantity of heat.....	4,396,400

Now, it will be necessary to show that even 600 pounds of water vapor can be decomposed, and the heat of the producer maintained. To ascertain the temperature of the furnace we divide the net units of heat by the weight of the gases produced, multiplied by their specific heat. The resultant gases are as follows:

3,150 pounds carbonic oxide × specific heat, .2480, =	781.200
5,837 " nitrogen × " .2440, =	1,424.228
550 " carbonic acid × " .2164, =	119.020
67 " hydrogen × " 3.4000, =	227.800
9,604 pounds gases × " .26575, =	2,552.248

The total net quantity of heat units, 4,396,400, divided by 2,552, equals 1,726° F. as the temperature of the producer, allowing no loss for radiation—that source of loss being about the same whether water vapor is or is not used, and the item is ignored in all the calculations.

The 1,726° F. was the highest possible temperature to be obtained under the conditions named, and certainly much above the real temperature. The inside of the walls toward the top of our producers are often only dark red. I shall therefore assume that the temperature of the gases entering the combustion chamber do not exceed 1,400° F., and then proceed to calculate the temperature attained in the combustion chamber, stating in advance that the air entering the combustion chamber for secondary combustion is heated by waste gases to 300° F.

	Units.
Heat carried up from the furnace, in the gases, 9,604 pounds × 1,400° × specific heat, .26575, =	3,573,168
We must now introduce 1,800 pounds of oxygen to unite with 3,150 pounds of carbonic oxide, and 533 pounds of oxygen to unite with 67 pounds of hydrogen. With this 2,333 pounds of oxygen will enter 8,167 pounds of nitrogen. Total air entering for secondary combustion, 10,500 pounds × 300° × specific heat, .238, =	749,700
In putting 1,500 pounds carbon into the furnace we put in 1,650 pounds coke, drawn hot from the retorts, entering furnace at not less than 1,800°. This will carry in heat, 1,650 pounds × 1,800° × specific heat, .2, =	594,000
Heat produced by the combustion of hydrogen, 67 pounds × 62,500 — (966 units (latent) × 600 pounds) =	3,607,900
Carbonic oxide burning to carbonic acid, 3,150 pounds × 4,325 units =	13,623,750
Total heat.....	22,148,518

Now, to find the temperature of combustion chamber we follow the rule stated above for ascertaining the temperature of the producer—i. e., multiply the weight of the resulting gases by their specific heat, and with resultant product divide the total heat units.

Carbonic acid..... 5,500 pounds × specific heat, .2164, =	1,190
Nitrogen..... 14,000 " × " .2440, =	3,416
Water..... 600 " × " .4750, =	285
Gases..... 20,100 pounds × specific heat, .2433, =	4,891

The total heat units, 22,148,518, divided by 4,891 equals 4,529° F., or the possible maximum temperature of the combustion chamber. In practice, of

course, it is much below this, not only from radiation and convection of the material composing the benches, but to a still greater degree by the liquefaction and gasification of the coal in the retorts.

From the above calculations we can deduce this fact—that for every one degree of temperature of the escaping gases we will lose 4,981 units of heat, and for every 100 degrees we lose a little above 2.2 per cent. If the gases escape from the flue of the combustion chamber (of the furnace we have been considering) at 900°, the heat carried away will equal 19.88 per cent. of total heat. But as the calculations considered only the exact quantity of necessary air, both for primary and secondary combustion, and as such exactness is never attained, it might be considered good work if not more than 25 per cent. of the heat of the combustion chamber were carried off when the gases escape at 900°; or an approximate rule would be to consider that 3 per cent. of the value of your fuel is lost for each 100° F. temperature of the gases in the escape flues.

Now, there are two questions to be considered here: First, can we keep down the temperature of our producers without the use of steam? Second, can we have same temperature, or higher, in the combustion chamber with no water used as when the water used equals 1 to 2.5 of carbon?

To the first question, I say the temperature can be kept down and the required quantity of carbonic oxide generated by making the furnaces large and causing slower combustion in the producer; but whether the formation of clinker will be prevented when the fire is at that temperature necessary for decomposition of carbonic acid is a question about which I am not clear. The reduction of the metals of the ash begins at a very low temperature; and I take it that it is the province of the steam to prevent that reduction—to keep the metals oxidized to sesquioxides, at which degree of oxidation they will not melt to clinker at the temperature of our producers; but when these metals are reduced to protoxides they melt at low temperatures.

Whether the second question can be answered in the affirmative is purely a question of calculation. We will assume that if no water or steam is used it will be necessary by some other means to keep down the heat of the producer, so that clinkers will not choke up the furnace; and that the gases entering the combustion chamber for secondary combustion will be of the same temperature (1,400° F.) as the gas was estimated at in the preceding calculation when water was used.

Assuming the temperature as above, the heat carried from the furnace into combustion chamber will be as follows:

	Units.
550 pounds carbonic acid × 1,400° × specific heat, .2164, =	166,628
3,150 pounds carbonic oxide × 1,400° × specific heat, .2480, =	1,093,680
7,700 pounds nitrogen × 1,400° × specific heat, .2440, =	2,630,320
11,400 pounds gases × 1,400° × spec. heat, .24377, = total heat units,	3,890,628
Units of heat carried in by the hot coke: 1,650 pounds × 1,800° × specific heat, .2, =	594,000
Carried in by air for secondary combustion: 8,100 pounds × 300° × specific heat, .238, =	578,340
Generated by the combustion of carbonic oxide to carbonic acid: 3,150 pounds × 4,325 =	13,623,750
Total heat units.....	18,686,718

We now have the resultant gases as follows:

Carbonic acid, 5,500 pounds + nitrogen, 14,000 pounds, × specific heat, .2362, =	4606
--	------

Using these last figures as a divisor and the total heat units as a dividend (thus, 18,686,718 ÷ 4,606 = 4,057° F.), the product is the temperature of the furnace, ignoring loss by radiation, same as in preceding calculations.

This shows that the maximum temperature with the use of water vapor, in the proportion of one of water to 2.5 of carbon, is, or can be made, 470° F. greater than when no water is used.

But when no water is used there will be a loss of only 4,606 units for each degree of temperature of escaping gases, instead of a loss of 4,981 units, as sustained when water is used. When no water is used, however, and the gases escape at 900°, the loss equals 22.18 per cent. of the total heat units of the combustion chamber.

The results of these calculations demonstrate conclusively to my mind that we can both save fuel and gain intensity of temperature by the use of about 40 pounds of water vapor to 100 pounds of carbon, or 110 pounds of coke, when the coke is consumed in a producer furnace, and the gases burnt in a combustion chamber about the retorts. That with the ordinary shallow coke fire there is a loss sustained in using water, but the loss is a necessary one.

The result of experiments in works in weighing the water passed into our furnaces leads me to conclude that probably many gas works managers have but a faint conception of the weight of water daily evaporated from their ashpans, or sent through the grate bars as a steam jet.

Notwithstanding the fact that I have proven by figures (and who doubts the veracity of figures?) that great loss is sustained by the use of an excess

of water vapor, and, further, that more than one of H_2O to 2.5 of carbon is an excess, yet this thought "will not down." Who can show better results from the working of their furnaces, where an excess of water has not been used, than has been shown by Stedman, where, apparently, great excess of water has been used? Therein, I think, lies food for reflection.

Discussion.

Mr. Fullagar—With regard to the idea advanced by Mr. McMillin, where he speaks of increasing the size of the furnace, I would like to inquire whether the increase advised would be made in area or depth?

Mr. McMillin—The area; not the depth. The object of substituting a larger furnace was to bring the oxygen of the atmosphere in contact with more fuel, obtaining the same quantity of gas during carbonization, but with slower combustion. If a nail lies out in the atmosphere and becomes completely rusted, its condition was occasioned through the action of heat just the same as though it had been brought about by a hot fire. You could not detect the heat conditions, simply because the combustion was so very slow.

Mr. Enfield—There seems to be some question among gas engineers as to whether the steam or water vapor is decomposed in passing through the regenerative furnace. For my part I have but little doubt about the matter. I think the vapor is decomposed into its constituents of hydrogen and oxygen. We all know—especially so with those who have had experience with the Lowe water gas process—that steam passed through incandescent fuel is broken up into its constituent gases; and we also know the gaseous mixture so produced is a permanent one—that it will stand confined in a holder for days at a time without important change. If this be so in that case why should not a like result happen with the steam passing through a furnace as we employ it? If so, we get the resulting gases which, together with the use of hot coke, and slow and perfect combustion, make up the aggregate of advantage and saving gained by working under the regenerative furnace system. It is rather a tedious and wearying task to figure up the different matters involved in a compilation of aggregate results; and while no doubt the calculation will prove the gain, those who have never made the figure comparison will readily acknowledge the great practical saving that follows the introduction of the regenerative system. I have seen old-style furnaces that absorbed 60 per cent. of the coke produced—very poor furnaces, indeed, were those; I know that others managed to get along with a fuel consumption of 33½ per cent., but I never yet have seen one that would work satisfactorily under an absorption of only 25 per cent. of the coke product. A regenerative furnace will give every satisfaction at the last named percentage of fuel supply, and do it continuously. We can see this fact practically demonstrated every day. The question of arriving at perfect combustion, I submit—no matter how it may be secured—is one of the most prominent and valuable topics for the consideration of the gas engineer of to-day. And I would assert as my opinion that, in regenerative firing, by the decomposition of steam in the furnace, and the passage of its resultant gases into the combustion chamber, acting as assistants to the other gases from the burning of the solid fuel, and there securing thorough combustion, we do get the best results that can be had.

President Hickenlooper here introduced Mr. John Fullagar, Engineer to the Cincinnati (Ohio) Gas Light Company, who read the following paper on the question of

DOES IT PAY TO USE ANY LIME IN CONNECTION WITH OXIDE OF IRON?

Mr. President and Gentlemen of the Ohio Association:—I have been called upon by your Executive Committee to read a paper upon the subject of lime in connection with hydrated peroxide of iron for purification; or, more properly stated, "Does it Pay to Use Hydrate of Lime for Removal of Carbonic Acid?"

It is well known that hydrated peroxide of iron for purification removes only the various sulphur compounds, and has no affinity for carbonic acid. I presume that any person familiar with the chemistry of gas making will admit the necessity for removal of the carbonic acid, as its presence deteriorates the illuminating value of the gas, and, to that extent, militates against a maximum production of a standard gas per ton of coal carbonized. Only one per cent. of carbonic acid in the gas reduces the candle power from 8 to 10 per cent.

The quantity of this impurity varies considerably, depending of course on the description of coal carbonized—the volume thereof in the gas ranging from zero to 4 per cent. A large portion of this is eliminated in the scrubber, but if only one-half of one per cent. remains in the gas after passing the oxide purifier it will certainly pay to remove it. To accomplish this it is necessary to resort to the use of hydrate of lime, as being the most efficient and cheapest agent for that purpose. The cost of lime for removal of this impurity is merely nominal, as one bushel of oxide of calcium will absorb fully 700 cubic feet of carbonic acid, or about 4.75 cubic feet per pound of hydrate.

By dispensing with the use of lime, and thus failing to abstract the car-

bonic acid, it would be necessary to use a large per cent. of enricher to maintain the illuminating power, or be satisfied with a decreased yield of gas per ton of coal carbonized to obtain a standard gas.

In view of these facts, I deem it expedient and profitable to use lime in conjunction with hydrated peroxide of iron for complete purification.

Discussion.

Mr. Hamlin—I presume there are some gentlemen here whose works are in capacity about the same as those I am interested in—4-inch connections. Formerly we had been using lime in purification, and found it very expensive. Finally we concluded to try iron borings, or sponge, and a short trial proved the new departure would cost us more than we had supposed. Then we purchased iron borings, adding sawdust thereto in the proportion of one pound sawdust to 30 pounds borings. We kept on altering the mixture until at last we fixed it at the ratio of 70 pounds borings to one bushel of sawdust. The substance appeared so dry that we at first sprinkled it. This plan not working well, we then tried it in a perfectly dry state. The lower layer in the purifier consisted of lime, in order that the impurity not extracted by the sponge would certainly be removed by the lime. We have now been using the mixture for a long time, and I must say it gives much better satisfaction than did the lime alone; also, it is cheaper. After it has been fouled we remove it from the boxes and allow it to revivify, in this way generally keeping three or four piles going through the process of revivification. It comes out black; we keep it exposed for five or six hours to sweeten up, and finally it resumes its original rusty color.

Mr. McMillin—There are a good many points of considerable interest in that paper. I understood the gentleman to read that one per cent. of contained carbonic acid would reduce the illuminating value of the gas from 8 to 10 per cent. I will agree that, if you take pure coal gas, without any carbonic acid gas in it, and add thereto one per cent. of carbonic acid gas, the addition would reduce the illuminating power very much; but I do not believe, if gas is purified with oxide of iron alone, and one per cent. of carbonic acid gas be thus left in, it will give 10 per cent. less light, nor 5 per cent., nor 1 per cent., nor any per cent. less than when purified with lime and all the carbonic acid taken out. I think, month in and month out, we will make a higher candle power using oxide alone than when using lime alone. I think if you use lime after the sulphur has been taken out you increase its value some; but as between the two systems of oxide and lime, you will get gas of higher power when purified by oxide than by lime.

Mr. McMillin here quoted from the report of the Massachusetts Gas Inspector's tables, and said:—Charlestown and Lynn are two places that use oxide only. At Charlestown the illuminating power is 17.01, and at Lynn 17.17. At the works named carbonic acid is anywhere from twice to ten times that in other Massachusetts towns; yet the illuminating power of the gas will average equal to or greater than the average of the other towns in that State. I do not believe you lose as much by allowing the carbonic acid to remain in the gas, when purifying with oxide alone, as you lose by taking out the rich carbonaceous oils carried along as vapors, when using lime exclusively. One has little idea of how much rich material he throws away when employing lime alone, unless he has tested it. For a time we filled some old discarded boxes with half lime and half coke, and took the mixture out after it had remained in the box for ten days. We then put it into a retort. The gas we had to purify was made from coal that gave four feet to the pound; we made two feet to the pound from the coke, breeze, and lime, and the product was just about as good gas as that given off by the coal. When you use lime and cast it aside every day, just see what, in the aggregate, you are throwing away. With us everything of that kind is lodged in these boxes mingled with coke screenings until the coke is saturated. Of course we never throw any oxides away. All the vapor that should be retained as permanent gas passes along with the gas. The oxide of iron and lime together is, I admit, perhaps better; but I do say that oxide is better than lime used alone.

Mr. Fullagar—Two years ago I found from experience when we were then using oxide alone, that carbonic acid gas was passing out very freely. To remedy this we placed a layer of lime on top of the oxide, and on the first day of the experiment our illuminating value was augmented by 1½ candles. One year ago we put 300 bushels of lime in the purifying house, and it is in use to-day. From letters received by me, I found the reason why other parties did not want to use oxide alone was because the candle power went down. I may say that this appears to be the general complaint against exclusive purification with oxide.

Mr. McMillin—With regard to the use of enrichers at the Massachusetts gas works, spoken of by me, I admit that more or less of different enrichers are there employed. That does not change the position I have taken. The difference still remains. One has one-tenth of one per cent. carbonic acid in his gas, and the other has 1.75, yet the illuminating power is about the same. Mr. Hamlin spoke of first trying dampened oxide, but did not then succeed; yet when used dry he did. I think he attributed his success to the

wrong cause. I never knew the oxide to succeed at the first trial—at first time of asking it always fails; but I believe it will succeed better wet than dry; it will do better work when damp than when dry. The decomposition makes water. If it were always kept dry, and the oxide did not become hydrated, it would be a very poor purifier.

Mr. Enfield—For a great many months I used oxide of iron to purify the gas, placing about three inches of hydrate of lime on the top tray. The lime, instead of having the same color that it usually possesses when taking out sulphuretted hydrogen, was white; and the men around the works noticing its white condition, and apparently looking so much like what it did when it was first put in, concluded it had not done any work, and so might be left in action. In thinking the matter over I concluded this lime had taken up no sulphuretted hydrogen because the oxide had already extracted it, but that it had been charged with carbonic acid (CO₂) and could not do its work over again. As a result I determined we had better put in fresh lime every time we changed the oxide.

Mr. Fullagar arose to say that was the principle he was acting upon. He had had it close on to three years. If it were put in a separate purifier they would have its full value; otherwise just about one-half would be lost.

Mr. Enfield said a wrong inference might be gathered from the remarks made by Mr. Hamlin, who, while he was probably using an ordinary oxide of iron, yet it had not the same formula as the common sponge that the majority of the members were working with.

At this stage of the proceedings congratulatory telegrams from the New England Gas Light Association, letters from Mr. C. J. R. Humphreys, Secretary of the American Gas Light Association, Mr. A. W. Littleton, Secretary of the Western Gas Association, and from Mr. Jos. R. Thomas, Editor AMERICAN GAS LIGHT JOURNAL, were read, and duly acknowledged.

In the absence of Mr. Jos. Light, of Dayton, Ohio, who had prepared a paper on "Circular Subject No. 6," entitled,

HOW MUCH COKE IS LOST AS SCREENINGS, AFTER BEING CRUSHED; AND WHAT ADVANCE MUST BE ADDED TO PRICE OF CRUSHED COKE TO MAKE IT EQUALLY PROFITABLE TO SELL BY GAS COMPANIES?

the Association's Secretary was instructed to read the communication. It was as follows:

Mr. President and Gentlemen:

The consumption of coke for fuel in private residences has become a very interesting item to all gas managers. It is but a few years since that coke was a drug in our home market; and, in fact, we could hardly give it away. I can recollect when the President of our company asked me if I could not suggest a plan by which we could get rid of our coke heaps. I told him I could; and my plan was to declare a dividend in coke, and compel each and every stockholder to take it from the premises whether he wanted it or not; but I could not get our chief officer to agree with me. Now, I am pleased to say, a great change has taken place; and the change has been so marked that we cannot supply the demand in the winter months.

How did this change take place? We began by selling the coke at a low price—in fact we gave some away in order to induce some of our citizens to try it. We also purchased a crusher, and broke or crushed the coke up so that it could be used in the anthracite self-feeding stoves. The subject which our Secretary asked me to bring before you is, "The loss incurred by crushing coke." That is rather difficult for me to determine; as a rule, the construction of the crushing machine will regulate that, some machines wasting more than others.

I will state the result as found by me at our works, which is as follows:

One hundred bushels of coke, weighing 3,600 pounds, yielded—

3,048 pounds, or 84½ bushels, of crushed coke.
 108 " " 3 " " pea coke.
 444 " " 12½ " " dust.

We receive for the large coke, 10 cents per bushel, delivered.

100 bushels, at 10 cents.....	\$10.00
Two men, one hour, at 15 cents.....	30
Fuel.....	12
Oil, wear and tear.....	09

\$10.51

Less the 3 bushels of pea coke, at 6c. per bushel..

18

\$10.33

Then, 84½ bushels of crushed coke, to be equally profitable, must sell at twelve and one-fifth cents per bushel.

Discussion.

Mr. Bate—I cannot go into details or percentage of loss, etc.; but so far as getting rid of coke is concerned my experience may be of interest to parties

who have not followed the plan of crushing. All gas managers who find a surplus of coke on hand should offer, as a first inducement to its use, to sell at whatever figure they can get. Nine years ago, or when I first went to Tiffin, no attempt had been made to sell the material. It was simply thrown into a nearby creek. They had been asking ten cents per bushel for the trifling lots they did find purchasers for. I did not believe in filling up that creek with a good fuel, and it accumulated quite rapidly. I cut the price down, and sold some 4,000 bushels at 4 cents a bushel. After selling that quantity the demand ceased, and the coke piles increased; and their magnitude became such that something had to be done. Here I might add that the tar was also being run into the creek, and the people located on its lower banks were complaining greatly. I at last suggested that the company make a trial of crushing the coke. They authorized me to make the necessary expenditure, and we went systematically to work. One temptation I held out to customers was similar to the practice outlined in Mr. Light's paper—that of giving away small portions for trial. I soon found the call for the fuel began to increase; and our local brewers tried the lump coke. Eventually the selling of coke assumed such proportions that I am now actually unable to supply one-tenth of the demands made upon us. Purchasers send their wagons for it, and often actually cart it away before we can cool it off. It is used by our consumers in preference to hard coal; and the preference is always shown to those who are regular consumers of our gas. Indeed our gas consuming patrons purchase our entire coke output. The price of hard coal at Massillon and in its vicinity has been as low as \$3 per ton, and it often goes up to \$6 and \$7 per ton. I think, even if I increased the present price of my coke, I could sell it all without any trouble. At the yard we charge ten cents, and deliver it for twelve cents per bushel.

Mr. Converse—I made an experiment with our coke crusher to determine about how much was lost, by the crushing, in the shape of slack or waste. The experiment appeared to show that there was a shrinkage of about 15 per cent. We get 8 cents a bushel for lump coke, and obtain 9 cents for the crushed product. We possibly might sell our lump coke at a better price; but the demand for it is probably not so great. Now, as I can dispose of it all when the crushers are kept in operation, you may be sure that I will not risk a trial of the lump method. Bituminous coal in our town retails at \$3.40 to \$3.50 per ton.

Mr. Fullagar—In an experiment made by me on the crushing of a hundred bushels of coke, I did not find as great a shrinkage as that named by Mr. Converse. Having due regard to proper size of mesh, I find that if you crush 50 bushels of lump coke you cannot get the crushed product back into the 50 bushel measure. We do not sell our coke by weight.

Mr. Enfield—In view of the discussion to be had on this subject at this meeting it was suggested that I make an experiment at our works; and I did so. We took 100 bushels lump coke and put it through the crusher; after it had been run through we got as a return 83 bushels of nut, and 8 bushels of pea coke (from the smaller screen), with 8 bushels of dust. By weight we got back 3,320 pounds out of the original weight of 4,000—3,020 of nut, and 300 of pea. Where the rest went to I do not know. The men said I had about a bushel on my hat.

President Hickenlooper—Mr. Fullagar I think should have added that he first screened the lump coke from the other qualities, and afterwards separated the nut and pea sizes.

Mr. Fullagar—The loss would depend much upon what sort of a crusher was being operated. I believe the 15 per cent. loss spoken of by Mr. Converse is altogether too great a one. In my opinion the shrinkage should not exceed 8 per cent.

Mr. Kinsman (Springfield) stated that he sold his coke by weight.

Mr. Bushnell (Springfield) calculated they probably lost, through crushing, 3 bushels out of 25. By measure they quite likely got in the proportion of 10 cents for lump, and 12 for crushed coke.

Mr. Enfield—With reference to the relative quantity of coke that would fill a bushel, crushed or uncrushed, I might speak of an experience that we went through the other day. We had a rather large basket in our yard, and I determined to make a weight test with it. Filled with crushed coke it weighed 65 lbs—the weight of basket was six pounds. with an equal quantity of uncrushed coke, the gross weight was but 56 pounds. Now, if we would sell a bushel containing 2,688 cubic inches crushed coke at the same price obtained for a similar weight of uncrushed fuel, we would not be great gainers by the crushing; nor would it be a very profitable scheme to sell it at an advance of a penny per bushel.

Mr. Salter—Our experience in the South has been that we lose about 18 per cent. At present we do not crush our coke. We dispose of it all in the lump.

Mr. Huntington—We should never have put a crusher up at Columbus except to get rid of the coke, which, in the lump state, constantly accumulated on our hands.

Mr. Coverdale stated that it did not pay to use a crusher at the Rome (Ga.) works, because in the summer season the people would not burn coke

or coal on account of climatic reasons; but in the winter time the daily production, as well as the summer supply, could be readily disposed of in the lump state at the price of 10 cents per bushel.

[To be continued.]

The Gas Question at St. Louis, Mo.

AS NOTED BY AN ONLOOKER.

It is now over three years when certain Philadelphia "water gas people" were attracted to the city of St. Louis, Mo., no doubt "drawn" thereto by the apparently fruitful field then afforded to raiders of their sort. These gentlemen were aided by a few local capitalists, amongst whom may be included a firm who have made the bulk of their fortune through selling gas mains and building gas works, and shipping gas works appliances throughout all the western country. The Philadelphians and their very few local allies organized a corporation, and in order to obtain a charter immediately stooped to deception; protesting that they wanted to make gas to be used for heating purposes *only*. And so the St. Louis Gas Fuel and Power Company was duly established, and commenced to erect works, lay mains, advertise for customers, etc. The gas was to be made under what is generally understood to be the "Lowe process." No sooner had the charter been obtained, mains laid, and gas made, than the new corporation threw off the mask of a "Fuel Gas Company" only, and distributed gas for lighting—in fact they sent out a regular illuminating water gas. The city had been supplied previous to the advent of the new-comers by three gas companies—*i. e.*, the Carondelet Gas Company, a suburban concern, which does not figure in the present contest; the St. Louis Gas Light Company, then supplying the southern portion of the city, and about the oldest company on the ground; the remaining corporation being the Laclède Gas Light Company, which supplied the northern portion of the city—and the territory of the same, by reason of the rapid growth of its district, was greatly increasing in size and importance with each succeeding year.

Naturally the older companies had watched with great interest the operations of the new "Fuel Gas Concern." They had not attempted to check its organization; for, up to the very last minute, one of the members of the local iron works' firm before referred to had given the most positive assurances to his old patrons—and these embraced the three older St. Louis Companies—that only gas for heating and power purposes would be made. As soon as the deceit was discovered the St. Louis Gas Light Company commenced an action in State Courts against the "Gas Fuel and Power Company." After some time had elapsed it was at last decided, and in the highest legal tribunal of the State of Missouri, that while the new concern *did* have the right to make any kind of gas it pleased on its premises, and could sell the same to whom it pleased, it could not use the public streets of the city for the purpose of laying gas mains or service pipes, because the right to do these things was vested in the old company for a term of years, according to a contract made with the city. This decision settled the raiders, at least for a while. The Laclède Gas Light Company did not go to the courts at all; but promptly met the cut in price made by the new concern, and took effective steps to improve its works, and cheapen the cost of gas making. The parent company was not idle in that direction either, as two 2,000,000-foot Standard washer scrubbers, a new station meter, and new purifying apparatus and house (all recent additions), testify. The Fuel and Power Company had laid about eight miles of mains, when the previously mentioned decision of the Supreme Court put a stop to that work. As stated, the Laclède Company asked no help from the courts; but by reducing the price, and bettering the quality of the gas—all of which was made possible by means of new and improved apparatus, and some little change in the management too—met its piratical opponent squarely on that basis. The new company at first secured quite a number of consumers, but appeared also to lose them with great celerity.

Thus matters stood, in May last, when the Western Gas Association met at St. Louis. The Philadelphians (those particular ones meant herein), however, are noted for their vast (I had almost said infinite) "cheek." The plant they had erected at St. Louis consisted of one small gasholder of about 5,000 cubic feet capacity, with a second one of about 140,000 cubic feet capacity; two sets of purifiers, one 8'x10', the other being 20'x20'—the latter a good set and housed in a good building; one 10' station meter; a small brick office; and, lastly, a frame shed, in which the boiler, engine, one fan blower, and a couple of "Improved Lowe Generators" were situated. The generating plant was of the latest Lowe style, with boiler attachments, so often boastfully advertised. It may here be remarked that the boiler attachment would not work at all, and was thrown into the yard (where it now lies), which necessitated the erection of an independent boiler as a substitute. The inside of the generator house is apparently built of charcoal; which, with the "Gas Maker"—with one ear burned off, and one hand badly scarred, is not likely to reassure the feelings of any chance visitor who may gain access to

the generally nailed and locked-up works of the "Gas Fuel and Power Company, of St. Louis." A worse looking concern for a gas works than the one described—as a whole—really is, would be hard to imagine. The "company" rents an office in the Lindell Hotel, one of the best in the city; and which hotel is supplied, by-the-way, with coal gas made at the Laclède works. They used water gas, but gave it up. During the past autumn the managers of the water gas concern sought to put new life into the corpse by offering to prominent St. Louis citizens a *controlling interest* in their company. The works described were capitalized at one million dollars in *stock*, and one million dollars bonds. The generous Philadelphians offered the St. Louis gentlemen a little over \$500,000 worth of stock for the sum of one hundred thousand dollars. They proposed to keep the rest—and the bonds too. Now, remember, the whole plant is certainly not worth \$100,000. Were they not generous? They did interest some people; but, so far as known, the stock was to be bought on condition that the City Council should pass an ordinance giving the water gas company the privilege of laying mains. The old St. Louis Company, with rare stupidity, kept up the price of gas at a figure (\$2.50 per 1,000) which everybody had a right to consider too high, since the Laclède Gas Light Company was selling at \$1.50 per 1,000, claiming to be satisfied with that, and only desired to be let alone—even promising, unless coals and labor got dearer, to rather reduce than increase the price of gas. Bills were introduced in the City Councils giving the water gas Company the right to lay mains. These were met by other bills extending the formation of the old St. Louis Company beyond its charter, under condition that the price of gas should be reduced in its district. The "ordinances" were quite numerous. Finally one was hatched out by some of the city officials, by which, if passed, the price of gas in the old company's district would be reduced from \$2.50 to \$1.75 per 1,000 cubic feet, and the franchise of that company extended 20 years. At the same time the Laclède Company was to increase the price of gas to its consumers from \$1.50 to \$1.75 per 1,000, and pay the increase of 25 cents per 1,000 sold into the city treasury. Then there was a grand howl of indignation. The Laclède Company's consumers could not see why they should be taxed 25 cents per 1,000 feet of gas used, in order that the old company should do simple justice to its consumers. And the consumers of the old company, while benefited by the reduction, would not be quieted; and the people and newspapers talked, wrote and printed, nothing but gas, gas, gas, and all united in shouting, "Down with the old monopoly!" Nor did the Laclède Company escape condemnation. Its apparent acquiescence in the measure brought down the vials of wrath upon this otherwise popular corporation. The water gas company withdrew its first proposition, taking advantage of the popular feeling, as might be expected, and presented another bill, offering gas at \$1.30 per 1,000 cubic feet if granted the desired franchise. Now, it should be understood that, because of reasons not necessarily stated here, but yet solid facts, water gas cannot be made and sold at St. Louis as cheaply as good coal gas. It is exceedingly strange that the old St. Louis Gas Company did not profit by all the signs of the times. There would seem to be no example in previous gas history like unto the blindness they have so far exhibited, and rarely will we find it paralleled in civil history; certainly, it would seem to me, not until we go back to the antics of the French Bourbons just prior to the great revolution of a century ago.

When the various gas bills were brought up for action in the local "House of Delegates," it was freely charged that the members had been bribed by either the old coal or the new water gas company. It was charged by a member, in open session, that the attempt had been made. An investigation was ordered, and really commenced. Enough was shown that the water gas company had been very free with their offers of stock at very low figures to members of the city councils; but no case was made out, and the committee of the House of Delegates having the investigation in charge abandoned the matter by mutual agreement, just at a juncture when everybody thought something would come of it. The water gas bill was not acted on; but the old company's bill was passed by the "Delegates," and then in the "Upper House" of the Council the bill was laid on the table. As the election for a whole new set of city officials was now at hand, it was finally agreed upon in both houses of the City Councils to take no further action in the gas matter, but to leave the whole question to be settled by their successors in office. All the candidates for office, from the Mayor down, were interviewed as to their standing in relation to the gas question, and their replies to the questions were published. The election is now over, and the whole gas matter will undoubtedly be reopened at an early date.

The foregoing is about as succinct a statement, embracing the whole matter, as could be given. The majority of the people of St. Louis are not at all in favor of the water gas Company; on the contrary, the streets in many portions of the city having been newly paved with expensive material, the people are rather in favor of the older companies. But the persistency and the blindness with which the old St. Louis Gas Company clings to its \$2.50 per thousand schedule maddens the people and makes them almost willing to do anything—even to the point of committing the folly of granting the water

gas company anything it asks for. The universal experience of gas companies, that, by a material reduction in the price of gas, the increase of sales more than compensated the otherwise decreased profits, so that the dividends would not be affected, these people cannot be made to understand or believe. And so they go on fooling and fussing with lawyers, politicians, and kindred spirits, and worrying themselves without cause, when by a reasonable reduction in price they would have more money in the end, and have the people as their friends to.

SPECIAL ENGLISH CORRESPONDENCE.

COMMUNICATED BY NORTON H. HUMPHRYS.

SALISBURY, April 10, 1885.

A report on "Standards of Light" has been prepared by Mr. W. J. Dibdin, F.I.C., F.C.S., chemist and superintending examiner to the Metropolitan Board of Works, in accordance with instructions received from that body some months since. It comprises an elaborate series of experiments made with the standard sperm candle, the Keates oil lamp, Vernon Harcourt's pentane standard, Methven's slit, and Sugg's 10-candle slit. As the result of his experiments, Mr. Dibdin is of opinion that the public "are now in possession of four reliable substitutes for the candle as a standard of light;" but in the main principle it comes down to two—viz., the substitution of oil, as in the Keates lamp, or of air gas, as in the apparatus proposed by Harcourt, Methven, and Sugg respectively. There is, however, a marked difference between Harcourt's plan of taking a flame burning from a round hole, and that followed by Methven and Sugg, which consists in using an ordinary Argand burner, and intercepting a portion of the flame by means of a screen. In the selection of one of these four as the standard, however, there seems some likelihood of *embarrasse du richesse*. Mr. Dibdin evidently prefers the Keates oil lamp; he does not, however, recommend that this should be adopted to the exclusion of the other proposed standards, but suggests before any one of these substitutes for candles is accepted as the standard of light that a systematic series of tests be made with them, by means of a four-way photometer, for the purpose of determining, under conditions beyond all question, which in practical working gives the most uniform results and the closest approximation to the legal standard at present in use in this country. Such a test would certainly afford useful information; and to avoid possible dispute each standard might be manipulated by its particular champion. Mr. Dibdin, for example, might operate with the Keates lamp; Messrs. Hartley and Hirsch with the Methven slit; Professor Vernon Harcourt might with the pentane test; and Mr. Sugg might follow with his 10-candle slit. I do not know who would take the sperm candle, for these authorities, however much they may differ as on other points, all agree in condemning the candle, and being anxious to give it a parting kick. Such an experiment might perhaps settle the question of a light standard to the satisfaction of the Metropolitan Board of Works; but really there are so many different standards in the field that anything like an international agreement on the subject (which has recently been suggested) seems perfectly hopeless. This appeared to be the position of affairs when the subject was considered in Paris a few years ago. Even if the claims of these four standards, proposed in connection with coal gas, could be satisfactorily adjusted, there are many others that have been suggested from time to time. Besides various combustibles there have been units of melted platinum and silver, and various arrangements of incandescent electric lamps, and many other arrangements, brought forward as improvements on the sperm candle. Even in regard to a standard for determining the lighting value of coal gas—which is a considerable narrowing down from the general question of a unit of light suitable for any kind of scientific illumination, and analogous to the units applied to heat and electricity—it seems likely to remain a case of "doctors differing." A committee appointed by the Board of Trade lately reported in favor of the pentane standard, and a committee appointed by the Gas Institute expressed a preference for the Methven slit; and now we find Mr. Dibdin taking up a central position, but with a little inclination toward the Keates lamp. So the matter stands, and is likely to remain until the general state of knowledge respecting the mechanical and chemical properties of light has advanced substantially beyond its present stage; and until a greater degree of unanimity prevails as to the substitute for the candle, it seems possible that this much abused standard will maintain its position as the legal unit of light.

Mr. Thomas Fletcher, of Warrington—who delivers so many lectures that one wonders when he finds time to invent gas appliances, and invents so many gas appliances for heating, cooking, and special technical purposes that we may well speculate how he possibly finds time to prepare his lectures—has recently given a lecture on "Smokeless Houses and Manufactories," under the auspices of the Smoke Abatement Institution. He said that his principal business that night was to give actual results obtained in his own works and house, which were and had been for a long time prac-

tically smokeless. Mr. Fletcher has entirely banished coal from his house, and gas supplies all requirements for fireplaces, water heating, bath heating, washing, drying, ironing, cooking, and general domestic purposes. This has been accomplished with no alterations other than those inherent to the laying on of ample sized gas supply pipes. The first cost of the whole of the appliances he estimates at £26, and his gas bill for twelve months, with gas at 3s. 3d. per thousand cubic feet, has been about £22; showing a consumption of 130 to 140 thousand cubic feet of gas. "The work has been done in a style impossible with coal, at about the same cost, and with a great saving in dirt, servants, and inconvenience." With the gas appliances he has been able to have fires in the bedrooms each morning and evening, if necessary, to say nothing of many other advantages.

Well done, Mr. Fletcher! Let us hope you will long live to enjoy the comforts of gas appliances in your own home. And, by means of lectures and improved appliances, to call general attention to the advantages of gas both for domestic and technical purposes. Facts such as the above are more likely to aid the objects of the Smoke Abatement Institution than the proposed tax on fireplaces, the enforced use of anthracite coal, and other methods that have at times engaged the attention of its zealous but sometimes rather impractical supporters.

The Glasgow Gas Corporation recently appointed a special sub-committee to "consider and report on the whole question of the utilization of gas for other than illuminating purposes, more especially as applied to domestic heating and cooking, and to make such recommendations as they might think suitable to be adopted in Glasgow, with a view of promoting the more general use of gas for domestic and trade purposes." The committee have gone to work energetically, personally visiting many of the principal towns in England and Scotland, besides sending out letters of inquiry; and with the aid of the information so acquired, they have presented a report which attains almost to the proportion of a treatise on the present position of the subject. It is needless to add that the whole of the evidence collected is favorable to the system of letting stoves on hire. The report, of course, includes much with which gas engineers are already acquainted through the medium of their serial literature; but it may be commended as a useful work for the use of directors of gas undertakings, or members of gas committees, as it sets forth the advantages of promoting a day consumption of gas, both to the vendors and consumers. Remembering that so many gas companies and corporations have had the hiring system in successful operation for so many years, it seems rather late in the day for such an important town as Glasgow to be collecting information on the subject. I notice that several other Scottish towns are turning their attention to the subject of offering every facility for increased summer and day consumption.

An action recently tried at the Hereford County Court illustrates a disadvantage that has frequently been brought forward as an objection inherent to the discount system, but which really arises in practice. If an allowance is made for prompt payment, it stands to reason that it must be confined by a hard and fast line, within a limited time; or otherwise it will soon become a dead letter. The usual practice in this county is—discount allowed if paid within a month after the quarter day. The Hereford Corporation, as owners of the gas works, sued a consumer for a small sum, being the amount allowable as discount on a quarter's consumption, which amount they alleged that the defendant had forfeited by not paying his account within the stipulated time. The defendant alleged that he had always paid the gas accounts promptly, but with regard to the one in question, it was not delivered until within a day or two of the expiration of the discount period; and that he had paid it, less the discount, within nine days of the delivery. In point of law the Corporation was correct, and of course they obtained a verdict. Whether it is advisable in these matters to rigidly abide by a hard and fast rule is an open question. The assertion that the account was not delivered until a day or two before the latest date for discount was not disputed, and the usual practice appears to have been the allowance of a few weeks between the delivery of the bill and the expiration of the discount period; so the defendant is certainly entitled to some share of sympathy. Where a consumer is known to habitually attempt the evasion of the discount rule, harsh measures may perhaps be advisable; but the case assumes a different complexion when the default is committed by accident, on the part of an habitually punctual payer, and especially when the oversight is abetted by an irregularity in the delivery of an account. Under such circumstances an exception can be made without fear of establishing a precedent, and probably the Hereford Corporation will eventually find that their best policy would have been to have let the matter drop, and taken care to present their accounts promptly in future. I take it that the prompt rendering of accounts is the backbone of any discount system.

The verdict in the case of Sugg vs. Bray, mentioned in my letter that appeared in September last, has just been declared. After taking eight months to consider his judgment, Mr. Justice North has announced as his decision that the action is to be dismissed without costs, and promised to give his full judgment later on. So it cannot be said that the matter has been un-

duly hurried. Indeed the legal proceedings first commenced nearly four years since, and it is said that the entire cost on both sides approaches to £20,000. It will be interesting to read the reasons which have led the learned judge to this decision, for, in a case of this sort, a judgment of "dismissed without costs" is not without some similarity to the celebrated verdict of the Welsh jury—"not guilty; but don't do it again."

Now that the cost of incandescent electric lighting is calmly and judiciously investigated, there is overwhelming evidence that this system can never compete successfully in a pecuniary sense with gas; and the utter fallacy of the extravagant assertions that were advanced, and in many quarters accepted as fact, is now fully established. A paper recently communicated to the Physical Society, by Professors Ayrton and Perry, embodies some interesting information as to the best and most profitable methods of working incandescent lamps, the results of practical experiments at the Finebury Technical College, with Edison 16-candle lamps. The best result obtained by these well-known and acknowledged experts was 11d. per candle power for a period of 560 hours, and the cost of maintaining a 16-candle light for that period would be 14s. 8d. The quantity of coal gas required to maintain a light of similar power would be 5.0 cubic feet per hour, and this could be greatly reduced by using modern improved burners. But taking it at 5 cubic feet, the total quantity of gas required would be 2,800 cubic feet. So the above result is equivalent to something more than 5 per cent. per 1,000 cubic feet for gas, or an approach to double the price at which it is actually sold. If experts, working under the most favorable conditions, fail to realize a marked economy as compared with coal gas, it seems out of the question to attempt to realize such in practical working. It usually happens, too, that the estimates of these scientific gentlemen are deficient in the matter of repairs, establishment charges, etc.

ITEMS OF INTEREST FROM VARIOUS LOCALITIES.

A CHAPTER FROM MORRISTOWN (N. J.) GAS RECORDS.—MORRISTOWN, N. J., takes high rank amongst the numerous beautiful townships that are located within short distance of or right close to the steel ways of the D. L. & W. Railroad. The quiet waters of the Whippany river ripple over its course pretty much as they did during the war of the Revolution, over 100 years ago, or when Morristown gave shelter to the sorely-tried patriots of '76. The township has hardly been true to its promise of some 25 years back, when it bid fair to become a manufacturing center of considerable importance; but it would seem as though New Brunswick had attracted the tide of trade that was to come. Even though Morristown's growth has been retarded, it is still a bustling township, and signs of business progress have again manifested themselves. To show that the quickening hum will be fostered by the old Morristown Gas Light Company is the purport of this item, and the following details will convey how the corporation's managers propose to do it. The company celebrated its thirtieth birthday on the 19th of last February, and we are sorry to be obliged to chronicle the fact that shortly thereafter Mr. H. B. Stone resigned the Superintendency, being impelled to such a step on account of failing health. For years Mr. Stone has been the active agent in the direction of the company's business affairs, and probably in strict justice to himself he should have retired from the company's service at an earlier period than the one above noted. He has been a patient sufferer, and it is to be hoped that rest and quiet will bring him health and strength. With the beginning of '85 Dr. E. B. Woodruff, President of the corporation, considered that the time had come when the plant should be improved and enlarged, and to do so intelligently the amiable Doctor called to his aid the counsels of two engineers thoroughly competent to give him a fair and square opinion on the subject, with the result that, when the betterments are finally completed, the Morristown Company will have a first-class coal gas plant. Mr. Stone's resignation necessitated the engaging of a Superintendent, and Mr. H. M. Hunt, formerly in charge of the Hempstead (J. I.) Gas Works, was chosen as Mr. Stone's successor, Mr. H. taking control of Morristown works on April first. On same date the directors authorized the new superintendent to make the announcement to consumers that from and after date of April 1st the selling price of gas would be reduced to \$2.50 per 1,000 cubic feet. The former price was \$3. This is what we expected, and have no doubt, when the alterations and extensions spoken of above are carried out, that we shall hear of a still further step in the right direction.

SPONTANEOUS COMBUSTION DESTROYS A PILE OF GAS COAL.—At the old station of the Boston (Mass.) Gas Light Company's works a bad case of spontaneous coal combustion was developed about three weeks ago. The company had about 20,000 tons of coal stored under one shed, and when the discovery of its heated condition was made the combustion had made such progress that it took a long while to master it. One estimate given places the quantity of coal destroyed at about 5,000 tons. The loss is quite a serious one.

AN ACKNOWLEDGMENT.—We desire herewith to acknowledge an invitation received by us from J. W. Allison, President of the "Cotton Seed Crusher's Association," to attend the annual convention of that organization, held at New Orleans, La., on Tuesday, April 21st. While we could not make the trip, we are obliged for the courtesy extended, and hope that Bro. Jackson and his associates had a successful re-union. Mr. Allison is also President of the Jackson (Tenn.) Gas Light Company.

IT MUST BE A JOKE.—A despatch to the daily papers, dated Philadelphia (Pa.), April 11th, says: "In consequence of frequent complaints of consumers that their gas bills are enormously high, the trustees have ordered an investigation into the competency of the firm who secured the contract to make the meters to ascertain whether or not the workmen are skilled mechanics." Now, we do not submit the above "despatch" (it is taken from the columns of the New York *Tribune*) either as a model of composition or as a specimen of terse diction; but we would ask if the *Tribune's* correspondent at Philadelphia is inclined to be "funny?" The Goodwin Company has supplied in past times large "lots" of meters to the Trust, and if the company's men did "strike," and did join the "Knights of Labor," we never heard aught said against them as skilled mechanics in their particular line of work; so the reported resolution (as claimed above) passed by the Trust can have no reference to the Goodwin folks. On the other hand, the successful bidders of this year (Messrs. Helme & McIlhenny) justly enjoy as good reputation as any other firm of meter makers in this country are possessed of—we have known them both for years, and the older the acquaintanceship grows the firmer does it become—and so the resolution can have no reference to them. Take it all in all, it must be a joke; and could probably have its origin traced back to the "brilliant brain and fertile pen" of some one of the numerous "comic journalists" located in and about the Quaker city.

HANNIBAL (MO.) GAS LIGHT COMPANY REDUCES SELLING RATES.—In our last issue mention was made of the annual meeting of the American Water Works Association, news of which event had been forwarded us by the Secretary, who is also none other than the Superintendent of the Hannibal Gas Light Company. Mr. Decker, even though he has always been prominently identified with the above-named Association, has not in any sense overlooked or forgotten the niceties of gas management, and he is just as active and spry in these departments as ever. He has succeeded in imbuing the minds of the Hannibal directors with the idea that cheap gas is a good thing, and since he assumed charge of the works four reductions in price have been made to consumers—the last of the four bearing date of April 5, 1885, when the managers empowered Supt. Decker to proclaim the fact that all consumption registered from first day of April would be subject to a gross charge of \$2.50 per thousand, with a scale of discounts graded as follows: On monthly bills of less than \$25, 5 per cent. off; monthly accounts between \$25 and \$100, 10 per cent. off; a 15 per cent. reduction to be granted on a monthly consumption exceeding \$100 in value. The discounts only to apply when settlements are made on or before sixth day of month in which bill is presented. Mr. Decker is determined to secure a goodly day consumption with the coming summer, and to that end is making an intelligent canvass among the inhabitants of his city. Gas stoves are to be supplied, and the necessary fittings therefor put in, at net cost. He also offers to replace defective or worn out burners *without charge* for materials or substitution. This latter is a plan that should be followed by every medium sized company in the country; and the same practice would not do the "big ones" a bit of harm. The "official" notification of reduction concludes with the following plain statement: "We would remind you that your liberal consumption will make *cheap gas*, and this company stands ready to make the price of gas as low as the amount of sales will warrant." That is the way to talk, Brother Decker.

KILLED BY THE ELECTRIC CURRENT.—At Chicago, Ills., on evening of April 22, Charles B. Shultz, an electrician, stood on the top round of a ladder, at a height of 14 feet from the sidewalk, adjusting the carbon points in a dimly burning electric lamp located at corner of Clark and Madison streets. Losing his balance, he grasped both rods supporting the lamp, and through which the current was passing. He could not loosen his hold, but hung writhing and swaying with the swinging motion of the lamp until the engine actuating the dynamos was cut off. With the stoppage of the current the unfortunate man fell to the sidewalk a corpse.

TORONTO (ONT.) TO HAVE CHEAPER GAS.—Despite the fact that the Dominion of Canada has been more or less (generally "more") perturbed over the operations of the Half-Breed Riel, the "Camek" gas men do not appear as very greatly scared, since they are paying attention to their business, and are "doing the square thing by their consumers." On April 22 Mr. W. H. Pearson, Secretary to the Consumers Company of Toronto, forwarded us the

information that the directors, at a meeting held April 20, gave him authority to inform the patrons of the corporation that all gas used for illuminating purposes from April 1st would be reduced in accordance with the annexed schedule—the discounts only to apply in cases of prompt payment: Ordinary consumers, \$1.50 net—previous rate being \$1.60; consumers burning an annual quantity reaching or exceeding 200,000 cubic feet to be furnished their supply at \$1.30—previous rate \$1.35. The reduced rate at which gas for cooking, heating, and power purposes (\$1.25) was supplied has not been changed. The Consumers Company makes no rental charge on meters. Mr. Pearson's letter to us also conveys the pleasing intelligence that during the past six months his company's consumption has increased at a greater ratio than ever before, and this gain has been made in face of the efforts of the electric lighting promoters. Quite a number of the customers of the Consumers' Company who, for a period, used electricity exclusively, have come back to gas; Mr. Pearson also finding that the "missing sheep," once they did return to the true fold, now burn more gas than before their temporary alienation. "Let them alone, and they'll all come home," etc. Mr. Pearson always was a consistent advocate of cheap gas.

TRYING TO FIX GAS PRICES AT SAN FRANCISCO, CAL.—The San Francisco (Cal.) Board of Supervisors lives in the gas man's memory as the "municipal body" that let San Francisco's streets remain in darkness (rather than pay the people who did the lighting) some two or three years ago. We have never been informed as to whether the San Francisco Gas Light Company got the back moneys due it for street lighting at that period; and right here we might complain a trifle about the dereliction of our Pacific Coast friends in "posting" us on what is going on in gas circles out "in the land of the setting sun." At any rate, the lighting committee of this progressive body of public representatives, during a session held on April 8th, were engaged in an attempt to fix the price to be charged for gas at an all round figure of \$1.75 per 1,000; and this they sought to do under what is known as the "Coffey Act." Strange that legislators bearing the name of "Coffey" should be so anxious about "fixing" gas prices. There is our own "Coffey," up at Albany, who thinks he has given sufficient grounds for settling the price at which gas should be sold in the larger cities in the Empire State; still there is the probable danger (to him) that the strain upon him will be so great as to upset his pot; but, of course, that remains to be yet made clear. We are not cognizant as to the peculiar provisions of the California "Coffey Act;" but President J. D. Crockett's reasons for opposing the "fixing" of gas prices in San Francisco, at the scale proposed, were given as follows: The average price of caking coal there is \$6.96 per ton, and shale for enriching comes at \$11; stokers are paid \$3, and helpers are paid \$2.25, per day; and so it goes all through the list. To sum the thing up, the prices entering into cost of manufacture are, as whole, 35 per cent. higher than in the East. We believe the committee finally agreed to report back to Board on a \$2 basis. Would Mr. Crockett kindly let us know what determination was reached?

EXTENDING MAINS AT LONG BRANCH, N. J.—The new management of the Long Branch Gas Light Company are making extensive additions to plant capacity. About the most important item in connection therewith is the lengthening of the conduit system, the contract for same having been awarded to Mr. T. E. Crimmins, of New York city. We understand that Mr. Crimmins' contract calls for the placing of about six miles of eight-inch pipe, and the work was to have been started in on Tuesday, April 28th.

HUNTSVILLE (ALA.) GAS COMPANY AT THE SAME WORK.—The Huntsville Gas Light Company, Mr. J. W. Murdock, Supt., is putting underground 5,000 feet of eight-inch main. The capital stock of this company is only \$36,000.

ITS EPITAPH WRITTEN.—The Tucson (Arizona Ter.) Electric Light Company has closed down indefinitely, and for the very good reason that every 24 hours continuance of business but added to its financial difficulties. The managers are apt to vouch for the truth of the statement that electricity is but "the light of the future."

TRYING TO INDUCE THE POUGHKEEPSIE COMMON COUNCIL TO TRY ELECTRIC STREET LIGHTING.—"The American Electric Illuminating Company" is apparently very anxious to "illuminate" the streets of Poughkeepsie, N. Y., with its carbon points. As a starter the managers made a proposition to Common Council that they be authorized to put up 25 lights at such points as the authorities might designate, the price for each to be placed at \$182.50 per annum. The Citizens Gas Company is now doing the lighting, and for the ensuing year proposes to bid for a continuance of the work at the rate of \$31 per post—or a total sum (there being 621 lamps) of \$19,251. Last year the Citizens Company paid into the city treasury, as taxes, the sum of \$3,750, while the electric company with the "big name" is only on paper yet; still its promoters come smilingly forward with their proposition. To

show the saving that might be expected in case of a change from gas to electricity, Alderman Owen, during the informal discussion on the question, said that the lighting of avenue leading from the Post Office to Eighth Place by arc lamps would annually cost \$1,297.50; whereas the expense for gas was but \$341. Ald. Corcoran said the people were well satisfied with the present system, and the only parties desiring the change were those interested in the electric company. No positive action, up to last advices, was taken on the proposition.

ANOTHER REDUCTION IN GAS RATES AT NORTH ADAMS, MASS.—At the annual meeting of the North Adams Gas Light Company (April 6th) W. L. Brown was chosen President; F. S. Richardson Treasurer; and A. D. Cady Secretary. The results of reduction made about a year ago were so gratifying to the directors that Mr. Richardson had no trouble in persuading the management about the good policy of "going still lower." The price to ordinary consumers was reduced from \$2.50 to \$2.25 per 1,000; consumers of over 20,000 cubic feet per month to get their supply at \$2.15. The lower rate will also be made to apply to all consumption of gas for other purposes than lighting. The mill proprietors of North Adams (there are a number of them in that city) get a further concession of 20 cents (\$1.95) per thousand. Despite the efforts of a local electric lighting company, the business outlook of the North Adams gas man is decidedly promising. Brother Richardson evidently means that it shall continue so.

MILWAUKEE (WIS.) HEARD FROM.—The price of gas at Milwaukee is to be lowered from and after July 1st, 1885. Particulars will be given in next issue.

THE DEATH ROLL; CASE No. 1.—A man named Geo. Harris, a temporary sojourner at the Pacific House, Quincy, Ills., "blew out the gas" before retiring, on night of Sunday, April 5th. Next day he was found in an unconscious condition. He was removed to the Blessing Hospital, where he remained in a state of insensibility which ended in death on night of 8th. Wm. Ketha and wife were overcome by gas, on night of April 9th, in their apartment in Quincy House, Ills. Early following morning the couple were found unconscious, and gas was escaping into the room from a turned-on burner. Dr. Byrd succeeded in reviving them. They owe their escape to the fact that a window to the apartment was but partially closed.

CASE No. 2.—Mary Harrington, a domestic in the employ of Mr. Geo. S. Curtis, residing at No. 167 W. 130th street, this city, went to her sleeping room on night of April 15th last, and before going to bed "blew out the gas." The tracing of an escape of gas to her room developed the fact that she had been asphyxiated during the night. The body was removed to the Morgue.

CASE No. 3.—Wm. Ahearn, an inmate of the Putnam House (located at 369 Fourth avenue this city), and registered as coming from Woodbridge, N. J., "blew out the gas" on night of 23d April. Next morning he was removed to Bellevue Hospital, where his demise ensued on Friday, 24th.

CASE No. 4 IS A SURPRISE.—At last we have a death from coal gas inhalation. The case reported is that of H. W. Ash, of Steuben, Me., who, while on a visit to Rockland, in same State, put up at the Thorndike House, on date of April 3d. Ash had been indulging in alcoholic stimulants, and according to the testimony developed at the inquest it was concluded deceased had, after retiring to bed, been obliged to relieve his stomach—the state of wash basin showed this, as also did the bed linen—and that in shutting the burner key off he inadvertently turned the gas supply on again, his dazed condition preventing timely discovery of the fact. Coal gas is made at Rockland.

SHE RECOVERED.—Mr. Marcus Smith, Secretary Wilkes-Barre (Pa.) Gas Company, writes us to say that the "special" to New York papers (published as "Case No. 2," in April 16th issue) was in error in so far as it reported the death of the domestic, Kate Schlessinger. Mr. Smith says that all of the sufferers in the Wilkes-Barre prostration of April 5th "speedily recovered." We are glad of it.

WHAT ELECTRIC STREET LIGHTING MAY COST NEW YORK CITY.—An estimate of the cost of lighting the city by gas and electric light was submitted to Aldermen on April 24th, by Mr. S. McCormick, Supt. of Lamps and Gas. It appears the 647 arc lights now in use cost \$165,308 per annum, and the gas lamps so displaced would cost but \$52,780. Council resolutions call for 2,093 additional arcs, the total cost of which would be \$537,761; these would displace gas lamps that could be maintained at an annual expenditure of \$93,537. Should the arcs ordered be put up their total cost to city would be \$700,700. The city's gas bill would yet reach \$350,616, making a grand total of close on to \$1,100,000. Mr. McCormick reports that the only advantage he can discover in the arc system over gas is that of instantaneous lighting. Corporation Counsel Lacombe has informed Commissioner Squire that the law of 1834 prohibits the stringing of any additional wires on poles now in use. If the electric companies be authorized to lay on additional lights they will have to bury the wires. [The Gas Commission awarded the contracts on April 28th. We will give them in next issue.]

The Market for Gas Securities.

As advised by us at time of last market report, Consolidated gas purchased at the then ruling rate proved a decidedly "good thing." Between dates of April 15th and 30th about 8,000 shares changed hands, opening price on April 15th being 83 bid; opening price (sales made too) on 30th, 90½. The Senate bill for creation of a Gas Commission for New York city was defeated in Assembly on afternoon of April 30. Noon quotations for Consolidated are 90 bid, offered at 91. Equitable gas is remarkably strong at 113 bid. Mutual is also higher, 126 bid.

Nassau gas, Brooklyn, has declared and paid a dividend of 2 per cent.; Fulton Municipal has paid one of 2½ per cent. Baltimore Con. is fairly steady at 54 to 55. Huntsville (Ala.) Gas Company earns and pays an eight per cent. return per annum. It is reported from good sources that the Fulton Municipal managers are contemplating a raid upon the Flatbush (L. I.) Gas Light Company. They propose, according to the rumor, to extend a main out along Flatbush avenue, and compel the Flatbush Company to supply its consumers with the most approved article of carbonic oxide.

Ammoniacal Liquor.

PROPOSALS will be received up to NOON OF SATURDAY, MAY 9TH., 1885, for the **Ammoniacal Liquor** produced at both works of the **Cincinnati Gas Light and Coke Company**, for a period of **FIVE YEARS**, from July 1, 1885, to July 1, 1890.

The old works are supplied with Tower Scrubbers, the new works with "Standard" Washer-Scrubbers. Bids will be received for the entire product, based on tons of coal carbonized or on quantity and strength of liquor furnished.

H. W. SAGE, Secretary.

FOR SALE.

A 3-4ths Interest in Mattoon Gas Co.

Mattoon, Ills., is a flourishing town of about 8,000 inhabitants. Party wishes to sell on account of health. Address 621-2t **MATTOON GAS CO., MATTOON, ILLS.**

Appointment Desired,

By a graduate of the School of Mines of Columbia College, in a **Water Gas Works** in or near New York city. Speaks English and German. Age, 22 years. Address **O. BODELSEN, 618-4t 1072 Tenth Avenue, N. Y. City.**

WANTED,

Second-Hand Gas Works Apparatus.

Hydraulic Main, Dip, Bridge, and Stand Pipes for a hench of sixes; Four Purifying Boxes, with either 6 or 8 inch seal and connections. The material must be in good condition. Address **619-4t E. McMILLIN, Columbus, Ohio.**

FOR SALE,

One Station Meter,
Capacity, 500,000 feet.

Four Purifiers,

16 ft. by 16 ft. by 4 ft., with trays, covers, carriages, and 10 in. connections complete.

One Dry 10-inch Center Seal, 10-inch Gas Valves, and Cast Iron Pipe.

All in good condition. Address **E. McMILLIN, Columbus, Ohio.**

FOR SALE,

100 MINER GLOBE STREET LAMPS.

The lamps have been in use, but only those that are in good order are offered for sale. For terms, etc., address

THE NEW YORK & NEW JERSEY GLOBE GAS LIGHT CO., 615-tf No. 1 Park Place, New York City.

For Sale at a Bargain.

COMPLETE 4-INCH GAS GENERATING APPARATUS,

From our old works. Iron Frame for Roof; Mouthpieces, Stand Pipes, etc., etc.

Just the thing for adding to capacity of works already in operation, or for starting a new works. Address

616-St GAS COMPANY, LIMA, OHIO.

W. H. DOAN,

REFINER OF

NAPHTHA and GASOLINES

ALSO MANUFACTURER OF

A Special Grade of Naphtha for Gas Companies

FOR ENRICHING COAL GAS.

Correspondence solicited.

No. 43 Euclid Avenue, Cleveland, Ohio.

WELSH "ABERNANT"

Silica Dinas Fire Brick & Cement.

Unrivalled for Endurance Under Intense Heat. Percentage of Silica, 95.64.

Also SCOTCH "BLOCHAIRN" FIRE BRICK.

A. T. CHUR,

SOLE AGENT FOR THE UNITED STATES,

Mills Building, Room 14, Fifth Story, New York.

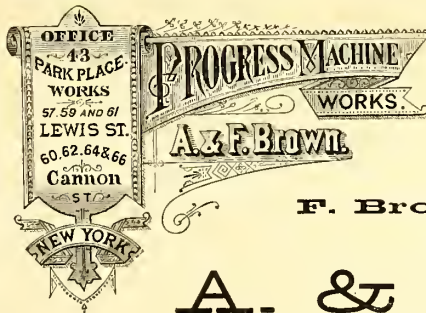

Shafting, Pulleys, HANGERS.

F. Brown's Patent Friction Clutch.

Send for Illustrated Catalogue and Discount Sheet to

A. & F. BROWN,

No. 43 Park Place, New York City.

Pipe Coverings.

Fireproof, Non-Conducting Coverings for **STEAM PIPES, BOILERS, And all Hot Surfaces.**

Made in sections three feet long. Easy to apply; light and cheap. Asbestos Materials, Fibre, Braided Packing, and Cement. These goods are used at Continental Works, Br'klyn. **CHALMERS-SPENCE COMPANY, 419 & 421 EIGHTH ST., N. Y.**

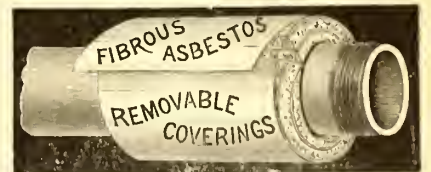

Parson's Steam Blower,

FOR IMPROVING BAD DRAUGHT IN BOILERS, AND FOR BURNING BREEZE OR OTHER WASTE MATERIAL.

PARSON'S TAR BURNER,

FOR UTILIZING COAL TAR AS FUEL.

PARSON'S AIR JET TUBE CLEANER,

FOR CLEANING BOILER TUBES.

These devices are all first-class. They will be sent to any responsible party for trial. No sale unless satisfactory. Manufactured by the **WATERTOWN STEAM BLOWER COMPANY.**

H. E. PARSON, Supt., 42 PINE ST., N. Y.

It will "Pay the Piper,"

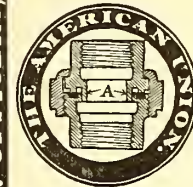

If he aims to pipe well for STEAM, WATER, GAS, ACIDS, OILS, AMMONIA, &c., to examine this UNION, which requires no packing, but is always ready for instant use. When you next order Fittings of any Dealer, ask for a sample American Union to come with them, and it will tell you the whole story, or we will, if you write us for particulars.

PANCOAST & MAULE, PHILADELPHIA, PA.

GAS CO. OFFICERS,

READ AND REFLECT.

HODGE'S UNIVERSAL ANGLE UNION, Pat'd

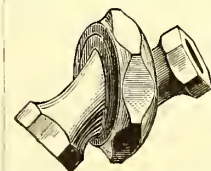

A new and important Pipe Fitting for Steam, Water, or Gas. Combining a variable angle or elbow and a union. Saves pipe, saves time, decreases friction and radiation, gives a union joint at every angle, and can be set at any angle at which it is desired to run the pipe.

HODGE'S SWIVEL FLANGE,

A common sense article, designed to save time and money.

MANUFACTURERS AND WHOLESALE AGENTS,

ROLLSTONE MACHINE CO.,

142 Water St., Fitchburg, Mass.

Iron Sponge,

GAS EXHAUSTERS,

AUTOMATIC GAS GOVERNORS,

CONNELLY & CO., Limited,

No. 407 BROADWAY, NEW YORK CITY.

THE CLERK GAS ENGINE.

Highest Award American Institute, New York, 1883. Silver Medal American Institute, N. Y., 1884.

Gold Medal Awarded Crystal Palace Electrical Exhibition, London, 1882.

Highest Award for Motive Power British Section International Exhibition of Electricity, Paris, 1881.

Reliable.

Economical.

No Boiler.

No Engineer.

Steady.

No Explosion

No Coal.

No Gearing
Wheels.

Simple.

No Danger.

No Ashes.

No Parts
requiring
frequent
renewal.

Compact.

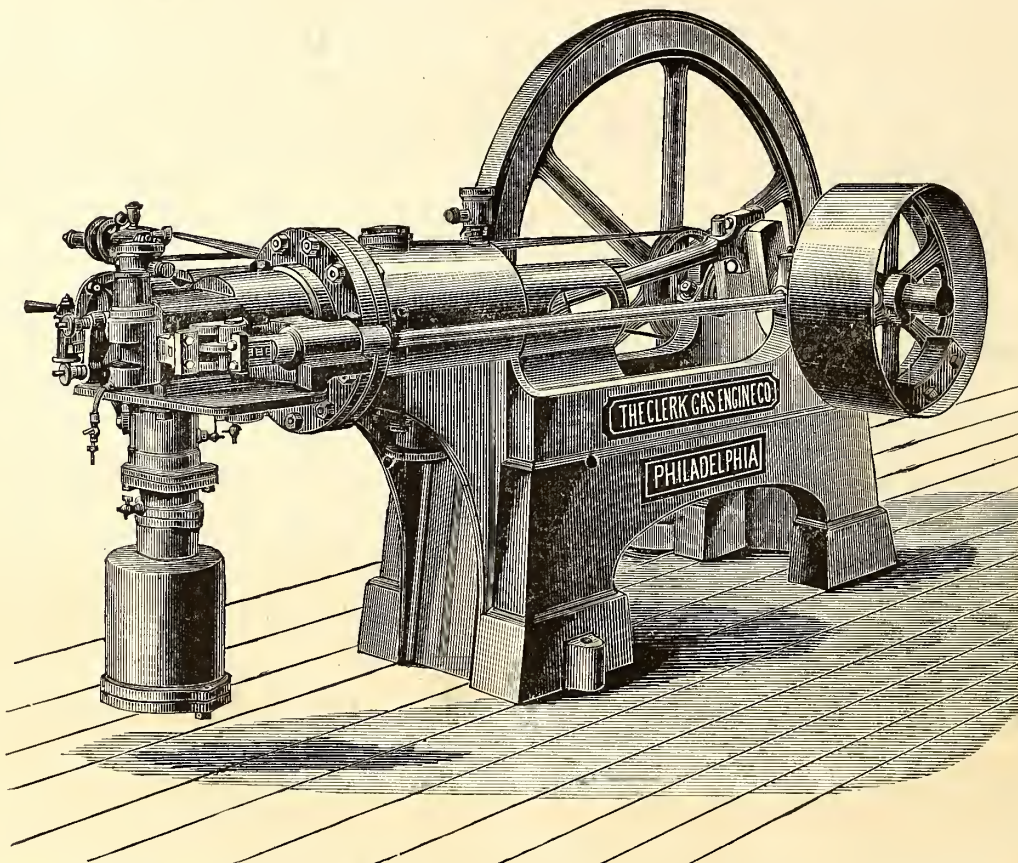

REQUIRING ONLY A MATCH TO START IT--GIVING ITS FULL POWER IMMEDIATELY.

We would inform the public that during the last few months we have improved THE CLERK GAS ENGINE to such an extent that we can now offer an engine vastly superior to our former pattern. These improvements have enabled us to sell our engine at a GREATLY REDUCED FIGURE, partly on account of the decreased weight (our engine weighing about half that of others giving the same Brake H. P). The consumption of gas has been decreased to a considerable extent, and the Brake H. P. has been increased some 25 to 30 per cent. All parts of the old design that were considered defective have been remodeled and new designs added. We now have an engine second to none as regards power, consumption, and ease of working. With our new engine all trouble in starting has been removed, the noise reduced to a minimum, and the regularity of motion is now all that can be desired. We guarantee all we claim for it, and the material and workmanship being of the best, enables us to guarantee the engine for twelve months.

SOLE MAKERS,

THE CLERK GAS ENGINE CO.,

WM. W. GOODWIN, President. E. STEIN, Secretary. S. LEWIS JONES, Asst. Secretary. L. P. GARRET, Supt.

Main Office, 1012-1018 Filbert Street, Philadelphia, Pa.

BRANCH OFFICES,

142 Chambers St., N. Y.

4 West Fourteenth St., N. Y.

76 Dearborn St., Chicago.

General Agents,

THE GOODWIN GAS STOVE & METER CO.,

Of Philadelphia, New York, and Chicago.

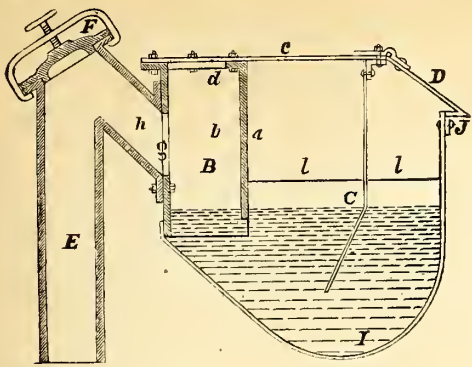

Boardman Hydraulic Main,

Patented October 7, 1884.

For description, see AM. GAS LIGHT JOURNAL of Feb. 2, 1884.
For terms, apply to

A. E. BOARDMAN, Macon, Ga.

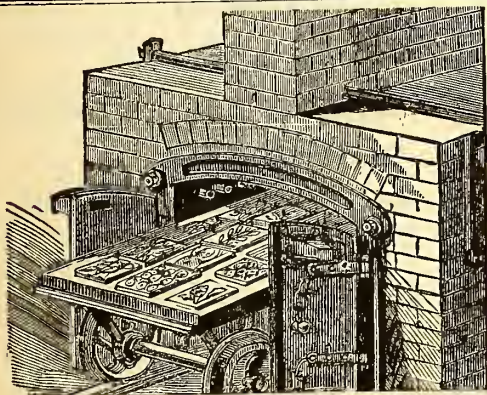

Glass-Staining Gas Kiln.

BAKERS' & CONFECTIONERS' OVENS (PAT.)

Thompson Gas Kiln & Oven Co.

59 Carmine St., N. Y.

Send for Circular by mail.

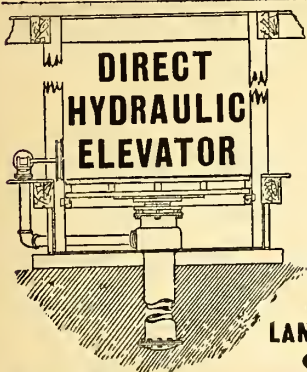

DIRECT HYDRAULIC ELEVATOR

With Iron or Wood Platform.

Largely used by Leading Gas Co.s for Coal and Coke Lifts.

Adapted for use with city service, or special pumping and accumulator system. For prices address the

LANE & BODLEY CO., Cincinnati, O.

WM. FARMER, ENGINEER,
32 Park Place, Room 36, New York.

THE CHEMIST'S ASSISTANT; OR, KINDERGARTEN SYSTEM OF CHEMISTRY.

A system by which the elements and their valences are represented by illustrations and solid bodies.
BOX AND PAMPHLET COMPLETE, \$2.50.

MITCHELL. VANCE & CO.,

MANUFACTURERS OF

Chandeliers

and every description of

GAS FIXTURES.

Also manufacturers of Fine Gilt Bronzes and Marble Clocks warranted best time-keepers. Mantel Ornaments, etc.

Salesrooms, 836 Broadway, N. Y.

Special Designs furnished for Gas Fixtures for Churches, Public Halls, Lodges, etc.

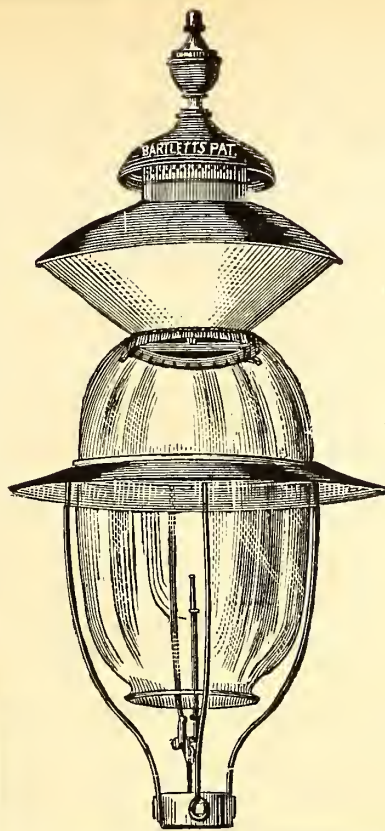

C. BARCALOW, PREST.

J. V. BARCALOW, SEC. & TREAS.

BARTLETT
Street Lamp Mfg. Co.

MANUFACTURERS OF

Bartlett's Patent

GLOBE LAMPS.

FOR

Streets, Parks, Railroad Stations, Public Buildings, Etc.

LAMP POSTS A SPECIALTY.

Office and Salesroom,

No. 35 Howard Street, N. Y. City.

Gas Companies and others intending to erect lamps and posts will do well to communicate with us.

F. M. ROOTS.

S. C. ROOTS

D. T. ROOTS.

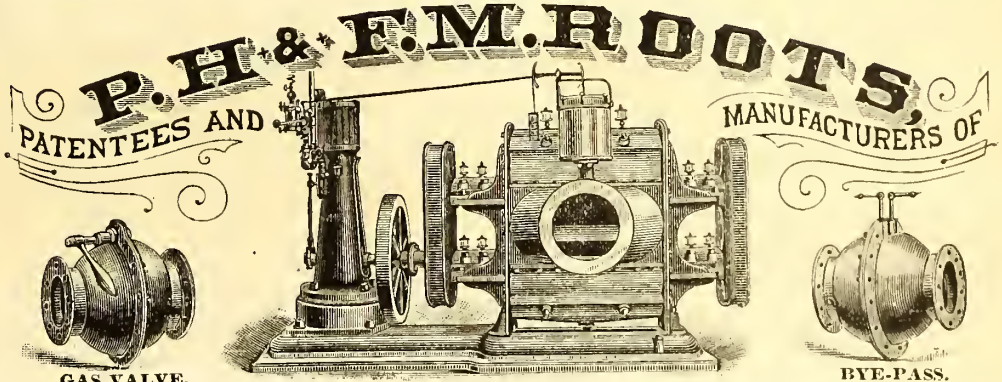

GAS VALVE.

BYE-PASS.

IMPROVED GAS EXHAUSTER,

WITH ENGINE ON SAME BED PLATE, OR WITHOUT.

BYE-PASSES, GAS VALVES, GOVERNORS, ELBOWS, PIPE-FITTINGS, Etc., FURNISHED TO ORDER,

P. H. & F. M. ROOTS, Patentees & Manufacturers, CONNERSVILLE, IND.

S. S. TOWNSEND, General Agent, 22 Cortland St. and 9 Dey St., N. Y.

JAS. BEGGS & CO., Selling Agents, 9 Dey St., N. Y.

COOKE & CO., Selling Agents, 22 Cortland St., N. Y.

✧ SEND FOR ILLUSTRATED CATALOGUE AND PRICE LIST. ✧

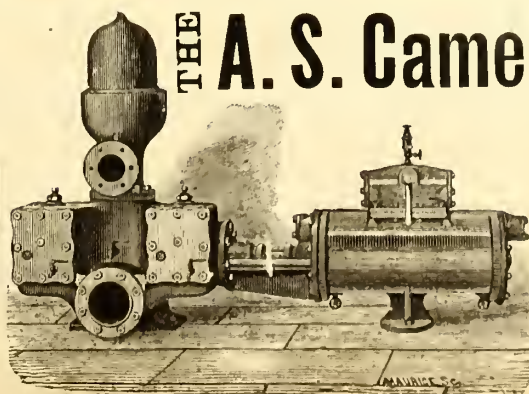

THE A. S. Cameron Steam Pump,

THE STANDARD OF EXCELLENCE.

Upward of 30,000 in Use.

BEST GAS WORKS PUMP
Ever Introduced.

Adapted to Every Possible Duty.

A.S. Cameron Steam Pump Works,

Foot East 23d St., N. Y.

J. H. CAUTIER & CO..

CORNER OF
GREENE AND ESSEX STREETS,
JERSEY CITY, N. J.

MANUFACTURERS OF

Clay Gas Retorts,
Gas House Tiles,
Fire Bricks, Etc. Etc.
Ground Clay, Fire Brick and
Fire Sand in Barrels.

J. H. GAUTIER.
C. E. GREGORY.

T. B. GAUTIER.
C. E. GAUTIER.

BROOKLYN

Clay Retort & Fire Brick Works,
(EDWARD D. WHITE & CO.)

Manufacturers of Clay Retorts, Fire Brick,
Gas House and other Tile.

VAN DYKE, ELIZABETH, RICHARD & PARTITION STS.
Office, 88 Van Dyke St., Brooklyn, N. Y.

LACLEDE FIRE BRICK MFG. CO.,

MANUFACTURERS OF

Fire Brick, Gas Retorts,

AND

ST. LOUIS STANDARD SEWER PIPE.

Blast Furnace and Cupola Linings, every description of Fire
Clay Material, Fire Clay Flue Linings, Chimney Tops
Dry Milled and Crude Fire Clays, etc.

OFFICE AND DEPOT.

901, 903, and 905 Pine Street,
ST. LOUIS, MO.

ESTABLISHED IN 1845.

B. KREISCHER & SONS,

OFFICE FOOT OF HOUSTON ST., E. R., N. Y.

Gas Retorts,

TILES, FIRE BRICK.

AND EVERYTHING IN THE FIRE CLAY LINE.

MANHATTAN

FIRE BRICK & ENAMELLED CLAY

RETORT WORKS.

ADAM WEBER.

CLAY GAS RETORTS
AND RETORT SETTINGS,
FIRE BRICKS, TILES, ETC.,

Office and Works, 15th Street and Avenue C., N. Y.

CHICAGO

Retort & Fire Brick Works,

OFFICE AND FACTORY,

Clark, Forty-Fifth, and La Salle Streets,

CHICAGO, ILL.

GEORGE C. HICKS, PRES. PAUL P. AUSTIN, SEC. & TREAS.

STANDARD

Clay Retorts and Settings.

BLOCKS & TILES

Of every Shape and Size to Order.

Standard Fire Bricks.

JAMES GARDNER, JR.

Works,
LOCKPORT STATION, PA.

—ESTABLISHED 1864.—

WILLIAM GARDNER & SON,

Successor to GARDNER BROTHERS.

WILLIAM GARDNER.

Office, COAL EXCHANGE,
PITTSBURGH, PA., P. O. Box 373.

Fire Clay Goods for Gas Works.

C. H. SPRAGUE, No. 70 KILBY STREET, BOSTON, MASS., Agent for the New England States.

OFFICE, 418 to 422 East 23d St., New York.

ESTABLISHED 1856.

WORKS, PERTH AMBOY, NEW JERSEY.

HENRY MAURER,

Excelsior Fire Brick & Clay Retort Works

CLAY GAS RETORTS, BENCH SETTINGS, FIRE BRICK, TILES, ETC.

STANDARD GAS RETORT AND FIRE BRICK COMPANY,

J. ANDERSON, PRES. & MANG'R.

OF IRONTON, OHIO.

C. PETERS, SECRETARY.

Clay Gas Retorts, Fire Brick, and Fire Clay Goods of Every Description.

Plans of Livesey-Somerville, McIlhenny, and other Furnaces, and Competent Workmen Supplied.



CINCINNATI

Gas Retort & Fire Brick Co.,

(ESTABLISHED 1872.)

CINCINNATI, OHIO.

Manufacturers of Gas Retorts, Retort Set-
tings, Fire Brick, Tiles, Etc.

OAKHILL

GAS RETORT & FIRE BRICK

COMPANY.

PARKER, RUSSELL & CO.

City Office, 711 Pine Street,

ST. LOUIS, MO.

Our immense establishment is now employed almost entirely in
the manufacture of

MATERIALS FOR GAS COMPANIES.

We have studied and perfected three important points. Our re-
torts are made to stand changes of temperature, the strongest
heats of the furnace, and the abrasion of feeding and emptying.
Our customers are in almost every State of the Union, to all of
whom we refer.

THOS. SMITH, Prest.

AUGUST LAMBLA, Vice-Prest. & Sup

BALTIMORE
RETORT & FIRE BRICK CO.

MANUFACTORY AT

LOCUST POINT, BALTIMORE, MD.

Connection with the City by Telephone.

Clay Retorts, Blocks & Tiles,
FIRE BRICK, FIRE CLAY,
AND FIRE CEMENT.

Red and Buff Ornamental Tiles and Chim-
ney Tops. Drain and Sewer Pipe (from
2 to 30 inches). Baker Oven Tiles
12 x 12 x 2 and 10 x 10 x 2.

WALDO BROS., 88 WATER ST., BOSTON, MASS

Sole Agents for New England States

THE AMERICAN METER CO.,

MANUFACTORIES,

512 West Twenty-second Street, N. Y.

Arch and Twenty-second Street, Phila.

Nos. 244 & 246 North Wells Street, Chicago, Ill.

AGENCIES,

No. 177 Elm Street, Cincinnati, Ohio.

Nos. 122 & 124 Sutter Street, San Francisco, Cal.

No. 810 North Second Street, St. Louis, Mo.

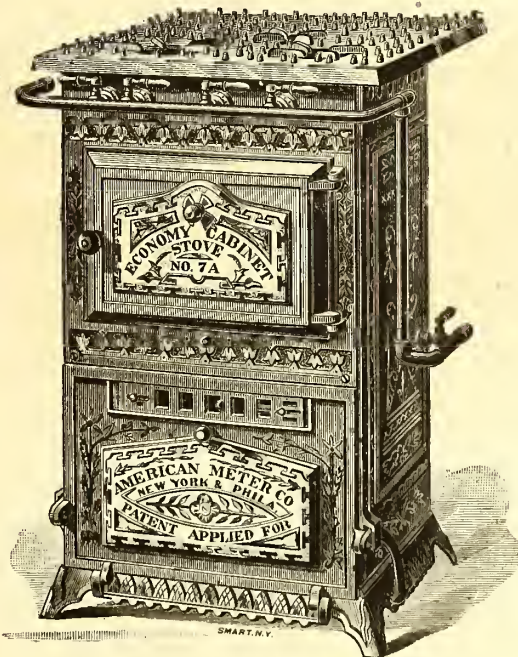

NEW DESIGN STOVES MADE IN CAST IRON, WITH EITHER OPEN OR CLOSED TOPS.

In presenting our "Economy" Gas Cooking Stoves and Ranges for the Season of 1885, we have the pleasure to inform our patrons that the increasing demand for these Stoves has encouraged us to make entirely new patterns, of HIGHLY ORNAMENTAL DESIGNS, for the popular sizes. We have also embraced the opportunity to increase the size of these Stoves, giving greater TOP PLATE AND OVEN capacity.

Full Lists and Catalogues are in preparation, and large stocks of Stoves will be kept at our Manufactories and Agencies for prompt shipment.

AMERICAN METER CO.

A. H. M'NEAL,

BURLINGTON, N. J.

Flange-Pipes

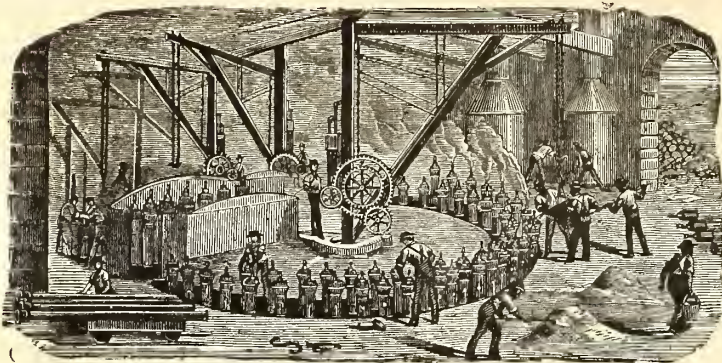

General Foundry Work.

CAST IRON PIPES FOR WATER AND GAS.

JAMES S. MOORE, Pres.
BENJAMIN CHEW, Treas.

JAS. P. MICHELLON, Sec.
WM. SEXTON, Supt.

GLOUCESTER IRON WORKS, GLOUCESTER CITY, N. J.



Cast Iron Gas & Water Pipes, Stop Valves, Fire Hydrants, Gasholders, &c.
Office No. 6 North Seventh Street, Philadelphia.

ESTABLISHED 1856.

WARREN FOUNDRY AND MACHINE CO.,

WORKS AT PHILLIPSBURGH, N. J.
NEW YORK OFFICE, 162 BROADWAY.

Cast Iron Water and Gas Pipe

FROM TWO TO FORTY-EIGHT INCHES DIAMETER.
ALSO ALL SIZES OF

FLANGE PIPE for Sugar House and Mine Work.
Branches, Bends, Retorts, Etc., Etc.

436-1

MATTHEW ADDY, President.

W. L. DAVIS, Selling Agent.

GEO. P. WILSHIRE, Sec. & Treas.

Cincinnati and Newport Iron and Pipe Company,

NEWPORT, KY.

Lamp Posts
AND
BENCH CASTINGS

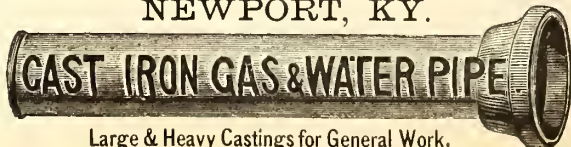

Branch
AND
SPECIAL CASTINGS

A Specialty.

Large & Heavy Castings for General Work.

FOR GAS & WATER CO'S.

Manufacture Pipe from 2 to 48 inches. All work guaranteed first quality.

Mellert Foundry and Machine Co. Limited. Established 1848. MANUFACTURERS OF



Specials—Flange Pipe, Valves and Hydrants,
Lamp Posts, Retorts, etc.
Machinery and castings for Furnaces, Rolling Mills, Grist and
Saw Mills, Mining Pumps, Hoists, etc.

GENERAL OFFICE, - - - READING, PA.

LUDLOW VALVE MFG. CO.

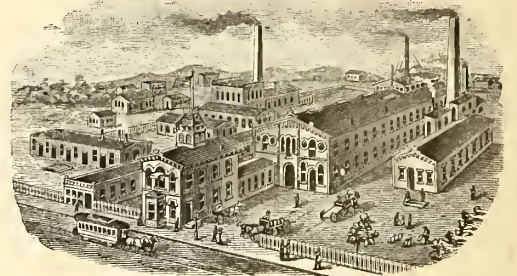

OFFICE AND WORKS,
938 to 954 River Street and 67 to 83 Vail Av.,
TROY, N. Y.

Hydraulic Main Dip Regulators, also
Check Valves, Foot Valves, Yard-
wash and Fire Hydrants.
Send for Circulars.

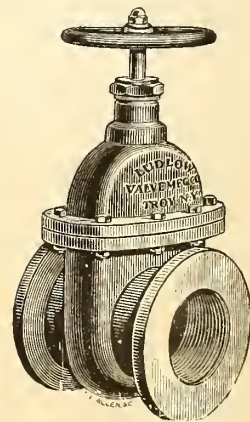

Valves.—Double and Single Gate, 1/2 in. to
48 in., outside and inside Screws. Indica-
tor, etc., for Gas, Water, Steam, and Oil.
Send for Circulars.

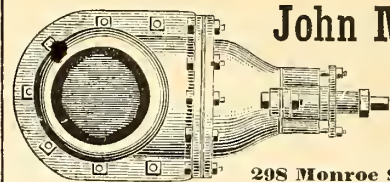

John McLean

Man'facturer of

GAS
VALVES.

298 Monroe Street, N. Y.

PRESERVE

The Journal

BY THE USE OF

THE STRAP FILE.

Advantages of the Strap File.

- 1st. It is simple, strong, and easily used.
- 2d. Preserves papers without punching holes.
- 3d. Will always lie flat open.
- 4th. Allows any paper on file to be taken off without disturbing the others.

Price, \$1.25. Sent either by express or mail, at directed. By mail the postage will be 20 cents, which will be added to the price of the Binder.

A. M. CALLENDER & CO., 42 PINE ST., N. Y.

R. D. WOOD & CO.,

400 Chestnut Street, Phila., Pa.

Cast Iron Gas & Water Pipe, Water Machinery & Gas Apparatus

Cast Iron Pipe, Fire Hydrants, Eddy Valves, Lamp Posts, Large Loam Castings, Flanged Pipe, Sugar House Work, Iron Roofs and Floors, Wrought & Cast Iron Tanks, Turbine Water Wheels and Pumps.

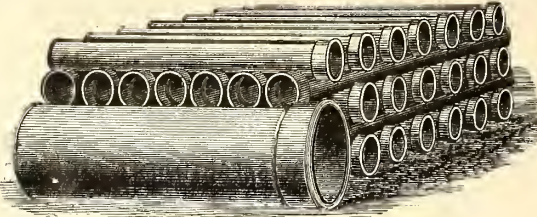

Casholders, Lime Trays, Center Valves, Purifiers, Bench Work, Exhausters, Condensers, Governors, Scrubbers, Gas Valves, Station Meters, Cast Iron Pipe Fittings.

Manufacturers of Heavy Castings and Machinery of Every Description.

ENGINEERS & CONTRACTORS FOR THE ERECTION OF GAS WORKS, & ALL MACHINERY CONNECTED THEREWITH

Estimates and specifications furnished for erection of new works or the extension or alteration of old ones.

Foundries and Works, - - Millville, Florence, and Camden, N. J.

SMITH & SAYRE MFG. COMPANY,

G. G. PORTER, Prest.

245 Broadway, N. Y.

CHAS. W. ISBELL, Sec'y.

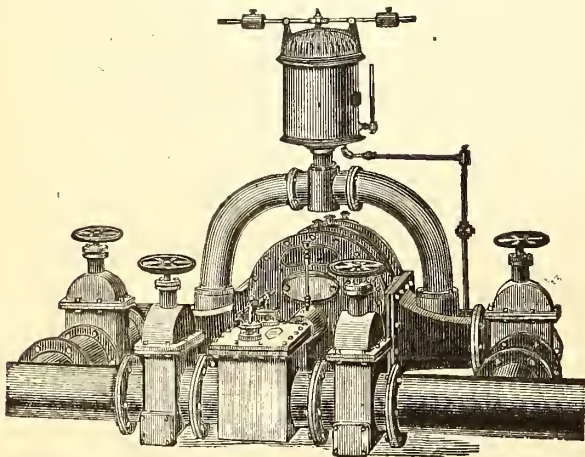
**Machinery & Apparatus for Gas Works**

Drawings, Plans, and Estimates Furnished for the Improvement, Extension, or Alteration of Gas Works, or for the Construction of New Works.

Mackenzie's Patent Rotary and Steam Jet Gas Exhausters, Governors, Compensators, Condensers, Washers, Scrubbers. Isbell's Patent Automatic Street Pressure Governor, Gas and Water Valves, Hydraulic Main Dip Regulator, Bench Castings, etc. Purifying Boxes and "Standard" Scrubbers. Isbell's Patent Self-Sealing Retort Doors.

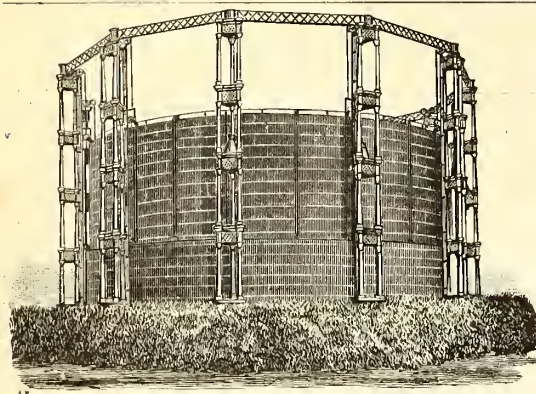

W. E. Tanner, Pres., W. R. Trigg, V.-Pres., A. Delaney, Supt.

Tanner & Delaney Engine Co.
RICHMOND, VA.

Gas Apparatus,

INCLUDING

Condensers of various styles, Scrubbers, Holders, Purifiers, Castings for Retort Houses, Etc.

ALSO STEAM ENGINES AND BOILERS.
Plans, Specifications and Estimates Furnished.

MORRIS, TASKER & CO.,
Limited,

Builders of Gas Works,
PHILADELPHIA, PA.

To Gas Companies.

We make to order **CAP BURNERS** to burn any amount under a stated pressure. Send for samples.

Also, **SERVICE CLEANERS, DRIP PUMPS, and STREET MAIN PROVING APPARATUS.**

C. A. GEFROER,
248 N. 8th Street, Phila., Pa.

SOUTHWARK FOUNDRY AND MACHINE COMPANY,

Successors to **MERRICK & SONS.** Established in 1836.

No. 430 Washington Avenue, Philadelphia, Pa.

MANUFACTURERS OF

Single and Telescopic Gasholders,

BENCH CASTINGS,

Washers, Scrubbers, Condensers, Purifiers,

And all apparatus necessary for the construction of improved new gas works and in the extension of established works. Also manufacturers of

Gas Engines, and of all descriptions of Steam and Hydraulic Machinery, and of Boiler and Tank Work.

Plans, specifications, and estimates furnished promptly on application.

WM. HENRY WHITE,

Consulting & Constructing

Gas Engineer & Contractor.

ESTIMATES, PLANS, AND SPECIFICATIONS FURNISHED FOR NEW WORKS OR EXTENSIONS OF EXISTING WORKS.

32 Pine St., New York City.

Correspondence solicited.

JAMES R. FLOYD,
 (SUCCESSOR TO HERRING & FLOYD)
Oregon Iron Works,
 531 to 543 West 20th St., N. Y.
Practical Builders of Gas Works,
 MANUFACTURERS OF
ALL KINDS OF CASTINGS
 AND
APPARATUS FOR GAS-WORKS.

BENCH CASTINGS
 from benches of one to six Retorts each.
WASHERS: MULTITUBULAR AND
AIR CONDENSERS; CONDENSERS;
SCRUBBERS
 wet and dry, and
EXHAUSTERS
 for relieving Retorts from pressure.
BENDS and BRANCHES
 of all sizes and description.
FLOYD'S PATENT
MALLEABLE RETORT LID.
PATENT
SELF-SEALING RETORT LIDS.
FARMER'S
PATENT BY-PASS DIP-PIPE.
SABBATON'S PATENT
FURNACE DOOR AND FRAME.
BUTLER'S
COKE SCREENING SHOVELS.

GAS GOVERNORS,
 and everything connected with well regulated Gas Works at
 low price, and in complete order.
SELLER'S CEMENT
 for stopping leaks in Retorts.
N. B.—STOP VALVES from three to thirty inches—
 at very low prices.
 Plans, Specifications, and Estimates furnished.

KERR MURRAY MFG. CO.,
 MANUFACTURERS OF
Single Lift and Telescopic
GASHOLDERS.

Built, 1884:

Altoona, Pa.	Capacity, 160,000 cubic feet.
Pittsburgh, Pa.	250,000 "
"	220,000 "
Bellaire, Ohio.	50,000 "
Youngstown, Ohio.	60,000 "
Canton, "	60,000 "
Akron, "	80,000 "
Xenia, "	10,000 "
Adrian, Mich.	65,000 "
Ypsilanti, Mich.	25,000 "
Muskegon, "	70,000 "
South Bend, Ind.	70,000 "
Anderson, "	20,000 "
Plainfield, "	10,000 "
Springfield, Illinois.	100,000 "
Evanston, "	50,000 "
Freeport, "	35,000 "
Elgin, "	60,000 "
Sheboygan Wis.	20,000 "
Key West Fla.	10,000 "

Plans and estimates furnished for the erection of
 new and the rebuilding of old works. Address

Kerr Murray Mfg. Co.,
FORT WAYNE, IND.

CONTINENTAL WORKS.

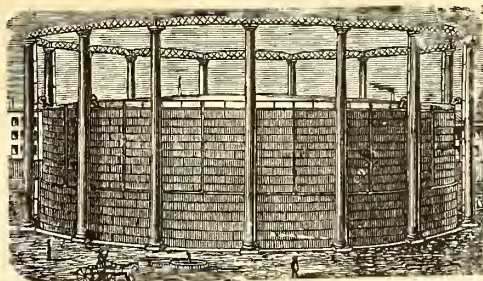

GASHOLDERS OF ANY MAGNITUDE.

T. F. ROWLAND, Proprietor.
GREENPOINT, BROOKLYN, N. Y.
 ENGINEER AND MANUFACTURER OF
GAS-HOLDERS.
CONDENSERS, SCRUBBERS, VALVES,
PURIFIERS, RETORTS, and HY-
DRAUIC MAINS,
 and all other articles connected with the Manufacture
 Distribution of Gas. Plans and Specifications prepared
 and Proposals given for the necessary Plant for Lighting
 Cities, Towns, Mansions, and Manufactories.

H. RANSHAW, Prest. & Mangr. WM. STACEY, Vice-Pres. T. M. BIRCH, Asst. Mangr. R. J. TARVIN, Sec. & Treas.

STACEY MFG. CO.,

MANUFACTURERS OF

Single and Telescopic Gasholders,

IRON ROOFS, BRIDGES, LAMP POSTS,

Water and Oil Tanks, Coal Elevator Cars,
COKE CRUSHERS, BENCH CASTINGS,

And all kinds of Wrought and Cast Iron Work used in the erection of Coal and Oil Gas Works.
 Rolling Mill Machinery and Heavy Castings a Specialty.

Foundry:
 33, 35, 37 & 39 Mill Street.

Wrought Iron Works:
 16, 18, 20, 22, 24 & 26 Ramsey Street.

Cincinnati, Ohio.

BARTLETT, HAYWARD & CO.,

Office, 24 Light.

BALTIMORE, MD.

Works, Pratt &

PURIFIERS.

Roofs.

Bench Castings.

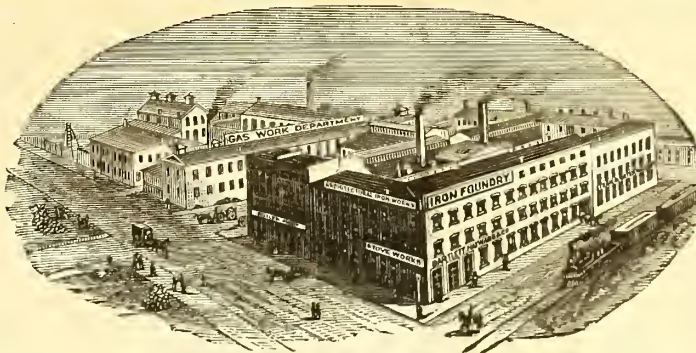

SCRUBBERS.

BOILERS.

CONDENSERS.

GASHOLDERS.

CONSTRUCTING ENGINEERS AND BUILDERS OF GAS WORKS.

1842. **DEILY & FOWLER, 1884.**

Laurel Iron Works.

Address, No. 39 Laurel Street, Philadelphia, Pa.

MANUFACTURERS OF

GASHOLDERS,

Single or Telescopic, with Cast or Wrought Iron Guide Frames.

Holders Built Since 1880:

Mount Joy, Pa.	West Point, N. Y.	Galveston, Texas (2d.)	Kalamazoo, Mich. (3d.)	Newport, R. I.
Rockaway B'ch, N.Y. (2)	Fitchburgh, Mass.	Marlboro, Mass.	Glen Island, N. Y.	Portland, Oregon.
Zanesville, O. (2d.)	New London, Conn.	Denver, Col.	Warren, Ohio.	Allegheny, Pa. (2d.)
Lancaster, O.	Derby, Conn.	Chicago, Ill. (West Side)	Bath, N. Y.	Atlanta, Ga. (2d.)
Blackwell's Island N. Y.	Bridgeport, Conn.	Pittsburgh, Pa. (S. Side)	Lynn, Mass.	N.Y. City (Central Gas)
Waltham, Mass., (1st.)	Allegheny, Pa. (1st.)	Pawtucket, R. I.	New Bedford, Mass.	Lynchburg, Va. (2d.)
Dorchester, Mass.	St. Hyacinth, Can.	Brookline, Mass.	Waterbury, Conn.	Rondout, N. Y.
Wheeling, West Va.	Norwalk, O.	Sherbrooke, Can.	Deseronto, Can.	Saylesville, R. I.
Lansing, Mich.	Brattleboro, Vt.	Burlington, N. J. (2d.)	Roosie Falls, N. Y. (2d.)	Atlantic City, N. J.
Flint, Mich.	Waltham, Mass (2d.)	Bridgeton, N. J.	Bethlehem, Pa.	Augusta, Ga.
Galveston, Texas (1st.)	West Chester, Pa.	Bay City, Mich.	Atlanta, Ga. (1st.)	Waltham, Mass. (2d.)
Milton, Pa.	Baltimore, Md.	Erie, Pa.	Savannah, Ga.	
Scranton, Pa.	Hollidaysburg, Pa.	Jackson, Mich.	Montgomery, Ala	

GAS COALS.

GAS COALS.

GAS COALS.

JAMES D. PERKINS.

PERKINS & CO.,

F. SEAVERN.

General Sales Agents for

**The Youghioghenny River Coal Company's
OCEAN MINE YOUGHIOGHENY GAS COAL.**

The Coal from the Ocean Mine (recently operated by Messrs. W. L. Scott & Co., of Erie, Pa.,) is now used by all the leading Gas Companies in the United States from Maine to Texas, and is recognized as *the only reliable Youghioghenny Gas Coal.* (See Map on p. 87 of this Journal, Feb. 16, 1885.)

P. O. Box 3695,
New York.

PERKINS & CO., 228 and 229 N. Y. Produce Exchange BEAVER STREET ENTRANCE.

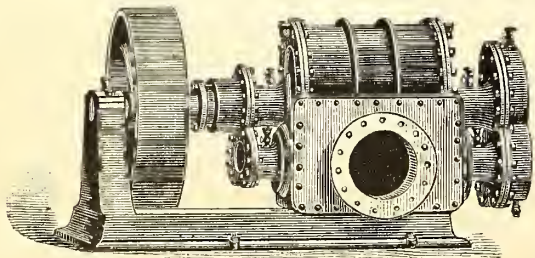

Gas Exhauster Driven by Belt.

The Wilbraham Gas Exhauster,

“BAKER SYSTEM,”

WITH ENGINE ATTACHED, ON SAME BED PLATE OR WITHOUT.

Best, Cheapest and Most Durable Exhauster known.

WILBRAHAM BROS.,

No. 2320 Frankford Avenue, Philadelphia, Pa.

F. J. DAVIS & J. R. FARNUM,

TRUSTEES AND AGENTS FOR THE

SINUOUS FRICTION CONDENSER.

We desire to draw the attention of the gas community to the merits of the **SINUOUS FRICTION CONDENSER.** Companies intending to introduce new condensers into their works will do well to confer with us and examine plans and estimates before contracting for any other pattern. The **FRICTION CONDENSER** is now in use at the gas works located in the following places:

- | | | | |
|--------------------------------|------------------|-------------------------------|---------------------|
| Portland, Me. | Brookline, Mass. | Pawtucket, R. I. | Frederickton, N. B. |
| Newport, R. I. | Chelsea, Mass. | Jamaica Plain, Mass. | St. John, N. B. |
| Gloucester, Mass. | Woburn, Mass. | Attleboro, Mass. | Paterson, N. J. |
| Newton & Water-
town, Mass. | Peoria, Ill. | Calais, Me. | Dover, N. H. |
| | Clinton, Mass. | Fall River, Mass. | Waltham, Mass. |
| | | Nassau Works, Brooklyn, N. Y. | |

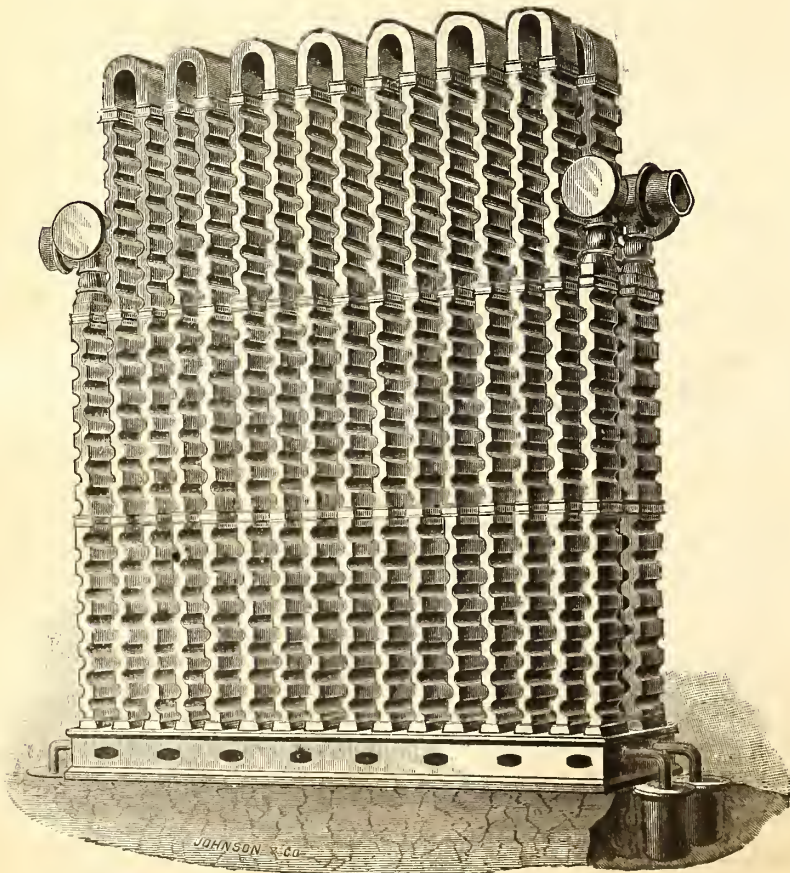

DAVIS & FARNUM MFG. CO.

MANUFACTURERS OF

Gas and Water Pipes,

AND

GAS AND WATER MACHINERY

OF THE MOST APPROVED PATTERN.

Also, Gasholders and Iron Roofing.

Orders from Gas and Water Companies promptly attended to.

WALTHAM, MASS.

Boston Office, Room 55, Mason Building, 70 Kilby Street.

GAS COALS.

GAS COALS.

GAS COALS,

Newburgh Orrel Coal Co.,

MINERS AND SHIPPERS OF

**Newburgh Orrel, Tyrconnell
and Palatine Gas Coals.**

ALSO SHIPPERS OF FOUNDRY COKE.

Mines Situated at

Newburgh, Flemington & Fairmont, W.Va.

HOME OFFICE,

25 S. Gay St., Baltimore.

CHARLES MACKALL,
MANAGER.

CHAS. W. HAYS, Agent in New York,

Room 92, WASHINGTON BUILDING, No. 1 Broadway.

Shipping wharves at Locust Point. References furnished when required. Special attention given to chartering vessels.

THE DESPARD COAL COMPANY

OFFER THEIR SUPERIOR

DESPARD COAL

To Gas Light Companies and Manufacturers of Fire Clay Goods
Throughout the Country.

ROUSSEL & HICKS, } AGENTS. { BANGS & HORTON,
71 Broadway, N. Y. } 16 Kilby St., Boston.

Mines in Harrison Co., West Va. Wharves, Locust Point, Balt.

Company's Office, 15 German St., Baltimore, Md.

Among the consumers of Despard Coal we name: Manhattan Gas Light Co., N. Y.; Metropolitan Gas Light Co., N. Y.; Jersey City, (N. J.) Gas Light Co.; Washington (D. C.) Gas Light Co.; Portland (Maine) Gas Light Co. Reference to them is requested.

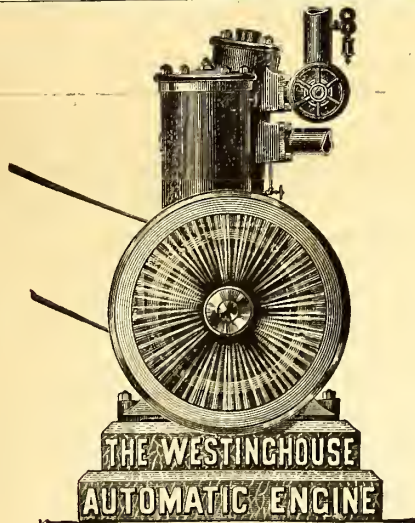

1,500 Engines Now in Use.

Our capacity being now equal to 100 Engines per month, we shall hereafter keep in stock for immediate shipment all sizes from 4 to 200 H.P.

SEND FOR ILLUSTRATED CIRCULAR AND REFERENCE LIST.

Westinghouse Machine Co.,
PITTSBURCH, PA.

SALES DEPARTMENT CONDUCTED BY

Westinghouse, Church, Kerr & Co., 17 Cortlandt Street, New York City.

Fairbanks, Morse & Co., Chicago, Cincinnati, Cleveland, Louisville, and St. Paul.

Fairbanks & Co., St. Louis, Indianapolis, and Denver.

Parke & Lacy, San Francisco, and Portland, Or.

Parke, Lacy & Co., Salt Lake City, Utah, and Butte, Montana.

D. A. Tompkins & Co., Charlotte, N. C.

Keating Implement & Machine Co., Dallas, Texas

Inray & Co., Sydney and Melbourne, Australia.

Robert Middleton, Mobile, Ala.

H. Dudley Coleman, 9 Perdido St., New Orleans, La.

R. Rogers, 43 Rue Laflitte, Paris.

**THE
PENN GAS COAL COMPANY**
OFFER THEIR
**COAL, CAREFULLY SCREENED,
AND PREPARED FOR
GAS PURPOSES.**

Their Property is located in the Youghiogheny Coal Basin, near Irwin's and Penn Station on the Pennsylvania Railroad, and on the Youghiogheny River.

OFFICES

No. 209 South Third Street, Phil'a. 90 Wall Street, New York.

PLACES OF SHIPMENT.

Pennsylvania Railroad, Pier No. 2 (Lower Side).

Greenwich Wharves, Delaware River.

366-17

Pier No. 1 (Lower Side), South Amboy, N. J.

Chesapeake & Ohio Railway Coal Agency,

FOR THE SALE OF THE

**Superior Kanawha Gas Coals, Cannelton Cannel,
Also, SPLINT AND STEAM COALS.**

From the Kanawha and New River Regions, on the line of the Chesapeake & Ohio R'way.

C. B. ORCUTT, Sales Agent. | OFFICE, 150 BROADWAY, N. Y.

FRANCIS H. JACKSON, PRESIDENT.

EDMUND H. MCCULLOUGH, SEC. & TREAS.

THE WESTMORELAND COAL CO.

Chartered 1854.

Mines situated on the Pennsylvania and the Baltimore and Ohio Railroads, in Westmoreland County, Penn.

POINTS OF SHIPMENT:

PHILADELPHIA, BALTIMORE, SOUTH AMBOY, N. J.
WATKINS (SENECA LAKE), N. Y.

Since the commencement of operations by this Company its well-known Coal has been largely used by the Gas Companies of New England and the Middle States, and its character is established as having no superior in gas-giving qualities, and in freedom from sulphur and other impurities.

Principal Office, 224 South 3d St., Phila., Pa.

The Bower Gas Lamp.

The Perfected Duplex-Regenerative Gas Burner, under the combined Patents of Anthony S. Bower, Geo. S. Grimston, and Thos. Thorp.

The First Gold Medal awarded at the Crystal Palace Exhibition in London, and two Gold Medals at the Stockport (Eng.) Exhibition of Gas Appliances. Both in 1883.

GEO. SHEPARD PAGE, JOHN BOWER,
69 Wall Street, N. Y. City.

The Management of Small Gas Works.

By C. J. R. HUMPHREYS. Price, \$1.

A. M. CALLENDER & CO., 42 Pine St., N. Y.

INTERNATIONAL--1876--EXHIBITION.



The U. S. Centennial Commission

HAVE DECREED AN AWARD TO

HARRIS, GRIFFIN & CO.,

12th and Brown Sts., Philadelphia, and 49 Dey St., N. Y., U. S. A.,

FOR THE FOLLOWING REASONS :

The Exhibit consists of a Series of METERS from the Largest Size Station Meters for the use of the MANUFACTURE OF GAS, to those for the use of the ORDINARY CONSUMER. The Instruments are WELL MADE, RELIABLE as to INDICATION, and embody a number of sundry improvements which, with the general character of the Exhibit, entitle the whole to commendation.

Attest—J. L. CAMPBELL,
Secretary, pro-tem.

Signed—A. T. GOSHORN,
Director General

J. R. HAWLEY,
President

CHARLES E. DICKEY.

JAMES B. SMALLWOOD.

CHARLES H. DICKEY.

Maryland Meter and Manufacturing Co.,

DICKEY, TANSLEY & CO.,

Established 1866.

Nos. 22 and 24 Saratoga Street, Baltimore, Md.

No. 46 La Salle St., Chicago, Ill.

MANUFACTURERS OF

DRY GAS METERS, STATION METERS, GLAZED METERS, TEST METERS, METER PROVERS, PRESSURE AND VACUUM REGISTERS, GOVERNORS, INDICATORS, SERVICE AND METER COCKS, AND METER CONNECTIONS.

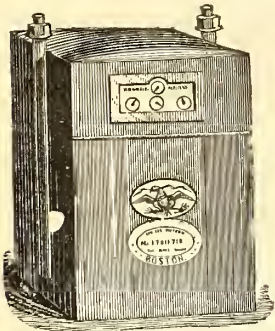

Dry Gas Meter.

With 39 years' experience and the best facilities for manufacturing, is enabled to furnish reliable work and answer orders promptly.

NATHANIEL TUFTS,

No. 153 Franklin Street, Boston. Mass.,

MANUFACTURER OF

DRY GAS METERS.

Station Meters of any Capacity.

Test and Experimental Meters, Pressure Registers, Pressure Gauges, Pressure and Vacuum Gauges.

METER PROVERS, PHOTOMETERS, STREET LANTERNS, ETC., ETC.

Patent Cluster Lanterns for Street Illumination.

SCIENTIFIC BOOKS.

We are prepared to furnish to Gas Managers, and others interested in the topics treated of, the following books, at prices named :

- | | | |
|--|---|---|
| <p>KING'S TREATISE ON THE MANUFACTURE OF COAL GAS. Three vols.; \$10 per vol.</p> <p>GAS MANUFACTURE, by WILLIAM RICHARDS. 4to., with numerous Engravings and Plates, in Cloth binding. \$12.</p> <p>THE GAS ANALYST'S MANUAL, by F. W. HARTLEY. \$2.50.</p> <p>ANALYSIS, TECHNICAL VALUATION, PURIFICATION, and USE OF COAL GAS, by REV. W. R. BOWDITCH, M.A.; with Engravings; 8vo., Cloth. \$4.50.</p> <p>GAS MEASUREMENT AND GAS METER TESTING by F. W. HARTLEY. \$1.60</p> <p>GAS CONSUMER'S HANDBOOK, by WILLIAM RICHARDS, C.E.; 18mo., Sewed. 20 cents.</p> | <p>GAS CONSUMER'S MANUAL, by E. S. CATHELS, C.E. 10 cts.</p> <p>PRACTICAL TREATISE ON HEAT, by THOMAS BOX. Second edition. \$5.</p> <p>GAS WORKS—THEIR ARRANGEMENT, CONSTRUCTION, PLANT, AND MACHINERY. \$8.</p> <p>COAL; ITS HISTORY AND USE, by PROF. THORPE. \$3.50.</p> <p>THE GAS WORKS OF LONDON, by COLBURN. 60 cents.</p> <p>THE GAS FITTER'S GUIDE, Showing the Principles and Practice of Lighting with Coal Gas, by JOHN ELDRIDGE. 40 cents.</p> <p>GAS WORKS, AND MANUFACTURING COAL GAS, HUGHES. \$1.80.</p> <p>THE MANAGEMENT OF SMALL GAS WORKS, by C. J. R. HUMPHREYS. \$1.</p> | <p>A PRACTICAL TREATISE ON GAS AND VENTILATION, with Special Relation to Illuminating, Heating, and Cooking by Gas, by E. E. PERKINS. \$1.25.</p> <p>PURIFICATION OF COAL GAS, by R. P. SPICE. 8vo. \$3.</p> <p>HOW TO MANAGE GAS, by F. WILKINS. Paper. 20 cents.</p> <p>THE GAS MANAGER IN THE LABORATORY, by a Practical Student. 8vo., Cloth. \$1.50.</p> <p>THE DOMESTIC USES OF COAL GAS, AS APPLIED TO LIGHTING, by W. SUGG. \$1.40.</p> <p>DISTILLATION OF COAL TAR AND AMMONIACAL LIQUOR, by GEO. LUNGE. \$8.50.</p> <p>A TREATISE ON THE COMPARATIVE COMMERCIAL VALUES OF GAS COALS AND CANNELS, by D. A. GRAHAM. 8vo., Cloth. \$3.</p> |
|--|---|---|

The above will be forwarded by express, upon receipt of price. We take especial pains in securing and forwarding any other Works that may be desired, upon receipt of order. All remittances should be made by check, draft, or post office money order.

A. M. CALLENDER & CO., No. 42 Pine Street, New York.

T. C. HOPPER, Pres. G. J. MCGOURKEY, Vice-Pres. (New York). WM. N. MILSTED, Gen. Supt. & Treas. (New York). WM. H. DOWN Sec.

AMERICAN METER COMPANY,

WET AND DRY GAS METERS. STATION METERS. EXHAUSTER GOVERNORS. DRY CENTRE VALVES. GOVERNORS FOR GAS WORKS. PRESSURE REGISTERS. PRESSURE & VACUUM REGISTERS. PRESSURE & VACUUM GAUGES. CRESSON GAS REGULATORS. MARSLAND WATER METERS. METER PROVERS. PORTABLE TEST METERS. EXPERIMENTAL METERS. AMMONIA TEST METERS. BAR AND JET PHOTOMETERS.

Manufactories:
512 W. 22d St., N. Y.
Arch & 22d Sts., Phila.

GAS STOVES,
SUGG'S "STANDARD" ARGAND BURNERS,
SUGG'S ILLUMINATING POWER METER,
Wet Meters, with Lizar's "Invariable Measuring" Drum.

Agencies:
177 Elm Street, Cincinnati.
214 & 216 N. Wells Street, Chicago.
810 North Second Street, St. Louis.
122 & 124 Sutter St., San Francisco.

HELME & McILHENNY,

(Successors to Harris & Brother. Established 1848.)

GAS METER MANUFACTURERS,

CONTINUE AS HERETOFORE AT THE OLD ESTABLISHMENT,

Nos. 1115 and 1117 Cherry Street, Philadelphia, Pa.,

To Manufacture Wet and Dry Gas Meters, Station Meters, Experimental Meters, Meter Provers, Center Seals, Pressure Registers, GOVERNORS, INDICATORS, PHOTOMETERS, & ALL OTHER KINDS OF APPARATUS FOR USE IN GAS WORKS.

From our long practical experience of the business, and from our personal supervision of all work, we can guarantee all orders to be executed promptly, and in every respect satisfactorily.

WM. WALLACE GOODWIN, Prest. and Treas.

WM. H. MERRICK, V.-Prest.

S. L. JONES, Sec.

S. V. MERRICK, Supt.

THE GOODWIN GAS STOVE AND METER COMPANY,

Successors to W. W. GOODWIN & CO.

1012, 1014 and 1016 Filbert St., Phila., Pa. 142 Chambers St., New York.
76 Dearborn St., Chicago, Ill.

WALDO BROS., Agents, 88 Water St., Boston.

MANUFACTURERS OF THE "SUN DIAL" GAS STOVES, FOR COOKING AND HEATING PURPOSES.

Dry and Wet GAS METERS, Station Meters (Square, Cylindrical or in Staves) Glazed Meters, King's and Sugg's Experimental Meters, Lamp Post Meters, Etc., Etc., Meter Provers (sizes 2, 5 and 10 feet), Pressure Guages of all kinds, Pressure Registers, Pressure and Vacuum Registers, Pressure Indicators (sizes 4 inch, 6 inch and 9 inch), King's Pressure and Vacuum Gauges, Dry and Wet Centre Seals, Dry and Wet Governors, Exhauster Governors, Photometers of all descriptions. Letheby's Sulphur and Ammonia Test Apparatus complete—also Testing and Chemical Apparatus of all kinds, and of the most perfect description, for all purposes relating to Gas.

GOODWIN'S IMPROVED LOWE'S JET PHOTOMETER.

Agents for Bray's Patent Gas Burners and Lanterns.

Special attention to repairs of Meters, and all apparatus connected with the business.
All work guaranteed first class in every particular, and orders filled promptly.

G. B. EDWARDS, Mang'r, New York.
E. H. B. TWINING, Mang'r, Chicago.
A. B. STANNARD, Agent.

D. McDONALD & CO.,

GAS METER MANUFACTURERS.

(Established 1854.)

No. 51 Lancaster Street, Albany, N. Y.

STATION METERS, EXPERIMENTAL METERS, METER PROVERS, PRESSURE & VACUUM REGISTERS, PRESSURE GAUGES, ETC.

Also STAR GAS STOVES, RANGES, and HEATING STOVES.

We use only the very best materials, and employ the most skilled labor, and by our long experience (29 years) and personal supervision of every detail, we feel justified in assuring the public that our goods will give perfect satisfaction. Every Meter emanating from our establishment will bear the State Inspector's BADGE, and will be fully warranted by us. Our Annual and Calendar will be sent to Gas Companies upon application.

KING'S TREATISE ON COAL GAS.

The most complete work on Coal Gas ever published. Three vols., bound, \$30.

A. M. CALLENDER & CO., No. 42 Pine Street, New York.

THE GOODWIN GAS STOVE AND METER CO.,

1012-18 Filbert St., Phila., 142 Chambers St., N. Y., 76 Dearborn St., Chicago.

Agents, WALDO BROTHERS, 88 Water Street, Boston.

WM. W. GOODWIN, PRES. & TREAS.
W. H. MERRICK, VICE-PRES.
S. LEWIS JONES, SEC.
SAMUEL V. MERRICK, SUPT.

SOLE MANUFACTURERS OF THE

G. B. EDWARDS, Mang'r, N. Y.
E. H. B. TWINING, Mang'r, Chicago.
A. B. STANNARD, Agent.

"SUN DIAL" GAS STOVES

The Most Economical, Efficient, and Durable Gas Stove Made.

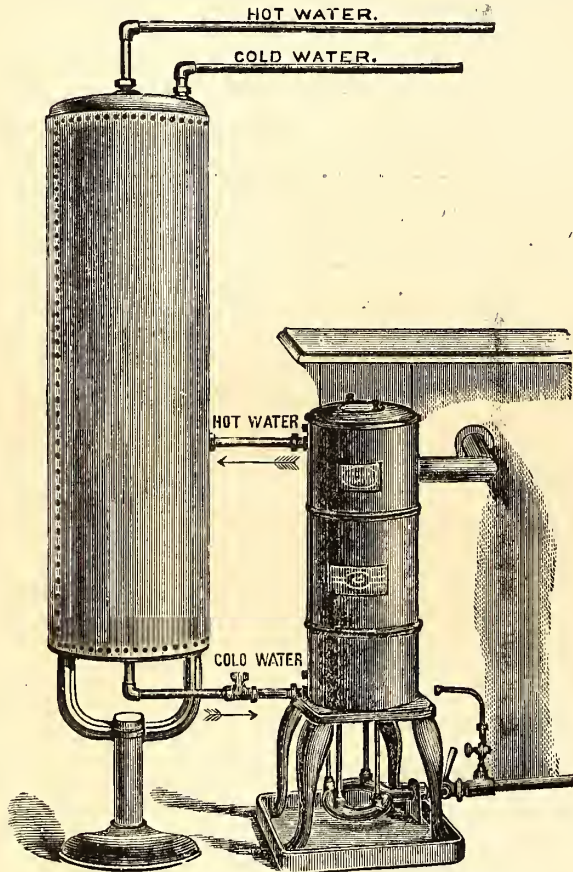

I.—Safety Hot Water Generator and Boiler.

Safety Hot Water Generator and Boiler.

Cut I. represents our Safety Gas Hot Water Generator and Boiler, arranged for home use. This most easy, quick, and economical way of preparing a warm bath, or for heating water for any domestic purpose, entirely supersedes any necessity for the use of ranges or stoves—a great comfort, particularly in hot weather. The boiler being self-filling, as the hot water is drawn off, can never become empty, thus preventing the possibility of any accident.

We beg to call attention to the cast iron pan which is now attached to the legs of the Generator (see illustration). This is to catch the drippings from the Coil, which many persons suppose come from a leak, when in fact they are produced by condensation. This condensation is caused by the hot flame coming in contact with the coil filled with cold water.

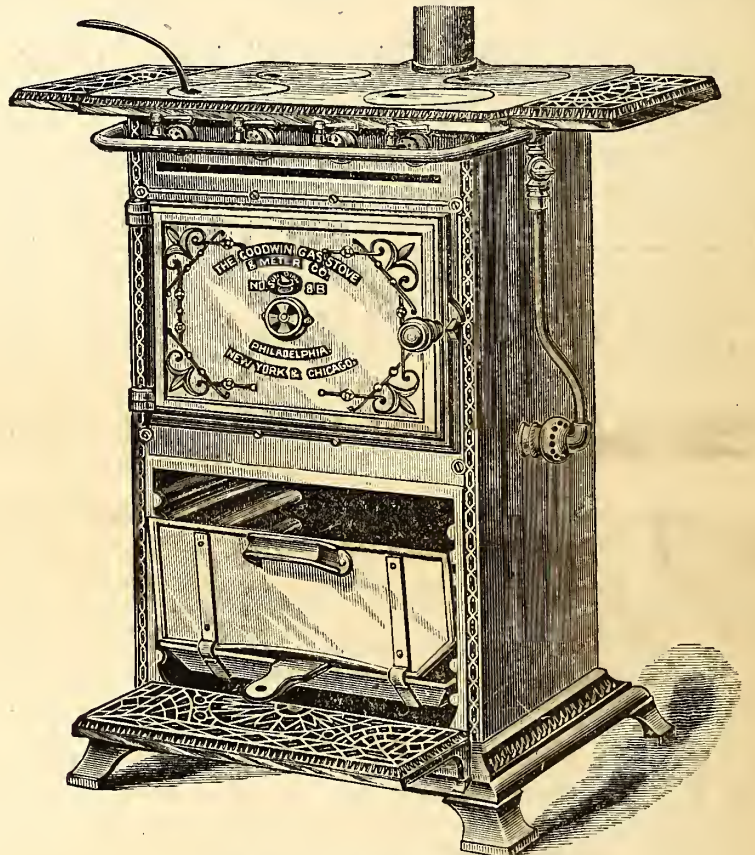

II.—Gas Cooking Stove No. 8 B.

New Style Gas Cooking Stove.

Cut II. represents our New Style Cooking Stove. As will be seen, it has an ornamented cast iron base and front, and extension shelves. The oven burner, which is atmospheric (unless otherwise ordered), is of an entirely new and improved pattern (patent applied for). The ovens are of greater capacity than those of the old style. The top, in conjunction with the outlet pipe, is designed to carry off all products of combustion; hence the outlet pipe must be connected with a flue, or the stove will not work properly.

This Stove has 4 boiling burners in top of hot plate. All fittings are nickel plated. We are making this style of Cooking Stove in the following sizes—viz., No. 7 B, No. 8 B, No. 9 B, and No. 10 B.

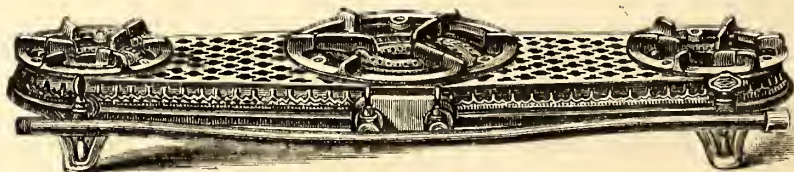

III.—Improved Hot Plate, No. 108.

New Style Hot Plates.

Cut III. represents our New Style of Hot Plates, of which we are making No. 106 (two small boiling burners), No. 107 (two medium sized boiling burners), and No. 108 (two medium and one large boiling burner). See new Catalogue and Price List for further particulars.

THE AMERICAN

GAS LIGHT JOURNAL

REDMAN KENNY, N. Y.

PUBLISHING OFFICE No. 42 PINE STREET

DEVOTED TO THE INTERESTS OF ILLUMINATION, VENTILATION, WATER SUPPLY AND DISTRIBUTION, & GENERAL SCIENCE.

VOLUME XLII.—No. 10.
Whole No. 622.

NEW YORK, SATURDAY, MAY 16, 1885.

{ \$3 PER ANNUM
IN ADVANCE.

A. M. CALLENDER & Co., Proprietors. C. E. SANDERSON, Manager.
JOS. R. THOMAS, C. E., Editor.

ENTERED AT THE POST OFFICE AT NEW YORK, N. Y.,
AS SECOND CLASS MATTER.

Published on the 2d and 16th of each month, at No. 42 Pine Street, N. Y.
Terms of Subscription, Including Postage.—For the United States and Canada, \$3 per annum. European countries, \$3.50 (15 shillings—18 francs). All payments to be made in advance. Single copies, 15 cents.
Remittances should be made either by post-office order, registered letter, or bank draft on New York, payable to the order of A. M. Callender & Co.
Collections are invariably made directly from this office, for subscriptions, advertisements, etc. We have agents to solicit the same, but they are not authorized to receipt for money.
Correspondence.—Wishing to make this JOURNAL a gazette of intelligent discussion to those of our readers who may wish to gain or give information on the subjects to which its columns are devoted, correspondence is solicited for publication from all who make the study of those subjects a pleasure or a profession.
The American News Company, Nos. 39 and 41 Chambers street, New York, are agents for this JOURNAL. Newsdealers will send orders to them.
Books.—We will mail, post-paid, at publisher's lowest rates, any book—scientific or otherwise—to any address in the United States or Canada. No books will be sent C. O. D.

CONTENTS.

An Asterisk (*) denotes an illustrated article.

OFFICIAL NOTICE—	
Central New York Gas Engineers Association.....	253
EDITORIALS—	
An Unwarranted Slur.....	253
Ludicrous Antics of the Gas Reformers.....	254
A Change at Louisville, Ky.....	254
The Market for Gas Securities	254
Fifteenth Annual Meeting of the New England Association of Gas Engineers—Official Report—Concluded from page 230.....	255
Conclusion of Question-Box Discussion—"What is the cause of the clogging up of burner tips in houses that are situated at the dead ends of mains; and what is the remedy?"—"What is the best coke crusher?"—"Will gas at a temperature of 100 deg. give the same pressure on a gauge as it would at 50 deg.?"—"What percentage will gas shrink in bulk if the temperature is reduced 30 deg., or from 70 deg. to 40 deg.?"—"Fixing Compensation of Secretary and Treasurer—To Manage Arrangements for Semi-Annual Meeting—Final Adjournment;	
Papers Read before the First Annual Meeting of the Ohio Gas Light Association, with Discussions on Same—Official Report—Continued from page 235.....	257
What Plan or System is the Best for Discovering Leaks on Lines of Gas Mains; and What is the Best Jolt for Gas Mains?—Discussion—Papers by Messrs. Printz and Enfield on What Percentage of the Loss of Gas is Due to Leakage, and what to Condensation?—Discussion—First Day; Evening Session—What is it that Obstructs the Service Pipes to Lamp Posts and to Consumers. In Extreme Cold Weather: and is there any Way to Prevent this Annoyance? by G. Taylor—Discussion.	
Testing Gas for Carbonic Acid.....	262
*The Box and Waller Washer-Scrubber.....	263
Manufacture and Use of Oxygen.....	263
How Disease is Spread.....	263
ITEMS OF INTEREST FROM VARIOUS LOCALITIES.....	
Changes in the Postal Laws—Lighting Up Rittenhouse Square (Phila., Pa.) with Siemens Burners—Cheaper Gas for Montreal, Canada—Looking after an Increased Day Consumption—Messrs. Tanner and Delancy Secure a Contract—Obtaining Permission to Go Ahead—A Mysterious Sort of "Company"—Cheaper Gas for Dayton, Ohio—"Coming Down" Once More at Milwaukee, Wis.—Trying to "Find Out" where He "Comes In"—Something from Pittsfield, Mass.—Bangor (Me.) Turns on the Electric Light—The Death Roll—Street Lighting Awards in New York City—An Electric Lighting Company for the Harlem District, N. Y.	

[OFFICIAL NOTICE.]

CENTRAL NEW YORK GAS ENGINEERS ASSOCIATION.

OFFICE OF THE GAS LIGHT COMPANY, OF SYRACUSE, }
SYRACUSE, N. Y., April 30, 1885. }

The Sixth Annual Meeting of the Central New York Gas Engineers Association will be held in Syracuse, N. Y., on Thursday, May 21, 1885. Headquarters will be at Globe Hotel. Those intending to be present will confer a favor by notifying the Secretary on or before May 19th.

Any person interested in the manufacture of gas in central or western New York is eligible to active membership.

We cordially invite members of other Associations to be present.

H. N. BABCOCK, Secretary.

AN UNWARRANTED SLUR.

The May number of the *Electrician and Electrical Engineer* contains a rather mean slur on a most painstaking and fairminded official of New York city, and we regret that our contemporary should go so far out of its way to do an injustice toward a man who has done so much for public street lighting in this city during the past few years. In an article headed "Darkness Preferred to Light," the *Electrician*, in pursuance of its undoubted right, goes on to discuss the report submitted to the New York city Board of Aldermen, on April 24th last, by Mr. Stephen McCormick, Superintendent of Lamps and Gas, in which that gentleman furnished figures estimating the comparative cost of street lighting by gas and electricity. Our contemporary claims that Mr. McCormick's figures showing that resolutions of the Common Council "called for 2,003 additional arc lights to replace 5,345 gas lamps," are apt to convey "a very erroneous impression as to the efficiency of the electric lights;" and then makes the claim, "The records prove that they have heretofore replaced from 8 to 12 gas lamps each, according to location." Even supposing that "heretofore" (and the figures of the *Electrician* are decidedly far from being correct, as the average displacement has never exceeded 6½ gas lamps to one arc) an arc did displace "from 8 to 12 gas lamps," this in itself is no proof that the 2,003 additional arcs called for by resolutions of Council would displace a single more post than the 5,345 returned by the Superintendent. However, what we wish to call particular attention to is not that, but this: The *Electrician* then remarks, "The Superintendent goes so far as to say, 'I have not discovered any advantage which the electric light possesses that cannot be obtained from gas lighting, except the instantaneous lighting'"—putting the following slur upon the motives which impelled Mr. McCormick to make the above assertion: "If there is any job lurking in the suspicious statement of Supt. McCormick, perhaps a beam of light turned in that direction may unearth some interesting developments." Not only do we assert that this is a decidedly mean slur upon Superintendent McCormick, who has time and again, and at a period long before the *Electrician* had graced the world of technical literature with its presence, shown the honest sort of stuff that enters into his composition; but we would also submit that the *Electrician*, if it is so eager to "turn rays of light" upon "jobs," might find plenty of material worthy of illumination if it would only explain how it is that the electric lighting companies managed to induce the city to pay them 70 cents per night for each arc light maintained by them!

LUDICROUS ANTICS OF THE GAS REFORMERS.

The defeat of "Sherman, Thurber & Co.," as experienced at the hands (and votes) of the members of the New York State Assembly on the afternoon of April 30, has thrown these worthies into a most frenetic state of mind and feeling. In fact, if their bodies had been subjected to contact with the current developed from a high-power dynamo they could not by any manner of possibility have indulged in a more extensive or varied assortment of contortions than those displayed by them after receipt of information that the "forty thousand dollars per annum" commission measure had been buried beyond the hope of resurrection; and, in truth, we were inclined to pity rather than laugh at the picture they presented when the conviction was forced upon them that their "little game was up." As far as the merits of the defeated Commission bill go, we do not propose to enter into any dissection of them; but will dismiss the whole thing with the remark that the measure was abortive in every respect, and not possessed of a single feature that could recommend it to the favorable verdict of either the gas maker or the gas consumer. Mr. Sherwood may be an authority on "flats," or apartment houses; Mr. Thurber may know all about the manufacture and sale of glucose, and be equally well posted in regard to the make up and distribution of various brands of cheap cigars; Mr. Schultz is undoubtedly an expert when it comes to delving into the mysteries of the respective and comparative merits of different grades of "pebbled goat," superfine French calf," etc., leathers, and could probably tell at a glance whether a hide had been properly tanned or not; and Mr. Bottsford, beyond cavil, is accurately posted in the art of correcting printers' proof sheets. Still, possibly we may be pardoned by one and all of these gentlemen if we gently convey to them an intimation that when it comes to the question of a real knowledge of the science and practice of the manufacture of gas they know just as much about these things as does "the man in the moon."

"Fools rush in where angels fear to tread," and it does seem as though the old saying had a good deal of truth in it, more especially so when we behold the real estate speculators, wholesale grocers, leather tanners, and amateur journalists of a great city like New York boldly, and in the most off-handed manner, combining together with the avowed purpose of "regulating" a business of which they know absolutely nothing. What a rarely ludicrous thing it would be were General Roome to assume upon himself the task of telling Mr. Schultz that he was selling his leather at too high a price; or that he failed to give proper quantity according to the bargain made. Yet that in effect is what the reformers say to the General. They say the gas rates are too high, and the meters are a fraud. The JOURNAL has always been an advocate of low gas prices, and not on account of any high moral reasons either. Years of experience have taught us the pecuniary value of low rates and stability of profits arising from them. Where rates are low but little temptation is offered for the investment of new capital—in short, cheap gas throttles mere speculation, and builds a safeguard broad and high around investments honestly made in the business. If the capital of the Consolidated Company is excessive, and that all its shares do not fairly represent an actual money investment, that is only to be attributed to the foolish operations of former "reformers," whose disregard of the simplest known commercial laws enabled schemers to obtain the possession of grant after grant for the establishment of opposition works. The "reformer" predecessors of those of the present day caught the fever of regulating the gas business by the aid of competition, and so the work of piling up the capital went merrily on. But, since our readers are already well posted in these matters, it is futile to pursue them further here.

As far as the meter portion of the Sherwood wail is concerned, the very stupidity and dense ignorance of the claim should be apparent to any ordinarily intelligent mind ere the echoes of the bray had died away upon the lips of the utterer. The New York Assemblymen did credit to themselves when they refused to give assent and consent to the enactment of a measure that emanated from the addled brains of a handful of zealots, who, in the intensity of their egotism, supposed that they had but to say, and it were done. We do not say that the Sherwood clique may not in time learn something about the principles governing gas supply; but it would far better become them, and possibly entitle them to consideration, did they begin with the primer of the art instead of attempting at first to dictate the letters of which the alphabet of that art was to consist. Their trick of May 13th at Albany, in connection with the measures known as the Cullen and Coffey gas bills will avail them nothing during this session. And if they can learn by the experience gained in '85, perhaps wisdom (or at least a grain of it) may appear in their efforts at lawmaking in '86. Still, it must be unfortunately conceded that cropping the ears of a certain loud-voiced quadruped does not succeed in making that animal resemble the descendants of the Godolphin Arabian.

Before leaving this subject we cannot forbear making some mention of the mass meeting held at Masonic Temple (in this city, on night of May 6th), at the instance of the "Gas Consumers Association," the main and the avowed object of the conclave being to signify how deeply and badly the "Associa-

tion" was suffering on account of internal wounds received at the hands of New York State's lawmakers on the afternoon of April 30th. President Sherwood and Secretary Gardner had conceived the brilliant idea that the proceeding at Masonic Hall would be enhanced did they make it assume, in its preliminary shape, somewhat of the aspect of a funeral; consequently thousands of handbills, surrounded with a deep black border, were scattered broadcast through the city. These handbills bore the heading, "The fight for honest gas!" like as though any one had ever heard of dishonest gas; and they were also strangely silent on the subject as to what sort of crime the gas had committed; and stranger yet the whole discussion on the night of the 6th appeared to hinge closely upon the honesty, or reverse, of the Albany Assemblymen. The "getters up" of the meeting, in so far as they counted upon having a funereal assemblage were pretty nearly correct. The hall was about half occupied, and the "fight for honest gas" was waged to empty benches. It needs no repetition here of what was done to make the proceedings recognizable to our readers. Sherwood, Schultz, *et al*, were there in full force, and "whereases" and "resolves" were indulged in to an unlimited extent. From some of the statements made there we find it was gravely asserted that—"Pressure was brought to bear on some of the country members by local gas companies. The assistance of these instruments was invoked by and through the American Gas Light Association—an organization of gas companies apparently for both offensive and defensive purposes. It professed to see in this bill an entering wedge of widening legislation." Can anything equal to this for downright stupid mendacity be presented? We reprint this statement as it appeared in the columns of the *Tribune* (giving detailed report of the Masonic Temple proceedings), of date of May 7th. We have not observed any contradiction of it subsequently made by the "reformers," and we are obliged to believe that they so put themselves on record. With the above example we may take our leave of the "reformers," pure and simple, and, by way of closing out the subject, note that it would seem more rational did that Harlem preacher—who holds forth at the Unitarian Church, 128th street in this city, and who spoke last Sunday to the topic of "Honest Gas"—forsake the pulpit for the trapeze. He would give less scandal in the latter situation.

A CHANGE AT LOUISVILLE, KENTUCKY.

It has not been generally known to the fraternity that Mr. J. H. Baxter, formerly President of the Louisville (Ky.) Gas Light Company, had succumbed to the attacks of the grim reaper. His death occurred on the 30th day of last March. At the meeting of directors subsequently held to fill the vacancy thus created a unanimous vote of the board resulted in the elevation of the Hon. Geo. W. Morris to the presidential chair. Mr. Morris has been a director in the company for several years, and is well qualified for his new position by an abundance of business tact gained through an intimate connection with various business enterprises. His suavity and tact will be of valuable assistance to the Louisville Company in its present battle with the mongrel combination of usurpers now operating there under the title of the Citizens Gas Light Company. Even with gas rates at \$1 per 1,000, the old company is managing to accumulate a surplus, and Mr. Carley, despite the frantic appeals and comic posturings of his "man, Fitch," may yet have occasion to regret the hour in which he listened to the siren-like blandishments of the U. G. Imp. Co.

The Market for Gas Securities.

In our quotations for gas securities in last issue Consolidated of New York city was reported at 90 bid, offered at 91. As was naturally to be expected the defeat of the high-priced commission scheme by the Assembly of New York State had the effect of stiffening prices, and the brokers were kept busy in supplying stock to parties seeking sound investment parchment. During the fortnight about 10,000 shares changed hands between the figures of 93 and 96½, the latter quotation representing latest transaction heard of by us up to time of writing (noon of May 14), at which notch 100 shares were sold. There is every likelihood that Consolidated will go to par before "Decoration Day" of 1885. It is pretty well authenticated that a dividend of three per cent. will shortly be declared. The feature of the city market, though, is the upward movement in Equitable, which we now quote at 124 to 126. Mutual is higher at 130 to 132. In regard to Equitable it may just possibly be the case that the "insiders" are manipulating the shares in order to gain the confidence of investors with respect to the placing of the stock of their new scheme at Baltimore, Md. Be this so or not, we would advise "outsiders" to part with their New York Equitable holdings at the present (or even a trifle below it) market figure. Brooklyn stocks are steady to strong.

In out-of-town shares it is understood that the Philadelphia Philanthropists are endeavoring to obtain control of the old St. Louis (Mo.) Gas Light Company. Should they eventually succeed it will cost them a neat sum, as \$800 is bid on each par value of one hundred dollars. Laclede, of St. Louis, is looking up; Jersey City (N. J.) is strong; and the same may be said of Louisville, Ky., and Washington, D. C. For regular list, see page 166.

[A despatch from Chicago (May 15), says that Pres. Lackland of St. Louis Company refuses to continue negotiations with the Philadelphia speculators.]

[OFFICIAL REPORT—CONCLUDED FROM PAGE 230.]

Fifteenth Annual Meeting of the New England Association of Gas Engineers.

HELD AT YOUNG'S HOTEL, BOSTON, MASS., FEB. 18 AND 19, 1885.

SECOND DAY—MORNING SESSION—FEB. 19.

CONCLUSION OF QUESTION-BOX DISCUSSION.

The next question taken from the box was the following :

"What is the cause of the clogging up of burner tips in houses that are situated at the dead ends of mains; and what is the remedy?"

The President—Col. Stedman, have you any "dead ends" on the Newport gas mains?

Mr. Stedman—We have a few places or locations where trouble has arisen from stoppages caused by an accumulation of fine particles in the burner, the effect of which would be to destroy the structure of the flame; but we have always had the greatest trouble of that sort when we have put in an extension to a main (to supply a new district) which terminated in a "dead end." For a year or two after the main was laid we would have the stoppages. We changed from batswing to fishtail burners, in order to overcome the difficulty. We have sometimes used large burners, packing up their interiors with cotton or wool for the purpose of arresting the passing particles. We have found that the fishtail burner is less likely to become obstructed than the batswing burner. In a few particularly bad cases we were obliged to change all the burners in a number of houses (substituting fishtail for batswing) in order to overcome the stoppages constantly occurring when the batswing burner was in use.

The President—Did you find that there was more of this trouble experienced near the "dead ends" of mains than in ordinary locations on mains?

Mr. Stedman—Yes, sir. We attributed the trouble to the new iron, believing that a great number of minute particles from the newly made castings were loosened and swept along with the gas. I know that the stoppage trouble would abate in the course of a year or two from the time the new pipe was put down. In one case, where we laid from 700 to 800 feet of 4-inch pipe, stoppages occurred during a period lasting about three years. At the termination of third year the trouble ceased, and we have had no more complaints from that point, in spite of the fact that we have not extended the main any further. In still other cases where we have extended our mains, and had obtained quite a number of consumers on the new extension, we experienced, for a short time, trouble with them all. When relief was once secured the stoppages never recurred. I would not ascribe these stoppages to the fact of the creation of a dead end on a main, but, as said before, I adhere to the belief that they are occasioned by the detaching of minute particles from the interior of the newly made iron.

The President—Have you ever had any trouble with new mains which did not terminate in dead ends?

Mr. Stedman—No; I do not think we ever did. I remember one time when we put in a 12-inch main to replace an old 3-inch one (at about the center of the town), and I do not recollect that we had any difficulty at all. In the particular case spoken of above (the new district with the supply main thereof ending "dead") the location of the pipe was between $2\frac{1}{2}$ to 3 miles distant from the works, and the work was done at different periods—say at three or four intervals, and laying between 300 and 400 feet at a time—occupying perhaps three years for its entire completion. Now, each time that main was extended the stoppages would occur in the burners supplied from the new pipe, the difficulty entirely disappearing after the lapse of a year or two—indeed, seemingly being determined by the greater or lesser number of services that would be tapped into it. It seemed to take just about so much gas to clean up the particles, no matter whether that amount was used in six months or in one or two years. I do not know why we should not have the same difficulty when we put in a new main through the center of the city; but I have never heard any complaints from consumers so located. Possibly the particles were swept along out of the range of the consumers on that line, and thus distributed among so large a number of consumers as not to exert any appreciable effect in any particular case.

Mr. Harbison—We have very few dead ends in our system of mains at Hartford; but, as against Mr. Stedman's theory of the difficulty only occurring where new mains were laid terminating in dead ends, I can say that one year ago last fall we laid about 8,000 feet of new pipe in order to reach one consumer. The parties used the batswing burner all through their building; and they have had no difficulty during the fifteen months they have been using the gas supplied. We have another line, nearly a mile in length, laid three years ago, to reach one house, and we have had no difficulty at all. With these examples, I think the difficulty cannot be caused by "particles sweeping along the main."

Mr. Yorke—In case of such stoppages I would be apt to recommend that the parties purify their gas a little better; and mentioning this, I might re-

late an experience gained several years ago, and which served as a good lesson to me. Being absent from my works at one period for over a week, when I returned I dropped into the company's office. While there a consumer came in and inquired from the clerk why the gas smelled so bad; or rather said there was a bad smell in his premises, and that he had attributed it to the gas. It occurred to me that perhaps the gas had been allowed to get foul. I went right up to the works, tested the gas, and found it to be foul in both holders. The ammonia was up to 40 or 50 grains. Shortly after that complaints of clogged burners came in from all sections of the town, and of course the clogging up must have been due to the foul gas sent out. It took a week to end the trouble.

Mr. Nettleton—I am glad this question has been asked, for during the last winter I have been exceedingly annoyed in that way in my own house. I live at the end of a long line of pipe laid last fall, and on which there are very few consumers. At first I used lava-tipped batswing burners, but was annoyed at once by the burners stopping. I changed the tips frequently, but it did no good. Finally I put on brass fishtail burners; and since then I have had very little trouble. There is certainly some cause for these stoppages.

Mr. Harbison—What kind of burners did you put on?

Mr. Nettleton—Principally brass-tipped fishtail burners, and a few of the Bray fishtail description. I think the difficulty must be attributed to something besides the new mains, because I have had the same experience as that recounted by Col. Stedman—laying new mains through the center of the town, when very few burners were stopped.

Mr. Stedman—Our experience of noticeable trouble in that direction has been so uniformly coincident with the laying of new mains at a distance from our works, or where they would form dead ends, that we have been forced to the conclusion that there was something in the new mains that caused the difficulty. As to the matter of purification, we rather pride ourselves that we get most of the impurities out. We always have our ammonia below five grains, and we always keep one clean purifier through which the gas is going. We test the third purifier, and have one entirely clean box. I was in a town once where no pretence was made of taking out the ammonia, but where they *did* change the purifiers once in a while—doing so, nevertheless, without any regard to their fouling; and the purifiers were at all times so hot that you could not bear your hand on the first one, the station meter itself being so warm that you did not want to keep your hand there a great while. The gas went through with pretty much all of the original impurities left in it; and where that gas would burn *at all* they did not have the least difficulty with stoppages of the burners. I know of one large mill that used the gas, and the only difficulty the mill owners had with it was that they were compelled occasionally to shut down the mill and dismiss their operatives because the air got so contaminated with sulphur that they could not breathe it.

Mr. Snow—At Holyoke during the last four years we have laid about six miles of new pipe, some of it in the heart of the city and part of it in the suburbs. With the central portion we have had no trouble at all, and stoppages are only to be found in burners located on and near dead-end mains. Last fall, in order to reach two consumers, we laid 3,800 feet of pipe. The consumers had such continual trouble (the buildings supplied were private residences) that they were obliged to replace the burners every few nights.

Mr. Stedman—I think Mr. Snow will find a remedy by using brass-tipped fishtail burners—the Bray description, for instance.

Mr. Snow—I am glad to hear that. If the brass tips have not been tried I will recommend the substitution at once.

Mr. Learned—We had this same trouble at Newton Center, and conquered the difficulty by putting on the Bray fishtail burner.

The President—This discussion has shown the value of the question-box. Here is a matter that has bothered many people; Mr. Snow has got something out of this discussion, and perhaps Mr. Nettleton may also get something out of it. It is a practical question, such as we want to hear discussed here.

Mr. Snow—There is yet another point I will mention. The house of a consumer is close to a dead end, and the location is on high ground. The burners kept clogging up, and we were inclined to believe that the stoppages were caused by the high pressure. We put on a governor to bring the pressure down to about one inch; the stoppages then ceased. Whether that plan would work in every case or not is a question to be determined.

Mr. Stedman—In the particular locality referred to by me there was no excess of pressure.

Mr. Wood—Just at this point I would like to say that we have had a great deal of trouble at Syracuse this winter from the clogging up of consumers' burners in different parts of the city. It cannot be attributed to new pipes, because the stoppages have been quite as bad on the old pipes as on the new. We have done what we could to see that our gas was thoroughly purified; it has gone out clean, free from sulphur or ammonia. I am inclined to ascribe the trouble as a consequence of the extreme cold weather experienced this winter.

The President—I think everybody has had some trouble with burner stoppages this winter; and I believe Mr. Wood's theory quite nearly accounts for the vexation.

The President—The next question is—

“What is the best coke crusher?”

I think Mr. Slater crushes his coke, and can probably answer the question.

Mr. Slater—We borrowed the idea from Mr. Stedman.

The President—What style of crusher does Mr. Stedman employ?

Mr. Stedman—The crusher we use is a simple device gotten up something after the suggestion of the “picker” in an ordinary cotton mill. Imagine a series of stationary teeth set in the bottom of a box, and between these revolve the teeth placed on a spindle or shaft which makes about 300 revolutions per minute. The teeth, revolving with a good deal of speed, strike the coke with considerable force; and we think the result is that the coke is cracked rather than crushed. We thus get the minimum of dust and small particles as a consequence of coke breaking. Of course, a machine like the one I have attempted to describe can be made to crush any amount of coke in a given time. It is simply a question of the size of the box, the number of teeth, and the power necessary to run it. At our place we can crush about 100 bushels per hour; but we have no occasion to crush that quantity. We generally crush about 90 per cent. of the coke which we sell, since it is all taken for domestic use. The last mill to be operated in our city was recently closed out under the “hammer,” and at the present time we have no manufacturing establishments at all. As a consequence, our sales of coke are restricted to the requirements of domestic use; and we are obliged to prepare our coke so that our customers can use it conveniently in their stoves.

Mr. Yorke—Is your crusher run by power?

Mr. Stedman—Yes; and in handling a quantity of coke there may be a good many economies introduced—such as raising it into the crusher without the intervention of hand labor.

The President—Does the crusher break the coke to the same size, whether it runs fast or slow?

Mr. Stedman—We run at a uniform speed, and have never tried to vary it. I think it would be apt to break the coke into larger pieces if run slower. Each piece is now struck a blow so violent that it almost knocks it out of the machine into the screen.

The President—Is there a patent on your machinery?

Mr. Stedman—No.

The President—Has any other gentleman any information to volunteer on the subject of crushers?

Mr. Leach—I do not see Mr. Cushing in the room; but I recently understood him to say that in trying a coke crusher he found that he could do the work very much faster by hand. I do not know how he managed it, but that is the remark he made.

Mr. Stedman—It would depend upon the number of hands employed.

Mr. Leach—But he said that, with the same amount of help, manually he could break coke faster than he could by machinery.

Mr. Stedman—When we first put our crusher in we sold but a very small percentage of our coke in the broken state; but the demand has gradually increased, until now we find it necessary, in order to make speedy sales of coke, to crush nearly the whole of it. If we were to fit up anything new we should handle our coke entirely by machinery—that is, we should elevate it (after wetting) into a hopper, from which it could be fed directly into the crusher; be carried from that onto the screen, and then be dumped into bins sorted out and ready for sale, without having been once touched by the hand. I am confident that no one could begin to crush coke so economically by hand as he could by a proper system of machinery. As at present arranged, we wheel our coke in barrows, and dump it into the machine entirely by hand; and of course that system is not very economical. There is no question about the economy of using machinery, because one man, provided he had the machinery necessary to elevate the coke, could break more coke in one hour than could be done by six men by hand in a day.

Mr. Leach—I was very much surprised at the remark of Mr. Cushing, as I had seen the Stedman coke crusher at work, and had become impressed with the idea that it represented a great advance over hand practice.

Mr. Sherman—I think Mr. Nettleton can give us some information on that subject.

Mr. Nettleton—I use the Stedman crusher. I have never tried coke breaking by hand, as I have always considered it cheaper to break by power.

Mr. Howe—I would like to ask Mr. Stedman if he could give us figures so that we may tell about how great the expense of crushing is? That is the test of the whole thing.

Mr. Stedman—Our net returns average about 6½ cents per bushel from the coke when we sell it for eight cents. That would be 1½ cents per bushel

for the entire expense of handling the coke, including the loss by breaking. Of course, it would be as cheap for us to sell the coarse coke in the first place at 6½ cents as it would be to sell it at eight cents when crushed. We reckon the loss in bulk at 10 per cent. I find that our figures warrant us in carrying about that percentage. In other words, if you take 40 bushels of coarse coke it nets you 36 bushels broken coke. We do get some breeze which we use in our lime kiln; but we do not reckon that at all. By reason of its being broken into stove size it measures more compactly, and we get more weight per bushel.

Mr. Slater—Has Mr. Stedman in mind the figures of the comparative weights, by chaldron, of coke before and after it is crushed?

Mr. Stedman—I have not that in mind now.

Mr. Slater—Our experience is that the average weight of a chaldron of coarse coke, as it comes from the retort house, and as we sell it, is 1,600 pounds to the 36 bushels, and that a chaldron of broken coke, or just as we sell it, would weigh from 1,900 to 2,000 pounds.

Mr. Stedman—It must have a good deal of water in it.

Mr. Slater—We have had, and for several months at a time, every load of coke that went out of the yard weighed, and a record of the weight kept. From it I find that the average weight was about 1,600 pounds.

Mr. Lamson—Thirty-six bushels of coke, in the quantity that we handle, will average from 1,800 to 2,000 pounds. We now sell our coke by the ton of 2,000 pounds.

Mr. Stedman—Then the gentlemen who get 42 bushels of coke from a ton of coal must obtain a pretty good return in weight.

The President—Probably dry coke will not weigh that.

Mr. Stedman—There must be an enormous quantity of water in it; for ordinarily I think I sell from 1,450 to 1,500 pounds of dry coke to the chaldron.

The President—You are saving of water at Newport.

Mr. Slater—I beg pardon for bringing up that subject. Indeed I had no idea that I would again bring up the old coke question.

The President—We have not time to-day to discuss the question of what a bushel of coke is. We have other questions here, one of which is—

“Will gas at a temperature of 100° give the same pressure on a gauge as it would at 50°?”

What do you say, Mr. Prichard?

Mr. Prichard—Yes.

The President—No one contradicting that answer, the question is answered in the affirmative. The next question is—

“What remedy is there for tar in gas after leaving the holder?”

Mr. Stiness—It should not be there.

Mr. Slater—There is no remedy.

Mr. Harbison—Pump it out.

The President—The matter seems to excite the smiles of the members; but the gentleman who asked the question probably does not see the joke.

Mr. Cabot—Perhaps Mr. Yorke's remedy for stopped burners might apply here: Purify the gas better in the first place. I do not know of any better answer to that question than that conveyed by Mr. Harbison's suggestion to pump it out of the drips.

The President—Still another question is—

“What percentage will gas shrink in bulk if the temperature is reduced thirty degrees, or from 70° to 40°?”

Mr. Stedman—According to the rule which has been laid down, gases expand 1-480th of their bulk for each degree of temperature. For 30 degrees this would give one-sixteenth of the entire bulk.

The President—Because the temperature sinks 30° it does not follow that all the gas in the gasholder would respond to an equal fall. Sixty thousand feet of gas shrinkage out of a million would be considerable.

Mr. Yorke—My experience is that the bulk is decreased to the extent of one-quarter of one per cent. for each degree. I do not know what ratio of expansion would follow as a consequence of a great rise in temperature.

The President—It would then be about seven per cent., instead of six.

Mr. Yorke—I tried that experiment several years ago. During cloudy weather the sun, acting on one side of the holder, would make quite a difference. I made the experiments always in cloudy weather, taking the temperature of the atmosphere at an early hour of the morning, and again in the heat of the day. With one holder that we had not used for several months I tried the experiment several times; and the best result that I could get was about a quarter of one per cent.

The President—It is a fact that the large uncovered gasholder maintained by us just across the line at Roxbury expands so much from the heat that, during warm weather, we never dare to put it up full, because it expands so rapidly, when the sun comes out at the middle of day, as to put it up over two feet. That holder has a capacity of one and a-quarter millions; but if we had 900,000 cubic feet stored, and the temperature should rise rapidly, as is often the case when murky or rainy mornings clear up towards noon

with bright sunshine, it would go up with a rise equivalent to that caused by the addition of 100,000 feet.

Mr. Spaulding—I find that our men very often charge according to the holder. At our works the holder is uncovered; and we go pretty much according to the weather. On a warm day we cannot charge near as heavily as we can on a cool day.

Mr. Prichard—In addition to the expansion of the gas there will be watery vapor deposited. Gas at 60° will contain more watery vapor than it will at 30°. The difference is quite appreciable. There is also a certain amount of illuminants deposited on a cold day, which are taken up again in warm weather (as everyone knows) in an uncovered holder.

FIXING COMPENSATION OF SECRETARY AND TREASURER.

Mr. Neal moved that salary of Secretary and Treasurer be fixed at \$50 per year, that sum to cover his personal expenses while in attendance at the meetings. Mr. Neal regretted that the funds of Association would not allow the sum of \$100 to be set apart, and asserted that \$50 was insufficient. During the 14 years that he (Mr. Neal) had held the position his expenses had invariably exceeded by \$15 or \$20 the sum allotted by Association. For the last few years \$25 was the amount set apart, and that was altogether too meager. Mr. Stiness seconded the motion, and the members ratified the resolution by unanimous vote.

TO MANAGE ARRANGEMENTS FOR SEMI-ANNUAL MEETING.

On motion of Mr. Neal, the Board of Directors were authorized to make all necessary arrangements for semi-annual meeting of Association to be held on a date in August next.

FINAL ADJOURNMENT.

Shortly before adjournment the Chairman read a letter from Mr. H. H. Sheldon, in which that gentleman invited the Association to visit several places where his new attachment for burning gas in ordinary coal stoves could be seen in operation. This device has since been widely advertised as the "Vice-Versa" Range.

On motion of Mr. Stiness, Chairman Greenough declared the business sessions of 1885 had terminated.

[OFFICIAL REPORT.—Continued from page 235.]

Papers Read before the First Annual Meeting of the Ohio Gas Light Association, with Discussions on Same.

FIRST DAY.—AFTERNOON SESSION.

The President announced that no paper having been received bearing on "Subject No. 7," the title of same being—

"WHAT PLAN OR SYSTEM IS THE BEST FOR DISCOVERING LEAKS ON LINES OF GAS MAINS; AND WHAT IS THE BEST JOINT FOR GAS MAINS?"

he thought that, as the questions were of great practical importance, it would be a good idea to hold a verbal discussion on the topics included in "Subject No. 7." The members coincided with the suggestion advanced, and thereupon ensued the following

Discussion.

Mr. Huntington—For years the Columbus Gas Company used lead joints exclusively, and a result of the policy was the gas gradually honeycombed the lead to such an extent that the joints leaked. This experience led the company to adopt the cement joint, and its use has been adhered to. Many originally opposed the cement joint because it would not yield; on the other hand, they urged that the lead would "give" a trifle if the pipe moved. At Columbus we have for a long time confined ourselves exclusively to the cement joint. This is an interesting question, and it has also excited a good deal of discussion at the Columbus works, in which sharp differences of opinion were at times brought out.

Mr. Bate—I know very little about cement joints; but with regard to Mr. Huntington's statement as to the honeycombing of lead joints, it is just possible that may account for an experience I once went through. When I took charge at the Tiffin works there was a heavy leakage all over the city. One could hardly walk the streets without encountering the smell of gas. I at once overhauled the conduit system until now we have less than 1,000 feet of the pipe underground that was doing duty when I assumed control. I encountered leakage almost at every joint. I had an idea that the lead was eaten away. I found that what was supposed to be a corrosion was simply an opening of the space between the inside ball and spigot end of the other pipe, so that when the joint was run there had been no chance for the lead to flow back into the interstice. I found on some inside sections places where there was perhaps not a quarter of an inch of lead to interfere with the leakage of gas; then in other places it might run back 2 or 3 inches. As to the "giving" of the lead, I discovered places where the pipe had drawn one-half inch, and I imagined if that was caused by expansion something "would have been pulled loose." I made all lead joints, making it a point

to use about twice the quantity of lead set down in the formulas, and now I have no leaky joints.

Mr. Robinson—The condition of our pipes was thoroughly arrived at because of the fact that the pavement of the main street in our city of Columbus was being torn up preparatory to relaying. The time being of course favorable to look after our mains, we tried each joint, finding escapes of gas at almost every one, some being really bad cases. The remedy employed was to tap up the lead and put in what our superintendent called a "wiped joint." Afterwards, when the Parisian style of pavement was put down, we took this conduit up, and replaced it by two mains to right and left of street, doing this so that when putting in services we would not be obliged to dig through an unnecessary length of the asphalt and rock materials composing the new pavement. The new mains were of much larger diameters than the one they replaced. The new joints were made of cement. Our Board had concluded it was good policy to cease using lead. We also had experience with a tar or asphalt-coated pipe. We did not put down any great length of it, but did find that the influence of the gas on the coating was such as to finally reduce the covering material to a sort of paste or powder. That condition reached, the joints commenced leaking all around; and it seemed to make no difference whether lead or cement was employed to make the union. This experience induced us to abandon coated pipe, and for the last 15 years nothing other than plain, uncoated pipe, fitted together in plain cement joints, has been used at Columbus.

Mr. Fullagar—Have you noticed what action naphthaline (particularly in Spring) has on cement?

Mr. Robinson—We once took up an entire line of 4-inch pipe, running through Third street of our city, with the intention of substituting a larger conduit. The joints on the stripped line (they were laid in cement) were thoroughly examined. It was found that the cement we had used—it was the best quality of Roman cement that we could purchase—had become apparently about as hard and impervious as the iron itself. It seemed to adhere to the iron with remarkable tenacity. About the only trouble we found with it was that occasionally a pipe would have to be pulled apart. There was no "give" to the joint; it was about as "stiff as a rail." I might say that our soil is admirably adapted to the maintenance of pipe in original condition, it being a firm, gravelly loam. I do not know of any serious case of "pulling apart" that happened with us during our use of the cement joint. Of course we have an occasional leak, just as is the experience of other gas managers.

Mr. Fullagar—I have observed statements emanating from engineers in various cities that, on removing pipe laid with cement joints, they often discover the under part of joint in a pliable or plastic state. I remember one case where a line of all cement pipe about 800 feet in length, and laid to carry foul waste away from the condensers, caved in at the end of third year. It seems to me to be only a question of time when engineers who have made the change from lead to cement joints invariably go back to lead; and I would estimate the time it takes to convince them as to the superiority of the leaden joint at between eight to ten years.

Mr. Bushnell asked Mr. Robinson whether he could state the comparative cost as between cement and leaden joints.

Mr. Robinson—I am not able to answer that question. I can tell you the price of cement, but could not say as to the difference in cost between quantities of each material requisite to make a joint. Our method of making a cement joint is this: First put in a band of oakum and pack in the cement; next add a second band of oakum, and close the mass up solidly by tamping; outside of that filling make a wiped joint.

Mr. Bate—When Mr. Robinson was speaking of the joints being "as stiff as a rail," it occurred to me that there was a question as to the durability. At one period I used wrought iron to a considerable extent, because I could place it quicker and, at that particular time, buy it very cheap. I put down about 700 feet, making allowance here and there for an expansion joint. I had to use the joint on account of, or to provide for, extremely cold weather. This line showed a very heavy expansion and contraction movement, and if the pipes had been screwed closely together they would have broken apart. Now, on ordinary cast iron mains with lead union I have never had a joint to break.

Mr. Enfield—I have had but little experience with the cement joint, and that trifling experience is not favorable to the practice. Certainly, there are a good many sorts of cement. The Columbus people use Roman cement; the cement I tried was known as "Louisville," and the "Louisville" description had always been employed at the works with which I have been connected. During last summer, in looking after leaks, I had occasion to inspect a great many joints. I did not find any very large escapes, but almost invariably I found that the cement had parted from the pipe, and oftentimes had cracked so badly as to permit slow escapes of gas from the main. When laying pipe last summer I put in one lead joint to every nine or ten lengths. Good yarn should be inserted, and the good tight yarn joint should be completed with a good lead finish. Yarn is elastic; and I have

seen it taken from joints, where it had been concealed some 10 or 15 years, still remaining elastic and tough.

Mr. Gwynn—The Last speaker said that he used "Louisville" cement. Now, in my opinion "Louisville" cement would be utterly worthless for the purpose specified, as it will not stand when exposed to low temperatures. On the other hand, joints made with Portland cement will stand freezing without becoming impaired. In 1879 I laid two miles of pipe in the town of Upper Sandusky, putting it all in with Roman cement joints. I remained at that works until 1882, and can safely say our annual leakage loss did not exceed one per cent. Since '82 I have not visited that town, but have heard through inquiry that they have not had a case of pulling apart or breaking of the joints put down six years ago. I had rather looked forward there to broken joints as a consequence of contraction. I think a properly laid cement joint, with lead joints say every 500 or 600 feet apart, the best system that can be followed.

President Hickenlooper—Does the gentleman mean to say that the leakage was less than one per cent.?

Mr. Gwynn—Yes, sir.

President Hickenlooper—What kind of gas was it?

Mr. Gwynn—An oil gas. I had no choice as to the kind of joint or material; these were specified by the engineer.

Mr. McMillin—I fail to see how it is possible to lay a system of mains all over a city, putting in cement joints exclusively, and not only have leakage, but also a great deal of it. I cannot understand how it would be possible to get leakage down to one per cent. with any kind of joint, but more particularly so when employing cement. If you put down 10, 15, or 20 miles of main, often the mileage of many small towns, and then notice the difference of temperature that probably occurs in the ground between the heat of summer and the cold of winter, and make calculation of the expansion and contraction of that length of pipe, you will probably find that the mileage is from 50 to 100 feet longer in summer than in winter. I do not like the cement joint myself—certainly not when used exclusively. They have not had many broken mains in Columbus. In other works that I have control of, where cement joints are used exclusively, and where the leakage should be small, it is sometimes really very great. In towns where the temperature sinks to -30°, something has to give. I think it bad practice to put down cement joints, and I particularly disbelieve in their exclusive use.

Mr. Gwynn stated, with reference to the one per cent. leakage, that there was no day consumption in Upper Sandusky. The holder would stand all day without rising or falling an inch. He thought this was very good evidence that there was no leakage.

President Hickenlooper—Who built that holder?

Mr. Gwynn—I think it was built by a Pittsburgh firm.

President Hickenlooper—I had hoped you would say the Stacey Company. [The discussion here branched out into a consideration of the best method for discovering leaks; and the general weight of the testimony favored the "nose and probe" system. Messrs. Bushnell, Bate, Hamlin, Salter, Hickenlooper, McMillin, Fullagar, Taylor, and Printz were among those who gave their experiences on the subject.]

Two papers were submitted on the eighth subject of Secretary's Circular, Messrs. Eugene Printz, of Zanesville, and William Enfield, of Columbus, being the contributors. In accordance with the practice before instituted in the case of dual papers, the communications were read by the authors, their presentation being followed by a joint discussion. The subject treated of was,

WHAT PERCENTAGE OF THE LOSS OF GAS IS DUE TO LEAKAGE, AND WHAT TO CONDENSATION?

Mr. Printz first commanded the attention of the members, and he read as follows:

I scarcely can conceive why our Secretary should have assigned me the duty of preparing a paper on this particular subject, as it is one on which I had not given much thought previous to his writing me. His request was to prepare a short paper for the purpose of provoking a discussion on the subject; and if I succeed in doing this much, even should I not present anything new, I shall be satisfied, and think I have at least tried to perform my duty toward the Association.

Now, as the percentage of gas unaccounted for varies greatly in different localities, and from many sources—such as imperfect main pipes, improperly made joints, carelessly connected and leaky service pipes, public lamps allowed to burn over schedule time (when the gas is not measured by meters), and with burners on the lamps larger than the size agreed upon; and, again, we have long lines of main pipe with but few consumers, or small mains requiring excessive pressure to supply the demand on them, thereby increasing the loss from actual leakage, consumers meters registering too slowly—all these are among what we designate as external causes, *i. e.*, outside of the manufacturing department of the gas plant.

In the works proper we have, for instance, as likely causes of loss, water carried above the true line in the station meter, causing a proportionate in-

crease in registration over the amount actually passed; or, as is too often the case, the gas is measured at too high a temperature—instead of the standard 60° F., it is nearer to 70°; indeed, many times, as you all no doubt have noticed, as high as 80°. Now, as each degree above 60° adds, in round numbers, one foot in volume to five hundred, we will have for every five degrees above 60°, ten feet to the thousand; or, in other words, one per cent. of gas for every five degrees above 60° to be accounted for at the end of the year as lost by leakage; all going to show that what proportion of the loss of gas should be assigned to actual leakage is certainly a very difficult problem to arrive at.

A loss from leakage that would in one locality be considered a very small percentage would in another be reckoned as very high, considering the total amount of gas made; yet the real number of feet lost may be the same in both cases. For instance, the first may have a daily send-out of 100,000 cubic feet, with a loss of 5,000 cubic feet per day, or 5 per cent.; and a second case, with a daily send-out of 50,000 cubic feet, with a per diem loss of 5,000 cubic feet, or 10 per cent., will show that, while the apparent percentage of loss is doubled, yet the true loss is really the same actual quantity in thousands of feet. Again, one may have a greater number of miles of main pipe than the other, with the same loss per mile of pipes, and yet the one with the longer line of pipe will have the larger percentage of loss on the same make of gas per day. Were it possible to have the main pipes and services perfectly tight, and placed deep enough in the ground to prevent undue condensation, and with diameters fully large enough to supply all demands for gas at a moderately low pressure, consumers' meters registering correctly, with a true statement of gas consumed by public lamps, and particularly to have a correct registration on the station meter, then the percentage of gas lost by actual leakage should be very small indeed.

Loss by Condensation.

Some gas men claim that the loss from condensation is so small as not to be worthy of any consideration; this reasoning they justify on the ground that the naphthaline and other rich vapors condensed at one time are taken up at a later period, and are really carried on and not lost. This may be true; I hope it is, and will consider it so for the present. I have construed this question to mean not the condensation of naphthaline and other rich constituents of gas; but the condensation of aqueous vapor that may be, and is, taken up by gas in its passage through or over water—the amount or percentage depending on the temperature of the gas at the time. We find in "Clegg's Treatise on Coal Gas," at page 50, a table exhibiting the proportion by volume of aqueous vapor existing in any gas standing over or in contact with water at certain temperatures. At 40°, for instance, we have a given volume; at 60°, double that volume; and at 80°, four times the first volume. Now, I have reason to believe that in many gas works the conditions do exist by which a great amount of aqueous vapor is measured by the station meter as gas, and afterwards condensed on its way to the consumers' meters, it afterwards turning up on our ledgers in the shape of "unaccounted-for-gas." The gas passes the washer at a moderate temperature, is copiously washed with water; thence to the purifying boxes, containing lime which is necessarily very wet. The temperature there is raised considerably, and the gas absorbs or takes up water as vapor; now, the distance from the center-seal to station meter is too short to allow the condensation of but very little, if any, of the aqueous vapors, and they are measured as so much gas.

With the view of ascertaining practically the percentage of aqueous vapor in our Zanesville gas, I made a series of experiments, or tests, taking the gas just before its entrance to the meter, passing it through a box of dry lime, carefully measuring it before entrance and after exit, and from the difference calculated the percentage of moisture, purposely making the tests at such times that a number would be on days when the outside temperature was very low, and the others when it would be at a moderate degree.

At the Zanesville gas works we carbonize native coals which produce a gas containing a large proportion of the sulphur compounds, compelling the use of larger purifying boxes than usual for the amount of gas made, thus exposing the gas to a large surface and contact of wet lime. We have a Pe'ouze and Andouin condenser, ordinary pipe condensers, a tower washer, four purifying boxes, each 3'x10'x20', and thirty-five feet of pipe from center-seal to meter. I will read you the results as given by four of the tests, together with the temperature at the time the tests were made:

	Temperatures, Degrees Fah.			
	Test No. 1.	Test No. 2.	Test No. 3.	Test No. 4.
Outside atmosphere.....	18°	11°	37°	38°
Gas at entrance to condensers.....	108°	94°	102°	107°
Air of condenser room.....	60°	54°	70°	67°
Gas at entrance to washer.....	58°	55°	68°	66°
Air in washer room.....	48°	42°	56°	60°
Air in purifying house.....	64°	63°
Gas at station meter.....	70°	68°	80°	77°
Air in meter room.....	70°	70°	72°	70°
Percentage of loss by moisture....	.77	.80	1.83	1.40

Average percentage of the four tests, equal 1.20, which is equivalent to 12 feet to the 1,000.

The two first tests were made while we were putting out a daily make of about 90,000 cubic feet; the two last being taken when the make per day was 110,000 cubic feet. You will notice that in "Test No. 3" the percentage is much larger than is shown in "Test No. 4"—the temperatures of both being nearly alike. That difference of temperature I seek to account for in this way: Just previous to the time of "Test No. 3" a new or clean purifier had been turned on; but during the time of "Test No. 4" the purifiers were about ready for changing, thus giving "Test No. 3" the advantage of a box of very wet lime to work on.

While abstracting the moisture I made several tests; but could not detect any difference in the candle power of gas, either before or after passing it through the dry lime.

I am fully aware that the percentage of loss chargeable to the condensation of aqueous vapor, or the percentage which may be caused by registration at too high a temperature, will not affect the result as to the dividends of a gas company nearly as much as will the loss arising from leakage pure and simple; but it surely is difficult to persuade a stockholder that such is the fact—a percentage of loss to them is taken as such, no matter whether it be real or apparent.

Mr. Wm. Enfield was then introduced, and that gentleman occupied the attention of the Association in the following manner:

Mr. President and Gentlemen of the Ohio Gas Association:—It gives me pleasure to come before you with a few thoughts pertaining to the ratio of loss in unaccounted-for-gas chargeable to leakage and condensation, respectively. I am fully alive to the fact that I shall occupy the debtor side in the reading of this paper; and I want to thank you beforehand for your generous attention.

At the start I must acknowledge that I, at least, have no "knockdown" arguments on the matter in question, but hope that it may start some of us into a research which may aid and enlighten us.

In this proposition which we now make our text there may be many questions, with little of definite truths or data; but there may be some valuable suggestions which, in the absence of clear facts, may lead us to as satisfactory a solution of this problem as the case admits of.

Let us first deal with condensation, and how it occurs, looking also at the various causes which lead to the liquid depositions which we find in our mains and drip-boxes, and which we indiscriminately call condensation; and having arrived at some reasonably satisfactory conclusion as to the leakage, we may then, perhaps, assume a near approach to solution.

The general rule is to measure gas by the station meter before passing it into holders at a temperature as near 60° Fah. as possible. In some well-regulated works the custom is followed of correcting the volume of gas to mean temperature and atmospheric pressure, by reading the meter, thermometer, and barometer at stated intervals during the day, and making the necessary deductions or additions to the volume recorded. The general effect of these corrections is to reduce considerably the volume made as recorded by the station meter, notwithstanding the additions made during extreme low temperatures. In using these means we do not reduce the leakage and condensation, but simply make a nearer approach to a correct record, and thus avoid debiting an account with an undue charge.

Now, if we have put our gas into the holders, and have got, as nearly correct as is possible, the record of its volume, we may try to ascertain where that whole volume goes to. First, we are aware that this volume of gas carries with it a certain amount of watery vapor, and some vapors of the heavy hydrocarbons. Some of these vapors may have passed over from the retorts in the process of distillation; others may have been taken up by absorption and evaporation from the water in the holder tanks. This last cause of vapor in our gas may not be taken into account so far as the volume recorded is concerned; but will go to help explain the cause of the liquor found in our drip-boxes, etc.

It is an easy task to measure our gas and correct its temperature, etc., at the station meter; but not so easy to decide its temperature at the various points where we measure it to the consumer. We may, perhaps, average temperatures approximately, and get a partial view of the changes gas undergoes in distribution. For instance, we may take the average temperature of gas in our mains at, say, 45° Fah. Any diminution in volume between the measurement of gas at consumers' meter and station meter must go to leakage account; but we nevertheless now have one cause for the deposition of liquor.

The average temperature we estimate at 45°; this is 15° below the temperature at station meter, and as each 5° make a difference in volume of about 1 per cent., we may reason this as a cause of about 3 per cent. in our leakage account. Now, in the same line, we have 15° of decreased temperature which will make a difference in the quantity of liquor vapor carried by the gas. At 45° temperature, barometer 30 inches, gas will carry about 1.13 per cent.

of vapor, and at 60° temp., bar. 30 inches, about 1.87 per cent; or at the former temperature, .74 of one per cent. of volume less than at station meter. This three-quarters of one per cent. may be charged directly to condensation, and with it, perhaps, a small percentage of the condensable hydrocarbons. But I have a very grave opinion that the percentage of heavy hydrocarbons which may be dropped after passing the station meter, at ordinary temperatures, is very small. Whence then comes the liquor which we find in our drip-boxes, mains, meters, etc.? My answer would be, chiefly from leakage. Such imperfections as will let gas out will also let water in.

We have found how three-quarters of one per cent. of the volume measured by station meter may be deposited as condensation, and we may add to that whatever vapors may be suspended in the gas by any increase of temperature above 60° imparted to the gas in the holders where it stands over water. For example, we may put the average temperature in the holders at 70°, or 10° above the mean temperature as measured, and at this increase of temperature the gas will carry an additional amount of vapor of about .7 of one per cent., which, notwithstanding it does not affect the leakage account, does help to make the liquor in our drips. I might add here that to take the average temperature for the amount of vapor carried in gas is not strictly correct, because the quantity of moisture carried increases as the temperature increases, as you may notice in my figures—the percentage between 45° and 60° being three-quarters for the 15°; the percentage between 60° and 70° being .7, or nearly as much for the 10°.

We have in our experience often noticed the quality of the liquor pumped from our drips, and in the case of coal gas, I think, are about ready to decide that it is little but water pure and simple. We have noticed also that in low, wet districts we find more of this liquor in our drips than in high and dry localities. The trouble in the former cases sometimes almost amounts to a daily necessity for pumping; while in the latter cases drips seldom, if ever, need pumping.

As a further evidence of the incondensability of coal gas I may give an experience that occurred during the writing of this paper. We have three holders, one large and two smaller; and as the consumption commenced falling off during February we did not need the gas in one of the smaller ones, but kept it as a reserve for a period of two weeks. The holder at the beginning of this period was full to within a half sheet, the temperature remaining much the same during the whole period. At the end of the two weeks there was a decided change in the temperature, when the holder quickly lifted, and we had to let some of the inflated gas pass out in order to prevent "blowing." The holder rose and fell with the temperature right along until the temperature increased so much at the end of the two weeks as to expand the gas beyond the capacity of the holder.

We have had occasion to notice the influence of temperature on coal gas in this paper, and may add here a recent experience in that line. I had occasion to put up a Jones jet photometer in our works, and the half-inch pipe to supply it was run along a wall rather highly heated by steam pipes and a steam boiler. This same jet photometer had previously registered from 17 to 19 candle power in another part of the works; but on placing it where the gas in the supply pipe became abnormally heated, it did not show more than from 14 to 16 candle power. Of course, the governor of the photometer passed only the given quantity of inflated gas, and the loss, or difference, was shown in the reduction of illuminating value.

Now to recapitulate somewhat. We have in our view, from the assumed data used, a most probable three-quarters of one per cent. of condensation from decrease in temperature, and, to be very liberal, we may add to this another possible three-quarters of one per cent. for the deposition of hydrocarbons, etc.—making together 1½ per cent. of the volume of the gas recorded; and here, for my part, I would draw the line. We have also found, under the same assumed data, a probable loss to be charged to leakage from decrease in temperature of 3 per cent. Summing up, we have 4½ per cent. of loss without allowing anything for real leakage; and we may now ask what should be the percentage of actual leakage under which we might rest easy. Without entering into further details I would say that, for cities having a good or fair consumption per mileage of mains, not more than 3 per cent. should be tolerated. Adding this to the 4½ per cent., we would have 7½ per cent. as the maximum unaccounted-for gas for a well laid and well cared for set of mains.

I have heard of distributing plants which gave less than 5 per cent. of unaccounted for gas; but not in this climate, nor affected by the wide range of temperature under which we suffer. I am ready to believe anything that is good, if it do not seem too good; and quite believe it possible that, in ordinary cases, the maximum leakage and condensation account can be kept somewhere between 7 and 8 per cent. average per annum. The day is fast passing when we can quietly suffer our unaccounted-for gas to remain at the almost criminal proportions of between 12 and 20 per cent.—especially as the prices of gas are on every hand falling to bed-rock. Like "little foxes," our little leaks are stealing away the profits. The big leaks we hear of and secure readily; but the little ones dodge and almost defy us. These little fellows

once left in our tracks are hard to find, but their multitudinous action will stare us very hard in the face. Will we not learn the lesson contained in the old adage, "Prevention is better than cure!" Never was this truer than when uttered in connection with the topic of gas mains.

Discussion.

Mr. Bushnell—I believe that if the members would give figures as to their actual loss of gas, either from condensation or leakage, we might find out the lowest percentage, and profit by its methods to the extent perhaps of cutting down our loss to the proportions spoken of by Mr. Enfield, who thinks it should be in the neighborhood of 7½ per cent. At Springfield the loss runs up to 12 and even 15 per cent.

Mr. Hamlin—Some five years ago I became interested in the Wilmington works, and at the outset our unaccounted-for gas amounted to about 15 per cent. We then introduced the system of "probing" for leaks, and soon (1884) brought the loss down to a figure represented by 10.83 per cent. It should really have been less than that, as we keep no account of gas consumed about the works. I hope to do still better. I would like to hear an expression of opinion as to what the average loss should be in works of the capacity of mine.

Mr. Bowers stated that his unaccounted-for loss during the first year ('82) of his connection with the Hillsboro works was over 18 per cent.; the next year it had fallen to 16; last year to 15. He took hold of the management as a "greenhorn," and knew nothing whatever about pressure or like details. He thought the greatest trouble at Hillsboro was the pressure they had been working under—24-10ths. This, he concluded, accounted for the 18 per cent. leakage.

Mr. Huntington—The leakage at our Columbus works, during a number of years, has ranged between 12 and 18 per cent. We have sometimes thought the figure was pretty large, and would be highly pleased to learn some method of decreasing the percentage.

Mr. Printz—At the Zanesville works our loss is about 14 per cent. We have quite a main mileage laid for street lamp supply only; and perhaps on one-half of our mains we have no private consumers. During a spell of severe economy we put down some wooden pipe, and its possession has given us great trouble. Next year we propose to take it all up, and this action will undoubtedly reduce our leakage account.

Mr. McMillin—I think the two papers just presented were about as interesting as any that I have ever heard read before this or any other meeting. The writers have gone thoroughly into the subject, and told us how much loss was due to condensation and how much to leakage. We should not undertake to find leaks until we are certain we have them. One gentleman has reduced his loss to 4½ per cent. After getting it down to that you really have not got any leaks. The amount of leakage a gas company ought to have from its mains is something pretty difficult to tell. The conditions are so entirely different as to preclude the fixing of any rule that could be made hard and fast. Even after the fixed figure had been given, you would not know much nearer than before as to whether or not it was a reasonable loss. The leakage at our works in Columbus is very large; and, getting back to an old subject, I think it is very largely due to the lack of any expansion joints. Leakage ought to be less in Columbus than at Zanesville. It ought to be greater, perhaps, in Columbus than in Cincinnati; but you cannot draw a line by saying it is proper to run up to 8 or 10 per cent. in all places, or that a man who does not get down to these figures is not doing good work.

President Hickenlooper—Ten years ago our loss at Cincinnati was 13½ per cent. We then instituted an extremely rigid system of main inspection, which resulted in a decrease to 11 per cent. My own judgment is that you will find much of your loss is attributable to slow meters. You all know that a very large proportion of incorrect meters are registering against the company. We followed the main inspection by a careful house-to-house meter test, which resulted in showing that out of all the meters not registering absolutely correct 95 per cent. were slow. This confirmed our judgment that a very large proportion of what is usually termed leakage is but the under-measurement of consumers' meters. Three years ago our leakage was 11 per cent.; two years ago, 9½ per cent.; last year, but 7½ per cent. Good sometimes grows out of evil; and much of this good came from the visit of a so-called friend of the consumers who visited our city some time since for the purpose of making independent tests of consumers' meters, and thus expose the thieving propensities of the gas companies, for which he received, from credulous consumers, \$5 per meter. They could, of course, have had a much more accurate test made upon application at the office; but, I suppose, preferred not to trust the company's agents. He worked here very industriously for two or three months. The possessor of every *fast* meter at once reported, but the happy possessors of many more *slow* meters failed to notify us. When the gentleman was through and about to leave for pastures new I sent for him and offered him 50 cents each for his list of slow meters. As he had already received \$5 from the consumers, he gladly accepted this offer; and we certainly never made an investment that paid better. It at

once occurred to me that a careful system of test-meter house inspection would be an improvement upon the old and more laborious plan of bringing all meters in for inspection. It occurred to me that if this man could go around town and make tests that approximated to correctness, why could we not do the same? We now have four men employed, and they make a systematic inspection from house to house. If they find a meter running approximately correct it is not disturbed, otherwise it is immediately ordered in for a more careful test. In that way we have found a larger number of slow meters than I had originally supposed existed; and if you, gentlemen, will look in that direction, I think you will find a similarly large proportion.

Mr. McMillin—Regarding the meters taken out and tested at the request of the consumer, and also noting the old meters tested at Columbus, you will find a paper (giving the statistics) that was published in the AMERICAN GAS LIGHT JOURNAL,* which shows that the grand average of tests proved "slow" by .44 per cent. In making up that estimate meters that failed to register at all were excluded. Sometimes the consumer gets gas when the meter does not register.

Mr. Enfield—I think, putting this and that together, we can get upon pretty good standing ground. You have sounded a pretty good point as to the registration of meters. No doubt much unaccounted-for-gas may be traced to that source. If a sound system of testing be adopted, and then what I said in reference to preventing leaks in gas mains be adopted—being sure that we get the best mains, and then, above all, get the best men to lay them—I think we can get down to the figures I gave, speaking of any ordinarily good gas consuming community.

President Hickenlooper—I think another trouble will be found in the over supplying of your street lights. You will generally find a street light consumes more gas than your contract requires. I have no doubt you will find when you are required to furnish but four feet, you are oftentimes furnishing 5 or 6 feet.

FIRST DAY—EVENING SESSION.

Leakage and condensation having been disposed of, Mr. Geo. Tayler, of Warren, read the following paper, in response to the question of—

WHAT IS IT THAT OBSTRUCTS THE SERVICE PIPES, TO LAMP POSTS AND TO CONSUMERS, IN EXTREME COLD WEATHER; AND IS THERE ANY WAY TO PREVENT THIS ANNOYANCE?

The annoyance occasioned by obstructed service pipes during extremely cold weather is a double one. It annoys not only the employees of the gas company, whose duty it is to keep the services clear; but also bothers the consumer, who, perhaps when he most wants light, finds himself without it.

To determine what it is that causes these obstructions, and to devise a plan by which the annoyance can be banished, is well worth the time and attention of this Association.

If you will look into one of these obstructed pipes you will perceive a sort of white frost, which placed in the palm of the hand soon dissolves into an oily, watery substance, with an odor somewhat similar to that emanating from the drip-pump; and it would seem as though the deposit had materially decreased the illuminating power of the gas. This substance, in my opinion, has been congealed from aqueous vapor, and vapors of volatile liquid carbides of hydrogen (which, in the retort house and condensing room, we have been so anxious to retain in our gas), but mainly from the former.

The only positive cure for this annoyance is to protect the pipes from the harmful action of frost and extremely cold weather. Mains must be laid below the possible reach of frost, and all exposed places must be avoided. To do this is no easy matter; indeed, in most cases, is impracticable. If the mains are not laid below the reach of frost, then the service pipes cannot be secured; and so we must take our mains where we find them, and, in many cases, do likewise with our services also. Yet, with proper care in laying the services, and in protecting them afterwards, the annoyance can, I am satisfied, be reduced to a minimum.

I have been many times bothered by these stoppages; and, in a great majority of cases, have located the trouble at the point where the service pipe came in contact with stonework or brickwork. Whenever practicable I have cut away the masonry and encased the service in a wooden box or tube, being careful to leave an air space between the service and its covering, and also to protect the air space from any accumulation of water. This I have found to be very effectual. When this could not be done I have changed the location of the service. When I have had exposed or open spaces to contend with—such as vaults under sidewalks, and basement passageways in front of stores, I have gone around them whenever possible; and to this end have supplied several stores by means of one large service. When this could not be done I have protected the service pipes in the same manner that I

* Vol. XLI., Dec. 16, 1884, p. 315.

protect them from contact with masonry, at the same time avoiding any angles in the pipe.

With lamp posts, a great many of which stand near the curb of the stone sidewalks, I have found stoppages, the causes of which were traced to the service being in contact with, or in close proximity to, the curbstone, which extended into the ground—sometimes to the depth of thirty inches—carrying the frost down its full length. For some lamp posts I employ one-inch pipes, but never set a smaller size than three-quarter-inch. I take care that the openings through which the service enters the post are closed, so that no earth can fall in around the pipe, or about the elbow from which the pipe rises to the burner. I also stay the pipe in center of post so that it cannot come in contact with the post at any point.

With these precautions, I have now only four service pipes to consumers which have frozen up this winter; and their location will be changed before the winter of '85 sets in, so that they will then cause me no further annoyance.

With lamp posts I have not been so fortunate, as fifteen of these have frozen up. This, however, is a great improvement over former years.

Discussion.

Mr. Bate—One of the questions intended for construction was, what caused the obstructions. Of course, services, when closed up in cold weather, are generally described as being "frozen up." Now, the real point is, does the trouble arise from naphthaline, or is it occasioned by true frost formation? If it be naphthaline, are there any steps which we may take at the works that will prevent its appearance? I have always considered these deposits as the result of frost, and have treated them as such. I have only some five or six services that give me any bother, and these are at places where I could not put in a service without crossing areaways.

Mr. Bowers—Talking about passing through areaways, I think that would not have any effect upon the gas. We have at Hillsboro about 20 services passing through areaways, and not one of them had frozen up during this winter. In reality, where the services are best protected there do we have the greatest trouble; and at my own home, with the service 2½ feet underground, I had a very perplexing case. A new dry meter had been put in; after two weeks from time it had been placed we could not get a foot of gas through it. That meter, on examination, had a pint and a half of water taken out of it. That was the first thing of the kind that had ever happened with me. I took that meter out on the eighth of February, fixed everything up all right, setting it right back again—on the 16th no gas could be had. I cleaned up things again, taking out more water, and expect when I go back, or shortly thereafter, to repeat the operation. Can anyone here tell me why so much condensation should appear at that particular spot? We have had so far this winter about ten lamp post stand-pipes, or services, that gave us trouble, but a pint of alcohol opened them up.

Mr. Bate—Mr. Bowers claims that services passing through open areaways should not be affected by these stoppages. It is at such points that my services invariably freeze.

Mr. Wood—A service pipe to Sandusky County Jail, for the first time in 9 years' of duty, was frozen up on a recent occasion. A portion of the service was filled with a solid mass of ice. That trouble may be traced, I think, to the fact that in the cellar through which the service passes is located a boiler which generates steam to heat the building. During the winter the walls and ceilings reek with water, and the exposed service pipe was wet all the time. We could not do anything with our force pump, and afterwards tried to soften the deposit with alcohol, using up, during 48 hours, much more of that spirit than I liked to spend on the experiment, and yet did not succeed in freeing the tube. As a last resort I had to run a temporary service. All our pipes through open areaways have frozen up. I have a 4-inch pipe running across our Market street bridge which has often given me great trouble in former years, but has not bothered me greatly this winter. I also have had trouble this winter with a service supplying the convent building, although hitherto it had worked all right. Then, again, I have a 2-inch pipe crossing another bridge that occasionally makes its presence known, while the service under the Barr street bridge, only a short distance away, never gave me any annoyance whatever.

Mr. Printz—At Zanesville we had supposed we were laying a short line of pipe along territory that would in time be occupied as a public roadway; after-developments proved that our reckoning was wrong, as a house was built over the land and our pipe was exposed while the cellar walls of the structure were being erected. Twice within the last ten days we have had that pipe (it is 50 feet long) frozen solidly up, with the consequence that the gas supply to the northeast portion of Sandusky was entirely shut off for a short period. We cleared out the obstruction by means of hot water application.

President Hickenlooper—Was it a deposit of ice or naphthaline?

Mr. Printz—Well, it was ice.

The President—How do you know it was ice?

Mr. Printz—From tapping the pipe at four or five different places. We have a six-inch line over one of our river bridges, and it has to be carefully looked to after a heavy frost followed by a thaw.

A member inquired of Mr. Printz what size of pipe was that running through the cellar spoken of.

Mr. Printz—Four-inch; and it is exposed to the air on all sides. We have had quite an experience in the freezing up of services; and, strange to say, the happenings are most erratic. Those which have never bothered us before will, without a moment's notice, close up tight; while, on the other hand, the offenders of a previous winter will keep right along on their good behavior. The nuisance is at its height during extremely low weather temperatures.

Mr. Kelly—In regard to that 6-inch line of bridge pipe—at what point do you find the ice chokes it up? Is not the difficulty experienced at the spot where it strikes the bridge; and is it not your experience that no trouble is encountered on the section passing under the bridgeway?

Mr. Printz—The ice forms where the gas passes into the exposed pipe.

Mr. Kelly—When it encounters the change from the earth temperature to the much lower one of the exposed main, of course condensation must ensue. Look at the panes in the windows to this room; the interior warm air striking the cold glass is deposited thereon in the shape of rime or hoar frost. If the internal atmosphere were now equal to that out of doors the frosty deposit would not manifest itself; and that I would offer as an explanation of Mr. Printz's bridge main stoppages. Where pipes are kept at equal temperatures there will be none of this bothersome experience. I have passed gas through mains underneath bridgeways, and below canal bottoms, and have always noted that if the gas were not obliged to encounter sudden chilling, stoppages from frosty condensation would never occur. Where the pipe comes out of the ground just at the bridge approach is where I have looked for and found frosty stoppages.

Mr. McMillin—Can Mr. Printz tell us what probable quantity of gas is passing through that uncovered main which he speaks of having "frozen up" on him?

Mr. Printz—I could not say.

Mr. McMillin—If you just make a calculation of the vapors passing in the gas, as stated in the papers presented here to-day—taking temperature of gas, say, at 40° F.—I think you will find it will require about 500,000 cubic feet to condense sufficient water to form that quantity of ice. You would require to send through an enormous quantity, and have every particle of it condense at the stated point in order to solidly fill that pipe with ice. It requires a large quantity of gas to produce moisture for even one cubic foot of ice formation; yet that pipe would hold more than four cubic feet of ice.

President Hickenlooper—Let me call your attention to the conditions. The statements made in the papers are based upon average conditions. This is an exceptional case. Might there not be a greater deposit, a greater condensation of vapor, under those conditions than under the circumstances as described in the papers? The writers do not demonstrate that there is no vapor in suspension in the atmosphere. Now, if you take extraordinary conditions, such as stated by Mr. Printz, is there not likely to be a much greater proportion of condensation deposited than the writers of the papers have set forth?

Mr. McMillin—I based the calculation on a well-known law of the quantity of moisture that any gas will carry; and the lower the temperature the less that moisture will be. This gas being exposed to nearly zero in the holder, you could not have more than one per cent. of moisture in the gas passing through that pipe.

President Hickenlooper—For instance, to illustrate my idea: If you have a steam pipe, protected for its entire length, and allow the steam to pass through it continuously, is it not conveyed along without appreciable condensation? On the contrary, pack that pipe in ice, and would you not find plenty of condensation?

Mr. McMillin—Not less than 500,000 cubic feet of gas would have to pass through that pipe, and deposit all its moisture, in order to make the 4½ cubic feet of ice there thrown down.

Mr. Printz—While I cannot say as to what quantity of gas passes through that main in a week, I can say that twice within two weeks we had to clear it out; and I cannot think that the obstruction was anything other than ice.

President Hickenlooper—Has any other gentleman, in his experience, had a pipe filled solid with ice?

Mr. Tayler—In the paper I have not touched upon pipes running across bridges, nor spoken about main pipes in the streets, because these matters were not what the questions referred to. The questions speak of service pipes. I have had a 3-inch pipe frozen solid with ice for perhaps 30 or 40 feet of its length, and it was laid at a depth of three feet below ground surface. The "freeze," though, was a simple case of "leak into the pipe." One and a half squares distant from the location of freeze, water was running into the main; and so there was nothing wonderful about it.

Mr. Bate—But still the question is, "Are we to consider this deposit as

ice or as naphthaline?" I once had a 2-inch main "freeze" up. I was at a loss to account for it until I learned there was a sort of sewer running underneath the street, the location of which I was entirely ignorant about until the stoppage occurred. I found from examination that the gas main was running right above the crown of the sewer. On digging down I found that the earth enclosing the main was frozen as solid as though it had been on the surface of the street. I built a fire about the main and thawed it out. A short distance below where the stoppage occurred there was a drip; when the pipe was freed we pumped two or three barrels of water (it was as clear as though it had come from a well) out of that drip. Naphthaline resolves itself into a dirty, greasy liquor. If naphthaline had been the cause of the obstruction why did not the drip collection show a dirty appearance? It may have had a trifling odor, but not marked enough to be especially noticeable. Speaking of mains crossing bridges, I am in accord with Mr. Kelly. Such stoppages are caused by the sudden change of temperature experienced by the gas. The "rising" side, I have noticed, is always the one where we have to administer the alcohol, never the other. I am inclined to think it is ice we are bothered with instead of naphthaline.

Mr. Coverdale—I never had any experience with pipes freezing up solidly, but I can remember several places where small diametered pipe was used in crossing bridges, and which gave no end of trouble. One situation that I remember was the case of a bridge conduit 250 feet in length, diameter of pipe being $\frac{3}{4}$ inch. That pipe would freeze up several times in the course of a winter, as you might well expect it to. I have always made it a rule to give service pipes plenty of "fall." I have known them to be carefully laid with a level; if so laid you will always have trouble with them.

Mr. Enfield—My experience with ice formation in pipes has been that I discovered it in the legs or drips that we put on at the end of service pipes in the cellar, or it has been found in traps along in the service pipes. Where pipes would run across an area or other open space, or lie shallow under a gutter, etc., I have found a kind of hoar frost, but not often solid ice. I have, as said, seldom found solid ice where pipes were laid with a proper grade. Of course, alcohol will readily cut through and remedy the difficulty for the time being. I have often thought that a good frost preventive remedy for pipes running across areas, or where the pipe made a sudden bend likely to be exposed to extremely low temperatures, is to enlarge the diameter. I would enlarge the pipe right where it crosses the area. Of course, this may not be a specific remedy, but the pipe, at any rate, offers a much larger space for the frosty accumulation to fill, and the cold snap might possibly pass away before the diameter was closed. I think, too, that we can accomplish much by careful laying of our services.

Mr. Bate—The gentleman said, "Give the service pipe as great a fall as you possibly can." Would that apply also to the lamp post services? I think the great difficulty with them is the putting in of short bends or ordinary elbows. I have known some superintendents who used bends of a larger size than the services, or even the riser itself, thus covering the entire elbow and lower section of riser where it arose out of the ground. A three-quarter-inch is my favorite size of service for lamp posts. I have had pipes to shut up on me, and after pouring in alcohol until I was ashamed to waste any more of it, I have "pounded a way through." My experience convinces me that this moisture congelation occurs not from the simple fact that the drip or watery vapor had been arrested at some point where it could not flow back into the mains, but should be attributed to the sudden chilling experienced by the gas on entering the portion of riser just above the ground.

Mr. Enfield—I think our general experience goes to show that real ice formation does not take place; but that it is a deposit of hoar frost. If you "pound" upon this hoar frost with a rammer you will very soon pack it into a hard and solid ice.

Mr. Fullagar—That is so. Put the funnel on, but never make an attempt at clearing the service with a rammer.

President Hickenlooper—What is the notable difference in appearance between this hoar frost and naphthaline?

Mr. Fullagar—After melting or dissolving naphthaline you will find a sediment deposited; but melt the stuff usually found in lamp post services and the liquor will be quite clear.

Mr. McMillin—I supposed, from the tenor of questions in Subject No. 8, they referred only to the stoppages in service pipes that had been properly laid. If the pipe was put down in such a manner that it would not carry off aqueous condensation, of course it will keep freezing up. I do not believe that that moisture was condensed from the gas—speaking of those instances where parties found solid ice in their pipes; but I do assert that these cases were the result of leakage. You may note that in pipes which clog up (especially those through areaways) the deposit adheres to every portion of the tube; and the aperture left for the gas to traverse, no matter how small it may become, will be in pipe center. The percentage of moisture carried in the gas is far too small to be able to clog a service up from day to day. Some services require thawing out almost every 24 hours. The stoppages are the consequences of naphthaline, or other heavy hydrocarbon deposits. If you

put a rammer in at any one place of course you can pack these deposits up quite solidly.

Mr. Bate—Do you think, then, where you encounter one of those solid compounds spoken of, the formation is caused by a leak in the main?

Mr. McMillin—Yes, sir; if the obstruction is ice.

Mr. Bate—The hardest formation I ever encountered in our Washington street bridge main was noticed during the middle of March, 1884. I put on the pump, thinking possibly there might have been an accumulation of water in the riser. The pump failed to show such a condition of things. I opened the plug and could get no sign of gas. I poured a quantity of alcohol in, but finally had to "pound" through the mass. The straight supply is a four-inch pipe, buried at a depth of about seven feet, which should be out of reach of frost; and I hardly think I could have leakage from the riser pipe. I believe you will find our trouble from frost in services is much greater during early spring than in the height of winter.

Mr. McMillin—That this is so is not owing so much to the heavy frost as it is to intermittent spells of freezing and thawing. At the surface of the ground, as the temperature gets warmer, the scales of naphthaline drop down. Lamp services are always more troublesome at the end of a freeze than at the beginning of one.

Mr. Tayler—I think this hoar frost deposit arises mainly from vapor thrown down during the passage of the gas. Possibly some of the hydrocarbons may be included in it; but I incline to the idea that aqueous vapor is the chief offender. After the deposit has been reduced to a liquor by melting it does possess a trifling odor; but yet it is entirely free from sediment—in fact it counterfeits water very well.

Mr. Printz—Mr. McMillin may be right in respect to a leak in that four-inch pipe of mine; but I doubt it, and doubt it because we have never found any water in it. Some years ago I had a peculiar stoppage happen on a main at a point distant about a mile from the works. Probably four or five places in the length of it had closed up on me. That pipe was probably 30 inches under ground, and right where the stoppage occurred the street was so overshadowed that the sun did not strike the pavement at any hour of the day. We took out a solid lump from the main. It had never troubled us before, and it has not done so since. The main was perfectly dry. There was no water in the soil—the earth formation being firm and solid.

Mr. Enfield—The thought has occurred to me while listening to this discussion that perhaps where a pipe has a good grade—and we would suppose that all vapors condensed would be led into the drip-box—right where the cold temperature first touched it there was a joint. Now, of course, we cannot expect the spigot and hub to fit so nicely as not to leave some slight irregularity—even, perhaps a hole; and the same thing might perhaps be noted in connection with elbows or fittings to services passing through areaways, or to services in other positions where they might be exposed to extreme cold. The vapors carried in the gas, and possibly the heavy hydrocarbons, may condense to the extent of forming a tiny stream, and that stream may run down the grade until it comes to the obstruction. At first a slight particle adheres to the obstruction or crevice and there congeals, succeeding particles doing likewise, until finally the whole diameter of pipe at the affected spot is closed up completely. May not such be the case?

[To be continued.]

Testing Gas for Carbonic Acid.

The London *Journal* "notes" that a method for determining the proportion of carbonic acid in coal gas has been proposed and described by Mr. Blochmann. It is claimed for this method of analysis that it is simple as compared with the usual procedure, which requires experienced operators and special apparatus. The test consists in shaking up a certain volume of gas with a sufficient quantity of lime water, of known strength, until all the carbonic acid is absorbed. The quantity of lime water necessary for this result gives, by a simple calculation, the volume of carbonic acid in the mixture treated. For facility in recognizing the quantity of lime water required, some drops of an alcoholic solution of phenol-naphthaline are previously added to the liquid, until it acquires a clear red tint. If after agitation with the gas to be tested the liquid is discolored, it is an indication that there is still carbonic acid unabsorbed; and consequently more must be added until the liquid ceases to be further affected, when the reaction is to be regarded as complete. The lime water can be easily prepared. It is known that a cubic centimeter of pure water will, at the temperature of 17.5° C., absorb 1.276 milligrammes of lime; and that 56 parts of lime will combine with 44 parts of carbonic acid. Wherefore 1 c.c. of lime water is equal to $\frac{1.276 \times 44}{56} = 1 \text{ mg.}$

or 0.55 cubic meter of carbonic acid. If, therefore, 1 c.c. of lime water is exactly sufficient to neutralize the carbonic acid of 100 centimeters of gas, it follows that this gas contains 0.55 per cent. of carbonic acid; or, if the gas

contains 0.5 per cent. of carbonic acid, it will take $\frac{100 \times 0.55}{0.5} = 110$ c.c. of gas per cubic centimeter of lime water. Thus, if the graduations of the burette containing the lime water are to the volume of gas to be tested as 1 is to 110, the quantity of lime water contained between any two of these graduations will correspond to 0.5 per cent. of carbonic acid. An extremely simple arrangement for employing this test is constructed as follows: A glass tube, curved at right angles, enters a half-liter flask, the other end being in connection with the gas supply. The flask is filled with gas while held upside down, and (the gas pipe being slowly withdrawn) the flask is rapidly corked. To test whether the gas contains more than 1 per cent. of carbonic acid, the colored lime water corresponding to this proportion, as marked on the burette, is introduced into the flask and shaken up briskly for two or three minutes. If the water is still colored more must be added, and the same treatment pursued until the absorption is complete, when the quantity of water used gives the percentage of carbonic acid with sufficient accuracy for ordinary purposes. If sulphuretted hydrogen is present in the gas, the proportion of carbonic acid is apparently raised.

The Box and Waller Washer-Scrubber.

Among recent developments in the field of gas washing may be noted the apparatus devised by Messrs. Box and Waller, the patent right proprietors of same being G. Waller & Co., a firm well known to the English gas fraternity under the title of the "Phoenix Engineering Works," with factories at Southwark, London. The apparatus here illustrated was built by the makers to the order of the St. Albans Gas Works, and is calculated to pass 750,000 cubic feet in 24 hours.

The machine is made in several compartments, in each of which the same operation is repeated, the purification being carried a stage further each

the water in them begins to spill over the edge, and in a short time descends in a veritable shower-bath, the drops falling from tube to tube, and becoming broken and dispersed in all directions, so that the gas which has to make its way among the tubes is subjected to a continuous and most thorough washing. As the tubes empty they become filled with gas which is carried down below the general water level, and has to rise in bubbles.

Each washing wheel is situated in a separate compartment of the external casing as regards its lower part, the division rising nearly as far as the central shaft. But every alternate division extends to the top of the casing, and forms a complete barrier between the adjacent compartments, which at that point have no communication except through the hollow shaft, which is divided into short lengths by internal diaphragms. It thus follows that the gas passes through one wheel to the hollow shaft, and through the latter to the next compartment. Thence it passes outwardly through the wheel, and passing round the edges of it, proceeds inwardly through the next wheel to the shaft, and so on, following a sinuous course the whole length of the machine. The water flows through external pipes from compartment to compartment, being drawn off at the point where its specific gravity is the greatest. The tar is led away from the lowest point by pipes which dip into a tar main.

The casing is cast in four semi-cylindrical parts, and is bolted together by flanges not shown in the illustration. Each compartment is provided with a large manhole, and a testing tap by which the quality of the gas can be tried at that point.

We are indebted to *Engineering* for the details above given.

Manufacture and Use of Oxygen.

From a foreign source we learn that MM. Brin, of Passy, are producing oxygen on rather a large scale by the barium-oxide process. They have two large retort furnaces regularly going, filled with retorts of 2.80 meters length

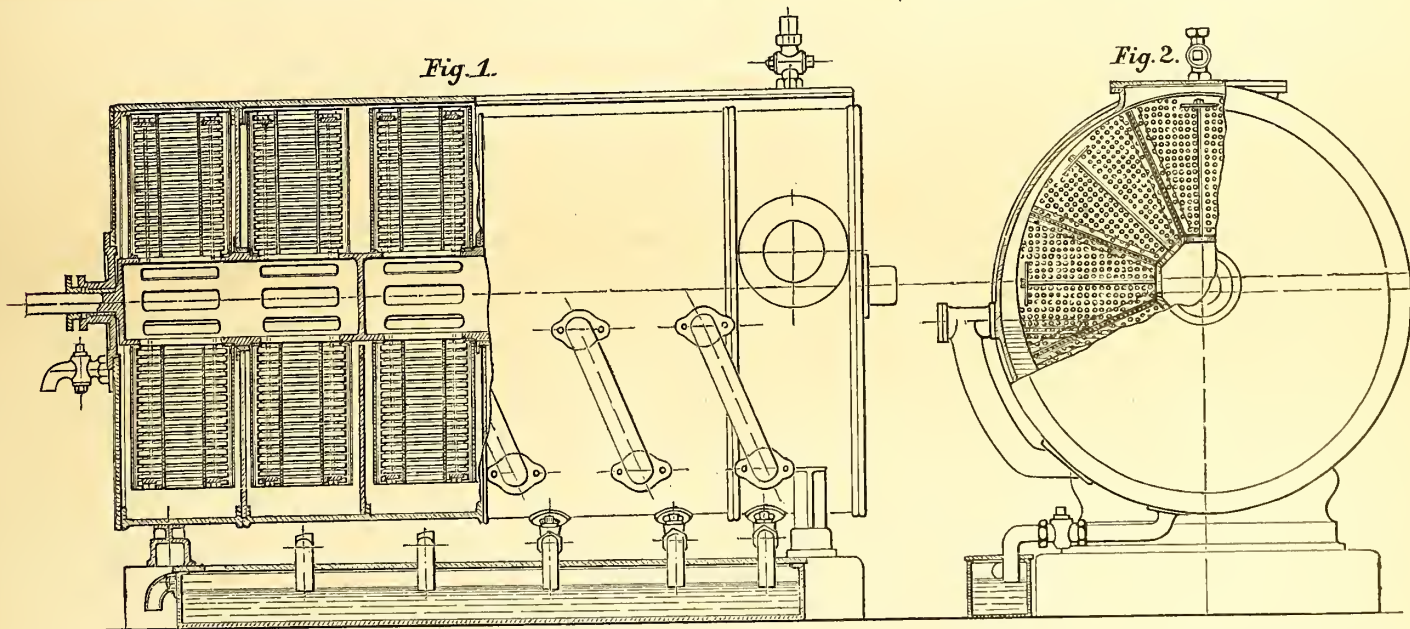

time until it is complete. The number of compartments is more than sufficient to effect the entire cleaning, so that should any of them be temporarily put out of order the manufacture would not be stopped. The gas is acted upon in two distinct ways; it is brought into contact with an immense area of wetted surface, and at the same time it is drenched by falling streams of water, which are deflected and splashed in all directions by obstacles which break their vertical descent. The same liquid passes through all the compartments of the apparatus in succession, the clean water first meeting the pure gas, and gradually picking up more and more impurities until it escapes at the further end where the crude product enters. By this arrangement a high standard of purity is obtained in the gas, and the ammoniacal liquor is not unduly diluted.

A central shaft, 14 in. diameter, runs from end to end of machine and rotates at about three revolutions per minute. Upon this there are built six or more washing wheels, each consisting of four wrought iron discs, of which the two outer form guard or division plates, and the two inner form the framework to carry the wetted surface and water lifting arrangements. These discs are pierced with about 1,000 holes, and carry between them short lengths of tubes spaced as shown in the engravings. These tubes are not perfect cylinders; they are stopped at the ends, and are slotted down one side, with an opening 12 in. long and 1/2 in. wide, so that when they dip into the liquid contained in the lower half of the casing they become filled and carry their contents up with them for a considerable distance. As they rise

and 16 centimeters diameter. In these retorts they calcine oxide of barium, passing over it a stream of air which has first passed through quicklime to free it of carbonic acid. During this calcination the heat does not exceed 500° C., at which temperature the barium oxide absorbs oxygen, becoming peroxidized. The nitrogen is drawn off and passed into gasholders, to be used for making ammonia, etc. When the barium-oxide has absorbed as much oxygen as it can, the heat is raised to about 800° C., at which temperature the peroxide is decomposed, giving up again the absorbed oxygen, which is drawn off and pumped into a gasholder. MM. Brin make use of the oxygen so collected in many ways, one being the application of it to the purification of water. Filtered water is placed in a cylinder and saturated with oxygen gas at 300 lbs. pressure to the inch. All organic matter is destroyed, and perfectly pure water results.

How Disease is Spread.

In speaking of this subject the *Sanitary World* furnishes the following practical illustration:

"A young Scottish lassie, in domestic service not far from the town of Elgin, died from scarlet fever in her 'place.' Her clothes were carefully packed up, and her 'kist' containing them was conscientiously sent home to her native village. On its arrival at the station there was the usual difficulty of getting it conveyed over the hills to the place of its destination, so

there it had to remain awaiting a friendly lift. Meanwhile the infected kist formed a happy hunting ground for the station master's children, who, in due time, all fell ill with scarlet fever. At last the friendly lift came, and the box (a large wooden one) was carried home, and the contents generously distributed among the neighbors. Needless to say that an outbreak of scarlet fever in the village was the result; and as to the station, where people do congregate and often have long to wait, it would simply be a center from which many a fever track would radiate, exciting the usual wonder whence and how the fever came."

ITEMS OF INTEREST FROM VARIOUS LOCALITIES.

CHANGES IN THE POSTAL LAWS.—Towards the close of last Federal Congress one or two rather important changes were made in the postal rates, and for fear that these may have escaped the attention of our readers, we will reproduce their salient features.

I. The weight of all single-rate letters is increased from one-half ounce each, or fraction thereof, to *one* ounce each, or fraction thereof. The same increase of weight is allowed for drop letters, whether mailed at stations where there is free delivery, or where carrier service is not established.

II. All newspapers sent from the office of publication, including sample copies, or when sent from a news agency to actual subscribers thereto, or to other news agents, shall be entitled to transmission at the rate of one cent per pound, or fraction thereof, the postage to be prepaid. Equivalent to a reduction of one-half from existing rates.

III. Any article in a newspaper may be marked for observation, except by written or printed words, without increase of postage. These rates go into effect with 1st day of July, 1885, and their effect on the transmission of ordinary letters is to double the weight of postal missives at present forwarded at a tax of two cents each.

LIGHTING UP RITTENHOUSE SQUARE (PHILA., PA.) WITH SIEMENS BURNERS.—About the first of present month the 24 Siemens lamps placed about Rittenhouse Square, at the instance of the Philadelphia Gas Trust, were put in action. A couple of months ago it was noted in the JOURNAL that the Siemens Company, after a warm contest with the electric lighting promoters, had received an order to substitute a certain number of their high-power burners for the "arc" lights that formerly did the night lighting in certain portions of the Quaker City. The Rittenhouse Square example has proved (indeed there never was any doubt at all as to the outcome) an entire success, and the Philadelphians are very much pleased over it. A local newspaper, in detailing the spectacle presented on the initial evening of the improved gas illumination, said: "The whole park, which contains about ten acres, was as light as day, and the broad asphalt walks were swarming with children darting about on roller skates—indeed, for a time, they turned it into a sort of free rink. The light from these lamps is very evenly distributed, having a most pleasing effect, since it causes no intense shadows. One can see to read a newspaper in any part of the Square, and the grass, as well as everything else upon which the light falls, retains its original color. The lighting effect is fully equal to that given off by 30 of the ordinary burners." Franklin and Logan Squares are to be illuminated in a similar manner, and the ferry slips at foot of Market street are to be lighted by aid of the Siemens improved system. Verily; Brocher Stein and his business associates hath learned how to "do the thing up brown."

CHEAPER GAS FOR MONTREAL CANADA.—The Montreal Gas Company has made the important reduction of 20 cents per 1,000 from its former selling rate. Notification of the reduction bears date of April 15th, and the concession made took effect on consumption registered on and after May 1st. The gross price of gas to ordinary consumers, for gas used in illumination, is placed at \$2 per 1,000, with a discount, for prompt payment, of 50 cents per 1,000—a net rate of \$1.50. Gas supplied for other than lighting purposes—such as for heating, cooking, gas engines, etc.—is placed at \$1.50 gross, prompt payment making net charge equal to \$1 per 1,000. Gas furnished to street lamps is included in the lowest net rate. A small sum is annually charged for meter rent. Mr. Scriver evidently means "business," and we think (in fact we are sure) he is on the right "trail" after it.

LOOKING AFTER AN INCREASED DAY CONSUMPTION.—Mr. J. Gwynn Superintendent of the Fostoria (Ohio) Gas Light Company, has determined that it will not be his fault if the day and summer consumption of the plant over which he has control is not greatly enlarged. The owners of the company are determined to second him in his efforts, and in order to facilitate the enterprise authorized him, on May 1st, to notify the people of Fostoria that gas used for cooking and heating purposes, between the dates of May 1st and September 1st, 1885, would be supplied at the rate of \$1.50 per 1,000 cubic feet, making the proviso, however, that in each case a minimum monthly consumption of 500 cubic feet would have to be registered before

the concession was available. We are emboldened to suggest that the discussion on the subject of heating and cooking by gas (had at the annual meeting of the Ohio Gas Association) had much to do with the determination arrived at by Mr. Gwynn, and is in line of showing how valuable such practical common-sense "talks" are. We have not the slightest doubt but that Mr. Gwynn's schedule will be kept up *after* 1st of next September.

MESSRS. TANNER AND DELANEY SECURE A CONTRACT.—The Tanner & Delaney Engine Company, of Richmond, Va., through their Engineer, Mr. Wm. Simpkin, submitted plans to the managers of the new gas works to be erected at Knoxville, Tenn., for the general arrangement of the plant, etc.; handing in at the same time estimates for a good portion of the iron work, apparatus, etc. Several well-known firms of gas works builders had also furnished plans and figures; and, taken as a whole, the competition was a very spirited one. On April 22d the committee (composed of Messrs. Ross, Tuttle and McClung) appointed to examine the plans and award the contract held a meeting to dispose of the matter. They were assisted in their deliberations by Mr. J. T. Lynn, Superintendent of the Chattanooga (Tenn.) Gas Light Company, who had been retained as an expert. The examination lasted several hours, and the outcome of the session was that Mr. Simpkin's plans were adopted, and the contract for apparatus and its erection awarded to the Richmond manufacturers. The contracts for the buildings will be given out to local bidders. The money value of the bid made by Messrs. Tanner & Delaney is about \$10,000—at least so we are informed. It is expected that the new company (its corporate name is, "Citizens Gas Company") will be ready to send out gas on or before Oct. 1st, 1885. A closing hint might be given to the effect that the water gas prowlers were most persistent in their attempt to erect a carbonic oxide death-trap there, but they were routed, "bag and baggage."

OBTAINING PERMISSION TO GO AHEAD.—On date of May 7 the directors of the recently organized Citizens Gas Light Company, of Westchester County, N. Y., obtained permission from the Mamaroneck town authorities to lay their pipes along the line of the turnpike and other public thoroughfares, with the condition that one of the Highway Commissioners be appointed to supervise the main laying operations. Can we call upon Mr. Van Beuschooten, of New Rochelle, for some particulars regarding this Citizens Company?

A MYSTERIOUS SORT OF "COMPANY."—At Albany, N. Y., on afternoon of May 7, the "Avery Gas Company," through its incorporators, filed articles with Secretary of State. Its location as to future field of operations is surrounded with "gloom," although the "articles" are quite pronounced in the assertion that the corporation proposes "to manufacture gas, principally from petroleum, for illuminating and heating purposes." Richard Avery, Henry W. Brooks, and Nicholas Baggs are named as corporators; and T. M. Kones, Wm. T. Wiley, Edward P. Cone, and J. W. Bartlett as directors. Perhaps, so modest are they about their future operations, they are trying to "hide their light under a Baggs."

CHEAPER GAS FOR DAYTON OHIO.—Acting under authorization of his Board of Directors (action having been taken at a meeting of the Board held April 28), Mr. Geo. M. Smart, Secretary of the Dayton Gas Light Company, has given notice that from and after July 1, 1885, the gross price of gas will be reduced to \$1.80 per thousand cubic feet. A discount of 10 cents per thousand is to be allowed to consumers settling their accounts on or before the fifth day of month in which the statements are presented. The price at Dayton is based on an "all round" schedule, and no discrimination is made between gas employed for illumination and that used for culinary or power purposes. It might possibly pay the Dayton folks to make trial of the scheme (inaugurated with first day of May and referred to above) now being tried at Fostoria.

"COMING DOWN" ONCE MORE AT MILWAUKEE, WIS.—In our last issue we promised to give particulars concerning the latest move in reducing selling rates for gas at Milwaukee, and we herewith redeem that pledge. Before proceeding with the same, however, we wish to thank Superintendent Ed. G. Cowdery for his courtesy to us in connection with the matter. It may be remembered that the Milwaukee Company's management, upon announcing the July, 1884, reduction, said to the consumers that if they (the latter) would only encourage the former by a free use of gas, future reductions in price would be cheerfully granted. The consumers responded in proper style, and now the gas men keep their promise; and, by the way, it is just a trifle curious to note the regard with which a gas man is held in out at Milwaukee—especially the gas men connected with the Milwaukee Company. [Not to exaggerate the matter one tittle, the average Milwaukee gas consumer is actually willing and anxious to treat the Milwaukee gas maker as though he were an honest business man, actually engaged in a reputable commercial enterprise. It may seem rather odd to most of the fraternity; but nevertheless such is the state of affairs out there. To no other gas man will the

ludicrous side of this appear more strongly than to the one who operates in New York city, or her sleepy partner on the other side of the East River, recognizable to geographers as Brooklyn, but to the general world known either as the City of Churches, the dwelling-place of Mr. Beecher, or the cage of Mr. Talmage. In these cities the fair and equitable policy maintained by the Milwaukee Gas Company toward its consumers would have no earthly effect. Gas at a dollar a thousand would be rated as an attempt at vile extortion just about one year after the time when it had been reduced (supposing a case) from \$3; and the Sherwoods, Thurbers, Coffeys, Bottsfords, *et al.*, would be at one moment in tears at the sufferings of their fellow-consumers, while the succeeding division of the minute would be sufficient to alter these sorrowful wailings into wrathful and resonant outpourings against the rapacity and rascality of the purveyors of carburetted hydrogen. Perhaps by this time our readers are a trifle perplexed about the question as to what all this has got to do with the new gas prices at Milwaukee. Not a great deal, it is true; but we may be pardoned for the digression (and the explosion), being led thereto simply on account of remembering that if the gas maker lies on a bed of roses at Milwaukee, his brother at this end of the country has no option but to stretch his weary limbs upon a couch the upholstery of which is not sufficiently thick to restrain the thorns from coming through—speaking in both cases solely with reference to “public opinion;” and as for other matters connected with our city fraternity, it may be put upon record that they “are doing quite well.”]

The Milwaukee Company's directors, on Wednesday, April 23d, after having made an inspection of the accounts, and canvassed together over the probable outlook, promulgated the following order: From and after July 1st, 1885, consumers' bills are to be made out on the basis of \$1.80 per 1,000, and in consideration of prompt payment a discount of 40 cents will be allowed, making the net charge equal \$1.40. On January 1st, 1882, the company reduced the price from \$2.25 to \$2; July 1st, 1883, to \$1.80; July 1st, '84, to \$1.60; and the one above announced becoming operative on July 1st, '85, \$1.40. In this last statement only lowest net rate for prompt payment is given. The increasing demand for gas has rendered necessary the enlargement of what is known as the “Third Ward” plant, and the betterments thereto include the erection of a new holder, with cubic content of 400,000 cubic feet, new condenser and purifying apparatus calculated to pass one million cubic feet per diem, the latter machinery to be erected in buildings designed to admit of its future duplication. The estimated expense attendant upon this construction is placed at \$140,000. The distribution system is to be overhauled and extended, \$25,000 having been set apart for the completion of that work. It might be explained that the major portion of the latter sum is to be expended in the direction of replacing a certain mileage of small pipe with conduits of larger diameter. Take it all in all, Superintendent Cowdery will have a busy time of it this summer.

TRYING TO “FIND OUT” WHERE HE “COMES IN.”—That “apostle of light and honesty,” Mister W. W. Gibbs, is in a sort of quandary just now, as the Consolidated Gas Company, of Baltimore, Md., appears to be rather backward in paying up the cash in settlement of certain “delicate” negotiations which Gibbs, according to his claim, carried on between the Equitable and Consolidated managers some time ago. It is surmised the negotiations were those which resulted in the termination of the war of gas rates enjoyed by the Baltimore gas consumer; or, in other words, the “deal” by which the price of gas was increased from \$1 to \$1.70 per thousand in the Monumental City. Mister Gibbs asks for the modest sum of \$50,000 as a recompense for his “delicate tactics.” He entered snit for that “pretty penny” on the 11th day of May; and Mister Gibbs' hair, we imagine, will be very thin by the time he gets a judgment. It is only to be hoped that the Consolidated Company will urge a speedy trial of the case; and we opine that if it ever comes before a jury, Mister Gibbs will be about the “sickest man” of his day and time in this country. There was a somewhat similar case to this in Brooklyn some years ago, or when a certain gentleman connected at the time with the Citizens Gas Light Company, of that city, asked to be remunerated for certain services rendered in connection with a proposed famous (it seems as though a prefix had been omitted from the last word) “deal” in Brooklyn gas circles. The Brooklyn party, though, never had the temerity to ask a court of justice to assist him in “collecting” the “remuneration;” and he never got one cent of the sum asked for. The water gas gentry had better “chain Mister Gibbs up,” as the hardness of his cheek appears to be extending rapidly in the direction of his “massive” organs of thought. It would be a pity if general induration should soon attack Mister Gibbs, or, at any rate, before he has had another chance at Washington.

SOMETHING FROM PITTSFIELD, MASS.—The annual meeting of stockholders of the Pittsfield Gas Light Company was held on Tuesday, May 5th, and the following board of directors was chosen for the ensuing year: Messrs. R. W. Adam, W. G. Backus, W. R. Plunkett, D. J. Dodge, and J. W. Hull. The directors organized by selecting R. W. Adam as President, and

W. R. Plunkett as Treasurer. Mr. Hull is a new man in the directorate, and was chosen to succeed Mr. Edwin Clapp, the latter named gentleman having “gone over to the silent majority.” The directors signalized their accession to office by making a reduced rate for gas, the terms of which come into effect on consumption dating from first of next October. The gross price was reduced from \$3 to \$2.50 per 1,000, discounts for prompt payment being the following:

A monthly consumption of less than	1,000 cubic feet,	25 cents per M.
“ “ “ between	1,000 and 50,000,	50 “ “
“ “ “ of over	50,000 cubic feet,	62½ “ “

In 1864 the price charged for gas at Pittsfield was \$5 per 1,000, and it should be understood that Pittsfield's population increase has by no means been commensurate with the steady decrease in gas rates. Still, the gas men there have kept on doing what they could towards improving their condition by pursuing honest business methods. Freight charges make gas coals dear in that locality, and the extremely low temperatures often experienced during the winter seasons are, of course, disadvantageous. Despite these disadvantages the Pittsfield folks have always managed to send out good gas, the report of State Gas Inspector showing the grand average of illuminating power for the year to have been 18.96 candles; and in face of every difficulty their business has steadily prospered. Two new benches of sixes were added to plant last year; an inclined railway, for conveying coal from storage sheds to retort house, was erected, and one or two minor betterments carried out, at the expense of several thousand dollars. The pretty city, nestling so near to the Berkshire hills, has no complaint to make about its gas purveyors.

BANGOR (ME.) TURNS ON THE ELECTRIC LIGHT.—The electric light plant installed at Bangor through the instrumentality of the American Electric Lighting Company, of Boston, Mass., was put in operation on the evening of April 24. The capacity of the station is rated as equal to the maintenance of 114 arc lights. The Armington & Sims Engine Company (Providence, R. I.) furnished the engines. It is said the Edison Company now proposes to erect a plant for incandescence lighting at Bangor.

THE DEATH ROLL.—P. Loeblen, keeper of a public barroom at 189 East 117th street, New York city, was found dead in his bed at 10:30 p.m., on evening of April 28th. He had retired to take a “nap” (at about 6:30 p.m.), requesting that he be called at 10:30 p.m., so that he might relieve his assistant. When Mrs. Loeblen went to arouse him at the appointed time she made the discovery that her husband was a corpse. It is said that a gas pipe to the apartment had not been properly capped, hence the escape that caused Loeblen's death by asphyxiation. It should be remembered that water gas is now being supplied by the Consolidated Company to the Harlem district, and there have been two deaths in the space of a month that are traceable to gas inhalation.

STREET LIGHTING AWARDS IN NEW YORK CITY.—The New York city Gas Commission, on April 28, met and awarded the contracts for city's street lighting for fiscal year ending April 30, 1885. The Consolidated Company's portion was allotted at the rate of \$17.50 per lamp, the Mutual Company getting an award at same figures. The Equitable Company gets all the lamps along its lines of mains at \$12 per annum each. It is estimated that the latter corporation will light about 1,200 lamps, and the loss incurred on each, at the contract figure, certainly cannot be less than \$4. It is a decided pity that the Equitable folks are not so situated that they might get the entire service to attend to. The Central Company is to light the 23d Ward lamps for \$28 each; the Northern and Yonkers Companies to be paid \$30 per lamp for lighting done in 24th Ward. The electric companies were authorized to continue their present lighting, and a grant of 56 additional lights was awarded them—the latter being located along Catherine, Chambers, Fulton, and Canal streets.

AN ELECTRIC LIGHTING COMPANY FOR THE HARLEM DISTRICT, N. Y.—According to a certificate of incorporation filed May 2, the objects for which the Harlem Electric Illuminating Company is created are “to produce and use electricity for purposes of light, heat, and power, and to manufacture and sell apparatus to be employed in its production.” The capital stock is \$300,000. The incorporators are G. F. Smith, H. Marsh, and D. Carleton.

Naphtha for Enriching Coal Gas.

CLEVELAND GAS LIGHT AND COKE COMPANY,
CLEVELAND, OHIO, March 18, 1885.

W. H. DOAN, Esq., Cleveland, Ohio:

Dear Sir—We have used for a number of years your naphtha for enriching our coal gas. We find we get a whiter light and higher candle power gas than we otherwise would by using canal coal; and we also avoid the annoyance of two qualities of coke.

Yours truly,

J. H. MORLEY, President.

—Adv.



A. M. CALLENDER & CO.,
PROPRIETORS.

Editor—**JOS. R. THOMAS, C.E**
Manager—**C. E. SANDERSON.**

PUBLISHED ON THE 2ND AND 16TH OF EACH MONTH
At No. 42 Pine Street, New York.

This is a recognized official organ of—
LIGHT, HEAT, STEAM, WATER-SUPPLY,
VENTILATION, SANITARY IMPROVEMENT,
AND GENERAL SCIENCE.

TERMS

SUBSCRIPTION—Three Dollars per annum, in advance.

AGENTS

NEW YORK—AMERICAN NEWS CO. 39 and 41 Chambers St.
BOSTON—S. M. PETTENGILL & Co., 6 State Street.
PHILADELPHIA—PRATT & Co., Corner 9th and Arch Streets.
England—C. W. HASTINGS, 22 Buckingham St., London, W. C
Germany—B. WESTERMANN & Co. of New York

SATURDAY, MAY 16, 1885.

Gas Stocks.

Quotations by **Geo. W. Close, Broker and Dealer in Gas Stocks.**

16 WALL ST., NEW YORK CITY.

MAY 16.

All communications will receive particular attention.
The following quotations are based on the par value of \$100 per share.

	Capital.	Par.	Bid	Asked
Consolidated.....	\$35,430,000	100	96½	97
Central.....	440,000	50	60	70
“ Scrip.....	220,000	—	47	57
Equitable.....	2,000,000	100	124	126
“ Bonds.....	1,000,000	—	107	110
Harlem, Bonds.....	170,000	—	—	—
Metropolitan, Bonds...	658,000	—	113	—
Mutual.....	3,500,000	100	130	132
“ Bonds.....	1,500,000	1000	104	107
Municipal, Bonds.....	750,000	—	—	—
Northern.....	125,000	50	50	—
“ Scrip.....	108,000	—	—	—
Gas Co's of Brooklyn.				
Brooklyn.....	2,000,000	25	127	129x
Citizens.....	1,200,000	20	83	85
“ S. F. Bonds...	320,000	1000	106	110
Fulton Municipal.....	3,000,000	100	148	150
“ Bonds....	300,000	—	104	108
Peoples.....	1,000,000	10	81	83
“ Bonds.....	290,000	—	105	110
“ “.....	250,000	—	90	95
Metropolitan.....	1,000,000	100	94	96
Nassau.....	1,000,000	25	123	126
“ Cfts.....	700,000	1000	92	94
Williamsburgh.....	1,000,000	50	134	137
“ Bonds...	1,000,000	—	110	110½
Richmond Co., S. I....	300,000	50	64	75
“ Bonds.....	40,000	—	—	—
Out of Town Gas Companies.				
Buffalo Mutual, N. Y...	750,000	100	80	85
“ Bonds....	200,000	1000	95	100
Citizens, Newark.....	918,000	50	103	115
“ “ Bonds.	124,000	—	105	110
Chicago Gas Co., Ills...	5,000,000	25	128	132
Peoples G. L. & C. Co.,				
Chicago, Ills.....			8	12

Cincinnati G. & C. Co..		180	182
Consolidated, Balt.....	6,000,000	100	54¾ 55
“ Bonds....	3,600,000	107	107½
Central, S. F., Cal.....		—	58
Capital, Sacramento, Cal.		56	—
Hartford, Conn.....	750,000	25	123 129
Jersey City.....	750,000	20	145 —
Laclede, St. Louis, Mo.	1,600,000	100	100 105
Louisville, Ky.....	1,500,000	50	95 100
Montreal, Canada.....	2,000,000	100	181 182½
New Haven, Conn.....		25	166 170
Oakland, Cal.....			29 30
Peoples, Jersey City...		—	45 —
“ “ Bonds..		—	—

Advertisers Index.

	Page
GAS ENGINEERS.	
Jos. R. Thomas, New York City.....	267
Wm. Henry White, New York City.....	264
GAS WORKS APPARATUS AND CONSTRUCTION.	
James R. Floyd, New York City.....	275
T. F. Rowland, Greenpoint, L. I.....	275
Delly & Fowler, Phila., Pa.....	275
Kerr Murray Mfg. Co., Fort Wayne, Ind.....	275
Stacey Mfg. Co., Cincinnati, Ohio.....	275
Bartlett, Hayward & Co., Baltimore, Md.....	274
Morris, Tasker & Co., Limited, Phila., Pa.....	248
Davis & Farnum Mfg Co., Waltham, Mass.....	274
Tanner & Delaney Engine Co., Richmond, Va.....	274
R. D. Wood & Co., Phila., Pa.....	274
Southwark Foundry and Machine Co., Philadelphia, Pa.....	274
GAS AND WATER PIPES.	
A. H. McNeal, Burlington, N. J.....	272
Gloucester Iron Works, Phila., Pa.....	272
Warren Foundry and Machine Co., Phillipsburgh, N. J.....	272
Mellert Foundry and Machine Co., Reading, Pa.....	272
Cincinnati and Newport Iron and Pipe Co., Newport, Ky.....	272
PIPE JOINTS.	
Pancoast & Maule, Philadelphia, Pa.....	267
Rollstone Machine Company, Fitchburg, Mass.....	267
SCRUBBERS AND CONDENSERS.	
G. Shepard Page, New York City.....	273
REGENERATOR FURNACES.	
Charles F. Dieterich, Baltimore, Md.....	276
GAS ENGINES.	
Schleicher, Schumm & Co., Phila., Pa.....	280
Clerk Gas Engine Company, Phila., Pa.....	268
RETORTS AND FIRE BRICK.	
J. H. Gautier & Co., Jersey City, N. J.....	270
B. Kreischer & Sons, New York City.....	270
Adam Weber, New York City.....	270
Laclede Fire Brick Works, St. Louis, Mo.....	270
Brooklyn Retort and Fire Brick Works, Brooklyn, N. Y.....	270
Borgner & O'Brien, Phila., Pa.....	270
William Gardner & Son, Pittsburgh, Pa.....	270
Henry Maurer, New York City.....	270
Chicago Retort and Fire Brick Works, Chicago, Ills.....	270
Baltimore Retort and Fire Brick Co., Baltimore, Md.....	270
Standard Gas Retort and Fire Brick Co., Ironton, Ohio.....	270
Oakhill Gas Retort and Fire Brick Co., St. Louis, Mo.....	270
Cincinnati Gas Retort & Fire Brick Co., Cincinnati, O.....	270
A. T. Chur, New York City.....	267
GAS STOVES.	
American Meter Co., New York and Philadelphia.....	271
The Goodwin Gas Stove and Meter Co., Philadelphia, Pa.....	252
GAS METERS.	
Harris, Griffin & Co., Phila., Pa.....	278
American Meter Co., New York and Philadelphia.....	279
The Goodwin Gas Stove and Meter Co., Phila. Pa.....	279
Helme & McIlhenny, Phila., Pa.....	279
Maryland Meter and Mfg. Co., Baltimore, Md.....	278
D. McDonald & Co. Albany, N. Y.....	279
Nathaniel Tufts, Boston, Mass.....	278
EXHAUSTERS.	
P. H. & F. M. Roots, Connersville, Ind.....	269
Smith & Sayre Manufacturing Co., New York City.....	274
Wilbraham Bros., Philadelphia, Pa.....	276
GAS COALS.	
Penn Gas Coal Co., Phila., Pa.....	277
Perkins & Co., New York City.....	276
Newburgh Orrel Coal Co., Baltimore Md.....	277
Despard Coal Co., Baltimore, Md.....	277
Chesapeake and Ohio R.R. Coal Agency, N. Y. City.....	277
Westmoreland Coal Company, Phila., Pa.....	277
GAS ENRICHERS.	
W. H. Doan, Cleveland, Ohio.....	267

VALVES.	
Ludlow Valve Manufacturing Co., Troy, N. Y.....	272
John McLean, New York City.....	272
GAS LAMPS.	
Siemens Regenerative Gas Lamp Co., Philadelphia, Pa.....	273
G. Shepard Page, New York City.....	249
GAS KILNS AND OVENS.	
Thompson Gas Kiln and Oven Co., New York City.....	269
PURIFIER SCREENS.	
John Calot, Lawrence, Mass.....	267
STREET LAMPS.	
J. G. Miner, Morrisania, New York City.....	269
Bartlett Street Lamp Mfg Co., New York City.....	267
BURNERS.	
G. Geffroyer, Phila., Pa.....	274
PURIFYING MATERIAL.	
Connelly & Co., New York City.....	267
STEAM BLOWER FOR BURNING BREASE.	
H. E. Parson, New York City.....	239
PIPE COVERINGS.	
Chalmers-Spence Company, N. Y. City.....	267
GAS FIXTURES.	
Mitchell, Vance & Co., New York City.....	269
STEAM ENGINES.	
Westinghouse Machine Co., Pittsburgh, Pa.....	277
STEAM PUMPS.	
A. S. Cameron Steam Pump Works, N. Y. City.....	269
HYDRAULIC ELEVATOR.	
Lane & Bodley Company, Cincinnati, Ohio.....	269
SHAFTING, PULLEYS, ETC.	
A. & F. Brown, New York City.....	267
HYDRAULIC MAIN.	
A. E. Boardman, Macon, Ga.....	269

Position Wanted,

As Superintendent or Assistant Superintendent
Of a gas works. Has had experience in the manufacture and distribution of gas, laying of mains and services, care of meters, and repair of same. Any company in want of a temperate, industrious man, address "W. T. W.," care this Journal.

FOR SALE,
Four Second-Hand Purifiers,

5 by 5 ft., with 6-in. center seal and 6 in. connections. Apply to
EAST RIVER GAS LIGHT CO.,
622-1t RAVENSWOOD, LONG ISLAND CITY, N. Y.

To Let,
GAS WORKS FOR EXPERIMENTING.

Situated at Astoria, Long Island City.
Apply to EAST RIVER GAS LIGHT CO.,
622-1t RAVENSWOOD, LONG ISLAND CITY, N. Y.

Ammonia Plant for Sale.

Owing to a change in the manufacture of gas by the York Gas Company, we offer for sale our complete plant for the manufacture of sulphate of ammonia from gas liquor. Capacity, 500 lbs. daily, which can be increased to 1,000 lbs. Suitable for a gas works carbonizing from 1,000 to 10,000 tons of coal per annum. We will agree to deliver, set up, and start the same for a moderate price, and show a fair profit. For further particulars address

C. H. DEMPWOLF & CO.,
622-4t YORK CHEMICAL WORKS, YORK, PA.

FOR SALE.

A 3-4ths Interest in Mattoon Gas Co.

Mattoon, Ills., is a flourishing town of about 8,000 inhabitants. Party wishes to sell on account of health. Address
621-2t MATTOON GAS CO., MATTOON, ILLS.

FOR SALE,

100 MINER GLOBE STREET LAMPS.

The lamps have been in use, but only those that are in good order are offered for sale. For terms, etc., address
THE NEW YORK & NEW JERSEY GLOBE GAS LIGHT CO.,
615-tf No. 1 Park Place, New York City.

WANTED,

**Second-Hand
Gas Works Apparatus.**

Hydraulic Main, Dip, Bridge, and Stand Pipes for a bench of sixes; Four Purifying Boxes, with either 6 or 8 inch seal and connections. The material must be in good condition. Address 619-4f E. McMILLIN, Columbus, Ohio.

For Sale at a Bargain.

COMPLETE 4-INCH GAS GENERATING APPARATUS,

From our old works. Iron Frame for Roof; Mouthpieces, Stand Pipes, etc., etc.

Just the thing for adding to capacity of works already in operation, or for starting a new works. Address

616-8t GAS COMPANY, LIMA, OHIO.

**New Process for Enriching
COAL GAS.**

A new process for enriching coal gas has just been invented. The coal gas, after passing from the hydraulic main, is led through Gasoline, which is carried off in vaporous form back into retorts and decomposed. The mixture results in a thoroughly fixed gas. Under this system ordinary coals can be made to yield double their normal candle power. For particulars apply to

IRA JAMES,
Pres't. Mattoon, Ills., Gas Light Company.

W. H. DOAN,
REFINER OF

NAPHTHA and GASOLINES

ALSO MANUFACTURER OF

A Special Grade of Naphtha for Gas Companies

FOR ENRICHING COAL GAS.

Correspondence solicited.

No. 43 Euclid Avenue, Cleveland, Ohio.

It will "Pay the Piper,"
If he aims to pipe well for STEAM, WATER, GAS, ACIDS, OILS, AMMONIA, &c., to examine this UNION, which requires no packing, but is always ready for instant use. When you next order Fittings of any Dealer, ask for a sample American Union to come with them, and it will tell you the whole story, or we will, if you write us for particulars.

PANCOAST & MAULE,
PHILADELPHIA, PA.

GAS CO. OFFICERS, **READ AND REFLECT.**

HODGE'S UNIVERSAL ANGLE UNION, Pat'd

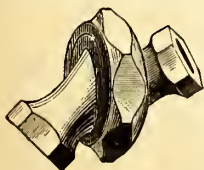

A new and important Pipe Fitting for Steam, Water, or Gas. Combining a variable angle or elbow and a union. Saves pipe, saves time, decreases friction and radiation, gives a union joint at every angle, and can be set at any angle at which it is desired to run the pipe.

HODGE'S SWIVEL FLANGE,

A common sense article, designed to save time and money.

MANUFACTURERS AND WHOLESALE AGENTS,

ROLLSTONE MACHINE CO.,

142 Water St., Fitchburg, Mass.

**WELSH "ABERNANT"
Silica Dinas Fire Brick & Cement.**

Unrivalled for Endurance Under Intense Heat. Percentage of Silica, 95.64.

Also SCOTCH "BLOCHAIRN" FIRE BRICK.

A. T. CHUR,

SOLE AGENT FOR THE UNITED STATES,

Mills Building, Room 14, Fifth Story, New York.

WM. FARMER, ENGINEER,
32 Park Place, Room 36, New York.

THE CHEMIST'S ASSISTANT; OR, KINDERGARTEN SYSTEM OF CHEMISTRY.

A system by which the elements and their valences are represented by illustrations and solid bodies.

BOX AND PAMPHLET COMPLETE, \$2.50.

**Iron Sponge,
GAS EXHAUSTERS,**

AUTOMATIC GAS GOVERNORS,

CONNELLY & CO., Limited,

No. 407 BROADWAY, NEW YORK CITY.

MITCHELL, VANCE & CO.,

MANUFACTURERS OF

Chandeliers

and every description of

GAS FIXTURES.

Also manufacturers of Fine Gilt Bronzes and Marble Clock warranted best time-keepers. Mantel Ornaments, etc.

Salesrooms, 836 Broadway, N. Y.

Special Designs furnished for Gas Fixtures for Churches, Public Halls, Lodges, etc.

NEWBIGGING'S

Gas Manager's Handbook.

Price, \$4.80.

EVERY GAS MAN SHOULD HAVE ONE.

Orders may be sent to this Office.

JOS. R. THOMAS, C.E.,

May be Consulted on all Matters Relating to Gas Works and Gas Manufacture.

ADDRESS THIS OFFICE.

OFFICE
43
PARK PLACE
WORKS
57, 59 AND 61
LEWIS ST.
60, 62, 64 & 66
Cannon
NEW YORK

**PROGRESS MACHINE
WORKS**

A. & F. BROWN

**Shafting, Pulleys,
HANGERS.**

F. Brown's Patent Friction Clutch.

Send for Illustrated Catalogue and Discount Sheet to

A. & F. BROWN,

No. 43 Park Place, New York City.

Pipe Coverings.

Fire-proof, Non-Conducting Coverings for

**STEAM PIPES, BOILERS,
And all Hot Surfaces.**

Made in sections three feet long. Easy to apply; light and cheap. Asbestos Materials, Fibre, Braided Packing, and Cement. These goods are used at Continental Works, Br'klyn.

CHALMERS-SPENCE COMPANY, 419 & 421 EIGHTH ST., N. Y.

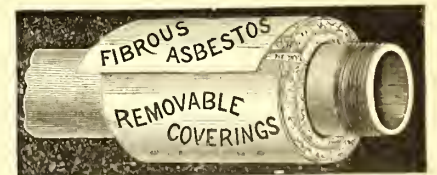

CHURCH'S REVERSIBLE SCREEN FOR GAS PURIFIERS

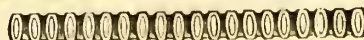

PATENTED JULY 9, 1878.

References in all parts of the country. Send for circular and list of companies who now have the Screen in use.

**Very Durable
Easily Repaired.**

**Oval Slats, with
Malleable Iron
Cross Bars.**

Apply to

JOHN CABOT,

LAWRENCE, MASS.

THE CLERK GAS ENGINE.

Highest Award American Institute, New York, 1883. Silver Medal American Institute, N. Y., 1884.
Gold Medal Awarded Crystal Palace Electrical Exhibition, London, 1882.
Highest Award for Motive Power British Section International Exhibition of Electricity, Paris, 1881.

Reliable.
No Boiler.
Steady.
No Coal.
Simple.
No Ashes.
Compact.

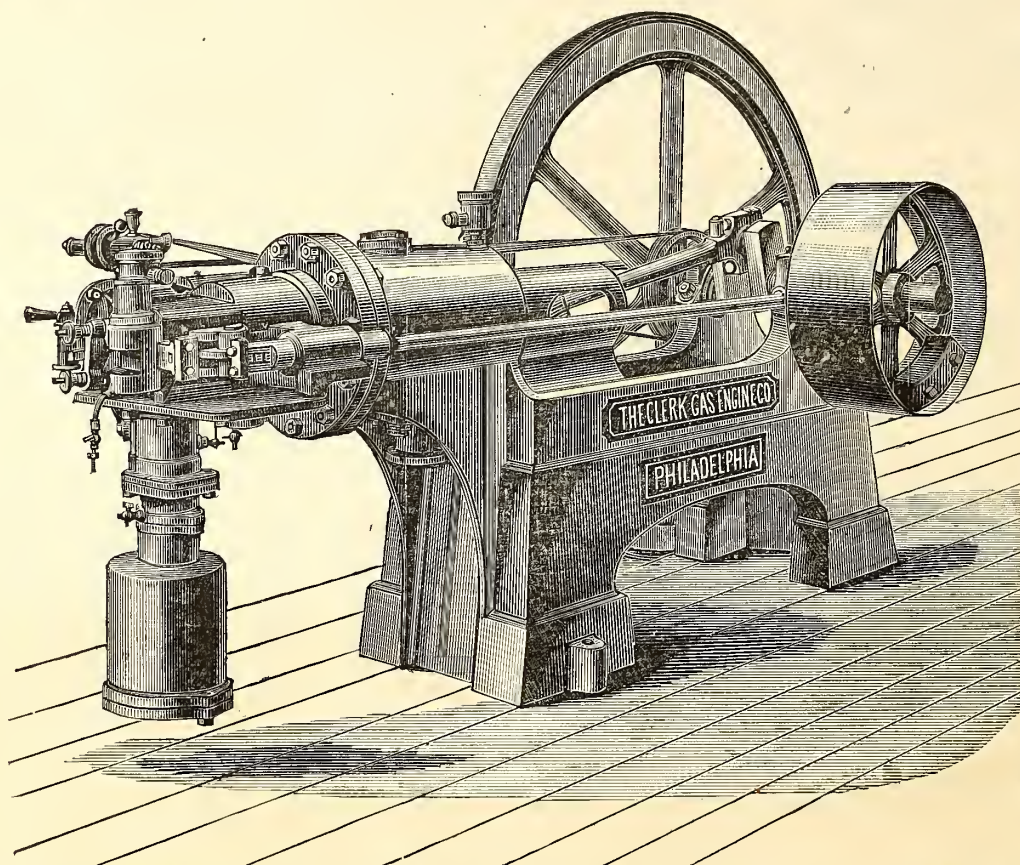

Economical.
No Engineer.
No Explosion
No Gearing
Wheels.
No Danger.
No Parts
requiring
frequent
renewal.

REQUIRING ONLY A MATCH TO START IT--GIVING ITS FULL POWER IMMEDIATELY.

We would inform the public that during the last few months we have improved THE CLERK GAS ENGINE to such an extent that we can now offer an engine vastly superior to our former pattern. These improvements have enabled us to sell our engine at a GREATLY REDUCED FIGURE, partly on account of the decreased weight (our engine weighing about half that of others giving the same Brake H. P). The consumption of gas has been decreased to a considerable extent, and the Brake H. P. has been increased some 25 to 30 per cent. All parts of the old design that were considered defective have been remodeled and new designs added. We now have an engine second to none as regards power, consumption, and ease of working. With our new engine all trouble in starting has been removed, the noise reduced to a minimum, and the regularity of motion is now all that can be desired. We guarantee all we claim for it, and the material and workmanship being of the best, enables us to guarantee the engine for twelve months.

SOLE MAKERS,

THE CLERK GAS ENGINE CO.,

WM. W. GOODWIN, President. E. STEIN, Secretary. S. LEWIS JONES, Asst. Secretary. L. P. GARRET, Supt.

Main Office, 1012-1018 Filbert Street, Philadelphia, Pa.

BRANCH OFFICES,

142 Chambers St., N. Y.

4 West Fourteenth St., N. Y.

76 Dearborn St., Chicago

General Agents,

THE GOODWIN GAS STOVE & METER CO.,
Of Philadelphia, New York, and Chicago.

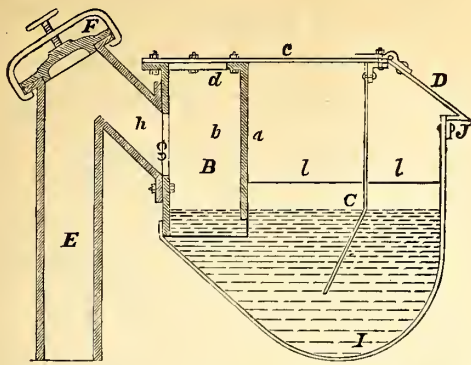

Boardman Hydraulic Main,

Patented October 7, 1884.

For description, see AM. GAS LIGHT JOURNAL of Feb. 2, 1884.
For terms, apply to

A. E. BOARDMAN, Macon, Ga.

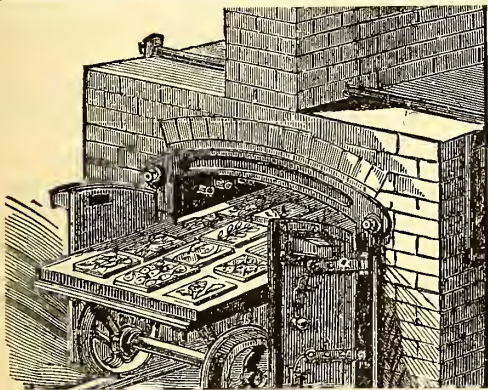

Glass-Staining Gas Kiln.

BAKERS' & CONFECTIONERS' OVENS (PAT.)

Thompson Gas Kiln & Oven Co.

59 Carmine St., N. Y.
Send for Circular by mail.

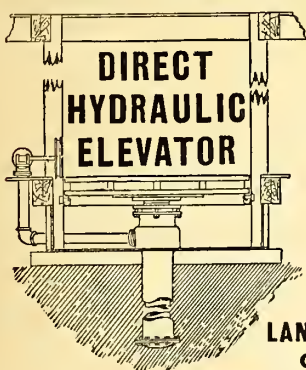

With Iron or Wood Platform.

Largely used by Leading Gas Co.s for Coal and Coke Lifts.

Adapted for use with city service, or special pumping and accumulator system. For prices address the

LANE & BODLEY CO., Cincinnati, O.

THE GLOBE STREET LAMP.



MINER'S PATENT STREET LAMPS.

Are adapted for use of Streets, Parks, Depots, Ferries, & Private Grounds.

WITH POSTS OR BRACKETS.

Jacob G. Miner,

MORRISANIA, N. Y. CITY.

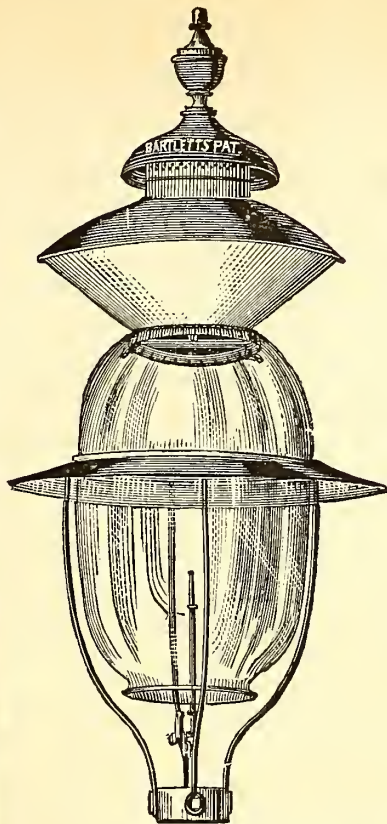

C. BARCALOW, PREST.

J. V. BARCALOW, SEC. & TREAS.

BARTLETT Street Lamp Mfg. Co.

MANUFACTURERS OF

Bartlett's Patent

GLOBE LAMPS.

FOR

Streets, Parks, Railroad Stations, Public Buildings, Etc.

LAMP POSTS A SPECIALTY.

Office and Salesroom,

No. 35 Howard Street, N. Y. City.

Gas Companies and others intending to erect lamps and posts will do well to communicate with us.

F. M. ROOTS.

S. C. ROOTS

D. T. ROOTS.

P. H. & F. M. ROOTS
PATENTEES AND MANUFACTURERS OF

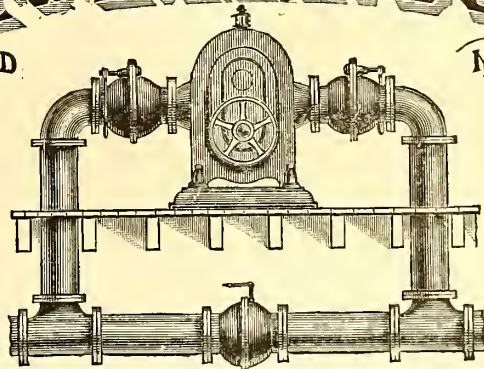

IMPROVED GAS EXHAUSTER,

WITH ENGINE ON SAME BED PLATE, OR WITHOUT.

BYE-PASSES, GAS VALVES, GOVERNORS, ELBOWS, PIPE-FITTINGS, Etc., FURNISHED TO ORDER.

P. H. & F. M. ROOTS, Patentees & Manufacturers, CONNERSVILLE, IND.

S. S. TOWNSEND, General Agent, 22 Cortland St. and 9 Dey St., N. Y.

JAS. BEGGS & CO., Selling Agents, 9 Dey St., N. Y.

COOKE & CO., Selling Agents, 22 Cortland St., N. Y.

✻ SEND FOR ILLUSTRATED CATALOGUE AND PRICE LIST. ✻

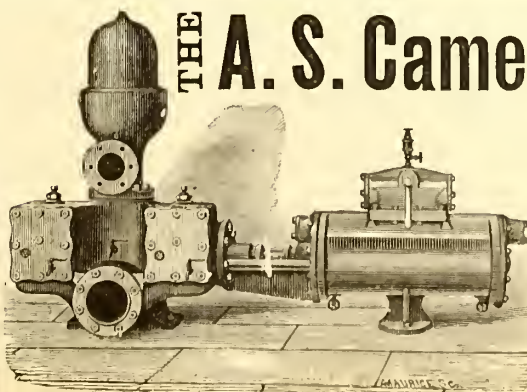

THE A. S. Cameron Steam Pump,

THE STANDARD OF EXCELLENCE.

Upward of 30,000 in Use.

BEST GAS WORKS PUMP

Ever Introduced.

Adapted to Every Possible Duty.

A. S. Cameron Steam Pump Works,

Foot East 23d St., N. Y.

J. H. GAUTIER & CO.,

CORNER OF
GREENE AND ESSEX STREETS,
JERSEY CITY, N. J.

MANUFACTURERS OF

**Clay Gas Retorts,
Gas House Tiles,
Fire Bricks, Etc. Etc.**
Ground Clay, Fire Brick and
Fire Sand in Barrels,

J. H. GAUTIER.
C. E. GREGORY.

T. B. GAUTIER.
C. E. GAUTIER.

BROOKLYN

Clay Retort & Fire Brick Works,
(EDWARD D. WHITE & CO.)

Manufacturers of Clay Retorts, Fire Brick,
Gas House and other Tile.

VAN DYKE, ELIZABETH, RICHARDS & PARTITION STS.
Office, 88 Van Dyke St., Brooklyn, N. Y.

LACLEDE FIRE BRICK MFG. CO.,

MANUFACTURERS OF

Fire Brick, Gas Retorts,

AND

ST. LOUIS STANDARD SEWER PIPE.

Blast Furnace and Cupola Linings, every description of Fire
Clay Material, Fire Clay Flue Linings, Chimney Tops
Dry Milled and Crude Fire Clays, etc.

OFFICE AND DEPOT

901, 903, and 905 Pine Street,
ST. LOUIS, MO.

ESTABLISHED IN 1845.

B. KREISCHER & SONS,

OFFICE FOOT OF HOUSTON ST., E.R., N.Y.

Gas Retorts,

TILES, FIRE BRICK.

AND EVERYTHING IN THE FIRE CLAY LINE.

MANHATTAN

FIRE BRICK & ENAMELLED CLAY

RETORT WORKS.

ADAM WEBER.

CLAY GAS RETORTS

AND RETORT SETTINGS

FIRE BRICKS, TILES, ETC.,

Office and Works, 15th Street and Avenue C., N. Y.

CHICAGO

Retort & Fire Brick Works,

OFFICE AND FACTORY,

Clark, Forty-Fifth, and La Salle Streets,

CHICAGO, ILL.

GEORGE C. HICKS, PRES. PAUL P. AUSTIN, SEC. & TREAS.

STANDARD

Clay Retorts and Settings.

BLOCKS & TILES

Of every Shape and Size to Order.

Standard Fire Bricks.

JAMES GARDNER, JR.

Works,
LOCKPORT STATION, PA.

ESTABLISHED 1864.

WILLIAM GARDNER & SON,

Successor to GARDNER BROTHERS.

WILLIAM GARDNER.

Office, COAL EXCHANGE,
PITTSBURGH, PA., P. O. Box 373.

Fire Clay Goods for Gas Works.

C. H. SPRAGUE, No. 70 KILBY STREET, BOSTON, MASS., Agent for the New England States.

OFFICE, 418 to 422 East 23d St., New York.

ESTABLISHED 1856.

WORKS, PERTH AMBOY, NEW JERSEY.

HENRY MAURER,

Excelsior Fire Brick & Clay Retort Works

CLAY GAS RETORTS, BENCH SETTINGS, FIRE BRICK, TILES, ETC.

STANDARD GAS RETORT AND FIRE BRICK COMPANY,

J. ANDERSON, PRES. & MANG'R.

OF IRONTON, OHIO.

C. PETERS, SECRETARY.

Clay Gas Retorts, Fire Brick, and Fire Clay Goods of Every Description.

Plans of Livesey-Somerville, McIlhenny, and other Furnaces, and Competent Workmen Supplied.



CINCINNATI

Gas Retort & Fire Brick Co.,

(ESTABLISHED 1872.)

CINCINNATI, OHIO.

Manufacturers of Gas Retorts, Retort Set-
tings, Fire Brick, Tiles, Etc.

OAKHILL

GAS RETORT & FIRE BRICK

COMPANY.

PARKER, RUSSELL & CO.

City Office, 711 Pine Street,

ST. LOUIS, MO.

Our immense establishment is now employed almost entirely in
the manufacture of

MATERIALS FOR GAS COMPANIES.

We have studied and perfected three important points. Our re-
torts are made to stand changes of temperature, the strongest
heats of the furnace, and the abrasion of feeding and emptying.
Our customers are in almost every State of the Union, to all of
whom we refer.

THOS. SMITH, Prest. AUGUST LAMBDA, Vice-Prest. & Sup

BALTIMORE

RETORT & FIRE BRICK CO.

MANUFACTORY AT

LOCUST POINT, BALTIMORE, MD.

Connection with the City by Telephone.

Clay Retorts, Blocks & Tiles,

FIRE BRICK, FIRE CLAY,

AND FIRE CEMENT.

Red and Buff Ornamental Tiles and Chim-
ney Tops. Drain and Sewer Pipe (from
2 to 30 inches). Baker Oven Tiles
12x12x2 and 10x10x2.

WALDO BROS., 88 WATER ST., BOSTON, MASS

Sole Agents for New England States

THE AMERICAN METER CO.,

MANUFACTORIES,

512 West Twenty-second Street, N. Y. Arch and Twenty-second Street, Phila.
Nos. 244 & 246 North Wells Street, Chicago, Ill.

AGENCIES,

No. 177 Elm Street, Cincinnati, Ohio. Nos. 122 & 124 Sutter Street, San Francisco Cal.
No. 810 North Second Street, St. Louis, Mo.

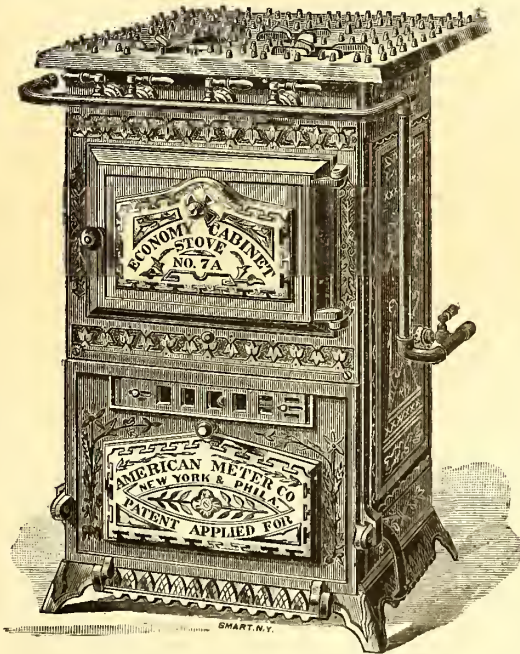

NEW DESIGN STOVES MADE IN CAST IRON, WITH EITHER OPEN OR CLOSED TOPS.

In presenting our "Economy" Gas Cooking Stoves and Ranges for the Season of 1885, we have the pleasure to inform our patrons that the increasing demand for these Stoves has encouraged us to make entirely new patterns, of HIGHLY ORNAMENTAL DESIGNS, for the popular sizes. We have also embraced the opportunity to increase the size of these Stoves, giving greater TOP PLATE AND OVEN capacity.

Full Lists and Catalogues are in preparation, and large stocks of Stoves will be kept at our Manufactories and Agencies for prompt shipment.

AMERICAN METER CO.

A. H. M'NEAL,

BURLINGTON, N. J.

Flange-Pipes

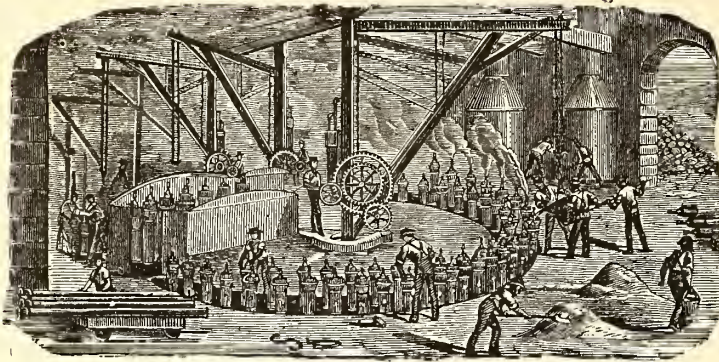

General Foundry Work.

CAST IRON PIPES FOR WATER AND GAS.

JAMES S. MOORE, Pres.
BENJAMIN CHEW, Treas.

JAS. P. MICHELLON, Sec.
WM. SEXTON, Supt.

GLoucester IRON WORKS, GLoucester CITY, N. J.

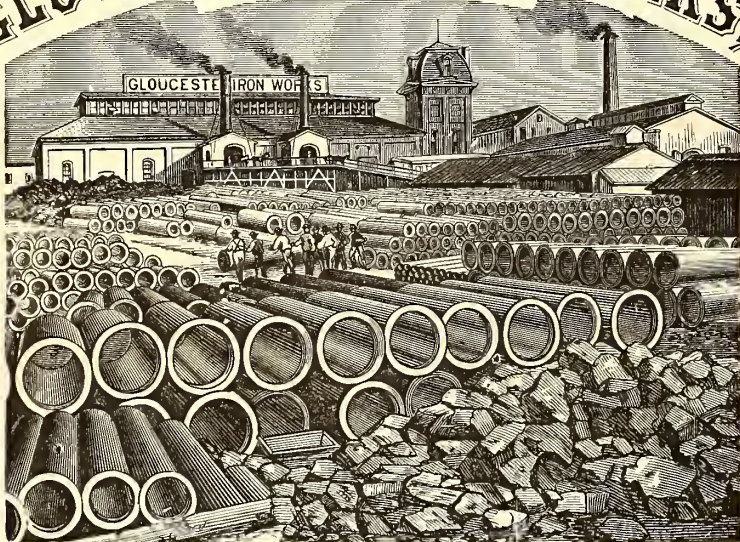

Cast Iron Gas & Water Pipes, Stop Valves, Fire Hydrants, Gasholders. &c.
Office No. 6 North Seventh Street, Philadelphia.

ESTABLISHED 1856.
WARREN FOUNDRY AND MACHINE CO.,
WORKS AT PHILLIPSBURGH, N. J.
NEW YORK OFFICE, 162 BROADWAY.

Cast Iron Water and Gas Pipe

FROM TWO TO FORTY-EIGHT INCHES DIAMETER.
ALSO ALL SIZES OF

FLANGE PIPE for Sugar House and Mine Work.
Branches, Bends, Retorts, Etc., Etc.

436-1

MATTHEW ADDY, President.

W. L. DAVIS, Selling Agent.

GEO. P. WILSHIRE, Sec. & Treas.

Cincinnati and Newport Iron and Pipe Company, NEWPORT, KY.

Lamp Posts
AND
BENCH CASTINGS

A Specialty.



Large & Heavy Castings for General Work.

Manufacture Pipe from 2 to 48 inches. All work guaranteed first quality.

Branch
AND
SPECIAL CASTINGS
FOR GAS & WATER CO'S.

Mellert Foundry and Machine Co. Limited. Established 1848. MANUFACTURERS OF



Specials—Flange Pipe, Valves and Hydrants,
Lamp Posts, Retorts, etc.
Machinery and castings for Furnaces, Rolling Mills, Grist and
Saw Mills, Mining Pumps, Hoists, etc.
GENERAL OFFICE, - - - READING, PA.

LUDLOW VALVE MFG. CO.

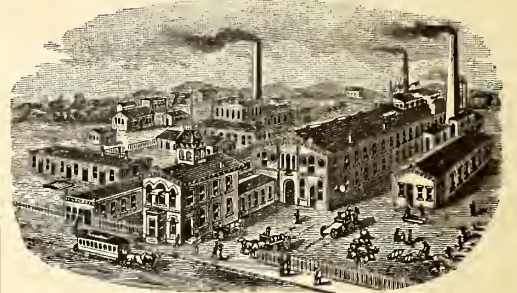

OFFICE AND WORKS,
938 to 954 River Street and 67 to 83 Vail Av.,
TROY, N. Y.

Hydraulic Main Dip Regulators, also
Check Valves, Foot Valves, Yard
wash and Fire Hydrants.
Send for Circulars.

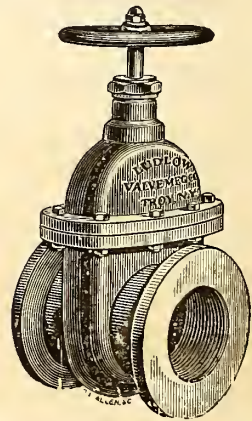

Valves.—Double and Single Gate, 1/2 in. to
48 in., outside and inside Screws. Indica-
tor, etc., for Gas, Water, Steam, and Oil.
Send for Circulars.

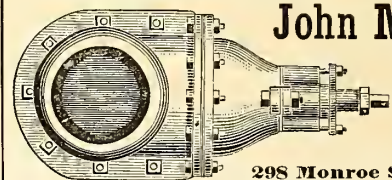

John McLean

Manufacturer of
**GAS
VALVES.**

298 Monroe Street, N. Y.

PRESERVE The Journal BY THE USE OF THE STRAP FILE.

Advantages of the Strap File.

- 1st. It is simple, strong, and easily used.
- 2d. Preserves papers without punching holes.
- 3d. Will always lie flat open.
- 4th. Allows any paper on file to be taken off without disturbing the others.

Price, \$1.25. Sent either by express or mail, at directed. By mail the postage will be 20 cents, which will be added to the price of the Binder.

A. M. CALLENDER & Co., 42 FINE ST., N. Y.

Siemens's Regenerative Gas Burners, For Lighting and Ventilating.

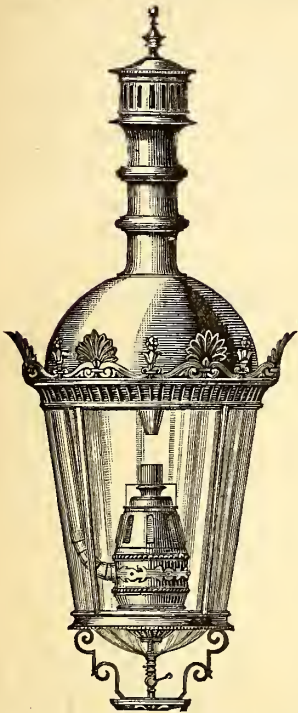

THE CHEAPEST, PUREST, AND MOST BRILLIANT OF ALL GAS LIGHTS.

Superior to the Electric Light in Economy, Beauty, & Steadiness.

SPECIALLY ADAPTED FOR LIGHTING HALLS, FACTORIES, OPEN SPACES, ETC.

Numerous Tests made by various Gas Companies in the United States show an Efficiency of Ten Candle Power per Cubic Foot of Gas.

General Agents:

- SIEMENS LIGHTING CO., 347 West Main St., Louisville, Ky.
- MEYER, MARSHALL & CO., 528 California St., San Francisco.
- DENNEHY, WOLF & O'BRIEN, 85 & 87 Dearborn St. Chicago, Ill.
- WILCOX & McGEARY, - No. 11 Bissel Block, Pittsburgh, Pa.
- T. T. RAMSDALL & CO., - 20 Swan Street, Buffalo, N. Y.
- SIEMENS GAS ILLUMINATING CO.,
Room 6, No. 157 Broadway, New York City.
- W. D. COLT, - - - - 1420 F Street, Washington, D. C.
- JOHN KIEFER, - - - 344 Lawrence, Street, Denver, Col.

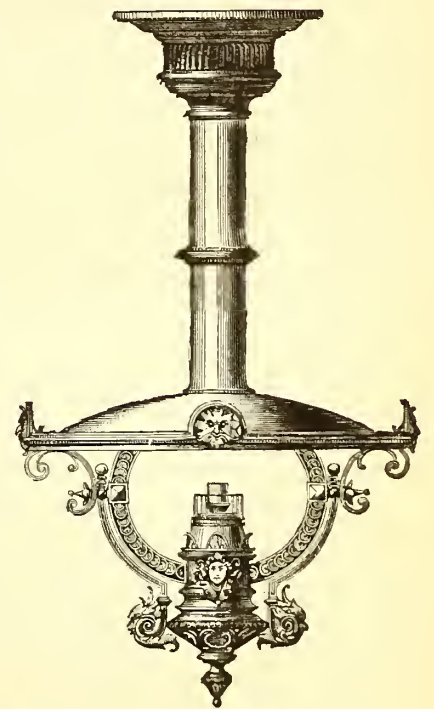

THE SIEMENS REGENERATIVE GAS LAMP COMPANY,
SOLE MAKERS FOR THE UNITED STATES,
N. E. Cor. 21st. St. and Washington Av., Philadelphia, Pa.

THE "STANDARD" WASHER-SCRUBBER, KIRKHAM, HULETT & CHANDLER'S PATENT.

Total Capacity per 24 Hours of "Standard" Washers Ordered During the Following Years.

1877.....	4,000,000 cubic feet.
1878.....	4,750,000 "
1879.....	24,545,000 "
1880.....	42,967,500 "
1881.....	36,462,500 "
1882.....	39,300,000 "
1883.....	57,735,000 "
1884.....	26,177,500 "
Total.....	235,937,500 cubic feet.

Total Number and Capacity per 24 Hours of "Standard" Washers Erected and in Course of Erection in the Several Countries

	Number.	Cubic Feet per Day.
Great Britain..	151	157,070,000
Western Hemisphere.	38	39,337,500
Australia.....	18	12,150,000
New Zealand ..	2	650,000
France.....	6	4,550,000
Belgium.....	8	5,420,000
Germany.....	16	8,200,000
Holland.....	4	4,160,000
Denmark.....	1	150,000
Russia.....	2	3,500,000
Spain.....	1	350,000
India.....	1	400,000
Total.....	248	235,937,500

THE CONTINUED POPULARITY

Of these Machines

Will be recognized from the following extracts from letters from representatives of some of the companies having them in use:

ALLEGHENY GAS WORKS, }
ALLEGHENY, PA., Dec. 12, '84. }

MR. GEO. SHEPARD PAGE, New York:

Dear Sir—The "Standard" Washer Scrubber is giving us entire satisfaction. At present we are using one gallon water per thousand cubic feet, and the liquor as it leaves the Scrubber is 8 degrees (16 oz.) by Twaddle's hydrometer.

Yours respectfully,
ROBERT YOUNG, Eng'r.

"Standard" Washers Ordered During the Current Year.

	Cu. Ft. per Day
Anneberg Gas Co.....	200,000
Bombay Gas Co.....	400,000
Brussels Co.....	1,250,000
Chemnitz Gas Co.....	1,000,000
CITIZENS GAS CO., BUFFALO.....	750,000
Coke Works in Zabre, Ober-Schlesien	1,500,000
Cokerei der Friedenshutte, Upper Silesia. ...	700,000
Dumfries Corporation.....	250,000
Dunedin Gas Co., New Zealand	400,000
King's Lynn Gas Co.....	300,000
Leiden, Holland.....	600,000
Lincoln Gas Co.....	400,000
Liverpool Gas Co.....	2,000,000
" ".....	3,000,000
LOUISVILLE GAS CO.....	1,500,000
Numea Gas Co.....	100,000
PITTSBURGH GAS CO.....	1,500,000
PORTLAND GAS CO., Oregon	562,500
SAN FRANCISCO GAS CO.....	4,000,000
Sheepbridge	40,000
ST. LOUIS GAS CO.....	2,000,000
Sydney Gas Co.....	2,500,000
WASHINGTON, D. C. GAS CO.....	2,000,000
Whitechurch Gas Co.....	175,000
Total.....	26,177,500

GEO. SHEPARD PAGE, No. 69 WALL STREET, NEW YORK,
SOLE AGENT FOR THE WESTERN HEMISPHERE.

R. D. WOOD & CO.,

400 Chestnut Street, Phila., Pa.

Cast Iron Gas & Water Pipe, Water Machinery & Gas Apparatus

Cast Iron Pipe, Fire Hydrants, Eddy Valves, Lamp Posts, Large Loam Castings, Flanged Pipe, Sugar House Work, Iron Roofs and Floors, Wrought & Cast Iron Tanks, Turbine Water Wheels and Pumps.

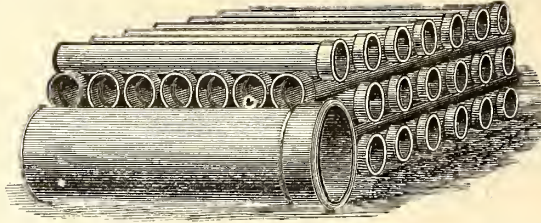

Casholders, Lime Trays, Center Valves, Purifiers, Bench Work, Exhausters, Condensers, Governors, Scrubbers, Gas Valves, Station Meters, Cast Iron Pipe Fittings.

Manufacturers of Heavy Castings and Machinery of Every Description.

ENGINEERS & CONTRACTORS FOR THE ERECTION OF GAS WORKS, & ALL MACHINERY CONNECTED THEREWITH

Estimates and specifications furnished for erection of new works or the extension or alteration of old ones.

Foundries and Works. - - Millville, Florence, and Camden, N. J.

SMITH & SAYRE MFG. COMPANY,

G. G. PORTER, Prest. 245 Broadway, N. Y. CHAS. W. ISBELL, Sec'y.

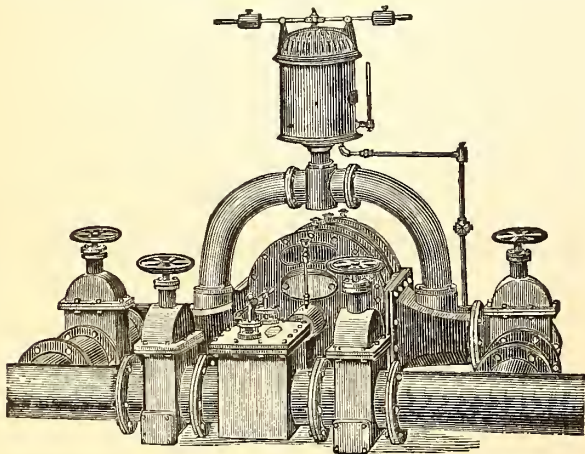

Machinery & Apparatus for Gas Works

Drawings, Plans, and Estimates Furnished for the Improvement, Extension, or Alteration of Gas Works, or for the Construction of New Works.

Mackenzie's Patent Rotary and Steam Jet Gas Exhausters, Governors, Compensators, Condensers, Washers, Scrubbers. Isbell's Patent Automatic Street Pressure Governor, Gas and Water Valves, Hydraulic Main Dip Regulator, Bench Castings, etc. Purifying Boxes and "Standard" Scrubbers. Isbell's Patent Self-Sealing Retort Doors.

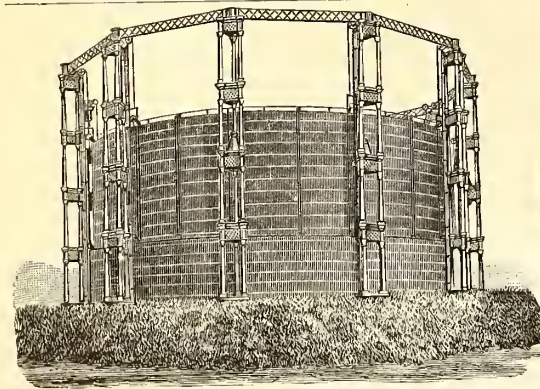

W. E. Tanner, Pres., W. R. Trigg, V.-Pres., A. Delaney, Supt.

Tanner & Delaney Engine Co.

RICHMOND, VA.

Gas Apparatus,

INCLUDING

Condensers of various styles, Scrubbers, Holders, Purifiers, Castings for Retort Houses, Etc.

ALSO STEAM ENGINES AND BOILERS.

Plans, Specifications and Estimates Furnished.

MORRIS, TASKER & CO.,

Limited,

Builders of Gas Works,

PHILADELPHIA, PA.

To Gas Companies.

We make to order **CAP BURNERS** to burn any amount under a stated pressure. Send for samples.

Also, **SERVICE CLEANERS, DRIP PUMPS,** and **STREET MAIN PROVING APPARATUS.**

C. A. GEFRORER,
248 N. 8th Street, Phila., Pa.

WM. HENRY WHITE,

Consulting & Constructing

Gas Engineer & Contractor.

ESTIMATES, PLANS, AND SPECIFICATIONS FURNISHED FOR NEW WORKS OR EXTENSIONS OF EXISTING WORKS.

32 Pine St., New York City.

Correspondence solicited.

SOUTHWARK FOUNDRY AND MACHINE COMPANY,

Successors to MERRICK & SONS. Established in 1836.

No. 430 Washington Avenue, Philadelphia, Pa.

MANUFACTURERS OF

Single and Telescopic Gasholders,

BENCH CASTINGS,

Washers, Scrubbers, Condensers, Purifiers,

And all apparatus necessary for the construction of improved new gas works and in the extension of established works. Also manufacturers of

Gas Engines, and of all descriptions of Steam and Hydraulic Machinery, and of Boiler and Tank Work. Plans, specifications, and estimates furnished promptly on application.

KERR MURRAY MFG. CO.,

MANUFACTURERS OF

Single Lift and Telescopic GASHOLDERS.

Built, 1884:

Altoona, Pa	Capacity, 160,000 cubic feet.
Pittsburgh, Pa	250,000 "
"	220,000 "
Bellaire, Ohio	50,000 "
Youngstown, Ohio	60,000 "
Canton, "	60,000 "
Akron, "	80,000 "
Xenia, "	10,000 "
Adrian, Mich	65,000 "
Ypsilanti, Mich	25,000 "
Muskegon, "	70,000 "
South Bend, Ind	70,000 "
Anderson, "	20,000 "
Plainfield, "	10,000 "
Springfield, Illinois	100,000 "
Evanston, "	50,000 "
Freeport, "	35,000 "
Elgin, "	60,000 "
Sheboygan Wis	20,000 "
Key West Fla	10,000 "

Plans and estimates furnished for the erection of new and the rebuilding of old works. Address

Kerr Murray Mfg. Co.,
FORT WAYNE, IND.

JAMES R. FLOYD,
(SUCCESSOR TO HERRING & FLOYD)

Oregon Iron Works,
531 to 543 West 20th St., N. Y.
Practical Builders of Gas Works,

MANUFACTURERS OF
ALL KINDS OF CASTINGS
AND
APPARATUS FOR GAS-WORKS.

- BENCH CASTINGS from benches of one to six Retorts each.
- WASHERS: MULTITUBULAR AND AIR CONDENSERS; CONDENSERS; SCRUBBERS (wet and dry), and
- EXHAUSTERS for relieving Retorts from pressure.
- BENDS and BRANCHES of all sizes and description.
- FLOYD'S PATENT MALLEABLE RETORT LID.
- PATENT SELF-SEALING RETORT LIDS.
- FARMER'S PATENT BYE-PASS DIP-PIPE.
- SABBATON'S PATENT FURNACE DOOR AND FRAME.
- BUTLER'S COKE SCREENING SHOVELS.

GAS GOVERNORS,
and everything connected with well regulated Gas Works at low price, and in complete order.

SELLER'S CEMENT
for stopping leaks in Retorts.
N. B.—STOP VALVES from three to thirty inches—at very low prices.
Plans, Specifications, and Estimates furnished.

CONTINENTAL WORKS.

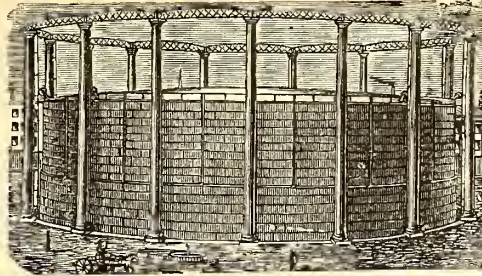

GASHOLDERS OF ANY MAGNITUDE.

T. F. ROWLAND, Proprietor,
GREENPOINT, BROOKLYN, N. Y.
ENGINEER AND MANUFACTURER OF
GAS-HOLDERS.
CONDENSERS, SCRUBBERS, VALVES,
PURIFIERS, RETORTS, and HY-
DRAULIC MAINS,

and all other articles connected with the Manufacture Distribution of Gas. Plans and Specifications prepared and Proposals given for the necessary Plant for Lighting Cities, Towns, Mansions, and Manufactories.

H. RANSHAW, Prest. & Mangr. WM. STACEY, Vice-Pres. T. H. BIRCH, Asst. Mangr. R. J. TARVIN, Sec. & Treas.

STACEY MFG. CO.,

MANUFACTURERS OF

Single and Telescopic Gasholders,

IRON ROOFS, BRIDGES, LAMP POSTS,

Water and Oil Tanks, Coal Elevator Cars,
COKE CRUSHERS, BENCH CASTINGS,

And all kinds of Wrought and Cast Iron Work used in the erection of Coal and Oil Gas Works. Rolling Mill Machinery and Heavy Castings a Specialty.

Foundry: 33, 35, 37 & 39 Mill Street. **Wrought Iron Works:** 16, 18, 20, 22, 24 & 26 Ramsey Street.

Cincinnati, Ohio.

BARTLETT, HAYWARD & CO.,

Office, 24 Light.

BALTIMORE, MD.

Works, Pratt &

PURIFIERS.
Roofs.
Bench Castings.

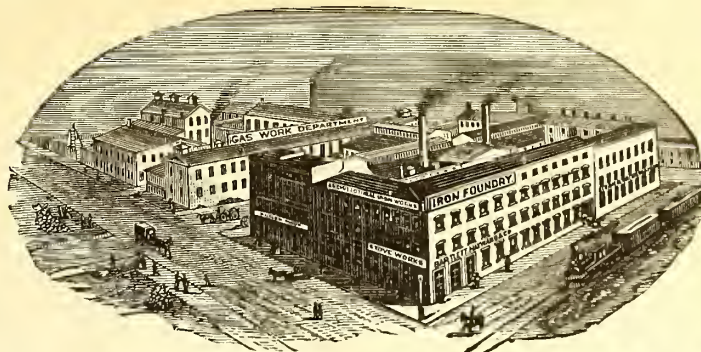

CONDENSERS.
BOILERS.
SCRUBBERS.

GASHOLDERS.

CONSTRUCTING ENGINEERS AND BUILDERS OF GAS WORKS.

1842. **DEILY & FOWLER,** 1884.

Laurel Iron Works.

Address, No. 39 Laurel Street, Philadelphia, Pa.

MANUFACTURERS OF

GASHOLDERS,

Single or Telescopic, with Cast or Wrought Iron Guide Frames.

HOLDERS BUILT SINCE 1880:

- | | | | | |
|--------------------------|----------------------|---------------------------|---------------------------|------------------------|
| Mount Joy, Pa. | West Point, N. Y. | Galveston, Texas (2d.) | Kalamazoo, Mich. (3d.) | Newport, R. I. |
| Rockaway B'ch, N.Y. (2) | Fitchburgh, Mass. | Marlboro, Mass. | Glen Island, N. Y. | Portland, Oregon. |
| Zanesville, O. (2d.) | New London, Conn. | Denver, Col. | Warren, Ohio. | Allegheny, Pa. (2d.) |
| Lancaster, O. | Derby, Conn. | Chicago, Ill. (West Side) | Bath, N. Y. | Atlanta, Ga. (2d.) |
| Blackwell's Island N. Y. | Bridgeport, Conn. | Pittsburgh, Pa. (S. Side) | Lynn, Mass. | N.Y. City (Central Ga) |
| Waltham, Mass., (1st.) | St. Hyacinth, Can. | Pawtucket, R. I. | New Bedford, Mass. | Lynchburg, Va. (2d.) |
| Dorchester, Mass. | Norwalk, O. | Brookline, Mass. | Waterbury, Conn. | Saylesville, R. I. |
| Wheeling, West Va. | Brattleboro, Vt. | Sherbrooke, Can. | Deseronto, Can. | Roudout, N. Y. |
| Lansing, Mich. | Waltham, Mass. (2d.) | Burlington, N. J. (2d.) | Hoosic Falls, N. Y. (2d.) | Atlantic City, N. J. |
| Flint, Mich. | West Chester, Pa. | Bridgeton, N. J. | Bethlehem, Pa. | Augusta, Ga. |
| Galveston, Texas (1st.) | Baltimore, Md. | Bay City, Mich. | Atlanta, Ga. (1st.) | Waltham, Mass. (2) |
| Milton, Pa. | Hollidaysburg, Pa. | Erie, Pa. | Savannah, Ga. | |
| Scranton, Pa. | | Jackson, Mich. | Montgomery, Ala | |

GAS COALS.

GAS COALS.

GAS COALS.

JAMES D. PERKINS.

PERKINS & CO.,

F. SEAVERN.

General Sales Agents for

The Youghiogheny River Coal Company's OCEAN MINE YOUGHIOGHENY GAS COAL.

The Coal from the Ocean Mine (recently operated by Messrs. W. L. Scott & Co., of Erie, Pa.,) is now used by all the leading Gas Companies in the United States from Maine to Texas, and is recognized as *the only reliable Youghiogheny Gas Coal.* (See Map on p. 87 of this Journal, Feb. 16, 1885.)

P. O. Box 3695,
New York.

PERKINS & CO., 228 and 229 N. Y. Produce Exchange BEAVER STREET
ENTRANCE.

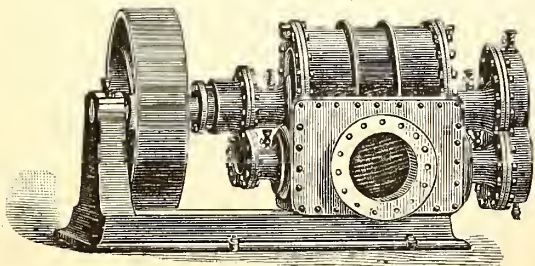

Gas Exhauster Driven by Belt.

The Wilbraham Gas Exhauster,

"BAKER SYSTEM,"

WITH ENGINE ATTACHED, ON SAME BED PLATE OR WITHOUT.

Best, Cheapest and Most Durable Exhauster known.

WILBRAHAM BROS.,

No. 2320 Frankford Avenue, Philadelphia, Pa.

Chas. F. Dieterich's Regenerator Furnace.

CAN BE ADAPTED TO ANY BENCH WITHOUT DISTURBING THE ORDINARY SETTINGS.

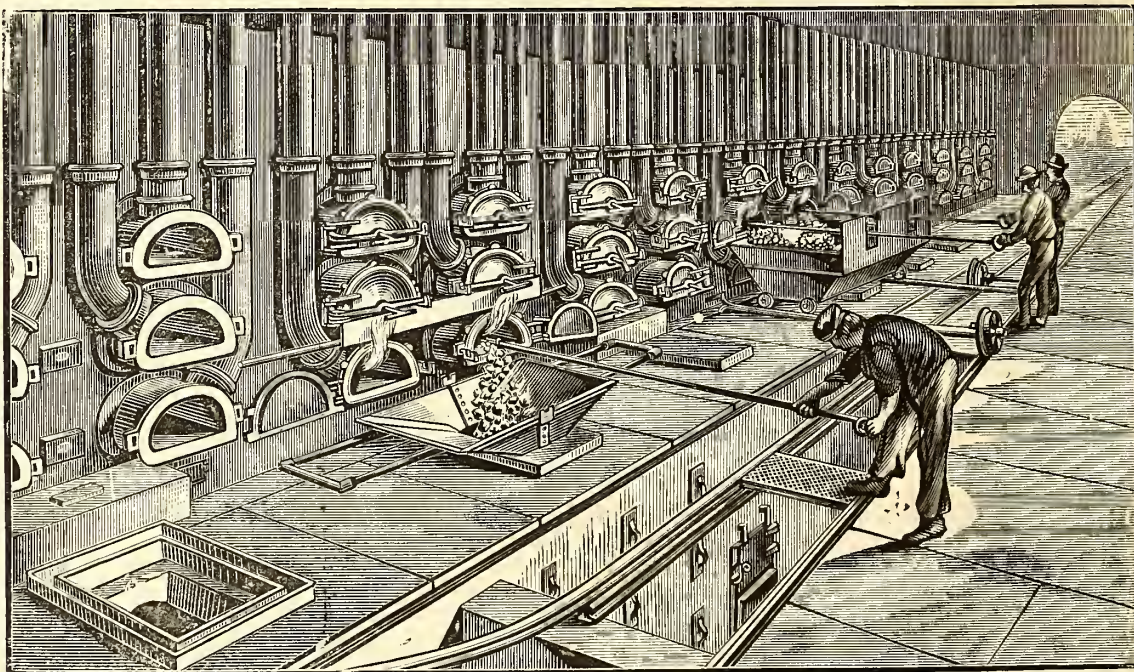

These Furnaces have been in operation at the works of the People's Gas Company, Baltimore, since June, 1878. A bench of sixes, with retorts 20 in. by 12 in. by 8 ft. 6 in. will burn off 1,350 pounds of coal in 3 hours. Twenty-five per cent. of the coke is sufficient to thoroughly burn off the charges.

We refer by permission to the following Companies who are using these Furnaces:

A. B. SLATER, Providence Gas Co. S. G. STINESS, Pawtucket Gas Co. JAS. H. ARMINGTON, Brooklyn Gas Lt. Co.
State, city, and factory rights granted on reasonable terms. For full particulars apply to

CHAS. F. DIETERICH, Engineer P. O. Box 512, BALTIMORE, MD.

GAS COALS.

GAS COALS.

GAS COALS,

Newburgh Orrel Coal Co.,

MINERS AND SHIPPERS OF

**Newburgh Orrel, Tyrconnell
and Palatine Gas Coals.**

ALSO SHIPPERS OF FOUNDRY COKE.

Mines Situated at

Newburgh, Flemington & Fairmont, W.Va.

HOME OFFICE,

25 S. Gay St., Baltimore.

CHARLES MACKALL,
MANAGER.

CHAS. W. HAYS, Agent in New York,

Room 92, WASHINGTON BUILDING, No. 1 Broadway.

Shipping wharves at Locust Point. References furnished when required. Special attention given to chartering vessels.

THE DESPARD COAL COMPANY

OFFER THEIR SUPERIOR

DESPARD COAL

To Gas Light Companies and Manufacturers of Fire Clay Goods
Throughout the Country.

ROUSSEL & HICKS, } AGENTS. { BANGS & HORTON,
71 Broadway, N. Y. } 16 Kilby St., Boston.

Mines in Harrison Co., West Va. Wharves, Locust Point, Balt.

Company's Office, 15 German St., Baltimore, Md.

Among the consumers of Despard Coal we name: Manhattan
Gas Light Co., N. Y.; Metropolitan Gas Light Co., N. Y.; Jersey
City, (N. J.) Gas Light Co.; Washington (D. C.) Gas Light Co.;
Portland (Maine) Gas Light Co. Reference to them is requested.

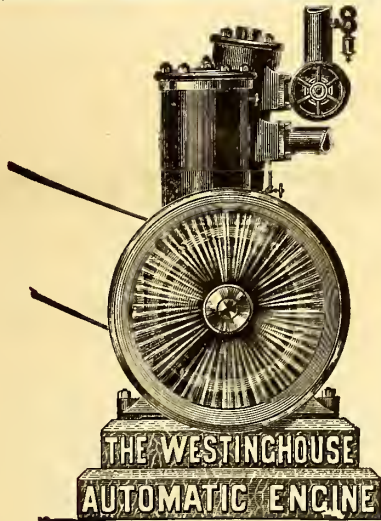

1,500 Engines Now in Use.

Our capacity being now equal to 100 Engines per
month, we shall hereafter keep in stock for immediate
shipment all sizes from 4 to 200 H.P.

SEND FOR ILLUSTRATED CIRCULAR AND REFERENCE LIST.

Westinghouse Machine Co.,

PITTSBURCH, PA.

SALES DEPARTMENT CONDUCTED BY

Westinghouse, Church, Kerr & Co., 17 Cortlandt
Street, New York City.

Fairbanks, Morse & Co., Chicago, Cincinnati, Cleve-
land, Louisville, and St. Paul.

Fairbanks & Co., St. Louis, Indianapolis, and Denver.

Parke & Lacy, San Francisco, and Portland, Or.

Parke, Lacy & Co., Salt Lake City, Utah, and Butte,
Montana.

D. A. Tompkins & Co., Charlotte, N. C.

Keating Implement & Machine Co., Dallas, Texas

Imray & Co., Sydney and Melbourne, Australia.

Robert Middleton, Mobile, Ala.

H. Dudley Coleman, 9 Perdido St., New Orleans, La.

R. Rogers, 43 Rue Laflitte, Paris.

**THE
PENN GAS COAL COMPANY**
OFFER THEIR
**COAL, CAREFULLY SCREENED,
AND PREPARED FOR
GAS PURPOSES.**

Their Property is located in the Youghiogheny Coal Basin, near Irwin's and Penn Station
in the Pennsylvania Railroad, and on the Youghiogheny River.

OFFICES

No. 209, South Third Street, Phil'a. 90 Wall Street, New York.

PLACES OF SHIPMENT.

Pennsylvania Railroad, Pier No. 2 (Lower Side).

Greenwich Wharves, Delaware River.

366-1y

Pier No. 1 (Lower Side), South Amboy, N. J.

Chesapeake & Ohio Railway Coal Agency,

FOR THE SALE OF THE

**Superior Kanawha Gas Coals, Cannelton Cannel,
Also, SPLINT AND STEAM COALS.**

From the Kanawha and New River Regions, on the line of the Chesapeake & Ohio R'way.

C. B. ORCUTT, Sales Agent. | OFFICE, 150 BROADWAY, N. Y.

FRANCIS H. JACKSON, PRESIDENT.

EDMUND H. MCCULLOUGH, SEC. & TREAS.

THE WESTMORELAND COAL CO.

Chartered 1854.

Mines situated on the Pennsylvania and the Baltimore
and Ohio Railroads, in Westmoreland County, Penn.

POINTS OF SHIPMENT:

PHILADELPHIA, BALTIMORE, SOUTH AMBOY, N. J.

WATKINS (SENECA LAKE), N. Y.

Since the commencement of operations by this Company its well-known
Coal has been largely used by the Gas Companies of New England and the
Middle States, and its character is established as having no superior in gas-
giving qualities, and in freedom from sulphur and other impurities.

Principal Office, 224 South 3d St., Phila., Pa.

The Management of Small Gas Works.

By C. J. R. HUMPHREYS. Price, \$1.

A. M. CALLENDER & CO., 42 Pine St., N. Y.

**CATHELL'S
Gas Consumer's Manual.**

Enables every gas consumer to ascertain at a glance, without any
previous knowledge of the gas meter, the quantity and money
value of the gas consumed. Also the best method of obtaining
from gas the largest amount of its light. It will be to the advan-
tage of Gas Companies to supply their consumers with one of
these Guides, as a means of preventing complaint arising from
their want of knowledge in regard to the registration of meters.

A. M. CALLENDER & CO., 42 Pine St., N. Y.

King's Treatise on Coal Gas.

The most complete work on Coal Gas ever published.

Three Vols. Bound, \$30.

A. M. CALLENDER & CO., 42 Pine St., N. Y.

**AMERICAN
GAS LIGHT JOURNAL.**

\$3.00 per Annum.

A. M. CALLENDER & CO.,
42 Pine Street, N. Y. City.

INTERNATIONAL--1876--EXHIBITION.



The U. S. Centennial Commission.

HAVE DECREED AN AWARD TO

HARRIS, GRIFFIN & CO.,

12th and Brown Sts., Philadelphia, and 49 Dey St., N. Y., U. S. A.,

FOR THE FOLLOWING REASONS :

The Exhibit consists of a Series of METERS from the Largest Size Station Meters for the use of the MANUFACTURE OF GAS, to those for the use of the ORDINARY CONSUMER. The Instruments are WELL MADE, RELIABLE as to INDICATION, and embody a number of sundry improvements which, with the general character of the Exhibit, entitle the whole to commendation.

Attest—J. L. CAMPBELL,
Secretary, pro-tem.Signed—A. T. GOSHORN,
Director GeneralJ. R. HAWLEY,
President

CHARLES E. DICKEY.

JAMES B. SMALLWOOD.

CHARLES H. DICKEY.

Maryland Meter and Manufacturing Co.,

DICKEY, TANSLEY & CO.,

Established 1866.

Nos. 22 and 24 Saratoga Street, Baltimore, Md.
No. 46 La Salle St., Chicago, Ill.

MANUFACTURERS OF

DRY GAS METERS, STATION METERS, GLAZED METERS, TEST METERS, METER PROVERS, PRESSURE AND VACUUM REGISTERS, GOVERNORS, INDICATORS, SERVICE AND METER COCKS, AND METER CONNECTIONS.

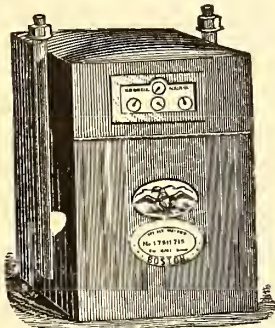

Dry Gas Meter.

With 39 years' experience and the best facilities for manufacturing, is enabled to furnish reliable work and answer orders promptly.

NATHANIEL TUFTS,

No. 153 Franklin Street, Boston, Mass.,

MANUFACTURER OF

DRY GAS METERS.

Station Meters of any Capacity.

Test and Experimental Meters, Pressure Registers, Pressure Gauges,
Pressure and Vacuum Gauges.

METER PROVERS, PHOTOMETERS, STREET LANTERNS, ETC., ETC.

Patent Cluster Lanterns for Street Illumination.

SCIENTIFIC BOOKS.

We are prepared to furnish to Gas Managers, and others interested in the topics treated of, the following books, at prices named:

KING'S TREATISE ON THE MANUFACTURE OF COAL GAS. Three vols.; \$10 per vol.	GAS CONSUMER'S MANUAL, by E. S. CATHELS, C.E. 10 cts.	A PRACTICAL TREATISE ON GAS AND VENTILATION, with Special Relation to Illuminating, Heating, and Cooking by Gas, by E. E. PERKINS. \$1.25.
GAS MANUFACTURE, by WILLIAM RICHARDS. 4to., with numerous Engravings and Plates, in Cloth binding. \$12.	PRACTICAL TREATISE ON HEAT, by THOMAS BOX. Second edition. \$5.	PURIFICATION OF COAL GAS, by R. P. SPICE. 8vo. \$3.
THE GAS ANALYST'S MANUAL, by F. W. HARTLEY. \$2.50.	GAS WORKS—THEIR ARRANGEMENT, CONSTRUCTION, PLANT, AND MACHINERY. \$8.	HOW TO MANAGE GAS, by F. WILKINS. Paper. 20 cents.
ANALYSIS, TECHNICAL VALUATION, PURIFICATION, and USE OF COAL GAS, by REV. W. R. BOWDITCH, M.A.; with Engravings; 8vo., Cloth. \$4.50.	COAL; ITS HISTORY AND USE, by PROF. THORPE. \$3.50.	THE GAS MANAGER IN THE LABORATORY, by a Practical Student. 8vo., Cloth. \$1.50.
GAS MEASUREMENT AND GAS METER TESTING by F. W. HARTLEY. \$1.00	THE GAS WORKS OF LONDON, by COLBURN. 60 cents.	THE DOMESTIC USES OF COAL GAS, AS APPLIED TO LIGHTING, by W. SUGG. \$1.40.
GAS CONSUMER'S HANDBOOK, by WILLIAM RICHARDS, C.E.; 18mo., Sewed. 20 cents.	THE GAS FITTER'S GUIDE, Showing the Principles and Practice of Lighting with Coal Gas, by JOHN ELDRIDGE. 40 cents.	DISTILLATION OF COAL TAR AND AMMONIACAL LIQUOR, by GEO. LUNGE. \$8.50.
	GAS WORKS, AND MANUFACTURING COAL GAS, HUGHES. \$1.80.	A TREATISE ON THE COMPARATIVE COMMERCIAL VALUES OF GAS COALS AND CANNELS, by D. A. GRAHAM. 8vo., Cloth. \$3.
	THE MANAGEMENT OF SMALL GAS WORKS, by C. J. R. HUMPHREYS. \$1.	

The above will be forwarded by express, upon receipt of price. We take especial pains in securing and forwarding any other Works that may be desired, upon receipt of order. All remittances should be made by check, draft, or post office money order.

A. M. CALLENDER & CO., No. 42 Pine Street, New York.

T. C. HOPPER, Pres. G. J. McGOURKEY, Vice-Pres. (New York). WM. N. MILSTED, Gen. Supt. & Treas. (New York). WM. H. DOWN Sec.

AMERICAN METER COMPANY,

WET AND DRY GAS METERS. STATION METERS. EXHAUSTER GOVERNORS. DRY CENTRE VALVES. GOVERNORS FOR GAS WORKS.

PRESSURE REGISTERS. PRESSURE & VACUUM REGISTERS. PRESSURE & VACUUM GAUGES. CRESSON GAS REGULATORS. MARSLAND WATER METERS.

METER PROVERS. PORTABLE TEST METERS. EXPERIMENTAL METERS. AMMONIA TEST METERS. BAR AND JET PHOTOMETERS.

Manufactories:
512 W. 22d St., N. Y.
Arch & 22d Sts., Phila.

GAS STOVES,
SUGG'S "STANDARD" ARGAND BURNERS,
SUGG'S ILLUMINATING POWER METER,
Wet Meters, with Lizar's "Invariable Measuring" Drum.

Agencies:
177 Elm Street, Cincinnati.
244 & 246 N. Wells Street, Chicago.
810 North Second Street, St. Louis.
122 & 124 Sutter St., San Francisco.

HELME & McILHENNY,

(Successors to Harris & Brother. Established 1848.)

GAS METER MANUFACTURERS,

CONTINUE AS HERETOFORE AT THE OLD ESTABLISHMENT,

Nos. 1115 and 1117 Cherry Street, Philadelphia, Pa.,

To Manufacture Wet and Dry Gas Meters, Station Meters, Experimental Meters, Meter Provers, Center Seals, Pressure Registers, GOVERNORS, INDICATORS, PHOTOMETERS, & ALL OTHER KINDS OF APPARATUS FOR USE IN GAS WORKS.

From our long practical experience of the business, and from our personal supervision of all work, we can guarantee all orders to be executed promptly, and in every respect satisfactorily.

WM. WALLACE GOODWIN, Prest. and Treas.

WM. H. MERRICK, V.-Prest.

S. L. JONES, Sec.

S. V. MERRICK, Supt.

THE GOODWIN GAS STOVE AND METER COMPANY,

Successors to W. W. GOODWIN & CO.

1012, 1014 and 1016 Filbert St., Phila., Pa. 142 Chambers St., New York.
76 Dearborn St., Chicago, Ill.

WALDO BROS., Agents, 88 Water St., Boston.

MANUFACTURERS OF THE "SUN DIAL" GAS STOVES, FOR COOKING AND HEATING PURPOSES.

Dry and Wet GAS METERS, Station Meters (Square, Cylindrical or in Staves) Glazed Meters, King's and Sugg's Experimental Meters, Lamp Post Meters, Etc., Etc., Meter Provers (sizes 2, 5 and 10 feet), Pressure Guages of all kinds, Pressure Registers, Pressure and Vacuum Registers, Pressure Indicators (sizes 4 inch, 6 inch and 9 inch), King's Pressure and Vacuum Gauges, Dry and Wet Centre Seals, Dry and Wet Governors, Exhauster Governors, Photometers of all descriptions. Lethby's Sulphur and Ammonia Test Apparatus complete—also Testing and Chemical Apparatus of all kinds, and of the most perfect description, for all purposes relating to Gas.

GOODWIN'S IMPROVED LOWE'S JET PHOTOMETER.

Agents for Bray's Patent Gas Burners and Lanterns.

Special attention to repairs of Meters, and all apparatus connected with the business.
All work guaranteed first class in every particular, and orders filled promptly.

G. B. EDWARDS, Mang'r, New York.
E. H. B. TWINING, Mang'r, Chicago.
A. B. STANNARD, Agent.

D. McDONALD & CO.,

GAS METER MANUFACTURERS.

(Established 1854.)

No. 51 Lancaster Street, Albany, N. Y.

STATION METERS, EXPERIMENTAL METERS, METER PROVERS, PRESSURE & VACUUM REGISTERS, PRESSURE GAUGES, ETC.

Also STAR GAS STOVES, RANGES, and HEATING STOVES.

We use only the very best materials, and employ the most skilled labor, and by our long experience (29 years) and personal supervision of every detail, we feel justified in assuring the public that our goods will give perfect satisfaction. Every Meter emanating from our establishment will bear the State Inspector's BADGE, and will be fully warranted by us. Our Annual and Calendar will be sent to Gas Companies upon application.

KING'S TREATISE ON COAL GAS.

The most complete work on Coal Gas ever published. Three vols., bound, \$30.

A. M. CALLENDER & CO., No. 42 Pine Street, New York.

THE "OTTO" GAS ENGINE.

Guaranteed to Consume 25 to 75 ANY OTHER GAS ENGINE
Per Cent. LESS GAS than PER BRAKE HORSE POWER.

TWIN ENGINES Impulse every revolution.
THE STEADIEST RUNNING GAS ENGINE YET MADE.

ENGINES AND PUMPS COMBINED,

For Hydraulic Elevators, Town Water Supply, or Railway Service.

Special Engines for Electric Light Work.

OVER 15,000
IN USE.

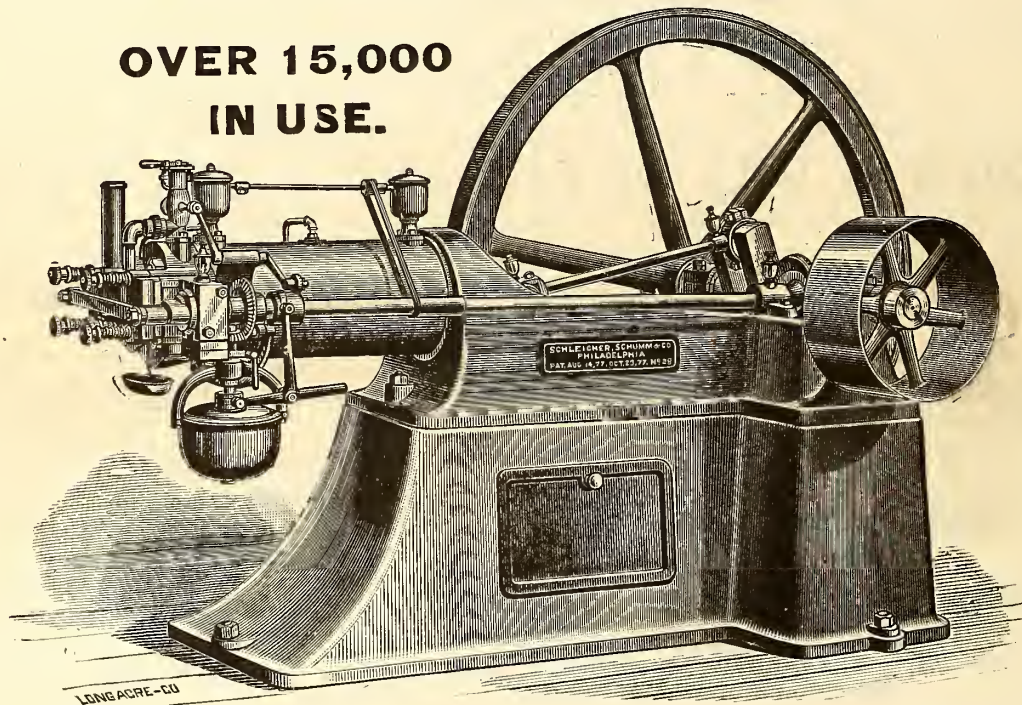

The Otto Gas Engine is now consuming, at a moderate computation, 2000 millions cubic feet of gas per year, nearly all of which is furnished during day time only.

**THE ONLY HIGHEST AWARD, ONLY GOLD MEDAL,
AT ELECTRICAL EXHIBITION, PARIS, 1881.**

MADE IN SIZES FROM 1 TO 25 HP. INDICATED.

FOR PARTICULARS, PRICES, ETC., APPLY TO

SCHLEICHER, SCHUMM & CO.,

Works:

E. Cor. 33d & Walnut Sts., Phila., Pa.

Branch Office:

214 Randolph Street, Chicago, Ill.

THE AMERICAN

GAS LIGHT JOURNAL

REDMAN, KENNY, N. Y.

PUBLISHING OFFICE No. 42 PINE STREET

DEVOTED TO THE INTERESTS OF ILLUMINATION, VENTILATION, WATER SUPPLY AND DISTRIBUTION, & GENERAL SCIENCE.

VOLUME XLII.—No. 11.
Whole No. 623.

NEW YORK, TUESDAY, JUNE 2, 1885.

{ \$3 PER ANNUM
IN ADVANCE.

A. M. CALLENDER & CO., Proprietors. C. E. SANDERSON, Manager.
JOS. R. THOMAS, C. E., Editor.

ENTERED AT THE POST OFFICE AT NEW YORK, N. Y.,
AS SECOND CLASS MATTER.

Published on the 2d and 16th of each month, at No. 42 Pine Street, N. Y.

Terms of Subscription, Including Postage.—For the United States and Canada, \$3 per annum. European countries, \$3.50 (15 shillings—18 francs). All payments to be made in advance. Single copies, 15 cents.

Remittances should be made either by post-office order, registered letter, or bank draft on New York, payable to the order of A. M. Callender & Co.

Collections are invariably made directly from this office, for subscriptions, advertisements, etc. We have agents to solicit the same, but they are not authorized to receipt for money.

Correspondence.—Wishing to make this JOURNAL a gazette of intelligent discussion to those of our readers who may wish to gain or give information on the subjects to which its columns are devoted, correspondence is solicited for publication from all who make the study of those subjects a pleasure or a profession.

The American News Company, Nos. 39 and 41 Chambers street, New York, are agents for this JOURNAL. Newsdealers will send orders to them.

Books.—We will mail, post-paid, at publisher's lowest rates, any book—scientific or otherwise—to any address in the United States or Canada. No books will be sent C. O. D.

CONTENTS.

An Asterisk (*) denotes an illustrated article.

EDITORIALS—

The Chicago Meeting of the Western Gas Association.....	281
All Hail to President Newman.....	282
Eighth Annual Meeting of the Western Gas Association—Official Report.....	283
First Day, Morning Session—Roll-Call—Reading of Minutes—President's Address—Committee on President's Address—New Members—Committee on Obituary Resolutions—Welcoming the Visitors—Committee on Nomination of Officers.	
Papers Read before the First Annual Meeting of the Ohio Gas Light Association, with Discussions on Same—Official Report—Concluded from page 262.....	285
Discussion on "What is the loss in weight of coal from a storage of six months, or the difference between weights of coal when put into coal house and charged into retorts?"—Second Day, Morning Session—How can the Form of the Retort, or the Manner of Setting the Same, be Improved? by Mr. J. Anderson—Discussion—Adjournment.	
The Effect of Carbonic Acid on the Illuminating Power of Coal Gas, by C. J. R. Humphreys.....	288
*The Bower Recuperative Burner.....	289
Special English Correspondence.....	290

ITEMS OF INTEREST FROM VARIOUS LOCALITIES..... 291

Mister Gibbs "Gets Left"—The Death Roll—Case No. 1 Looks Like a Suicide—Case No. 2—Our English Contemporary Thinks So Too—Trumping up Charges of Labor Troubles—Certainly; Why Not?—How a Reverend Gentleman Looks upon Different Lights—More Investigations—The Cost of Operating a Gas Assaying Furnace—Nominating an Inspector of Gas Meters—How they Trust One Another—Striving for an Increased Summer Consumption—Montgomery (Ala.) to do Likewise—Gas Turned on at Los Gatos, Cal.—Waiting for the Improved Machines—No Electric Light for Poughkeepsie, N. Y.—Is it a Job?—Station Meter Blown Up—Gas War at Austin, Texas.

The Market for Gas Securities 293

THE CHICAGO MEETING OF THE WESTERN GAS ASSOCIATION.

The Western Gas Association celebrated its eighth annual birthday, in right royal style, at the Tremont House, Chicago, Ills., on the 13th, 14th and 15th days of last month. It was anticipated that a right good rousing anniversary would be the result of Secretary Littleton's earnest attention to the preliminary work of the gathering; but when President Lausden rapped for order on the morning of the 13th, and announced that everything was in readiness for the transaction of business, the grand attendance of honest, earnest men was such as to make the speculatively inclined open wide their eyes in wonderment while revolving within themselves the question as to what proportions might be attained by this Western Gas Association within the next decade. Let the dwellers in the East (or rather let those so inclined refuse to see) look upon it as they will, the Westerner is the coming man—he is resolute unto aggressiveness, and knows no such thing as turning back. But as this is scarcely the proper time or place to discuss the "coming man," we will dismiss the matter and return to the subject in hand.

To show with what *celeritate* the arrival of the visitors was ushered in, we might mention that on the evening of the 12th, at an hour when almost every train that entered Chicago was contributing its quota of living freight, in the shape of gas men, to the hospitable embraces of the "Gotham of the West," the weather clerk had provided a sort of impromptu reception in the shape of a smart thunder shower; and to keep along with a description of the after weather conditions during the days of the sessions, the word perfect best describes them. To some, perhaps, it may have appeared as though the mercury were over-anxious to mount the scale; but to us from the East, and particularly so with those from localities not far removed from the Atlantic coast line, the first ardors of old Sol's rays are sure to be appreciated.

It will be remembered that about the only thing in the nature of a drawback to complete enjoyment of the proceedings at the St. Louis meeting of the year previous was the poor acoustic property of the hall or parlor in the Southern Hotel in which the sessions were held. With that experience in view, the Local Committee of Arrangements for the present year saw to it well that a like complaint should not be heard in 1885; nor was it sounded. The Tremont House answered most admirably in every respect, and too much praise cannot be awarded the proprietor of that elegant and commodious caravansary for his solicitude in attending to the wants, as well as in his untiring ministrations to the comforts of his guests.

As said before, the attendance was grand, and everybody was immensely pleased thereat. Lausden, brisk as ever, bubbled over in smiles, and genial Gus Littleton fairly hugged himself in congratulation. The local committee were as active as crickets—indeed they seemed to have become for the time almost ubiquitous. When the Chairman had fairly started the business in, and no time was wasted in preliminaries, with the reading of his annual message, everything progressed smoothly and rapidly. In his address Mr. Lausden departed somewhat from the usual style of handling the matters generally contained in such documents; and, take it all in all, we think he did rather wisely. He spoke his mind in a thoroughly common-sense way, and put things forward in a nice congruity. We do not propose to discuss at length the topics descanted on by him; and, indeed, had we the mind to do so, the action of the committee appointed by the Association to consider the same lifts the subject proper from the sphere of legitimate criticism. How-

ever, we cannot forbear noting one or two points. Mr. Lansden sounds the true metal when he invites those in charge of the smaller works to "come to the front" with the recital of their experiences in manufacture. These are the very men whose daily practice affords most valuable ground for future progress in the larger plants. Your "big company" is not complete without its experimental fitting. Right next we beg to disagree with Brother L.; and must submit that we incline to the view that he is woefully out in the way of his estimate with what he calls the "science of gas manufacturing." Science and practice must go hand-in-hand in any business that is in any manner allied to the twin sisters, chemistry and physics, if the full measure of success is to be realized. We cannot think that Mr. Lansden means to be taken literally in his statement, "I would not exchange one month's practical experience for fifty years of delving into the science of gas manufacturing."

But, to forbear from any further notice of this single point wherein we differ with Mr. Lansden's statements, we think it must have been with a keen appreciation of the humor of the situation that Mr. Lansden listened to the president of that small company, when the latter put himself on record as believing that "your gas associations are all a humbug. * * * No two of you could agree on anything." We sorrow with Mr. L. that the "small president's" superintendent was not present at the meeting, and further believe that the "small company" would be better served if that president (we have not the slightest idea who he is) handed in his resignation. That portion of the address relating to the topic of gas meters we commend most heartily to the tender consideration of "our own dear Mr. Sherwood" and his brother agitators. Chairman Lansden welcomed to the banded ranks the Ohio and Iowa State Associations, and with good foresight hopes that the other States will follow in the practice. May we hope Mr. L. will see to it that initiatory steps will soon be taken in Missouri? It is in the formation of these State bodies that proper legislation in regard to control of the gas business may be best effected. Mr. Lansden's tribute to the memory of Mr. Butterworth is the offering of a kindly heart, and does but simple justice to the honor and manliness of the Association's dead ex-president. We must confess that Mr. Lansden's announcement of the demise of associate-member, Mr. George Downing, of New York city, was news to us. He was a genial, generous man, and one whose absence from the ranks cannot fail to be sincerely regretted.

Mr. Lansden's address will be found reproduced on pp. 283-4 of this issue, and the manager of every small gas works in this country will find it worth many a bright dollar to him if he will but study it closely.

Littleton had his hands full all through the first day's session in attending to the applications for membership, and by the time the list was tallied up the roll had been increased by 36. His annual report of state of finances shows a healthy state of the Western's treasury. The invitation to accept of the hospitalities of the Association was neither a "delusion nor a snare." Among the Eastern visitors were noticed Harbison, of Hartford, Conn., looking just as straight and sturdy as though no such a thing as pneumonia had ever existed; Slater, of Providence, R. I., clothed with his usual charming urbanity; Cap. White (cannot name a place of precise abode for him), with that Roman collar unspotted and unsmirched—it was yet early in the proceedings, though; Harry E. Floyd, of New York city, scholarly and prim; L. P. Gerould, of Manchester, N. H., confident and smiling; and J. H. Walker, of Rochester, N. Y., calm, placid and unruffled. There were other Yankees present, and many of them, too; but as they answered to roll-call in the regular way, why, it was their bounden duty to be present. In the name of these gentlemen, and also speaking for ourselves, we cannot too warmly thank our hosts for their gratifying attention, made so heartily manifest on every possible occasion. Truly, did Littleton know whereof he spoke when he promised that those who accepted of the Association's summons to hospitality would find the latchstring in its proper place. The latchstring was there, and the most hospitable of hosts were behind it.

Three sessions were held on the 13th at morning, afternoon and evening; and on the 14th sessions took place at morning and afternoon. The papers read and discussed were the following: "On the Pressure of Gas in the Mains," by Mr. G. A. Hyde, of Cleveland, Ohio; "The Steam-jet Exhauster and Naphthaline," by Ex-president J. B. Howard, of Dubuque, Iowa; "The Proper Location of the Gas Meter," by Mr. J. G. Miller, of Green Bay, Mich.; "Utilization of Waste Heat," by Mr. J. W. Dunbar, of New Albany, Ind.; "Iron Purifying Material," by Mr. E. H. Jenkins, of Columbus, Ga.; "Stoppages in Small Gas Works," by Mr. V. L. Elbert, of Jackson, Mich.; "Success in the Gas Business," by Mr. Wm. E. Lindsley, of Cleveland, Ohio; "Gas Bills vs. Gas Light," by Mr. B. E. Chollar, of Topeka, Kan.; and the "Cooper Coal Liming Process," by Mr. G. S. Page, of New York city. Between time of reading the 6th and 7th papers, at the suggestion of President Lansden, the question-box (which had previously been placed in position) was opened, and the queries taken therefrom were discussed. It may well be imagined that a proper digestion of the papers presented made dalliance or delay impossible; and in order to clear up the decks so that the pro-

gramme might be made in readiness for the banquet, which was to be discussed at 8 p.m., of the 14th, the members adhered closely to their work. In fact it was one continual scene of "hammering right along." Lansden, Littleton, and that spry and really clever "gas man from Columbus"—Emerson McMillin—aided much towards the accomplishment of the "regular order" by their parliamentary tact and skill.

The Association chose as officers for the ensuing year the following-named gentlemen:

President—Mr. James Somerville, Indianapolis, Ind.

First Vice-President—Mr. John Fullagar, Cincinnati, Ohio.

Second Vice-President—Prof. S. H. Douglas, Ann Arbor, Mich.

Secretary and Treasurer—Mr. A. W. Littleton, Quincy, Ills.

Directors—Messrs. E. H. Jenkins, G. A. Hyde, Jr., W. Wallace, S. Prichitt, T. A. Cosgrove, W. H. Odiorne, T. G. Foster, and J. Montgomery.

Before taking leave of this portion of the subject we cannot help once more reverting to Secretary Littleton's faithfulness in his official duties in connection with the Secretaryship of the Western Association; and this persistence is all the more praiseworthy when it is borne in mind that he had been all but prostrated from the weariness attendant upon one who for weeks has been battling with an enemy that threatened the abrupt severance of those domestic ties which man holds most dear to his heart. The verdict of the Western Association, along with our own, is, May Littleton's apprenticeship to trouble soon be but a memory of the past.

At 8 o'clock on the evening of the 14th the members sat down to the enjoyment of a right regal banquet, provided for their entertainment at the instance of the various manufacturing houses, connected with or allied to the gas industry, either doing business directly from, or having agencies in, the city of Chicago. Among the subscribers to the banqueting arrangements, we may, without any invidious appearance, mention the name of the Chicago Gas Light and Coke Company. The main dining room had been in a short space of time transformed into a most charming banqueting hall. The tables were arranged in tasteful parallel rows, with a cross-table at head of the three columns, and at the cross-table were gathered the dignitaries of the feast. The bill of fare was well selected, the viands choice, and the liquids rare. The speeches were sparkling with wit and humor, and President Lansden acquitted himself nobly. Everything went off without a flaw (this applies to the wine, too), and entire success attended the banquet from the time "grace was said" until the assemblage adjourned, with every one sounding the praises of the Local Committee of Arrangements and their co-adjutors, the Manufacturers Committee on Banquet.

On the 15th, which was devoted to sightseeing, a most commendable plan was pursued. Carriages conveyed the members to the Post Office building, where a photographer was in readiness to take a picture of the "gathered clansmen." This done, the occupants of the different carriages gave orders to their drivers to convey them to such points as it was desired to visit. Some went to the different gas works, and others (those who were not well acquainted with the city) preferred to inspect the many gorgeous buildings which grace the Western Gotham. Taken as a whole, it was a most pleasurable and untrammelled way of "doing a sightseeing trip." The 15th of May, with all its pleasures, ending with the hour for train-time home, parting adieus were spoken, and the Eighth Annual Meeting of the Western Gas Association was ready for inscription on the records. It is needless to add that these records will appear as usual in the columns of the JOURNAL.

ALL HAIL TO PRESIDENT NEWMAN.

In our "Market for Gas Securities" in last issue we stated that Mr. R. J. Lackland, of the St. Louis (Mo.) Gas Light Company, had refused to continue negotiations with the representatives of the United Gas Improvement Company, of Philadelphia, who sought to obtain control of the St. Louis Company by purchasing a certain number of shares in that corporation at the figure of \$315 for each fifty-dollar share (St. Louis shares are "half-stock"), and allowing the former holders to divide among themselves a sum of money, equivalent to \$85 per share, due the Company; in other words, the "Imp." Company offered \$400 for each \$50 share. The Philadelphia people either could not or would not (probably the former) stick to their bargain; and now comes the best part of the thing. Mr. Socrates Newman, who (with his friends) is largely interested in the St. Louis Company, said to Mr. Lackland and his friends: "I will give you \$400 a share for your stock." The offer was accepted, the transfer was made, and Mr. Newman was elected to the Presidency; Mr. C. C. Maffit took Mr. G. B. Allen's place as Vice-President; and Mr. Scullin succeeds Judge Madill in the Directorate. This is a triumph for honest management and cheaper gas in the old St. Louis district, as Mr. Newman is a progressive man, and has no intention of keeping up the dog-in-the-manger policy that has so long prevailed in that city. Mr. Geo. S. Page, of New York city, had a "finger in this pie." Our next issue will, if possible, contain an account of the St. Louis affair.

[OFFICIAL REPORT.]

Eighth Annual Meeting of the Western Gas Association.

HELD AT THE TREMONT HOUSE, CHICAGO, ILLS., MAY 13, 14, and 15, 1885.

FIRST DAY—MORNING SESSION—MAY 13.

The Eighth Annual Meeting of the members of the Western Gas Association, in accordance with the call of the Secretary, was held at the Tremont House, Chicago, Ills., on the 13th, 14th, and 15th days of May. The Convention was called to order at 10 o'clock on the morning of May 13th by the President, Mr. Thomas G. Lansden, of St. Louis, Mo. Mr. A. W. Littleton, of Quincy, Ills., occupied the Secretary's desk.

ROLL CALL.

A call of the roll showed the presence of the following members:

Honorary Member.

Joseph R. Thomas, Brooklyn, N. Y.

Active Members.

- | | |
|---------------------------------------|--------------------------------------|
| Agard, W. A., Des Moines, Iowa. | Barret, A. H. Louisville, Ky. |
| Baxter, Jr., A. C., Lima, Ohio. | Belden, C. W., Chicago, Ills. |
| Bellmer, W. E., Carlville, Ohio. | Brown, Edwin Lee, Chicago, Ills. |
| Butman, J. W., Decatur, Ills. | Canby, R. H., Bellefontaine, Ohio. |
| Chollar, Byron E., Topeka, Kansas. | Clarke, Harry E., Kansas City, Mo. |
| Collins, Carroll, Murfreesboro, Tenn. | Cosgrove, Thos. A., Evanston, Ills. |
| Coverdale, R. T., Cincinnati, Ohio. | Cressler, A. D., Fort Wayne, Ind. |
| Daniels, James, St. Louis, Mo. | Davis, Daniel, Iowa City, Iowa. |
| Decker, J. H., Hannibal, Mo. | Dell, John, St. Louis, Mo. |
| Dickey, C. H., Baltimore, Md. | Douglas, S. H., Ann Arbor, Mich. |
| Down, W. H., New York, N. Y. | Dunbar, J. W., New Albany, Ind. |
| Elbert, V. L., Jackson, Mich. | Fullagar, John, Cincinnati, Ohio. |
| Gerould, H. T., Mendota, Ills. | Foster, T. G., Montgomery, Ala. |
| Goodwin, W. W., Philadelphia, Pa. | Gimper, John, Leavenworth, Kansas. |
| Griffin, J. J., Philadelphia, Pa. | Green, James, St. Louis, Mo. |
| Harris, J. A., Philadelphia, Pa. | Harris, G. S., Mansfield, Ohio. |
| Hauk, Chas. D., Springfield, Ohio. | Haselmeyer, A., Springfield, Ills. |
| Hicks, Geo. C., Chicago, Ills. | Henning, D., Chicago, Ills. |
| Howard, J. B., Dubuque, Iowa. | Howard, E. T., St. Louis, Mo. |
| Humphrey, R. C., Ashtabula, Ohio. | Howden, J. J., Muskegon, Mich. |
| Hyde, Jr., G. A., East Saginaw, Mich. | Hyde, G. A., Cleveland, Ohio. |
| Keller, C. M., Columbus, Ind. | Jones, N. W., Chicago, Ills. |
| King, E. J., Jacksonville, Ills. | Kennedy, J. M., Rockford, Ills. |
| Lansden, T. G., St. Louis, Mo. | Knight, C. S., Fort Wayne, Ind. |
| Lindsley, Edward, Cleveland, Ohio. | Light, Joseph, Dayton, Ohio. |
| McDonald, W., Albany, N. Y. | Littleton, Aug. W., Quincy, Ills. |
| McMillin, E., Columbus, Ohio. | Mellhenny, John, Philadelphia, Pa. |
| Mitchell, J. K., Galesburg, Ills. | Miller, J. G., Green Bay, Wis. |
| Moran, Michael, Joliet, Ills. | Montgomery, James, Sedalia, Mo. |
| Morse, E. W., Fort Scott, Kansas. | Morgans, W. H., Pontiac, Mich. |
| Nash, C. H., St. Joseph, Mo. | Murdock, G. T., Elkhart, Ind. |
| Page, Geo. S., New York, N. Y. | Odiome, W. H., Springfield, Ills. |
| Pratt, Henry, Chicago, Ills. | Perkins, B. W., South Bend, Ind. |
| Printz, Eugene, Zanesville, Ohio. | Prentice, Allen T., Chicago, Ills. |
| Ramsdell, G. G., Vincennes, Ind. | Pritchitt, Samuel, Nashville, Tenn. |
| Ritchie, W. C., St. Louis, Mo. | Raynor, C. H., Adrian, Mich. |
| Runner, Z. T. F., Freeport, Ills. | Roots, D. T., Connersville, Ind. |
| Russell, T. G., St. Louis, Mo. | Russell, D. R., St. Louis, Mo. |
| Smedberg, J. R., Lancaster, Pa. | Scofield, L. K., Fort Scott, Kansas. |
| Somerville, Jas., Indianapolis, Ind. | Smith, Thos., Grand Rapids, Mich. |
| Stacey, Wm., Cincinnati, Ohio. | Spencer, R., Burlington, Iowa. |
| Starr, J. M., Richmond, Ind. | Stanberry, F. H., Pekin, Ills. |
| Taylor, Geo. H., Warren, Ohio. | Stout, John, Chicago, Ills. |
| Twining, E. H. B., Chicago, Ills. | Thompson, M. H., Elgin, Ills. |
| Wallace, Wm., Lafayette, Ind. | Walker, J. H., St. Louis, Mo. |
| Woodmanseo, J. H., Danville, Ills. | Wirt, R. D., Independence, Mo. |

READING OF MINUTES.

A report of proceedings of Seventh Annual Meeting having been published in the AMERICAN GAS LIGHT JOURNAL, a motion to dispense with a reading of same was agreed to.

PRESIDENT'S ADDRESS.

President Lansden then delivered the following inaugural address:

Gentlemen of the Western Gas Association:

Since it is customary for your presiding officer to present an address at the opening of each annual meeting, embracing matters of interest to our profession, I shall not feel I am taking advantage of my position if I here say I shall endeavor to take up as little time as respect for that position will admit of.

Knowing the number of papers that have been prepared for this occasion, I feel it is due to the best interests of the Association that as much time as it

is possible to allot shall be devoted to their hearing, with an after discussion of the many points of practical experience contained therein.

I here ask that when a paper has been read that these who may take part in discussing it will endeavor to keep as near to the lines of the subject treated of as possible. There are so many different matters brought out in our discussions that we are sometimes apt to attempt to follow along in the one debate the process of manufacture from the ashpan to the station meter. By thus concisely disposing of each paper as it is read, our proceedings will be rendered more systematic, and, therefore, become mere profitable to us. If questions should suggest themselves to members, during the discussion of papers, that they would like to ask, but which would be calculated to lead to matter that is not really under discussion at the particular time, I would suggest the gentlemen make a note of them, and then drop them into the question-box, where at the proper time they will receive due attention. Our question-box can be opened between the reading of papers, when much valuable information may be brought out.

I see from the number present that the interest heretofore manifested in our Association has not abated; but that, on the contrary, many of you have come together to compare notes, and talk coolly over our past successes and failures, as also, possibly, to attempt a glimpse at the future.

As a consequence of the varying circumstances surrounding us individually as gas makers, it is natural we should have results that will show wide of uniformity. If we find in our experience of the last year we have obtained results more favorable, or have made failures in our experiments, it will be your duty to make known here "their footprints, that perhaps another, seeing, may take heart again."

I desire especially that those who have charge of the smaller works will not be backward in giving to the Association what results they have obtained within the twelvemonth. It is generally in the small works that we have the best opportunity of gaining that which comprises the best and whole knowledge of our profession—from the coal to the meter. Do not think, because you have charge of works containing but one bench (and it may be a setting of threes at that), that you cannot say anything to interest your fellow members of this society.

I would not exchange one month's practical experience for fifty years of delving into the science of gas manufacturing. Science sometimes shortens the route; sometimes it does not. I say, gentlemen, that each one of us must work out his own salvation; and how often it is done with "fear and trembling."

I once heard the president of a small company say, "I think your gas associations are all a humbug, after reading the proceedings of one of your meetings. I found no two of you could agree on anything. Every one had different results." I immediately undertook to show him, from the difference in our surroundings, the great variety of coals, lime, size of plant, amount of gas made, price of coke, tar, and other residuals, that he did not know what he was talking about. The "talk" came out because I was trying to persuade him to send his superintendent to our meetings. I am sorry to say he is not here. This superintendent had also said to me that the published proceedings of the gas associations as they have appeared in the AMERICAN GAS LIGHT JOURNAL, had been a great benefit to him. He reads the JOURNAL regularly, and pays for it himself. I think it would be money well spent by gas companies if they would see that their superintendents were supplied with well-bound copies of the proceedings of the meetings of the various gas associations of the United States.

In consequence of the variety of our surroundings these societies were established that we might come together and find out what each one was doing. Through the acquaintanceship formed here we can correspond with one another, and feel certain that our letters will be answered.

I maintain the formation of these societies has done more to reduce the price of gas than any other single cause. I must congratulate you all that the interests allied to our profession are still holding their own, and can say this, while almost all other sorts of business have shown most sensibly the effects of stringent times. With some few gas companies I understand there has been a decrease in consumption, but only to a limited extent.

With all of those who are devoting their best energies to place our profession where it may properly be understood by those with whom we have to deal, I must say it is not all sunshine. We hear it insinuated that we are not altogether what we should be. Even such gentle epithets as "robbers," "thieves," "swindlers," "soulless monopolists," etc., have been applied to the managers of some of the companies we represent. Think of it; we who toil to give others light—for a small consideration. Could the downtrodden gas consumer be brought to realize the blessing this wonderful discovery has been to mankind, such of them as may have any conscience left would stand abashed. Bartholdies would spring up in every city and village; and strife would be among the people for the privilege of paying for pedestals. It would be "Liberty (gas) lighting the world."

There must be some cause for the condition of public opinion in regard to our particular profession. Shall we not endeavor to find out the cause, and

strive to have it removed? There is no other article that comes into such general use about which there is so little known by the average citizen.

The only medium through which we may reach the people (except the gas bill) is the public press. But what has the public press done toward giving reliable information to the people in regard to illumination by gas? It will tell of the iron interests; note the state of the lumber trade; speak intelligently and accurately about the produce market; blazon forth the price of hops; and it will even speak of feathers—not because they are “light,” but simply because they represent an article of trade. What they say of us is usually done in a flippant way—more in derision than in an honest attempt to educate the people.

I do not accuse the newspapers of wilfully misrepresenting us; but I do accuse them of allowing matter to appear in their columns, ninety-nine per cent. of which is written by men who do not understand the first principles of gas making. As a sample, this came under my eye a few days ago:

“*The Thieving Meter.*—Out of 523 Chicago gas meters tested by an expert 518 registered fast, and the company knew it. This, however, is not enough to injure the reputation of a gas company.”

Now, I leave it to you, gentlemen, if the writer of that paragraph could ever have seen and understood the mechanical construction of a meter, and then wrote that article. Should not a hatchet be erected over the grave of Annanias, and the champion belt be passed over to this newspaper scribe?

The gas meter, which has been the source of so much derision, stands today as one of the most beautiful pieces of machinery that ever traced its emanation to the brain of man. How strange that it is but a few short years since it has commenced to bring odium upon gas companies. For fifty years it never had been accused of lying; and now, when mechanical science is at its zenith, it has ceased to tell the truth! What would the average consumer think if I should say that a million dollars is ready for the man who can furnish a more reliable and correct gas measurer? No, it is not the meter; and you may think it strange when I say it is only since our gas companies have been making such large reductions in the price of gas that this outcry against the meter has been heard—that silent arbitrator that tells of the particular habits of home life. One meter says, “The woman who presides over this household is a treasure to her husband and family.” Another one proclaims, “This is a go-as-you-please establishment; the servants and the children run this house.” What is it that the meter does not tell of character in controlling a household? Mrs. Smith says, “My neighbor, Mrs. Jones, has a larger house and she has more burners than will be found in mine; yet her gas bill is not more than half as large as is the case with me.” Now, I wanted to tell Mrs. Smith the reason; but I did not dare to. The simple reason was, Mrs. Smith had been brought up in one of the go-as-you-please establishments.

Right here let me say, I must differ with some in regard to the method adopted when the meter statements are taken. Many of the larger companies do not allow the men who take the statements to carry with them the former registration. I think, as they are the only persons who come in contact with the consumers, they ought to be men of such intelligence that they should be required to make out the bill at the house and leave it with the consumer. Here is the result of the other method. Once I happened to be passing along a particular street when a meter taker happened to be leaving a house just as “Bridget” was engaged in scrubbing down the stoop steps, and so I overheard the following dialogue: Said Bridget, “How much is the gas bill this month?” Response: “I cannot tell you; you must call at the office.” Said Bridget: “Sure you can guess at it here as well as at the office.” When an inspector gives such an answer the consumer is puzzled. They know quite well if there is anything about the meter calculated to tell how much gas they have consumed the inspector knows it; and why he should say “he cannot tell” is more than they can understand. Then, as the papers so often say, “it is all guess-work,” and the consumers are ready to believe the assertion.

In consequence of the reduction of the price of gas in a city the average consumer makes up his mind that his bills are going to be reduced in proportion; and as it is so convenient to have more light, he immediately educates himself and family to the use of more gas. By the time his first bill, under the reduced rate, comes around he has consumed probably double the amount formerly used under the old price. What is the consequence? He blames it on the meter, curses the gas company, and refuses to be comforted.

When I said to a gentleman, a short time ago, I send out to a majority of our residence consumers more gas on the mornings of December, January and February than I do to the same consumers in the evenings of June, July and August, he could not believe it at first; but finally he admitted that even in his own house he consumed more gas on winter mornings than during summer evenings.

A lady once said to me, “Mr. Lansden, will you tell me why my gas bills are as large, if not larger, than before the price was reduced? I have the same house, and same servants; and, in fact, everything as it was before.”

(The gas rate had been reduced in that district from \$2.50 to \$1.50.) I asked her if she had taken the same interest in looking after the gas as she had done when the price was \$2.50 per thousand. She said, “Well, I supposed my bills would be much less in consequence of the reduction. I really have not paid any attention to it.” I told her the old story: “If you expect to reap the benefit of a reduction through smaller gas bills you must pay the same attention that you gave to the matter before the reduced rate went into effect.”

As it appears in the nature of an impossibility to make the public feel that our interests are mutual, I heartily concur in the idea that is being advanced in some of the States—that of having a State Gas Commission, similar in nature to those at present having charge of the railroads. This is, in my opinion, the only way the problem will ever be solved. The time has gone by when gas companies should expect to realize more than ten per cent. on their capital. I think a large majority of them would now welcome any movement which would tend to place their capital in a safe position. Any one who will take the trouble to go over what has been done in Europe will see that this was there the last resort; and the method has come quite near to effecting a solution of the problem.

I hope time will be had during this meeting when the subject may be brought up and thoroughly discussed. I feel confident that a majority of gas companies would do all in their power to assist in the movement for a State Commission.

I am glad to see that there has been a movement in the way of forming State Associations in the West. I know we are all glad to welcome the Ohio and Iowa State Associations formed within the last year. You all have seen from the published proceedings of the first-named that it starts out in the right way. I think it will be well for those of us in other States to follow in their footsteps. Matters of mere local interest can then be brought out, and which could not be properly attended to in our larger Associations.

It becomes my painful duty to notify you that death has made its first claim from among us since our organization. It has taken one whom we all loved and respected. His genial face will no more gladden our hearts as in days gone by. Mr. Thomas Butterworth was the second President of our Association; no one took a greater interest in its success, while in its younger life, than he, and to him is due much of the interest that is now being manifested in its more mature years. When such men are called from among us we sorely feel the blow. Let us all try to be governed by the same sturdy principle—that of justice to all—manifested by him throughout his life. I would suggest that a committee be appointed to draw up appropriate resolutions, a copy of which should be sent to his family, and another be placed upon the records of our Association.

I also bring to your notice the death of one of our associate members—Mr. George Downing. I would suggest that a committee be appointed to bring before the Association such resolutions as may be appropriate to the memory of our deceased brother.

Thanking you for your kind attention, I announce that the regular order of business will be proceeded with.

COMMITTEE ON PRESIDENT'S ADDRESS.

Mr. McMillin moved that the Secretary appoint a committee of three, with instructions to consider Chairman Lansden's address, and to report back their conclusions thereon to the Association at its afternoon session. The motion being agreed to, Secretary Littleton appointed Messrs. E. McMillin, Columbus, Ohio; S. H. Douglas, Ann Arbor, Mich.; and R. H. Canby, Bellefontaine, Ohio, as such committee.

NEW MEMBERS.

On motion Messrs. James Somerville, Indianapolis, Ind., John Gimper, Leavenworth, Kansas, and E. J. King, Jacksonville, Ills., were appointed as a committee to receive and report upon applications for membership. The committee subsequently made a favorable report upon the applications of the following-named gentlemen:

Allison, J. W., Jackson, Tenn.	Bradley, C. D., Chicago, Ills.
Brown, F. G., Madison, Wis.	Bogue, O. A., Hyde Park, Ills.
Blinks, W., Michigan City, Ind.	Baxter, I. C., Evansville, Ind.
Bixby, W. A., Galena, Ills.	Butterworth, W. C., Rockford, Ills.
Cowdery, E. G., Milwaukee, Wis.	Critchlow, J. M., Beaver Falls, Pa.
Clark, Walton, New Orleans, La.	Connelly, T. E., Pittsburgh, Pa.
Egan, James, Galva, Ills.	Faben, C. R., Jr., Toledo, Ohio.
Jenkins, E. H., Columbus, Ga.	Kellogg, L. L., Sioux City, Iowa.
Levings, W. H., Paris, Ills.	McKnight, G. F., Chicago, Ills.
Mayer, J. F., Baltimore, Md.	Murphy, J. M., Nebraska City, Neb.
McMillin, G., LaCrosse, Wis.	McClary, N. A., Chicago, Ills.
Parlin, W. H., Canton, Ills.	Persons, F. R., Chicago, Ills.
Scobey, T. E., Cincinnati, Ohio.	Stannard, A. B., Philadelphia, Pa.
Snow, G. B., Buffalo, N. Y.	Starkweather, G. F., Chicago, Ills.
Tarvin, R. J., Cincinnati, Ohio.	Thompson, J. D., St. Louis, Mo.

Woodmansee, R., Davenport, Iowa. Worcester, E., Chicago, Ills.
Williams, C. W., Terre Haute, Ind. Wells, E. D., Atchison, Kansas.
Wolverton, Chas., South Bend, Ind. Webster, W. M., Chicago, Ills.

Upon motion, the Secretary cast the ballot of the Association for the applicants named in committee's report, and they were declared to be duly elected to the privileges and duties of membership. The newly elected members were thereupon formally introduced.

COMMITTEE ON OBITUARY RESOLUTIONS.

On motion, Messrs. J. B. Howard, Dubuque, Iowa; Jos. R. Thomas, Brooklyn, N. Y.; and G. G. Ramsdell, Vincennes, Ind., were appointed to draft and present resolutions of regret and condolence in regard to death of Mr. Thomas Butterworth, of Rockford, Ills.; Messrs. E. H. Jenkins, Columbus, Ga.; T. A. Cosgrove, Evanston, Ills.; and J. M. Starr, Richmond, Ind., receiving instructions to perform a like service to the memory of Mr. G. E. Downing, of New York city.

WELCOMING THE VISITORS.

The following-named gentlemen were formally introduced to the Association as heartily welcomed guests. They were invited to seats in the Convention, and the most courteous and hospitable attentions were paid to them during the time of the sessions.

H. E. Floyd, New York city. L. P. Gerould, Manchester, N. H.
J. P. Harbison, Hartford, Conn. A. B. Slater, Providence, R. I.
Capt. W. H. White, New York city. J. H. Walker, Rochester, N. Y.

As the introductions were proceeded with each of the guests responded appropriately to the generous greeting extended, Mr. Harbison, Mr. Slater, and Capt. White, as usual, excelling in the neatness of their acknowledgements.

COMMITTEE ON NOMINATION OF OFFICERS.

A discussion hereupon arose as to the best manner to be pursued in electing officers for ensuing year. Owing to the way in which the matter had been spoken of at the sessions of '84, President Lansden refused to take upon himself the duty of selecting a nominating committee. The question was finally disposed of (on motion made by Mr. Starr), by having a nominating committee of five selected at the suggestion of individual members in open session. This plan resulted in the choice of Messrs. J. B. Howard, Dubuque, Iowa; J. M. Starr, Richmond, Ind.; S. H. Douglas, Ann Arbor, Mich.; T. A. Cosgrove, Evanston, Ills.; and T. G. Foster, Montgomery, Ala.

President Lansden—Having disposed of pressing routine business, the next regular order is the reading of papers.

[To be continued.]

[OFFICIAL REPORT.—Concluded from page 262.]

Papers Read before the First Annual Meeting of the Ohio Gas Light Association, with Discussions on Same.

FIRST DAY.—EVENING SESSION.

When discussion on Mr. Taylor's paper* had been brought to a conclusion the Secretary read a paper by Mr. Hawley, of Albany, N. Y., on the subject of "The Bunsen System of Burning Gas as a Fuel." [This paper, being a voluntary contribution, was not forwarded us by Secretary Butterworth.]

To the President (General Hickenlooper) had been assigned the task of preparing a paper to the question of—

"WHAT IS THE LOSS IN WEIGHT OF COAL FROM A STORAGE OF SIX MONTHS, OR THE DIFFERENCE BETWEEN WEIGHTS OF COAL WHEN PUT INTO COAL HOUSE AND WEIGHTS CHARGED INTO RETORTS?"

The General explained that he had not had sufficient opportunity to prepare a properly arranged paper on the subject, but would verbally and briefly relate the result of an experiment (and bearing upon the topic) made at the Cincinnati works some time since. The speaker then proceeded:

A certain number of pounds of coal were put into a box open at top, with lattice-work sides, and placed on a loft over a stack of benches; an equal weight of coal was placed in an open shed in yard; while a third coal portion was filled into a box similar to one above described and placed in convenient situation on top of tank wall of one of the holders. After a year had elapsed the coal was reweighed. That near the stack had lost 11 per cent.; that in the shed had decreased 10 per cent.; and the third lot (the one which had been placed on coping of tank wall), greatly to the surprise of the gentleman who had charge of the experiment, showed a loss of only 1.74 per cent. The last result might, in great part, be attributed to the fact that, just previous to the reweighing, there had been a heavy rain storm, although there was no extraneous appearance of moisture about the coal. A fourth coal portion, taken from a coal "wall" on river bank, where it had been exposed to action of elements for about three years, showed a loss of 13 per cent. It ap-

peared rather odd that of the three first mentioned lots the one on tank wall, or in most exposed situation, should develop the least percentage of loss, yet such was the fact. Of course there must have been somewhat contradictory conditions at work, since the river-bank specimen had lost 13 per cent. The three portions were of an identical grade—second pool Youghiogheny—taken from one and the same mine.

Discussion.

Mr. McMillin—These are very interesting figures, and it would require some thought to get at an idea of what caused the loss. It is important, since the best result we can get from Youghiogheny coal is a 25 per cent. yield in gas.

President Hickenlooper—I will call attention to the fact that we also tried experiments on samples of coal that were in our yards for 10 or 12 years, in comparison with new coal, and there was very little difference in the yield between the old and the freshly mined.

Mr. Huntington—Then it is your opinion that the shrinkage is not all due to loss of gas?

Mr. Hickenlooper—It cannot be.

Mr. McMillin—I do not see how it is possible for any of the ash, or solid carbon, to get away! The only other cause for shrinkage, then, is moisture evaporation, and Youghiogheny coal usually shows only about one per cent. of contained moisture. Youghiogheny coal, though, does contain 7½ per cent. of oxygen, and, of course, that does not count for anything when you come to make gas.

Mr. Huntington—Would not that oxygen, from its passing away, rather tend to increase the nominal value of a coal for gas making purposes, through increasing the percentage of gas produced from a given weight?

Mr. Printz—Could we not partly account for the loss by remembering that 100 pounds of freshly-mined coal would have a greater bulk than the same weight of the old material?

President Hickenlooper—Of course, if you take coal by the pound, a bushel of the lighter sort would not yield as much gas as that given off from a bushel of the heavier kind; or it would take a greater number of bushels of the old coal to produce a certain yield of gas than would be the case with the new—although the same result might not follow were the quantity figured in pounds.

Mr. Fullagar—Some years ago I had an idea of spreading the coal out over the floor of the retort house, with a view of drying out all the moisture. I think, should we do that, and the practice would extract all vapor, we would save the money we are now spending in driving out the contained moisture during the process of carbonization.

Mr. McMillin—President Hickenlooper tells us that the difference in the yield per pound of coal between coal that had been stored 10 or 12 years and coal that was newly mined was but very slight. Now, we must not infer from this that we will sustain no loss by storing coal through long periods. The loss occurs from having 10 or 12 per cent. less pounds weight of coal from which to make gas when we come to carbonize the coal after its long retirement underneath our storage sheds.

SECOND DAY.—MORNING SESSION.—FEB. 19.

The last paper on regular list was presented by Mr. J. Anderson, of Iron-
ton, Ohio. The communication was presented in response to the question:

"HOW CAN THE FORM OF THE RETORT, OR THE MANNER OF SETTING THE SAME, BE IMPROVED?"

Upon being formally introduced, the author read as follows:

Mr. President and Gentlemen:—The request to read a paper before you only reached me a few days past, and when at quite a distance from home. Now, as I returned to Iron-
ton on Feb. 16th, I have had very little time to prepare it; and, besides, I feel as if others of you could have "filled the bill" with more ability, as, given sufficient time and study, much of interest could be said on the subject of "The best form of retorts and their settings"—since from the first discovery of coal gas they have been the most useful agents in its production. I therefore ask of you allowance for my shortcomings.

In 1792 Mr. Murdock, a Scotch engineer, then in the South of England, discovered the availability of coal gas for illuminating. He made many experiments during a number of years, and finally brought his ideas into practical use. In 1797 he lighted his premises in Old Cumnock, Scotland, and in 1798, again in 1802, he illuminated the great Soho Iron Works, in Birmingham, at times of public rejoicing. These were the first attempts at public displays of the use of gas of which there is any positive record, and were at the time, I expect, wonderful and attractive.

The first holder used was a simple bladder—as Murdock carried the gas in bladders to light his path home from his works during the winter evenings.

The first gas retorts of which we have any knowledge were shaped like a coffee pot; the charges were small, about 15 pounds of coal, and as the vessels were filled and emptied through a mouth at the top, it was a trouble-

* See JOURNAL, issue May 16, pp. 261-2.

some task, more especially considering the numerous operations required in the handling of such small quantities. Through a long number of years there were various changes in the forms and sizes of retorts, as also in the manner of setting them. Among these some had turn-tables in them, while others had trays on endless chains. The charging material was broke up as small as nut coal and thinly spread; but I deem it unnecessary to take up your time in further remarks on iron retorts, as their history is now a thing of the past.

The advent of fire-clay retorts may be said to have come in with Grafton, who patented his make in 1820. It is true their manufacture had been tried previously in some such manner as at present made; but as I presume the manufacturers did not understand the manipulation of clay at that time, or at least to such degree as it is comprehended now, their tendency to crack threw them out of the market, and caused the adoption of Grafton's, which were built of flanged tiles. Some of these were of large capacity, taking charges of from 500 to 1,500 pounds, with only one retort in an oven, and carbonization was completed in from four to five hours. These large and thick retorts were not profitable, however (although they lasted from four to six years), for they required comparatively immense fires, consuming 70 per cent. of the coke.

Subsequently the ordinary clay retorts were made in sections, two or three lengths in a retort, and at some works in Europe these are continued to the present day; indeed, there still are some built of brick. In this country clay retorts are made in one piece, with the exception of through retorts, which are made in two or three sections.

The question of the best size of retorts for service is an important one, and there is a limit, of course, to all things. I think there is no doubt the larger ones are the more profitable, as the difference in cost is trifling over that of the smaller sizes. They have greater capacity; their charges can be more conveniently increased or diminished as required; and their heating costs not as much in proportion to their work. The disposition of practical gas engineers and superintendents generally inclines to an increase in the size of retorts; and most if not all the ovens now going up are of dimensions fit for the reception of the largest sizes in use. Of course, where ovens already built are small, the benches must be suited to them; but in many of these, by a change of setting, larger retorts could be used; sometimes an additional retort may be set, and changes in three or four benches would materially improve the situation, and probably economize to the extent of one fire.

There are several forms of retorts in use; of these the round, the elliptical or oval, the arch or , and the combined arch and oval are the most general shapes.

The round retort is considered the strongest, as least susceptible to changes of temperature; but its form is objectionable because of its greater height in proportion to its capacity, and the impracticability of spreading the coal in it.

The oval retort comes next to the round in its unsusceptibility to changes of temperature. The charge can be spread more evenly, and, as we know, these retorts give good satisfaction in the Pittsburgh, the Laeade, the St. Louis, and both stations of the Cincinnati works—especially so in the latter, where there are 224 through and 640 single retorts set, and which are worked with the highest heats obtainable. After several years of experience they are preferred to the -shape.

A question comes in here—May not the movement in the charge during carbonization affect the retort? The charge first becomes partially solute before caking. As it softens in its early stage it settles down; then as it hardens into coke it swells, and, especially in heavy charges, sometimes resorted to, the expansion may press more on the arching sides of the retorts than we know of. The oval retort would not be quite as liable to be affected by this movement, as the coal does not usually fill up level with the center. As it widens out to the center, there is space for expansion of the charge without impinging on any part of the retort; while in the -shape the sides contract on or immediately over the coke.

The arch or  retort is the most general shape in use; and probably may so continue, from the fact of its greater capacity for a well-spread charge. Of these, for example, I consider a 15" x 23" stronger than a 14" x 22"; or a 15" or 16" x 26" stronger than a 14" x 26". The form gives a stronger arch, and they are preferable for use excepting where their height, as in benches of sixes, would make them inconvenient to work.

As for the combined arch and oval retort, I cannot see proper compensation in them for their diminished capacity.

There was a retort patented by a Mr. Scott, of Musselburgh, about ten years ago, built like a cupola, of a capacity of 1,500 pounds, charged through a hopper at top, and drawn by the movement of a grate at the bottom, resting in what may be termed a basin, which sealed the grate; but its working has not been satisfactory. There may be a day when gas will be generated in cupolas, or the like, of large dimensions; but efforts experimenting in that direction have been few as far as heard from.

There is also the Davidson retort, of peculiar shape, and covered by patent. I cannot say if it is equal to what the patentee claims for it, as my information is solely gained from his circular, which I have no reason to doubt.

The plans of settings are quite numerous. Through retorts in large gas works are the most economical. They have greater capacity for the space occupied in a range; require comparatively less fuel in heating; are kept free from carbou by opening both ends when changing charges; and have less change of temperature, through changing fires at only one end at a time.

All large gas works should have benches of six (or more) retorts, especially those having long ranges of benches, where the steam stoker could be applied to advantage. In benches of six (or more) retorts, especially with generative or regenerative furnaces, the bridge-wall setting is very good. A strong draught is required by this setting; but with ordinary fire boxes, I believe, while higher heats, better distributed, may be attained, not only is there an intense heat drawn up the face of the bridge-wall, and damaging to the sides of the retorts nearest, but the same parts are exposed to the sudden changes of temperature from the open door when firing and clinking.

The late Mr. Sabbaton, of New York city, to whom American gas men owe much, and whom all should hold dear in memory as a benefactor of gas interests, has left us great improvements in settings, suitable to nearly all sorts of benches; and his plans, with some modifications by the several manufacturers, are the most general in use. Through the competition rife between manufacturers, however, the settings have been scaled down in quantity as well as in price; and the tiles and blocks are so light and narrow that at the present time the retorts have not proper support or protection in many instances. And, I must say, there is a disposition among gas men to give encouragement to this practice, to their own detriment; and if, instead of bargaining by bulk at so much per bench, they would buy by the piece and per weight, relying on and seeing that the manufacturer gives just all that is necessary, they would be better served. For a good setting a fair price can be afforded with gain.

I do not think it prudent to build sixes in small works, where good stokers are not always available. Benches of fives are more easily managed; for if any retorts are slighted by the stoker they are the top ones of sixes—the top retort in fives is not so high. In some places, where it is difficult to secure good stokers, it might be best to follow the old style of setting fives—with three in line and two on top; but with good stokers, setting up a bench with retorts two and two abreast, and one on top, is preferable, as more economical to set and work, besides occupying less space.

There is no doubt that the more retorts that can be conveniently worked in a bench, over one fire, the less the cost of manufacturing; and no works of any magnitude should run small benches, as the remodeling of the retort house, with entirely new benches, would repay the cost in a few months' operation of the works.

[Mr. George Anderson, of England, adds a supplementary bench of threes to his sevens, which he heats from the same fire.]

It would be difficult, I venture to say, to find a man of practical experience in working large benches, to attempt to controvert this, or any but a crank to gainsay it.

Furnaces for benches should be ample in proportion to the size of the oven. A 12" x 42" x 22" fire-box would suffice for an oven 6' 6" x 9', with threes; while a furnace of 15" to 16" x 54" x 27" would be necessary for an oven 7' 6" x 9', with sixes. The plain furnace is best suited to small works; and I think that where furnaces cannot be had to stand out the life of the benches, it is well to build them of hard-burned, pressed furnace blocks, say 6" wide, and put in after the plan called by masons as "stretchers," not as "headers," two in a course, so that those next the fire, as burned and broken out, may be removed and fresh blocks set in. Furnaces should be set well below the bench, and not up between the two lower retorts; and too much space should not be lost between the grate bars and ashpans. In many places that I have visited the fires stand too high from the ashpan, receiving too much air and deriving no benefit from the water in the pan underneath.

In a works of even moderate, as well as in those of large size, where the manufacture warrants a double-stage retort house and regenerative furnaces, it pays to have them. These furnaces may be built under or in the rear of the benches, or even, where pits may be formed under the level of the floor, they can be built under old works. A depth of seven feet below the bottom retorts is ample space for some of these furnaces. They are the most economical, give greater and more regular heat with less fuel, and require less attention than ordinary fires; and besides the cost of construction is not so great an item as to be objectionable where they may be made available.

Discussion.

Mr. Fullagar—Mr. Anderson seems to advocate benches of fives—with two retorts on top. In the first place this setting requires an arch of fire brick over the furnace. How long will the middle retort last?

Mr. Anderson—It will last as long as the others if properly set.

Mr. Fullagar—We at one time had an old English setting of that sort, and the middle retort had to be supported by a slab of the heavy Zanesville stone. That middle retort never lasted over six mouths. I think the Mobile and New Orleans works are the only ones in this country employing that setting.

Mr. Anderson—Mr. Fullagar should remember that I recommended the use of those benches only in certain cases. I say I do not think it prudent to build these in small works where good stokers are not always available. I would say to Mr. Fullagar that I think I could put in a bench of that description so that the middle retort would not burn out any sooner than the others. In some places in England—it may be the case here—they build an arch out of what they call crown brick, and then tile on top of it. The heat cannot injure the middle retort much more than it does any of the others. It is the strength and thickness of the arch that gives protection from the heat.

Mr. Fullagar—The difference in height between that and the old setting is only 9 inches. I do not see why a stoker should mind that.

President Hickenlooper—Do you mean that the arch is continuous, or are small arches thrown over every 8 or 10 inches?

Mr. Anderson—It is continuous.

Mr. Coverdale—I rise simply to make the suggestion that this discussion as to the setting of retorts should be made as thorough as is possible. If gas companies are going to remodel their works in the attempt to reduce the cost of manufacture, in order that they may reduce selling prices to consumers, we must begin by solving this question. We must commence at the retort. We desire and expect to receive the benefit of the experience of those companies who have spent a good deal of money in this matter; and get that knowledge, too, without having it cost us anything. We want to start where they left off. I would like to say, also, that the papers read at this meeting have been most interesting. They show that our members are pretty well up in their business.

President Hickenlooper remarked that it was difficult to explain one's views about bench settings without drawings to illustrate the oral description; but asked Mr. McMillin to attempt it.

Mr. McMillin—I think we have made some progress at Columbus in the manner of setting retorts, and building furnaces; but, as our President remarked, it would be very difficult to explain what we have done without drawings. We employ several forms of furnace. We have four benches of sixes set on about the Cincinnati plan. On first starting them up we used perhaps 33 per cent. of the coke made; but we had been using 50 per cent. in the old settings they replaced. As our men got accustomed to handle the furnace, they soon brought the coke feed down to 25 per cent., and while we are now using just one-half the quantity of coke that we used before, we have also increased our output. These four benches are really making as much gas as any other six of the old style. The longer we run these—the "Cincinnati" furnaces, as we call them—the better we like them. We will build four more of them this summer; or rather we will put Cincinnati furnaces under all of the benches in that section. This winter we constructed eight benches in an old building where we had no basement. We went down so as to get a furnace about 3½ feet deep; and that was as low as we could get. I do not know what sort of furnace we could call it, for I never saw anything like it elsewhere. All its parts have been used before in some other furnace; but, owing to the condition of affairs at Columbus, we had to combine a good many things. It is not only a gas furnace but it is also a regenerative furnace that heats the air by waste gases and evaporates water by the waste gases passing through fine under ashpan. The saving, so far, has not been so great as that gained with the "Cincinnati" furnace, although finally I think it may be even greater. We have only run them since Christmas time. When our men have been handling them as long as the others this furnace ought to take up even less fuel. I must say, though, that we have not got the depth in them that we ought to have. In the construction of this furnace we tore out the retorts and went right down below the earth at bottom of the old foundation. The bottom of the ashpan was down on a level with the earth, and the escape flue still below that again. The grate bars were placed only a few inches (perhaps six) above the top of the ashpan, allowing just enough space to get a shovel in. The gases, as they pass up, are made to travel back and forward several times, and finally reach back to the end of the setting, then coming forward under the ashpan, evaporating water and sending steam into the furnace. The air for secondary combustion is heated by passing through several inch and a-half gas pipes. In every alternate course of brick is laid one of these pipes, extending from within 9" of the front wall to within about 2' of the back wall. The back end opens into a chamber 2×4 feet, and 2 or 3 feet deep. The cold air is admitted through a little sliding door. That is opened so as to give a space of about ½ to 2½ inches for secondary combustion. In the large chamber it is subjected to a great deal of heat before it rises, and travels forward through small holes over the coke in furnace and combines with the gases for second-

ary combustion. To look through the furnace when in operation you would think there was a high illuminating gas going right out of those lateral openings; but there is no gas in these holes, for we see only the gases from the furnace which burn with a blue flame outside and with the intensity of a white flame inside. We might and do carbonize almost any quantity of coal that can be put into the retorts. We have no occasion to use a clinker-bar; and that is the biggest gain in any of these furnaces. The ashes are shoveled out; there is no need of drawing grate bars at all. With the "Cincinnati" furnace we are running very high heats in our retorts. We can melt pig iron if necessary; and yet in the producer part of these furnaces the clay joints are apparently as perfect as they were the day we fired our benches. They are hardly red-hot. I expect to burn out a dozen settings without ever renewing the furnaces proper. My old experience was that the furnace would "let down" first. They would not have been running three months when you could bury a beer keg in the furnace walls. The heat would melt brick walls right down. When you find you can crowd these benches as much as you want to, without letting down the heat, you often find you can run with one bench where, under the old system, you would have been obliged to use two or three. It does not seem to make much difference what quantity of coal you put in them. You can heat them just as hot as you like. I had expected Mr. Anderson would tell us, not only how retorts are made and what the best forms were, but also how to make entirely different settings. I am not fully satisfied with the present arrangements. I would like to see coal put in by the ton and never touched from the time it is put into the retort until it is turned over to the consumer, either in the shape of gas or coke.

Mr. Anderson—I suggested that probably the day may come when cupolas will be used instead of retorts; but that is hardly for the present. I would like to ask Mr. McMillin if he uses steam under his fires, or whether he relies only on water in his ashpan?

Mr. McMillin—We use steam under the "Cincinnati" furnaces. They do not evaporate any water. The other furnaces do not evaporate as much water as I want to pass into them; but the sending in of steam is not essential. Mr. Enfield is managing that part of the works and has given it more attention than I have.

Mr. Enfield—I do not know that I have thought very much over this matter of the manner of settings; but one point in Mr. Anderson's paper attracted my particular attention. He thought in many instances the retorts were not getting sufficient bracing. I have had experience with benches set in what are called skeleton settings, or practically, instead of putting in five or six blocks along the length of retort, not more than two or three are employed. The idea, I believe, is to have less material for the oven to heat up. At first I thought well of it; but I now confess I do not think so favorably of the plan. After a retort has been subjected a short time to the heat of the oven, it begins to break up or crack in all directions. When we attempt to patch up the retorts in the effort to hold them together our most important aid is found in the surrounding supports; and while we might have too much material around them, I think we should avoid having too little. We should have a good firm setting. I think one great consideration is to have a furnace large enough. I have known a furnace to consume 60 per cent. of the coke made, and also have known some of the old style which took up 33½ per cent. I always favor large furnaces and slow combustion, as giving less clinker, and showing less wear and tear. It is hard to say definitely what forms the settings of the future will take; but it is perfectly safe to say that the engineer of the future will be aggressive and pushing. One thing, however, is sure of development, and that will be some arrangement to show definitely what heats we are working at. I think now we too often go to extremes. The stoker's eye is not infallible, and so cannot be always trusted. When the chemist desires to bring out a certain result in distillation, he strives for a definite heat, and at that heat he gets a definite result; but in gas making one day we run at a high heat, and the next day at a low one. Could we not do better if we knew precisely at what temperatures we were working?

Mr. Fullagar—My experience goes to show that the oval form of retort is the best. One reason is that in cases of cracks or breaks the retorts are more easily patched, as the flames pass around the surface instead of impinging on the corners; a second is, greater ease in drawing the charges. As to settings for benches, I think the Sabbaton plan should be awarded the palm. The fault with all retorts made in the United States is their after-expansion, often so great as to burst out the front walls. What can the stoker neglect in the top retort? He has only to draw the coke out of it. As I said, I think the Sabbaton setting and the oval retort is the best working method for any engineer to follow. The first improved furnace we built at our works was, I think, 30 inches between walls, 5 or 6 feet in height, and 4 feet in length. From that we got very good results; indeed, I might say the results were splendid. Fire-brick men talk about their fire brick, etc. If we are going into improved furnaces, the fire-clay workers will have to furnish us with better materials than they are giving us now. The fire-clay manu-

facturers send us very nice samples ; but somehow or another "mistakes" occur in mixing the clay in different style from that pursued in getting up the sample lot. Clay is taken out of the bank to-day, is put under the water tank, and to-morrow the brick is in the kiln. It is a wonderful thing with them now to "weather" clay for a month. In olden times a year or even two was taken up in "weathering." Another thing: do they make proper analyses of the clay? A portion taken from one section of the bank is brought to you; you test it and find it good, and you give an order. When the brick come to hand they are not up to the test; they will shrink and let down the work. The manufacturer's agent comes to you, and, after some talk, he agrees to furnish material for your benches that will last three years; if you get three months out of the material you are lucky.

Mr. Anderson—I believe in benches of sixes where it is possible to run them. I do regret that in country places good stokers are hard to get; but gas companies in country districts have now "skinned" things down very low. They will pay \$30 for an inferior man when they could get a good one for \$40 a month. With regard to Mr. Fullagar's remarks about quality of bricks. When we understand better where the different kinds of brick are to be used—those that are to be put in an open fire (which should be strong and dense), and such as are to be used in arches, etc.—perhaps then we will be able to approach more closely to Mr. Fullagar's views.

Mr. McMillin—One thing which I think very important in small gas works is closing up the space between the grate bars and ashpau, so as to let in about 1-20th part of the air usually passing in. In the old form the opening is sometimes 14 by 22 inches, and the air that will pass in at that point will carry off about 50 per cent. of the heat. We close up the space under our grate bars with doors.

Mr. Anderson—I am glad that Mr. McMillin has alluded to the unnecessary space under the furnace often found in small gas works. I have seen many places where the openings are 12 by 15 or 14 by 16 inches, and also have seen in many small works where no attempt was made at closing up the openings. All that is necessary is to place a piece of sheet iron, pierced with holes, before the opening; and it would be much better if the doors were kept nearly closed.

[The discussion was carried on at some further length, Messrs. Hickenlooper, McMillin, Tayler, Enfield, and Hamlin participating therein; no essentially new points were brought out, and at its conclusion the Chairman declared the regular business sessions of meeting of 1885 as finally adjourned.]

[A Paper read before the Guild of Gas Managers.]

The Effect of Carbonic Acid on the Illuminating Power of Coal Gas.

By C. J. R. HUMPHREYS.

It seems an apt commentary on the incongruity which occasionally attaches to decisions emanating from the goddess of chance, that when the Guild decided, a month ago, to make a new departure in its mission of usefulness, by having papers read at the monthly meetings, and intrusted fickle chance to determine who must take the lead, that she should have elected that this duty and honor should fall on one of your latest recruits; for it would certainly have been more in keeping if to one of the older members had been committed the task of taking the initiatory, so that from the outset the standard for the papers could be established in a manner which would be most pleasing to the members of the Guild. As, however, there is no appeal from the decision of the tribunal invoked, I would ask your kind attention to the subject of these remarks, namely—the effect of carbonic acid on the illuminating power of coal gas.

The matter may well be considered under three heads. Under the first division I would briefly record the extent of the present knowledge of our theme. Passing on to give you in the second section an account of the experiments I have recently made in the hope that I might obtain some light on this question. And, finally, I would try and draw from the foregoing premises such deductions as the facts would seem to warrant.

It has generally been held that, by permitting the carbonic acid which comes over from the retorts along with the gas to remain therein, the illuminating power is destroyed to the extent of two candles. This statement is, however, a very general one, and has seldom been backed up by a record of exact experiments. We have, however, at hand one series of tests, the teachings of which are very instructive. This record is found on page 10 of Mr. Hinman's report for 1882. Mr. Hinman took the ordinary Boston gas, and mixed with it certain percentages of carbonic acid gas, and obtained the following results:

Experiments with Argand Burner.

Percentage of Carbonic Acid.	Loss of Light in per cent.
1.3.....	2.3
2.8.....	5.4
4.9.....	9.2
7.5.....	15.1

Experiments with Flat Flame Burner.

Percentage of Carbonic Acid.	Loss of Light in per cent.
1.4.....	6.3
2.5.....	12.4
3.9.....	16.9

You will note from these tests that the loss of light, when using a flat flame burner, is greater than in the case of an Argand. When using the former burner the lighting quality of the gas is reduced by 6.3 per cent. from the presence of 1.4 per cent. of carbonic acid—this, with 17-candle gas, means a loss of 1.07 candles. I will now give you a brief account of the experiments I have recently made bearing on this matter. Premising the description with the remark that at Lawrence we have been in the habit of passing the gas through three boxes of iron sponge, and then cause it to traverse two boxes of lime; but we have not pretended to use sufficient lime to remove all the carbonic acid. The point I wished to determine was what would be the pecuniary effect were I to use more lime and extract all of this impurity?

To solve the problem I erected in the photometer room at our main office a purifier 2 feet by 2½ feet and 1½ feet deep, and so arranged the connecting pipes that I could cause the gas to flow from the main direct to the test-meter; or I could force it through the purifier before passing to the photometric apparatus. The purifier was filled with lime well moistened. All the tests were made in pairs. I would first determine the quality of the gas as it came direct from the supply pipe; then I would change the valves, so compelling the gas to pass through the purifier, and ascertain the candle power of the purified gas. The following is a record of the experiments:

No. of Test, and Date.	Style of Burner.	Loss of Light in Candles.
1. March 26.....	Argand, D.....	.7
2. " 26.....	".....	.6
3. " 26.....	".....	1.0
4. " 27.....	".....	.7
5. " 27.....	".....	.9
6. " 27.....	Bray, No. 3 Special...	1.4
7. " 28.....	Bray, No. 5 Special...	.6
8. " 28.....	Bray, No. 5 Special...	1.0
9. April 1.....	Sugg, No. 5 Batswing.	.8
10. " 1.....	Sugg, No. 5 Batswing.	1.0
11. " 1.....	Empire Batswing.....	1.0
12. " 1.....	Empire Batswing.....	1.4

In the above statement column No. 1 shows the number of the test; No. 2, the date on which each experiment was made; No. 3, the style of burner employed; and No. 4 shows the loss of light by reason of not passing the gas through the lime purifier. Experiments Nos. 1 to 5, inclusive, were made on the standard Sugg's Argand; the average of these tests showed a loss of light, of the unpurified contrasted with the purified gas, of 0.8 of a candle. Experiments Nos. 6 to 12 were made on different styles of flat-flame burners; the average of these showed a loss of 1.03 candles. In these tests I was very careful to have all the conditions alike during each half of the experiment. I was particular to consume gas at the same rate when passing the gas through the purifier as when running without it; and I was extra careful in this regard when working on the flat-flame burners. All results were figured to a basis of five feet of gas an hour before ascertaining the loss of light.

I was desirous of informing myself how much carbonic acid the gas contained, so that I might know to what percentage of this impurity the falling off in candle power was due. I therefore had an analysis of the gas made as it was passing direct from the main, and also after it had traversed the lime purifier. The analysis of the unpurified gas was as follows:

Analysis of Gas Made March 28, by C. D. Jenkins.

Illuminants.....	5.42
Marsh gas.....	37.24
Hydrogen.....	48.68
Carbonic oxide.....	6.04
Nitrogen.....	1.30
Carbonic acid.....	1.32
	100.00

The analysis of the gas after passage through the small purifier showed that it was free from carbonic acid. Therefore, to summarize the work as far as we have gone, the presence in the gas of 1.32 per cent. of carbonic acid caused a loss in illuminating power of 0.8 of a candle when the gas was burned through an Argand burner, or a loss of 1.03 candles when a flat-flame burner was used.

We wish now to determine whether, as a matter of dollars and cents, it would be preferable to use more lime and take out this impurity, or, leaving it in, make up for its presence by charging more candle. This brings us to the preliminary consideration. Which series of experiments shall we take

as a basis to figure from? Shall we say the loss is 0.8 or 1.03 of a candle? Obviously the latter, because the flat-flame burners are the kind generally used; and we make gas to give light unto the world, and not to toy with in photometer rooms. This being granted, we have to ascertain the cost of putting back this 1.03 candles into the gas; and, on the other hand, to make note of the expense of removing the 1.32 per cent. of CO₂. To add this candle power to the gas would require 5 per cent. of cannel, costing 2.3 cents per thousand feet. The expense of removing the balance of the carbonic acid would be 0.6 of a cent, while the loss due to the diminution of volume by the extraction of this impurity would be 0.5 of a cent. I have placed the cost of cannel at \$10.13; this includes an allowance of 15 cents a ton for breaking, over the expense of breaking caking coal. From actual tests I have found we get one-seventh less coke from Cannelton than from caking coal. This adds 48 cents a ton to the cost of the enricher, making the cannel cost \$10.13. In the cost of purification I have placed lime at 9 cents a bushel of 2,150 cubic inches; labor, \$1.50 a day; a bushel of lime removing the 1.32 per cent. of carbonic acid from 18,000 feet of gas.

To recapitulate:

Cost of cannel in putting back the 1.03 candles per thousand feet.....	2.3 cents.
Against this, cost of lime.....	0.6 cents.
Loss from shrinkage.....	0.5 "
	1.1 "
	1.2 cents.

—Showing a net loss by leaving the carbonic acid in the gas of 1.2 cents per thousand feet.

Finally, gentlemen, I have ventured to bring this subject to your attention not because it is an interesting theme to the chemist or the physicist, but because it is of interest to us in our every-day duties as practical gas managers, inasmuch as it affects the cost of the product we manufacture.

[Translated for the JOURNAL, by "C. P. C."]

The Bower Recuperative Burner.

[M. Albert Marnier, in *Revue Industrielle*, furnishes the following particulars regarding the mechanism and operation of the Bower-Grimston-Thorp recuperative burner. The illustrations given below are also reproduced from drawings that accompanied M. Marnier's communication to our French contemporary.]

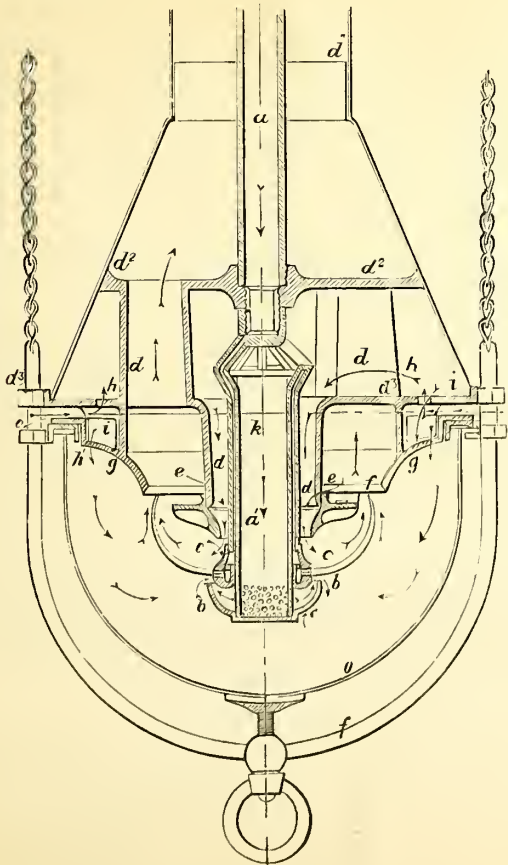

Fig. 1.—Vertical Section.

While electricians are busily engaged in their attempts to effect an economical and practical solution of the problems involved in electric lighting, other and equally persevering and ingenious explorers are pursuing their researches in the field of gas lighting, with a view to securing improved illu-

mination effect by the agency of powerful burners. This competitive rivalry has awakened great interest in the subject, and to this interest must be ascribed the greater proportion of the patented devices which have recently made their appearance. Mr. Bower, by combining or incorporating the best features of the Grimston and Thorp patents with his own, has perfected a

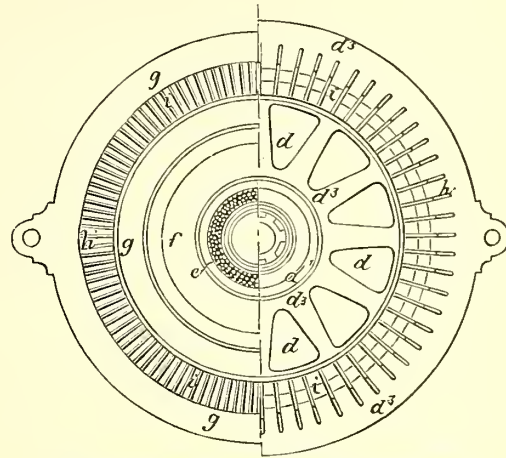

Fig. 2.—Horizontal Half-Sections.

system of intensive burners which, when their principle is thoroughly comprehended, must of necessity be highly thought of by gas consumers in general.

From the diagrams it will be seen that in the Bower lamp the gas descends into a burner having a fixed crown at the middle of the globe. The flame burns above and below the crown, thus forming a veritable ball of light. The

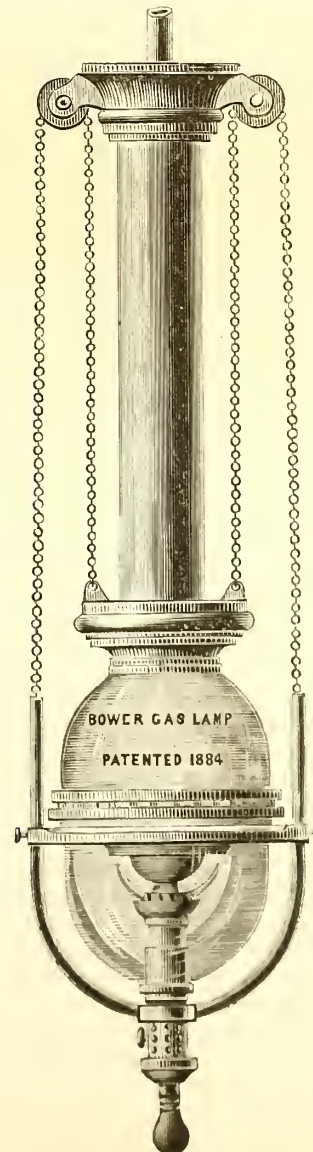

Fig. 3.—Exterior View.

products of combustion escape through a series of heat recuperator tubes placed above the globe. These tubes soon arrive at a red heat, and are surrounded by a series of metallic "winglets"—which are also heated by contact with the gas burned. The cold air traversing these radiating "wing-

lets" is brought to a very high temperature before it reaches interior of burner. A small quantity of warm air circulates on the inside of the globe, preventing it from becoming blackened. A third current, which may be regulated at will, according to variation in quantity of gas being consumed, enters from underneath, gives form to the flame, and supplies the air necessary for combustion. The flame reaches its maximum intensity in about one-quarter of an hour, and the illuminating value varies between 3 and 8 candles for every 27 litres (0.953 cubic feet) of gas consumed. Stated simply, the chief principle of the action is, the heating to a high and uniform temperature of the volume of air necessary for the complete combustion of the gas.

The shape of the burner, and the disposition of its accessory parts, however, are not without importance as factors in the increase of illuminating power gained. Figure I. shows a vertical section of lamp; Figure II., showing horizontal half sections, clearly illustrates the method of construction. Figure III. is an exterior view. In the lower section of the apparatus may be noted an air duct which can be opened or closed at the pleasure of the operator.

The gas enters through the conduit *a*, which terminates in a still larger tube, *a'*, and communicates with interior of burner, *b*, which is perforated with holes to admit of the free passage of the gas. This burner is made of steatite or any other suitable description of material. A steatite crown, pierced with holes, is placed between two stays, *c*, one of these being attached to the lower part of the tube, *a'*, while the other covers the circular gas flow pipe, *a*. This is also surrounded by the heat recuperator, placed, as is usual, above the burner, and is composed of radiating "winglets" forming distinct compartments. The change of temperature between the warm gas and the cold air admitted at *e* is obtained by a series of vertical tubes, *d*, brought from the source by means of metallic discs, *d₁*, *d₂*, and traversed by the products of combustion before they enter the chimney, *d''*. Between the recuperator, *d*, and the burner is placed a tube, *d'*, fitted with a disc, *e*, pierced with holes. A circular crown at the neck, *g*, diverts the flame towards the interior. The space comprised within the discs, *g*, and *d₂*, is occupied, at *i*, with a series of divisions or partitions, alternately resting on one or the other of these two discs. The circular space, *i*, communicates on one side with the atmosphere, connecting on the other side with the first recuperator in such a manner that the crown, *i*, constitutes what may be termed an auxiliary recuperator.

Examination of the direction of arrows traced on fig. I. shows that the air heated by the first recuperator penetrates into the interior of tube *k*, and leaves it at its lower part, where it is mixed with the gas, which, as a consequence, gives out a most intense flame. Another quantity of air circulates along the tube *d'*, heats itself through contact with walls of second recuperator, and traverses the grating *e*, to feed the flame above the burner. The globe *o*, rests on a support, *fx*, kept in place by a swinging chain, thus permitting, and without any difficulty, the cleansing of the interior.

According to statements made by the inventor this burner, with a consumption of 425 to 850 liters (15.006 cu. ft. to 30.012 cu. ft.) of gas per hour, gives 8 candles for 28 liters (0.988 cu. ft.), and even better results may be attained if a reflector be used.

SPECIAL ENGLISH CORRESPONDENCE.

COMMUNICATED BY NORTON H. HUMPHRYS.

SALISBURY, May 9, 1885.

Gas Explosion in London.—The Steam Roller Case.—The Prospects of the Sulphate of Ammonia Market.—Gas Exhibitions.—The Chancellor of the Exchequer and a Proposed Tax on Gas.

Not many months have elapsed since I had to record a disastrous explosion of gas in the southeast district of London, resulting in the wrecking of a small tenement and serious damage to those adjacent; and again I have to call attention to an accident, resulting in very similar disastrous consequences, in the same neighborhood, and affecting a similar class of property. A new thoroughfare had lately been laid down, and a row of small cottages, for the occupation of the artisan classes, just completed; and several months since a 4-inch gas main was put down by the request of the parochial authorities for the supply of a few public lamps, but the gas had not been laid on to any of the cottages. It appears that a row of similar buildings was in process of construction on the opposite side of the road, and the original land, having been found to contain good building sand, was being excavated for the removal of the same, the void being made up with rubbish. The excavation, approaching within a few feet of the gas main, probably weakened the soil below, being assisted in this respect by overflowings and sloppings from a water tub placed close by for the use of the builders. Under these circumstances a heap of rubbish comprising, according to evidence at the inquest (for the disaster was unfortunately attended by fatal consequences), some 20 tons weight, was shot on the surface of the ground just over the gas main. These two causes combined to force the main to sink

several inches, and of course resulted in a fracture. The escaping gas found its way into the tenement of the cellar opposite, and at about 8:30 on the evening of the 20th ult. it was inflamed by a little girl going into the cellar with a lighted candle. A tremendous explosion followed, which completely blew out the front and wrecked the whole of the house, the adjacent house being also much shaken and injured. Fortunately, being a quiet bye-street, there were few people about; but the noise of the explosion, which is described as resembling a heavy cannonade, at once drew together a large and excited concourse. The occupants of the unfortunate house, with the exception of two infants who escaped uninjured, were frightfully battered about; one woman has already succumbed, and another is reported as in a precarious state. Of course a regular London crowd assembled, and at once began to avail themselves of the vantage ground offered by the heap of rubbish before mentioned for viewing the ruins, or so much of them as could be distinguished; but they quickly vacated this spot, on account of the fact that, being just over the fractured gas main, it was permeated with gas, which, being inflamed by some means, illumined the whole scene, until the gas company's men succeeded in stopping off the gas—this being effected by breaking the main at some distance away, and stopping up the broken pipe with clay.

There are some people who seem to imagine that every accident with gas is in some some way or other, directly or indirectly, the fault of the gas company; and in connection with this deplorable event there are those who find fault with the way in which the gas mains were laid. Of course a proper inquiry will be held as to the cause of the disaster, and if any negligence occurred in connection with the laying of the main, the same will be fully elicited. No evidence of such, however, is as yet forthcoming, nor is such needed to account for the accident, the cause of which is obvious from the description of the facts above given. Really, when we remember the enormous aggregate length of gas mains in the streets of any large town, and the amount of disturbance to which they are subjected in the course of carrying out sewage and drainage works, excavations for the erection of large buildings, underground railway tunnels, alterations in level of streets, etc.—all of which are carried on with but little special regard to the safety of any gas mains in the vicinity—the fact that the occurrence of accidents from broken gas mains are so few is remarkable. Of course the gas company always have an efficient system of supervision; but it does not seem practicable, in the absence of regulations enforcing contractors to give notice of any work they may be carrying on near to the gas pipes at the office of the company, to devise any system that shall be sufficient to protect the mains and service pipes from interference in the way of weakening the ground below them, or piling heavy weights above. According to the latest Parliamentary return, the three gas companies who divide the honor of supplying London with gas are the proprietors of between 2,600 and 2,700 miles of main pipes; add to this the small connections for consumers, and we may say that the total length of gas pipes in London streets cannot be less than 4,000 miles. An enormous length—equal (following the fanciful method of expressing large quantities that is now so much in vogue in "popular scientific" circles) to one-half the diameter of the earth.

After the contemplation of this disaster, and its melancholy consequences, we turn with increased satisfaction to the judgment delivered in a case which came before the "Supreme Court of Judicature—Court of Appeal" a day or two since. This was an appeal by the defendants against the judgment given in the case of "The Gas Light and Coke Company vs. the Vestry of St. Mary Abbots, Kensington," popularly known as "the steam roller case," to which I have previously referred (see Vol. XLII., p. 10). The appeal was dismissed with costs, the judgment given by Justice Field being upheld on every point. It will be remembered that the gas company applied for an injunction to prevent the defendants from repairing the road in such a manner as to injure the gas mains—the use of a heavy steam roller being specially complained of, and shown by evidence to have been the cause of several accidents. The Vestry, in defence, claimed they had a perfect right to do what they pleased on the roads for the purpose of repairing them, without regard to the gas mains. The extraordinary argument was advanced that the pipes were there on sufferance at the owner's risk, and if they were broken it was for the gas company to replace them with others sufficiently strong to stand any strain to which they might be exposed. As I remarked at the time, the fact that the leakages might be attended with disastrous and even fatal consequences (as instanced by the accident just described), was entirely ignored by the parochial authorities, who, as the representatives of the public, might naturally be expected to have a keen regard for public welfare and safety. According to the interpretation of the law given by the Lord Chief Justice in pronouncing judgment, it appears that the gas mains are to be respected, and that no process likely to be injurious to them may be used by the highway authorities, unless the latter can show that such process "is expressly authorized by statute." There is no statute authorizing the use of steam rollers, and therefore the case of the vestry falls to the ground. This decision is very important, as it affords a precedent for gas companies to quote, as

securing reasonable care, either on the part of highway authorities or other parties, against injuring the gas mains; it also disposes of the absurd argument that gas mains should be of extraordinary strength, so as to withstand any amount of interference—showing that, on the contrary, all gas companies have to do is to provide for the strains of ordinary traffic, etc., in a reasonable way.

Mr. C. D. McAllum, of Newcastle, is a sort of Job's comforter, as regards the present depression in the sulphate of ammonia trade; which depression, by-the-way, shows no present signs of improvement. Taken with the present difficulty of finding a market, Mr. McAllum's views are such as to cause considerable anxiety to those who, calculating on the returns for residuals that have been obtainable in recent years, have been sailing close to the wind in the matter of the price of gas. In the gas world the intrinsic value of sulphate as a manure has been accepted as a matter of course; and also that it is preferred to its competitor, nitrate of soda; and so it is rather a shock to be told by Mr. McAllum that nitrate of soda is preferred to sulphate, even at a higher price, and that "sulphate is going out of favor for agricultural purposes, because it does not answer well as manure." But sulphate has now been in the market for several years, so it is rather late in the day to be told that it is, if not useless, far inferior to nitrate. Those who have tried it as a manure, and have developed a local trade for it, know better than that. There may be cases where it has not been applied under conditions suited to the requirements; for it is obvious that all artificial manures must be applied with great judgment and skill. Mr. McAllum's complaint against sulphate was comprised in a paper on "Sulphate of Ammonia," read at the recent meeting of the North of England Gas Managers Association; and his remarks were not challenged in the discussion for the simple reason that the subject of the properties of sulphate as a manure was quite novel to the members. The grounds for these opinions do not appear to be the result of practical experience; they are apparently deductions drawn from the relative prices that have respectively been obtained for sulphate and nitrate during the last few years. But I venture to think that, if necessary, plenty of practical proof will be forthcoming as to the value of sulphate as a manure. On account of the low prices many gas engineers are turning their attention to the development of a local trade; as an example of what is being done in this direction I enclose you a circular recently issued by my friend, Mr. Sainsbury, of Trowbridge:

"BRITISH GAS LIGHT COMPANY, LIMITED, TROWBRIDGE.

"SULPHATE OF AMMONIA.

"TO FARMERS, MARKET GARDENERS, AND OTHERS.

"Sulphate of ammonia is highly valued as a manure for producing good crops of wheat, oats, etc., and also fine fruit, vegetables and flowers. The British Gas Light Company, Limited, are manufacturers of this excellent manure at the Trowbridge works, and are now selling it at retail, by the cwt., packed in bags, and will forward it, as may be directed, to any address. The price varies from time to time; it is now — per cwt., including the bags, loaded into carts at the works, or railway trucks at Trowbridge railway station.

"The following are the proportions in which it should be used: For grass land; about 1½ cwt. per acre, to be put on the land before or after a shower of rain. For wheat, oats, and barley; about 1 cwt. per acre for wheat; about 1 cwt. per acre for oats; about 1½ cwt. per acre for barley. For vines; 1 bushel on the vine border, and lightly fork it in, in the months of March, April, May and September. This quantity (1 bushel) to be for the nourishment of four vines. For onion beds; give a good sprinkling over the beds two or three times during the growth of the onions. For potatoes; about 1½ cwt. per acre, as a top-dressing, before the haulms appear above ground. For greenhouse plants; a large teacupful in a bucket of water, to water the greenhouse plants with twice a week. Not to be used, however, for heaths, rhododendrons, or orchids. For peach, apricot, plum, currant, and gooseberry trees; a similar solution to that given for greenhouse plants, in the months of March, April and May. Rose trees and garden plants are benefited by the use of the solution. Celery, cabbages, and cauliflower also grow well when watered with the solution. For raising healthy plants from seeds; sprinkle a good quantity of the sulphate on the seed beds, and then water them a week before sowing the seeds. Melons and cucumber plants are likewise much benefited by sulphate of ammonia. By the use of sulphate of ammonia vegetation is rendered more healthy, and consequently less liable to the destructive attacks of the scavengers of nature, especially if used in the spring of the year, when vegetation requires a condensed antiseptic food and nourisher to enable it to withstand the blighting effects of the northeasterly winds."

Gas exhibitions appear to be more than ever in the ascendant this season, and a large number were held during the past month. The most notable is that held at Carlisle, under the auspices of the Mayor and Corporation. There is every reason why such should pass off satisfactorily in that town, for the gas works is the property of the Corporation, and consequently the

gas consumers are made to find the money for all sorts of public improvements that otherwise would have to be paid for out of the rates. The proceedings comprised lectures, by Mr. Harold B. Dixon, on "Gas light and gas heat;" by Dr. Stevenson Macadam, on the "Sanitary aspects of heating and cooking by gas;" and a course of lectures on cookery, by Mrs. Thwacks. There is something attractive about the easy way in which these lady lecturers peel apples, roll out pastry, and perform other operations without the slightest hitch in their fluent expositions on the matter in hand; and lectures on cookery are a decided attraction in connection with any gas exhibition. A well-arranged scientific lecture, illustrated by experiments, is also sure to be well received, and both Mr. Dixon and Dr. Macadam are well-known as adepts at this sort of thing. But the exhibitions are not confined to our principal towns; they are being held at small places numbering only a few thousand inhabitants, and in all cases appear to be attended with success.

On one evening last week I noticed that the chancellor of the exchequer, in referring to suggested means for raising additional revenue for the country, amongst others, by a tax on gas and illuminating oils, expressed a decided opinion on this latter subject, and one which will be received by the gas interest at large with much satisfaction. He said: "I will have none of these taxes; I strongly object to have anything to do with the imposition of taxes on raw materials or the necessaries of life, whether food, or the means of warming and lighting." For some years past the government has been in the habit of demanding an annual return from statutory gas undertakings, setting forth the principal facts in connection with their year's working; and, indeed, forming almost as full a report on the condition of the undertaking as a shareholder could wish for; and some curiosity has from time to time been expressed as to the object in view in demanding so full a return. The possibility of a tax on gas has more than once been hinted at, since such a proceeding is known to be regarded in a favorable light in certain influential quarters; and the above unmistakable expression of opinion from the chancellor of the exchequer will be received with much acceptance by those who have seen reason to anticipate such a drawback to the advancement of the gas industry and interests.

ITEMS OF INTEREST FROM VARIOUS LOCALITIES.

MISTER GIBBS "GETS LEFT."—In our last issue we had occasion to mention that W. W. Gibbs (he of the United Gas Improvement Company, of Phila., Pa.) brought suit to recover the sum of \$50,000 as compensation for services he had rendered the Consolidated Gas Light Company, of Baltimore, Md., in patching up a truce, between the officials of that corporation and the managers of the rival (the Equitable) company, as to the war of gas rates that prevailed there some time ago. We ventured the assertion that Mister Gibbs would not be likely to get any of the money, and now we can say that he won't. On May 14th Judge Morris, of the United States Circuit Court, before whom and a jury the case was to be tried, took the case out of the latter's hands, by ruling that the truce contract between the two gas companies was null and void, consequently the plaintiff had no standing in court, since his assumed "services" had resulted in nothing other than an illegal agreement. Messrs. Morrison and Bond, of counsel for Consolidated Company, submitted briefs showing that the Equitable Company's charter expressly forbade the action which Mister Gibbs was at such "great pains" to accomplish. Section 4, chapter 328, acts of 1882 (really a supplemental act to the charter of the Equitable Company), provides, "That the said company be and hereby is prevented from entering into any consolidation, combination or contract with any other gas company whatsoever; and any attempt so to do, or to make such combinations or contracts as are herein prohibited, shall be utterly null and void." The substance of the agreement, now declared null and void, is, substantially, as follows: The two companies were to raise the price of gas to \$1.60 net per 1,000 feet, and the Equitable was not to make any further main extensions; both were to pool the net profits derived from all new business, the profits subsequently to be divided in a certain proportion, and the Equitable was to pay interest on the cost of the plant necessary to secure such new business. They were also to pool their entire receipts from the old business, the sum of same to be divided in certain proportion. Each company was to look after its own securities. A forfeit of \$250,000 was the penalty incurred by the company first to break the contract. President Hull, of the Consolidated, testified, "he did not consider the agreement, as made, desirable to his company." Now, it would seem as though the latter gentleman might be right in so thinking, especially since the Chesapeake opposition promoters might incline to the idea that the "agreement" would be decidedly favorable to their operations. It is a pity that the "true inwardness" of this Chesapeake "deal" cannot be brought to light, although the "lapse of time" may be counted on to show up some of its leading features. To return to Mister Gibbs: That eminent apostle of carbonic oxide had no trouble in convincing the Equitable managers that his services as mediator should be recompensed, and they immediately handed him over

\$50,000—in cash? our readers ask. Well, no; not exactly. They gave him \$50,000, at *par value*, in the stock of the Equitable Company. We ventured to suggest in our number for May 16th that Mr. Gibbs' hair would become pretty thin before he got a verdict, and the decision of Judge Morris, as given above, amply confirms the prognostication; but just think how venerable Mister Gibbs will be in appearance by the time he has had an opportunity to ask his bankers to cash a dividend check, the figures whereon may be taken to represent money earned by the Equitable Company as a seller of gas! He would be able to dispute seniority with Methuselah. Taking a calm survey of the situation, it would seem as though Captain Hall, of the Consolidated Company, has a little the best of his opponents—be they either connected with Gibbs, the Equitable, or the Chesapeake opposition.

THE DEATH ROLL.—CASE NO. 1 LOOKS LIKE A SUICIDE.—On the morning of May 1st Adolph Glackmeyer was found dead in bed in his room at the Rochester Hotel, No. 114 Bleecker street, New York city. The room was filled with gas that had escaped from a turned-on burner. While there had been no attempt made at closing up the crevices at door and windows to room—in fact the transom was ajar to the extent of a couple of inches—from the fact that Glackmeyer, who was personally unknown to the proprietor of the hotel, had registered under an assumed name, that he had been suffering for months from a pulmonary disease, that on two prior occasions he had attempted to commit suicide by taking poison, and that his domestic relations had been very unhappy—all these things were brought to light within a day or two after his death—it was surmised that the unfortunate man had determined to end his life, and with that purpose in view went to bed after having blown out the gas.

CASE NO. 2.—On evening of May 19th Jno. Devine registered at the new Cluilton Hotel, Kokomo, Ind. He retired to his room, and some three or four hours afterward the smell of escaping gas attracted the notice of a hall porter. The search ended at door to Devine's apartment. A forcible entrance developed the usual state of affairs. Devine was a corpse, and his death had resulted from asphyxiation caused by the inhalation of illuminating gas. The old story of blowing out the gas is once more repeated. When the Kokomo folks made coal gas their product never killed anybody.

OUR ENGLISH CONTEMPORARY THINKS SO TOO.—The *Journal of Gas Lighting*, of date of May 5th, devotes over two columns of its space to an ably-written (indeed our brilliant contemporary is ever noted for the ability and impartiality with which it discusses any topic) review and commentary upon the now famous report,* made by Profs. Sedgwick and Nichols, of Massachusetts, in regard to the poisonous qualities of water gas. It is with a feeling of genuine pleasure that we note our contemporary ranges itself on our side of this matter; and we suppose that the patent-right sellers on this side of the Atlantic will have the decency (we do not expect them to acquiesce on the score of common sense or honesty) to admit that the London *Journal*, voicing as it does the opinions of writers like King, Weber, Fentrell, Newbigging, Humphrys, and others, takes its standpoint from no other basis than a wish to promote the best interests of the gas maker. We would recommend that all our readers should peruse this calm judgment of our London contemporary, and regret that the pressure upon our columns is so great as to prevent us from republishing it in full. We cannot forbear, however, from reproducing the final statement made by our English *confere*, which is as follows: "Upon general principles, the promiscuous sale of gaseous poison seems to require to be checked as much as the irresponsible dealing in arsenic by a quack apothecary. It is impossible to read the narratives of casualties arising from the inhalation of water gas by inexperienced hotel visitors and domestic servants without an unpleasant impression that these occurrences should be more fully investigated than seems to be the rule. Speaking plainly, it appears that the presence in a sleeping apartment of a burner supplied with water gas is a facility for murder that should not be permitted in a civilized land. It is unnecessary to pursue this part of the subject; but the mere suggestion of the nefarious use to which water gas lends itself so readily, and with the slightest possible risk of discovery, should be sufficient to exclude it not only from France and Massachusetts, but from every other State on both sides of the Atlantic."

TRUMPING UP CHARGES OF LABOR TROUBLES.—The Newark (N. J.) daily newspapers, probably at a loss for some local sensational matter, determined to have a fling at the Newark Gas Light Company, thereby seeking to bring down "two birds with one stone"—in the first place hoping to point the "finger of public scorn" at a bloated monopoly, with thesecond object of posing as the true "friends of labor." Oh! yes. The true friends of labor, certainly. If these very self-appointed conservators of Newark's laboring classes would only publish the prices at which they "remunerate" their own compositors and pressmen perhaps their remarkable disinterest-

edness might not seem so apparent. At any rate, the "formers of public opinion" indulged in an outcry at a recent reduction in the wages of the employees of Mr. Vanderpool's company, and raised a sort of dismal howl about the uncalled for dismissal of several of the men. How much of truth was contained in the assertion may be understood from the following; and bear in mind that the "sleuth-hounds of the press struck the scent" on or about the middle of May: On January 3d, 1885, the Newark Company made a reduction of 25 cents (or from \$2.50 to \$2.25) in the pay of some of the hands. It was the first reduction made in some years, and the Newark folks could now readily fill the position of every similar class of "hand" in their works at a cost of \$2 per day each. No reduction beyond that of January was at any time contemplated. On the contrary, since then the pay of certain hands in some other departments of the company's plant has been increased. The tasks allotted to the men have not been in any way added to. Since January 1st ten removals have been made—and every one of those dispensed with had given sufficient cause for the action taken. The sleuth-hounds have evidently been "barking up the wrong tree."

CERTAINLY; WHY NOT?—A trifling light has been vouchsafed us in regard to that mysterious "Avery Gas Company," since we announced the filing of its certificate of incorporation as given in our last issue. The "company" has held its annual meeting. It took place on the 19th of May, and the officers selected to preside over its destinies were: E. P. Cone, president; J. W. Kones, vice-president; A. F. Learned, secretary; and J. W. Bartlett, treasurer. A representative of the JOURNAL was gravely informed that the company owns a new gas process which is well calculated to revolutionize the gas business of the country; but like unto that incandescent light of the great Pennsylvania balloonist professor, and that other wonderful "scientist of Penn's land" "Prof." Keely, the particulars regarding "the composition of the materials" are withheld until the proper period arrives. The last hope of the coal gas man hath vanished! Certainly; why not?

HOW A REVEREND GENTLEMAN LOOKS UPON DIFFERENT LIGHTS.—The Rev. Dr. Howard Crosby has been turning his pious thoughts toward "light," and his opinion is thus made manifest. The gentleman has been manufacturing light on his own account; but he has only thus far succeeded in illuminating the pages of a book with the homebred product. The book bears the title of "Kindly Light"—it is a right good book, too—and an advertisement of its excellencies bears an imprint of the quotation, "It is a softened sunlight that carries healing on its wings." Now, of course, if Dr. Crosby did not think his light was as it is represented in that "ad." he would immediately order his publishers to stop making the assertion. So much for the Doctor's own "light;" and here is what he thinks of the Consolidated Gas Company's light—an excellent, good light it is too—in particular, and other gas lights in general; for so he wrote during the "Sherwood boom" of fragrant memory: "Our gas companies have been plundering long enough. They should be squeezed like leeches to give up the blood they have sucked." "How sweet is charity," etc. The Doctor must have been troubled with indigestion at about the time he penned those elegant and forceful words.

MORE INVESTIGATIONS.—The Senate junketing committee that "investigated" the New York gas companies early last spring must have had such a pleasant time at the Morton House as to make others of their august body anxious to try a hand at it. At least this inference might be deemed fair from the closing proceedings at Albany, N. Y., on date of May 15th last, for President McCarthy appointed Senators Gilbert, Robinson, and Murphy as a special committee to "investigate the consolidation of the New York gas companies." Why, we thought, judging from previous assertions made on the floor of the Senate, and just at the time when that 19 to 1 affirmative vote was taken on the "New York Gas Commission bill" (otherwise the "forty thousand dollars per annum job"), that Sherwood & Co. had posted the lawmakers in every particular. It seems not, though. If the special committeemen have power to take testimony whenever they like and wherever they elect, we would suggest July and August as the months and Long Branch as the place. The Monmouth Park racetrack is convenient to the "Branch," the sport is always good, and poolselling is not interfered with "down that way." Furthermore, Mr. Withers, G. and P. Lorillard, Peabody Wetmore, and J. G. Bennet (the owners of the track) are understood to be more or less interested in gas stocks. If they cannot take testimony in New Jersey, they could hold the seances up at Saratoga, where the conditions are pretty much the same as those at the "Branch." Who could blame them for combining business with pleasure?

THE COST OF OPERATING A GAS ASSAYING FURNACE.—Prof. Torrey says that the expense of running a specimen of the Reichhelm gas assaying furnace (in use for some time in the assaying department of the United States sub-treasury building on Wall and Pine streets in this city), carrying a muffle of 7 by 12 inches, is about ten cents an hour, with gas costing \$1.50

* See JOURNAL, March 16, pp. 148-9.

per thousand. This shows an hourly consumption of about 66 cubic feet. The estimate was made up from the average of one year's experiments.

NOMINATING AN INSPECTOR OF GAS METERS.—Governor Hill, on May 14, handed in to the Senate for confirmation as official inspector of gas meters for New York city the name of Mr. William O'Brien. The nominee's principal qualification for the position appears to be the fact that he is the nephew of the Hon. "Jimmy" O'Brien. We do not know what action was taken by the Senate on the nomination, the Secretary of State never having troubled himself to answer our communication in regard thereto. And yet we are told that "public office is a public trust."

HOW THEY TRUST ONE ANOTHER.—On June 19, 1884, a serious fire occurred at the works of the Bloomington (Ills.) Gas Light Company (it was reported in JOURNAL of July 2), and on the representations of Mr. C. D. Hawk—at that time manager of the Bloomington plant—that the accident arose from a defect in the apparatus furnished by A. O. Granger & Co., the latter firm made good the loss sustained by the Bloomington folks, and to do so incurred an expense of \$1,200. Granger subsequently made a quiet investigation of the case, and this resulted in apparently showing that the negligence and foolhardiness of the Bloomington employees had brought about the catastrophe. Granger accordingly entered suit to recover the expense he was put to in repairing the plant. After a trial of the case Granger was awarded a judgment in the sum of \$1,215.18. And yet "these be all honorable men." It might here be casually noted that Mr. C. D. Hawk is supposed to be backed by a wealthy firm of Springfield (Ohio) manufacturers.

STRIVING FOR AN INCREASED SUMMER CONSUMPTION.—The Covington (Ky.) Gas Light Company's managers intend to sell some gas this summer. They are urging upon their consumers the benefits to be derived from an intelligent use of gas cookers, and have also decided to make a discrimination in selling prices between gas used for cooking and that employed for lighting, with a view toward fostering an enlarged consumption of the former class of output. Gas used for illumination is scheduled at \$2 per thousand; that for cooking and power at \$1.50.

MONTGOMERY (ALA.) TO DO LIKEWISE.—Mr. T. Gardner Foster, Manager of the Montgomery Gas Light Company, recently informed us that his company will make a persistent attempt to introduce gas for cooking purposes with this summer; indeed, he has already gone at the work with vigor. A discriminatory rate will be made, but the exact figures have not yet been fixed upon.

GAS TURNED ON AT LOS GATOS, CALIFORNIA.—Gas was turned on to the mains of the Los Gatos Gas Light Company, for the first time, on the evening of April 15. The appearance of the illuminant was made the occasion of public rejoicing there. Mr. M. G. Elmore, the organizer of the company, as also constructor of its plant, made the first overtures toward the institution of the corporation on about the middle of January. The project received hearty support from the start, as, indeed, the fact that gas was sent out in three months from the time the enterprise was broached amply proves. Of course, the works are small; but the town, although a live place, is only possessed of about 5,000 souls. The plant has a per diem capacity of 15,000 cubic feet; but we would suggest to Mr. Elmore that, even though clay retorts were very expensive out in that section of the country, and that he would be obliged to wait some time for their delivery, prudence would certainly have accepted both these alternatives rather than employ the iron vessels really put in. The capital stock of the Los Gatos Company is fixed at \$50,000, of which \$17,500 has been paid in. Mr. Gilbert Clayton has been selected to assume the post of Superintendent.

WAITING FOR THE IMPROVED MACHINES.—Lynchburg (Va.) Councils awarded a partial contract for the night lighting of that city "quite a long while ago," to a concern called the Piedmont Electric Illuminating Company. Having had time enough to do the work of installation at least ten times over, the city fathers at last became impatient to know when the moons were to shine; and in response to their formal inquiry Mr. E. Grening, Manager of the Piedmont, etc., wrote back in reply that his company had purchased their dynamos and lamps from the "Brooklyn Electric Construction Company," and as these specimens of the craft of the electrical constructor were not adapted to run well when impelled by water power (it is proposed to use hydraulic power at Lynchburg), hence the delays in perfecting the system, etc. Mr. Grening concludes his plaint by "craving the indulgence of your Common Council for but a few days longer." If the Council were wise they would grant Mr. Grening an indefinite postponement, and so save the taxpayers their money.

NO ELECTRIC LIGHT FOR POUGHKEEPSIE, N. Y.—Mr. Allen, of the Citizens Gas Light Company, of Poughkeepsie, has finally vanquished the

American Electric Lighting Company in the latter's attempt to secure a portion of the street lighting. On the evening of Monday, May 12th, the City Council voted to contract with the Citizens Company for the entire street lighting during 1885, on the following basis: 160 lamps at \$23 each, and 461 lamps at \$31 each, or a total contract price of \$17,971. No charge is to be made for gas supplied to public buildings. This latter is a rather queer policy, even though the cost of gas consumed in the public buildings is estimated at but \$500 for the twelvemonth. Indeed, we do not see on what grounds Mr. Allen can justify the movement; it certainly cannot be because the gas he sells is worthless.

IS IT A JOB?—On the evening of Thursday, May 7th, the Troy (N. Y.) Common Council passed a resolution granting Messrs. G. S. Geer and Chas. McCarthy permission to lay pipes for the transmission of non-illuminating gas to be employed in domestic and mechanical operations as a fuel agent. It is understood that the grantees of the privilege awarded propose to utilize, as far as possible, the mains of the defunct Troy Steam Heating Company, and, further, that they intend to employ the Lowe system. Everybody knows how the sharks of the United Gas Improvement effected a partial entrance and lodgment into the St. Louis (Mo.) Gas Company's territory under the false pretense that they intended to manufacture and sell a fuel gas only. The words and promises of such men go for naught—they are best judged by their acts; and it will stand the Troy (N. Y.) Gas Company in good need if they watch Mr. Geer pretty sharply. He will bear it; and the scrutiny will not be thrown away.

STATION METER BLOWN UP.—At 10 A.M., on May 20th, while three workmen were employed in making search for a defect that was supposed to exist in a station meter located at the Second and Convent street station of the St. Louis (Mo.) Gas Light Company's works, one of the men, it is supposed, poked a candle into the dry well of the meter, and a tremendous explosion ensued. Two of the men (named Burns and Doran, respectively) were instantly killed, while the third (Killian) although badly injured, will recover. The meter had been out of use since last January. Superintendent Lansden had given the men strict injunctions as to how they should proceed—in fact he had probably not been away from the spot over five minutes when the explosion took place. The coroner's jury, after listening to Killian's testimony at the trial held on May 21st, exonerates the gas company's superintendent most completely from any sort of negligence in the premises. The loss is put down at \$10,000.

GAS WAR AT AUSTIN, TEXAS.—The latest trace of our erratic traveler, B. Van Steenberg, crops out at Austin, Texas. At that point our wandering hero is in control of the fortunes of an opposition concern called the Capital Gas Light Company. He has "piped" the paying portion of the city, and given notice that from and after May 1st the opposition jugglers would be ready to deliver gas at \$1.25 per 1,000 cubic feet. Mr. Judge, Secretary of the old Austin Gas Light and Coal Company, met the cut in that section of the city by offering to supply consumers in the disputed district at the rate of \$1.50, and further notifies his customers that should they think of making a change they had better call at the office of the old company, and so probably save money. We think we can rely upon Mr. White, of Houston, to keep us posted as to the doings of the Austin branch of the Van Steenberg (how like it is to Van Amberg) menagerie.

The Market for Gas Securities.

At present hour of writing (noon, May 29th) the quotations on 'change show Consolidated gas at 98½ bid, offered at 99. In last number of JOURNAL we predicted that Consolidated would about reach par before Decoration Day, and were not very far out of the way in the assertion. Sales were made some two or three days ago at as high a notch as 99½, and the total transfers for the fortnight aggregate somewhere in the immediate neighborhood of 3,600 shares. We also stated that a dividend of three per cent. would shortly be declared; but we were out of our reckoning slightly, since, on May 27th, the management published the announcement that on June 16th the Consolidated Company would pay a 3½ per cent. return to its stockholders. The transfer books will be closed on June 5th. Equitable is in the "dumps," and is now offered at 122½. We gave pretty good advice with regard to this security in our last market report. Mutual holds its own fairly well. Brooklyn shares are sluggishly inclined. Baltimore Consolidated is down to 47. Washington (D. C.) gas keeps very steady. St. Louis (Mo.) gas is rated at 775 bid. All classes of Eastern gas shares are fairly well held. Muller, New York city, recently sold the following lots at auction: Peoples (Brooklyn), 800 shares, at 81 to 81½; 100 shares Brooklyn, at 126; 1,312 shares Nassau (Brooklyn), at 120½ to 121½; and 20 shares Havana (Cuba) Gas Light Company's stock, at 12½. Nothing else of interest, unless it be to say that, with gas at a dollar a thousand, the Louisville (Ky.) Company can earn about 5½ per cent. on its capital.

**FOR SALE,
Second-Hand Gas Apparatus.**

The Louisville (Ky.) Gas Light Company wishes to dispose of the following:

- 15 Sixteen-Inch Chapman Valves.
- 6 Twelve-Inch Chapman Valves.
- 2 Twelve-Inch Center Seals & Connections.
- 2 Smith & Sayre Gas Steam Governors.

All in good order, and will be sold at low figures. Address inquiries to
A. H. BARRET,
Engineer's Office, Louisville (Ky.) Gas Company.

Ammonia Plant for Sale.

Owing to a change in the manufacture of gas by the York Gas Company, we offer for sale our complete plant for the manufacture of sulphate of ammonia from gas liquor. Capacity, 500 lbs. daily, which can be increased to 1,000 lbs. Suitable for a gas works carbonizing from 1,000 to 10,000 tons of coal per annum. We will agree to deliver, set up, and start the same for a moderate price, and show a fair profit. For further particulars address

C. H. DEMPWOLF & CO.,
622-4t YORK CHEMICAL WORKS, YORK, PA.

For Sale at a Bargain.

COMPLETE 4-INCH GAS GENERATING APPARATUS,

From our old works. Iron Frame for Roof; Mouthpieces, Stand Pipes, etc., etc.

Just the thing for adding to capacity of works already in operation, or for starting a new works. Address

616-St GAS COMPANY, LIMA, OHIO.

**FOR SALE,
100 MINER GLOBE STREET LAMPS.**

The lamps have been in use, but only those that are in good order are offered for sale. For terms, etc., address

THE NEW YORK & NEW JERSEY GLOBE GAS LIGHT CO.,
615-tf No. 1 Park Place, New York City.

It will "Pay the Piper,"
If he aims to pipe well for STEAM, WATER, GAS, ACIDS, OILS, AMMONIA, &c., to examine this UNION, which requires no packing, but is always ready for instant use. When you next order Fittings of any Dealer, ask for a sample American Union to come with them, and it will tell you the whole story, or we will, if you write us for particulars.

PANCOAST & MAULE,
PHILADELPHIA, PA.

GAS CO. OFFICERS, READ AND REFLECT.

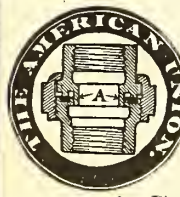

HODGE'S UNIVERSAL ANGLE UNION, Pat'd

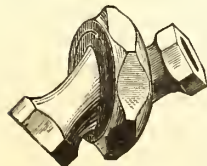

A new and important Pipe Fitting for Steam, Water, or Gas. Combining a variable angle or elbow and a union. Saves pipe, saves time, decreases friction and radiation, gives a union joint at every angle, and can be set at any angle at which it is desired to run the pipe.

HODGE'S SWIVEL FLANGE,

A common sense article, designed to save time and money.

MANUFACTURERS AND WHOLESALE AGENTS,

ROLLSTONE MACHINE CO.,
142 Water St., Fitchburg, Mass.

WM. FARMER, ENGINEER,
32 Park Place, Room 36, New York.

THE CHEMIST'S ASSISTANT; OR, KINDERGARTEN SYSTEM OF CHEMISTRY.

A system by which the elements and their valences are represented by illustrations and solid bodies.

BOX AND PAMPHLET COMPLETE, \$2.50.

**WELSH "ABERNANT"
Silica Dinas Fire Brick & Cement.**

Unrivalled for Endurance Under Intense Heat. Percentage of Silica, 95.64.

Also SCOTCH "BLOCHAIRN" FIRE BRICK.

A. T. CHUR,

SOLE AGENT FOR THE UNITED STATES,

Mills Building, Room 14, Fifth Story, New York.

W. H. DOAN,

REFINER OF

NAPHTHA and GASOLINES

ALSO MANUFACTURER OF

A Special Grade of Naphtha for Gas Companies

FOR ENRICHING COAL GAS.

Correspondence solicited,

No. 43 Euclid Avenue, Cleveland, Ohio.

MITCHELL VANCE & CO.,

MANUFACTURERS OF

Chandeliers

and every description of

GAS FIXTURES.

Also manufacturers of Fine Gilt Bronzes and Marble Clocks, warranted best time-keepers. Mantel Ornaments, etc.

Salesrooms, 836 Broadway, N. Y.

Special Designs furnished for Gas Fixtures for Churches, Public Halls, Lodges, etc.

NEWBIGGING'S

Gas Manager's Handbook.

Price, \$4.80.

EVERY GAS MAN SHOULD HAVE ONE.

Orders may be sent to this Office.

JOS. R. THOMAS, C.E.,

May be Consulted on all Matters Relating to Gas Works and Gas Manufacture.

ADDRESS THIS OFFICE.

CAST IRON GAS AND WATER PIPES,

From 2 to 48 Inches in Diameter.

FOX & DRUMMOND,

No. 160 Broadway, New York City.

OFFICE
43 PARK PLACE
WORKS
57.59 AND 61
LEWIS ST.
60.62, 64 & 66
Cannon
ST.
NEW YORK

PROGRESS MACHINE
WORKS
A. & F. BROWN



**Shafting, Pulleys,
HANGERS.**

F. Brown's Patent Friction Clutch.

Send for Illustrated Catalogue and Discount Sheet to

A. & F. BROWN,

No. 43 Park Place, New York City.

Pipe Coverings.

Fireproof, Non-Conducting Coverings for

**STEAM PIPES, BOILERS,
And all Hot Surfaces.**

Made in sections three feet long. Easy to apply; light and cheap.

Asbestos Materials, Fibre, Braided Packing, and Cement. These goods are used at Continental Works, Br'klyn.

CHALMERS-SPENCE COMPANY, 419 & 421 EIGHTH ST., N. Y.

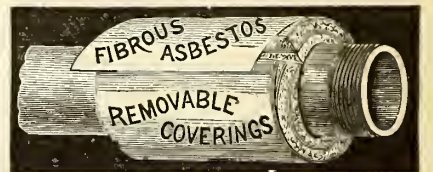

Parson's Steam Blower,

FOR IMPROVING BAD DRAUGHT IN BOILERS, AND FOR BURNING BREEZE OR OTHER WASTE MATERIAL.

PARSON'S TAR BURNER,

FOR UTILIZING COAL TAR AS FUEL.

PARSON'S AIR JET TUBE CLEANER,

FOR CLEANING BOILER TUBES.

These devices are all first-class. They will be sent to any responsible party for trial. No sale unless satisfactory. Manufactured by the WATERTOWN STEAM BLOWER COMPANY.

H. E. PARSON, Supt., 42 PINE ST., N. Y.

Connelly's Automatic Gas Governors, FOR STREET MAINS.

The Only Strictly Automatic Gas Governor in the Market! No Weights! No Clock! No Attention Required!

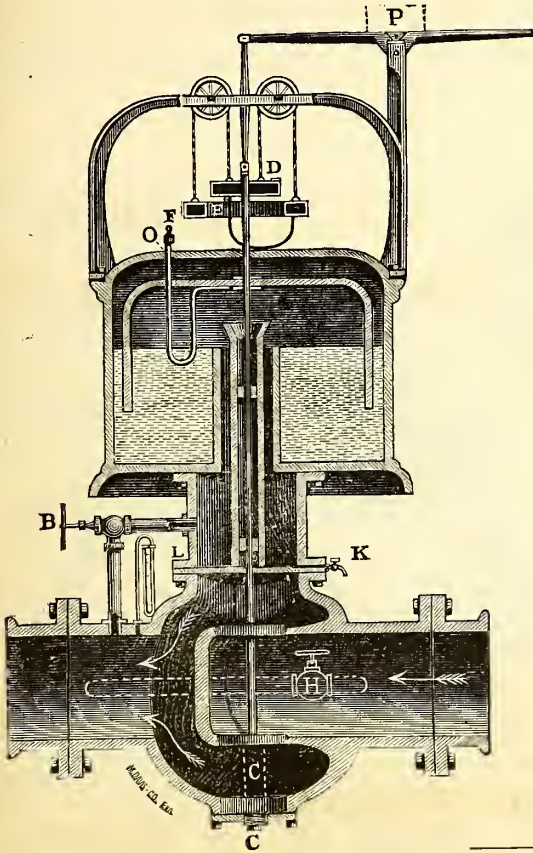

Will respond instantly, WITHOUT VIBRATION, to changing pressure from Telescopic Holders, or to any sudden increase in consumption, however large; which cannot be said of any other Governor. It is this feature that enables us to claim it to be

THE ONLY PERFECT AUTOMATIC GAS GOVERNOR EVER MADE.

It will control and regulate the pressure to suit the variation in consumption with perfect accuracy and absolute reliability. It will respond instantly to any unusual demand during the day or night, increasing volume and pressure together, and reduce same to the minimum as the lights are extinguished. It does away with all necessity for watching changes in the weather, or extra occasions of unusual demand, and insures the pressure being the exact amount required at all times.

We unhesitatingly claim our "Automatic Governors" to fill every requirement. They are simple in construction, cannot get out of order, will not corrode, occupy but little room, and can be placed and adjusted by anyone. They are capable of a wide range of adjustment, and can be set to any maximum and minimum pressure desired.

The accompanying cut shows the pressure held in the Columbus, Ohio, gas mains by one of our 16-inch Governors, the *light line* showing the pressure held during Friday, April 24th, 1885, and the *heavy line* pressure held Saturday, April 25th, 1885; the *two lines* showing the actual service of the Governor under varying demands. The accompanying letter from Mr. McMillin attests its wonderful perfection in very brief terms:

Pressure in Street Mains at Columbus Works.

COLUMBUS GAS LIGHT & COKE Co., }
COLUMBUS, OHIO, April 28, 1885. }
MESSRS. CONNELLY & Co., LIMITED, No. 407
Broadway, New York:

Gentlemen—We have had one of your Automatic Governors in use for some months, and are well pleased with it. No attention is required more than to give it a few drops of oil once a week. The register card it makes clearly indicates the character of the weather, whether clear or cloudy. It puts three or four tenths less pressure on Sunday night than on other nights of the week, and takes the pressure off two or three hours earlier. In other words, *it supplies the demand*—no more and no less. Yours truly,

E. McMILLIN, Superintendent.

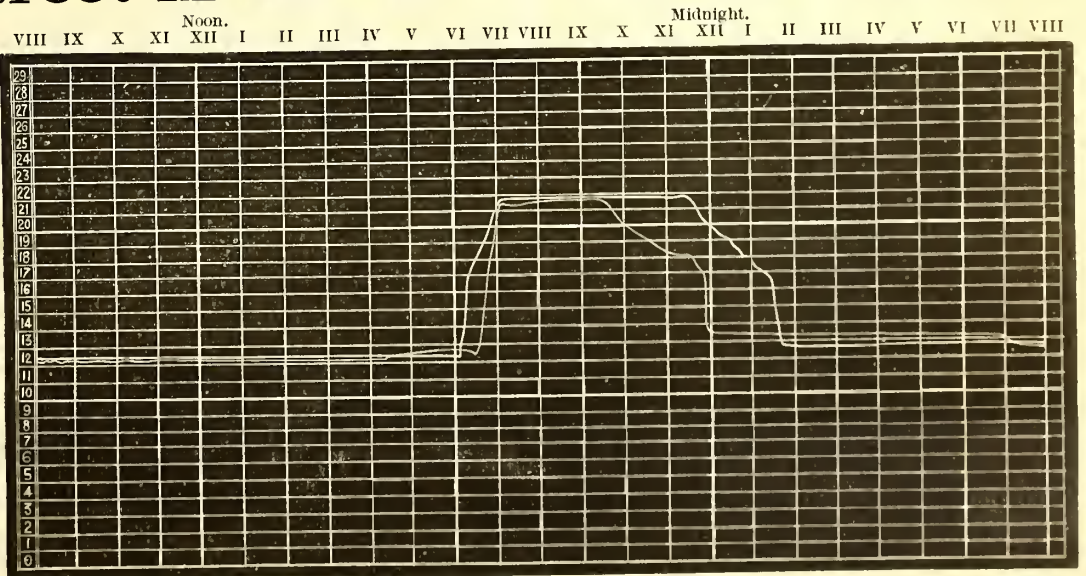

In calling the attention of our friends and patrons to our Automatic Governor we do so in full confidence that it will give most thorough satisfaction, and pay for itself in from one to ten months (depending upon the percentage of leakage), which any manager can easily estimate for himself. Certainly nothing can be placed in a gas works to-day that will pay for itself so soon. Correspondence solicited.

No. 407 Broadway, New York City. **CONNELLY & CO., Limited.** 33d & Smallman Sts., Pittsburgh.
New England Agent, C. H. SPRAGUE, 70 Kilby Street, Boston.

THE CLERK GAS ENGINE.

Highest Award American Institute, New York, 1883. Silver Medal American Institute, N. Y., 1884.

Gold Medal Awarded Crystal Palace Electrical Exhibition, London, 1882.

Highest Award for Motive Power British Section International Exhibition of Electricity, Paris, 1881.

Reliable.
No Boiler.
Steady.
No Coal.
Simple.
No Ashes.
Compact.

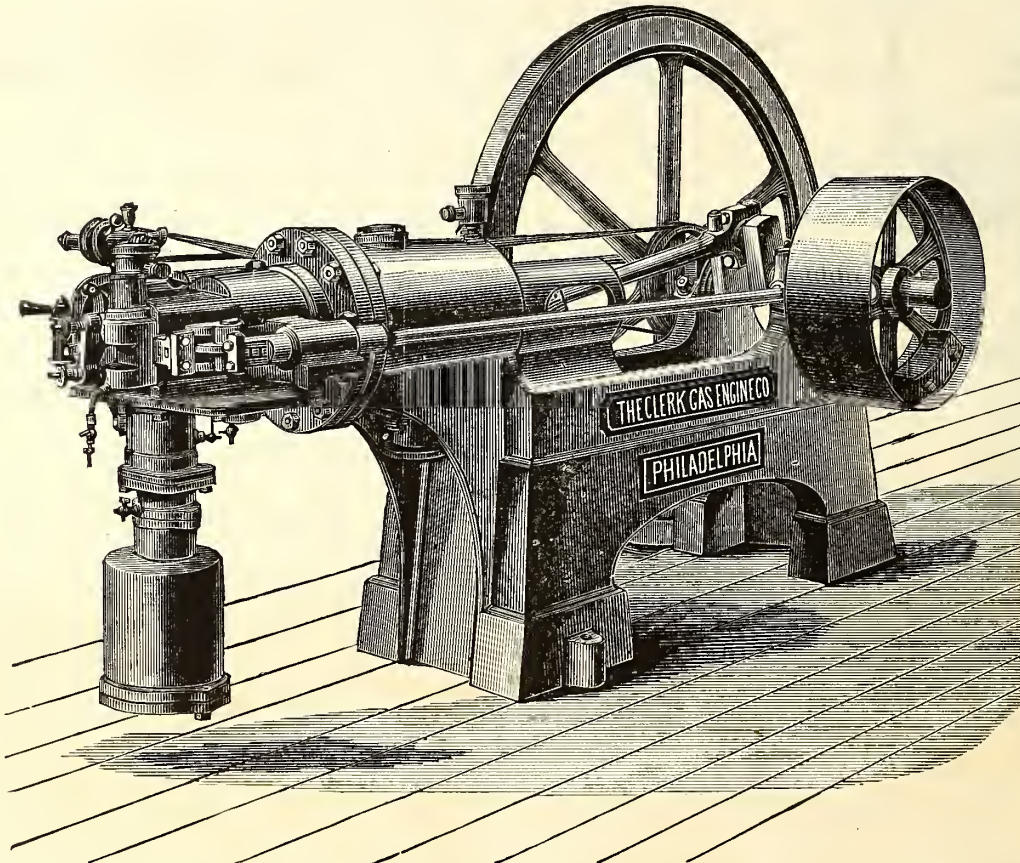

Economical.
No Engineer.
No Explosion
No Gearing
Wheels.
No Danger.
No Parts
requiring
frequent
renewal.

REQUIRING ONLY A MATCH TO START IT--GIVING ITS FULL POWER IMMEDIATELY.

We would inform the public that during the last few months we have improved THE CLERK GAS ENGINE to such an extent that we can now offer an engine vastly superior to our former pattern. These improvements have enabled us to sell our engine at a GREATLY REDUCED FIGURE, partly on account of the decreased weight (our engine weighing about half that of others giving the same Brake H. P). The consumption of gas has been decreased to a considerable extent, and the Brake H. P. has been increased some 25 to 30 per cent. All parts of the old design that were considered defective have been remodeled and new designs added. We now have an engine second to none as regards power, consumption, and ease of working. With our new engine all trouble in starting has been removed, the noise reduced to a minimum, and the regularity of motion is now all that can be desired. We guarantee all we claim for it, and the material and workmanship being of the best, enables us to guarantee the engine for twelve months.

SOLE MAKERS,

THE CLERK GAS ENGINE CO.,

WM. W. GOODWIN, President. E. STEIN, Secretary. S. LEWIS JONES, Asst. Secretary. L. P. GARRET, Supt.

Main Office, 1012-1018 Filbert Street, Philadelphia, Pa.

BRANCH OFFICES,

142 Chambers St., N. Y.

4 West Fourteenth St., N. Y.

76 Dearborn St., Chicago

General Agents,

THE GOODWIN GAS STOVE & METER CO.

Of Philadelphia, New York, and Chicago.

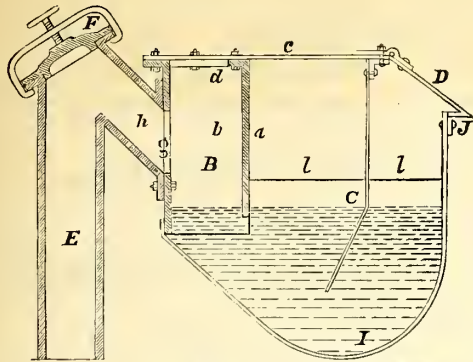

Boardman Hydraulic Main,
Patented October 7, 1884.

For description, see AM. GAS LIGHT JOURNAL of Feb. 2, 1884.
For terms, apply to

A. E. BOARDMAN, Macon, Ga.

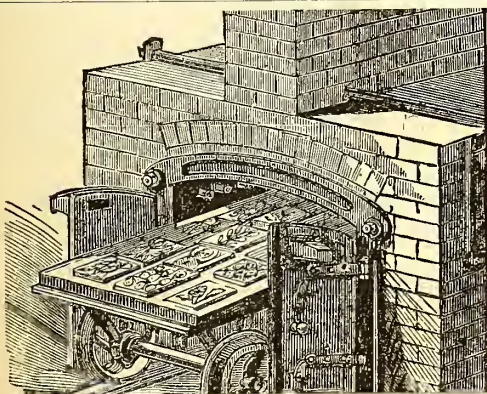

Glass-Staining Gas Kiln.

BAKERS' & CONFECTIONERS' OVENS (PAT.)

Thompson Gas Kiln & Oven Co.

59 Carmine St., N. Y.

Send for Circular by mail.

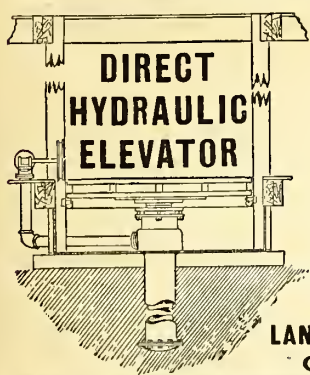

**DIRECT
HYDRAULIC
ELEVATOR**

With Iron or Wood Platform.

Largely used by Leading Gas Co.s for Coal and Coke Lifts.

Adapted for use with city service, or special pumping and accumulator system. For prices address the

LANE & BODLEY CO.,
Cincinnati, O.

**Iron Sponge,
GAS EXHAUSTERS,**

AUTOMATIC GAS GOVERNORS,

CONNELLY & CO., Limited,

No. 407 BROADWAY. NEW YORK CITY.

**The Management of Small
Gas Works.**

BY C. J. R. HUMPHREYS.

Price, \$1.

Orders to be sent to **A. M. CALLENDER & CO.,**
42 PINE STREET, NEW YORK.

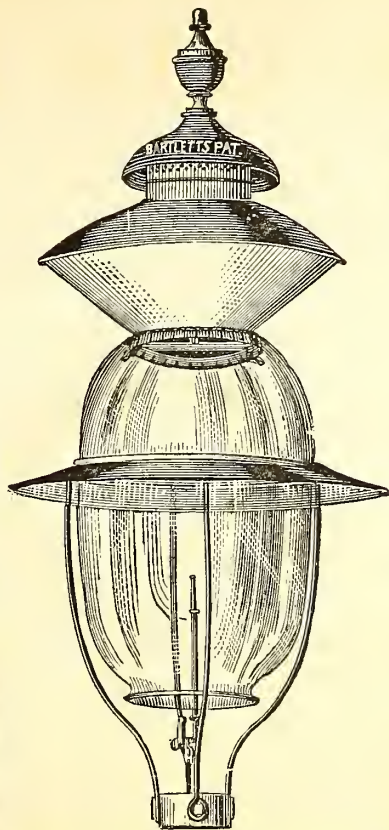

C. BARCALOW, PREST.

J. V. BARCALOW, SEC. & TREAS.

**BARTLETT
Street Lamp Mfg. Co.**

MANUFACTURERS OF

Bartlett's Patent

GLOBE LAMPS.

FOR

**Streets, Parks, Railroad Stations, Public
Buildings, Etc.**

LAMP POSTS A SPECIALTY.

Office and Salesroom,

No. 35 Howard Street, N. Y. City.

Gas Companies and others intending to erect lamps and posts
will do well to communicate with us.

F. M. ROOTS.

S. C. ROOTS

D. T. ROOTS.

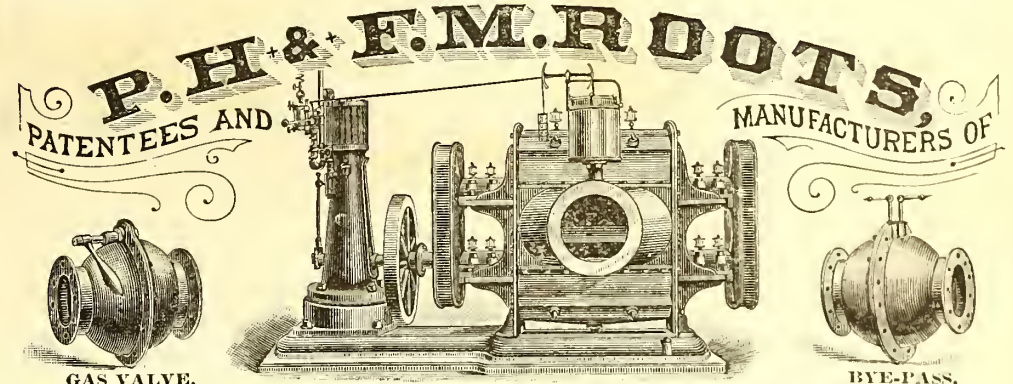

IMPROVED GAS EXHAUSTER,

WITH ENGINE ON SAME BED PLATE, OR WITHOUT.

BYE-PASSES, GAS VALVES, GOVERNORS, ELBOWS, PIPE-FITTINGS, Etc., FURNISHED TO ORDER,

P. H. & F. M. ROOTS, Patentees & Manufacturers, **CONNERSVILLE, IND.**

S. S. TOWNSEND, General Agent, 22 Cortland St. and 9 Dey St., N. Y.

JAS. BEGGS & CO., Selling Agents, 9 Dey St., N. Y.

COOKE & CO., Selling Agents, 22 Cortland St., N. Y.

✧ SEND FOR ILLUSTRATED CATALOGUE AND PRICE LIST. ✧

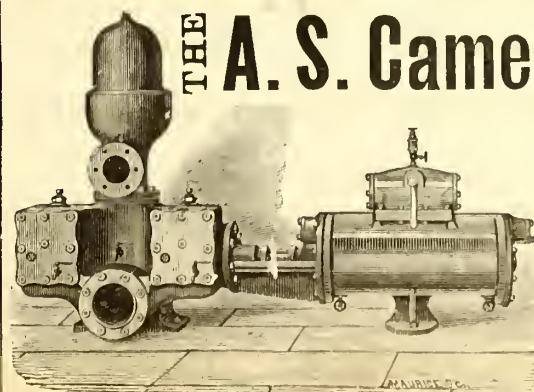

THE A. S. Cameron Steam Pump,

THE STANDARD OF EXCELLENCE.

Upward of 30,000 in Use.

BEST GAS WORKS PUMP

Ever Introduced.

Adapted to Every Possible Duty.

A.S. Cameron Steam Pump Works,

Foot East 23d St., N. Y.

J. H. CAUTIER & CO.,
 CORNER OF
 GREENE AND ESSEX STREETS,
JERSEY CITY, N. J.
 MANUFACTURERS OF
**Clay Gas Retorts,
 Gas House Tiles,
 Fire Bricks, Etc. Etc.**
 Ground Clay, Fire Brick and
 Fire Sand in Barrels,
 J. H. GAUTIER. T. B. GAUTIER.
 C. E. GREGORY. C. E. GAUTIER.

BROOKLYN
Clay Retort & Fire Brick Works,
 (EDWARD D. WHITE & CO.)
 Manufacturers of Clay Retorts, Fire Brick,
 Gas House and other Tile.
 VAN DYKE, ELIZABETH, RICHARDS & PARTITION STS.
 Office, 88 Van Dyke St., Brooklyn, N. Y.

LAGLEDE FIRE BRICK MFG. CO.,
 MANUFACTURERS OF
Fire Brick, Gas Retorts,
 AND
ST. LOUIS STANDARD SEWER PIPE.
 Blast Furnace and Cupola Linings, every description of Fire
 Clay Material, Fire Clay Flue Linings, Chimney Tops
 Dry Milled and Crude Fire Clays, etc.
 OFFICE AND DEPOT
 901, 903, and 905 Pine Street,
 ST. LOUIS, MO.

ESTABLISHED IN 1845.
B. KREISCHER & SONS,
 OFFICE FOOT OF HOUSTON ST., E.R., N.Y.
Gas Retorts,
TILES, FIRE BRICK.
 AND EVERYTHING IN THE FIRE CLAY LINE.

MANHATTAN
FIRE BRICK & ENAMELLED CLAY
RETORT WORKS.
ADAM WEBER.
CLAY GAS RETORTS
AND RETORT SETTINGS
FIRE BRICKS, TILES, ETC.,
 Office and Works, 15th Street and Avenue C., N. Y.

CHICAGO
Retort & Fire Brick Works,
 OFFICE AND FACTORY,
 Clark, Forty-Fifth, and La Salle Streets,
CHICAGO, ILL.
 GEORGE C. HICKS, PRES. PAUL P. AUSTIN, SEC. & TREAS.
STANDARD
Clay Retorts and Settings.
BLOCKS & TILES
 Of every Shape and Size to Order.
Standard Fire Bricks.

JAMES GARDNER, JR.
 Works,
 LOCKPORT STATION, PA.

—ESTABLISHED 1864.—
WILLIAM GARDNER & SON,
 Successor to GARDNER BROTHERS.

WILLIAM GARDNER.
 Office, COAL EXCHANGE,
 PITTSBURGH, PA., P. O. Box 373.

Fire Clay Goods for Gas Works.

C. H. SPRAGUE, No. 70 KILBY STREET, BOSTON, MASS., Agent for the New England States.

OFFICE, 418 to 422 East 23d St., New York.

ESTABLISHED 1856.

WORKS, PERTH AMBOY, NEW JERSEY.

HENRY MAURER,
Excelsior Fire Brick & Clay Retort Works
 CLAY GAS RETORTS, BENCH SETTINGS, FIRE BRICK, TILES, ETC.

STANDARD GAS RETORT AND FIRE BRICK COMPANY,
 J. ANDERSON, PRES. & MANG'R. OF IRONTON, OHIO. C. PETERS, SECRETARY.
Clay Gas Retorts, Fire Brick, and Fire Clay Goods of Every Description.
 Plans of Livesey-Somerville, McIlhenny, and other Furnaces, and Competent Workmen Supplied.



CINCINNATI
Gas Retort & Fire Brick Co.,
 (ESTABLISHED 1872.)
CINCINNATI, OHIO.
 Manufacturers of Gas Retorts, Retort Set-
 ings, Fire Brick, Tiles, Etc.

OAKHILL
GAS RETORT & FIRE BRICK
COMPANY.
PARKER, RUSSELL & CO.
 City Office, 711 Pine Street,
ST. LOUIS, MO.

Our immense establishment is now employed almost entirely in
 the manufacture of
MATERIALS FOR GAS COMPANIES.
 We have studied and perfected three important points. Our re-
 torts are made to stand changes of temperature, the strongest
 heats of the furnace, and the abrasion of feeding and emptying.
 Our customers are in almost every State of the Union, to all of
 whom we refer.

THOS. SMITH, Prest. AUGUST LAMBLA, Vice-Prest. & Sup
BALTIMORE
RETORT & FIRE BRICK CO.
 MANUFACTORY AT
 LOCUST POINT, BALTIMORE, MD.
 Connection with the City by Telephone.
Clay Retorts, Blocks & Tiles,
FIRE BRICK, FIRE CLAY,
AND FIRE CEMENT.

Red and Buff Ornamental Tiles and Chim-
 ney Tops. Drain and Sewer Pipe (from
 2 to 30 inches). Baker Oven Tiles
 12 x 12 x 2 and 10 x 10 x 2.
WALDO BROS., 88 WATER ST., BOSTON, MASS
 Sole Agents for New England States

THE AMERICAN METER CO.,

MANUFACTORIES,

512 West Twenty-second Street, N. Y. Arch and Twenty-second Street, Phila.
Nos. 244 & 246 North Wells Street, Chicago, Ill.

AGENCIES,

No. 177 Elm Street, Cincinnati, Ohio. Nos. 122 & 124 Sutter Street, San Francisco Cal.
No. 810 North Second Street, St. Louis, Mo.

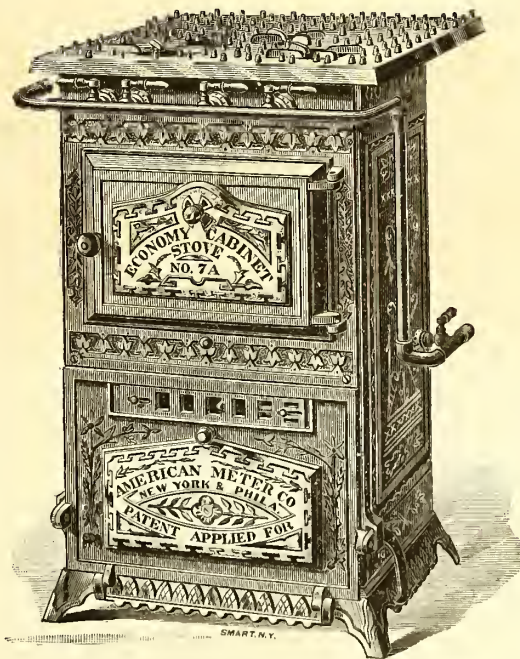

NEW DESIGN STOVES MADE IN CAST IRON, WITH EITHER OPEN OR CLOSED TOPS.

In presenting our "Economy" Gas Cooking Stoves and Ranges for the Season of 1885, we have the pleasure to inform our patrons that the increasing demand for these Stoves has encouraged us to make entirely new patterns, of HIGHLY ORNAMENTAL DESIGNS, for the popular sizes. We have also embraced the opportunity to increase the size of these Stoves, giving greater TOP PLATE AND OVEN capacity.

Full Lists and Catalogues are in preparation, and large stocks of Stoves will be kept at our Manufactories and Agencies for prompt shipment.

AMERICAN METER CO.

A. H. M'NEAL,

BURLINGTON, N. J.

Flange-Pipes

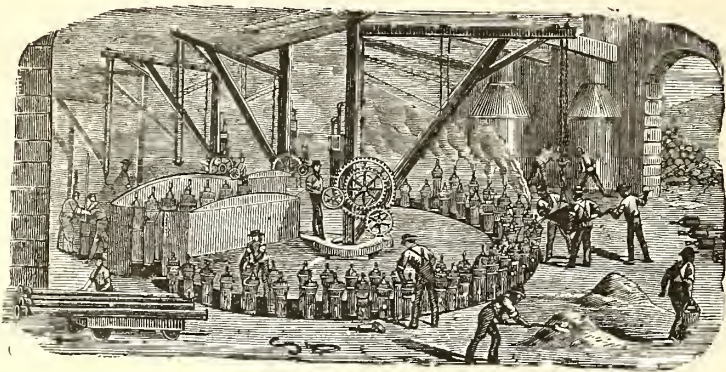

General Foundry Work.

CAST IRON PIPES FOR WATER AND GAS.

JAMES S. MOORE, Pres.
BENJAMIN CHEW, Treas.

JAS. P. MICHELLON, Sec.
WM. SEXTON, Supt.

GLoucester IRON WORKS, GLoucester CITY, N. J.

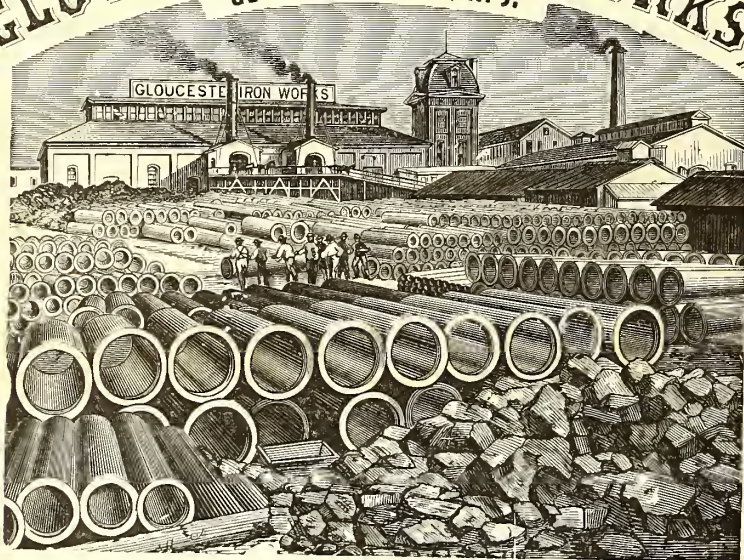

Cast Iron Gas & Water Pipes, Stop Valves, Fire Hydrants, Gasholders, &c.
Office No. 6 North Seventh Street, Philadelphia.

ESTABLISHED 1856.

WARREN FOUNDRY AND MACHINE CO.,

WORKS AT PHILLIPSBURGH, N. J.
NEW YORK OFFICE, 162 BROADWAY.

Cast Iron Water and Gas Pipe

FROM TWO TO FORTY-EIGHT INCHES DIAMETER.
ALSO ALL SIZES OF

FLANGE PIPE for Sugar House and Mine Work.
Branches, Bends, Retorts, Etc., Etc.

436-1

MATTHEW ADDY, President.

W. L. DAVIS, Selling Agent.

GEO. P. WILSHIRE, Sec. & Treas.

Cincinnati and Newport Iron and Pipe Company,

NEWPORT, KY.

Lamp Posts
AND
BENCH CASTINGS

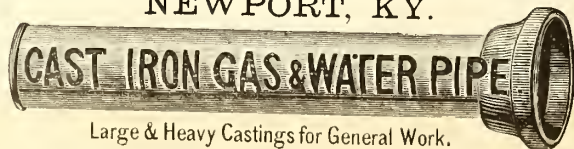

Branch
AND
SPECIAL CASTINGS

A Specialty.

Large & Heavy Castings for General Work.

FOR GAS & WATER CO'S.

Manufacture Pipe from 2 to 48 inches. All work guaranteed first quality.

Mellert Foundry and Machine Co.

Limited. Established 1848.
MANUFACTURERS OF



Specials—Flange Pipe, Valves and Hydrants,
Lamp Posts, Retorts, etc.
Machinery and castings for Furnaces, Rolling Mills, Grist and
Saw Mills, Mining Pumps, Hoists, etc.

GENERAL OFFICE, - - - READING, PA.

LUDLOW VALVE MFG. CO.

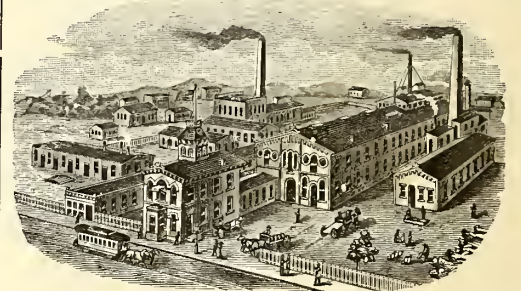

OFFICE AND WORKS,
93S to 954 River Street and 67 to 83 Vail Av.
TROY, N. Y.

Hydraulic Main Dip Regulators, also
Check Valves, Foot Valves, Yard-
wash and Fire Hydrants.
Send for Circulars.

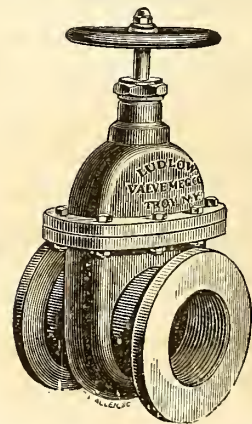

Valves.—Double and Single Gate, 1/2 in. to
48 in., outside and inside Screws. Indica-
tor, etc., for Gas, Water, Steam, and Oil.
Send for Circulars.

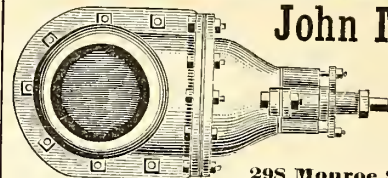

John McLean

Man'facturer of
GAS
VALVES.

29S Monroe Street, N. Y.

PRESERVE

The Journal

BY THE USE OF

THE STRAP FILE.

Advantages of the Strap File.

- 1st. It is simple, strong, and easily used.
- 2d. Preserves papers without punching holes.
- 3d. Will always lie flat open.
- 4th. Allows any paper on file to be taken off without disturbing the others.

Price, \$1.25. Sent either by express or mail, at directed. By mail the postage will be 20 cents, which will be added to the price of the Binder.

A. M. CALLENDER & CO., 42 PINE ST., N. Y.

Siemens's Regenerative Gas Burners, For Lighting and Ventilating.

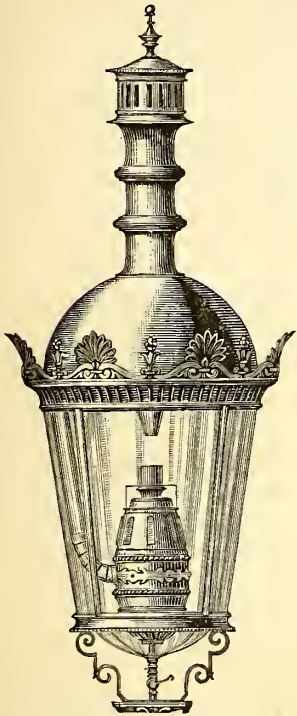

THE CHEAPEST, PUREST, AND MOST BRILLIANT OF ALL GAS LIGHTS.

Superior to the Electric Light in Economy, Beauty, & Steadiness.

SPECIALLY ADAPTED FOR LIGHTING HALLS, FACTORIES, OPEN SPACES, ETC.

Numerous Tests made by various Gas Companies in the United States show an Efficiency of Ten Candle Power per Cubic Foot of Gas.

General Agents:

- SIEMENS LIGHTING CO., 347 West Main St., Louisville, Ky.
- MEYER, MARSHALL & CO., 528 California St., San Francisco.
- DENNEHY, WOLF & O'BRIEN, 85 & 87 Dearborn St. Chicago, Ill.
- WILCOX & McGEARY, - No. 11 Bissel Block, Pittsburgh, Pa.
- T. T. RAMSDALL & CO., - 20 Swan Street, Buffalo, N. Y.
- SIEMENS GAS ILLUMINATING CO.,
Room 6, No. 157 Broadway, New York City.
- W. D. COLT, - - - - 1420 F Street, Washington, D. C.
- JOHN KIEFER, - - - 344 Lawrence, Street, Denver, Col.

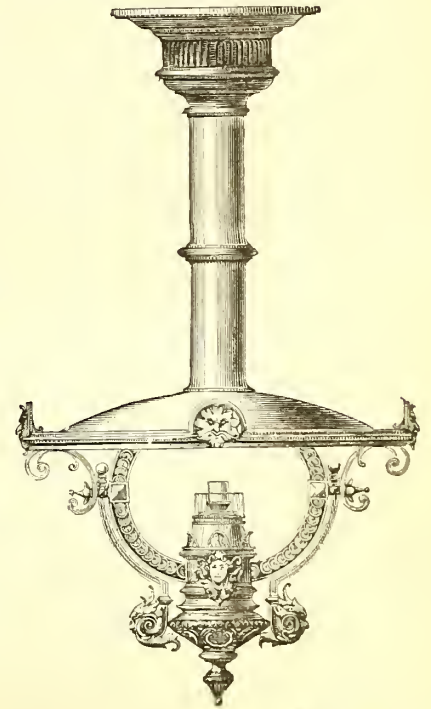

THE SIEMENS REGENERATIVE GAS LAMP COMPANY,
SOLE MAKERS FOR THE UNITED STATES,
N. E. Cor. 21st. St. and Washington Av., Philadelphia, Pa.

THE "STANDARD" WASHER-SCRUBBER, KIRKHAM, HULETT & CHANDLER'S PATENT.

Total Capacity per 24 Hours of "Standard" Washers Ordered During the Following Years.

1877.....	4,000,000 cubic feet.
1878.....	4,750,000 "
1879.....	24,545,000 "
1880.....	42,967,500 "
1881.....	36,462,500 "
1882.....	39,300,000 "
1883.....	57,735,000 "
1884.....	26,177,500 "
Total.....	235,937,500 cubic feet.

Total Number and Capacity per 24 Hours of "Standard" Washers Erected and in Course of Erection in the Several Countries

	Number.	Cubic Feet per Day.
Great Britain..	151	157,070,000
Western Hemisphere.	38	39,337,500
Australia	18	12,150,000
New Zealand	2	650,000
France	6	4,550,000
Belgium	8	5,420,000
Germany	16	8,200,000
Holland	4	4,160,000
Denmark	1	150,000
Russia	2	3,500,000
Spain	1	350,000
India	1	400,000
Total.....	248	235,937,500

**THE CONTINUED POPULARITY
Of these Machines**

Will be recognized from the following extracts from letters from representatives of some of the companies having them in use:

ALLEGHENY GAS WORKS,
ALLEGHENY, PA., Dec. 12, '84. }

MR. GEO. SHEPARD PAGE, New York:

Dear Sir—The "Standard" Washer Scrubber is giving us entire satisfaction. At present we are using one gallon water per thousand cubic feet, and the liquor as it leaves the Scrubber is 8 degrees (16 oz.) by Twaddle's hydrometer.

Yours respectfully,
ROBERT YOUNG, Eng'r.

"Standard" Washers Ordered During the Current Year.

	Cu. Ft. per Day
Anneberg Gas Co.....	200,000
Bombay Gas Co.....	400,000
Brussels Co.....	1,250,000
Chemnitz Gas Co	1,000,000
CITIZENS GAS CO., BUFFALO.....	750,000
Coke Works in Zabre, Ober-Schlesien	1,500,000
Cokerel der Friedenshutte, Upper Silesia.	1,000,000
Dumfries Corporation.....	250,000
Dunedin Gas Co., New Zealand	400,000
King's Lynn Gas Co	300,000
Leiden, Holland.....	400,000
Lincoln Gas Co.....	400,000
Liverpool Gas Co	2,000,000
" "	3,000,000
LOUISVILLE GAS CO.....	1,500,000
Namen Gas Co.....	100,000
PITTSBURGH GAS CO.....	1,500,000
PORTLAND GAS CO., OREGON	562,500
SAN FRANCISCO GAS CO.....	4,000,000
Sheepbridge	40,000
ST. LOUIS GAS CO.	2,000,000
Sydney Gas Co.....	2,500,000
WASHINGTON, D. C. GAS CO.....	2,000,000
Whitechurch Gas Co	175,000
Total.....	26,177,500

GEO. SHEPARD PAGE, No. 69 WALL STREET, NEW YORK,
SOLE AGENT FOR THE WESTERN HEMISPHERE.

R. D. WOOD & CO.,

400 Chestnut Street, Phila., Pa.

Cast Iron Gas & Water Pipe, Water Machinery & Gas Apparatus

Cast Iron Pipe, Fire Hydrants, Eddy Valves, Lamp Posts, Large Loam Castings, Flanged Pipe, Sugar House Work, Iron Roofs and Floors, Wrought & Cast Iron Tanks, Turbine Water Wheels and Pumps.

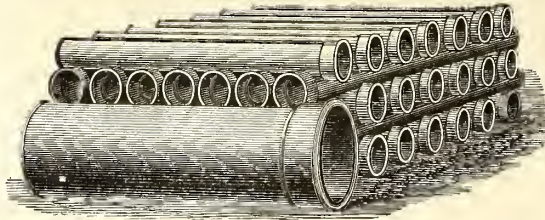

Casholders, Lime Trays, Center Valves, Purifiers, Bench Work, Exhausters, Condensers, Governors, Scrubbers, Gas Valves, Station Meters, Cast Iron Pipe Fittings.

Manufacturers of Heavy Castings and Machinery of Every Description.

ENGINEERS & CONTRACTORS FOR THE ERECTION OF GAS WORKS, & ALL MACHINERY CONNECTED THEREWITH

Estimates and specifications furnished for erection of new works or the extension or alteration of old ones.

Foundries and Works. - - Millville, Florence, and Camden, N. J.

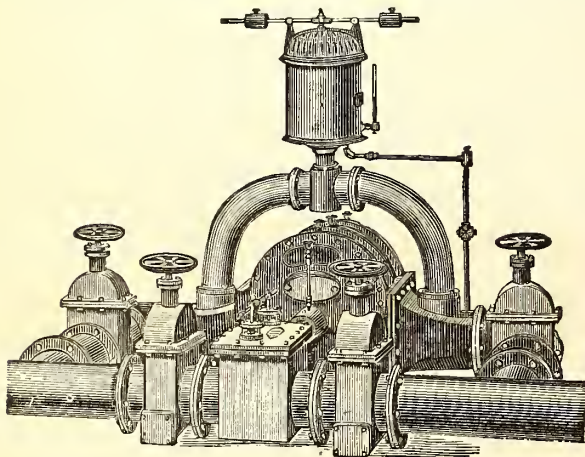

SMITH & SAYRE MFG. COMPANY,

G. G. PORTER, Prest.

245 Broadway, N. Y.

CHAS. W. ISBELL, Sec'y.

Machinery & Apparatus for Gas Works

Drawings, Plans, and Estimates Furnished for the Improvement, Extension, or Alteration of Gas Works, or for the Construction of New Works.

Mackenzie's Patent Rotary and Steam Jet Gas Exhausters, Governors, Compensators, Condensers, Washers, Scrubbers. Isbell's Patent Automatic Street Pressure Governor, Gas and Water Valves, Hydraulic Main Dip Regulator, Bench Castings, etc. Purifying Boxes and "Standard" Scrubbers. Isbell's Patent Self-Sealing Retort Doors.

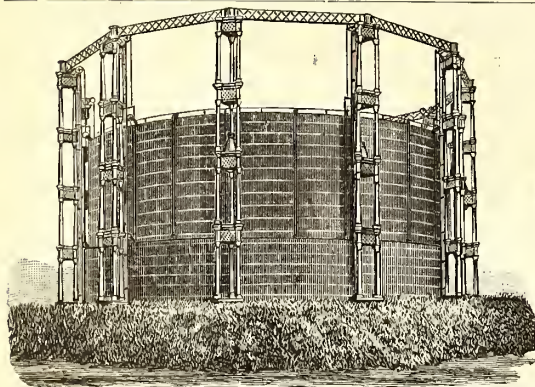

W. E. Tanner, Pres., W. R. Trigg, V.-Pres., A. Delaney, Supt.

Tanner & Delaney Engine Co.
RICHMOND, VA.

Gas Apparatus,

INCLUDING

Condensers of various styles, Scrubbers, Holders, Purifiers, Castings for Retort Houses, Etc.

ALSO STEAM ENGINES AND BOILERS.

Plans, Specifications and Estimates Furnished.

MORRIS, TASKER & CO.,

Limited,

Builders of Gas Works,

PHILADELPHIA, PA.

To Gas Companies.

We make to order **CAP BURNERS** to burn any amount under a stated pressure. Send for samples.

Also, **SERVICE CLEANERS, DRIP PUMPS, and STREET MAIN PROVING APPARATUS.**

C. A. GEFRORER,

248 N. 8th Street, Phila., Pa.

SOUTHWARK FOUNDRY AND MACHINE COMPANY,

Successors to MERRICK & SONS. Established in 1836.

No. 430 Washington Avenue, Philadelphia, Pa.

MANUFACTURERS OF

Single and Telescopic Gasholders,

BENCH CASTINGS,

Washers, Scrubbers, Condensers, Purifiers,

And all apparatus necessary for the construction of improved new gas works and in the extension of established works. Also manufacturers of

Gas Engines, and of all descriptions of Steam and Hydraulic Machinery, and of Boiler and Tank Work.

Plans, specifications, and estimates furnished promptly on application.

WM. HENRY WHITE,

Consulting & Constructing

Gas Engineer & Contractor.

ESTIMATES, PLANS, AND SPECIFICATIONS FURNISHED FOR NEW WORKS OR EXTENSIONS OF EXISTING WORKS.

32 Pine St., New York City.

Correspondence solicited.

KERR MURRAY MFG. CO.,

MANUFACTURERS OF

Single Lift and Telescopic

GASHOLDERS.

Built, 1884:

Altoona, Pa.	Capacity, 160,000 cubic feet.
Pittsburgh, Pa.	250,000 "
"	230,000 "
Bellaire, Ohio.	50,000 "
Youngstown, Ohio.	60,000 "
Canton, "	60,000 "
Akron, "	80,000 "
Xenia, "	10,000 "
Adrian, Mich.	65,000 "
Ypsilanti, Mich.	25,000 "
Muskegon, "	70,000 "
South Bend, Ind.	70,000 "
Anderson, "	20,000 "
Plainfield, "	10,000 "
Springfield, Illinois.	100,000 "
Evanston, "	50,000 "
Freeport, "	35,000 "
Elgin, "	60,000 "
Sheboygan Wis.	20,000 "
Key West Fla.	10,000 "

Plans and estimates furnished for the erection of new and the rebuilding of old works. Address

Kerr Murray Mfg. Co.,
FORT WAYNE, IND.

JAMES R. FLOYD,

(SUCCESSOR TO HERRING & FLOYD)

Oregon Iron Works,

531 to 543 West 20th St., N. Y.

Practical Builders of Gas Works

MANUFACTURERS OF

ALL KINDS OF CASTINGS

AND

APPARATUS FOR GAS-WORKS.

BENCH CASTINGS

from benches of one to six Retorts each.

WASHERS: MULTITUBULAR AND AIR CONDENSERS; CONDENSERS; SCRUBBERS

wet and dry), and

EXHAUSTERS

for relieving Retorts from pressure.

BENDS and BRANCHES

of all sizes and description.

FLOYD'S PATENT

MALLEABLE RETORT LID.

PATENT

SELF-SEALING RETORT LIDS.

FARMER'S

PATENT BY-PASS DIP-PIPE.

SABBATON'S PATENT

FURNACE DOOR AND FRAME.

BUTLER'S

COKE SCREENING SHOVELS.

GAS GOVERNORS,

and everything connected with well regulated Gas Works at low price, and in complete order.

SELLER'S CEMENT

for stopping leaks in Retorts.

N. B.—STOP VALVES from three to thirty inches—at very low prices.

Plans, Specifications, and Estimates furnished.

CONTINENTAL WORKS.

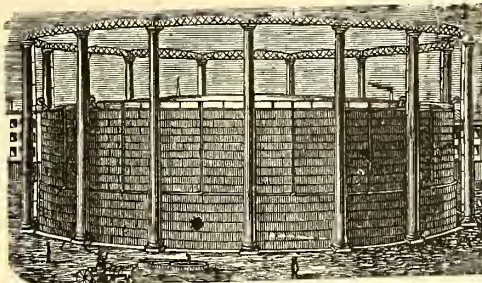

GASHOLDERS OF ANY MAGNITUDE.

T. F. ROWLAND, Proprietor,
GREENPOINT, BROOKLYN, N. Y.
ENGINEER AND MANUFACTURER OF
GAS-HOLDERS.
CONDENSERS, SCRUBBERS, VALVES,
PURIFIERS, RETORTS, and HY-
DRAULIC MAINS,

and all other articles connected with the Manufacture and Distribution of Gas. Plans and Specifications prepared and Proposals given for the necessary Plant for Lighting Cities, Towns, Mansions, and Manufactories.

H. RANSHAW, Prest. & Mangr. WM. STACEY, Vice-Pres. T. H. BIRCH, Asst. Mangr. R. J. TARVIN, Sec. & Treas.

STACEY MFG. CO.,

MANUFACTURERS OF

Single and Telescopic Gasholders,

IRON ROOFS, BRIDGES, LAMP POSTS,

Water and Oil Tanks, Coal Elevator Cars,

COKE CRUSHERS, BENCH CASTINGS,

And all kinds of Wrought and Cast Iron Work used in the erection of Coal and Oil Gas Works. Rolling Mill Machinery and Heavy Castings a Specialty.

Foundry:
33, 35, 37 & 39 Mill Street.

Wrought Iron Works:
16, 18, 20, 22, 24 & 26 Ramsey Street.

Cincinnati, Ohio.

BARTLETT, HAYWARD & CO.,

Office, 24 Light.

BALTIMORE, MD.

Works, Pratt &

PURIFIERS.

Roofs.

Bench Castings.

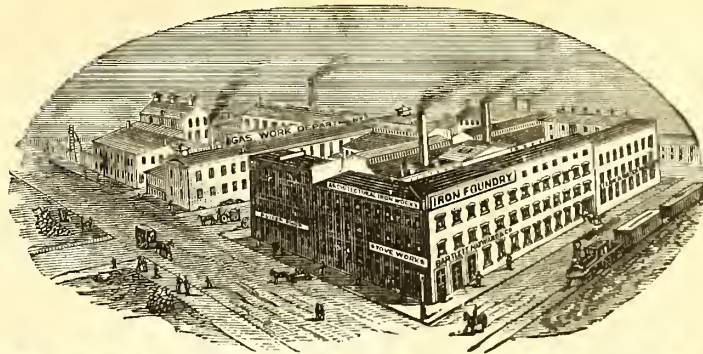

SCRUBBERS.

BOILERS.

CONDENSERS.

GASHOLDERS.

CONSTRUCTING ENGINEERS AND BUILDERS OF GAS WORKS.

1842. **DEILY & FOWLER,** 1884.

Laurel Iron Works.

Address, No. 39 Laurel Street, Philadelphia, Pa.

MANUFACTURERS OF

GASHOLDERS,

Single or Telescopic, with Cast or Wrought Iron Guide Frames.

Holders Built Since 1880:

Mount Joy, Pa.	West Point, N. Y.	Galveston, Texas (2d.)	Kalamazoo, Mich. (3d.)	Newport, R. I.
Rockaway B'ch, N. Y. (2)	Fitchburgh, Mass.	Marlboro, Mass.	Glen Island, N. Y.	Portland, Oregon.
Zanesville, O. (2d.)	New London, Conn.	Denver, Col.	Warren, Ohio.	Allegheny, Pa. (3d.)
Lancaster, O.	Derby, Conn.	Chicago, Ill. (West Side)	Bath, N. Y.	Atlanta, Ga. (2d.)
Blackwell's Island N. Y.	Bridgeport, Conn.	Pittsburgh, Pa. (S. Side)	Lynn, Mass.	N. Y. City (Central Ga)
Waltham, Mass. (1st.)	Allegheny, Pa. (1st.)	Pawtucket, R. I.	New Bedford, Mass.	Lynchburg, Va. (2d.)
Dorchester, Mass.	St. Hyacinth, Can.	Brookline, Mass.	Waterbury, Conn.	Saylesville, R. I.
Wheeling, West Va.	Norwalk, O.	Sherbrooke, Can.	Deseronto, Can.	Rondout, N. Y.
Lansing, Mich.	Brattleboro, Vt.	Burlington, N. J. (2d.)	Hoosic Falls, N. Y. (2d.)	Atlantic City, N. J.
Flint, Mich.	Waltham, Mass. (2d.)	Bridgeton, N. J.	Bethlehem, Pa.	Augusta, Ga.
Galveston, Texas (1st.)	West Chester, Pa.	Bay City, Mich.	Atlanta, Ga. (1st.)	Waltham, Mass. (2)
Milton, Pa.	Baltimore, Md.	Eric, Pa.	Savannah, Ga.	
Scranton, Pa.	Holidaysburg, Pa.	Jackson, Mich.	Montgomery, Ala	

GAS COALS.

GAS COALS.

GAS COALS.

JAMES D. PERKINS.

PERKINS & CO.,

F. SEAVERNS.

General Sales Agents for

**The Youghioghenny River Coal Company's
OCEAN MINE YOUGHIOGHENY GAS COAL.**

The Coal from the Ocean Mine (recently operated by Messrs. W. L. Scott & Co., of Erie, Pa.,) is now used by all the leading Gas Companies in the United States from Maine to Texas, and is recognized as *the only reliable Youghioghenny Gas Coal.* (See Map on p. 87 of this Journal, Feb. 16, 1885.)

P. O. Box 3695,
New York.

PERKINS & CO., 228 and 229 N. Y. Produce Exchange

**BEAVER STREET
ENTRANCE.**

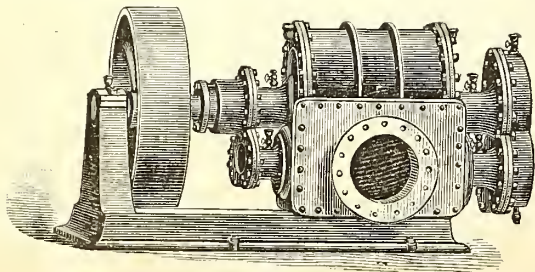

Gas Exhauster Driven by Belt.

The Wilbraham Gas Exhauster,
"BAKER SYSTEM,"

WITH ENGINE ATTACHED, ON SAME BED PLATE OR WITHOUT.
Best, Cheapest and Most Durable Exhauster known.

WILBRAHAM BROS.,

No. 2320 Frankford Avenue, Philadelphia, Pa.

F. J. DAVIS & J. R. FARNUM,

TRUSTEES AND AGENTS FOR THE

SINUOUS FRICTION CONDENSER.

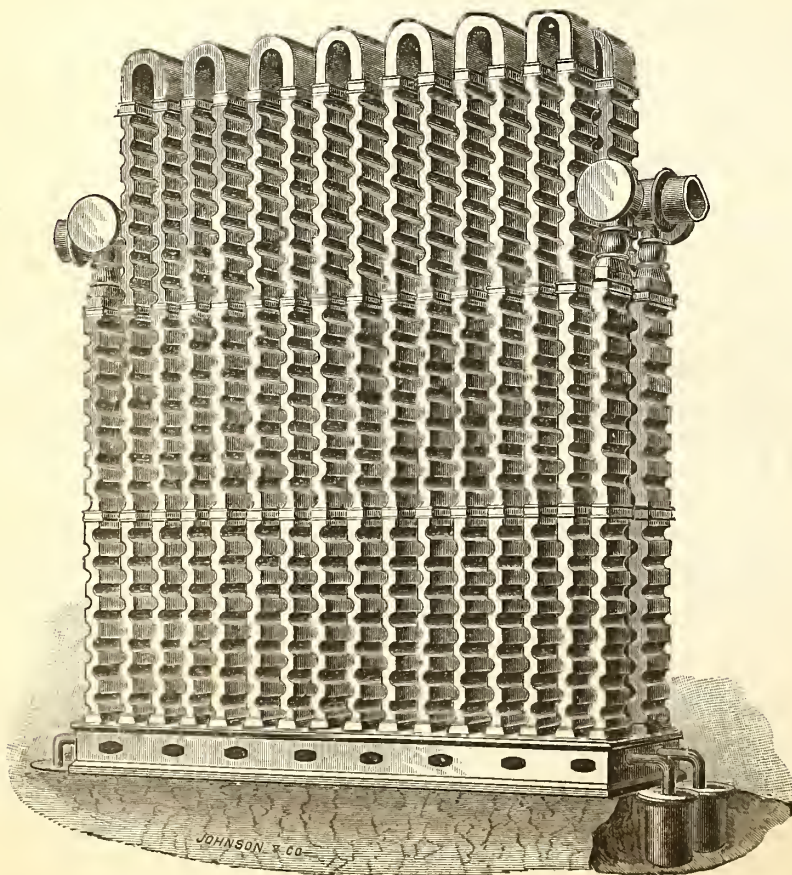

We desire to draw the attention of the gas community to the merits of the **SINUOUS FRICTION CONDENSER.** Companies intending to introduce new condensers into their works will do well to confer with us and examine plans and estimates before contracting for any other pattern. The **FRICTION CONDENSER** is now in use at the gas works located in the following places:

- | | | | |
|--------------------------------|------------------|-------------------------------|---------------------|
| Portland, Me. | Brookline, Mass. | Pawtucket, R. I. | Frederickton, N. B. |
| Newport, R. I. | Chelsea, Mass. | Jamaica Plain, Mass. | St. John, N. B. |
| Gloucester, Mass. | Woburn, Mass. | Attleboro, Mass. | Paterson, N. J. |
| Newton & Water-
town, Mass. | Peoria, Ill. | Calais, Me. | Dover, N. H. |
| | Clinton, Mass. | Fall River, Mass. | Waltham, Mass. |
| | | Nassau Works, Brooklyn, N. Y. | |

DAVIS & FARNUM MFG. CO.

MANUFACTURERS OF

Gas and Water Pipes,

AND

GAS AND WATER MACHINERY

OF THE MOST APPROVED PATTERN.

Also, Gasholders and Iron Roofing.

Orders from Gas and Water Companies promptly attended to.

WALTHAM, MASS.

Boston Office, Room 55, Mason Building, 70 Kilby Street.

GAS COALS.

GAS COALS.

GAS COALS,

Newburgh Orrel Coal Co.,

MINERS AND SHIPPERS OF

**Newburgh Orrel, Tyrconnell
and Palatine Gas Coals.**

ALSO SHIPPERS OF FOUNDRY COKE.

Mines Situated at

Newburgh, Flemington & Fairmont, W. Va.

HOME OFFICE,

25 S. Gay St., Baltimore.

**CHARLES MACKALL,
MANAGER.**

CHAS. W. HAYS, Agent in New York,

Room 92, WASHINGTON BUILDING, No. 1 Broadway.

Shipping wharves at Locust Point. References furnished when required. Special attention given to chartering vessels.

THE DESPARD COAL COMPANY

OFFER THEIR SUPERIOR

DESPARD COAL

To Gas Light Companies and Manufacturers of Fire Clay Goods
Throughout the Country.

ROUSSEL & HICKS, } AGENTS. { BANGS & HORTON,
71 Broadway, N. Y. } 16 Kilby St., Boston.

Mines in Harrison Co., West Va. Wharves, Locust Point, Balt.

Company's Office, 15 German St., Baltimore, Md.

Among the consumers of Despard Coal we name: Manhattan
Gas Light Co., N. Y.; Metropolitan Gas Light Co., N. Y.; Jersey
City, (N. J.) Gas Light Co.; Washington (D. C.) Gas Light Co.;
Portland (Maine) Gas Light Co. Reference to them is requested.

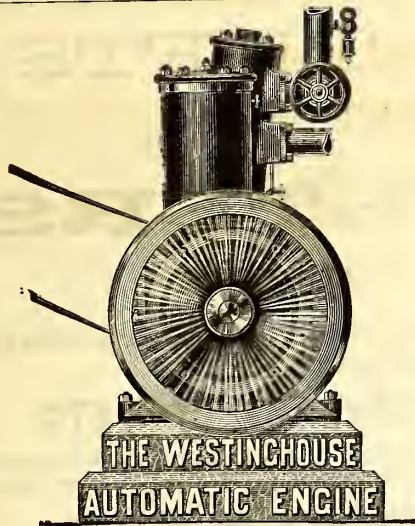

1,500 Engines Now in Use.

Our capacity being now equal to 100 Engines per
month, we shall hereafter keep in stock for immediate
shipment all sizes from 4 to 200 H.P.

SEND FOR ILLUSTRATED CIRCULAR AND REFERENCE LIST.

**Westinghouse Machine Co.,
PITTSBURCH, PA.**

SALES DEPARTMENT CONDUCTED BY

Westinghouse, Church, Kerr & Co., 17 Cortlandt
Street, New York City.

Fairbanks, Morse & Co., Chicago, Cincinnati, Cleve-
land, Louisville, and St. Paul.

Fairbanks & Co., St. Louis, Indianapolis, and Denver.

Parke & Lacy, San Francisco, and Portland, Or.

Parke, Lacy & Co., Salt Lake City, Utah, and Butte,
Montana.

D. A. Tompkins & Co., Charlotte, N. C.

Keating Implement & Machine Co., Dallas, Texas

Imray & Co., Sydney and Melbourne, Australia.

Robert Middleton, Mobile, Ala.

H. Dudley Coleman, 9 Perdido St., New Orleans, La.

B. Rogers, 43 Rue Laflitte, Paris.

**THE
PENN GAS COAL CO.**

OFFER THEIR

Coal, Carefully Screened & Prepared for Gas Purposes.

Their Property is located in the Youghiogheny Coal Basin, near Irwin and Penn Stations on the
Pennsylvania Railroad, and on the Youghiogheny River.

Principal Office:

209 SOUTH THIRD STREET, PHILA., PA.

Points of Shipment:

Pennsylvania Railroad Piers; Greenwich Wharves, Delaware
River; Pier No. 1 (Lower Side), South Amboy, N. J.

Chesapeake & Ohio Railway Coal Agency,

FOR THE SALE OF THE

**Superior Kanawha Gas Coals, Cannelton Cannel,
Also, SPLINT AND STEAM COALS,**

From the Kanawha and New River Regions, on the line of the Chesapeake & Ohio R'way.

C. B. ORCUTT, Sales Agent. | OFFICE, 150 BROADWAY, N. Y.

FRANCIS H. JACKSON, PRESIDENT.

EDMUND H. MCCULLOUGH, SEC. & TREAS.

THE WESTMORELAND COAL CO.

Chartered 1854.

Mines situated on the Pennsylvania and the Baltimore
and Ohio Railroads, in Westmoreland County, Penn.

POINTS OF SHIPMENT:

PHILADELPHIA, BALTIMORE, SOUTH AMBOY, N. J.
WATKINS (SENECA LAKE), N. Y.

Since the commencement of operations by this Company its well-known
Coal has been largely used by the Gas Companies of New England and the
Middle States, and its character is established as having no superior in gas-
giving qualities, and in freedom from sulphur and other impurities.

Principal Office, 224 South 3d St., Phila., Pa.

The Bower Gas Lamp.

The Perfected Duplex-Regenerative Gas Burner, under
the combined Patents of Anthony S. Bower,
Geo. S. Grimston, and Thos. Thorp.

The First Gold Medal awarded at the Crystal Palace Exhibition in
London, and two Gold Medals at the Stockport (Eng.) Exhibition of Gas
Appliances. Both in 1883.

GEO. SHEPARD PAGE, JOHN BOWER,
69 Wall Street, N. Y. City.

The Management of Small Gas Works.

By C. J. R. HUMPHREYS. Price, \$1.

A. M. CALLENDER & CO., 42 Pine St., N. Y.



INTERNATIONAL--1876--EXHIBITION.

The U. S. Centennial Commission.

HAVE DECREED AN AWARD TO

HARRIS, GRIFFIN & CO.,

12th and Brown Sts., Philadelphia, and 49 Dey St., N. Y., U. S. A.,

FOR THE FOLLOWING REASONS:

The Exhibit consists of a Series of METERS from the Largest Size Station Meters for the use of the MANUFACTURE OF GAS, to those for the use of the ORDINARY CONSUMER. The Instruments are WELL MADE, RELIABLE as to INDICATION, and embody a number of sundry improvements which, with the general character of the Exhibit, entitle the whole to commendation.

Attest—J. L. CAMPBELL,
Secretary, pro-tem.

Signed—A. T. GOSHORN,
Director General

J. B. HAWLEY,
President.

CHARLES E. DICKEY.

JAMES B. SMALLWOOD.

CHARLES H. DICKEY.

Maryland Meter and Manufacturing Co.,

DICKEY, TANSLEY & CO.,

Established 1866.

Nos. 22 and 24 Saratoga Street, Baltimore, Md.

No. 46 La Salle St., Chicago, Ill.

MANUFACTURERS OF

DRY GAS METERS, STATION METERS, GLAZED METERS, TEST METERS, METER PROVERS, PRESSURE AND VACUUM REGISTERS, GOVERNORS, INDICATORS, SERVICE AND METER COCKS, AND METER CONNECTIONS.



Dry Gas Meter.

With 39 years' experience and the best facilities for manufacturing, is enabled to furnish reliable work and answer orders promptly.

NATHANIEL TUFTS,

No. 153 Franklin Street, Boston, Mass.,

MANUFACTURER OF

DRY GAS METERS.

Station Meters of any Capacity.

Test and Experimental Meters, Pressure Registers, Pressure Gauges, Pressure and Vacuum Gauges.

METER PROVERS, PHOTOMETERS, STREET LANTERNS, ETC., ETC.

Patent Cluster Lanterns for Street Illumination.

SCIENTIFIC BOOKS.

We are prepared to furnish to Gas Managers, and others interested in the topics treated of, the following books, at prices named:

KING'S TREATISE ON THE MANUFACTURE OF COAL GAS. Three vols.; \$10 per vol.	GAS CONSUMER'S MANUAL, by E. S. CATHELS, C.E. 10 cts.	A PRACTICAL TREATISE ON GAS AND VENTILATION, with Special Relation to Illuminating, Heating, and Cooking by Gas, by E. E. PERKINS. \$1.25.
GAS MANUFACTURE, by WILLIAM RICHARDS. 4to., with numerous Engravings and Plates, in Cloth binding. \$12.	PRACTICAL TREATISE ON HEAT, by THOMAS BOX. Second edition. \$5.	PURIFICATION OF COAL GAS, by R. P. SPICE. 8vo. \$3.
THE GAS ANALYST'S MANUAL, by F. W. HARTLEY. \$2.50.	GAS WORKS—THEIR ARRANGEMENT, CONSTRUCTION, PLANT, AND MACHINERY. \$8.	HOW TO MANAGE GAS, by F. WILKINS. Paper. 20 cents.
ANALYSIS, TECHNICAL VALUATION, PURIFICATION, and USE OF COAL GAS, by REV. W. R. BOWDITCH, M.A.; with Engravings; 8vo., Cloth. \$4 50.	COAL; ITS HISTORY AND USE, by PROF. THORPE. \$3.50.	THE GAS MANAGER IN THE LABORATORY, by a Practical Student. 8vo., Cloth. \$1.50.
GAS MEASUREMENT AND GAS METER TESTING by F. W. HARTLEY. \$1.60	THE GAS WORKS OF LONDON, by COLBURN. 60 cents.	THE DOMESTIC USES OF COAL GAS, AS APPLIED TO LIGHTING, by W. SUGG. \$1.40.
GAS CONSUMER'S HANDBOOK, by WILLIAM RICHARDS, C.E.; 18mo., Sewed. 20 cents.	THE GAS FITTER'S GUIDE, Showing the Principles and Practice of Lighting with Coal Gas, by JOHN ELDRIDGE. 40 cents.	DISTILLATION OF COAL TAR AND AMMONIACAL LIQUOR, by GEO. LUNGE. \$8.50.
	GAS WORKS, AND MANUFACTURING COAL GAS, HUGHES. \$1.80.	A TREATISE ON THE COMPARATIVE COMMERCIAL VALUES OF GAS COALS AND CANNELS, by D. A. GRAHAM. 8vo., Cloth. \$3.
	THE MANAGEMENT OF SMALL GAS WORKS, by C. J. R. HUMPHREYS. \$1.	

The above will be forwarded by express, upon receipt of price. We take especial pains in securing and forwarding any other Works that may be desired, upon receipt of order. All remittances should be made by check, draft, or post office money order.

A. M. CALLENDER & CO., No. 42 Pine Street, New York,

T. C. HOPPER, Pres. G. J. McGOURKEY, Vice-Pres. (New York). WM. N. MILLSTED, Gen. Supt. & Treas. (New York). WM. H. DOWN Sec.

AMERICAN METER COMPANY,

WET AND DRY GAS METERS. STATION METERS. EXHAUSTER GOVERNORS. DRY CENTRE VALVES. GOVERNORS FOR GAS WORKS. PRESSURE REGISTERS. PRESSURE & VACUUM REGISTERS. PRESSURE & VACUUM GAUGES. ORESSON GAS REGULATORS. MARSLAND WATER METERS. METER PROVERS. PORTABLE TEST METERS. EXPERIMENTAL METERS. AMMONIA TEST METERS. BAR AND JET PHOTOMETERS.

<p>Manufactories: 512 W. 22d St., N. Y. Arch & 22d Sts., Phila.</p>	<p>GAS STOVES, SUGG'S "STANDARD" ARGAND BURNERS, SUGG'S ILLUMINATING POWER METER, Wet Meters, with Lizar's "Invariable Measuring" Drum.</p>	<p>Agencies: 177 Elm Street, Cincinnati. 244 & 246 N. Wells Street, Chicago. 810 North Second Street, St. Louis. 122 & 124 Sutter St., San Francisco.</p>
--	--	--

HELME & McILHENNY,

(Successors to Harris & Brother. Established 1848.)

GAS METER MANUFACTURERS,

CONTINUE AS HERETOFORE AT THE OLD ESTABLISHMENT,

Nos. 1115 and 1117 Cherry Street, Philadelphia, Pa.,

To Manufacture Wet and Dry Gas Meters, Station Meters, Experimental Meters, Meter Provers, Center Seals, Pressure Registers, GOVERNORS, INDICATORS, PHOTOMETERS, & ALL OTHER KINDS OF APPARATUS FOR USE IN GAS WORKS.

From our long practical experience of the business, and from our personal supervision of all work, we can guarantee all orders to be executed promptly, and in every respect satisfactorily.

WM. WALLACE GOODWIN, Prest. and Treas. WM. H. MERRICK, V.-Prest. S. L. JONES, Sec. S. V. MERRICK, Supt.

THE GOODWIN GAS STOVE AND METER COMPANY,

Successors to W. W. GOODWIN & CO.

1012, 1014 and 1016 Filbert St., Phila., Pa. 142 Chambers St., New York.
76 Dearborn St., Chicago, Ill.

WALDO BROS., Agents, 88 Water St., Boston.

MANUFACTURERS OF THE "SUN DIAL" GAS STOVES, FOR COOKING AND HEATING PURPOSES.

Dry and Wet GAS METERS, Station Meters (Square, Cylindrical or in Staves) Glazed Meters, King's and Sugg's Experimental Meters, Lamp Post Meters, Etc., Meter Provers (sizes 2, 5 and 10 feet), Pressure Guages of all kinds, Pressure Registers, Pressure and Vacuum Registers, Pressure Indicators (sizes 4 inch, 6 inch and 9 inch), King's Pressure and Vacuum Gauges, Dry and Wet Centre Seals, Dry and Wet Governors, Exhauster Governors, Photometers of all descriptions. Letheby's Sulphur and Ammonia Test Apparatus complete—also Testing and Chemical Apparatus of all kinds, and of the most perfect description, for all purposes relating to Gas.

GOODWIN'S IMPROVED LOWE'S JET PHOTOMETER.

Agents for Bray's Patent Gas Burners and Lanterns.

Special attention to repairs of Meters, and all apparatus connected with the business.
All work guaranteed first class in every particular, and orders filled promptly.

G. B. EDWARDS, Mang'r, New York.
E. H. B. TWINING, Mang'r, Chicago.
A. B. STANNARD, Agent.

D. McDONALD & CO., GAS METER MANUFACTURERS.

(Established 1854.)

51 Lancaster St., Albany, N. Y. 34 & 36 West Monroe St., Chicago, Ill.

STATION METERS, EXPERIMENTAL METERS, METER PROVERS, PRESSURE & VACUUM REGISTERS, PRESSURE GAUGES, ETC.

Also STAR GAS STOVES, RANGES, and HEATING STOVES.

We use only the very best materials, and employ the most skilled labor, and by our long experience (29 years) and personal supervision of every detail, we feel justified in assuring the public that our goods will give perfect satisfaction. Every Meter emanating from our establishment will bear the State Inspector's BADGE, and will be fully warranted by us. Our Annual and Calendar will be sent to Gas Companies upon application.

KING'S TREATISE ON COAL GAS.

The most complete work on Coal Gas ever published. Three vols., bound, \$30.

A. M. CALLENDER & CO., No. 42 Pine Street, New York.

THE GOODWIN GAS STOVE AND METER CO.,

1012-18 Filbert St., Phila., 142 Chambers St., N. Y., 76 Dearborn St., Chicago.

Agents, WALDO BROTHERS, 88 Water Street, Boston.

WM. W. GOODWIN, PRES. & TREAS.
W. H. MERRICK, VICE-PRES.
S. LEWIS JONES, SEC.
SAMUEL V. MERRICK, SUPT.

SOLE MANUFACTURERS OF THE

G. B. EDWARDS, Mang'r, N. Y.
E. H. B. TWINING, Mang'r, Chicago.
A. B. STANNARD, Agent.

"SUN DIAL" GAS STOVES

The Most Economical, Efficient, and Durable Gas Stove Made.

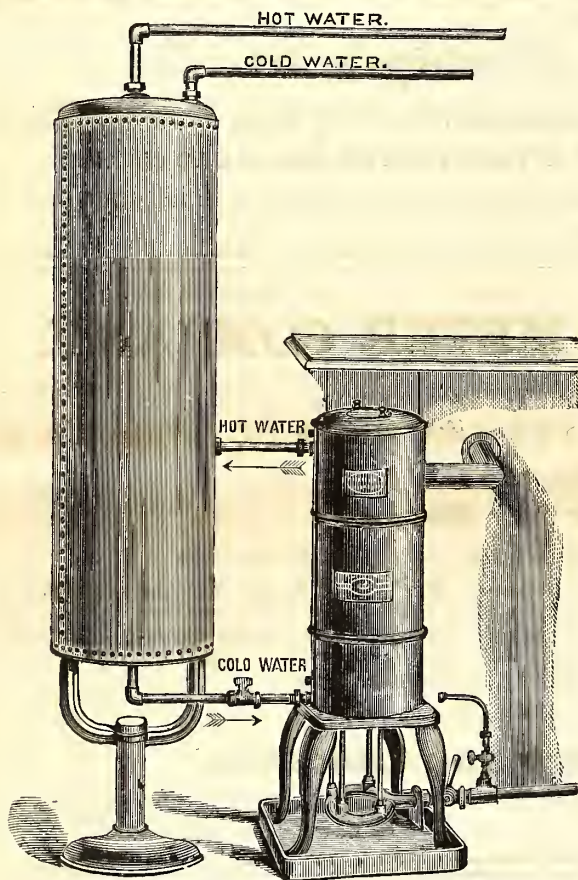

I.—Safety Hot Water Generator and Boiler.

Safety Hot Water Generator and Boiler.

Cut I. represents our Safety Gas Hot Water Generator and Boiler, arranged for home use. This most easy, quick, and economical way of preparing a warm bath, or for heating water for any domestic purpose, entirely supersedes any necessity for the use of ranges or stoves—a great comfort, particularly in hot weather. The boiler being self-filling, as the hot water is drawn off, can never become empty, thus preventing the possibility of any accident.

We beg to call attention to the cast iron pan which is now attached to the legs of the Generator (see illustration). This is to catch the drippings from the Coil, which many persons suppose come from a leak, when in fact they are produced by condensation. This condensation is caused by the hot flame coming in contact with the coil filled with cold water.

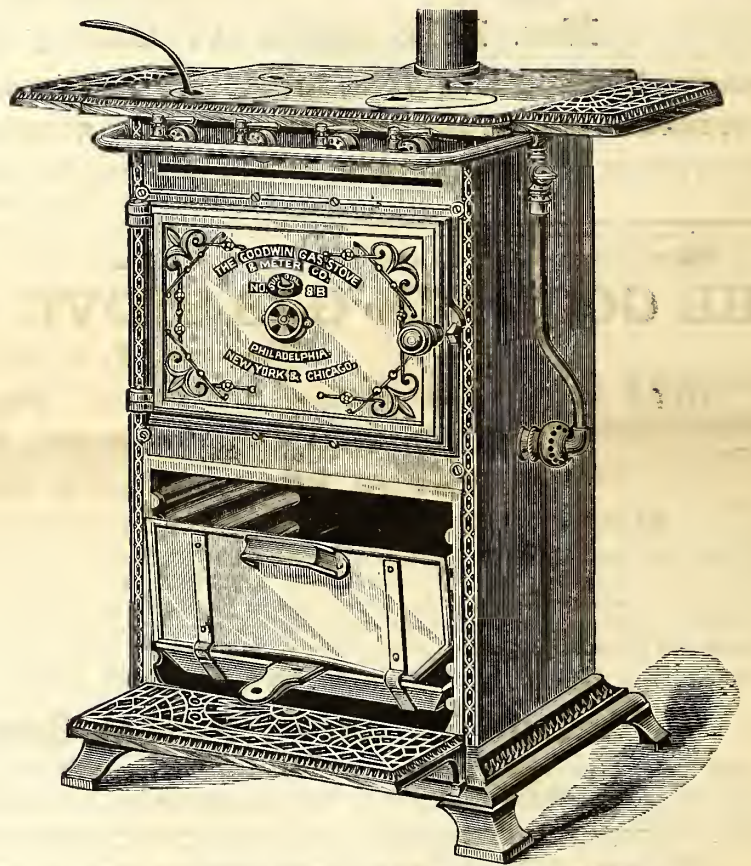

II.—Gas Cooking Stove No. 8 B.

New Style Gas Cooking Stove.

Cut II. represents our New Style Cooking Stove. As will be seen, it has an ornamented cast iron base and front, and extension shelves. The oven burner, which is atmospheric (unless otherwise ordered), is of an entirely new and improved pattern (patent applied for). The ovens are of greater capacity than those of the old style. The top, in conjunction with the outlet pipe, is designed to carry off all products of combustion; hence the outlet pipe must be connected with a flue, or the stove will not work properly.

This Stove has 4 boiling burners in top of hot plate. All fittings are nickel plated. We are making this style of Cooking Stove in the following sizes—viz., No. 7 B, No. 8 B, No. 9 B, and No. 10 B.



III.—Improved Hot Plate, No. 108.

New Style Hot Plates.

Cut III. represents our New Style of Hot Plates, of which we are making No. 106 (two small boiling burners), No. 107 (two medium sized boiling burners), and No. 109 (two medium and one large boiling burner). See new Catalogue and Price List for further particulars.

THE AMERICAN

GAS LIGHT JOURNAL

RODMAN & KENNY, N. Y.

PUBLISHING OFFICE No. 42 PINE STREET

DEVOTED TO THE INTERESTS OF ILLUMINATION, VENTILATION, WATER SUPPLY AND DISTRIBUTION, & GENERAL SCIENCE.

VOLUME XLII.—No. 12.
Whole No. 624.

NEW YORK, TUESDAY, JUNE 16, 1885.

{ \$3 PER ANNUM
IN ADVANCE.

A. M. CALLENDER & CO., Proprietors. C. E. SANDERSON, Manager.
JOS. R. THOMAS, C.E., Editor.

ENTERED AT THE POST OFFICE AT NEW YORK, N. Y.,
AS SECOND CLASS MATTER.

Published on the 2d and 16th of each month, at No. 42 Pine Street, N. Y.
Terms of Subscription, Including Postage.—For the United States and Canada, \$3 per annum. European countries, \$3.50 (15 shillings—18 francs). All payments to be made in advance. Single copies, 15 cents.
Remittances should be made either by post-office order, registered letter, or bank draft on New York, payable to the order of A. M. Callender & Co.
Collections are invariably made directly from this office, for subscriptions, advertisements, etc. We have agents to solicit the same, but they are not authorized to receipt for money.
Correspondence.—Wishing to make this JOURNAL a gazette of intelligent discussion to those of our readers who may wish to gain or give information on the subjects to which its columns are devoted, correspondence is solicited for publication from all who make the study of those subjects a pleasure or a profession.
The American News Company, Nos. 39 and 41 Chambers street, New York, are agents for this JOURNAL. Newsdealers will send orders to them.
Books.—We will mail, post-paid, at publisher's lowest rates, any book—scientific or otherwise—to any address in the United States or Canada. No books will be sent C. O. D.

A CHAPTER OR TWO IN THE HISTORY OF CLEVELAND (OHIO) GAS AFFAIRS.

We are quite sure that the fraternity of this country will agree with us in the statement that no other name is more indelibly stamped upon their memories than is that of the lamented Wm. H. Price, of Cleveland, Ohio. A natural leader, a calm thinker and cool reasoner, the dead President of the Cleveland Gas Light Company harmoniously joined to these, in his charming personality, all those qualities which go to make a man respected in life and mourned after when death removes him from the presence of his fellows. The steady progress of the years but makes his memory greener, for like as the cold rains of early spring bring back vivid hues to the grasses seared by the frosty blasts of winter, so does a recollection of his counsel and practice renew in our minds the sterling value of his precept and example, and reinvigorates in our hearts those feelings of esteem and affection which he so honestly earned by his upright course and sturdy rectitude when a dweller among us.

It is true that the matter in hand might possibly have been disposed of without any such lines as the preceding; but, again, on the other hand, no one can as yet rightfully attempt the delineation of a "chapter or two in the history of Cleveland gas affairs," and more particularly so when that history deals with details similar to those which are to follow here, without making some reference to the merits of the man who (and only after many severe struggles and even hardships) placed the Cleveland Gas Company on the safe and sure foundation where it now rests, and whose far-seeing judgment had more than once pronounced the opinion that security in the gas business would be best obtained through honest attempt at open dealing with the public.

Quite a number of the gas makers of to-day will say that we all know this to be so. Certainly the majority know it now; but Mr. Price knew it and advocated it years and years ago—even at the time when one gas man was almost afraid that a brother manufacturer should enter his retort house. The times are changed—it is very different now; and due credit should be given to those who were the first to speak against the folly, if not worse, of the old-time secrecy and even mystery.

Several of the public prints of the day not long since published an item to the effect that the "Forest City Gas and Fuel Company" had been denied the right to establish a gas plant in the city of Cleveland, Ohio. Being somewhat astonished that the water gas adventurers had the boldness to make an attempt at securing a foothold in that city, we made some inquiries respecting the affair, and as a result of our gleanings we obtained the following items; and we desire herewith to extend our hearty thanks to the gentleman (he does not wish his name to appear) who so kindly assisted us in obtaining a knowledge thereof.

The first intimation the Cleveland Company received of an impending strike at their business was obtained from the columns of the *Cleveland Morning Leader*, date of Saturday, Nov. 15, 1884. The article in that paper said a certain H. S. Jackson (a familiar cognomen it is), an agent of the United Gas Improvement Company, of Philadelphia, Pa., would have a resolution presented to the City Council, at its meeting to be held on the evening of Monday, Nov. 17, requesting the Mayor to call a special election for the second Monday of the next month, the object of the election being to submit to the people of the city the proposition as to whether or not a corporation calling itself the Forest City Gas and Fuel Company should have the right to

CONTENTS.

An Asterisk (*) denotes an illustrated article.

EDITORIALS—

A Chapter or Two in the History of Cleveland, Ohio, Gas Affairs	309
Central New York Gas Engineers Association.....	310
Death of M. Servier.....	310
Membership of the Gas Institute.....	310
Eighth Annual Meeting of the Western Gas Association—Official Report—Continued from page 285.....	311
Steam-jet Exhauster and Naphthaline, by J. B. Howard—Discussion—The Proper Location of the Gas Meter, by J. G. Miller—Discussion—Afternoon Session—In Memoriam—Report of Committee on President's Address—Election of Officers—To Name a Place for Holding Next Annual Meeting.	
How Much it Costs to Produce the Incandescent Electric Light, by Frederic Egner.....	315
The Value of Sulphate of Ammonia as a Manure.....	315
The "Novelties" Exhibition to be Held by the Franklin Institute, by H. C. A.....	316
Thirtieth Annual Report of the Jamaica Plain (Mass.) Gas Light Company.....	317
Torpedoes and Oil Wells.....	317
Red Lead in Steam Pipe Joints.....	318
Fireproof Doors.....	318
Recovery of Sulphur.....	319
ITEMS OF INTEREST FROM VARIOUS LOCALITIES.....	319
President Crockett Explains the State of Affairs at San Francisco, Cal.—Cheaper Gas for Dayton, Ohio—And So Does Brother Forstall—Water Pipe for Flatbush, L. I.—Something from Somerville, Mass.—Reducing Price of Gas at Columbus, Ga.—It Gave Up the Ghost—To Build a New Wharf—The Ohio Institute of Mining Engineers—Another Original Thief—Athletic Sports at Night with Electric Illumination—Something from Delaware, Ohio—Two Tests of Peerless Gas Coal—Possibly a Commission.	

CORRESPONDENCE—

Suggesting a Remedy.....	321
The Market for Gas Securities.....	321

establish and maintain a gas works within the city's limits. It was said that the incorporators would, as a guarantee of good faith, pledge themselves to pay the cost of the special election (liberal, were they not?), and deposit with the City Treasurer a check for \$1,000 to defray the expenses of the same. The article also gave the names of the officers and directors of the United Gas Improvement Company, and in continuation of its theme announced that "this company operates and owns or controls the following-named gas companies—viz.: Central, of San Francisco, Cal.; Omaha Mfg. Co., Omaha, Neb.; Waterbury, of Waterbury, Conn.; Harrisburg and Citizens, of Harrisburg, Pa.; Paterson and Peoples, of Paterson, N. J.; Pensacola, of Florida; and Mutual, of Savannah, Ga."

Promptly, and as promised, Mr. Jackson presented himself at the Council meeting of the stated Monday, and after repeated efforts in the line of earnest solicitation and almost frantic appeal to several of the city fathers, failed to find one of them who would consent to place his resolution to the formal notice of the Board; and when the session adjourned Mr. Jackson and his "resolves" occupied precisely the same position that they did before. Mr. Jackson, it must be said, was energetic in his efforts on behalf of his employers, as from week to week, and for upward of a month, he kept pestering the Councilmen in his attempt to have the resolutions presented, but, as before, without avail. Mr. Jackson at last disappeared; but subsequent developments showed that disappearance to have been but a temporary migration.

Leaving Mr. Jackson in his temporary retirement it might be as well to give one or two details regarding what his employers said they were willing to do in the way of lighting, prices, etc., and make slight mention of what it is necessary to do before an opposition could secure for itself a foothold in the Forest City. The proposition of the would-be despoilers was to the effect that they would agree to furnish the public with a gas of 20-candle power, at a charge of \$1.40 per thousand, and would pledge themselves (ever ready with their "pledges," which, something like unto those of a pawnbroker, are not always redeemed) never to charge over \$1.50 per thousand to the public. They would furnish gas to the city buildings and the street lamps at the rate of \$1 per thousand. [The old Cleveland company's charge at the time to the public generally was \$1.40; to the city, \$1.25. On the first of January, 1885, the latter or city charge was reduced by 25 cents per thousand. The illuminating power of the product sold, taking the figures of the past three years, as shown by the photometer-room records, has averaged fully up to 19 candles.] The laws of the State of Ohio governing the formation of a gas company, in a place where more than one similar corporation or works is in existence, require that the new applicant for business must first induce the local legislative body to pass a resolution ordering the matter to be voted upon by the people at large; should the ballot be favorable to the project, then the ordinance granting the use of the streets to the new-comer must secure the approval of a body known as the Board of City Improvements, and then that action must be ratified by the City Council, which also has the final right to add thereto any restrictions or safeguards that a majority of the members may see fit to impose. The City Council is composed of 50 members; it meets once a week, and the election for members thereof takes place on the first Monday in April of each year. Under the most favorable circumstances for speed in such matters (unless a suspension of the rules was ordered, which is very seldom the case, or only in times of emergency) it takes up three or four weeks before any ordinance could be secured. So much for those items in the situation.

On Monday, March 9th, the serenity of the Cleveland Company was once more disturbed by the unexpected—in fact somewhat apparitional—appearance of Mr. Jackson, accompanied with, or rather in possession of, the petition of the previous November. His appearance was made on March 9th; it was also observable that March 9th, happening on a Monday, was the occasion of the regular weekly meeting of Council, at which arrangements were to be made for the annual spring election of April. It transpired that Mr. Jackson had not been without influence after all, and that during the interim of his absence had not been idle with his persuasive powers. When business of the session progressed far enough to admit of the presenting of petitions, it transpired that Mr. Jackson had secured, as the result of over three months' of effort, a Councilman who was willing to father the resolution to the extent of bringing it formally before the Board. This time Jackson sought to have the ordinance presented to the people for their voting action at the same time that they would choose a new Council, the Imp. Company, if with no other object in view, thereby seeking to get rid of the \$1,000 impost. The resolution, upon having been read, was referred to the consideration of the Judiciary Committee, and this committee named an evening for the discussion of the merits of the thing. It was in reality an *ex parte* session, for while Mr. Jackson and his attorney were present, the old Cleveland Company was not represented in any way, shape or manner. During the progress of the inquiry some very pertinent (undoubtedly, Jackson thought they were impertinent) questions were propounded to him by one or two of the Councilmen, who inquired into his (Jackson's) and the United Gas Improvement Company's gas operations in various cities. Those present at the

time said afterwards that it was quite amusing to witness Jackson's discomfiture at perceiving the fact that the investigators seemed perfectly well posted as to the devious style of operations pursued by the "Philadelphia capitalists" in their raiding throughout the country. The questions were, indeed, most embarrassing to friend Jackson, and it will only be necessary to mention one of them, with his reply thereto, as an illustration of the unpleasant predicament that the "poor man" was placed in. When asked to name a city in which the gas from works owned or controlled by the United Gas Improvement Company was sold at a less or even equal price to that then charged by the old Cleveland Company, after much stammering, he replied that gas was sold in Savannah* (Ga.) at a dollar a thousand. One or two more "leading queries" brought out the fact (it was given with great reluctance) that even the dollar rate during the Savannah "fight" was made originally by the old company there, and that the raiders were obliged to follow in the lead. This last seemed to stagger the committeemen, and they subsequently reported unanimously against Mr. Jackson and his employers, and their report was unanimously adopted by the Council, in open board, and without a dissenting voice. The Council would not listen to a proposition which sought to gain a week's postponement before final action was taken on report of Judiciary Committee; they would listen to nothing else than an immediate slaughter of Mr. Jackson's petition; and once more did he sink into obscurity, ready to emerge therefrom, in all probability, at the beck of his "philanthropic" employers.

So ended the attempted Cleveland raid of '84-'5; although possibly the end of it (that is, for the "Imp." Company) may not yet have been reached, as a gentleman named John S. Mathews, a resident of the Forest City, and who is possessed of certain documents connected with the Cleveland "negotiations" and "negotiators," is inclined to make it warm for the latter. He can do it, and we earnestly hope that he will; and the columns of this JOURNAL are at his disposal whenever he sees fit to open fire on the depredators whose plan of procedure has made them a horror to honesty.

Before taking leave of the Cleveland history it is our pleasant duty to say that the old Cleveland Gas Company made an excellent choice, in its selection of a successor to the vacated chair of Mr. Price, by naming Mr. John H. Morley for the post. Mr. Morley, from his apprenticeship as a director of the Company since 1852, is amply qualified to carry on the task from the point where his lamented predecessor laid down the burden.

CENTRAL NEW YORK GAS ENGINEERS' ASSOCIATION.

The Sixth Annual Meeting of this Association was held at the time specified in the "official notice" previously published in the JOURNAL. We regret that the particulars came to hand too late for proper mention in this issue; and as we do not wish to do other than justice to the gathering (which was in all respects successful), further consideration of the matter is postponed for a fortnight

Death of M. Servier.

The last issue of the London *Journal* at hand (May 26th) contains the following:

"We regret very much to learn of the death of M. Edouard Servier, editor of the *Journal des Usines a Gaz*. The intelligence of this sad event, which removes from amongst us one of the leading men connected with the French gas industry, reached us too late to allow of a short notice of M. Servier's life and work appearing in the present issue of the *Journal*; but we hope to be able on an early occasion to give a few particulars in regard thereto. In the meantime we can only express our deep sympathy with his family, his friends, and his colleagues, on the loss they have sustained."

Membership of The Gas Institute.

From the statements made in the Annual Report of the Council of The Gas Institute (which, it will be remembered, is but the altered designation of what was formerly known as the British Association of Gas Managers) advance sheets of which had made their appearance in the last week of May, we learn that numerically the Institute has not progressed so rapidly during the past as in previous years, the net gain for 1885 over its predecessor being reduced to two. The comparative figures of the two years are annexed:

	1884.	1885.
Honorary members.....	20	20
Ordinary members.....	656	651
Extra-ordinary members.....	73	69
Associates.....	124	135
Totals.....	873	875

NOT QUITE READY.—The particulars regarding the attempted St. Louis (Mo.) purchase are not yet in proper shape for publication.

* This "fight" has since been ended by a consolidation, and the price of gas has been greatly increased, the "Imp." Company having dictated the terms.

[OFFICIAL REPORT—Continued from page 285.]

Eighth Annual Meeting of the Western Gas Association.

HELD AT THE TREMONT HOUSE, CHICAGO, ILLS., MAY 13, 14, and 15, 1885.

FIRST DAY—MORNING SESSION—MAY 13.

President Lansden informed the Convention that the reading of papers was in order. He thereupon introduced Mr. J. B. Howard, of Dubuque, Iowa, who read the following paper on the subject of—

THE STEAM-JET EXHAUSTER AND NAPHTHALINE.

Mr. President and Gentlemen :

Inquiries have been made by some members of this Association respecting the size and output of gas works that could with profit employ an exhauster ; also, whether a steam-jet exhauster is in comparison with a rotary as perfect in its operation, and if the troublesome naphthaline which its employment has a tendency to create can be managed without much difficulty. This paper is presented for the purpose of bringing out the opinions of those who are, or should be, ever ready to express themselves when any subject is brought up for their consideration.

There is some conflict of opinion as to the causes which create naphthaline ; but it would seem as though the general impression were that this particular pest is produced by high heats—for while some have asserted that it has been produced with low heats as well, it must be remembered that what would be considered a low heat to-day, would have been called a very high heat with the iron retort of 25 years ago, and when the presence of naphthaline was almost unknown. It is not the province of this paper to discuss the causes leading to naphthaline production, but rather to attempt to give the remedy for it while using a steam-jet exhauster.

The steam-jet exhauster being of the most simple construction, and doing its work without any mechanical appliances, is equally effective in the use it is designed for as any one of the various classes of rotary machines, and costs but one-third of the price usually charged for apparatus of the latter named style. It requires little or no attention, and performs its duty in a satisfactory manner, with a steam pressure varying from 10 to 40 pounds (also requiring much less skill in its management than is necessary when using a rotary with engine), and when placed in the retort house is always safely under the control of the men in charge. There can be no question but that the use of the steam-jet instrument adds to the illuminating power of the gas, since the gas on its issuance from the hydraulic main is heavily charged with tar ; the heating power of the steam emanating from the jet tends to set free the naphtha vapors, thereby enriching, to some extent, the gas product ; it also extracts a large portion of tar, and increases materially the yield per pound of coal. The only cogent objection that I am aware of which can be urged against its use is its liability to produce naphthaline while carbonizing "second pool Youghiogheny," or an equally rich grade of coal. Now, it would seem as though, under certain conditions, this objection can be disposed of without much trouble or loss of time, since while carbonizing Illinois or Iowa coal no flakes of naphthaline are ever observed. Many small plants are now running without an exhanster, because their owners do not feel justified in going to the expense of purchasing a rotary, coupled with the additional time and attention it would require in its operation. If, however, they could be assured of overcoming the seeming difficulty attending the use of a steam-jet, they would not hesitate, perhaps, to give it a chance ; but being more or less influenced through information received regarding the experience of those who, having had it in use and laid it aside, for reasons heretofore stated, are finally deterred from making a trial of the apparatus. I am certain there is no real cause for such apprehension, and I am confident that the purchase and use of a steam-jet exhanster will profit any small company having an annual output of 3,000,000 cubic feet or over. I am well aware that many steam-jet exhausters have been and are at present in use ; and am also cognizant of the fact that in quite a number of cases they have been supplanted by rotaries, the reason for the substitution, as assigned, being the difficulty experienced in relieving the excessive accumulations of naphthaline. No doubt there was much truth in the complaints, and I am willing to believe that grave annoyances were often encountered. That the steam-jet has few friends I must concede ; but yet it is quite reasonable to suppose that if the naphthaline difficulty could have been overcome, many of the instruments that have been dispensed with would, in all probability, have remained still in use.

One mode of doing this will, perhaps, be best explained by a recital of my own experience in the use of a jet, which instrument had given me, for some months after its introduction, considerable vexation and trouble. I may just as well confess that on several occasions I contemplated getting rid of it, and was impelled thereto because of the rapid formation of naphthaline, together with my poor success in relieving the same. Having at last achieved success in overcoming the difficulty, but little time is now spent in removing naphthaline. It is a fact worth mentioning here that while the steam-

jet has been in use at our works naphthaline has never passed the purifiers ; we never having had a stoppage in the inlet pipe to holder, nor in the street mains or service pipes—and this could not be said when we did not have the steam-jet in use, we having frequently been called on during the old regime to free the inlet pipe to holder, and also to clear many street mains and services.

As before stated, many are of the opinion that high heats conduce to the formation of naphthaline ; and I will not dispute it, although I might say that I have carried high heats—and more especially when burning tar for fuel—without finding greater quantities of naphthaline than when the heats were not as strong and while using the steam jet.

I have some hesitancy in expressing my opinion, knowing that I will have but few supporters in the view I entertain regarding the merits of the steam-jet exhauster ; but the experience gained from the continuous use of one of these instruments over a period of five years enables me to speak with confidence as to its advantages. Our jet is stationed in the retort house, at a point within eight feet of the hydraulic main. (This location I believe to be the proper spot. It is not sufficient that it should be set in the retort house, but care should be taken to see that it is always within a short distance of the hydraulic main—this distance, if possible, not to exceed twelve feet.) A 10-inch pipe leads from the exhauster to the first condenser, and is carried underneath the ground for a distance of eighty feet. It was on this pipe that I expected to encounter trouble from naphthaline, owing to the supposed alteration of temperature. Several of my friends in the gas fraternity advised me by no means to attempt the use of a steam-jet at my works, giving it as their opinion that this pipe would be stopped up inside of a week—they putting especial stress on the likelihood of trouble during the winter season. Now, on the contrary, I can say that up to the present time I have not experienced in the slightest degree any indication of a stoppage there ; and this I claim is owing mainly to the extremely high temperature of the gas brought about by the steam vapor. The temperature of the gas at inlet to exhauster is at 140° F. ; at exhauster outlet it registers at 174° F. ; and at inlet to condenser the temperature will be found decreased by only 10°—or, say, 164° F. The gas then passes through an 8-inch atmospheric vertical condenser containing twenty tubes, each about 18 feet high ; from thence it goes forward to the multitubular and scrubber.

At intervals of a month or more I have occasion to clean out naphthaline obstructions ; but the operation consumes only a few minutes' time, since at several points steam pipe connections have been placed, in order that steam may be at once applied whenever a stoppage does occur. All dip-pipes from the condensers and scrubbers seal into an open tank, so that the naphthaline, after being steamed out, becomes liquid, then upon reaching the tank it congeals (as a consequence of being subjected to such a radical change of temperature), from whence it can be easily removed. Care should be taken that the gas, in its distribution through the different sets of condensing apparatus, receives no rapid cooling ; for nothing else conduces so greatly to the creation of naphthaline as does the act of sudden chilling. Gauges should also be located at different places throughout the works, or in such spots as one might likely look for the first indications of an increase of pressure, so that steam may be applied and the obstruction immediately removed. In conclusion, I claim that, with the strict observance of the precautions given, no apprehension need exist with regard to the policy of using a steam-jet exhauster ; nor need there be any fear as to want of success in preventing any undue inconvenience which will arise from its liability to produce an excess of naphthaline.

Discussion.

Mr. J. M. Starr—As Mr. Howard intimates that that system of his develops naphthaline, I would like to have a description of the apparatus which he employs for catching it. That is a point which has always been a mystery to me.

Mr. Howard—I could not very well explain that in the paper, yet I thought possibly the question might be asked. It is a very simple thing, hardly worth speaking of ; but it is effective, nevertheless. In a great many places where the steam-jet exhauster has been in use the deposits in drip pipes are led through wrought iron pipes to some outside receptacle, which is often at a distance of many yards away. There can be no question that ordinarily the use of a steam-jet will favor naphthaline deposit ; and in fact the great obstacle to its use is the liability of the outside pipes to obstruction with congealed naphthaline. I could readily clear them of the obstruction, and for a time everything would work quite smoothly ; but after a short period the same pipes would again clog up. It was in order to overcome this state of affairs that I tried the open tank, leading thereto all the drip pipes, no matter whether they were from the atmospheric or multitubular condensers, or from the scrubbers, etc. Having found that the naphthaline, as it passed the atmospheric condenser, would of its own accord become liquid, pass down the pipe into the tank, and be there congealed to such an extent that it could be taken out with a shovel, I naturally thought of connecting all the pipes in like manner, to the end that they could thus be kept perfectly free. After the steaming, the naphthaline will run into the open tank, and you can

dispose of it without any trouble. It is safe, sure, and simple. You must not only steam it out, but you must take care of it after it becomes liquid. If you do not watch it the pipes will become stopped up in a short time. With the alteration which I have made at our plant, I find no trouble whatever. Whenever there is the least indication of stoppage at any particular point, the man who has charge simply turns on the steam for a short while, and then the naphthaline is taken out of the tank. That is all there is to it.

Mr. E. J. King—Do you increase your illuminating power by the use of steam?

Mr. Howard—Yes.

Mr. King—What do you do with the naphthaline?

Mr. Howard—I tried the suggestion once made by Brother Somerville—that of putting it back into the retorts; but I found no increase in candle power. Some claim that naphthaline should in reality be a good enricher; but that is not my experience. The quantity that I take out now is of little or no consequence; but what I do get I mix with the breeze and burn it under the boiler.

Mr. King—We all understand that naphthaline is one of the important enrichers of gas, and that if you throw it away you are throwing away something valuable to the finished product. How can you gain illuminating power and throw the naphthaline away? That is the question.

Mr. Howard—The crude gas, as it comes from the hydraulic main, is, as you are all aware, in the form or nature of minute globules. The steam-jet sets free the naphthaline vapors, and the tendency is to break up those globules much better than can be done in the ordinary way. The gas in its passage impinges upon two plates, and it also has to pass through the ammoniacal liquor box. As a consequence a considerable portion of the naphthaline vapor is set free, and which would not otherwise be released. I have made tests with reference to the increase of illuminating power that you get from the use of the steam-jet, and the average of these goes to show that the increase will vary from 1 to 1½ candles. You have all heard the statement that an increase of illuminating power has followed the adoption of the plan of allowing a steam pipe to pass into the end of the hydraulic main. Some claim that through heating the tar at that particular point we increase the illuminating power of the gas. I presume the steam-jet acts upon the same principle; but it is far more effective than the steam pipe.

Mr. Starr—Do you not find that it will accumulate in the overflow from the tank?

Mr. Howard—I guard against that. At the overflow, right where it passes out into the cistern, I place a two-inch pipe and split it open to within a couple of inches from the end of the thread. All that the one who looks after it has to do is to occasionally clean out the pipe with a small scoop. Split the tube open down to the point where it goes into the thread; then you will never have any trouble from its stopping up.

Mr. Starr—I tried the same apparatus, and this was my experience with it. The overflow pipe going into tank (the tank had a capacity of five or six barrels) would fill up with tar and water until finally it would run over. I then put in a two-inch pipe; and after a very short while that stopped up. I took the pipe out, and then the drip ran down the side and entered the tank or cistern through a small gutter. The naphthaline, or whatever sort of deposit you might call it, became very hard, and was of a muddy color. The moment it commenced running out it began to solidify. The deposit would sometimes be a foot in width and a foot thick. Would Mr. Howard call that a naphthaline deposit or not?

Mr. Howard—I presume it was.

Mr. Starr—I believe I have seen the time when I could fill a bushel with the stuff taken from out the top of that pipe.

Mr. Howard—While my experience may be set down as perfectly satisfactory to myself, it might not be so in the case of others who undertook to adopt the same method; and for this reason—that a steam-jet exhaustor requires more extended condensing capacity. To work it successfully you must increase that capacity up to its maximum, on account of the extreme heat given to the gas by the steam vapors. In many instances, no doubt, the non-success of a steam-jet has been owing to that fact having been overlooked.

Mr. McMillin—About how long have you been using it?

Mr. Howard—For about five years.

Mr. Jenkins—Do you say that you clean out the scrubbers, etc., about once a month?

Mr. Howard—Yes.

Mr. Jenkins—Do you consider it absolutely necessary to steam them out as often as that?

Mr. Howard—It is hardly necessary at all. I do it from force of habit. I have run for four months at a time without steaming out.

Mr. Starr—Were you compelled to do it at the end of the four months?

Mr. Howard—Not exactly; it is no trouble to steam out, and I have several times gone along for four months at a time without steaming. In the winter season I would not steam oftener than once a month.

Mr. McMillin—I have had some experience with naphthaline; and I find that it is absolutely necessary to steam out once a month. The arrangement of my works is such as to make me think that naphthaline would be produced there under any circumstances. The increased heat from the steam-jet, and the sudden cooling, will produce it. We are now changing to a rotary exhaustor, and I think that after this change is made we shall have less trouble.

Mr. Howard—You will have the same trouble with a rotary exhaustor provided you follow the same method of condensing.

Mr. McMillin—You say that you increase the temperature of your gas 34°. That would make a difference. I would not have as much increase with a rotary exhaustor.

Mr. Howard—You may have it, perhaps, in situations where you did not previously have it with a steam-jet—in the distributing pipes, for instance.

Mr. H. E. Clarke—Had a rotary been in use before you introduced the steam-jet, or had you had no exhaustor before?

Mr. Howard—I had had no exhaustor before.

Mr. Elbert—Do you use lime or oxide of iron in purification?

Mr. Howard—I use both iron and lime.

Mr. Elbert—I have had a great deal of experience with naphthaline; but when I used lime the deposit never got beyond the purifiers. Last year, while using iron sponge, I had quite a heavy deposit. I think that the iron had something to do with it.

On motion of Mr. Cosgrove, a vote of thanks was tendered to Mr. Howard.

The next topic treated of was a paper submitted by Mr. J. G. Miller, of Green Bay, Wis., on the subject of—

THE PROPER LOCATION OF THE GAS METER.

A few days after the receipt of an invitation from our worthy Secretary, who intimated that he desired me to prepare something for consideration at this annual convention of our Association, and while I was somewhat at a loss for a subject that might be of interest, even if of no great importance, I happened to be in one of the leading jewelry stores of our city, in the pursuance of my regular duty, that of taking the statement of the meter, when the proprietor of the establishment said: "Mr. Miller, why do not you gas folks put your meters in convenient and conspicuous places where both yourself and the consumers can ascertain their standing as readily and quickly as they can ascertain what hour of the day it is by glancing at a clock? Besides," he added, "the mechanism of a gas meter is almost as delicate and about as liable to injury and disarrangement as is that of a clock or a watch; and yet no one would think of storing a clock in such places as gas meters are usually put, even though it were the intention of its owner to stow it away because it was no longer required for immediate use."

This observation, while not a particularly novel one, suggested a theme which I deemed might be serviceable here, and I therefore appropriated it.

I quite agree with the gentleman on this subject, and believe that gas meters should be placed where both the consumer and the gas man can readily and without any personal discomfort see them, and take their readings without being compelled to prowl about through dark, damp cellars, with a candle or lantern in hand, or to work a passage among goods and litter of every kind in other equally out-of-the-way places.

Every gas man who has done much service in taking the statements of meters knows, as the result of distressing experience, the inconvenience occasioned by the present method of placing meters, and so must be thoroughly alive to the necessity of reform in this respect. The meter taker will also more than likely have encountered a similar experience to that to which I was once subjected at Marquette, Mich.

The meter registering the gas consumed in a hotel in that city was located in a cellar that was frequently inundated to the depth of a foot or more, and also infested with several hundreds, more or less, of wharf rats. I was obliged to traverse the entire length of this cellar (usually accompanied by a rat-terrier as a body-guard or protector against concerted assault on the part of the rodents) to get at the meter and take its statement. To read the index I had to call to my aid the flicker of a candle, and the dip would hardly burn because of the foulness of the atmosphere. Imagine a woman, with the noted antipathy of her sex toward a mouse, ever venturing into such a place to verify the accuracy of the gas man's figures through a personal inspection of the meter!

Where meters are put in these inaccessible places it is impossible to convince the complaining consumer of the truth of the silent measurer's statement; and as a consequence the gas man becomes an object of distrust even to the extent of being voted as a dishonest tool of a "conscienceless monopoly," or rated as a lineal descendant of old Ananias.

A few days ago I saw in a newspaper a case in point, where the master of the house said to the servant: "How does it happen, Bridget, that there are as many feet of gas charged for this month as last, when Mrs. Blossom and myself have been out of town three weeks?" To this the servant re-

plied: "Sure, an' I can't tell, sor, savin' that whin the gintleman came to luk at the maythur there was six fate of wood and coal atop of it, and he observed that I needn't bother wid it, for he'd jist take a luk at the praycadin' figgers. Maybe he added the six fate of wood and coal, I don't know."

But architects and owners of buildings object to the placing of gas meters in conspicuous places, presumably because they are not objects of ornament as well as of use; and so accordingly they relegate them to places where they are liable to be surrounded if not absolutely covered with refuse matter and general litter; and where in winter they are likely to be subjected to the action of frost to such an extent that they become filled with condensation, so that it really becomes a wonder that they register at all. Of late I have prevailed on many of our consumers to have their meters placed in positions where they can be conveniently reached and seen by themselves as well as by the meter taker.

With respect to the objection about putting meters in conspicuous places because of their lacking of the ornamental, I believe that this scruple can be easily overcome, and the gas meter be made as much of an ornamental feature of a store, or other rooms of a building, as any other feature of equal utility. And this is a matter I deem worthy the consideration of meter makers. Of course, I wish it to be understood that this ornamentation should be such as not to materially enhance the cost of the meters. I have used meters with the top and sides made of glass, so that the mechanism of the measurer could be seen; yet I do not approve of these, because of their liability to breakage when turning off the gas.

As gas meters are, in the matter of dollars and cents, much more important to consumers of gas than even their clocks, surely the instruments might be made as ornamental as the latter, and accorded relatively conspicuous positions.

While it is somewhat irrelevant to the subject-matter of this paper, I desire to refer to a feature that bears relation to station meters. For several years I have siphoned the water from our station meter and added fresh liquid every day, with the view of drawing off the ammoniacal liquor that settles in the meter and tends to the destruction of the drum. I believe this process preserves the latter and arrests injury to the meter. I think it accomplishes this object without detriment either to the meter or the gas passing through it.

However, my prime purpose in referring to this matter is to obtain the views of others regarding it, as well as their views on the original subject of this communication.

Discussion.

Mr. James Somerville—I am very glad that such a paper as this has come before us. I do not know of any other subject which really is of more importance. You will notice that our President, in his opening address, dwelt very fully on the subject of the location of the meter. It is no wonder that people cannot understand about the measurement of gas when the meter is stuck away in the darkest hole or corner of a house. It is now many years since I wrote to the AMERICAN GAS LIGHT JOURNAL on this subject. I have always been much impressed with the importance of it; and I hope that each one of us will take up the question, and that after the discussion we will go away from here determined to alter the present state of things. We have fallen upon times when it is our imperative duty to make this poor man's friend as handy and as convenient to the people as possible. Indeed, we have got to do it. Therefore I am very glad that Mr. Miller thought it worth his while to write such a paper.

Mr. E. J. King—I have for some time back adopted the plan (wherever it was convenient, or whenever we could get the consent of the parties) of putting the meter in plain sight; and I always try to impress upon consumers the importance of carefully watching the meter themselves. I have a show meter in my office, and whenever I obtain a new consumer I try to explain to him the working of the instrument, and always say, "If you are dissatisfied, you can come here and have an opportunity of doing the testing yourself." I find that when I can get consumers interested up to the point of comprehending the working of the meter, and in understanding its reading, I never have any more trouble with them. I always tell the consumers that we will go to the expense of putting the meter in just such a position that they can see it, and watch it, if they will only do so. When we prevail upon them to do that we never have any more trouble with them. It is, as Mr. Somerville said, an important question.

Mr. G. G. Ramsdell—One great trouble with meters is that they are so difficult for an ordinary person to read. I find that without a great deal of instruction there are very few people who can make an intelligent reading of the dial, even when the meter is placed where it is easily accessible. They do not seem to master the fact that the middle hand travels backward, if I may so say. I think that if our meter makers should adopt some system which would make the task of reading more simple, it would do away with a great deal of trouble. I recently had a good illustration of the antipathy with which almost everybody not connected with the gas business regards the gas meter. I was away from home at a time when someone in

the City Council brought an expert to test our gas meters and lamp burners. We have a consumer with whom (even although he is a very good friend of mine) I have had a great deal of trouble. He never could believe that the meter was correct. We have tested his meter, changed his meter, and done about everything that was possible in our attempts to satisfy him. Immediately upon my return home I was informed that this expert was at the works doing some testing with our prover. I went down to the works and found that the examiner had my "cranky" friend's meter among the lot to be operated upon. I made the remark that I was glad he had that meter, because I thought now the gentleman would be satisfied. At the first of the month I took his bill to him as usual, and supposed, of course, that everything was all right, and made some pleasant remarks about it; but I found to my surprise that the gentleman was very indignant indeed. He thought it was a "set up job" all the way through, and he had no more faith than he had before. He made the remark that if he had been at home he would not have allowed his meter to be taken from the house. It shows the feeling of a large proportion of our consumers toward the gas meter. If we could only have some meter which would be as plain to read as a clock, and could then set it up in sight, it would do away with a great deal of vexation on both sides.

Mr. J. M. Starr—I approve of the gentleman's idea about having the meter more ornamental, and also agree in the idea of putting it where it can be seen. I think we should suggest to the meter makers that they get up some nice, ornamental meter, with a suggestive motto—possibly, "In God we trust," or something of that kind. (Laughter.) I wish that the meter makers would take advantage of this suggestion. They might charge a little more for the meter; or, for the sake of doing good to the community, they might charge a little less. But let us have the experiment made.

Mr. J. B. Howard—An incident occurred in our city which I think is worth relating now, seeing that we are on the topic of gas meters. The proprietor of quite a large store had burned gas for nearly three years. Toward the close of the third year he complained of his gas bills being excessive when compared with those of another store close by which had in it about as many burners as there were in his. He, in fact, found that his bills were, on an average, double those of the other shop; and he said he could not account for it. He wanted me to change the meter. I did change it, but next month there was the same dissatisfaction with regard to the account. He wanted me to put in still another meter. I said to him, "You must have a leak in some of the pipes in your building." He replied, "No; there are no gas leaks; I cannot smell escaping gas in any portion of the premises." In order to appease him I told him I would do anything to satisfy him; and so I changed his meter once more. Next month when the bill came in the same objection was made. Then I said to him, "In order to satisfy you I will take out your meter, and the neighbor's meter which you refer to, and we will go down to the works and prove them, and thus verify them." I took them out, proved them before him, and showed him how it was done. He became satisfied that the meters were correct. On returning, after placing the meter in position and turning the gas on, I found that there was a leak. I said, "You have a leak about your building, notwithstanding you say that such is not the case." We traced the thing out and discovered a big leak. We actually found that his leakage was greater than his consumption. In hunting for the escape we went all over the building without finding any external evidence of what we were looking after. A rather suspicious-looking spot between the roof and ceiling attracted my attention, and, sure enough, cutting away two feet of the plaster and lath developed the leaky joint. It was a good big one. I made him mount the ladder and examine it for himself. He afterwards figured up that his loss by leakage, judging from the difference in the amount of his bills before and after finding out the leak, had amounted to \$900. After the thing was over he said, "Don't mention anything about it."

A Member—It is a great wonder he did not ask you to reimburse him.

Mr. Emerson McMillin—There are a great many objections that may be urged against the generally-accepted plan of placing the meter. One of them was mentioned by me at the New York meeting of the American Gas Light Association,* and had reference to the matter of extra mileage. If you have, say, 500 stores, each 75 feet long, and are obliged to walk to the back end of them, and then come forward again, you have about thirty miles extra of walking to accomplish in the taking of the 500 indexes. Now, I think any one of us would rather walk 60 miles outside than do thirty miles in a cellar. I think that, as a rule, the consumer gains by having the meter in the cellar. I think, on an average, the temperature of the cellars would not be more than 50°, whereas up in the dwelling part of the house, or where you would place a clock, it would be 70 or 75°. Suppose the difference is only 20°, that would make four per cent. difference in the registry of the gas. If you tell each consumer that he will use 4 per cent. more because of having his meter put up where he can see it, he will tell you to "bury it

* Held at Teutonia Hall, October 1883, it being the XI. Annual Meeting.

a little deeper." It is not altogether advantageous to the consumer that his meter should be located in another part of the premises than the cellar. The cellar is, in many respects, a good place to set a meter—*i. e.*, if it can be approached readily. In fact, if you can only reach it readily, I do not know that you can get a better place for the meter than in the basement of a building.

Mr. J. M. Starr—Is Mr. McMillin correct in saying that that difference in temperature of the gas coming from the service pipe, and the length of time that that gas is in the meter, will make four per cent. difference in its registration?

Mr. McMillin—I think I am. The experiments made last year in England as to the heating of air in regenerator furnaces have demonstrated very clearly that gas or air travels only a very few inches from the place of heating before it goes back to the normal temperature of the atmosphere. On the other hand, it will travel but a very short distance in a hot temperature before it takes on the temperature of whatever it comes in contact with. It does not travel fast from the meter, and it possibly might not take up the full temperature of the room, but it would approximate to it. It certainly would come within 25 per cent. of that temperature, and this would make a three per cent. difference.

Mr. E. H. Jenkins—I think that argument of the gentleman is only another convincing reason that we ought to put our meters up stairs and save that four per cent.

On motion of Mr. Foster, the thanks of the Association were tendered to Mr. Miller for his paper.

The Convention then took a recess until 2 o'clock P.M.

FIRST DAY—AFTERNOON SESSION.

IN MEMORIAM.

Mr. J. B. Howard, from the Committee appointed to prepare resolutions in regard to the death of Mr. Thomas Butterworth, presented the following:

Whereas, The members of the Western Gas Association have learned with profound sorrow of the death of their late associate and friend, the Hon. Thomas Butterworth, of Rockford, Illinois; therefore, and in justice to the memory of that departed friend and brother, we hold it to be only proper we should make a fitting recognition of his lofty character and manifold virtues, be it

Resolved, That in the death of Thomas Butterworth we have suffered severe loss through the demise of one who occupied an eminent position in the ranks of the gas fraternity; a man possessed of extensive information gained through long experience, and of such a generous, kindly nature that he ever freely imparted the benefits of his knowledge and research to his brethren. He was faithful to every trust, whether public or private, that had been assigned him, and his honorable services to the people when acting as a member of the Illinois State Legislature were alike creditable to himself and to the wisdom of his constituents. Not alone in the Legislature, but also as well in every other position that he had occupied, did he prove himself honest, efficient and capable. His generous and magnanimous nature was constantly exhibited in all his relations with us, and his cordiality, good will, and agreeable personal qualities bound us closely to him in the friendliest social relations.

Resolved, That we appreciate fully the calamity which has befallen his family, and extend to them our heartfelt sympathy in their sore affliction.

Resolved, That these resolutions be made a part of our records, and that a copy of them be transmitted to the family of our deceased associate.

J. B. HOWARD,
J. R. THOMAS,
G. G. RAMSDALL. } Committee.

Mr. Howard—I think it is fitting, before the vote is taken on this report, that some remarks should be made with regard to our deceased friend, Mr. Thomas Butterworth. It is with deep feeling that I realize the fact that he is no longer with us. He was so genial in his nature, so cordial in his manner, that now we sadly miss him. Let us cherish the memory of his good qualities; and believing, as we do, that he is now where pleasure is everlasting, let us hope to join him in that better land.

Mr. J. R. Smedberg—In the year 1853, Mr. Butterworth, Mr. Joseph Light, of Dayton, and myself were youngsters in the Cincinnati Gas Works. In spite of this association, extending beyond the average life of man, the resolutions so completely express my feelings that I prefer simply to vote their adoption, rather than weaken them by any poor words of my own.

Mr. John Fullagar—I heartily concur with the resolutions, and also in the remarks of Messrs. Howard and Smedberg. I had known him for thirteen years; and I can say that no better man ever lived than Thomas Butterworth.

Mr. James Somerville—I can but echo the words of the resolutions. We all miss the manly form of our friend. I always expected to meet him at our gatherings, as he ever showed a deep interest in our Association. He was always among the first to come; and his cheery words of greeting,

"Somerville, how are you? I am glad to see you," came from out his heart, and the gladness beamed forth from his face. It was with profound sorrow that I heard of his death; and while I mourn with you at his demise, I am sincerely pleased in having this opportunity of adding my tribute of respect and affection to the memory of our friend and brother.

The resolutions were then adopted by a rising vote.

Mr. E. H. Jenkins, from the Committee appointed to prepare appropriate resolutions regarding the death of Mr. George E. Downing, read the following:

WHEREAS, It is with deep regret we learn of the death of our associate member, Mr. George E. Downing; be it therefore

Resolved, That we tender to his family our sincere sympathy in their great bereavement. We shall ever miss the face of one who was renowned for his whole-souled and generous disposition—a man whom it was always a pleasure to meet in any business or social relation.

Resolved, That these resolutions be spread upon the records of this Association, and that a copy of same be transmitted to the family of our deceased friend.

E. H. JENKINS,
JAS. M. STARR,
T. A. COSGROVE, } Committee.

Mr. E. H. Jenkins—It was with great surprise that I learned to-day for the first time of the death of Mr. Downing. For years he had been one of my warmest friends; and I was always glad to meet him, either at the meetings of the Association or when he would make his visits among the different companies. I think that I voice the sentiment of all our members when I say that he was a whole-souled man and brother.

Mr. James Somerville—I also well knew our deceased friend, Mr. Downing. He was an exceedingly affable and pleasant gentleman; and I would say that the coincidence of the deaths of these two members is most remarkable. If there was anyone in the fraternity with whom George Downing was better acquainted than with another, that one was Mr. Butterworth. They were warm personal friends. We have good assurance that they are together now, and enjoying that reward which remaineth for those who do their duty here.

The resolutions were then adopted by a rising vote.

REPORT OF COMMITTEE ON PRESIDENT'S ADDRESS.

Mr. E. McMillin, of Committee on President's Address, handed in the following report:

To the Members of the Western Gas Association:

Gentlemen—Your Committee to whom was referred the President's annual address beg leave to report as follows:

We find that the various suggestions embodied in the address are worthy of consideration; and that perhaps none other of the suggestions are of more importance than the one which says: "The managers of small gas works should take a prominent part in the discussions at our meetings." The experiences of these persons are certainly more varied, and thus often more interesting and instructive, than are the experiences of persons in control of or connected with larger plants.

Another good suggestion, and of not less importance, is the one that State Associations should be encouraged. The Committee are in full accord with that sentiment, and believe that great good would grow out of the organization of associations in every State in which are located ten or more gas works.

The President suggests that the question of the advisability of asking that State Gas Commissions be appointed be discussed. The Committee advise that the Association avail itself of the suggestion, and recommend that an hour be set apart for such discussion.

A report upon that part of the President's address referring to the decease of members is rendered unnecessary by the appointment of special committees to suggest appropriate action thereon.

Respectfully submitted,
E. McMILLIN,
R. H. CANBY,
S. H. DOUGLAS, } Committee.

The report was adopted.

On motion of Mr. E. J. King, the President appointed the following as a committee to take in hand the matter of the formation or appointment of State Gas Commissions, with instructions to report back their conclusions on the afternoon of second day—May 14: Messrs. E. J. King, G. G. Ramsdell, G. A. Hyde, Z. T. F. Runner, and C. Collins.

ELECTION OF OFFICERS.

Mr. J. B. Howard, from the Committee appointed to nominate officers for the ensuing year, submitted the following list of names:

For *President*—Mr. James Somerville, Indianapolis, Ind.

For *First Vice-President*—Mr. John Fullagar, Cincinnati, Ohio.

For *Second Vice-President*—Prof. S. H. Douglas, Ann Arbor, Mich.

For *Secretary and Treasurer*—Mr. A. W. Littleton, Quincy, Ills.

For *Directors*—Messrs. E. H. Jenkins, G. A. Hyde, Jr., W. W. Wallace, Samuel Prichitt, Thos. A. Cosgrove, W. H. Odiorne, T. G. Foster, and Jas. Montgomery.

On motion, the report of Committee was accepted, and the ballot of the Association was cast in favor of the election of above-named gentlemen to the positions designated. President Lansden declared the result in formal manner.

Mr. Howard—If it is in order, I would like to hear from our President-elect.

The President—We would all like to hear from Mr. Somerville.

Mr. James Somerville—I feel greatly honored in having been chosen to the Presidency of this Association. I only wish that the mantle had fallen upon someone who could wear it more worthily. Trusting, however, to your kind help, I will endeavor to so perform the duties of the office that the interests of the Association shall not suffer neglect during the term of my service in the Chair. It shall be my aim at all times to do all that I can for the advancement of our common interests.

Mr. E. McMillin—I think we ought to hear from our Vice-President; but as Mr. Fullagar is so exceedingly modest, perhaps the Association will excuse him from speaking.

Mr. John Fullagar—Gentlemen, I thank you for the honor conferred upon me. I will do all that I can to aid the Association, and assist President Somerville to the best of my ability.

Mr. J. B. Howard—I promised Prof. Douglas, at the time the nominations were agreed to by the Committee, that I would say something which would relieve him (as he was on the Committee) from seeming to assist at the nomination of himself for the Vice-Presidency. We put his name on the ticket without his approval and against his earnest protest. The other members of the Committee were unanimous in believing that it was but fitting we should thus show our appreciation of him as an honored member of our Association.

Prof. Douglas—I am obliged to the gentleman for his explanation. I felt that the fact of my being one of the younger members of the Association (not in age, but in membership) should exclude me from office. I feel a deep interest in the success and prosperity of the Association; and, whether as officer or member, will always do my best, and in whatever light I can, to advance its interests. I do not anticipate that my official services will be very laborious; but I feel that whatever of honor attaches to the office should have gone to the older members of the Association. I am obliged to the Association for the compliment; and I am obliged to Mr. Howard for offering the explanation which he made in my behalf.

TO NAME A PLACE FOR HOLDING NEXT ANNUAL MEETING.

The President—I will nominate Messrs. R. Spencer, T. Smith, and W. Wallace as a committee for determining our next place of meeting. I do not wish to be considered as desirous of influencing the action of that committee, but as one or two members thereof may possibly not understand the system adopted heretofore with regard to our selection or naming of a city wherein to hold our annual meetings, I will instruct them about the matter. We have been accustomed since our organization to have the Association meet alternately in one of the four cities of St. Louis, Cincinnati, Chicago, and Indianapolis. According to that system we would meet next year at Indianapolis. If the committee select Indianapolis, it will probably very well suit the convenience of our President-elect, Mr. Somerville.

[To be continued.]

How Much it Costs to Produce the Incandescent Electric Light.

By FREDERIC EGNER.

Gas men generally believe that it costs more to light a town by the agency or aid of the incandescent electric light than would be the case were illuminating gas employed; and yet, when the question is asked, "How much cheaper or dearer than gas is this electric light?" it is not so easy to get a reliable answer. "To supply a long-felt want"—excuse the expression—the following data may be of interest to many readers of the AMERICAN GAS LIGHT JOURNAL. The cost of lighting by the Edison incandescent system a certain town in the West for the months of last November, December and January was as follows:

Engineer (for the three months all told).....	\$165 00
Engineer's helper " "	90 00
Electrician " "	135 00
Coal (at \$1.65 per ton) " "	346 00
Oil and waste " "	29 10
Incidentals " "	16 95
Broken lamps (at 50 cents each), 3 months all told	162 00

Total, exclusive of office expenses, wear, tear, etc. \$944 05

Lights connected, though not all used—in fact not quite one-half were used:

Nov., 1,004 ten-candle power lamps, and 195 sixteen-candle power lamps.	
Dec., 1,057 " " " " 197 " " "	
Jan., 1,412 " " " " " " "	

But suppose if the whole outfit had been used, and it would have cost the same to operate the entire lot, the light furnished would have been equal to 637,480,960 grains of sperm. Divide that with the value of a cubic foot of your gas, my reader, and you will know what gas ought to cost you in the holder, if you were required to compete with a similar incandescent electric lighting plant. For the benefit of those who may not be acquainted with the rule for finding the value of a cubic foot of gas, the following quotation may be of use: "Multiply 120 (the grains allowed per hour for the consumption of the standard sperm candle) by the illuminating power, and divide by 5 (consumption of gas in cubic feet per hour by the standard burner). The answer will be the value of gas in grains of sperm per cubic foot." For instance: What is the value of a cubic foot of 20-candle gas?

$$\frac{120 \times 20}{5} = 480 \text{ grains of sperm.}$$

In that way we find that the light given by the electric plant in question, for those three months, was equal to that which would have been given by 1,328,000 cubic feet of 20-candle gas; and dividing the cost of the electric light—\$944.05—by the 1,328 thousands cubic feet of gas it represents, we find that gas ought to have cost 78.6 cents per 1,000 cubic feet in the holder, in order to be as cheap as the electric light was. It should have been mentioned that the electric lamps were kept burning only about 4 to 4½ hours each night. If you are so situated that coal would cost more than \$1.65 per ton; and that skilled labor could not be had quite so cheaply, that is all the better for you, my fellow gas man.

The results quoted are from one of the "show towns" of the electric light propaganda; hence, of the best. If, in the preceding case, we counted only the lamps actually in use, then the relative cost of gas would have been \$1.63—in the holder, don't forget; but it is fair to assume that to light all of the lamps would cost but very little more. The so-called 10-candle and 16-candle power lamps are found generally to be nearer 6 and 11-candle power than that claimed for them. The writer might go on and quote from the results obtained in two other towns lighted up in the same manner; but the one cited showing best—that is, in favor of the electric light, will do. Yet one more may be mentioned briefly. The assertion was made by the manager of one of these companies that the average cost of maintaining a 10-candle power lamp was two-tenths of one cent per hour. All this is exclusive of wear and tear of machinery, which latter, owing to the high speed that must be maintained, is not a trifle. On figuring up the detailed expenses of the latter gentleman's statements, it was found he had made a mistake somewhere, as, according to his own data, it really cost four-tenths of one cent per lamp per hour. Next in order is the incandescent gas burner—and look to your gas stock now; but when about to weaken, think of the electric light, and how, not long ago, it was to wipe out all gas works.

The Value of Sulphate of Ammonia as a Manure.

[Mr. F. J. Lloyd, F.C.S., recently contributed to the columns of the London Journal the following communication upon the above named subject.]

Of late the Journal has contained some interesting matter in reference to sulphate of ammonia. Perhaps, therefore, a few words on this subject from an agricultural point of view might not only prove of interest to its readers, but, while dispelling from their minds the false views regarding the future of this product, enable them to rightly estimate the true relative merits of soda and sulphate of ammonia as manures. Each of these substances has a manurial value; and both owe this value to the same fact—viz., that they contain nitrogen. In the one the nitrogen exists combined with hydrogen as ammonia; in the other, combined with oxygen as nitric acid. It is a well-known fact that 100 parts of commercial sulphate of ammonia, of 94 refraction, such as is now usually sold for manurial purposes, contains about 20 parts or more of nitrogen; while the detrimental impurities, the various cyanides, which used, twelve or more years ago, to be somewhat prevalent in sulphate of ammonia, are now seldom met with. On the other hand, commercial nitrate of soda, of 95 refraction, contains little less than 16 parts of nitrogen. Hence, unless it can be shown that the nitrogen in sulphate of ammonia is less valuable to the farmer than the nitrogen in nitrate of soda, it is evident that, so long as a ton of nitrate of soda can be bought for £10 (which is approximately its present price), sulphate of ammonia is worth £12 10s. a ton. Now, is the nitrogen of ammonia as valuable to the farmer as the nitrogen of nitrate? In order to answer this question, which lies at the root of the whole subject, it is necessary to briefly state some facts regarding the function of the roots of the plant, and the properties of the soil. The majority of plants take most if not all their nitrogen from the soil as nitric acid. There can be no doubt, therefore, that nitrate of soda will act upon vegetation more rapidly than sulphate of ammonia. But it is equally certain that every properly cultivated soil possesses to a high degree the power of nitrification—that is, it converts all nitrogenous substances gradually into nitric acid. Ammonia is one of the substances most easily so converted. Hence it is certain that when sulphate of ammonia is used as a manure the soil will gradually convert the ammonia into nitric acid, and supply

to the plant nitrogen really in the very same form as is supplied by nitrate of soda. So far it is evident, then, that nitrate of soda is only more beneficial than sulphate of ammonia, inasmuch as it acts upon vegetation more rapidly.

Next let us consider the action of the soil on these two substances respectively. The late Dr. Voelcker, among his valuable additions to agricultural chemistry, left none more valuable than his researches upon the action of soils on manures. By analyzing the water flowing from the drains of large fields, where crops were cultivated under varying conditions and manures, he proved that nitrate of soda is washed rapidly through the soil by rain, so that a large quantity of the nitrogen so applied to the soil is never taken up by the roots of the plants; and during the time there is no crop growing the nitrate of soda is being merely washed away. Not so with sulphate of ammonia. Only once or twice, in all his experiments, did he find ammonia being washed through the soil into the drains, and then only in minute quantities; and this was found to be the case even where the land had been manured with 4 or 5 cwt. of sulphate of ammonia—far larger quantities than are usually employed. What, then, became of the ammonia? It was found that all fertile soils had the power of retaining ammonia, which became only gradually converted into nitric acid; and then only, and not until then was it washed out of the soil. Meanwhile any plant growing in the soil would be well able to take up the nitric acid as it was formed, so that less would be lost than where the nitrogen had been applied as nitrate of soda. If, then, nitrate of soda is more active than sulphate of ammonia, still the latter is more lasting and less wasteful. It is evident that manure manufacturers are well aware of this fact; for one seldom finds nitrate of soda admixed in compound manures, except for special and forcing purposes, while sulphate of ammonia is largely and rightly used for mixing with phosphatic manures. If I have made my meaning clear it will be evident that the producers of sulphate of ammonia have nothing to fear, from theoretical reasons, as to the supposed inferiority of this manure when compared with nitrate of soda.

As might be anticipated, practice in the field confirms these scientific conclusions. Thus the renowned experiments of Sir John Lawes and Dr. Gilbert at Rothamsted, and the experiments by the late Dr. Voelcker at Woburn, for the Royal Agricultural Society, yielded the following results, where equal quantities of nitrogen were applied as sulphate of ammonia and nitrate of soda respectively:

	ROTHAMSTED.		WOBURN.	
	Sulphate of Ammonia.	Nitrate of Soda.	Sulphate of Ammonia.	Nitrate of Soda.
	Wt. per Bush.	Wt. per Bush.	Wt. per Bush.	Wt. per Bush.
Barley.....	42 $\frac{1}{4}$45 $\frac{3}{8}$	45.....48	41.2...52.4	42.6...52.3
Wheat.....	31 $\frac{1}{4}$60 $\frac{3}{4}$	37 $\frac{3}{4}$59	29.1...57.1	28.9...56.9
	Av. of 13 yrs.	Av. of 13 yrs.	Av. of 6 yrs.	Av. of 6 yrs.

At Rothamsted the ammonia salts were applied in the autumn; but at Woburn in the spring. In both cases the nitrate was applied in the spring; and it is evident that there is an apparent superiority of nitrate of soda over sulphate of ammonia (and chlorides, for they were mixed) at Rothamsted. I have, however, brought forward these results because they illustrate very forcibly how much the value of a manure (and especially a manure like sulphate of ammonia) depends upon the time of its application. Undoubtedly the best time to apply sulphate of ammonia is in the spring—early spring—and in damp weather. And this is why the Woburn experiments yield more favorable results. Had the nitrate of soda at Rothamsted been applied in the autumn, it would have been largely washed out of the soil and proved useless; and then the sulphate of ammonia would probably have yielded much larger crops than the nitrate. The fact that the sulphate remained in the land all through the winter and produced a crop very nearly as good as the nitrate applied in spring, is a strong proof of its great value as a manure. In fact the only legitimate conclusion which can be drawn from the preceding is that the nitrogen in sulphate of ammonia is every whit as valuable as the nitrogen in nitrate, provided the sulphate be properly used. But there is another advantage possessed by sulphate of ammonia, as opposed to a direct disadvantage under which nitrate labors. It is this: Nitrate of soda will often prove of more harm than good on stiff clay soils; while on such soils sulphate of ammonia proves a most valuable manure. Indeed there is no soil upon which sulphate of ammonia has proved to have any injurious effects; while there is evidence of farmers having found nitrate of soda injurious on their wet, stiff clays.

It must not be supposed for a moment that, in upholding the value of sulphate of ammonia, I wish to detract from the value of nitrate of soda. Each has its proper use; and each, to give good results, requires care and judgment in its use. There are circumstances and conditions when, as shown,

sulphate of ammonia is superior to nitrate of soda; but there are equally circumstances and conditions when nitrate of soda is superior to sulphate of ammonia. This, however, is not the place to enter into these conditions. All that I wish to point out to gas companies and sulphate of ammonia manufacturers is this—that sulphate of ammonia is most valuable as a manure, and can be applied in the majority of cases with as great advantage as nitrate of soda. The unit value of nitrogen, therefore, in these two substances is (for the farmer) identical; so that the price of sulphate can never be above that of nitrate of soda, except in so far as it contains 20 parts of nitrogen to 16 parts in nitrate of soda, and the market value of these two articles must regulate one another.

But the question of demand must be taken into account; into the supply of sulphate we need not inquire. What the manufacturers want is to create—or rather to increase the demand. Those interested in nitrate of soda have already realized the importance of this; and hence, no doubt, the tempting bait of £500 which has been offered for the best essay on its advantages. That this essay will be in strict accordance with scientific and proved facts is certain from the names of those who have been selected as judges. Hence it will carry great weight and conviction; and the impetus which will be given, not only in England, but throughout the world, to the use of nitrate of soda as a manure will be immense. Some twelve months at least must elapse before the prize essay can be published; and the producers of sulphate of ammonia will have none but themselves to blame if they refuse to utilize the interim in making more widely known the advantages of sulphate of ammonia as a manure—advantages which are as real, and as well proved, as any of those which can be brought forward in favor of nitrate of soda.

The "Novelties" Exhibition to be Held by the Franklin Institute.

By H. C. A.

The Franklin Institute, of the State of Pennsylvania, which has been for years permanently located at Philadelphia, is well known to those who take an interest in scientific or mechanical subjects. It was founded in 1824, and since that time it has steadily pursued its object, which, as set forth in its title, is, "The promotion of the mechanic arts." To most successfully achieve that end a number of exhibitions have been held under the auspices of the Institute at different times and of varying scope; but in each case with the single aim of bringing before the people, and thus illustrating, aiding, and advancing, the progress of invention.

The membership of the Institute, consisting as it does of men of most eminent authority in all branches of theoretical and applied science, and also of those having thorough familiarity with the practice of the mechanic and its allied arts, has enabled it to select such judges at these exhibitions that the award of merit there given has been regarded as the highest proof of the worth of any device or discovery.

A few years ago an exhibition was held that embraced the whole range of arts and manufactures; but the recent enormous growth of our industries and the many branches and extensions of the same that have recently sprung up, precluded any such liberal design on the part of the Institute in the future. Recourse was then necessarily had to special branches, and in the fall of 1884 an Electrical Exhibition was held, which proved a most gratifying success in all directions; it accomplished far more than was expected from it in promulgating the knowledge of electricity and extending its use. The careful and laborious reports of the examiners and judges, not even yet completed, will be so weighty and decisive that they are awaited with the most intense interest by the electrical world. So many applications were made last summer to the Electrical Exhibition Committee for permission to exhibit appliances that did not come properly within the province of an Electrical Exhibition, and which were consequently refused, that the Board of Managers were led to believe that material existed for another exhibition that would enable those who could not find such an opportunity last year to at last bring their work before the public.

Great difficulty was had in selecting the title and determining the scope of this one. Finally it was decided to call it the "Novelties" Exhibition; to hold it in the Electrical Exhibition building in West Philadelphia; to open it on September 15, and close it with the 31st day of October, 1885. The Board were very careful to express themselves so that no misapprehension could exist as to their interpretation of the meaning of the word "novelty" as used by them. The qualities that any invention must have to claim admittance are, (1) novelty; (2) merit; and that merit must be sufficiently high "to redeem the article from triviality."

While it is desired to allow the greatest latitude as to the kind of appliances to be exhibited, yet there will be exercised a most rigorous exclusion of the innumerable gimeracks that are nowadays commonly classed as novelties. It is desired to make this exhibition equal the same high standard that all previous ones have attained, and so to attract inventors and convince them that it will be well worth while for them to be represented there.

Unlike the plan pursued at the Electrical Exhibition, medals will be awarded at the "Novelties." The premiums will be: (1), The silver medal of the Institute; (2), the bronze medal of the Institute; and (3) a diploma or certificate of honorable mention. Besides those there will be awarded a "Grand Medal of Honor," to be given to the invention or discovery shown at the Exhibition which shall be held to contribute most largely to the welfare of mankind.

Here, it seems, is a chance for gas men to make a comparative showing against electricity, and we do not believe that such another opportunity will soon occur again. In no other branch of the industrial arts has more progress been made of late years than in that of the improved application of gas for purposes of illuminating, heating, motive power, etc. It is earnestly hoped that all that is new in such appliances will be represented; and also—and of this we have little doubt—that a great many devices that we have not yet heard of will be brought out there. The advantage of this exhibition as a means of familiarizing the public with any new inventions are very great and desirable when looked at from an advertising stand-point; and the auspices are such as are rarely found by inventors who desire to give publicity to some valuable discovery.

Already, we are glad to say, applications for space are coming from manufacturers of gas apparatus at home and abroad. In the department of illumination it is expected that competition will be especially warm. The Siemens, the Lowe incandescent, the Albo-carbon, and many other gas burners are now on the list, and the electric lamps are as numerous as usual. Many new and interesting features are looked for in the apparatus for heating and cooking, and in the recent devices for utilizing gas in some of the finer industrial work.

Let it be understood that all discoveries and inventions whether of process or of apparatus are eligible. Everything in gas manufacture, or its distribution and use, from a furnace to a burner tip, and all methods of utilizing otherwise wasted products, or for enriching, or purification, etc., will be received—provided, of course, they have the necessary qualifications of novelty and merit.

It is gratifying to the managers of the Institute to be able to now offer gas an opportunity of displaying its merits side by side with electricity; this, with the exception of a slight concession, they were unable to do last fall. We hope the gas fraternity will not be slow to appreciate this occasion. We can assure them that the electricians on their part will leave no stone unturned to demonstrate the cheapness and efficiency of their respective systems; and no half-hearted efforts of the gas men will offset the energy and alacrity of their rivals. We believe that gas can put electricity to shame in nearly all directions of efficiency and economy; and we urge upon those in whose power it lies and whose part it is to accomplish that, to see that it is done so thoroughly as to effectually change the ideas and opinions imbibed by the public mind during the recent "boom" in electricity.

All information as to spaces, blanks for application, regulations, etc., can be had by communicating with "The Committee on Exhibitions, Franklin Institute, Philadelphia, U. S. A."

Thirtieth Annual Report of the Jamaica Plain (Mass.) Gas Light Company.

[On date of April 1st, 1885, President John C. Pratt, acting on behalf of the Directors of the Jamaica Plain Gas Light Company, presented the following (the 30th) Annual Report to the stockholders of that corporation. The statement covers account of operations of the Company for fiscal year ended March 31st last.]

Total receipts were \$54,605.75; expenditures were \$36,624.11; leaving a net profit of \$17,981.64. Out of the profits two semi-annual dividends, each of 4 per cent., were paid. These aggregated \$16,000, and balance carried to surplus was \$1,981.64; which, added to previous surplus, makes that account now foot up to \$34,904.90. Of the total receipts, sales of gas and coke accounted for \$53,051.75; of expenditures, coal and labor represent an amount equal to \$20,511.83. In concluding fiscal details in report (which is a model one), Mr. Pratt goes on to say:

It will be seen from the foregoing statement that the net earnings of the Company the past year are \$17,981.64. The sum of \$752.38 has been expended for the extension of the street mains, required by the laying out of new streets and the consequent increase of consumers; the cost of this has been charged to general expenses.

The reduction of 25 cents per thousand feet in the price of gas on the 1st of July has resulted favorably—the falling off in receipts from that source being about 3 per cent., while the reduction on the consumption of the previous year was equivalent to 10 per cent.; and our surplus has increased, after paying dividends, in the sum of \$1,981.64, and is now \$34,904.90.

Our actual liabilities, after deducting cash and assets, are reduced to \$8,616.21; which is certainly a gratifying exhibit.

Our average yield of gas to the pound of coal has been 4.72 feet.

We have sold 1,220 chaldrons of coke—being 49 per cent. of the whole quantity made.

We have had in use two benches of retorts 215 days of the year, and three benches 150 days.

The works of the Company are in most excellent condition. A new steel boiler has just been purchased and set in place of one that was worn out.

The policy of the Company has been to furnish gas to our consumers at the lowest possible price consistent with fair and regular dividends; hence, as our business and profits have increased we have not given it to our stockholders in larger dividends, but have given it to our customers by making constant reductions in price. This we believe to be a wise and just policy. We hear complaints occasionally that our price for gas is higher than it is in the city proper and other large places. The answer to these complaints is simple and conclusive. We have about 20 miles of street mains, with an average of 40 consumers to the mile; in thickly settled places the average is ten times that number.

We could, with our present street mains, supply ten times the number of consumers we now do, and should require only a small addition to our capital and plant, a comparatively slight increase in labor, and the additional coal required; with such an addition to our business we could furnish gas as cheap as it is sold anywhere. It is for this reason that, as our business increases from year to year, we are able to reduce our price. There is no other industry where the price of the commodity manufactured is so largely dependent upon the quantity sold as is the gas industry.

A great deal of senseless talk is heard at the present time in favor of competition by the organization of new companies, with a view of obtaining lower prices. An intelligent man who carefully investigates the subject cannot honestly advance such an opinion, because the facts are all against such a conclusion. No one can dispute that one company in any community, with sufficient capital and plant, can manufacture and deliver gas cheaper than two companies in the same territory, with the capital, plant, mains, taxes, salaries, and other expenses duplicated and the business divided. The effect of competing companies occupying the same territory has been to render cheap gas practically impossible.

In many places, in response to an unintelligent public clamor, rival companies have been organized; and the public has not been the gainer by it. For a while, in some cases, sharp competition has ensued, and lower rates obtained; in a short time, however, combinations of the new and old companies have been formed, rates agreed upon no lower and often higher than before; and the public has enjoyed the combined monopoly of two or more companies instead of one, and had the satisfaction of paying in its gas bills the interest on double, or it may be four times, the previous capital. This has been, and always will be, the result of planting two or more companies where one is adequate to furnish all the gas required.

If it is charged that gas companies are extortionate in their charges, unjust or oppressive in their treatment of their customers, the people have the remedy in their own hands. Let the gas companies be placed under the most rigid supervision of the State; let a commission of able and disinterested men be appointed, who shall be a board of arbitration to hear and investigate all complaints by consumers, of bad management or neglect of duty on the part of the gas companies; to give full information of the condition, business, and profits of gas companies, by the publication of their accounts; to fix the price and establish the quality of gas sold; to give the consumer what he is entitled to—namely, full information with regard to what is now a necessary of life.

A bill for the appointment of such a commission is now pending in the Legislature, and the gas companies, with one accord, are urging its passage, believing it to be for their interest as well as that of the people; giving, as it will, protection to every fairly and honestly managed company, and dispelling many popular fallacies as to the business, profits, and general management of gas companies.

Torpedoes and Oil Wells.

An exchange, in speaking on this subject, says that on August 28th, 1859, or almost 26 years ago, Col. Drake completed drilling on the flats near Titusville, Pa., the first oil well ever sunk in the United States. It was, compared with some of the great wells afterwards discovered, a "small affair," pumping only 25 barrels of oil a day, but it was sufficient to cause an influx of adventurers from all parts of the globe, rivaling anything known in the gold excitement of '49. Thousands of wells were soon put down along the banks of Oil Creek, and every day brought forth some new phenomenon in the new industry. Among other things it was discovered that one well sunk within a few feet of another already producing was not certain to get oil. Often one dry hole was drilled in the space between two flowing wells. This fact and others gave rise to the "crevice theory," which, turned into common English, means that the oil is not always held, as water is, in a sponge,

in all the rocks in which it is found, but runs through the rock in seams or veins. These veins of oil wind through the strata of sandstone by thousands, and in zigzag, tortuous courses. Now, although these veins are very close together, it is possible that the drill can enter the rock and pass through it without touching or breaking one of them, and hence the well is dry. It occurred to several men independently and about the same time that were a torpedo lowered into the well-hole and exploded at the bottom it would shatter the rock and open the fissures to the oil veins. Of the several men who had the idea only one carried it to practical results. In 1865 Col. E. A. L. Roberts, of the Army of the Potomac (now deceased) visited Titusville with six torpedoes which he had constructed in the fall of the previous year. People looked upon the invention rather oddly at first, and it was not until the 21st of July, 1865, that he was allowed to put two of his torpedoes in the Ladies' well, on the Watson flats, to the east of this city. The well had been pumping oil, but after it had been torpedoed it commenced flowing. People began to think there might be something in this torpedo after all, and in December, 1866, one was lowered into the Woodin well, on the Blood farm, and exploded. The well had never produced a drop of oil, but it now commenced yielding from eight to forty barrels a day. One month later another torpedo was used, and the production of the well increased to eighty barrels. This assured the success of the torpedo for purposes other than destroying ships by blowing them up. After the result at the Woodin well the torpedo came into general use throughout the oil region. A company was formed with a capital of \$300,000 to work the patent, and a torpedo factory was erected in Titusville. The effect of torpedoes upon the production of the oil regions was marvelous. At the time the Woodin well was shot (1866) the production of oil was declining rapidly, and alarmists were predicting a speedy collapse of the petroleum industry. With the introduction of the torpedo the condition of affairs rapidly changed. In the summer of 1867 the output of the wells on Oil Creek was increased many thousands of barrels. In 1866 the total production was 3,697,527 barrels. Wells that had never produced a drop of oil were torpedoed and caused to flow; wells of small productions were converted into "gushers;" and old wells nearly exhausted were revived, and in their second lease of life did more than ever before. But the great part played by the torpedo in the oil business did not really begin until the opening of the Bradford field in 1875. The sand in this field is blackish and hard, and yields its oil reluctantly. The district, however, is of great extent, and contains thousands of wells that have been steadily producing for years. Had it not been for the Bradford field the immense stock of oil above ground now amounting to 38,000,000 barrels (of 42 gallons each), would not be. It is safe to say that fully one-half of the production of this field is directly due to torpedoes. There are to-day nearly 20,000 producing wells in the oil regions, and there are thousands of exhausted wells abandoned, and their derricks slowly rotting. It is estimated that on the average three torpedoes have been put in every well drilled. Many wells are torpedoed pretty nearly every month for the purpose of cleaning away the paraffine in the hole, opening fresh fissures in the rock, and thus maintaining the production of the well. The Medock well, on the McGuire farm, in the Church run district, near Titusville, was torpedoed twenty-four times. The first torpedoes were comparatively inoffensive when compared with those now in use.

The torpedoes with which Col. Roberts made his first experiments in the Ladies' well and the Woodin well were small cylindrical tin tubes, from four to six inches in diameter, and holding a few pounds of gunpowder. These were lowered into the well-hole, covered with water so as to prevent the force of the explosion from acting upward, and were fired by means of a weight dropped upon a fulminating cap fixed at the top of the torpedo. Later on nitro-glycerine was substituted for gunpowder, and the charge of explosive increased until now torpedoes containing as much as 350 pounds of nitro-glycerine are not uncommon. A few days ago such a charge was used at the Markham well in Thorn creek, and the explosion was felt for 75 yards on the surface around the well-hole. The torpedo was down 1,600 feet in the earth. Thousands of pounds of nitro-glycerine are daily used in the oil wells; indeed, nitro-glycerine was first brought into commercial use in the oil regions.

In 1847 Shonbein discovered gun-cotton. This was immediately followed by the discovery of a score or more of analogous explosive substances, such as starch, dextrine and sugar, with a mixture of nitric acid and sulphuric acid. The manufacture of nitro-glycerine was described as early as 1847. On July 27 of that year a paper was read before the French Academy detailing how to make from glycerine an explosive "analogous to fulminating cotton." The process is to cool a mixture of two volumes of sulphuric acid, density 66° Baume, and one volume nitric acid, density 43°, in a freezing mixture, and into this pour glycerine, with agitation so as to prevent elevation of temperature. The entire mixture is to be emptied into water. The nitro-glycerine collects as an oily liquid at the bottom of the water. Throughout the oil regions there are many manufactories of nitro-glycerine. When a well is ordered to be "shot" a wagon, constructed in numerous small padded compartments, each large enough to hold a tin containing three or four

pounds of the explosive, departs from the magazine with as many quarts of nitro-glycerine as may be needed. At the well the contents of these cans are emptied into a long torpedo, and this is lowered into the hole. The greatest care is needed to avoid explosion, for the compound goes off with a very slight blow. Accidents, of course have been numerous. Only a few weeks ago 6,000 pounds of nitro-glycerine exploded in a factory near Bradford; several men were present at the time, and all that remained of them, a few pounds in weight, could have been put in a bureau drawer. Materials subjected to the action of this fearful explosive seem to be vaporized. Another strange thing to be noted about nitro-glycerine explosions is that the force acts principally in a downward direction, scooping an immense hole in the ground.

Red Lead in Steam Pipe Joints.

Despite what should be a thorough acquaintanceship with the subject, owing to familiarity with it, many good mechanics nevertheless have very incorrect ideas with regard to using red lead in steam pipe joints. The fundamental principle of all joint making is, that the thinner the joint the more durable will it be. With flat-faced joints, as in pipe flanges, cylinder covers, etc., each face must have all the old lead removed, and then wiped over with a piece of oily waste (boiled linseed oil). The lead must be thoroughly worked, either by machine or by hand, to make it soft and pliable, and also to remove all grit and lumps. It should then be rolled in the hands into thin ropes, about one-quarter inch diameter, and laid on once round inside the bolt holes. The two faces must now be brought together carefully, and tightened up equally all round by screwing up opposite bolts, so as to avoid getting one side closer than the other. Tar twine, hemp, string, wire gauze, etc., should be studiously avoided wherever possible, as it prevents the faces from being brought into close contact. There are certain rough jobs where it may be permitted, but a joint so made is never so durable, and is very clumsy. When joints are accurately faced, by scraping or otherwise, as in locomotive practice, nothing but liquid red lead is used; made of red and white lead mixed with boiled oil to the consistency of paint, they are of exceptional durability. Joints between male and female threads, such as screwed pipes and sockets, bolts or studs screwed into boiler plates, etc.—in these cases liquid red lead is used, and should be put on the female thread for inside pressure, on the male for outside pressure, as then the steam in each case forces any surplus lead into the thread, and forms a more reliable joint, or rather assists it; whereas, when it is applied in the reverse way, as generally done, the threads are left quite bare and clear, leaving nothing to assist the joint. These methods, broadly speaking, apply just the same to the various compositions sold as substitutes for lead, the chief advantages claimed for them being cheapness and durability; but they can never surpass, nor even equal it, if it be only used as explained, especially if a little common sense be applied in special cases.

Fireproof Doors.

A contemporary points out that the most efficient fireproof doors are those made from wood and covered with tinned iron. The door is made of two thicknesses of tongued and grooved boards, crossing each other diagonally and thoroughly nailed together. The sheets of tin are bent over at the edges, forming locked joints as in a tinned roof; it is important that the edges, as well as the sides of the door, be covered, as its resistance to heat lies in the fact that the fire cannot burn the wood thus protected against exposure to the air, nor can it warp it, as is the case with an iron fire-door subjected to slight heat. If a fireproof door is hung on hinges, especial care must be taken to insure their security by fastening them to the door by means of bolts, rather than screws, and connecting them to the wall in an equally secure manner. The latches should be selected with a view to durability, as such a heavy door is apt to be destructive of weak latches. Where the position of the doorway permits sliding doors, it is preferable to have them on tracks, care being taken that cleats be placed on the floor each side of the doorway, so as to secure the door at its lower corners when shut. In the Boston Storage Warehouse, U. S., there are a large number of such doors in the fire walls, arranged to close an electric circuit when they are all shut, and the fact is recorded on the paper dial of the watchman's clock at certain intervals. Doors are frequently arranged to close in advance of a fire by means of the yielding of the alloy fusible at 160° F. The track upon which such a door is hung inclines about 1 ft. in 8 ft., and the door kept from closing by means of a round stick about 1 in. in diameter, which reaches from one edge of the door to the opposite side of the door frame. At the middle the stick is cut in two diagonally, and a ferrule made of two pieces of thin copper soldered together longitudinally with the fusible alloy, covers the joint in the stick. When this ferrule is exposed to a temperature of 160° F., its yielding causes the ferrule to split open, and the stick separates into pieces and allows the door to shut. In order that the stick shall not fall in the way of the

door, and that the door may be shut at any time, the stick is connected to the door frame by small chains near to each end. This simple device was designed by Mr. Lewis T. Downes, President of the What Cheer Mutual Insurance Company. Another method of utilizing this fusible alloy to close fire-proof doors and shutters is by means of a wire extending around the room, and containing in various places links made of two pieces of brass soldered together. When the solder melts and allows the two pieces of brass to separate, the wire allows the shutter or door to close. Mr. Frederick Grinnell has improved the ordinary link by cutting a slot in one of the pieces of brass and laying a short bit of wire therein when they are being soldered together; the solder flowing around this wire presents a resistance in three planes, in place of the ordinary joint, which may be imperfect and lies in a single plane concealed by the sheet brass so as to prevent inspection. Formerly solid links of fusible alloy were used; but the metal has so little resilience that it is apt to gradually lengthen and finally break at some inopportune time.

Recovery of Sulphur.

Engineering "notes" that chemists connected with the alkali manufacture have long sought for some thoroughly practical and economical process for recovery of the sulphur which is finally contained as calcium sulphide in the "waste" of the alkali works. Many processes have been worked out and tried with more or less success, several leading chemists having devoted themselves to researches on the subject; but so far no method has given complete satisfaction. It is now more than ever important that some such relief should be given to the hard-pressed Leblanc soda process as would result from enabling its users to dispense with a great part of the pyrites they now purchase, and probably there is at present more study and attention being devoted to the matter than ever before. One proposal recently made, and embodied in a German patent, is to obtain sulphur from the "waste" by first decomposing it so as to obtain sulphuretted hydrogen gas, and then to pass this gas over heated sulphates of alkali or alkaline earth. A reaction then takes place by which the oxygen of the sulphate combines with the hydrogen of the sulphuretted hydrogen, forming water, while at the same time free sulphur is produced, and the sulphate is reduced to a sulphide. If air is then passed over this residual sulphide, the heating being kept up, oxygen is again absorbed, and the sulphate renewed ready for the reaction on a fresh lot of sulphuretted hydrogen. In practically carrying out this process gypsum (calcium sulphate) is used, packed in pieces in a system of pipes or retorts heated to redness, through which alternate currents of sulphuretted hydrogen and air can be passed, the exit end being connected with a condenser for the liquid sulphur. The reaction which takes place in this case is shown by the chemical formula $\text{CaSO}_4 + 4\text{H}_2\text{S} = \text{CaS} + 4\text{H}_2\text{O} + 4\text{S}$. The flow of sulphuretted hydrogen gas is so regulated that there is always an excess of it present, in order to prevent any chance of the oxidization of any portion of the liberated sulphur. The gas which thus passes in excess, and is not decomposed, is drawn back again and repressed with the rest of the sulphuretted hydrogen, so that it is not lost. When all the gypsum in one set of retorts is reduced to calcium sulphide, as shown above, the sulphuretted hydrogen is passed through another set, while the calcium sulphide is again oxidized to sulphate, and again made ready for its work. During this reoxidation of the calcium sulphide a considerable evolution of heat takes place in the retorts or tubes, and this heat is utilized by so combining two sets of apparatus that the heat thus produced in one set is used for keeping up the temperature of the other.

ITEMS OF INTEREST FROM VARIOUS LOCALITIES.

PRESIDENT CROCKETT EXPLAINS THE STATE OF AFFAIRS AT SAN FRANCISCO, CAL.—In our "Item" columns in issue of May 2d we informed our readers that the San Francisco Board of Supervisors seemed inclined to make trouble for the gas makers doing business in the modern Eldorado. It would of course be decidedly strange should the members of any municipal body in this country seek to do aught else than make trouble for the gas purveyors established nearest them, since it goes without saying that our "city fathers" love a shining mark, and always seek to aim thereat. In that "item" we also invited President Crockett, of the San Francisco Gas Light Company, to forward us information as to what final conclusions the Supervisors had arrived at in regard to the fixing of gas rates at Frisco. Mr. C. responded in the most generous style and with great promptitude (we had his reply on date of May 18); but owing to the pressure on the JOURNAL's columns for issue of June 2d we were obliged to defer publication of the facts vouchsafed until the present time, and were led to this course through thinking that it would be better to print them *in extenso* now than give but a mere summary of them then. Mr. Crockett—who, by the way, has proved himself a regular jewel to the directors of the San Francisco Company—tells the story in the following manner:

"To the Editor AMERICAN GAS LIGHT JOURNAL:—Having noted, in your issue of May 2d, that you rather take us to task for not keeping you somewhat better informed as to gas matters on the Pacific Coast, I have determined to forward you some particulars in the attempt to give you an insight into the peculiar and unsatisfactory conditions prevailing in the business of gas manufacture in the State of California.

"In order that the leading features be made plain, I will inform you as to the gist of the legal measure known as the 'Coffey Act,' which legislation received the official seal on the first day of March, 1878. This act provides that in all cities in the State of California having a population of 100,000 or more inhabitants, the local legislative bodies thereof be thereby authorized and required to fix the 'standard quality and illuminating power of gas to be supplied, and the rate and price to be charged for each 1,000 cubic feet thereof, by any person, or company, or corporation whose pipes or mains are or shall be laid down in the streets or highways of such city for the purpose of supplying gas for the use of such city, or for the inhabitants thereof; provided, however, that the illuminating power of the gas shall not be less than 16 candles, and the rate to be charged for gas shall not exceed three dollars per thousand.' It also contained provision for the appointment of an inspector—his salary to be paid out of the funds contained in city's treasury—whose duty it would be to make a test of the gas at least once a week, and without having given prior notice to the company of the dates on which the tests were to take place. It further stipulated that the rate or price should not be fixed oftener than once a year, and also provided for the infliction of a penalty, in the shape of a fine of not less than \$100 nor more than \$1,000, for each violation of the clauses of the act.

"Shortly after the passage of this measure an attempt was made by our Supervisors to compel a reduction in gas rates of 25 cents per thousand, or from \$3 to \$2.75. The Supervisors did pass such an ordinance; but we met this with the claim that the 'Coffey Act' was unconstitutional, since it was in the nature of special legislation, and as such was prohibited both by the letter and spirit of the State Constitution, we refused to recognize or obey the mandate of the Board. We accordingly continued to adhere to the \$3 rate, and as no one contested the legality of our position, we went on as before, without hindrance or molestation—in fact, it was just as if no ordinance had been passed.

"In the year 1880, as an outcome of our labor troubles here, and during the time that Denis Kearney was posing as a leader of the oppressed, we were inflicted with what was called the *New Constitution*; and this, in reality, was nothing short of an instrument the real purport of which was designed to ruin corporate interests in the State of California. In Article XI., Section 19, of this beautifully grand specimen of man's great intelligence was to be found the following:

"In any city where there are no public works owned and controlled by the municipality, for supplying the same with water or artificial light, any individual, or any company duly incorporated for such purpose, under and by authority of the laws of this State, shall, under the direction of the Superintendent of Streets, or other officer in control thereof, and under such general regulations as the municipality may prescribe for damages and indemnity for damages, have the privilege of using the public streets and thoroughfares thereof, and of laying down pipes and conduits therein and connections therewith, so far as may be necessary for introducing into and supplying such city and its inhabitants either with gas light or other illuminating light, or with fresh water for domestic and all other purposes, upon the condition that the municipal government shall have the right to regulate the charges thereof."

"Of course this action could not apply to us, as our franchise had been granted prior to the adoption of the new Constitution; but there is a difference of opinion amongst lawyers in regard to the possible effect it might have upon the opposition company here—some of the expounders contending that a prior section in the constitution requires legislation to make it operative, while others hold that the section is operative in itself.

"After three years of hard fighting between the opposition and ourselves, during which time both corporations sold gas to consumers at \$1.50 per thousand, we agreed upon the terms of a 'treaty of peace.' After much agitation of the matter, and as a result of earnest deliberation, we agreed upon the rate of \$2.25 per thousand as being a price that would be fair to the consumer and reasonably (not any more) profitable to the companies. Of course, this figure being an advance of 50 per cent. over the rate obtaining during the opposition warfare, the dear public howled lustily and lengthily. The dolefulness of the yawp smote upon the ears of the Supervisors (a new Board had just been seated at the time the armistice had been agreed upon), who speedily concluded that 'they must at once do something for the people.' They went to work with a will, and the result was that two ordinance measures were introduced, or proposed, by the lighting committee—one recommending that the rate be fixed at \$2, while the second proposition displayed a still greater generosity in the disposition of other people's money, since it was sought by it to put the selling rate at \$1.75.

"In response to an invitation from the Committee I appeared before them and presented a comparative statement showing the cost of material, labor, etc., in Eastern cities as against the cost of same in San Francisco. I proved, although we did receive a much larger sum for our residuals—coke, tar, and ammonia—than was obtained by the Eastern gas maker, that our net cost for coal was 57 per cent. greater than his; that our labor charges—at \$3 for firemen, \$2.50 for helpers, and \$2 for ordinary labor—were 35 per cent. greater; and that our retorts, mains, services, and meters, owing to freight and insurance charges, cost us 35 per cent. more; yet, taking the average price of gas in fourteen of the largest Eastern cities at \$1.73 per thousand, and considering that our rate was but \$2.25, we were only charging 30 per cent. more for our San Francisco gas. Indeed, taking everything into consideration, we were selling our gas very cheap.

"After a *patient and exhaustive* examination—lasting just one hour and a half—the Committee (the members whereof had never been nearer the inside of a gas works than the fence-walls) were so well informed on the subject of the cost of manufacture and distribution of gas as to immediately recommend that the rate of \$2 be fixed upon as the price to be charged per thousand cubic feet from and after July 1st, 1885. This ordinance was passed by the Board and signed by the Mayor; but as yet the San Francisco Gas Light Company has not determined as to whether it will accept or reject the ordinance. In case the latter conclusion is reached the matter of its legality will at once be tested in the courts.

"This will give your readers some idea as to how the business of gas manufacture is hampered on the Pacific Coast by the most ill-advised sort of adverse legislation."

We thought matters of this sort were pretty loosely handled "up East," but it would, indeed, be rather rough if, for instance, the New York city Board of Aldermen had the power to regulate selling rates for gas in the metropolis—to say nothing at all about the "City Fathers" of Brooklyn and Boston. In the extract taken from the California "new constitution," as forwarded by Mr. Crockett, we would like to call particular attention to the words, "illuminating light." Perhaps some of the California agitators (possibly even the great "Dinis" himself) had just returned from an Eastern trip, during the continuance of which he had been inspecting the arc light. That often furnishes specimen bricks of a "non-illuminating light."

CHEAPER GAS FOR DAYTON, OHIO.—Mr. Geo. M. Smart, Secretary of the Dayton (Ohio) Gas Light Company, writes us that from and after July 1st, 1885, the gross selling price of gas will be reduced to \$1.70 per thousand. From that charge a discount of 20 cents per thousand will be granted to consumers who will settle their accounts at the office of the company on or before the 5th day of the month in which the bills are presented. One rate is the rule at Dayton, no matter whether gas be employed as an illuminator, or for domestic or power purposes. In 1882 the price of gas at Dayton was \$2.25. Comment is needless, and it is pretty near time that every gas man in the country had become familiar with the fact that there is more money to be made out of low than high rates. Brother Smart knows what he is about every time.

AND SO DOES BROTHER FORSTALL.—The Consumers Company, of Chicago, Ills., has been trying to borrow money for betterments, extensions, etc., "you know;" and judging from what the "financial man," of the *Chicago Tribune* wrote in his article of June 4th, they do not appear to be meeting with any great success in "raising the wind" through the instrumentality of the collateral which they offer to investors in exchange for the cash. The financial man wrote as follows: "The time during which the holders of the common stock of the Consumers Gas Company had the precedence over outsiders in the matter of subscribing for the proposed preferred stock has expired, and there are 60 days yet in which the books remain open for subscriptions by the public in general. It is not known how much of the stock has already been taken, but the management of the company say they have no anxiety in regard to the success of the experiment. It is claimed by some of the local brokers that only \$25,000 of the \$1,000,000 has been taken. It has been asserted all along that capitalists—presumably Philadelphians"—[ah! indeed!] "were ready to take the entire issue. The management of the company say they are extending their plant very fast, and that they have put in 1,000 meters since the 1st of January. There is a report that the old company are considering the question of holding out the olive branch, and they will propose that the two companies agree on \$1.50 per 1,000 as the price of gas." Philadelphians were going to take the entire allotment of the preferred stock? There be both fools and knaves in Philadelphia, and the fools did not get much out of the Chicago opposition deal. Now, it is well known that knaves are not to be sneezed at in the game of euchre; their power is mighty and would be absolute in all cases were it not for the fact that the joker—the man who introduced that feature in euchre playing could not have fancied the knaves—"takes them in;" and we are inclined to believe that Messrs. Watkins and Forstall "have cut the pack so cleverly" that the joker "fell to them in the deal." The "insiders," accord-

ing to the financial man's way of thinking, have about got enough, despite that 1,000 meters put in since January 1st; and the "outsiders" do not display any remarkable celerity in attempting to become "insiders." Wise outsiders; that is the side to be on. But as the last statement in the "financial man's" paragraph is to the effect that the old company "are" going to hold out the olive branch (it used to be called the white feather), how is it that the "preferred stock" goes begging for buyers, and why is it that such an absurd lie should have been telegraphed to every newspaper affiliated with the Associated Press? [The financial man's "yarn" appeared in all the leading newspapers of the United States on morning of June 4th.] The olive branch that is to be held out to the Consumers' managers in reality is nothing else or other than a hardy specimen of the genus *Urtica*, otherwise known as the nettle family. The sharpest thorn on the specimen cultivated by Messrs. Watkins and Forstall has been named by them "dollar gas," and it has been drawing blood steadily. To show that it has not lost its cunning, and that it is likely to do further duty in piercing the "insiders," we here reproduce a reply made by Mr. Forstall to the "financial man's" paragraph:

OFFICE OF THE CHICAGO GAS LIGHT AND COKE CO., }
CHICAGO, ILLS., JUNE 4, 1885. }

"Editor *Tribune*:—In the financial article of this morning's *Tribune*, at the close of a paragraph, the following statement appears: 'There is a report that the old company are considering the question of holding out the olive branch, and they will propose that the two companies agree on \$1.50 per 1,000 as the price of gas.' This is the first intimation which has reached this company of any such report, and no such report could exist except in the mind of the instigator of the paragraph, to whom the wish must be father to the thought. This company reduced the net price of gas to \$1 per thousand deliberately, after mature consideration, with the expectation that increased consumption and improved methods of manufacture would make this price moderately profitable. The result has fully justified its hopes and confirmed the wisdom of the policy adopted. There is neither desire nor intention to reverse it; nor does the suggestion that the price should be raised come with good grace from the philanthropists who engineered the Consumers' Company in behalf of the 'downtrodden gas consumers of Chicago.' We therefore emphatically deny the statement quoted; and in proof of its falsity merely announce the fact that this company will make contracts to supply consumers with the best quality of gas for five years at a net price of \$1 per thousand cubic feet. THEOBALD FORSTALL, Vice-President."

Does it not look like as though the Philadelphians had reason to stay where they are? They had the first pull at the Chicago orange; and they don't like lemons "straight," although they probably will be glad to get even lemons before long. The Louisville (Ky.) olive branch bearers had also better look to their future, for as Forstall has done at Chicago so can Barret do at Louisville.

WATER PIPE FOR FLATBUSH, L. I.—The Flatbush town authorities have authorized that a contract be entered into between the township and the local water works company empowering the latter to erect 50 fire and 20 public drinking hydrants at a certain stated price. In order to locate all the hydrants the main system of the water works company will need an addition of about nine miles of pipe. It is understood that the sizes to be contracted for are: Main water-way, 12 inch; lateral conduits, 10, 8, and 6 inch.

SOMETHING FROM SOMERVILLE, MASS.—A well authenticated statement reaches us that Somerville is threatened with the erection of a water gas plant. As we understand it, there is no separate gas works at Somerville, but that its inhabitants are supplied from the mains of the Charlestown and Cambridge Companies. Somerville, owing to its peculiarly odd collection of hills, should be an excellent place to show what a wretched substitute would be afforded by a change from coal gas to water gas.

REDUCING PRICE OF GAS AT COLUMBUS, GA.—Acting under the authority of his board of directors, in pursuance of a resolution passed May 21st, Mr. E. H. Jenkins, Superintendent of the Columbus Gas Light Company, gave notice to the patrons of the corporation that from and after June 1st the discount granted to consumers who settled their accounts on or before the 7th day from presentation of bill would be increased to 16½ per cent. The gross price for gas remaining as before, at \$3 per thousand; but the additional discount now allowed means a virtual reduction of 25 cents per thousand. Mr. Jenkins writes that the 25 cent decrease in selling rates made last October resulted in a decided addition to the number of consumers, and he is now thoroughly convinced of the good policy of selling cheaply. The Columbus Company makes a special rate for gas used in cooking stoves, and a determined effort is being made in the direction of increasing this class of output. In fact the Southern gas men have become thoroughly alive to the necessity of fostering summer day consumption, and it is a trifle strange they did not realize its importance years ago.

IT GAVE UP THE GHOST.—The Charleston (S. C.) Electric Light Company, organized in 1881, with a paid up capital of \$125,000, recently decided to suspend operations. Those interested—that is, they were interested once, but are now disgusted with it—in the scheme attribute the failure to losses incurred in a “fight” with the Charleston Gas Light Company. Gentlemanly “Tom.” Turner knows pretty well how to carry on a “fight” of that sort, and a few of the water gas raiders are well qualified, through experience, to bear out this statement. All the shares of the defunct electric lighting company were held in Charleston.

TO BUILD A NEW WHARF.—The management of the Philadelphia (Pa.) Gas Trust propose building a new wharf at the station known as the Twenty-fifth ward works. It is estimated that the cost of constructing same will approximate to \$35,000. That a new wharf should be erected there admits of no dispute.

THE OHIO INSTITUTE OF MINING ENGINEERS.—The summer meeting of this Association will be held at Jackson, Ohio, on dates of June 16, 17 and 18. Headquarters are to be at the Isham House. We wish to acknowledge receipt of invitation to sessions from Mr. Emerson McMillin, of Columbus, Ohio—who, by-the-way, is President of the Institute—and regret that we cannot visit the Buckeye State this week. “Mac.” is down on the programme as the contributor of a paper on “Natural Gas.” We will here convey a gentle hint to the effect that the readers of the JOURNAL would like to see that paper reproduced in these columns. There is hardly any necessity for wishing that a profitable and enjoyable time be had at Jackson, since it goes without saying that such is sure to be the case.

ANOTHER ORIGINAL THIEF.—Not long ago we were called upon to chronicle the case of a pair of knaves who stole a large quantity of copper conducting wire, stripping it from the poles of one of New York city’s electric lighting companies, and thought it was a very unique sort of thievery; but the operations of the knave or knaves who, during the last three or four months, have carried away 30 of the public lamps belonging to the village of Edgeware, S. I., should receive proper credit for their originality. The officials of the place have been unable to capture the thief or thieves.

ATHLETIC SPORTS AT NIGHT WITH ELECTRIC ILLUMINATION.—A great fuss is being made over the affair held on the grounds of the Williamsburgh Athletic Club (Brooklyn, N. Y.) on the night of May 20th. The “Club” owns its own electric plant (it is rated to maintain 8 high-power arc lights), and determined to give an outdoor exhibition of athletics—running and walking matches, vaulting, sparring, etc.—on the evening above noted, relying solely for illumination of the grounds, track, etc., on 5 arcs. The track is one-fifth of a mile in circumference, and the lights were disposed to the best possible advantage. Now, we should not have thought it worth while to allude to the exhibition then given were it not that the newspapers, and also some few of our technical journals, had given the exhibition no small meed of praise, and characterized it as having been thoroughly successful. The writer was present during the exercises, and without speaking unfairly may say that 20 electric arcs similar to those in use on the occasion would about half accomplish the lighting effect needed; and the further prediction is here made that it will be a long time before the Williamsburgh Athletic Club’s management will duplicate the fizzle of May 20th. They may try the experiment of night games, with electric lighting accompaniment; but it will not be done *with five lights only.*

SOMETHING FROM DELAWARE, OHIO.—On the evening of Friday, May 29, a lawn fête was held at Monnett Hall, Delaware, Ohio, in honor of Miss Therese Kyle, who is about to leave her home and enter on missionary work in far-off India. Mr. C. M. Converse, Secretary of the Delaware Gas Light Company, had charge of the lighting arrangements, which were satisfactory in every respect.

TWO TESTS OF PEERLESS GAS COAL.—The *Virginias*, in speaking of the gas coal mined by the Chesapeake and Ohio Railway from veins whose outcrop appears but a short distance away from Winifrede Junction Station, West Va., gives the following statement of tests made:

Test No. 1.—Richmond (Va.) Gas Works, 1875.—Yield in gas per ton of coal, 10,281 cu. ft.; candle power of gas product, 17.

Test No. 2.—Cincinnati (Ohio) Gas Works, 1884.—Weight of coal per bushel, 70 pounds; gas yield per ton of coal, 11,424 cubic feet; gas purified per bushel of stone lime, 15,000 cubic feet; candle power of gas product, 14.75; coke, 36 bushels; breeze, 1 bushel. The “Peerless” coal was formerly known as “Honston.”

POSSIBLY A COMMISSION.—It looks very much as though the Massachusetts State Legislature will pass some sort of a gas commission measure before final adjournment.

Correspondence

[The JOURNAL is not responsible for the opinions expressed by correspondents.]

Suggesting a Remedy.

OFFICE OF LOS ANGELES GAS COMPANY,
LOS ANGELES CAL., May 25, 1885.

To the Editor AMERICAN GAS LIGHT JOURNAL:

In reading over the proceedings of the last Annual Meeting of the New England Association of Gas Engineers, as published in previous numbers of the JOURNAL, my attention was particularly attracted to that portion of the discussion* which referred (I am quoting from memory) to the passage of air through main pipes and services at about the time when idle purifier was put in work—or towards dusk on winter afternoons. It seemed to me that this might be very easily avoided by slightly turning cover of centerseal, and so allowing but a small portion of gas to effect an entrance into purifier, with the concomitant effect, of course, of displacing an equally trifling quantity of air. In an hour’s time the seal could be fully turned, and with no perceptible deterioration of the light. Or, did one wish to avoid the trouble of two manipulations of the centerseal, the pipes of purifiers might all be connected with suitable sized wrought pipes fitted with cocks (these last will live out the boxes), the one to idle purifier to be opened an hour before time of changing. The slight leaking experienced by Mr. Stiness with his valve system operated to the end spoken of by me. Unless engineers wish to carburet air for the enriching of their gas, or are desirous of utilizing naphtha in the prevention of naphthaline, it would seem that the course outlined by me is both cheap and simple. I have tried it, and can speak for its efficiency.

Yours truly,
T. A. BATES, Supt.

An Important Notice.

OFFICE CLERK GAS ENGINE CO., 1012-1018 FILBERT ST., PHILA., PA.,
MANUFACTURERS OF CLERK’S PATENT GAS ENGINE,
PHILA., PA., JUNE 10, 1885.

To the Editor AMERICAN GAS LIGHT JOURNAL:

For months past our attention has been called to reports said to have emanated from the agents representing a certain gas engine manufactured in this country. Such reports have been circulated, no doubt, for the purpose of intimidating parties who have a desire to purchase gas engines manufactured by ourselves. We have hitherto refrained from taking notice of these reports, desiring to conduct our business upon business like principles. Recently copies of certain circulars have been sent to us by our friends, and additional reports have reached us which are evidently intended to further intimidate purchasers of the “Clerk Gas Engines.” We do not deem it necessary to enumerate these various statements promulgated by the parties referred to, further than to say that such reports, reflecting upon the character of our engines, and their ability to do all we have stated, are simply false and unwarranted by the facts. We desire to state that we are prepared to protect all persons who may purchase the “Clerk Gas Engine.” This engine will do the work we claim for it equal to, if not better than, any other gas engine manufactured in this country, and will consume no greater quantity of gas in doing it. It is specially designed for constant work, and we guarantee the engine to indicate the power claimed for it. The engine is fitted so that an indicator can be placed on the cylinder; and we hereby challenge any other gas engine manufacturers to a trial as to their ability to prove that their engines will indicate the power claimed for them. We think this plan preferable to the one pursued by the parties referred to. Innendoes and misrepresentations may be considered the best way to conduct competition by some people; we prefer the mode we have suggested. We are prepared to furnish gas engines of from five to thirty indicated horse power, and solicit a favorable consideration of our claims by those who desire to purchase gas engines.

—Advt.

THE CLERK GAS ENGINE CO.

The Market for Gas Securities.

The city gas share market is weak in tone, and the special feature in the trading has been a further drop in Equitable quotations; this latter is now quoted at 116 to 118. We believe it to be worth about 110, and those who managed to sell at the figure of 125—quotation of 30 days ago—made a “right smart turn.” Consolidated is lower, having sold ex-dividend at as low as 92 during the fortnight; the bulk of transfers being made in the 93 region. Trading in the shares lacks volume, and it is probable that not much of a decided move will occur before September. We hold to it that Consolidated is a purchase. The Gas Consumers Association, on the evening of June 4th, met at Delmenico’s, and indulged in a series of characteristic brays. They appear to have taken upon themselves the task of saying who shall or shall not be elected to seats in the Legislature, etc. We might give the Consumers Association a little bit of advice as to how they might do better at Albany in ’86 than they did in ’85. Let them instruct Mr. Sherwood in one or two of the commonest rules of politeness, so that he will not again make the “mistake” of ordering Senators and Assemblymen about as though they were janitors or porters in “flat” houses. Brooklyn gas share list shows great strength in Fulton Municipal and Williamsburgh. At auction, 126 shares Brooklyn gas, at 126; 25 Fulton Municipal, at 160. Balt. Con. is at 41 to 41½.

* See JOURNAL, current volume, pp. 199-200.



A. M. CALLENDER & CO.,

PROPRIETORS.

Editor—JOS. R. THOMAS, C.E

Manager—C. E. SANDERSON.

PUBLISHED ON THE 2ND AND 16TH OF EACH MONTH

At No. 42 Pine Street, New York.

This is a recognized official organ of—

LIGHT, HEAT, STEAM, WATER-SUPPLY,

VENTILATION, SANITARY IMPROVEMENT,

AND GENERAL SCIENCE.

TERMS

SUBSCRIPTION—Three Dollars per annum, in advance.

AGENTS

NEW YORK—AMERICAN NEWS Co. 39 and 41 Chambers St.

BOSTON—S. M. PETTENGILL & Co., 6 State Street.

PHILADELPHIA—PRATT & Co., Corner 9th and Arch Streets.

England—C. W. HASTINGS, 22 Buckingham St., London, W. C

Germany—B. WESTERMANN & Co., of New York

TUESDAY, JUNE 16, 1885.

Gas Stocks.

Quotations by Geo. W. Close, Broker and Dealer in Gas Stocks.

16 WALL ST., NEW YORK CITY.

JUNE 16.

All communications will receive particular attention. The following quotations are based on the par value of \$100 per share.

	Capital.	Par.	Bid	Asked
Consolidated.....	\$35,430,000	100	94	94½x
Central.....	440,000	50	60	70
“ Scrip.....	220,000	—	47	57
Equitable.....	2,000,000	100	113	118
“ Bonds.....	1,000,000	—	107	110
Harlem, Bonds.....	170,000	—	—	—
Metropolitan, Bonds....	658,000	—	110	113
Mutual.....	3,500,000	100	130	132
“ Bon’s	1,500,000	1000	104	107
Municipal, Bonds.....	750,000	—	—	—
Northern.....	125,000	50	50	—
“ Scrip.....	108,000	—	—	—
Gas Co’s of Brooklyn.				
Brooklyn.....	2,000,000	25	127	129x
Citizens	1,200,000	20	86	88
“ S. F. Bonds.....	320,000	1000	106	110
Fulton Municipal.....	3,000,000	100	160	163
“ Bonds.....	300,000	—	104	108
Peoples	1,000,000	10	80	81½
“ Bonds	290,000	—	105	110
“ “	250,000	—	90	95
Metropolitan.....	1,000,000	100	94	96
Nassau.....	1,000,000	25	123	126
“ Cfts.....	700,000	1000	97	98
Williamsburgh.....	1,000,000	50	140	—
“ Bonds... ..	1,000,000	—	110	—
Richmond Co., S. I.	300,000	50	64	75
“ Bonds.....	40,000	—	—	—
Out of Town Gas Companies.				
Buffalo Mutual, N. Y. ...	750,000	100	80	85
“ Bonds... ..	200,000	1000	95	100
Citizens, Newark.....	918,000	50	103	115
“ “ Bonds.	124,000	—	105	110
Chicago Gas Co., Ills... ..	5,000,000	25	128	132
Peoples G. L. & C. Co., ..				
Chicago, Ills		8	12	

Cincinnati G. & C. Co..		180	182
Consolidated, Balt.....	6,000,000	100	41 41½
“ Bonds.....	3,600,000	107	107½
Central, S. F., Cal.....		—	58
Capital, Sacramento, Cal.		56	—
Hartford, Conn.....	750,000	25	123 129
Jersey City.....	750,000	20	145 —
Laclede, St. Louis, Mo.	1,600,000	100	100 105
Louisville, Ky.....	1,500,000	50	95 100
Montreal, Canada.....	2,000,000	100	181 182½
New Haven, Conn.....		25	166 170
Oakland, Cal.....		29	30

WANTED,

A Superintendent for a Gas Works in the South. Gas made from Stone Coal. None but a thoroughly competent, industrious, and sober man need apply. All applicants will be expected to forward first-class references with their applications. Address 624-tt “R. J.,” Care this Journal.

FOR SALE, Second-Hand Gas Apparatus.

The Louisville (Ky.) Gas Light Company wishes to dispose of the following:

- 15 Sixteen-Inch Chapman Valves.
- 6 Twelve-Inch Chapman Valves.
- 2 Twelve-Inch Center Seals & Connections.
- 2 Smith & Sayre Gas Steam Governors.

All in good order, and will be sold at low figures. Address inquiries to A. H. BARRET, Engineer's Office, Louisville (Ky.) Gas Company.

Ammonia Plant for Sale.

Owing to a change in the manufacture of gas by the York Gas Company, we offer for sale our complete plant for the manufacture of sulphate of ammonia from gas liquor. Capacity, 500 lbs. daily, which can be increased to 1,000 lbs. Suitable for a gas works carbonizing from 1,000 to 10,000 tons of coal per annum. We will agree to deliver, set up, and start the same for a moderate price, and show a fair profit. For further particulars address

C. H. DEMPWOLF & CO., 623-4t YORK CHEMICAL WORKS, YORK, PA.

FOR SALE, 100 MINER GLOBE STREET LAMPS.

The lamps have been in use, but only those that are in good order are offered for sale. For terms, etc., address

THE NEW YORK & NEW JERSEY GLOBE GAS LIGHT CO., 615-tf No. 1 Park Place, New York City.

WM. FARMER, ENGINEER, 32 Park Place, Room 36, New York.

THE CHEMIST'S ASSISTANT; OR, KINDERGARTEN SYSTEM OF CHEMISTRY.

A system by which the elements and their valences are represented by illustrations and solid bodies. BOX AND PAMPHLET COMPLETE, \$2.50.

CAST IRON GAS AND WATER PIPES,

From 2 to 48 Inches in Diameter.

FOX & DRUMMOND,

No. 160 Broadway, New York City.



Shafting, Pulleys, HANGERS.

F. Brown's Patent Friction Clutch.

Send for Illustrated Catalogue and Discount Sheet to

A. & F. BROWN,

No. 43 Park Place, New York City.

WELSH "ABERNANT"

Silica Dinas Fire Brick & Cement.

Unrivalled for Endurance Under Intense Heat. Percentage of Silica, 95.64.

Also SCOTCH "BLOCHAIRN" FIRE BRICK.

A. T. CHUR,

SOLE AGENT FOR THE UNITED STATES,

Mills Building, Room 14, Fifth Story, New York.

W. H. DOAN,

REFINER OF

NAPHTHA and GASOLINES

ALSO MANUFACTURER OF

A Special Grade of Naphtha for Gas Companies

FOR ENRICHING COAL GAS.

Correspondence solicited.

No. 43 Euclid Avenue, Cleveland, Ohio.

MITCHELL, VANCE & CO.,

MANUFACTURERS OF

Chandeliers

and every description of

GAS FIXTURES.

Also manufacturers of Fine Gilt Bronzes and Marble Clocks, warranted best time-keepers. Mantel Ornaments, etc.

Salesrooms, 836 Broadway, N. Y.

Special Designs furnished for Gas Fixtures for Churches, Public Halls, Lodges, etc.

The Management of Small Gas Works.

BY C. J. R. HUMPHREYS.

Price, \$1.

Orders to be sent to A. M. CALLENDER & CO., 42 PINE STREET, NEW YORK.

Connelly's Automatic Gas Governors, FOR STREET MAINS.

The Only Strictly Automatic Gas Governor in the Market! No Weights! No Clock! No Attention Required!

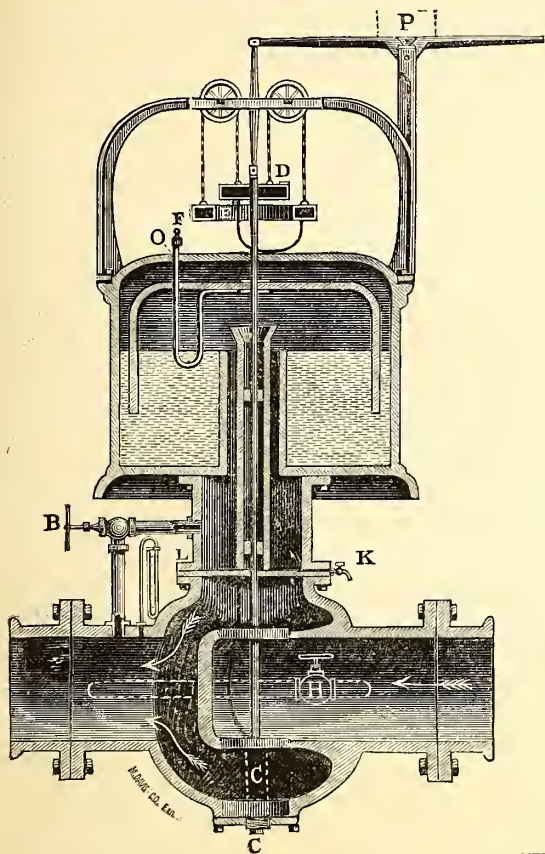

Will respond instantly, WITHOUT VIBRATION, to changing pressure from Telescopic Holders, or to any sudden increase in consumption, however large; which cannot be said of any other Governor. It is this feature that enables us to claim it to be

THE ONLY PERFECT AUTOMATIC GAS GOVERNOR EVER MADE.

It will control and regulate the pressure to suit the variation in consumption with perfect accuracy and absolute reliability. It will respond instantly to any unusual demand during the day or night, increasing volume and pressure together, and reduce same to the minimum as the lights are extinguished. It does away with all necessity for watching changes in the weather, or extra occasions of unusual demand, and insures the pressure being the exact amount required at all times.

We unhesitatingly claim our "Automatic Governors" to fill every requirement. They are simple in construction, cannot get out of order, will not corrode, occupy but little room, and can be placed and adjusted by anyone. They are capable of a wide range of adjustment, and can be set to any maximum and minimum pressure desired.

The accompanying cut shows the pressure held in the Columbus, Ohio, gas mains by one of our 16-inch Governors, the *light line* showing the pressure held during Friday, April 24th, 1885, and the *heavy line* pressure held Saturday, April 25th, 1885; the *two lines* showing the actual service of the Governor under varying demands. The accompanying letter from Mr. McMillin attests its wonderful perfection in very brief terms:

Pressure in Street Mains at Columbus Works.

COLUMBUS GAS LIGHT & COKE CO., }
COLUMBUS, OHIO, April 28, 1885. }
MESSRS. CONNELLY & CO., LIMITED, No. 407
Broadway, New York:

Gentlemen—We have had one of your Automatic Governors in use for some months, and are well pleased with it. No attention is required more than to give it a few drops of oil once a week. The register card it makes clearly indicates the character of the weather, whether clear or cloudy. It puts three or four tenths less pressure on Sunday night than on other nights of the week, and takes the pressure off two or three hours earlier. In other words, *it supplies the demand—no more and no less.* Yours truly,
E. McMILLIN, Superintendent.

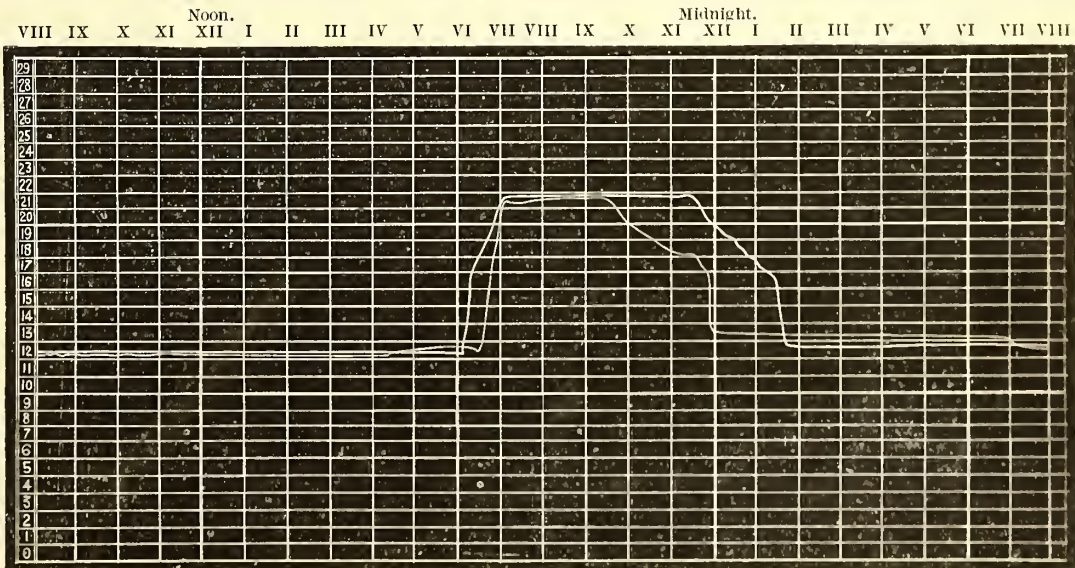

In calling the attention of our friends and patrons to our Automatic Governor we do so in full confidence that it will give most thorough satisfaction, and pay for itself in from one to ten months (depending upon the percentage of leakage), which any manager can easily estimate for himself. Certainly nothing can be placed in a gas works to-day that will pay for itself so soon. Correspondence solicited.

No. 407 Broadway, New York City. **CONNELLY & CO., Limited.** 33d & Smallman Sts., Pittsburgh.
New England Agent, C. H. SPRAGUE, 70 Kilby Street, Boston.

THE CLERK GAS ENGINE.

Highest Award American Institute, New York, 1883. Silver Medal American Institute, N. Y., 1884.

Gold Medal Awarded Crystal Palace Electrical Exhibition, London, 1882.

Highest Award for Motive Power British Section International Exhibition of Electricity, Paris, 1881.

Reliable.

Economical.

No Boiler.

No Engineer.

Steady.

No Explosion

No Coal.

No Gearing
Wheels.

Simple.

No Danger.

No Ashes.

No Parts
requiring
frequent
renewal.

Compact.

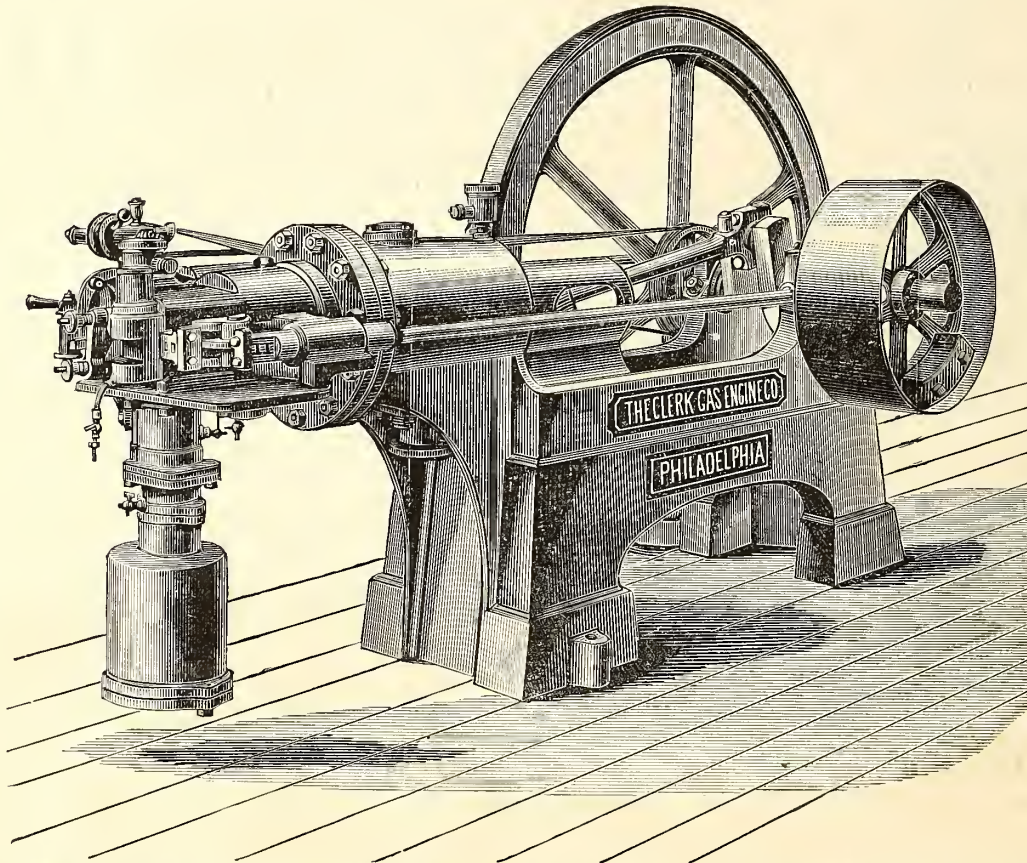

REQUIRING ONLY A MATCH TO START IT--GIVING ITS FULL POWER IMMEDIATELY.

We would inform the public that during the last few months we have improved THE CLERK GAS ENGINE to such an extent that we can now offer an engine vastly superior to our former pattern. These improvements have enabled us to sell our engine at a GREATLY REDUCED FIGURE, partly on account of the decreased weight (our engine weighing about half that of others giving the same Brake H. P.). The consumption of gas has been decreased to a considerable extent, and the Brake H. P. has been increased some 25 to 30 per cent. All parts of the old design that were considered defective have been remodeled and new designs added. We now have an engine second to none as regards power, consumption, and ease of working. With our new engine all trouble in starting has been removed, the noise reduced to a minimum, and the regularity of motion is now all that can be desired. We guarantee all we claim for it, and the material and workmanship being of the best, enables us to guarantee the engine for twelve months.

SOLE MAKERS,

THE CLERK GAS ENGINE CO.,

WM. W. GOODWIN, President. E. STEIN, Secretary. S. LEWIS JONES, Asst. Secretary. L. P. GARRET, Supt.

Main Office, 1012-1018 Filbert Street, Philadelphia, Pa.

BRANCH OFFICES,

142 Chambers St., N. Y.

4 West Fourteenth St., N. Y.

76 Dearborn St., Chicago

General Agents,

THE GOODWIN GAS STOVE & METER CO.

Of Philadelphia, New York, and Chicago.

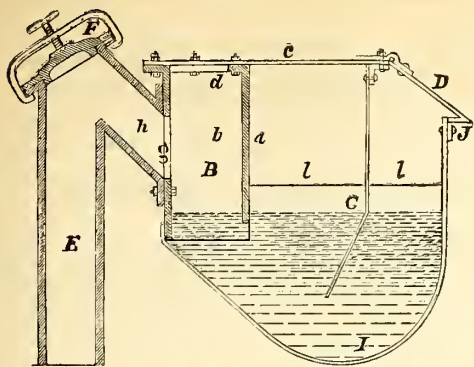

Boardman Hydraulic Main,
Patented October 7, 1884.

For description, see AM. GAS LIGHT JOURNAL of Feb. 2, 1884.
For terms, apply to

A. E. BOARDMAN, Macon, Ga.

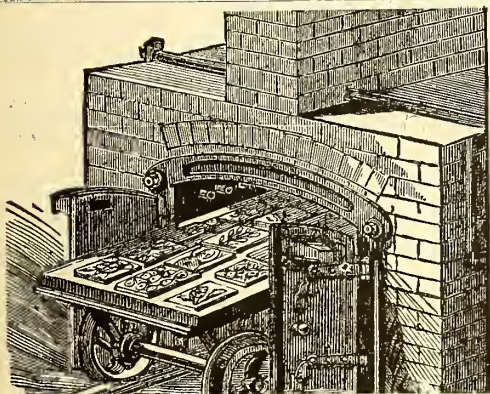

Glass-Staining Gas Kiln.

BAKERS' & CONFECTIONERS' OVENS (PAT.)

Thompson Gas Kiln & Oven Co.

59 Carmine St., N. Y.
Send for Circular by mail.

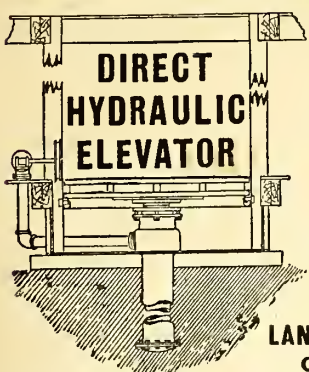

With Iron or Wood Platform.

Largely used by Leading Gas Co.s for Coal and Coke Lifts.

Adapted for use with city service, or special pumping and accumulator system. For prices address the

LANE & BODLEY CO.,
Cincinnati, O.

THE GLOBE
STREET LAMP.



MINER'S PATENT
STREET LAMPS.

Are adapted for use of Streets, Parks, Depots, Ferries, & Private Grounds.

WITH POSTS OR BRACKETS.

Jacob G. Miner,

No. 823 Eagle Ave., New York, N. Y.

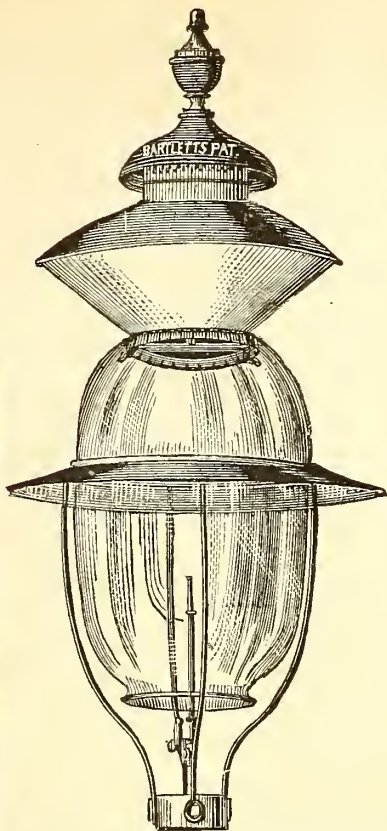

C. BARCALOW, PREST.

J. V. BARCALOW, SEC. & TREAS.

BARTLETT
Street Lamp Mfg. Co.

MANUFACTURERS OF

Bartlett's Patent

GLOBE LAMPS.

FOR

Streets, Parks, Railroad Stations, Public Buildings, Etc.

LAMP POSTS A SPECIALTY.

Office and Salesroom,
No. 35 Howard Street, N. Y. City.

Gas Companies and others intending to erect lamps and posts will do well to communicate with us.

F. M. ROOTS.

S. C. ROOTS

D. T. ROOTS.

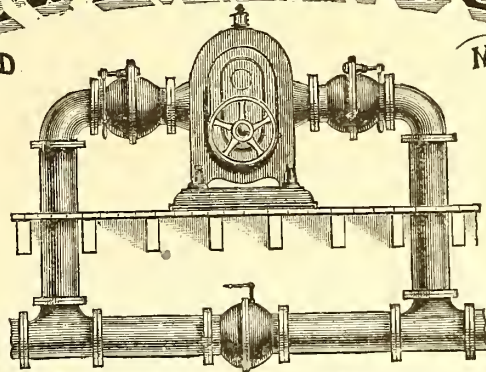
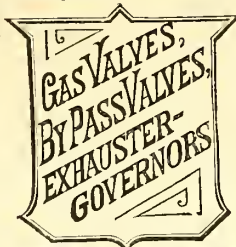

IMPROVED GAS EXHAUSTER,

WITH ENGINE ON SAME BED PLATE, OR WITHOUT.

BYE-PASSES, GAS VALVES, GOVERNORS, ELBOWS, PIPE-FITTINGS, Etc., FURNISHED TO ORDER,

P. H. & F. M. ROOTS, Patentees & Manufacturers, **CONNERSVILLE, IND.**

S. S. TOWNSEND, General Agent, 22 Cortland St. and 9 Dey St., N. Y.

JAS. BEGGS & CO., Selling Agents, 9 Dey St., N. Y.

COOKE & CO., Selling Agents, 22 Cortland St., N. Y.

✧ SEND FOR ILLUSTRATED CATALOGUE AND PRICE LIST. ✧

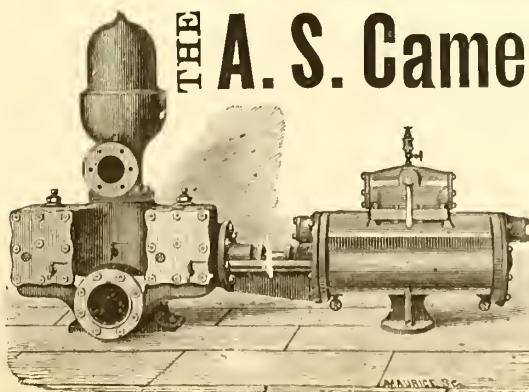

THE **A. S. Cameron Steam Pump,**

THE STANDARD OF EXCELLENCE.

Upward of 30,000 in Use.

BEST GAS WORKS PUMP
Ever Introduced.

Adapted to Every Possible Duty.

A. S. Cameron Steam Pump Works,
Foot East 23d St., N. Y.

J. H. GAUTIER & CO.,
CORNER OF
GREENE AND ESSEX STREETS,
JERSEY CITY, N. J.

MANUFACTURERS OF
**Clay Gas Retorts,
Gas House Tiles,
Fire Bricks, Etc. Etc.**
Ground Clay, Fire Brick and
Fire Sand in Barrels,

J. H. GAUTIER. T. B. GAUTIER.
C. E. GREGORY. C. E. GAUTIER.

BROOKLYN
Clay Retort & Fire Brick Works,
(EDWARD D. WHITE & CO.)
Manufacturers of Clay Retorts, Fire Brick,
Gas House and other Tile.
VAN DYKE, ELIZABETH, RICHARDS & PARTITION STS.
Office, 88 Van Dyke St., Brooklyn, N. Y.

LACLEDE FIRE BRICK MFG. CO.,
MANUFACTURERS OF
Fire Brick, Gas Retorts,

AND
ST. LOUIS STANDARD SEWER PIPE.
Blast Furnace and Cupola Linings, every description of Fire
Clay Material, Fire Clay Flue Linings, Chimney Tops
Dry Milled and Crude Fire Clays, etc.
OFFICE AND DEPOT
901, 903, and 905 Pine Street,
ST. LOUIS, MO.

ESTABLISHED IN 1845.
B. KREISCHER & SONS,
OFFICE FOOT OF HOUSTON ST., E.R., N. Y.
**Gas Retorts,
TILES, FIRE BRICK.**
AND EVERYTHING IN THE FIRE CLAY LINE.

MANHATTAN
FIRE BRICK & ENAMELLED CLAY
RETORT WORKS.
ADAM WEBER.

**CLAY GAS RETORTS
AND RETORT SETTINGS
FIRE BRICKS, TILES, ETC.,**
Office and Works, 15th Street and Avenue C., N. Y.

CHICAGO
Retort & Fire Brick Works,
OFFICE AND FACTORY,
Clark, Forty-Fifth, and La Salle Streets,
CHICAGO, ILL.
GEORGE C. HICKS, PRES. PAUL P. AUSTIN, SEC. & TREAS.
STANDARD
Clay Retorts and Settings.
BLOCKS & TILES
Of every Shape and Size to Order.
Standard Fire Bricks.

JAMES GARDNER, JR.
Works,
LOCKPORT STATION, PA.

—ESTABLISHED 1864.—
WILLIAM GARDNER & SON,
Successor to GARDNER BROTHERS.

WILLIAM GARDNER.
Office, COAL EXCHANGE,
PITTSBURGH, PA., P. O. Box 373.

Fire Clay Goods for Gas Works.

C. H. SPRAGUE, No. 70 KILBY STREET, BOSTON, MASS., Agent for the New England States.

OFFICE, 418 to 422 East 23d St., New York.

ESTABLISHED 1856.

WORKS, PERTH AMBOY, NEW JERSEY.

HENRY MAURER,
Excelsior Fire Brick & Clay Retort Works
CLAY GAS RETORTS, BENCH SETTINGS, FIRE BRICK, TILES, ETC.

STANDARD GAS RETORT AND FIRE BRICK COMPANY,
J. ANDERSON, PRES. & MANG'R. OF IRONTON, OHIO. C. PETERS, SECRETARY.
Clay Gas Retorts, Fire Brick, and Fire Clay Goods of Every Description.
Plans of Livesey-Somerville, McIlhenny, and other Furnaces, and Competent Workmen Supplied.

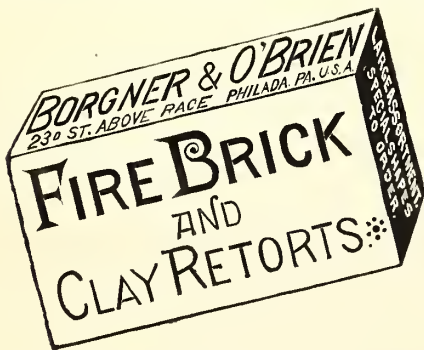

CINCINNATI
Gas Retort & Fire Brick Co.,
(ESTABLISHED 1872.)
CINCINNATI, OHIO.
Manufacturers of Gas Retorts, Retort Settings, Fire Brick, Tiles, Etc.

OAKHILL
GAS RETORT & FIRE BRICK
COMPANY.
PARKER, RUSSELL & CO.
City Office, 711 Pine Street,
ST. LOUIS, MO.

Our immense establishment is now employed almost entirely in the manufacture of
MATERIALS FOR GAS COMPANIES.
We have studied and perfected three important points. Our retorts are made to stand changes of temperature, the strongest heats of the furnace, and the abrasion of feeding and emptying. Our customers are in almost every State of the Union, to all of whom we refer.

THOS. SMITH, Pres. AUGUST LAMBLA, Vice-Prest. & Sup
BALTIMORE
RETORT & FIRE BRICK CO.
MANUFACTORY AT
LOCUST POINT, BALTIMORE, MD.
Connection with the City by Telephone.
**Clay Retorts, Blocks & Tiles,
FIRE BRICK, FIRE CLAY,
AND FIRE CEMENT.**

Red and Buff Ornamental Tiles and Chimney Tops. Drain and Sewer Pipe (from 2 to 30 inches). Baker Oven Tiles 12 x 12 x 2 and 10 x 10 x 2.
WALDO BROS., 88 WATER ST., BOSTON, MASS
Sole Agents for New England States

THE AMERICAN METER CO.,

MANUFACTORIES,

512 West Twenty-second Street, N. Y. Arch and Twenty-second Street, Phila.
Nos. 244 & 246 North Wells Street, Chicago, Ill.

AGENCIES,

No. 177 Elm Street, Cincinnati, Ohio. Nos. 122 & 124 Sutter Street, San Francisco Cal.
No. 810 North Second Street, St. Louis, Mo.

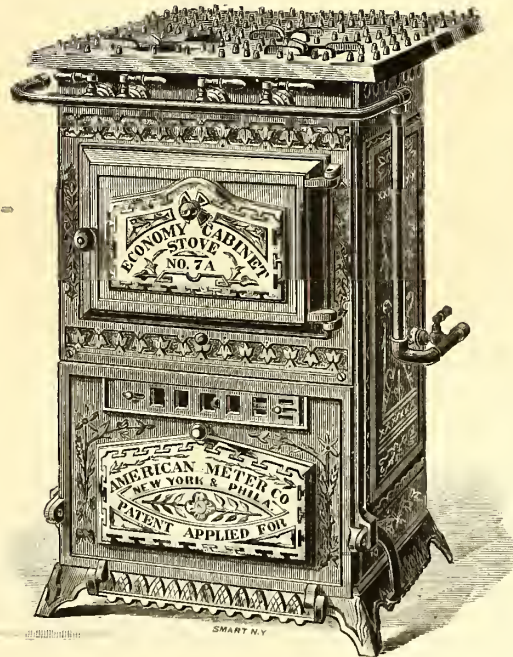

NEW DESIGN STOVES MADE IN CAST IRON, WITH EITHER OPEN OR CLOSED TOPS.

In presenting our "Economy" Gas Cooking Stoves and Ranges for the Season of 1885, we have the pleasure to inform our patrons that the increasing demand for these Stoves has encouraged us to make entirely new patterns, of HIGHLY ORNAMENTAL DESIGNS, for the popular sizes. We have also embraced the opportunity to increase the size of these Stoves, giving greater TOP PLATE AND OVEN capacity.

Full Lists and Catalogues are in preparation, and large stocks of Stoves will be kept at our Manufactories and Agencies for prompt shipment.

AMERICAN METER CO.

A. H. M'NEAL,

BURLINGTON, N. J.

Flange-Pipes

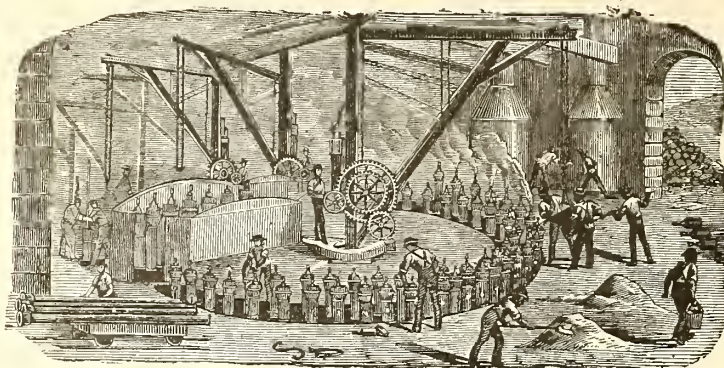

General Foundry Work.

CAST IRON PIPES

FOR WATER AND GAS.

JAMES S. MOORE, Pres.
BENJAMIN CHEW, Treas.

JAS. P. MICHELLON, Sec.
WM. SEXTON, Supt.

GLOUCESTER IRON WORKS, GLOUCESTER CITY, N. J.



Cast Iron Gas & Water Pipes, Stop Valves, Fire Hydrants, Gasholders, &c.

Office No. 6 North Seventh Street, Philadelphia.

ESTABLISHED 1856.

WARREN FOUNDRY AND MACHINE CO.,

WORKS AT PHILLIPSBURGH, N. J.
NEW YORK OFFICE, 162 BROADWAY.

Cast Iron Water and Gas Pipe

FROM TWO TO FORTY-EIGHT INCHES DIAMETER.
ALSO ALL SIZES OF

FLANGE PIPE for Sugar House and Mine Work.
Branches, Bends, Retorts, Etc., Etc.

436-1

MATTHEW ADDY, President.

W. L. DAVIS, Selling Agent.

GEO. P. WILSHIRE, Sec. & Treas.

Cincinnati and Newport Iron and Pipe Company,

NEWPORT, KY.

Lamp Posts
AND
BENCH CASTINGS

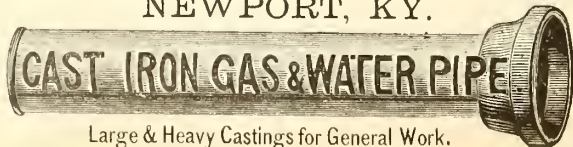

Branch
AND
SPECIAL CASTINGS

A Specialty.

Large & Heavy Castings for General Work.

FOR GAS & WATER CO'S.

Manufacture Pipe from 2 to 48 inches. All work guaranteed first quality.

Mellert Foundry and Machine Co.

Limited. Established 1848.
MANUFACTURERS OF



Specials—Flange Pipe, Valves and Hydrants,
Lamp Posts, Retorts, etc.
Machinery and castings for Furnaces, Rolling Mills, Grist
Saw Mills, Mining Pumps, Hoists, etc.

GENERAL OFFICE, - - - READING, PA.

LUDLOW VALVE MFG. CO.



OFFICE AND WORKS,

93S to 954 River Street and 67 to 83 Vail Av.

TROY, N. Y.

Hydraulic Main Dip Regulators, also
Check Valves, Foot Valves, Yard-
wash and Fire Hydrants.
Send for Circulars.

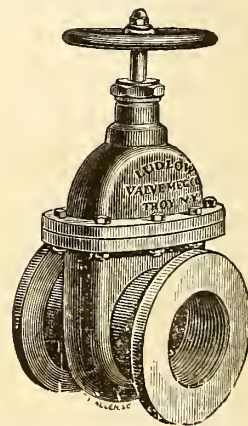

Valves.—Double and Single Gate, 1/2 in. to
48 in., outside and inside Screws. Indica-
tor, etc., for Gas, Water, Steam, and Oil.
Send for Circulars.

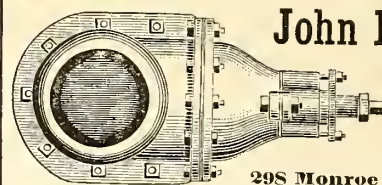

John McLean

Manufacturer of

**GAS
VALVES.**

298 Monroe Street, N. Y.

PRESERVE

The Journal

BY THE USE OF

THE STRAP FILE.

Advantages of the Strap File.

- 1st. It is simple, strong, and easily used.
- 2d. Preserves papers without punching holes.
- 3d. Will always lie flat open.
- 4th. Allows any paper on file to be taken off without disturbing the others.

Price, \$1.25. Sent either by express or mail, at directed. By mail the postage will be 20 cents, which will be added to the price of the Binder.

A. M. CALLENDER & Co., 42 PINE ST., N. Y.

Siemens's Regenerative Gas Burners, For Lighting and Ventilating.

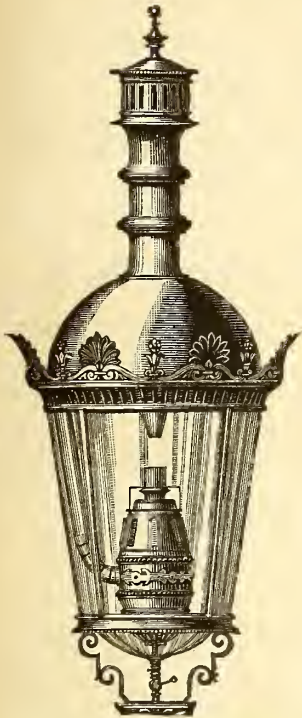

THE CHEAPEST, PUREST, AND MOST BRILLIANT OF ALL GAS LIGHTS.

Superior to the Electric Light in Economy, Beauty, & Steadiness.

SPECIALLY ADAPTED FOR LIGHTING HALLS, FACTORIES, OPEN SPACES, ETC.

Numerous Tests made by various Gas Companies in the United States show an Efficiency of Ten Candle Power per Cubic Foot of Gas.

General Agents:

- SIEMENS LIGHTING CO., 347 West Main St., Louisville, Ky.
- MEYER, MARSHALL & CO., 528 California St., San Francisco.
- DENNEHY, WOLF & O'BRIEN, 85 & 87 Dearborn St. Chicago, Ill.
- WILCOX & McGEARY, - No. 11 Bissel Block, Pittsburgh, Pa.
- T. T. RAMSDALL & CO., - 20 Swan Street, Buffalo, N. Y.
- SIEMENS GAS ILLUMINATING CO.,
Room 6, No. 157 Broadway, New York City.
- W. D. COLT, - - - 1420 F Street, Washington, D. C.
- JOHN KIEFER, - - - 344 Lawrence, Street, Denver, Col.

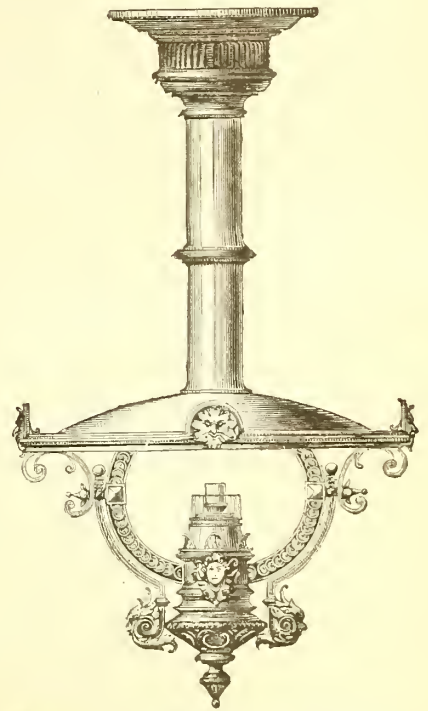

THE SIEMENS REGENERATIVE GAS LAMP COMPANY,
SOLE MAKERS FOR THE UNITED STATES,
N. E. Cor. 21st. St. and Washington Av., Philadelphia, Pa.

THE "STANDARD" WASHER-SCRUBBER, KIRKHAM, HULETT & CHANDLER'S PATENT.

Total Capacity per 24 Hours of "Standard" Washers Ordered During the Following Years.

1877.....	4,000,000 cubic feet.
1878.....	4,750,000 "
1879.....	24,545,000 "
1880.....	42,967,500 "
1881.....	36,462,500 "
1882.....	39,300,000 "
1883.....	57,735,000 "
1884.....	26,177,500 "
Total.....	235,937,500 cubic feet.

Total Number and Capacity per 24 Hours of "Standard" Washers Erected and in Course of Erection in the Several Countries

	Number.	Cubic Feet per Day.
Great Britain..	151	157,070,000
Western Hemisphere.....	38	39,337,500
Australia.....	18	12,150,000
New Zealand	2	650,000
France.....	6	4,550,000
Belgium.....	8	5,420,000
Germany	16	8,200,000
Holland.....	4	4,160,000
Denmark.....	1	150,000
Russia.....	2	3,500,000
Spain.....	1	350,000
India.....	1	400,000
Total.....	248	235,937,500

THE CONTINUED POPULARITY

Of these Machines

Will be recognized from the following extracts from letters from representatives of some of the companies having them in use:

ALLEGHENY GAS WORKS, }
ALLEGHENY, PA., Dec. 12, '84. }

MR. GEO. SHEPARD PAGE, New York:

Dear Sir—The "Standard" Washer Scrubber is giving us entire satisfaction. At present we are using one gallon water per thousand cubic feet, and the liquor as it leaves the Scrubber is 8 degrees (16 oz.) by Twaddle's hydrometer.

Yours respectfully,

ROBERT YOUNG, Eng'r.

"Standard" Washers Ordered During the Current Year.

	Cu. Ft. per Day
Anneberg Gas Co.....	200,000
Bombay Gas Co.....	400,000
Brussels Co.....	1,250,000
Chemnitz Gas Co.....	1,000,000
CITIZENS GAS CO., BUFFALO.....	750,000
Coke Works in Zabre, Ober-Schlesien.....	1,500,000
Cokerel der Friedenschutte, Upper Silesia.....	1,000,000
Dunfries Corporation.....	250,000
Dunedin Gas Co., New Zealand.....	400,000
King's Lynn Gas Co.....	300,000
Leiden, Holland.....	600,000
Lincoln Gas Co.....	400,000
Liverpool Gas Co.....	2,000,000
" ".....	3,000,000
LOUISVILLE GAS CO.....	1,500,000
Numea Gas Co.....	100,000
PITTSBURGH GAS CO.....	1,500,000
PORTLAND GAS CO., Oregon.....	562,500
SAN FRANCISCO GAS CO.....	4,000,000
Sheepbridge.....	40,000
ST. LOUIS GAS CO.....	2,000,000
Sydney Gas Co.....	2,500,000
WASHINGTON, D. C. GAS CO.....	2,000,000
Whitechurch Gas Co.....	175,000
Total.....	26,177,500

GEO. SHEPARD PAGE, No. 69 WALL STREET, NEW YORK,
SOLE AGENT FOR THE WESTERN HEMISPHERE.

R. D. WOOD & CO.,

400 Chestnut Street, Phila., Pa.

Cast Iron Gas & Water Pipe, Water Machinery & Gas Apparatus

Cast Iron Pipe, Fire Hydrants, Eddy Valves, Lamp Posts, Large Loam Castings, Flanged Pipe, Sugar House Work, Iron Roofs and Floors, Wrought & Cast Iron Tanks, Turbine Water Wheels and Pumps.

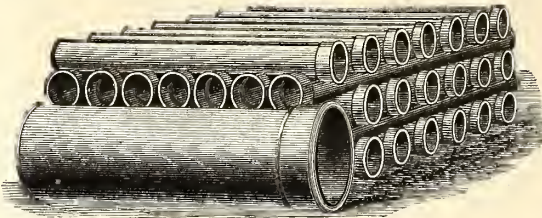

Casholders, Lime Trays, Center Valves, Purifiers, Bench Work, Exhausters, Condensers, Governors, Scrubbers, Gas Valves, Station Meters, Cast Iron Pipe Fittings.

Manufacturers of Heavy Castings and Machinery of Every Description.

ENGINEERS & CONTRACTORS FOR THE ERECTION OF GAS WORKS, & ALL MACHINERY CONNECTED THEREWITH

Estimates and specifications furnished for erection of new works or the extension or alteration of old ones.

Foundries and Works. - - Millville, Florence, and Camden, N. J.

SMITH & SAYRE MFG. COMPANY,

G. G. PORTER, Prest.

245 Broadway, N. Y.

CHAS. W. ISBELL, Sec'y.

Machinery & Apparatus for Gas Works

Drawings, Plans, and Estimates Furnished for the Improvement, Extension, or Alteration of Gas Works, or for the Construction of New Works.

Mackenzie's Patent Rotary and Steam Jet Gas Exhausters, Governors, Compensators, Condensers, Washers, Scrubbers, Isbell's Patent Automatic Street Pressure Governor, Gas and Water Valves, Hydraulic Main Dip Regulator, Bench Castings, etc. Purifying Boxes and "Standard" Scrubbers. Isbell's Patent Self-Sealing Retort Doors.

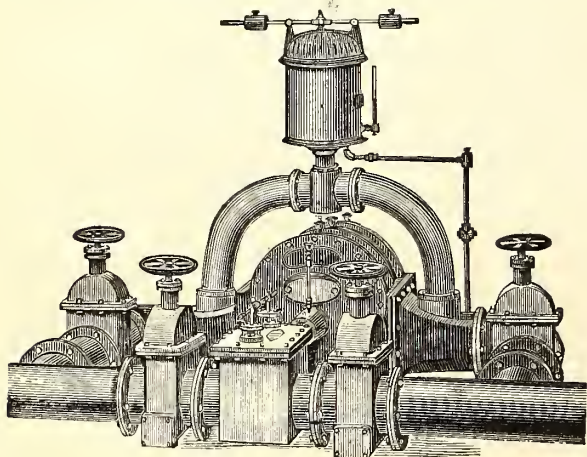

W. E. Tanner, Pres., W. R. Trigg, V.-Pres., A. Delaney, Supt.

Tanner & Delaney Engine Co.
RICHMOND, VA.

Gas Apparatus,

INCLUDING

Condensers of various styles, Scrubbers, Holders, Purifiers, Castings for Retort Houses, Etc.

ALSO STEAM ENGINES AND BOILERS.

Plans, Specifications and Estimates Furnished.

MORRIS, TASKER & CO.,
Limited,

Builders of Gas Works,
PHILADELPHIA, PA.

To Gas Companies.

We make to order CAP BURNERS to burn any amount under a stated pressure. Send for samples.

Also, SERVICE CLEANERS, DRIP PUMPS, and STREET MAIN PROVING APPARATUS.

C. A. GEFRORER,

248 N. 5th Street, Phila., Pa.

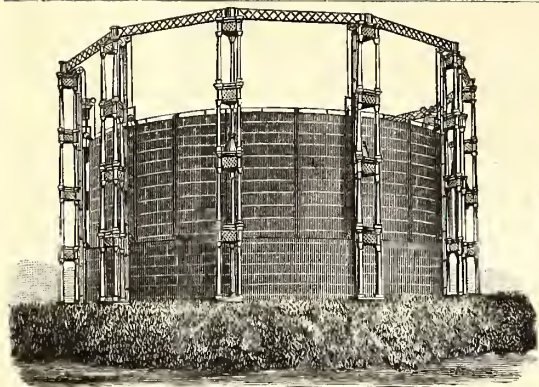

SOUTHWARK FOUNDRY AND MACHINE COMPANY,

Successors to MERRICK & SONS. Established in 1836.

No. 430 Washington Avenue, Philadelphia, Pa.

MANUFACTURERS OF

Single and Telescopic Gasholders,

BENCH CASTINGS,

Washers, Scrubbers, Condensers, Purifiers,

And all apparatus necessary for the construction of improved new gas works and in the extension of established works. Also manufacturers of

Gas Engines, and of all descriptions of Steam and Hydraulic Machinery, and of Boiler and Tank Work.

Plans, specifications, and estimates furnished promptly on application.

WM. HENRY WHITE,

Consulting & Constructing

Gas Engineer & Contractor.

ESTIMATES, PLANS, AND SPECIFICATIONS FURNISHED FOR NEW WORKS OR EXTENSIONS OF EXISTING WORKS.

32 Pine St., New York City.

Correspondence solicited.

GAS COALS.

GAS COALS.

GAS COALS.

JAMES D. PERKINS.

PERKINS & CO.,

F. SEAVERN.

General Sales Agents for

The Youghioghenny River Coal Company's

OCEAN MINE YOUGHIOGHENY GAS COAL.

The Coal from the Ocean Mine (recently operated by Messrs. W. L. Scott & Co., of Erie, Pa.,) is now used by all the leading Gas Companies in the United States from Maine to Texas, and is recognized as *the only reliable Youghioghenny Gas Coal.* (See Map on p. 87 of this Journal, Feb. 16, 1885.)

P. O. Box 3695, New York. **PERKINS & CO., 228 and 229 N. Y. Produce Exchange** BEAVER STREET ENTRANCE.

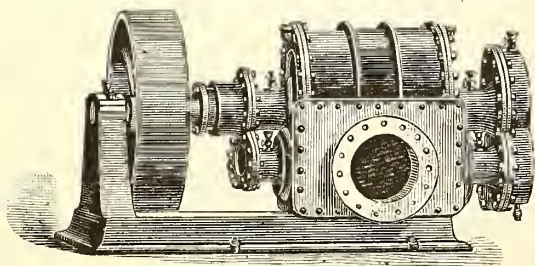

Gas Exhauster Driven by Belt.

The Wilbraham Gas Exhauster,

"BAKER SYSTEM,"

WITH ENGINE ATTACHED, ON SAME BED PLATE OR WITHOUT.

Best, Cheapest and Most Durable Exhauster known.

WILBRAHAM BROS.,

No. 2320 Frankford Avenue, Philadelphia, Pa.

Pipe Coverings.

Fireproof, Non-Conducting Coverings for

STEAM PIPES, BOILERS,
And all Hot Surfaces.

Made in sections three feet long. Easy to apply; light and cheap.

Asbestos Materials, Fibre, Braided Packing, and Cement. These goods are used at Continental Works, Br'klyn.

CHALMERS-SPENCE COMPANY, 419 & 421 EIGHTH ST., N. Y.

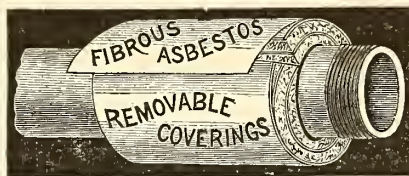

CHURCH'S REVERSIBLE SCREEN FOR GAS PURIFIERS

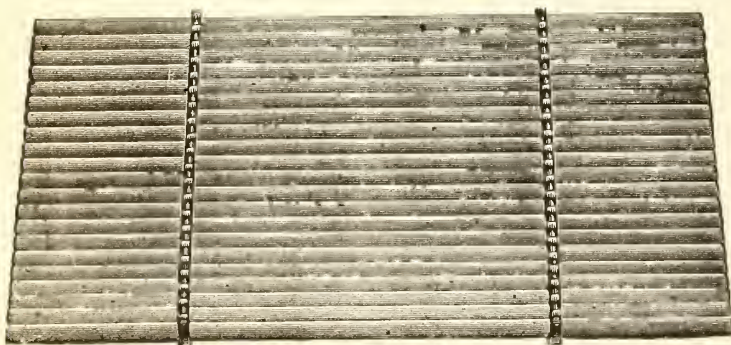

PATENTED JULY 9, 1878.

References in all parts of the country. Send for circular and list of companies who now have the Screen in use.

JOS. R. THOMAS, C.E.,

May be Consulted on all Matters Relating to Gas Works and Gas Manufacture.

ADDRESS THIS OFFICE.

NEWBIGGING'S

Gas Manager's Handbook.

Price, \$4.80.

EVERY GAS MAN SHOULD HAVE ONE.

Orders may be sent to this Office.

It will "Pay the Piper,"

If he aims to pipe well for STEAM, WATER, GAS, ACIDS, OILS, AMMONIA, &c., to examine this UNION, which requires no packing, but is always ready for instant use. When you next order Fittings of any Dealer, ask for a sample American Union to come with them, and it will tell you the whole story, or we will, if you write us for particulars.

PANCOAST & MAULE, PHILADELPHIA, PA.

GAS CO. OFFICERS,

READ AND REFLECT.

HODGE'S UNIVERSAL ANGLE UNION, Pat'd



A new and important Pipe Fitting for Steam, Water, or Gas. Combining a variable angle or elbow and a union. Saves pipe, saves time, decreases friction and radiation, gives a union joint at every angle, and can be set at any angle at which it is desired to run the pipe.

HODGE'S SWIVEL FLANGE,

A common sense article, designed to save time and money.

MANUFACTURERS AND WHOLESALE AGENTS,

ROLLSTONE MACHINE CO.,

142 Water St., Fitchburg, Mass.

Iron Sponge,

GAS EXHAUSTERS,

AUTOMATIC GAS GOVERNORS,

CONNELLY & CO., Limited,

No. 407 BROADWAY, NEW YORK CITY.

GAS COALS.

GAS COALS.

GAS COALS,

Newburgh Orrel Coal Co.,

MINERS AND SHIPPERS OF

**Newburgh Orrel, Tyrconnell
and Palatine Gas Coals.**

ALSO SHIPPERS OF FOUNDRY COKE.

Mines Situated at

Newburgh, Flemington & Fairmont, W.Va.

HOME OFFICE,

25 S. Gay St., Baltimore.

**CHARLES MACKALL,
MANAGER.**

CHAS. W. HAYS, Agent in New York,

Room 92, WASHINGTON BUILDING, No. 1 Broadway.

Shipping wharves at Locust Point. References furnished when required. Special attention given to chartering vessels.

THE DESPARD COAL COMPANY

OFFER THEIR SUPERIOR

DESPARD COAL

To Gas Light Companies and Manufacturers of Fire Clay Goods
Throughout the Country.

ROUSSEL & HICKS, } AGENTS. { BANGS & HORTON,
71 Broadway, N. Y. } 16 Kilby St., Boston.

Mines in Harrison Co., West Va. Wharves, Locust Point, Balt.

Company's Office, 15 German St., Baltimore, Md.

Among the consumers of Despard Coal we name: Manhattan
Gas Light Co., N. Y.; Metropolitan Gas Light Co., N. Y.; Jersey
City, (N. J.) Gas Light Co.; Washington (D. C.) Gas Light Co.;
Portland (Maine) Gas Light Co. Reference to them is requested.

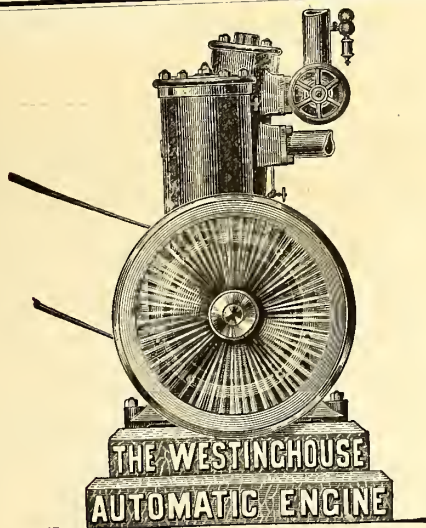

1,500 Engines Now in Use.

Our capacity being now equal to 100 Engines per
month, we shall hereafter keep in stock for immediate
shipment all sizes from 4 to 200 H.P.

SEND FOR ILLUSTRATED CIRCULAR AND REFERENCE LIST.

**Westinghouse Machine Co.,
PITTSBURCH, PA.**

SALES DEPARTMENT CONDUCTED BY

Westinghouse, Church, Kerr & Co., 17 Cortlandt
Street, New York City.

Fairbanks, Morse & Co., Chicago, Cincinnati, Cleve-
land, Louisville, and St. Paul.

Fairbanks & Co., St. Louis, Indianapolis, and Denver.

Parke & Lacy, San Francisco, and Portland, Or.

Parke, Lacy & Co., Salt Lake City, Utah, and Butte,
Montana.

D. A. Tompkins & Co., Charlotte, N. C.

Keating Implement & Machine Co., Dallas, Texas

Imray & Co., Sydney and Melbourne, Australia.

Robert Middleton, Mobile, Ala.

H. Dudley Coleman, 9 Perdido St., New Orleans, La.

R. Rogers, 43 Rue Laflitte, Paris.

**THE
PENN GAS COAL CO.**

OFFER THEIR

Coal, Carefully Screened & Prepared for Gas Purposes.

Their Property is located in the Youghiogheny Coal Basin, near Irwin and Penn Stations on the
Pennsylvania Railroad, and on the Youghiogheny River.

Principal Office:

209 SOUTH THIRD STREET, PHILA., PA.

Points of Shipment:

Pennsylvania Railroad Piers; Greenwich Wharves, Delaware
River; Pier No. 1 (Lower Side), South Amboy, N. J.

Chesapeake & Ohio Railway Coal Agency,

FOR THE SALE OF THE

**Superior Kanawha Gas Coals, Cannelton Cannel,
Also, SPLINT AND STEAM COALS**

From the Kanawha and New River Regions, on the line of the Chesapeake & Ohio R'way.

C. B. ORCUTT, Sales Agent. | OFFICE, 150 BROADWAY, N Y

FRANCIS H. JACKSON, PRESIDENT.

EDMUND H. McCULLOUGH, SEC. & TREAS.

THE WESTMORELAND COAL CO.

Chartered 1854.

**Mines situated on the Pennsylvania and the Baltimore
and Ohio Railroads, in Westmoreland County, Penn.**

POINTS OF SHIPMENT:

PHILADELPHIA, BALTIMORE, SOUTH AMBOY, N. J.
WATKINS (SENECA LAKE), N. Y.

Since the commencement of operations by this Company its well-known
Coal has been largely used by the Gas Companies of New England and the
Middle States, and its character is established as having no superior in gas-
giving qualities, and in freedom from sulphur and other impurities.

Principal Office, 224 South 3d St., Phila., Pa.

The Management of Small Gas Works.

By C. J. R. HUMPHREYS. Price, \$1.

A. M. CALLENDER & CO., 42 Pine St., N. Y.

CATHELL'S

Gas Consumer's Manual.

Enables every gas consumer to ascertain at a glance, without any
previous knowledge of the gas meter, the quantity and money
value of the gas consumed. Also the best method of obtaining
from gas the largest amount of its light. It will be to the advan-
tage of Gas Companies to supply their consumers with one of
these Guides, as a means of preventing complaint arising from
their want of knowledge in regard to the registration of meters.
A. M. CALLENDER & CO., 42 Pine St., N. Y

King's Treatise on Coal Gas.

The most complete work on Coal Gas ever published.

Three Vols. Bound, \$30.

A. M. CALLENDER & CO., 42 Pine St., N. Y.

**AMERICAN
GAS LIGHT JOURNAL.**

\$3.00 per Annum.

**A. M. CALLENDER & CO.,
42 Pine Street, N. Y. City.**



INTERNATIONAL--1876--EXHIBITION.

The U. S. Centennial Commission

HAVE DECREED AN AWARD TO

HARRIS, GRIFFIN & CO.,



12th and Brown Sts., Philadelphia, and 49 Dey St., N. Y., U. S. A.,

FOR THE FOLLOWING REASONS:

The Exhibit consists of a Series of METERS from the Largest Size Station Meters for the use of the MANUFACTURE OF GAS, to those for the use of the ORDINARY CONSUMER. The Instruments are WELL MADE, RELIABLE as to INDICATION, and embody a number of sundry improvements which, with the general character of the Exhibit, entitle the whole to commendation.

Attest—J. L. CAMPBELL,
Secretary, pro-tem.

Signed—A. T. GOSHORN,
Director General

J. R. HAWLEY,
President.

CHARLES E. DICKEY.

JAMES B. SMALLWOOD.

CHARLES H. DICKEY.

Maryland Meter and Manufacturing Co.,
DICKEY, TANSLEY & CO.,

Established 1866.

Nos. 22 and 24 Saratoga Street, Baltimore, Md.
No. 46 La Salle St., Chicago, Ill.

MANUFACTURERS OF

DRY GAS METERS, STATION METERS, GLAZED METERS, TEST METERS, METER PROVERS, PRESSURE AND VACUUM REGISTERS, GOVERNORS, INDICATORS, SERVICE AND METER COCKS, AND METER CONNECTIONS.

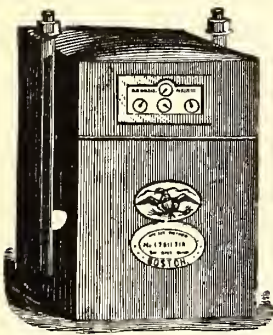

Dry Gas Meter.

With 39 years' experience and the best facilities for manufacturing, is enabled to furnish reliable work and answer orders promptly.

NATHANIEL TUFTS,

No. 153 Franklin Street, Boston, Mass.,

MANUFACTURER OF

DRY GAS METERS.

Station Meters of any Capacity.

Test and Experimental Meters, Pressure Registers, Pressure Gauges, Pressure and Vacuum Gauges.

METER PROVERS, PHOTOMETERS, STREET LANTERNS, ETC., ETC.

Patent Cluster Lanterns for Street Illumination.

SCIENTIFIC BOOKS.

We are prepared to furnish to Gas Managers, and others interested in the topics treated of, the following books, at prices named:

- | | | |
|---|--|--|
| KING'S TREATISE ON THE MANUFACTURE OF COAL GAS. Three vols.; \$10 per vol. | GAS CONSUMER'S MANUAL, by E. S. CATHELS, C.E. 10 cts. | A PRACTICAL TREATISE ON GAS AND VENTILATION, with Special Relation to Illuminating, Heating, and Cooking by Gas, by E. E. PERKINS. \$1.25. |
| GAS MANUFACTURE, by WILLIAM RICHARDS. 4to., with numerous Engravings and Plates, in Cloth binding. \$12. | PRACTICAL TREATISE ON HEAT, by THOMAS BOX. Second edition. \$5. | PURIFICATION OF COAL GAS, by R. P. SPICE. 8vo. \$3. |
| THE GAS ANALYST'S MANUAL, by F. W. HARTLEY. \$2.50. | GAS WORKS—THEIR ARRANGEMENT, CONSTRUCTION, PLANT, AND MACHINERY. \$8. | HOW TO MANAGE GAS, by F. WILKINS. Paper. 20 cents. |
| ANALYSIS, TECHNICAL VALUATION, PURIFICATION, and USE OF COAL GAS, by REV. W. R. BOWDITCH, M.A.; with Engravings; 8vo., Cloth. \$4.50. | COAL; ITS HISTORY AND USE, by PROF. THORPE. \$3.50. | THE GAS MANAGER IN THE LABORATORY, by a Practical Student. 8vo., Cloth. \$1.50. |
| GAS MEASUREMENT AND GAS METER TESTING by F. W. HARTLEY. \$1.60 | THE GAS WORKS OF LONDON, by COLBURN. 60 cents. | THE DOMESTIC USES OF COAL GAS, AS APPLIED TO LIGHTING, by W. SUGG. \$1.40. |
| GAS CONSUMER'S HANDBOOK, by WILLIAM RICHARDS, C.E.; 18mo., Sewed. 20 cents. | THE GAS FITTER'S GUIDE, Showing the Principles and Practice of Lighting with Coal Gas, by JOHN ELDRIDGE. 40 cents. | DISTILLATION OF COAL TAR AND AMMONIACAL LIQUOR, by GEO. LUNGE. \$8.50. |
| | GAS WORKS, AND MANUFACTURING COAL GAS, HUGHES. \$1.80. | A TREATISE ON THE COMPARATIVE COMMERCIAL VALUES OF GAS COALS AND CANNELS, by D. A. GRAHAM 8vo., Cloth. \$3. |
| | THE MANAGEMENT OF SMALL GAS WORKS, by C. J. R. HUMPHREYS. \$1. | |

The above will be forwarded by express, upon receipt of price. We take especial pains in securing and forwarding any other Works that may be desired, upon receipt of order. All remittances should be made by check, draft, or post office money order.

A. M. CALLENDER & CO., No. 42 Pine Street, New York.

T. C. HOPPER, Pres. G. J. McGOURKEY, Vice-Pres. (New York). WM. N. MILSTED, Gen. Supt. & Treas. (New York). WM. H. DOWN Sec.

AMERICAN METER COMPANY,

WET AND DRY GAS METERS. STATION METERS. EXHAUSTER GOVERNORS. DRY CENTRE VALVES. GOVERNORS FOR GAS WORKS. PRESSURE REGISTERS. PRESSURE & VACUUM REGISTERS. PRESSURE & VACUUM GAUGES. CRESSON GAS REGULATORS. MARSLAND WATER METERS. METER PROVERS. PORTABLE TEST METERS. EXPERIMENTAL METERS. AMMONIA TEST METERS. BAR AND JET PHOTOMETERS.

Manufactories:
 512 W. 22d St., N. Y. } **GAS STOVES,**
 Arch & 22d Sts., Phila. } SUGG'S "STANDARD" ARGAND BURNERS,
 SUGG'S ILLUMINATING POWER METER,
 Wet Meters, with Lizar's "Invariable Measuring" Drum. **Agencies:**
 177 Elm Street, Cincinnati.
 244 & 246 N. Wells Street, Chicago.
 810 North Second Street, St. Louis.
 122 & 124 Sutter St., San Francisco.

HELME & McILHENNY,

(Successors to Harris & Brother. Established 1848.)

GAS METER MANUFACTURERS,

CONTINUE AS HERETOFORE AT THE OLD ESTABLISHMENT,

Nos. 1115 and 1117 Cherry Street, Philadelphia, Pa.,

To Manufacture Wet and Dry Gas Meters, Station Meters, Experimental Meters, Meter Provers, Center Seals, Pressure Registers, GOVERNORS, INDICATORS, PHOTOMETERS, & ALL OTHER KINDS OF APPARATUS FOR USE IN GAS WORKS.

From our long practical experience of the business, and from our personal supervision of all work, we can guarantee all orders to be executed promptly, and in every respect satisfactorily.

WM. WALLACE GOODWIN, Prest. and Treas. WM. H. MERRICK, V.-Prest. S. L. JONES, Sec. S. V. MERRICK, Supt.

THE GOODWIN GAS STOVE AND METER COMPANY,

Successors to W. W. GOODWIN & CO.

1012, 1014 and 1016 Filbert St., Phila., Pa. 142 Chambers St., New York.
 76 Dearborn St., Chicago, Ill.

WALDO BROS., Agents, 88 Water St., Boston.

MANUFACTURERS OF THE "SUN DIAL" GAS STOVES, FOR COOKING AND HEATING PURPOSES.

Dry and Wet GAS METERS, Station Meters (Square, Cylindrical or in Staves) Glazed Meters, King's and Sugg's Experimental Meters, Lamp Post Meters, Etc., Etc., Meter Provers (sizes 2, 5 and 10 feet), Pressure Gauges of all kinds, Pressure Registers, Pressure and Vacuum Registers, Pressure Indicators (sizes 4 inch, 6 inch and 9 inch), King's Pressure and Vacuum Gauges, Dry and Wet Centre Seals, Dry and Wet Governors, Exhauster Governors, Photometers of all descriptions. Letheby's Sulphur and Ammonia Test Apparatus complete—also Testing and Chemical Apparatus of all kinds, and of the most perfect description, for all purposes relating to Gas.

GOODWIN'S IMPROVED LOWE'S JET PHOTOMETER.

Agents for Brav's Patent Gas Burners and Lanterns.

Special attention to repairs of Meters, and all apparatus connected with the business.
 All work guaranteed first class in every particular, and orders filled promptly.

G. B. EDWARDS, Mang'r, New York.
 E. H. B. TWINING, Mang'r, Chicago.
 A. B. STANNARD, Agent.

D. McDONALD & CO.,

GAS METER MANUFACTURERS.

(Established 1854.)

51 Lancaster St., Albany, N. Y. 34 & 36 West Monroe St., Chicago, Ill.

STATION METERS, EXPERIMENTAL METERS, METER PROVING, PRESSURE & VACUUM REGISTERS, PRESSURE GAUGES, ETC.

Also STAR GAS STOVES, RANGES, and HEATING STOVES.

We use only the very best materials, and employ the most skilled labor, and by our long experience (29 years) and personal supervision of every detail, we feel justified in assuring the public that our goods will give perfect satisfaction. Every Meter emanating from our establishment will bear the State Inspector's BADGE, and will be fully warranted by us. Our Annual and Calendar will be sent to Gas Companies upon application.

KING'S TREATISE ON COAL GAS.

The most complete work on Coal Gas ever published. Three vols., bound, \$30.

A. M. CALLENDER & CO., No. 42 Pine Street, New York.

THE "OTTO" GAS ENGINE.

Guaranteed to Consume 25 to 75
Per Cent. LESS GAS than ANY OTHER GAS ENGINE
PER BRAKE HORSE POWER.

TWIN ENGINES Impulse every revolution.
THE STEADIEST RUNNING GAS ENGINE YET MADE.

ENCINES AND PUMPS COMBINED,

For Hydraulic Elevators, Town Water Supply, or Railway Service.

Special Engines for Electric Light Work.

OVER 15,000
IN USE.

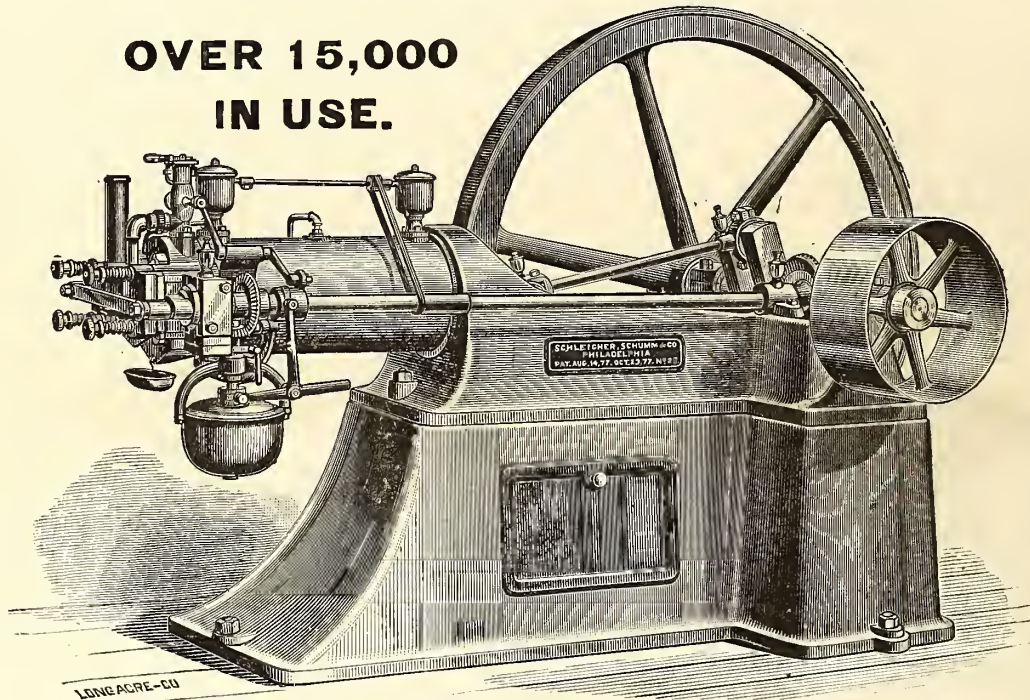

The Otto Gas Engine is now consuming, at a moderate computation, 2000 millions cubic feet of gas per year, nearly all of which is furnished during day time only.

**THE ONLY HIGHEST AWARD, ONLY GOLD MEDAL,
AT ELECTRICAL EXHIBITION, PARIS, 1881.**

MADE IN SIZES FROM 1 TO 25 HP. INDICATED.

FOR PARTICULARS, PRICES, ETC., APPLY TO

SCHLEICHER, SCHUMM & CO.,

Works:

N. E. Cor. 33d & Walnut Sts., Phila., Pa.

Branch Office:

214 Randolph Street, Chicago, Ill.

THE AMERICAN

GAS LIGHT JOURNAL

REDMAN & KENNY, N. Y.

PUBLISHING OFFICE No. 42 PINE STREET

DEVOTED TO THE INTERESTS OF ILLUMINATION, VENTILATION, WATER SUPPLY AND DISTRIBUTION, & GENERAL SCIENCE.

VOLUME XLIII.—No. 1.
Whole No. 625.

NEW YORK, THURSDAY, JULY 2, 1885.

{ \$3 PER ANNUM
IN ADVANCE.

A. M. CALLENDER & CO., Proprietors. C. E. SANDERSON, Manager.
JOS. R. THOMAS, C. E., Editor.

ENTERED AT THE POST OFFICE AT NEW YORK, N. Y.,
AS SECOND CLASS MATTER.

Published on the 2d and 16th of each month, at No. 42 Pine Street, N. Y.

Terms of Subscription, Including Postage.—For the United States and Canada, \$3 per annum. European countries, \$3.50 (15 shillings—18 francs). All payments to be made in advance. Single copies, 15 cents.

Remittances should be made either by post-office order, registered letter, or bank draft on New York, payable to the order of A. M. Callender & Co.

Collections are invariably made directly from this office, for subscriptions, advertisements, etc. We have agents to solicit the same, but they are not authorized to receipt for money.

Correspondence.—Wishing to make this JOURNAL a gazette of intelligent discussion to those of our readers who may wish to gain or give information on the subjects to which its columns are devoted, correspondence is solicited for publication from all who make the study of those subjects a pleasure or a profession.

The American News Company, Nos. 39 and 41 Chambers street, New York, are agents for this JOURNAL. Newsdealers will send orders to them.

Books.—We will mail, post-paid, at publisher's lowest rates, any book—scientific or otherwise—to any address in the United States or Canada. No books will be sent C. O. D.

CONTENTS.

An Asterisk (*) denotes an illustrated article.

EDITORIALS—

The Guild of Gas Managers Combining Business with Pleasure...	1
The Consumers Company, of Chicago, Ills.....	2
The Actual Candle Power of Arc Lamps, by H. C. Adams.....	2
The Market for Gas Securities	2
Eighth Annual Meeting of the Western Gas Association—Official Report—Continued from Vol. XLII., page 315.....	3
* Pressure of Gas in Street Mains, by G. A. Hyde, Sr.—Discussion—The Question-Box—The Utilization of Waste Heat from the Benches, by J. W. Dunbar—Discussion—Iron Purifying Material, by E. H. Jenkins—Discussion.	
Sixth Annual Meeting of the Central New York Gas Engineers Association—Official Report.....	7
Roll-Call—Routine Business—Election of Officers—Electing Mr. Harbison an Honorary Member—Programme of the Session—A Question-Box—Natural Gas—The Use of Steam in Furnaces, by A. C. Wood—Luncheon and Inspection.	
Large Casting in Italy.....	8
Special English Correspondence.....	9
On Testing Coal for its Producing Qualities.....	10
Gas Appliances at the Parkes Museum.....	10
Train Lighting.....	11
On the Removal of Paint and Varnish.....	11

ITEMS OF INTEREST FROM VARIOUS LOCALITIES.....

12
Something from Tiffin, Ohio—Old Wooden Water Pipe—A Lively Southern Gas Man—An Electric Fire—Patent Granted—To Manage the Wausau (Wis.) Gas Works—To Have an Agency at Chicago, Ills.—Prices of Gas at Nebraska City, Nebraska—They Should Accept the Proposition—Figuring on the Tax Rolls—The Jamestown (N. Y.) Gas Company Makes a New Departure—Keeping the Engines to Their Work—Awarded the First Premium—Poor Brooklyn—Mr. A. L. Allen, of Poughkeepsie (N. Y.), Makes a Discovery—Killed by Gas—Perhaps Detroit (Mich.) will Banish the Towers—Uniting the Two Stations of the Cincinnati (Ohio) Gas Light Company—Something from Richmond, Va.—Personal—Natural Gas as a Fuel—Electric Light on Railways.

THE GUILD OF GAS MANAGERS COMBINING BUSINESS WITH PLEASURE.

The members of the Guild of Gas Managers on the occasion of their last regular monthly meeting determined to strike out on a new line, and concluded that there was no good reason why that new line should not tend towards the acceptance of an invitation to visit the city of Manchester, N. H. Brother L. P. Gerould, of the Manchester Gas Light Company, promised that if they would but accept his invitation they should have no reason to regret such action; and his words were so pressing, and the scheme looked so tempting, that Gerould and his merry men carried their point, hence did the Guild, on the occasion of its June gathering (Friday, 12), forsake "hot and stuffy" Boston, eager for the chance to enjoy an outing in the land known to our forefathers (and even to ourselves) as the Switzerland of America, and the charm of whose scenery has many a time been sighed after by the brave and venturesome lads compelled by circumstance or necessity to turn their backs upon the old-time homesteads that nestled so cosily in valley or on hillside amidst all the glories so lavishly bestowed by nature upon the Granite State. But to come back to the Guild and its doings on June 12th.

The members and guests assembled at the Boston and Lowell depot in readiness to board the proper train, which was to "pull out" at 8:30 A.M., and deliver the party safe and sound in Mr. Gerould's care after a sharp run of two and one-half hours. The trainmen were as good as their promise, for quite on time the iron horse slowed up alongside the platform at the Manchester depot, where with smiling faces and outstretched hands stood the jolly host and his coadjutors—who on this occasion were his sons, Charlie and Ned. A cordial gripping of the fingers, a hurried word or two of welcome, and off the boys were whisked in carriages to the works of the Manchester Company. What could hardly (for it was rather on the substantial side) be called a luncheon was in readiness for the hungry ones; and the fact that the "luncheon" was of the solid sort seemed to be thoroughly understood and appreciated, since the manner and speed of its disappearance betokened the possibility that many of the party not only "got up," but also had "left their homes before breakfast." With the scant remnants of the feast (their scantiness spoke volumes about the stoutness of the visitors' appetites) spread thinly over the whilom heavily laden board, "the master waved his hand," and in groups of twos and threes the tourists made an inspection of the Manchester gas plant; and it is little wonder that Brother Gerould is inclined to regard it as "quite an affair." It does credit to every one connected with it. The inspection completed the party returned to the Company's office for the purpose of holding the regular business meeting. When Chairman A. B. Slater called the gathering to order it was observed that the following named members were in attendance: Secretary E. G. Pratt, and Messrs. W. A. Stedman, L. P. Gerould, John Andrew, Geo. D. Cabot, C. J. R. Humphreys, C. S. Spaulding, John Cabot, O. E. Cushing, C. F. Pritchard, R. B. Taber, Wm. B. Durfee, F. S. Richardson, J. H. Rollins, and S. G. Stiness. As specially invited guests were recognized Messrs. John P. Harbison, of Hartford, Conn.; Fred. J. Davis, of Waltham, Mass.; Wm. H. Down, New York city; J. A. Waldo, W. Colburn, and C. H. Sprague, of Boston, Mass.

When preliminary matters had been disposed of, Chairman Slater read a paper on, "The Pelouze and Audouin Condenser," which was chiefly de-

voted to a recapitulation of the results obtained in the use of one of these instruments at the works of the Providence (R. I.) Gas Light Company. Perhaps we could prevail upon Mr. Slater to forward us this paper, in order that we may give our readers the benefit of his wise judgment—for be it said, and we believe we have said it before, that Slater is one of those cool-headed gentlemen, whose opinion in regard to the merits or demerits of a piece of gas works machinery is well worth having. A general discussion on the subject matter of the paper, afterwards branching out to other questions of interest to gas men, was carried on. The "talk" occupied the better portion of an hour's time, when the entire party took their seats in carriages destined to convey them to Fletcher's Island, which is separated from the Manchester works by probably $3\frac{1}{2}$ miles of distance. The "Island" was reached at 2 P.M., and so happily had the journey been timed that host, members and guests were just in the "nick of time" to see the covers lifted from various dishes which contained all that goes to make up a noble specimen of the fish dinner. Excellently was it prepared; energetically was it consumed. The flavor, smack, spice—or call it what you will—of a Yankee fish dinner is well known to the New Englander; pity it is that it is not better known to the New Yorker. Some of those learned thinkers who are disposed to assert, and who do assert, that fish food is a great supporter of cerebration, should have been present at Fletcher's Island at that fish dinner, in order that they might have been witnesses to the mental activity which there and then prevailed. And by way of saying adieu to the late phosphoric-producing feast, it may be incidentally remarked that the crumbs left over would not have gone very far towards allaying the pangs of hunger experienced by a large and lively flock of Anglo-American sparrows.

After dinner the phosphor-charged party boarded a small and "natty" steamer that rejoices in the rather democratic name of Joe Cobb, for the purpose of enjoying a trip on the shimmering waters of Lake Massabosic (we won't be positive about the orthodoxy of our orthography), a beautiful silvery sheet of water, possibly $1\frac{1}{2}$ miles in length by half a mile in width, the location of which is so convenient to Manchester that it has become famous in that vicinity for its delightfulness as a summer retreat for the many. This lake is also the source from which the city of Manchester derives its water supply, and the excellent qualities thereof have made it famous as a beverage throughout the Eastern States—although there are other beverages in prim New England that are equally well known to fame.

The trip over the Massabosic was heartily enjoyed, although if the "Cobb" had been bigger no one would have found any fault over the increase in her dimensions. Shore being made, the party turned landmen once more and sought the shelter of the hotel piazzas, where pleasant conversation caused the minutes to fly swiftly, though not idly, by. Old Father Time is just the same steady-going chap on the borders of Massabosic that he is in Wall street, and when his "reckoners," in the shape of several Waltham chronometers, proclaimed 4:30 P.M., hosts and guests re-entered their carriages, so that they might be back at Manchester in time for the "5:37 train" for Boston.

The Jehus kept their steeds to their duty, and at the appointed hour there they were, ready to start for the "Hub." During the short wait at the depot a sort of special and impromptu meeting was organized. It was convened for the purpose of telling Brother Gerould and his sons just what was thought about them. We are afraid they blushed somewhat over the things that were said; and we are certain that they are thoroughly proficient in a knowledge of the pleasing art of playing the entertainer.

THE CONSUMERS COMPANY OF CHICAGO, ILLS.

In our item columns of last issue we made mention of a point or two in connection with the Consumers Gas Fuel and Light Company, of Chicago, Ills. Since the matter spoken of there must still be fresh in the memories of our readers, it is unnecessary that recapitulation of it be made now; and so all that remains with us for the present is to put upon record the latest news in regard to gas matters at the Lake City.

On Saturday, June 27, the New York *Daily Times* contained the following paragraph:

"CHICAGO, June 26.—Chas. C. Swinborne entered a judgment to-day against the Consumers Gas, Fuel, and Light Company, of this city, for \$26,250, and an execution was recorded against the company. The fact that such an execution had been recorded created a great deal of surprise, and no end of talk in business circles. The company was chartered in December, 1881, with a capital stock of \$500,000. The incorporators were J. W. Broekway, R. S. Tuthill, G. H. Harlow, M. A. Farwell, and A. C. Calkins. Most of these gentlemen were from Philadelphia. Subsequently the capital was increased to three millions of dollars, all paid up. The company has a bonded indebtedness of two million dollars, secured by first mortgage, and has issued \$300,000 debenture bonds, \$150,000 of which sum is outstanding. A month ago it borrowed from the Corn Exchange Bank \$26,250 for thirty

days, giving as security debenture bonds. The claim passed into Mr. Swinborne's hands, and, being unable to secure payment, he entered a judgment against the company. E. C. Judson, president of the company, states that the surplus fund is exhausted, and there was no money with which to pay the Swinborne claim. The business, Mr. Judson says, is very good, and the embarrassment, which he asserts is but temporary, is due to large expenditures in making improvements. There will be no cessation of business. The general impression is that the company will be able to weather the crisis in its affairs, although suffering from bad management. * * * The gas station cost \$1,250,000. * * *

It is rather difficult to understand what Mr. Swinborne's (that name has a bad sound) action means, although it would not surprise us in the least if it ultimately turned out that the stockholders are to be disposed of. If the *Times* man's statement is to be taken at its face value, the wiping out of the stockholders need not much interfere with their peace of mind. He says that the company has a bonded indebtedness aggregating \$2,150,000, and that its gas station (probably meaning the manufacturing plant) cost $1\frac{1}{2}$ millions of dollars. The stockholders may rest assured that the "gas station" has not increased any in value or worth since it was built; and they may also be perfectly well content over the fact that the remaining \$900,000 in bonds covers, and far more than covers, every possible article of value owned or enjoyed by the Consumers Company. Indeed, take it all in all, it appears as though some portion of the Consumers Company is about to be consumed—a fate that it richly deserves. It would be real saddening to learn that the surplus fund was exhausted, were it not that it requires so lively an exercise of imagination to call to mind the time that the company ever had a surplus fund. There will soon be some queer developments in Chicago gas affairs.

The Actual Candle Power of Arc Lamps.

By H. C. ADAMS.

There has been a great deal of discussion over the matter of the actual candle power of the arc lamps, and it is more than probable that the results of careful measurement by experts will be of interest. Below is given a short summary of the report of the examining committee appointed by the Franklin Institute, at the Electrical Exhibition held last fall in Philadelphia, Pa.:

Name of Lamp.	Candle Power.		Horse Power per Lamp.
	Horizontal.	45 Deg.	
Arago.....	273	583	.824
Ball.....	223	485	.432
Brush (1,200).....	180	613	.466
Brush (2,000).....	389	1,373	.785
Diehl.....	323	830	.754
Richter.....	313	894	.812
Van de Poelle.....	333	1,162	.817
Western.....	263	266	.617

From an examination of the tables from which the above figures are taken we find that the point of minimum illumination lies in the horizontal plane; and from that position the illumination increases as we elevate the lamp until we reach 45°, where is found the maximum of light. As we increase the angle over 45° the illumination gradually decreases. The distribution of the light down at such an angle is accounted for by the crater always formed in the upper or positive carbon, which is the source of the greater amount of light, and acts in some degree as a deflector.

Ten observations of each lamp were made at each of the several altitudes measured; and the variation in the intensity of each lamp during the test at any altitude was found to be very great. For instance, the Arago lamp, at altitude 56° 40', varied from 307 to 656-candle power; and the Brush (nominal) 2,000-candle lamp varied, in the horizontal, from 213 to 524-candle power. The Brush lamp made the best showing in the tests. It is to be regretted that the United States and Thomson-Houston lamps were not submitted.

The Market for Gas Securities.

About the most ridiculous thing ever noticed in connection with the gas share market of this city is the tomfoolery indulged in by the manipulators of Equitable quotations. Before the ink was dry on our figures as given in June 16th issue the shares had been pegged-up just 15 points, or from 116 to 131. Our "Market for Securities" in last number was written up on afternoon of Saturday, June 13th, and on that date the very best bid made for a small lot of the stock was 116½; yet, on the following Tuesday, and without cause or reason other than could be traced to the absorption of two or three small parcels held by not over-confident investors, the insiders had put the quotation up to 131. Those who hold Equitable at or below 110 have a pretty good thing of it, and need not mind much what the "pegger's" valuation is; but such as may have been tempted to purchase between 110 and 125 had better let the insiders take the stock at the ruling quotation—*i. e.*, at noon of June 30th, 137, bid. Consolidated gas is strong—the trading for fortnight opened at 94, highest price was 98½, and figure at time of writing is 96 to 96½. This stock is yet a purchase. Brooklyn shares are very strong, Fulton Municipal being at 160 to 162, and Williamsburgh at 152 to 155. The Citizens and Metropolitan Companies have declared and paid semi-annual dividends of 3 per cent.

[OFFICIAL REPORT—Continued from Volume XLII., page 315.]

Eighth Annual Meeting of the Western Gas Association.

HELD AT THE TREMONT HOUSE, CHICAGO, ILLS., MAY 13, 14, and 15, 1885.

FIRST DAY—AFTERNOON SESSION.

With the appointment of Committee to name a place wherein to hold next annual meeting, routine business for the time was disposed of, and the Chairman announced that the reading of papers would be proceeded with. Mr. G. A. Hyde, Sr., Engineer to the Cleveland (Ohio) Gas Light and Coke Company, was introduced to the Convention as the contributor of a paper on the subject of—

PRESSURE OF GAS IN STREET MAINS.

The gentleman read as follows :

The subject of pressure of gas in street mains is one of great importance to gas companies, and is also of vital interest to gas consumers. It seems to me, speaking in a general way, of course, that it has not received the attention which its importance should command, even although some have given the subject much careful study, and have invented useful devices looking to the regulation of the same. At the present time the larger companies, and some of the smaller ones as well, have so-called automatic or semi-automatic governors, or else employ the services of "a man at the valve" to regulate the pressure at the desired point; then, again, many managers of works make no attempt at pressure regulation, but permit the full pressure that comes from the weight of the holders to pass on into the street mains without hindrance.

Diversity of opinion, size of mains and services, and locality of works, furnish the source of nearly as many pressures as there are gas companies; and, consequently, the range of pressure at different plants varies from nine-tenths of an inch to the full pressure given by the holders. A uniformly low pressure can only be possible where mains, services, meters and house pipes are of reasonably ample size.

A pressure on the mains which is several times greater than required or used at the burner brings waste in leakage to the gas company, and forms the source of many complaints. Even though the pressure should be put on full during the heaviest consumption, say from sunset to midnight, yet during the remainder of the 24 hours it might be reduced, and thus save a large portion of the leakage. The expense attendant upon continually watching the pressure can be obviated by the use of an automatic governor, or one which, when set to give the requisite pressure for minimum consumption in clear weather, in the daytime, and the requisite pressure for maximum consumption at night, will automatically meet the varied demands between these points, and supply the requisite amount of gas.

There are elements which may disturb the initial pressure at the works, among which are—1st, the varying weights caused by coupling or uncoupling of telescopic holders; 2d, changing from single-lift holders of different sizes and weights; 3d, the varying weights of holders through being nearly submerged, or entirely inflated; and 4th, friction in the passage of the gas from the holders to the valve or governor house.

A change in initial pressure affects the resultant pressure in the proportion that the initial pressure bears to the resultant. If the flow is regulated by a fixed valve, the lowering of the initial pressure would lower the resultant pressure; but if regulated by a semi-automatic governor the resultant pressure would be increased in the same proportion, and would not recover its position; but if regulated by an automatic governor it would very soon recover its position.

In towns or cities where the main consuming district is above the works there are variations in the pressure, after the gas has passed the valve or governor, that are not contingent on the amount of gas being consumed. These variations have not heretofore been controlled or regulated by a governor, and cannot be checked by an attendant, unless he possesses a knowledge of the pressure in the district where the gas is consumed. The causes of these variations are—1st, the change in atmospheric pressure; 2d, change in the temperature of gas passing into the street main; and 3d, change in the temperature of the air.

1st. The variation in atmospheric pressure is annually about 1.3 inches, which would offset the pressure about one one-hundredth of an inch in our gas consuming district, which is 46 feet above the valve or governor house.

2d. The variation in temperature of the gas that flows into the street main is about 30° F. annually. The effect on our pressure from this change of temperature would be two one-hundredths of an inch.

3d. The variation in the temperature of the air is about 110° F.; this will affect our pressure 19 one-hundredths of an inch.

The two first-mentioned variations are of small account; but the fact that they exist should be recognized. The last is of greater importance, and an automatic governor could be so constructed as to correct this variation,

There are variations in pressure caused by the wind, which may occur anywhere or at any time. These are or may be much greater than those caused by the change in temperature of the air. Before describing the effect of the wind I wish to state that our works are located at the westerly end of our gas consuming district. Lake Erie is the northwesterly boundary, and its shore extends from the works in a northeasterly direction.

The Cuyahoga river valley is the southwesterly boundary, and extends in a southeasterly direction from the works. The gas works are near the point from which these two lines diverge. Winds blowing from points between northwest and southwest would blow from the works toward the gas consuming district; and would, when blowing from points between northeast and southeast, blow from the same district towards the works. Winds blowing from the north or south would be athwart the aforementioned directions. I will also mention that the office of the company is two-thirds of a mile distant from the works, and my residence is two and two-thirds miles from the same starting point—both in an easterly direction. I have observed, first, that a northwesterly wind blowing at the rate of 20 to 25 miles per hour raised the pressure at the office one-tenth of an inch, and at my residence $1\frac{1}{4}$ -tenths. 2d, that a west wind, blowing at the rate of 20 to 25 miles per hour, has raised the pressure at the office one-tenth of an inch, and two-tenths at my residence; 3d, that a northeast wind, blowing at the rate of 20 miles per hour, lowered the pressure at the office one-twentieth of an inch, and raised it $1\frac{1}{2}$ -tenths at my residence; 4th, that a southeast wind, blowing at the rate of 15 miles per hour, lowered the pressure one-twentieth of an inch at the office, with the same result at my residence. I might mention other observations, but these are amply sufficient to illustrate the general effect of the wind currents,

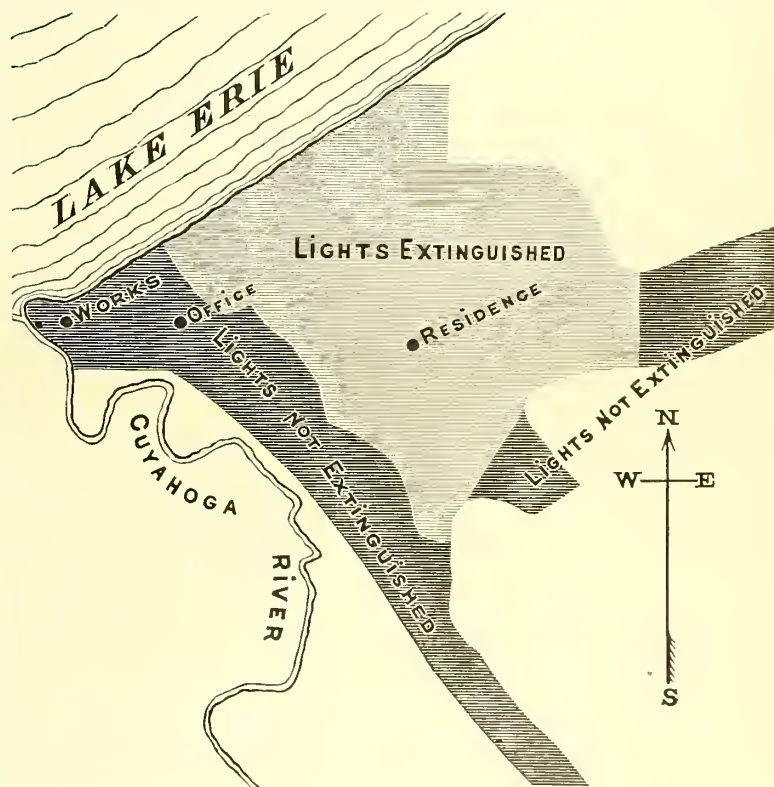

although I might further say that during the time of noting the aforementioned observations the pressure at the works remained unchanged.

Besides the ordinary disturbance of pressure caused by the wind which I have just noticed, I wish to refer to two unusual occurrences when, during their happening, the lights in the city were extinguished. The first of these disturbances happened some years ago, and the effect of the same was such as to put out nearly all the house and street lights in that portion of the city of Cleveland lying between Euclid avenue and Gordon street, and between Perry and Fairmount streets, or in a section of territory one-half mile in width and three miles in length. The pressure register at my residence, which is located within this territory, showed a sudden fall, followed by an immediate recovery of equilibrium. The same result was indicated on the register at the office, but to a less extent.

The second violent disturbance occurred on the third day of last April. The wind blew very strongly from the north shortly after one o'clock, A.M.; but at about 4 o'clock A.M. there was a sudden extinguishing of most of the house and street lights in a large portion of the city lying easterly of Morrison street, northerly of Woodland avenue, and westerly of Lincoln avenue, and extending to the Lake shore. The pressure registers showed that between the hours of 3:30 and 6:30 A.M. the ordinary pressure conditions had been greatly disturbed. At the works the oscillations were shown to have been as violent as four-tenths of an inch; at the office fourteen-tenths; and

at my residence they went up to 21-tenths. Between 1 and 3:30 o'clock A.M. the pressure at the office remained at the usual point; but at my residence it was $1\frac{1}{2}$ -tenths higher than usual.

Noting the comparatively small fluctuation at the works, as between the large ones at the office and at my residence, I sought to determine whether the disturbing cause was at or away from the works, and so I applied force to the float of the governor, and caused a fluctuation in the pressure of four-tenths of an inch. The office register showed a fluctuation of four-tenths, and at my residence the fluctuation reached to $4\frac{1}{2}$ -tenths. It would appear from this test that the disturbance above mentioned must have been caused by the wind, and was quite independent of anything that had transpired at the works.

The practical result of my experience is that to give uniform satisfaction to consumers, and yet do full justice to the interests of the company, a lower pressure should be kept on our street mains, both day and night, than is now maintained by many managers of gas companies; and those late investigations on the disturbance of pressure indicate that in a place having its gas consuming district very many feet above the valve house, provision should be made at the works for changing the pressure, either automatically or otherwise, to counteract the effect of the fluctuation in the temperature of the gas and air; and also that in every place the effect of a continued violent wind should be noted, and the pressure at the works so changed as to correct it.

Discussion.

Mr. Fullagar—I would like to ask Mr. Hyde a question. In looking at the map it seems to me that right where the greatest disturbance was noted as having occurred (at his residence) there is "dead-ending" main running nearly east and west. Is that so?

Mr. Hyde—(The speaker had a map before him illustrating the sizes and direction of mains in the district affected. The main conduit was 24 inches in diameter, the lateral branches being 20, 16, and 12 inches, respectively.) The pipe in front of my residence is 12 inches in diameter, and is fed from a 16-inch conduit, which draws from a 20-inch main, the latter being supplied from a 24-inch main leading direct from works. The particular pipe spoken of by Mr. Fullagar does not end "dead." In fact, so far as the mains are concerned, you cannot determine therefrom any reason why one portion of the lights in that district should be affected while the others remained lighted.

Mr. Fullagar—Had there been any great electrical atmospheric disturbance on the date in question?

Mr. Hyde—Not to my knowledge.

Mr. Fullagar—I asked the last question because Mr. Thomas stated that some six years ago an atmospheric disturbance took place—I believe he said its starting point was traced to Newark, N. J., from whence it moved on to Hoboken and Jersey City, in same State, then crossed the Hudson river over into New York City, and on again over (or under) the East river, making its presence felt in both the Eastern and Western districts of the city of Brooklyn, N. Y.—at an early hour of the morning, by which a great number of street lights were put out. The holders, according to the best judgment of those engineers whose lights were affected, rose between 18 inches and 2 feet; the pressure in valve room went down to nothing, and in a few moments it had increased to an inch above maximum. Mr. Thomas, who was then in charge of the Williamsburgh (Brooklyn) works, can state exactly what occurred at that time. I think Mr. Thomas ascribed the occurrence to an electrical or other atmospheric disturbance.

Mr. J. R. Thomas—On the night that this disturbance occurred a good many of our street lights were put out, and we were at a loss to account for the trouble. You know that gas men usually tell their neighboring brethren about their troubles; but on that particular occasion we held back, with the idea of hearing if anybody else in our vicinity had been similarly affected. We did not have to wait long until the Superintendent of the Citizens works, located at the other end of our city, or in South Brooklyn, reported that a very great number of his street lamps had been put out from some unknown cause. Comparison of date and hour made it apparent that his experience was also our experience. Next, and, in short order, we heard from Mr. Eugene Vanderpool, of the Newark Gas Light Company, that a similar visitation had befallen his street lights; then came a like story from Mr. C. V. Smith, of the Manhattan Company of New York city. The managers of other works in the five cities named also confessed that their lights had been attacked. The street lights extinguished on our lines of mains would average, I suppose, from ten to forty feet above the level of the gas works. In some of the low places they were not put out. This all happened, as near as I can recollect now, at about 2 o'clock in the morning; and the disturbance sounded a good deal like that which would be made by a large flock of strong-winged birds in their flight through the air. The atmospheric pressure was taken entirely off of the gasholders, and they rose with startling suddenness. The pressure gauge sheet showed a most peculiar mark. The pressure was over the normal one by $4\frac{1}{2}$ tenths. In our subsequent investi-

gations of the matter we found, from observations made at the Central Park Observatory, in New York city, that the barometer had fallen over an inch at the time our lights had been extinguished. There is no doubt in my mind that the putting out of the lights was caused by the removal of pressure from the gasholder, and not as a result of pressure added to it. I believe this from the simple reason that as soon as the atmosphere had regulated itself again the normal or usual gas pressure was restored. In our city we have a large number of consumers who are accustomed to burn gas all through the night; and between the hours of 2 A.M. and daylight we were kept pretty busily engaged in arousing consumers to make investigation as to whether their lights had been extinguished or not. In some localities plenty of them had been put out; in other situations they had not been affected. The lights in my own house were not disturbed in the slightest. The mains could have had nothing to do with it, for on the street where the greatest number of extinguishments were reported the distributing conduit was of large diameter, and not within three miles of a "dead end." The same thing occurred with Mr. Vanderpool at Newark; and it was a very singular circumstance in his case that the lights on one side of a street—for about a mile of its length—were all put out, while those on the other side kept on about their proper duty. In talking the thing over we could account for it in no other way than on the theory that during an atmospheric disturbance the pressure had suddenly been entirely taken off from the gasholder, and that the holder instead of falling had risen. I forget the exact time of the occurrence,* but think it was five or six years ago. We have had winds blowing at the rate of some 45 miles per hour; but at such times the pressure of our gas, after being delivered from the governor, has never varied the one tenth part of an inch.

Mr. Walter Clark—About five years ago we had a similar experience at the New Orleans (La.) works. We had six holders, placed pretty close together; and without warning or apparent cause one afternoon three out of the six rose about one foot, and then dropped back again. The remaining holders, which were in work (the affected ones were not at work) were not affected in the least. The water dashed up some six or eight feet out of the tanks. We could detect no atmospheric disturbance; there was no high wind blowing; the barometer was not affected—that is, there was no report of any atmospheric vagary as shown by the barometer. What the cause was is as yet a riddle, and is likely to remain so. There was nothing unusual reported as having occurred on that day by the Signal Service men. The holders moved around in such fashion that the men ran away from them in fear. There was of course no effect exerted on the street mains, as the holders that were in work were not affected. One holder that was affected was so close to one not affected that you could throw a stone from one to the other. I want to ask Mr. Hyde if anything unusual was noticed at the gas works when this disturbance took place.

Mr. Hyde—I was about to say that a few days ago, when trying to find out whether the disturbance spoken of was noticed either up in the city or at the works, I went to the governor, placed my hand on its plate, and oscillated it until the vibrations were two-tenths up and one-tenth down—or caused a disturbance equal to four-tenths. I say in my paper that the oscillation was four-tenths at the works, fourteen-tenths at the office, and four-tenths at my house. In the experimental disturbance of the governor to the extent of four-tenths of an inch, the marks on the pressure gauge showed just as they did during the actual disturbance of the 3d of April. Now, judging from the experiment, it could not be possible that the disturbing cause was at the works; and it is plain enough that the disturbance at the works was but the sequence or result of a disturbance away from the works. The disturbance must have taken place right through here. (Referring to map and pointing out the light shaded portion represented in cut.) The lights extinguished were all in the same territory as that in which my house is situated, and the oscillations or vibrations which were noticed afterwards would seem to indicate that the disturbance was in some way connected with wind passing over this portion of the city. I am sure that the gasholder was in no way, shape, or manner concerned in the affair—no more than if it had not been in the city at all. It must be that the tornado action of the wind on the gas sucked it up, or pressed it out in some way. I can give no real satisfactory explanation of the case. These are the facts, though. Here are the lights that were left burning; here are those that were put out; and here are gauges which show just what the effect was.

Mr. Thomas—There is one other thing that I might have mentioned in connection with that mysterious visitation of some years ago. The Manhattan Company's system of distribution is to work out the gas with valves; and at the time of the occurrence of this atmospheric disturbance before the men could get to the valves the whole thing had transpired. In regard to the operation of wind upon gas where there is a governor regulating the flow, as increasing pressure, I am able to speak from some experience with reference to that. Right opposite the Williamsburgh gas works

* The disturbance occurred on the night of April 16, 1880. For an account of same see JOURNAL for June 16, 1880—Vol. XXXII., p. 266.

is a large oil refinery, fitted with quite a number of agitators; the owners of the oil works have always insisted that agitators will never explode, but my faith in their veracity (and if for no other reason) was sadly shaken when I beheld one of them in the very act of exploding. The exploded agitator was separated from one of our holders by probably 80 feet—just on the other side of a narrow street. The force of the explosion was so great that it drove the gas-holder down in the tank for a distance of 7 feet, and threw water out of the tank up to a distance of 17 feet upon the columns. For a minute or so the pressure in the valve house was changed, the variations being between one and two tenths. No street nor consumer's lights were affected. The water went down and came up in the tank with a bound; and this tide-like condition of affairs lasted, I suppose, during two or three minutes.

Mr. E. J. King—With regard to the theory of tornado action, perhaps an incident in my experience may be pertinent thereto. I live in what may be designated as a tornado district; for although one of these devastators has never visited our city proper, they have made their appearance within a few miles to the north and south of us. To show how eccentric the action of a tornado may be, I will state the following: Right by the side of an ordinary three-barred rail fence a stiff hedge had been planted, with the idea that by the time the fence was worn out the hedge would be fit to take its place. The tornado came along, and that hedge was mowed down as nicely as if it had been done with a scythe—not a vestige of it was left; while not even a rail had been taken from the fence. I might also say that in the same place, and during the same disturbance, a small house stood in the path of the wrecker. It approached the rear of the house, jumped over the roof, and took off the front porch. Otherwise the dwelling was unharmed. There were many other instances of a curious kind; but that of the hedge and fence seems to me as somewhat analogous to the case spoken of by Mr. Thomas, where on one side of the street the lights were left burning, while those on the other side were extinguished.

Mr. Hyde—A gentleman in Cleveland told me of the following singular affair which occurred on the other side of the Cuyahoga river: One of the houses there had a chimney on either side; forty feet from rear of house was located a privy, and between privy and house there was a pile of straw. The point of the tornado in its sweep downward took off the chimney to left side of building, turned aside, struck the ground, and smashed the privy into splinters—there actually was not a single trace of it left; and yet the pile of straw, over which the tornado had to jump to reach the privy, showed no evidence of having been disturbed. I do not believe a blade of it was disarranged. The only damage done to the house building was the cutting off of the one chimney.

Mr. King—Speaking of tornadoes, I know of a very peculiar case that happened in Missouri. The case has been reported to the Signal Service authorities at Washington; and I have positive assurance that it was an actual occurrence. A man living in the western part of that State prepared a few sides of beef (it was certainly in a good state of preservation) and hung it to be cured in his smoke house; a tornado struck that smoke house shortly after the beef had been consigned to its care; the meat was carried down into a ravine, and then rolled up a hill on the other side, where it was left high and dry, owing to the storm having "sought pastures green and fields anew." Twelve hours afterward the owner of the beef discovered its position, and it was found to be perfectly alive with maggots; but where they came from, or what occasioned them, was the mystery.

Mr. James Somerville—I will suggest that after these explanations there is no difficulty whatever in understanding why Mr. Hyde's lights were put out; they were simply, for a time, in a vacuum. If a vacuum will demolish a privy building in the free and easy style described above, the vacuum may be depended upon to put out street lights. Mr. Hyde states that while lights continued to burn on one side of the street they were put out on the other side. On the one side of the roadway they were simply burning in a vacuum; then the pressure was taken away and the lights went out.

Mr. Hyde—I might say that on the occasion of the first extinguishment a very severe gale had passed over that part of the city.

Prof. S. H. Douglas—It appears to have become rather general practice to account for any unusual atmospheric disturbance on the ground that electricity is at the bottom of it. I have at various times received a great many letters upon this subject, and was thus often appealed to because many knew that I had devoted considerable attention to the study of electricity, and have also given some thought to the subject of atmospheric disturbances. I have received inquiries in regard to just such phenomena as those now under discussion; and nine out of ten of the inquirers would seek to have the disturbances explained upon the electrical theory, and it would seem as though this basis of explanation is resorted to because the phenomena can be attributed to no better source. They attribute it to electricity simply because they have nothing else to assign it to. Now, it strikes me that these vagaries are assignable to a much simpler source—nothing other than sudden variations in atmospheric pressure. Had the condition of the barometer been carefully observed at about the time that these extinctions

occurred, there can be little doubt but that a sudden rise in its registration would have been perceived. I cannot see that any other rational explanation can be made. That such rise was not observed at the nearest Signal Service station does not prove anything, as evidently the disturbances took place over but a very limited district. Look at the very small section or district that was affected in the large city of Cleveland, as reported by Mr. Hyde. There the lights that were extinguished were not far from the works, and yet the barometer at the works was not affected. That shows conclusively how limited was the field over which the disturbance extended. I would like Mr. Hyde to tell us as to whether his automatic pressure gauge indicated any unusual disturbance. I think it must have indicated something unusual. I think the rise and fall of holder alluded to can be attributed to nothing else but variations in atmospheric pressure; and, in short, that all these disturbances are beyond the influence of the atmosphere except as they influence the holder itself. Now that I am speaking I will allude to one other fact that I observed when Mr. Hyde was reading his paper. He carefully refrained from making any specific allusion to his automatic governor. I wish to say that Mr. Hyde has invented a governor; and you will recollect the drawings which he presented to the Association at our meeting of a year ago. After having given a very careful study to the drawings that were then presented, I ordered one of Mr. Hyde's governors, and the instrument was put in last fall. I think it but due to him to state to the Association that that governor, so far as I have been able to discover, is a model of perfection. It is perfectly automatic. From early last fall, or when it was put in, I have not touched it. It has worked constantly, giving me a day pressure of about 1½ inches, and a night pressure of about 3 inches. It takes care of itself. When the evening consumption commences the pressure runs up (without any attention whatever, or any change of weight) to night pressure, and there continues until the lights are turned off. That it has done day in and day out for six months. I have not touched the register at all, nor in any way interfered with it; and it has never failed to work to perfection. I say this in justice to Mr. Hyde, since it appears to me that he was a trifle too modest in failing to make any allusion to the efficiency of his instrument.

Mr. Hyde—I am grateful to Prof. Douglas for complimenting the governor that myself and son have devised, but I may say that I am not here to advocate the merits of any particular instrument. I did speak indirectly about the necessity of having an automatic governor. That, I think, cannot be gainsaid. If you have a governor that is really automatic in its action you get something which does work that a man cannot do, and it is a really valuable addition to the plant of any gas works.

On motion of Mr. Ramsdell the thanks of the Association were tendered to Mr. Hyde for his instructive paper.

THE QUESTION BOX.

Mr. King—Before reading the next paper I would like to ask if the Chairman's suggestion with regard to the question box has been followed out; and what portion of our time is to be devoted to a consideration of its contents?

The President—That will be for the Association to determine. The box is here, and I hope the members will use it; and I would particularly desire that those of our friends who are too modest to "speak out in meeting" will avail themselves of its presence to ask questions concerning matters in which they are especially interested. The questions need not necessarily relate to any one of the papers that have been read, but may be submitted in reference to any matter or topic allied to the gas industry.

Mr. John Fullagar—Mr. Chairman, I noticed another suggestion made in your address which seems to me worthy of our attention and action. You suggested that members of the smaller companies should take a more active part in the discussions at our meetings. These members, so far at least, have paid no attention to that intimation. At the meeting of our Ohio Association the members representing the smaller works were most active in the debates; they did about all the talking, and the talking was well done. Some of those who were present at that meeting are with us here at this gathering, and they have failed as yet to say one word. I think it is time for them to get up and say something. These meetings are of far more importance to the managers of small than of large plants—not that I would wish to be understood as detracting in the slightest from their value to the managers of the latter, either. Let the first-named mention their difficulties—provided they have any—and ask for advice.

The President—We must naturally conclude from their silence that they have got their works in such nice shape that they do not need to ask questions. I am, of course, greatly in favor of hearing the experience of every member. I expect that no one present will be backward in giving his own experience, and that those who wish for advice will freely call for the assistance needed. The reading of papers will now be resumed.

Mr. J. W. Dunbar, of New Albany, Ind., then read the following paper on the subject of—

THE UTILIZATION OF WASTE HEAT FROM THE BENCHES.

The gas plant with which I am connected as Superintendent has in use benches of "threes," and also employs a Salter steam-jet for the removal of gas from the hydraulic main. With benches of "threes" a greater percentage of coke is, of course, consumed in the carbonization of a given weight of coal than is the case where benches of "sixes" are run, or where regenerative furnaces are used. This greater percentage of coke required is occasioned by one or both of two things—viz., improper combustion of coke or of the gases generated from it; or from a loss of heat which has not been properly applied or utilized before it is passed out of the bench. With us at New Albany I am aware that the defect of waste heat has been prominent, and this prominence is undoubtedly a cause or reason that our coke percentage charged against carbonizing account was greater than it should have been.

The upright boiler which supplies our steam-jet and heats up the purifying room was, previous to December, 1884, heated with coke as fuel. The amount of coke used for 11½ months of 1884 was 3,400 bushels; which, at 9 cents per bushel—price received by us for coke in yard—amounted in value to \$306. This sum is now saved to the company, since we use no coke fuel under the boiler, but instead utilize the waste heat from benches to perform the required work.

This boiler is situated at a distance of about 25 feet from the rear or back of stack of benches from which we derive our waste heat. The plan pursued was this: A flue was constructed at end and bottom of stack of benches; it ran up along the end to top, where it was connected so that it might, if required, be arranged to receive the waste heat from all of the benches. From the bottom of this flue, and connecting with it, a second flue was built, running underground to the boiler—the flue being 18 by 12 inches; it entered the boiler under the brick foundation. The heat thus passes up on inside and out of stack to boiler.

The waste heat from one and one-half benches (as our boiler is now placed) will make 40 pounds of steam, or sufficient to remove pressure of gas made with three benches of "threes" from the hydraulic main, and also heat our purifying room. This arrangement still leaves one and one-half benches from which the waste heat is not utilized. The steam-jet under above arrangement requires little or no attention; the gauge shows zero all the time, and the amount of steam remains about constant.

As an evidence that the utilization of waste heat has not interfered with the draught, I will state that with the same number of retorts we have made 500 cubic feet per mouthpiece per diem more during the five months since the change was made than was the case in the five months preceding the change—our average yield for the last five months, with retorts 14 in. by 22 in. by 8 ft. 6 in., being 6,850 cubic feet per diem per mouthpiece. Forty per cent. of the coke made is required in the burning off of the charges. This large percentage of coke used in carbonization is accounted for on the ground that the furnaces are rather badly burned out, the benches from which the results are reported having been in use from 19 to 22 months.

When more steam is required in a gas works than that taken up in the mere running of a steam-jet and the heating of a single room, then by placing the boiler alongside of or close up to the end benches a much greater quantity of steam can be generated, as much heat is no doubt lost in passing through the underground flue for a distance of 25 feet. I expect to move my boiler and place it so that I can obtain enough steam to run a coke crusher recently purchased by us. This will require the diversion of more waste heat to generate the needed increase of steam power; but I am confident that by proper arrangement of dampers to flues the requisite amount of heat may be turned under the boiler.

In the prevention (or rather the utilization) of waste heat, we who run benches of threes and employ as much as 40 per cent. of our coke in keeping up the heats have a problem before us that I think we can with profit experiment upon. I am confident that by having our boilers in proper position, but one-quarter of the waste heat would be necessary where one-half of it is now required. As near as I can estimate, our coke consumption is reduced 5 per cent. (on whole amount made) through utilizing one-half of this waste heat; but with the boiler in proper position I am confident that one-quarter of the waste heat would do the heating required; and if this be the case it seems to prove that from 20 per cent. of coke burnt in our furnaces we get no return, or that one-fifth of the fuel absolutely passes off in the shape of waste heat. If we have need of this heat that is now wasted, the point for us to determine is how to economically prevent its passing off before it has rendered us due service in our benches. I think that to some extent this can be accomplished by using larger retorts with same size furnace; or by reducing width of furnace when using retorts of ordinary size. The furnace should also be placed as near the floor as possible, so as to give the heating gases a longer travel upward before they come in contact with the retorts.

Discussion.

The President—Here is something practical for your consideration. I hope that many of you will take part in the discussion.

Mr. James Somerville—I would like to ask Mr. Dunbar if he can tell us what is the temperature of the waste heat as it issues from the bench.

Mr. Dunbar—No, sir; I had not determined that.

Mr. Somerville—I think if a furnace is properly constructed, and the heat be made to do its duty, the waste heat will not be of much account. That is my idea; but of course there are furnaces where the waste heat is enormous, and where it might be utilized in the way Mr. Dunbar indicates. I would be rather inclined to work on the principle that there is no waste heat—that the heat has done its duty, and that it is carbonic acid gas and not carbonic oxide that issues from the flues.

Mr. E. McMillin—This is one of the best papers we have had read here to-day, and I would like to see more interest shown in it in this discussion. It is one of the matters that superintendents of small gas works might discuss with profit. If they could get a 25 per cent. increase to their salaries they would all like it; and now each company could afford to give a superintendent 25 per cent. increase to do what this gentlemen (Mr. Dunbar) has done. The average pay of a superintendent in this country is probably not more than \$1,200 per year. This gentleman says he has saved more than \$300. That is a big item. I think there is an abundance of heat that goes to waste in every gas works. If you have a regenerator furnace you may utilize it to great advantage; but not one in a hundred of the smaller gas works in this country has a regenerator furnace. I doubt if you will find any of them passing their waste gases off at less than 900° or 1,200°. You can utilize at least 400° or 500° of that, and still have sufficient temperature to give a good draught—if you have any stack at all. I am now figuring on the amount of waste heat in our works, where we use 15,000 bushels of coke every quarter; and that, too, where we have regenerator furnaces. The gases pass off, after we have utilized them to the greatest possible extent in our regenerator furnaces, at more than 700°.

The President—I think this is a matter of very great importance indeed to the smaller works throughout the country.

Mr. Harry E. Clarke—We had a boiler set in our stack that was heated with the waste gases. We had enough heat there to burn the bottom out of that boiler. We made steam for several months, but the boiler was set so close to the stack that even when we turned the waste heat away from it we could not cool it sufficiently to put a man in to scrape it. The result was that the bottom of the boiler burned out.

On motion of Mr. Howard, a vote of thanks was given to Mr. Dunbar for his interesting paper.

The President then introduced Mr. E. H. Jenkins, of Columbus, Ga., who read the following paper, entitled—

IRON PURIFYING MATERIAL.

In presenting this paper, I am well aware that some of the members present have used an iron material for purifying, with equally as good, perhaps better, results as those which I will here present; but I am also certain that others do not use it, and if I can give them a "dot" that may be of benefit to them, I shall feel amply repaid for any effort I may have made.

Some three years ago I called upon Mr. Thomas Smith, of the Grand Rapids (Mich.) Gas Light Company, and was shown by him a purifying mixture that he was using in lieu of lime. He kindly furnished me with the formula used in preparing the same; and I have since used this mixture with such good success that I have been induced to give some of the results. During the past year we have used it exclusively in the Columbus (Ga.) gas works.

I found upon looking over the book that the lime for the previous year had cost \$429.25. The entire cost of the iron borings, copperas, sawdust, etc., required to fill the four purifiers was a little less than \$25. My purifiers are 6 ft. by 6 ft. and 2½ ft. deep. We use an upper layer of lime to take out the carbonic acid. The total cost of our purification for the past year has been but \$72.50, or about three-quarters of a cent per thousand cubic feet of gas—a saving of \$356.75 over the purification expense of the previous year.

The material is doing better service now than when first put in work. The average amount of gas purified during the first three months was 245,000 cubic feet per purifier; for the last three months it was 268,000 cubic feet per purifier, and the material has increased in bulk by about 12½ per cent. The saving in labor is quite an item. In the winter months, under the lime process, it required about fifteen changes of purifiers per month; under the iron process we have only had one month that has had more than four changes, and that was in January—a purifier being changed on the 1st day of the month and another on the 27th, making five changes that month.

In using the material we put on the lower screens or trays, and fill the purifier as full as we can up to the top trays. We sprinkle the iron material with water as we put it into the purifier, so as to make it damp, but not wet enough to cake or get hard. We then put on the upper screens, and put about three inches of slaked and screened lime upon them.

We have not had a single complaint of foul gas, nor the least bit of trouble

from back pressure or otherwise, from the use of this material, and it has given perfect satisfaction.

We use native Alabama coal, which is a lighter grade of coal than Pittsburgh; it is something similar to the Western coals, but somewhat richer.

I will say, as to the materials used, that I shall be very glad (presupposing that Mr. Smith will offer no objection) to answer any questions.

Discussion.

Mr. Smith—Mr. Jenkins knew whereof he spoke.

The President—What quantity of gas did you purify per bushel of lime when using the latter, or in the year selected to make the comparison between lime and iron?

Mr. Jenkins—I am not prepared to say with regard to that, since it was the year just previous to my taking charge of the works.

The President—Do you know what the relative cost per thousand was?

Mr. Jenkins—The lime purification cost four cents per thousand that year, and the iron and lime purification this year cost three-quarters of one cent per thousand.

The President—What did the lime cost per bushel?

Mr. Jenkins—Sixty cents. My friend Starr says that lime down there costs as much as wood. Even if the lime could be had at 15 or 20 cents per bushel, or less, I think, all things considered, iron is the best purifying material that can be used—for small works especially.

The President—Are there any other members here who are using iron purification? If so, we would like to hear their experience with it.

A Member—I would like to ask Mr. Jenkins this question: Suppose he had charge of a plant where the boxes were too small for the work exacted from them; would he then prefer iron to lime?

Mr. Jenkins—If you can possibly use the iron sponge I would advise you to do it. Even where your purifiers are very small you have to depend upon a certain number of layers of lime. This sponge you can put in the full depth of your purifiers; it can be revived in three days, and then you may add more of the iron material if you wish. I think there are very few works where the purifiers are so small that iron cannot be used; and, indeed, I have doubt as to whether a locality exists in which iron purification will not be found advantageous. We put about 40 bushels into a box that is 6 feet by 6 feet.

A Member—What is the effect of the heating of the oxide when the cover is taken off the box?

Mr. Jenkins—When signs of heating are developed we "turn the material out" from the boxes and allow it to lie on a platform built for the purpose. After a day or two we turn it over, and might repeat the last performance again.

Mr. Smith—I will say that for 19 years I used lime in purification. Nine years ago I tried the oxide, and so well satisfied with it did I become that I have kept on with it ever since. A saving of between \$1,500 and \$1,600 per annum has accrued to us in the change from lime to oxide of iron purification. As you will have learned from Mr. Jenkins's paper, his system, or material, and mine are identical. We have never had any trouble with it. Perhaps a trifle more ammonia came up in the second purifier; but I have never found any carbonic acid in our gas.

Mr. Jenkins—You use lime also?

Mr. Smith—Yes, we use some lime with it; but the quantity is trifling.

Mr. G. A. Hyde, Sr.—I have had some experience with oxide of iron in purification. We purchased a quantity of it from Prof. Douglas. It was recommended quite highly to me by another gentleman, and I thought we would give it a trial. So far I am more than pleased with it; indeed, I am delighted with that manner of purification. So far we have purified nearly 60,000 cubic feet to the bushel. I cannot see at present that there is any deterioration in the efficiency of its purifying qualities. We can take it out and revive it easily; in three days it can be put back again if necessary. We do not change the box oftener than once in ten days. As near as I can determine, it purifies 11,700 feet at each run. Besides the 50 bushels of oxide in each box I use about three inches of slaked lime; but, taking this material at 50 cents per bushel in our yard, it has demonstrated to me that it has great economy over lime. Indeed, as far as I am concerned, I have no desire to use anything else.

A Member—Does Mr. Jenkins use any lime at all? If not, does not the carbonic acid left in the gas affect the illuminating power?

Mr. Jenkins—As said, we do use some lime. I have tried it both ways. Without any lime there is a shrinkage of at least one candle in the illuminating value of the gas. We only use one thin layer of lime. The proper way to use this material is to have an auxiliary lime purifier. That lime purifier need be charged but once in six months; but being cramped for room at Columbus, we use a three-inch layer of lime on the upper tray.

Mr. McMillin—If one who uses iron thinks it best to use lime also, let him keep the lime as "sweet" as possible. It does not hurt it to take out carbonic acid; and it will take out bisulphide of carbon. He will not get that at all if he uses lime with iron purification.

Mr. Starr—I think there need not be any trouble from admixture through the use of lime and oxide in the same box. I use iron sponge and lime in the one box, and by making the iron the lower layer, with the lime on top, and separating them with coarse burlap cloth, I save the iron sponge completely. Before trying the burlap plan I would lose from four to five bushels.

Mr. Jenkins—We have a light iron screen, punched with a large number of quarter-inch holes; and very little lime comes through such divisions. Instead of lime being hurtful to the sponge, we find it an advantage to put some lime in the material when making up.

The President—I had a very interesting experience last year while making some tests in purification. A gentleman who is here present had been experimenting on the subject of attempting to revivify the sponge while it remained in the purifiers, thus seeking to do away with the expense of handling it oftener than was absolutely necessary. His experiments were not very successful, as the sponge operated upon had been mixed with sawdust. I then determined that I would make a test of a material (intended to replace the sawdust) that would not catch fire, and here was the result: I took broken and ground up fire brick, mixed fouled iron sponge with it, put the mixture on a heavy wire purifier screen, and put the fans at work reviving it. In a box 25 feet square, filled with a 20-inch depth of material, I found, on the first trial, revivification was effected in seven hours. I kept a thermometer inserted through opening in the lid, and you may be sure I watched it closely. The second trial showed a revivification in five hours; the third and fourth trials being accomplished in time equal to that of the second. About the time I was ready for the fifth experiment I was unexpectedly summoned East, and so I selected the man whom I thought was best fitted to attend to the case while I was away from home. He thought he could beat that five hours record, and started in to do it. About the first reading he made of his thermometer he managed to break it. He let his fan run on during the time that his assistant was hunting for another temperature registerer. Before the assistant had been gone 15 minutes our hero began to think there was quite a lively heat in the box, and he was right. He whipped off the cover, and discovered that the iron had melted and formed into chunks as big as his head. The hose was turned on, and they had exciting times quenching the stuff. When I returned the material was piled up out in the yard. It had been lying there for two weeks, but it was no longer oxide of iron. I find from 450° to 500° of heat is as high as one should ever go; for beyond that you drive off the oxygen, and change your material from sulphate to sulphide.

On motion of Mr. Hyde, the thanks of the Association were given to Mr. Jenkins.

[To be continued.]

[OFFICIAL REPORT.]

Sixth Annual Meeting of the Central New York Gas Engineers Association.

HELD AT SYRACUSE, N. Y., THURSDAY, MAY 21, 1885.

The Sixth Annual meeting of the Central New York Gas Engineers Association was held at office of works of the Syracuse Gas Light Company, at 10:30 A. M., Thursday, May 21st, 1885. The following gentlemen were in attendance:

Avery, A. J., Dunkirk.	Babcock, H. N., Syracuse.
Cartwright, W., Oswego.	Down, W. H., New York city.
Gribbel, J., New York city.	Harbison, J. P., Hartford, Conn.
Humphreys, W., Dansville.	Hequembourg, C. E., Bradford, Pa.
Kingsbury, F. D., Corning.	McDongall, A., Hornellsville.
North, L. C., Canandaigua.	North, G. C., Corning.
Perry, E. C., Dunkirk.	Rider, Geo., Norwich.
Scrafford, W. H., Bath.	Truesdell, C., Cortland.
Tufts, J. H., Syracuse.	Wood, A. C., Syracuse.

ROUTINE BUSINESS.

In consequence of illness the President, Mr. John McDongall, Hornellsville, was an absentee. Mr. Wood called the gentlemen to order, and after stating why the chairman failed to attend, moved that Mr. A. J. Avery, of Dunkirk, act as Chairman *pro tem*. The motion was carried. Mr. Wood then notified the Chair that Messrs. W. H. Down, of New York city, and J. P. Harbison, of Hartford, Conn., were present, and moved that the privileges of the floor and the courtesies of the Association be extended to the visitors. This was agreed to. In formally announcing the action taken the Chairman said he was glad to welcome the gentlemen, and hoped they would join in the discussions with perfect freedom. In making their acknowledgments Messrs. Down and Harbison thanked the Association for the kindly courtesy shown them. Mr. Harbison assured the Chairman that he would gladly take part in the discussions.

A reading of the minutes of last annual meeting was dispensed with, and

the same, as published in the AMERICAN GAS LIGHT JOURNAL, were approved as printed. A letter to the Secretary, from Mr. W. T. Allison, Librarian of Patent Office, London, England, was read, and Secretary Babcock was instructed to make suitable reply thereto. Secretary and Treasurer's annual report for year was then read. The figures showed that receipts exceeded expenditures. On motion the statement was accepted and filed.

The names of Messrs. W. H. Down, N. Y. city, A. McDougall, Hornellsville, C. Truesdell, and S. C. North, Cortland, and J. H. Tufts, Syracuse, were proposed for membership. On motion Mr. Rider cast the ballot of the Association for the election of the applicants. On motion the Secretary was instructed to cast a ballot re-electing the old board of officers to the positions held by them during the past year. The gentlemen thus chosen to succeed themselves are the following :

President—John McDougall.

First Vice-President—Wm. Cartwright.

Second Vice-President—Wm. Parrish.

Secretary and Treasurer—H. N. Babcock.

Executive Committee { J. H. Findlay,
Wm. Humphreys,
L. C. North,
J. H. Case,
Geo. Rider.

On motion a committee of three (Messrs. Hequembourg, Kingsbury, and Babcock) were appointed to select the place for holding next annual meeting; they were also instructed to assign to different members the task of preparing and presenting papers to next annual gathering.

ELECTING MR. HARBISON AN HONARY MEMBER.

On motion the members unanimously voted to elect John P. Harbison, of Hartford, Conn., to Honorary Membership in the Association. When the Hon. J. P. H. recovered from the surprise into which this unexpected action had thrown him, he arose and said :

Mr. President and Gentlemen:—I thank you most heartily for your highly complimentary action towards me, and confess my inability to, at such short notice, do justice in words to the extent of your courtesy. I have been much pleased to note the large proportion of those on your membership list who are in attendance, and the fact certainly vouches well for the interest shown in previous meetings. I am pleased to observe the earnestness with which you discuss and act upon the matters that are presented to your notice. Let me impress upon you how important these matters are—not only to yourselves and to your Association, but to the entire gas fraternity as well. I might dilate upon the high esteem in which those of you (and they are many) with whom I am acquainted are held, and I might also speak of the good record which your Association has made for itself, but time forbids. Gentlemen, let us bear in mind that we are all working for the attainment of one thing—a better light to be sold at a reduced price. It is this that will kill any and every competitor, and I can truthfully say, as the result of long experience, that I have gathered much benefit and assistance from assemblies of this character. Let our motto be: "High quality and low-priced gas." Once more I thank you for the honor shown, and allow me to close with the hope that I may often meet with you in the future, and believe me that I shall be always glad to see you at my home in "the Land of Steady Habits."

PROGRAMME OF THE SESSION.

Mr. Wood announced the following programme or order of business for the day for adoption: Business meeting up to 12 M.; adjourn for lunch; inspection of the new plant of the Syracuse Gas Light Company; reading of a paper on the construction and operation of the new plant, by Mr. A. C. Wood; final adjournment to 5 o'clock dinner at the Globe Hotel. [This dinner was given at the instance of Mr. Wood.] On motion of Mr. Cartwright the programme, as outlined by the proposer, was adopted.

A QUESTION-BOX.

On motion the Secretary was instructed to procure a question-box, and have the same placed in suitable and convenient position. He was also directed to inform the members that the question-box would be made a permanent feature in future meetings.

NATURAL GAS.

Mr. Hequembourg—Now, gentlemen, I suppose you are all aware that I have made statements at your previous meetings, and also presented and read a paper before the last annual meeting of the American Gas Light Association, on the subject of natural gas. I am a trifle afraid that some of these assertions have not been received with favor—in short, or to put the matter more plainly, their truth has been questioned. Since Mr. Harbison has recently been in Bradford, and has been investigating my statements, perhaps I might ask him to tell the gentlemen present what his impressions were regarding what he saw there, and what he now thinks about natural gas?

Mr. Harbison—During my recent visit to Bradford I tested the natural gas

used there, and can fully confirm what Mr. Hequembourg has said in relation to it. Its abundance is astonishing. It is most satisfactory when employed for heating or cooking, as well as in mechanical operations. Used for illumination through the agency of a flat-flame burner, it is not so satisfactory, giving, under such circumstances, an unsteady and poor light of from 7 to 8-candle power, as shown by photometrical test carefully made. On the other hand, the same gas consumed through an Argand burner tested fully up to what has been claimed for it by our Bradford friend. According to my own experiments I learned that 6.2 cubic feet of the Bradford natural gas would yield a light of 27 candles. When consumed in a Siemens burner this gas gave the very best artificial illumination that I ever witnessed. In one of the drygoods shops of that city I beheld three Siemens burners consuming natural gas, and the large store was brilliantly lighted. Colors were brought out as clearly as they would be under sunlight, and tints could be plainly distinguished at a distance of from 25 to 30 feet away from the lamps.

Mr. Hequembourg—I feel under obligations to my friend Harbison for his courtesy in testing the Bradford gas, and am glad that his testimony confirms my prior statements in regard to it.

THE USE OF STEAM IN FURNACES.

Mr. Wood—Mr. President, at the February meetings of the New England Association of Gas Engineers, and the Ohio Gas Light Association interesting papers were read in which were discussed the possible or probable loss or gain resulting from the use of steam in our furnaces. I have no doubt you all read those papers, as also the discussions that followed, as published in the AMERICAN GAS LIGHT JOURNAL, and will no doubt be interested in knowing what others than gas makers are doing in the way of using steam as a promoter of combustion. The New York Central and Hudson River Railroad Companies are using steam for this purpose on their locomotives to great advantage; and although the conditions are somewhat different—as they introduce the steam and air over the fire, while we introduce it under the grate bars—yet they get extraordinary results from its use. The plan of operation is the invention of Mr. Buchanan, Supt. of locomotive power for that road; and through the courtesy of Mr. S. L. White, Master Mechanic, I am enabled to give you a description of the device which they have already applied to many of their locomotives, and which they will also apply as fast as possible to the remaining ones. The fire-box of the locomotive is divided into two compartments by means of a horizontal partition which they term a "deflecting plate." The plate is attached to the inside of rear (side) of fire-box at a point just below the lower flues—raising at a slight angle to front of fire-box, in the center of the deflecting plate, is a round opening, say, 10 inches in diameter, through which all of the products of combustion pass to the upper chamber of fire-box, thence into the flues of boiler. Through the front and rear of the fire-box are located short flues, say, 2½ to 3 inches in diameter, made fair with inside and outside of shell of the box—there being four of these flues in front and rear, or eight in all, placed equi-distant apart, just over the fire, or between it and the deflecting plate. In the center of each of these flues is placed an iron cone, and the jet of steam, under control of engineer, is adjusted to strike the apex of the cone, thus carrying a quantity of air with the steam into the combustion chamber, there uniting with the products from the combustion of the coal to produce a most intense heat, which passes through the opening in the deflecting plate into the upper chamber. An examination of the upper chamber through a sight-hole shows a most beautiful white heat. *All of the smoke is consumed*; no smoke is to be seen escaping from the smoke stack; and in their round trips from Syracuse to Buffalo and Albany and return *twenty-five per cent.* of the weight of coal formerly used under the old practice is saved. This has been demonstrated daily for several months; and I believe there is economy for us in using steam in our furnaces as evaporated from the water in the ash-pans.

LUNCHEON AND INSPECTION.

The hour of noon being reached, in accordance with the programme, the members were escorted to an apartment adjoining room in which the meeting was held. There they partook of a substantial luncheon, and after its "absorption" proceeded to make inspection of the new works of the "Gas Light Company of Syracuse." Superintendent A. C. Wood acted as guide, and when the beauties and compactness of the plant had been carefully examined the Association returned to the meeting-room, where they were called to order by the Chairman *pro tem.* That official then informed Mr. Wood that the members were in readiness to hear the promised communication descriptive of the new plant of the Gas Light Company of Syracuse.

(To be Concluded.)

LARGE CASTING IN ITALY.—The largest casting ever attempted in Italy was successfully accomplished at the ironworks of Signor Gregorini, Lombardy. This colossal block of cast iron, measuring 494.43 cubic ft., and weighing 105 English tons, is intended for the anvil of a 10-ton steam-hammer now being constructed for the Royal Arsenal of Spezia. The operation occupied twenty-three hours.

SPECIAL ENGLISH CORRESPONDENCE.

COMMUNICATED BY NORTON H. HUMPHRYS.

MANCHESTER, June 10, 1885.

The Gas Institute; Its Past, Present, and Future.—Programme of the Present Meeting.—Meter Testing at Manchester.—Sulphate of Ammonia.—Electric Light at the Inventions Exhibition.—Gas as a "Second String."—The Lamp Post of the Future.

Writing from the city which enjoys the honor of being the birthplace of the Gas Institute—for it was in this town, in the year 1863, that the "British Association of Gas Managers" was inaugurated—my thoughts naturally turn towards this Association and its work. After a prosperous career of 18 years under the latter title, the former more comprehensive name was adopted in 1881; whether for "better or worse" has yet to be proved. Certainly the number of members of all classes has increased from 675 in 1881, to 873 in 1885; but as this increase is largely made up of "Associates"—a class who only contribute 10s. 6d. per annum, and cost the Institute about 15s. per head—the condition of the funds has not shown that improvement which should be apparent concurrently with the increase of members. The British Association of Gas Managers "pursued the even tenor of its way" until some six or seven years ago, when a certain restlessness, a vague desire to extend its sphere of usefulness, to soar to higher heights, became apparent among its members. Some wished to do one thing and some another. In an indefinite clamor of tongues the change of name was carried, and this, so far from promoting a feeling of unity, has proved, in some sense, an apple of discord. At each subsequent meeting discussions have arisen as to the rules on points of management and administration respecting the work that should be taken up by the Institute, and all sorts of subjects; and, so far as can be judged, the present meeting will "keep the ball rolling," as several amendments in the rules are to be proposed, including some of a decidedly debatable nature.

But it must not be concluded that these differences are altogether an unhealthy sign. We have in this country a frequently-quoted proverb, "unity is strength;" but it is not of universal application, for the unity may, in some circumstances, arise from supineness or indifference. Indeed, differences of opinion are often a sign of strength, as showing that a numerous company comprising many different casts of opinion and thought, have determined that certain things should be done, but do not agree on points of detail as regards the mode of procedure to be pursued. Frequently a well-looking youth, on approaching towards manhood, exhibits a certain uncouthness of frame that entirely disappears on full development being attained. With regard to our Institute, it has been passing, since the change of name, through an active period of development; the Council, being no more than human, have made a few mistakes; but looking at the intense interest manifested in its progress—sitting in its crowded meetings and looking around, with a knowledge of the intellectual and general capabilities of many present, the stupendous achievements that they have brought to a successful issue in spite of all sorts of obstacles and adverse circumstances, it is impossible to feel downcast respecting its future. The body of men comprised in the muster roll of the Gas Institute are capable of carrying out useful work in connection with their special industry; and, in spite of present clouds, the Institute will go on and prosper, competently filling a dignified and important position as the recognized representative of the gas industry in this country.

Of the twenty-four gentlemen present at the first meeting in 1863 only seven now remain with us. A few days since one of these, Mr. P. Simpson, of Rugby, entertained his fellow survivors, Messrs. Fraser, Hutchinson, Leather, Martin, Newbigging (the President for 1885), and Patterson, at dinner, in commemoration of the visit of the Gas Institute to Manchester. This pleasant little gathering took place in an hotel at Rugby, in which some of the preliminary meetings in connection with the formation of the Association were held.

The programme now in course of execution comprises a fair representation of the various practical and theoretical questions at present claiming the more prominent share of attention in the profession. Sir Frederick Siemens gives a paper "On distributing light and heat and supplying heated air to ordinary gas burners." As might be expected, gaseous fuel and combustion come in for a large share of attention. Mr. William Gadd is to treat of "The effects of heated air on combustion," and Mr. William Sugg takes the subject of "Lighting and ventilating ordinary apartments by gas." If Mr. Sugg follows out the course adopted in his previous papers and lectures on gas lighting and ventilation, and notably in his little treatise on "The Domestic Uses of Coal Gas" (a book which every gas consumer, who would rather save money than abuse the gas company, should read), the result cannot fail to be another valuable contribution to our knowledge of this important subject. Mr. H. Townsend, who is known to have devoted special attention for some years past to the supply on a large scale of a cheap non-

luminous heating gas, of the kind generally known as "water gas," contributes a paper on "Gaseous fuel." The subject selected by Mr. Denny Lane, of Cork, viz., "On the first principles of the gas engine," bears some relationship to these. So altogether the extended use of gas comes in for a large, but by no means unnecessary, share of attention; for if gas companies do not promptly and energetically attend to the demand for gaseous fuel, which is continually increasing, other parties will step in to supply it. Mr. Denny Lane, by-the-way, is the President elect for next year, so perhaps the 1886 meeting of the Institute will be held at Cork. Most of the members of the Institute will be pleased to visit the sister Isle, and especially so if their visit is also the means of indirectly offering a compliment to Mr. Denny Lane. Mr. John Corks, in speaking "On the administration of foreign gas works;" Mr. W. Carr, in taking up the debatable subject of "Gas works rating;" and Mr. F. D. Marshall, in treating on "Differential prices for gas," will respectively represent the financial aspect of the gas industry. And Messrs. Hepworth, Read, and Newbigging, and Prof. Otto Intze, respectively contribute papers on the manufacture of sulphuric acid, gas holders and tanks, and testing coal. The hearing of these papers, with the subsequent discussions, together with the visits to the Manchester gas works, Messrs. Crossley's gas engine works, and other places of interest, cannot fail to make up an enjoyable and useful meeting.

The report of the official inspector of gas meters for the city of Manchester, for the year ended March 31st last, which has just been published, furnishes some interesting information as to the accuracy of gas meters. The number of meters tested was as follows: 5,109 new wet, and 161 new dry meters, 3,106 used wet and 1,333 used dry meters. The number rejected as not accurate within the provisions of the "Sales of Gas" Act, which specifies that gas meters must not be more than 2 per cent. fast, or against the consumer, or 3 per cent. slow, or in favor of the consumer, was 19 of the new, and 294 of the old wet meters, and 7 of the new, and 429 of the old dry meters. As expressed in percentages of the number tested it was: new wet meters, 0.37; old wet meters, 9.46; new dry meters, 4.34; old dry meters, 32.18. The wet meters evidently had the best of it, both as regards the new and also the used meters. But it must be remembered that while the dry meter tests fairly represent the measurement at the consumer's premises, the same cannot be said with regard to the wet meters, unless care was taken to maintain the proper water level. I venture to think that the statement that out of 1,333 used dry meters no less than 429 were rejected as inaccurate according to the Act, is one that scarcely does justice to the average dry meter as usually supplied in this country; perhaps the greater portion of the particular dry meters tested consisted of an old and therefore much less accurate kind than those at present manufactured.

In reference to the remarks in my last letter about sulphate of ammonia, I notice that, as anticipated, Mr. McAllum's assertions have not been permitted to pass unchallenged. Mr. F. J. Lloyd, F.C.S., of Kings College, has come forward in the columns of the *Gas Journal* with a number of indisputable practical statistics in favor of the value of sulphate as a manure. As further practical refutation the present condition of the market may be referred to. For two or three weeks past this has showed signs of improvement. Not only is an increased inquiry from buyers noticeable, but distinctly improved prices have been obtained both for present and forward deliveries. It happens rather singularly that this advance has been attended by a decline in the demand for nitrate of soda; from which it would appear that for some purposes, such, for instance, as for beet root crops, the sulphate is preferred to the nitrate. But gas companies must not hope to obtain as a permanency more than £11 or £12 per ton for this product; as, if the prices should range above this figure, a considerable quantity would be produced from coke ovens, blast furnaces, or, perhaps, specially worked up from waste coal heaps, etc., and so the market would soon be overstocked to a sufficient extent to bring the prices back to their original level.

The Inventions Exhibition at South Kensington, which is one of the series of annual exhibitions that are being held under the auspices of the government, it is needless to say, is a very extensive affair. As with the Fishery and the Health Exhibitions, it is remarked that the electric light enjoys the favor of those governmental officials who superintend the management of these large exhibitions; and the whole space allotted to gas exhibits is very much less than that occupied by the engine shed for generating the necessary electricity. Of course, coal gas is at hand ready for use in case of sudden failure; and, if general rumor is correct, it does not enjoy a sinecure. Perhaps the administrative committee recognizes the fact that the electric light requires a great deal of influential official support to enable it to stand its ground anywhere; while gas can carry its own credentials. But for the sake of completeness in an exhibition claiming to be a fair representation of modern inventions, the recent appliances introduced in connection with so general and extensive an industry as that with which we are intimately concerned, should have been more prominently set forth.

When gas is used as a "second string" in readiness for any failure on the part of the electric light, care should always be taken to leave the gas tap in

charge of a "cool hand." At a recent public meeting in a large hall the fickle and changeable brilliancies of electricity were used for illuminating the festive scene, the gas jets being lit and turned down low in readiness for any emergency. At a critical period the electric light failed, and two or three committeemen, applauding their own prethought, rushed to the main tap. But "there's many a slip," etc.; in the hurry they turned the tap the wrong way, and so completely extinguished the gas.

In the present rage for improvement—I will not say for change—even the smallest and apparently most unimportant subjects do not escape notice. A writer in an engineering magazine of recent date has expended some of his surplus ingenuity in pointing out the faults of the present forms of lamp posts from an æsthetic point of view. Besides being rendered "beautiful forever," he considers they might be turned into practical account and utilized as letter boxes, telephone stations, or expanded into a sort of sentry box for policemen. Possibly there may be room for improvement in the design of the post so as to render it light and unobtrusive in form, especially as regards those structures carrying three or more lamps, which are sometimes to be met with in the principal thoroughfares and at the crossings in our large towns, but which are, fortunately, rapidly giving way to the more efficient and economical compound burner; but to expand the lamp post into a mixture of a pillar letter box and sentry box would scarcely be an improvement. The *utilo et dutie* thus implied must be regarded as a mere vision, and any real improvement in the street lantern and lamp post—and it may be admitted there is room for such—must be in the direction of simplicity, the old-fashioned heavy column of cast iron being replaced by a lighter and more elegant structure of wrought iron or steel. But if the posts remain as they are, no one will be interfered with or injured in any way by them.

[A Paper presented by the author before the 23d Annual General Meeting of the British Gas Institute.]

On Testing Coal for its Producing Qualities.

By T. NEWBIGGING, C.E., MANCHESTER.

It is almost impossible to judge from the appearance of a coal whether its gas and coke yielding qualities are good, bad, or indifferent. So far as outward indications go, nothing is so deceptive to the inexperienced in such matters; and even to those who have had large practice in coal testing, it is very difficult to forecast with any certainty the result of a trial of any particular sample.

Some of the poorest coals and canuels have a fatty, unctuous appearance, suggestive of richness in gaseous properties; again, the most valuable canuels and shales, yielding gas in extraordinary abundance, have a dull, earthy cast, which might readily be taken as indicating poverty of composition and yield. The rich Boghead (Scotland), Sydney (New South Wales), and Cloverport (Kentucky), canuels and shales are striking examples of this latter kind. On the other hand, this does not hold good of the Brazilian shales or "Turba" that have come under my notice. These have a dull, clayey appearance, and are very indifferent both in the yield and in the illuminating power of their gas. The importance of being able to test samples of coal or cannel, or of having them tested by a specialist in whom reliance can be placed, before entering into a contract for the material in bulk is therefore obvious.

A test may be made either on a working scale, or in the experimental apparatus in the gas manager's laboratory. In the former case several tons of the material have to be used, and the trial of a single sample is a formidable and tedious process, extending over many days, until the old gas in the apparatus and holder has been replaced by the new. It is obviously impossible to test a variety of samples in this manner within a reasonable period. Besides, such a method of testing is not always satisfactory. The manager has to take a good deal for granted; he is largely dependent on subordinates for the attention and care that ought to be exercised, because his constant personal supervision throughout the time occupied by the test is out of the question.

The experimental test, in my opinion, is to be preferred for many reasons. The small apparatus is more under the command of the operator. Full justice is done to the material. The best results it is possible to obtain are secured. Time is economized in making the tests, because a number of samples can be tried in the course of, say, ten or fourteen days.

It may be urged against the experimental or laboratory test that, in practical working, equal results are unattainable. If this be the fact it only proves that either the practical working is at fault to the extent of the difference in result, or that the bulk of the material is not equal to the sample tested. Assuming, however, that the sample is a fair average of the whole, whatever the deficiencies of practical working may be, the coal at least should not be depreciated below its intrinsic value through defective heats and other faulty methods of carbonization. And although the actual everyday working of the material may afterwards fall short of the results obtained in the trial apparatus, these latter are a standard at which to aim. As a gen-

eral rule the difference between the results of actual use and the experimental results, with efficient plant and careful supervision, will not exceed 5 to 7 per cent. in favor of the experimental test.

To argue that the quality of a coal should be judged and determined solely by the results yielded by actual working, is just about as reasonable as to say that the illuminating power of gas should be decided by the methods of consumption, through possibly defective fittings, and some of the burners largely in use by consumers. Whether coal or gas, the means best calculated to develop its intrinsic qualities should be adopted.

In the apparatus the charge to be used is the 1,000th part of a ton, viz., 2.24, say, 2½ pounds.

Care should be taken to obtain a fair average sample of the coal to be operated upon. For that purpose at least half a hundredweight of the material should be broken up into small pieces and thoroughly intermixed; and from this three several charges are to be taken without selection.

The retort should be got up to, and maintained throughout the charge, at a bright red heat. If from any cause the temperature is much reduced, the test will not be satisfactory. This is especially the case in testing cannel and the rich shales. The time required to work off the charge of 2½ pounds will range from 40 to 60 minutes, according to the character of the coal.

The illuminating power of the gas given out from each charge should be ascertained by the Bunsen photometer, no other being sufficiently trustworthy for that purpose. The average of the three tests is then taken, both for yield of gas and coke, and for the illuminating power of the gas, and this will fairly represent the capabilities of the coal.

The further conditions to be observed are that the holder be entirely emptied of air, or of the previous charge of gas, and that the condenser be drained of its contents. The test charge may be continued until the whole of the gas is expelled, or otherwise, depending on circumstances. In comparing two coals an equal production from both may be obtained, and the comparative illuminating power then ascertained.

The coke and breeze should be carefully drawn from the retort into a water-tight receptacle made of sheet iron and closed by an air-tight lid; this is then placed in a bucket or other vessel of cold water, and when sufficiently cooled the coke is weighed.

For ascertaining the quantity of tar and ammoniacal liquor produced, drain the yield of the three charges from the condenser, and measure this in a graduated liquid measure. The number of fluid minims in a gallon is 61,440. Thus:

60 fluid minims = 1 drachm.
8 drachms = 1 ounce.
16 ounces = 1 pint.
8 pints = 1 gallon.

Then:

The weight of
the three charges
of coal.

Lbs. per
ton.

As 6.75

: 2,240

: : The number of
minims of
tar and liquor
obtained.

: : The total number of
minims of tar
and liquor in a
ton of the coal.

And this, divided by 61,440, gives the gallons of tar and liquor produced per ton.

Mr. T. Fletcher has recently produced an experimental retort which is heated by gas. This is handy in application, as the required temperature can be got up in less than a third of the time occupied when firing with coke. The temperature of distillation is also under perfect control, and may be regulated with nicety, which is a consideration of great importance in experimental work.

Gas Appliances at the Parkes Museum.

Wherever and whenever the opportunity is presented the English manufacturer of domestic gas appliances avails himself of the occasion to make the public better acquainted with the advantages and utility of such wares; the inevitable result being that the average English housekeeper is pretty well posted on the economy, cleanliness, and convenience of gas heat in its application to ordinary domestic purposes. Keeping in mind the great attention paid to this branch of the English gas industry, and the well-merited success that has been the reward of such attention, it would seem as though our American manufacturers might do well to experiment more closely upon the lines followed by their English brethren. An opportunity, and an excellent one, is soon to be granted the home talent to show what it can do in the line of display, and we sincerely hope that every advantage will be taken of the generous opportunity offered by the Franklin Institute in its projected "Novelties Exhibition."

Returning to the subject named in the headline given above, the London *Builder* publishes a "chatty" article on the exhibition of domestic gas appliances at the Parkes Museum (England)—for an inspection of which invi-

tations were issued on Saturday, June 6—from which we extract the following:

The exhibition is given for the purpose of displaying the exceedingly useful inventions of Mr. Fletcher, of Warrington, and therefore does not possess that wider interest which attaches to a general display of the works of many minds, and it presents none of the critical aspects of comparison. But it has the one advantage of being a unique collection of goods of the highest repute, crowned by gold medals and other awards by many international and other exhibitions, and of classes of articles of extensive and wide-spread use.

The star burners, the concentric burners, the radial burners are familiar objects in shop windows, and are universally accepted as exceedingly handy and useful; and the various less familiar modifications, such as those adapted for soldering irons, hatters' irons, laundry irons, and the drip-proof burner for glue-pots and liquids liable to boil over, are in great demand for their special purposes and applications.

There is another purpose to which gas heating is extensively applied—that of boiling water; and for this service many ingenious devices are shown. One of these, the most noticeable from its small size and its efficiency, is the small instantaneous water heater, formed by a cylindrical perforated burner, surrounded by a coil of twenty or more volutions through which the cold water flows, under the influence of the gas flame, for the whole length of the coil. Thus, say that the length of the burner is 12 in., and the diameter of the coil 3 in., the length of the pipe in which the water is heating in its passage past the flame will be, roughly, about 9 ft. It is easy, therefore, to see how water may enter at one end of the coil cold and go out at the other end hot. A very simple and perfect little instrument of this kind is shown, formed of a straight horizontal burner of about the above dimensions, for attaching to the walls of lavatories and other places where small quantities of hot water are frequently or occasionally required. The like principle of a coil is applied to the interior of the larger boilers for restaurants and hotels, around which in those cases the flame or hot air circulates freely amongst the volutions of the coil. There are also large hot water vessels heated by the star and radial burners from below. The small coil articles, however, have a most attractive appearance, and are designed with that forethought and intimate knowledge of requirements which characterize all Mr. Fletcher's inventions.

Another very useful article remains to be noticed amongst the smaller goods—the coffee roaster. The atrocious manner in which coffee is commonly prepared needs an almost universal remedy, and the hope cannot be suppressed that these little instruments may have a very wide employment. In sizes they are made from that equal to roasting from 2 oz. to $\frac{1}{2}$ lb., up to a large size for hotels for roasting from $\frac{1}{4}$ lb. to $1\frac{1}{2}$ lb. A quarter of a pound may be roasted thus in four minutes, and a pound in eight minutes; and we were assured by the attendant who showed the goods that a saving of 4d. per pound would be effected by the apparatus—a strong recommendation to housekeepers.

Two other different applications of gas to its natural purpose of heating—for cooking apparatus and for stoves for heating rooms—are represented by many well considered productions. The cooking stoves are of excellent design, and the lecturer on cooking at the Parkes Museum speaks most approvingly of their practical application. Gas for cooking, however, is not popular with domestic servants, and gas stoves in the kitchen are even strongly disliked. But the objection to them is in the largest degree that there is no fire to be seen. The watching of the flames and glowings of a coal fire has universal attraction; even dogs enjoy basking in the warmth of its rays and in its wavering light. For them, no more than for servants, does the gas fire seem to complete the appearance and the comfort of home. It is the same in all classes of society. The open grate and the coal or wood fire is the symbol as well as the reality of home. And although Mr. Fletcher produces excellent stoves with asbestos fiber squares of unquestionable quality, it is only for temporary purposes that such stoves have as yet in the world any actual occupation. They are very convenient in reception and other rooms, where visitors are intermittent, or occupation exceptional. They are also very handy at particular seasons, as late spring, or in autumn, when cold days interpose with warmer weather; but the gas fire for sitting-rooms and for bedrooms, in the present circumstances of the gas itself, is distinctly not a sanitary arrangement. The fault, however, is not separable from the gas companies. Nor can Mr. Fletcher do better until he can get gas—or, more correctly, pure hydrogen; for it is the pure hydrogen that is required for heating, and not the mongrel compound, carburetted hydrogen, supplied for lighting purposes. The carbon deteriorates the gas for all heating purposes. It is the source of smoke and of fumes; and neither cooking nor domestic heating can be properly effected when such impurities arise. To avoid them requires, under present circumstances, very careful manipulation. For cooking, gas should, indeed, be the most perfect fuel. Its quantity can be perfectly regulated; its combustion equally perfectly assured; and consequently the exact temperature can be applied with unvarying certainty for

any period of time; or the temperature can be raised or lowered in any way desirable. There is no waste of fuel; there is no time occupied in getting up a fire, as with coal, nor any further time taken in letting down a fire when once got up. There is no fire to be maintained whilst none is wanted against some future period when the fire will be wanted. The ingenious devices Mr. Fletcher puts forward in the shape of cooking stoves are everything seemingly required for the application of gas, and they ought to tempt cooks to trials of them. The burners can be used singly or in multiple; they revolve, so that by turning the flame downward grilling may be performed by the radiation from them downward, whilst boiling may be performed by the hot air rising upward from the flames beneath. Large square central chambers, clean whitewashed on the sides, and with gravy trays at bottom, afford admirable spaces for the cooking of joints or poultry. Double iron doors with silicate packing between the twin outer and inner sides stop all outward radiation of heat. The handiness, cleanliness, and convenience seem unexceptionable; but we doubt whether, whilst the companies carburet their hydrogen, gas cooking will take extensive hold in general domestic service. The admirable way in which gas stoves can be used even now in large establishments by trained experts is indicative of what their application might become if the gas supplied were more suitable for the purpose.

The Parkes Museum authorities are doing well in submitting such an excellent series of special class goods to the public view, and which are so worthy of being selected as specially illustrating the sanitary conditions attainable even now by common gas in its present state.

Train Lighting.

Engineering claims that electricity has lately been tried for train lighting in Germany, at Frankfort-on-the-Main. The experimental train consisted of a first, second, and third-class carriage, and a luggage van containing a Mochring dynamo, and 26 accumulators. The dynamo was driven by pulleys and belts from the axles of the wheels of the van at a speed of 700 revolutions per minute, when the train was running at a speed of 18 to 42 miles per hour. When the speed was less than 18 miles per hour the lamps were thrown out of circuit with the dynamo and accumulators, and fed from the accumulators direct by an automatic commutator. During the day the accumulators were charged with the lamps out of circuit. The cost of installation was 125*l.*, and weighed about 12 cwt. There were 12 incandescent lamps in all, and the cost of fitting up each carriage is estimated at from 3*l.* to 4*l.* The experiments demonstrated that the electric light is capable of lighting trains in motion and during stoppages; and the cost is estimated at about 1*d.* per lamp per hour. The trials continued for six weeks, and as everything was done automatically except at starting, the attendance required was slight. The difficulty of breaking up a train and shunting on to a new line while keeping the carriages lighted does not, however, seem to have been dealt with in these experiments.

[As *Engineering* saw fit to mention that one omission was made in the experiments, a disinterested person might be led to remark that the cost of installation and lighting charges (as evidenced by the figures given, as developed by the German railway experimenters) would more than likely prove a sufficient bar to the extension of the system. Those interested in the matter of lighting railway carriages with compressed gas will not tremble much over a recital of the Frankfort-on-the-Main experiments.]

On the Removal of Paint and Varnish.

A contemporary explains that where it is requisite to remove painting entirely from its ground it is usual to resort to mechanical scraping, etc., or to the very dangerous operation of setting fire to the painted surface immediately after washing it over with oil of turpentine, called turps, for burning off the paint from old disfigured work—an operation that may be safely and more easily accomplished by laying on a thick wash or plaster of fresh-slacked quicklime mixed with soda, which may be washed off with water the following day, carrying with it the paint, grease, and other foulness, so that when clear and dry the painting may be renewed as on fresh work. Clear-colouring is sometimes resorted to over old painting, for the purpose of repainting, in which case the surface exposed to the sun's rays or alterations of temperature is liable to become blistered and scale off. Varnish may be removed by friction—if it be a soft varnish, such as that of mastic, the simple rubbing of the finger ends, with or without water, may be found sufficient; a portion of the resin attaches itself to the fingers, and by continued rubbing removes the varnish. If it be a hard varnish, such as that of copal, which is to be removed, friction with sea or river sand, the particles of which have a rotundity that prevents their scratching, will accomplish the purpose. The solvents commonly employed for this purpose are the several alkalies, alcohol, and essential oils, used simply or combined. Of the alkalies the volatile in its mildest state, or carbonate of ammonia, is the only one which can be safely used in removing dirt, oil and varnish from a picture—which it

does powerfully; it must, therefore, be much diluted with water, according to the power required and employed with judgment and caution, stopping its action on the painting at the proper time by the use of pure water and a sponge. A thick coat of wet fuller's earth may be employed with safety, and, after remaining on the paint a sufficient time to soften the extraneous surface, may be removed by washing, and leave the picture pure; and an architect of the author's acquaintance has succeeded in a similar way in restoring both paintings and gilding to their original beauty by coating them with wet clay. Ox-gall is even more efficacious than soap. In filling cracks and replacing portions of the ground, putty formed of white lead, whitening, varnish, and drying oil, tinted somewhat lighter than the local colors require, may be employed, as plaster of Paris may also in some cases; and in restoring colors accidentally removed, it should be done with a vehicle of simple varnish, because of the change of tint which takes place after drying in oil.

ITEMS OF INTEREST FROM VARIOUS LOCALITIES.

SOMETHING FROM TIFFIN, OHIO.—Mr. Jos. M. Bate, Secretary and Supt. of the Tiffin Gas Light Company, writing to the JOURNAL office, under date of June 22d, says: "The article contributed to the columns of JOURNAL, in issue of June 16th, by Mr. Frederic Egner, fits the case of the Edison Electric Lighting Company of this place, with two exceptions, the points of difference being in regard to the total number of lamps in use, and price of coal. At Tiffin the total of incandescent lamps foots up to 600 ten-candle power lights—this statement includes all descriptions or powers of lights, but I have averaged them on the basis of ten-candle power—and coal costs nearer to \$3 than to \$1.65 per ton. It is only on rare occasions and with new lamps that a rated 16-candle incandescent gives a light better than eight candles. In one instance that I knew of here nine 16-candle power Edison lamps were installed to replace four 7-foot gas burners; and the electric illumination that resulted from the substitution was far from being the equal of that which it superseded. We—i. e., the Tiffin Gas Company—can replace ten of their 16-candle power lamps with seven gas burners (Bray, six feet), and the superiority of the gas illumination is readily and at once acknowledged. The electric lighting supplied at Tiffin is generally arranged for under the contract system, and the charges for same have now been reduced by about 50 per cent. from those which rated in 1884. With our Edison Company stoppages are frequent, and their customers come and go. Despite all their efforts, and notwithstanding their 50 per cent. reduction in prices, a majority of those using the electric light are either stockholders in the Edison company, or else rent their premises from those who are pecuniarily interested in that corporation. We still maintain a standard gross rate of \$2.25 per 1,000 cubic feet for gas, with certain stated discounts; and also stand by our colors in the matter of 20-candle power gas. We use Second Pool Youghiogheny, and employ Kanawha cannel for enriching. For my own part, I believe that good coal gas, sold at a low price, has nothing to fear from Mr. Edison's incandescent system." The trouble with Mr. Edison has been that he has found out how much his system has got to fear from illuminating gas, and it has been noted, no doubt, the "wizard" is less free and outspoken in his declarations regarding the fact that the gas industry was about to be "wiped from the field of its former triumphs." It will stand "a deal of rubbing" yet, Mr. Edison; and the truth is, "the more it is rubbed the better it shines."

OLD WOODEN WATER PIPE.—Some two or three years since we had occasion to note the removal of some long sections of wooden water pipe, put down, over 60 years ago, by the Manhattan Banking Company, in the downtown district of New York city, when that corporation included among its other pursuits the supplying of water to a certain section of the metropolis. This pipe was in remarkably good condition after its long burial, and we supposed that its preservation was in great part attributable to the nature of the soil in which it had been imbedded. This, however, would not seem to have exerted such a great influence after all; since the testimony of Mr. P. A. Taylor, of the Engineers Club, of Philadelphia, Pa., given at a business meeting of that body last December, goes to show that a section of the wooden water pipe laid by the late Stephen Girard, in the spring of 1834, a portion of which was unearthed in the fall of 1884, showed but little trace of decay. The nature of the soils, as between the location of the New York and Pennsylvania specimens of pipe that were removed, was totally different. The New York soil was in the nature of a fine sharp sand, while that of Pennsylvania was a soft clay. Mr. Taylor, in commenting on the matter, said: "The pipes were made of yellow pine logs, laid in sections, average length of each section about 18 feet; diameter of pipe, 15 inches; diameter of bore, 9 inches. It was laid from a dam located on a small stream known as Mud River, nearly on the summit of Broad Mountain, for a distance of 1½ miles to the head of Plane Number Five, of the Danville and Pottsville Railroad. It was used for the purpose of conveying water to the steam engines for

hoisting loaded cars from the Mahanoy Valley. The fall from dam to boilers was about 40 feet. The pipe from which the specimen under discussion was cut was dug out of the ground in 1884 by the Philadelphia and Reading Railway Company, which had built a new dam on the same site as the old one for the purpose of gaining an ample supply of water for its locomotives, stationary engines, etc. The company laid a new cast iron main of ten inches diameter, and followed as nearly as possible the old line of wooden water pipe. The specimen was found at a depth of about five feet below the surface, in a conglomeratic soil, and when taken out had been covered up for fifty years. When cut the specimen showed the pipe to be in a wonderful state of preservation, especially at the joints where the sections were connected. Sap was still in the wood."

A LIVELY SOUTHERN GAS MAN.—Mr. C. W. Robinson, of Meridian, Mississippi, some three years ago made up his mind that this thriving southern town should be lit by gas, and having made up his mind to that effect, he instituted the Meridian Gas Light Company without much delay. On October 1st, 1882, the Meridianites had the satisfaction of being emancipated from the compulsory use of ill-smelling kerosene lamps. The sum of \$35,000 was expended in construction, and this expenditure, or its result, was calculated as ample to meet the wants of the gas consumers of the town for several years to come. The calculation, however, was incorrect, simply for the reason that Meridian grew over-rapidly; and now Mr. Robinson finds himself compelled to double the capacity of the plant. It is expected that the enlargements will be perfected by September 15th. Mr. John Stafford is Superintendent of the works. It is about 21 years ago—to be precise, on the 19th day of Feb., 1864—since Gen. Sherman consigned the town of Meridian to destruction by fire, but it has been the decree of time that it should arise from its ashes and enter upon a new term of vigorous growth and business prosperity.

AN ELECTRIC FIRE.—Imperfectly insulated electric light wires, at midnight of June 17th, set fire to the awning in front of the premises No. 925 Broadway, New York city. Mrs. Lynch, the proprietress of the store, placed her loss at \$25. Better set to work placing the wires underground; or, at any rate, let us soon have information that the Commission ordered by the Legislature to attend to this underground wire business is inclined to begin the investigation with which it was charged.

PATENT GRANTED.—Mr. O. B. Monett, Manager of the Bucyrus (Ohio) Gas Works, informs us that letters patent have been granted him on that sheep-dip preparation of his, mention of which was made in previous issues of the JOURNAL. The "dip" is made from the waste lime of gas purification; and perhaps Mr. Monett might be prevailed upon some day or another to inform us as to the method or system pursued in the manufacture of the preparation.

TO MANAGE THE WAUSAU (WIS.) GAS WORKS.—Mr. John Whitehead, formerly of Hamilton, Ontario, has been named as manager of the Wausau plant.

TO HAVE AN AGENCY AT CHICAGO, ILLS.—Messrs. Harris, Griffin & Co., the meter manufacturing firm of Philadelphia and New York, have determined to "move along with the procession," and announce that they have opened an agency or headquarters in the West. They have hired the premises, No. 75 North Clinton street, Chicago, Ills., and there propose to "keep open house" for the reception of their customers and friends. Chicago will soon be known as the home of the meter maker.

PRICES OF GAS AT NEBRASKA CITY, NEBRASKA.—The following are the schedule prices of gas as sold at Nebraska City—the gross price (from which all discounts are rated) is \$3.50 per thousand:

1,000 feet per month, and under 2,000	\$0.20 per M.
2,000 " " "	3,000	.40 "
3,000 " " "	4,000	.60 "
4,000 " " "	5,000	.80 "
5,000 " " "	10,000	1.00 "
10,000 " " "	25,000	1.10 "
25,000 " " "	40,000	1.20 "
40,000 " " "	60,000	1.40 "
60,000 " " "	and upward	1.50 "

THEY SHOULD ACCEPT THE PROPOSITION.—On the evening of June 5 the City Council of Green Bay, Wis., received a communication from the managers of the local gas company in which the latter proposed that if the city would erect and use one-half dozen street lamps at stated places they would furnish all the gas supplied to city buildings at the rate of \$2.40 per 1,000 cubic feet, and would agree to furnish gas for general consumption at \$2.50. This proposition was referred to the committee on gas. We notice that, at

the same meeting, the joint committee appointed to consider the petition of the Western Electric Light Company, of Chicago, Ills., who asked that it be allowed to erect poles and stretch wires in and over the city for the purpose of supplying electric illumination, reported in favor of the project. The report was adopted; and now we may reasonably expect that before a great while Green Bay's taxpayers will be called upon to pay a nice round sum for electrical street disillumination.

FIGURING ON THE TAX ROLLS.—The personal property of the gas companies in the city of Brooklyn, N. Y., has been put down for 1885 at the following figures—the corresponding assessment for 1884 is also given.

	1885.	1884.
Brooklyn	\$795,200	\$802,800
Fulton Municipal	1,767,200	1,565,000
Citizens	361,000	470,000
Nassau	384,000	566,000
Metropolitan	322,400	315,400
Williamsburgh	437,800	373,000
Peoples	137,000	142,000
Totals	\$4,204,600	\$4,234,200

THE JAMESTOWN (N. Y.) GAS COMPANY MAKES A NEW DEPARTURE.—It is understood that the Jamestown Gas Company is making preparations to introduce incandescent lighting into the business district of that city. The best system or plan to adopt for carrying the scheme out is now under consideration, and will in large measure be determined by the advice of the Company's consulting engineers, Messrs. Westinghouse, Church, Kerr & Co., of this city. It may be good policy for gas companies to make investments in incandescent electric lighting plants; but, speaking for ourselves, we fail to appreciate the wisdom of the plan. If a gas company is so situated that it cannot supply gas light at a cheaper figure than that which must be charged in order to make a profit on incandescent electric lighting, it is about time that such gas company "spiked its retorts" and blew up its gasholder.

KEEPING THE ENGINES TO THEIR WORK.—It is said that the Fulton Municipal Gas Light Company, of Brooklyn, N. Y., operates two 40 horse power Westinghouse engines, on continuous stretches of six weeks at a time. That is keeping them on the "run," sure enough.

AWARDED THE FIRST PREMIUM.—The proprietors of the Laclede Fire Brick Manufacturing Company, of St. Louis, Mo., well known throughout the West and South as manufacturers of standard fire clay goods, had sufficient pluck and business tact to take advantage of the opportunity afforded by the late World's Fair, held at New Orleans, La., to make an exhibit of their manufactured wares, principally with a view toward letting the Southern gas man know how good an article of fire clay was yielded from the Missouri beds. We are glad to announce that the exhibit attracted very great attention, and are more than pleased to further announce that the Judges of the fair have awarded the St. Louis firm a first premium for the best fire clay gas retorts, as also for the best specimens of fire brick.

POOR BROOKLYN.—About the middle of May the Commissioner of City Works of Brooklyn, N. Y., acting under authorization of the Common Council, made contracts for the erection and maintenance of a total of 255 arc lamps. Each lamp is to be of 1,200 candle power, and their cost is to be 50 cents each per night, or \$182.50 per year. The Municipal Electric Light Company, with its field of operations in the Eastern District, gets 151 of the arcs; the Citizens Company, operating in the Western (or principal) division of the city, being allotted 104. It is claimed that the first-named allotment (151) of arcs will displace 958 gas lamps, and the second (104) will displace with 852 gas lamps. The true displacement of gas lamps by the arcs—the result of much close investigation by the writer—will be much nearer to 720 and 590 respectively; and, indeed, this estimate is somewhat in excess of that which will actually occur. As a sample of what they propose to accomplish it is only necessary to say it has been agreed upon that 20 arcs will be sufficient to illuminate the surface of Atlantic avenue from its beginning at South Ferry to the point where it is intersected by Fourth avenue. With that illustration, at least to those conversant with the topography of the City of Churches, "enuff is sed." While the territory of Brooklyn is nominally parcelled out between two electric lighting companies, the real fact is that the two are one—a sort of unity "as it were." When these people were given their franchise we made the assertion—and based it upon the names of one or two of the stockholders—that it would not be long before the electrical promoters fastened their grip upon the city's treasury. Brooklyn needs electrical illumination just about as much as the waters of Ridgewood* reservoir need salt.

MR. A. L. ALLEN, OF POUGHKEEPSIE (N. Y.) MAKES A DISCOVERY.—Friend Allen, now that he has succeeded in routing the electric lighting pro-

*The name by which the source of Brooklyn's water supply is generally known.

moters "up his way," has turned his attention to the matter of proving that marsh gas is one of the most deadly poisons known to the toxicologist. Some Philadelphia amateur journalist tried his hand in that direction not long ago, but failed to make a lasting impression; and we are afraid that Mr. Allen will fall short of transmitting his name to posterity as a consequence of the marsh gas theory. If he wants to know how dangerous carbonic oxide really is to human life, let him read the following item.

KILLED BY GAS.—A sailor who registered as A. Steinert at Guest's Hotel, 127 West street, this city, at 12:30 A.M. of June 24th, was shown to room 32. At 9:30 A.M. same date it was discovered that gas was escaping in room 32. The door was broken open, and Steinert was found unconscious in bed. The gas had either been blown out or carelessly turned on after it had been turned off. The man died. He was about 35 years old.—N. Y. Sun, June 25.

PERHAPS DETROIT (MICH.) WILL BANISH THE TOWERS.—Detroit has enjoyed the distinction of being the most ridiculously-lighted (as to its streets) city in the world for a period of a year or so; but it seems just now barely probable that the electric towers have had their day, as, at the Council meeting held there on June 16th, a resolution was carried inviting tenders for lighting the streets from the gas company, and from electric lighting companies other than the Brush concern. It was supposed, in this neighborhood at least, that the Brush Company came pretty near to "owning" the public authorities of Detroit, and we would be pleased to have that supposition refuted.

UNITING THE TWO STATIONS OF THE CINCINNATI (OHIO) GAS LIGHT COMPANY.—On Monday, June 15th, the East End Station of the Cincinnati Gas Light Company was joined to the main of the old works, and the two carbonizing plants are now practically one and the same thing. Those who read Gen. Hickeulooper's address,* delivered at the February meeting of the Ohio Gas Light Association, will have a pretty clear idea as to the magnitude and completeness of the East End Station of the Cincinnati Company; and the entire fraternity will join with us in extending hearty congratulation to the General and his associates over the happy termination of their big construction task.

SOMETHING FROM RICHMOND, VA.—On the evening of June 11th the Committee on Electric Light, of the Richmond City Council, met to consider bids which had been received for lighting the city by the arc system. There were two bidders—the Thomson-Houston Electric Company, of Boston, Mass., and the Schuyler Electric Light Company, of Hartford, Conn. The Schuyler Company agreed to furnish 100 arc lights at an equal charge or expense to that paid for the gas lamps that would be displaced. The Thomson-Houston folks offered to furnish 50 arcs at a charge of \$120 each per year; if the city would order 100 lights the company agreed to charge but \$108 per annum each. Judging from the tenor of the discussion it is quite likely that some sort of an electric lighting contract will be made; and we suppose that we may call upon Mr. Higgins to keep us informed as to the action taken.

PERSONAL.—Mr. Geo. Shepard Page, while on his travels out West, has been doing yeoman's work in the matter of exposing the fallacy and pretentiousness of the claims now being so recklessly made by the electric lighting promoters in the West. Mr. Page has a certain style of argument that carries conviction with it, and he is never slow in making proper use of the facts which his keen watchfulness is ever on the alert to capture.

NATURAL GAS AS A FUEL.—The Associated Press managers are responsible for the following statement: "Pittsburgh, Pa., June 22d.—By the first of next month every iron and steel mill in Pittsburgh and vicinity, with one exception, will be using natural gas as a fuel. This will reduce the consumption of coal here 38,250,000 bushels per annum, or nearly one-seventh of the yearly output of the region tributary to Pittsburgh. It will also throw out of employment thousands of firemen, coal heavers, and ash handlers employed in the mills." If the above estimate, regarding quantity of coal that will be dispensed with, is true, why, the colliery operators and coal handlers in that vicinity will experience a decrease in their receipts approaching closely to the sum of two and one-half millions of dollars. We have an idea that the "picture" is somewhat overdrawn.

ELECTRIC LIGHT ON RAILWAYS.—According to the *Railway World*, the Pennsylvania Railroad Company continues the experiment of lighting cars by electricity from Brush storage batteries, using the lights on a train running between Altoona and Pittsburgh. It claims that the arrangement has worked satisfactorily. The storage batteries are charged in the company's shops by connection with a Brush dynamo electric machine. It takes about 9 hours' running to charge the batteries with sufficient electricity for the round trip. The intention is, should the plan be found advisable for general use on through trains, to establish electric plants at different stations for charging batteries. Rather an expensive proceeding, we should judge.

*See Journal, March 16, p. 149.

Position Wanted,

As Constructing Engineer or Superintendent.
Twenty-three years' experience with coal and petroleum gas works. Address
W. C. WREN, Gas Engineer,
625-1t Jay and Water Sts., Brooklyn, N. Y.

SITUATION WANTED

As Manager or Assistant

in a gas works. Twenty-nine years' experience; entire management last thirteen years; references on application. Address
625-2t P. O. Box 181, Brockton, Mass.

SITUATION WANTED

By a practical man

To Prove and Repair Meters.

Would be a useful acquisition to a gas company, to attend to their general work. Address
625-1t "EXPERIENCE," Office of this Journal.

**WANTED, TO PURCHASE OR LEASE,
A Coal Gas Works,**

State terms and particulars in full. Address
625-2t GAS WORK, care this Journal.

FOR SALE.

Second-Hand Gas Apparatus.

One Condenser, 4½ ft. diameter by 13 ft. in length over all, containing 150 two and one-half inch tubes, 8 ft. long with 12-in. connections and bye-pass.

Two Smith & Sayre (12-inch) Steam-Jet Exhausters, with 3 Self-acting Bye-Passes.

Four Purifying Boxes, 10 ft. by 14 ft. by 3 ft., with 12-inch connections and center seal.

All in good order, and will be sold cheap. Address

PETER P. MILLER, Manager Citizens Gas Co.,
Buffalo, N. Y.

WANTED,

A Superintendent for a Gas Works in the South. Gas made from Stone Coal. None but a thoroughly competent, industrious, and sober man need apply. All applicants will be expected to forward first-class references with their applications. Address
624-1t "R. J.," Care this Journal.

FOR SALE,

Second-Hand Gas Apparatus.

The Louisville (Ky.) Gas Light Company wishes to dispose of the following:

- 15 Sixteen-Inch Chapman Valves.
- 6 Twelve-Inch Chapman Valves.
- 2 Twelve-Inch Center Seals & Connections.
- 2 Smith & Sayre Gas Steam Governors.

All in good order, and will be sold at low figures. Address inquiries to

A. H. BARRET,
Engineer's Office, Louisville (Ky.) Gas Company.

Ammonia Plant for Sale.

Owing to a change in the manufacture of gas by the York Gas Company, we offer for sale our complete plant for the manufacture of sulphate of ammonia from gas liquor. Capacity, 500 lbs. daily, which can be increased to 1,000 lbs. Suitable for a gas works carbonizing from 1,000 to 10,000 tons of coal per annum. We will agree to deliver, set up, and start the same for a moderate price, and show a fair profit. For further particulars address

622-4t C. H. DEMPWOLF & CO.,
YORK CHEMICAL WORKS, YORK, PA.

It will "Pay the Piper,"

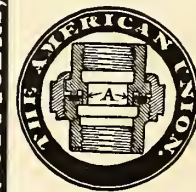

If he aims to pipe well for STEAM, WATER, GAS, ACIDS, OILS, AMMONIA, &c., to examine this UNION, which requires no packing, but is always ready for instant use. When you next order Fittings of any Dealer, ask for a sample American Union to come with them, and it will tell you the whole story, or we will, if you write us for particulars.

PANCOAST & MAULE,
PHILADELPHIA, PA.

GAS CO. OFFICERS,

READ AND REFLECT.

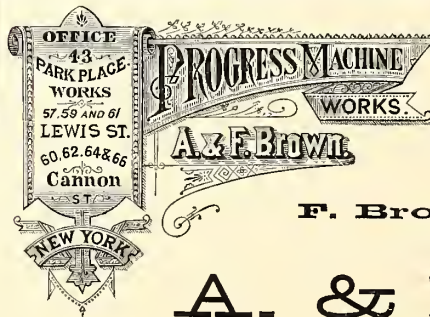

**Shafting, Pulleys,
HANGERS.**

F. Brown's Patent Friction Clutch.

Send for Illustrated Catalogue and Discount Sheet to

A. & F. BROWN,
No. 43 Park Place, New York City.

1885. The "Novelties" Exhibition 1885.

OF THE

FRANKLIN INSTITUTE, PHILADELPHIA.

Opens September 15th.

Closes October 31st.

This Exhibition
will afford
INVENTORS
AND
Manufacturers
IN THE FIELD OF
Gas Lighting
a good opportunity



of bringing to public
notice their
LATEST AND BEST
Appliances
AND
PROCESSES
for Manufacturing,
distributing, & using
Illuminating Gas.

For copies of Rules and Regulations, Blank Forms of Application for Space, and other information, address

COMMITTEE ON EXHIBITIONS,

Franklin Institute, Philadelphia, U. S. A.

Connelly's Automatic Gas Governors, FOR STREET MAINS.

The Only Strictly Automatic Gas Governor in the Market! No Weights! No Clock! No Attention Required!

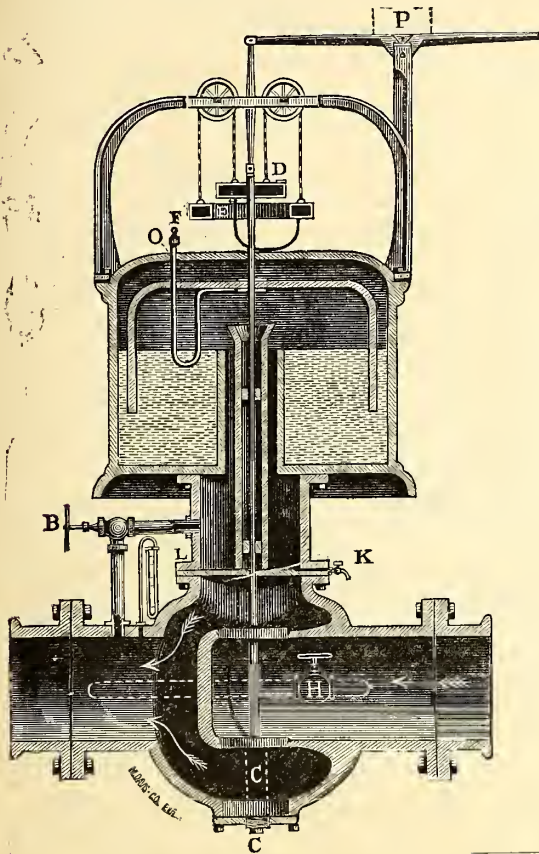

Will respond instantly, **WITHOUT VIBRATION**, to changing pressure from Telescopic Holders, or to any sudden increase in consumption, however large; which cannot be said of any other Governor. It is this feature that enables us to claim it to be

THE ONLY PERFECT AUTOMATIC GAS GOVERNOR EVER MADE.

It will control and regulate the pressure to suit the variation in consumption with perfect accuracy and absolute reliability. It will respond instantly to any unusual demand during the day or night, increasing volume and pressure together, and reduce same to the minimum as the lights are extinguished. It does away with all necessity for watching changes in the weather, or extra occasions of unusual demand, and insures the pressure being the exact amount required at all times.

We unhesitatingly claim our "Automatic Governors" to fill every requirement. They are simple in construction, cannot get out of order, will not corrode, occupy but little room, and can be placed and adjusted by anyone. They are capable of a wide range of adjustment, and can be set to any maximum and minimum pressure desired.

The accompanying cut shows the pressure held in the Columbus, Ohio, gas mains by one of our 16-inch Governors, the *light line* showing the pressure held during Friday, April 24th, 1885, and the *heavy line* pressure held Saturday, April 25th, 1885; the *two lines* showing the actual service of the Governor under varying demands. The accompanying letter from Mr. McMillin attests its wonderful perfection in very brief terms:

Pressure in Street Mains at Columbus Works.

COLUMBUS GAS LIGHT & COKE Co., }
COLUMBUS, OHIO, April 28, 1885. }
MESSRS. CONNELLY & Co., LIMITED, No. 407
Broadway, New York:

Gentlemen—We have had one of your Automatic Governors in use for some months, and are well pleased with it. No attention is required more than to give it a few drops of oil once a week. The register card it makes clearly indicates the character of the weather, whether clear or cloudy. It puts three or four tenths less pressure on Sunday night than on other nights of the week, and takes the pressure off two or three hours earlier. In other words, *it supplies the demand*—no more and no less. Yours truly,
E. McMILLIN, Superintendent.

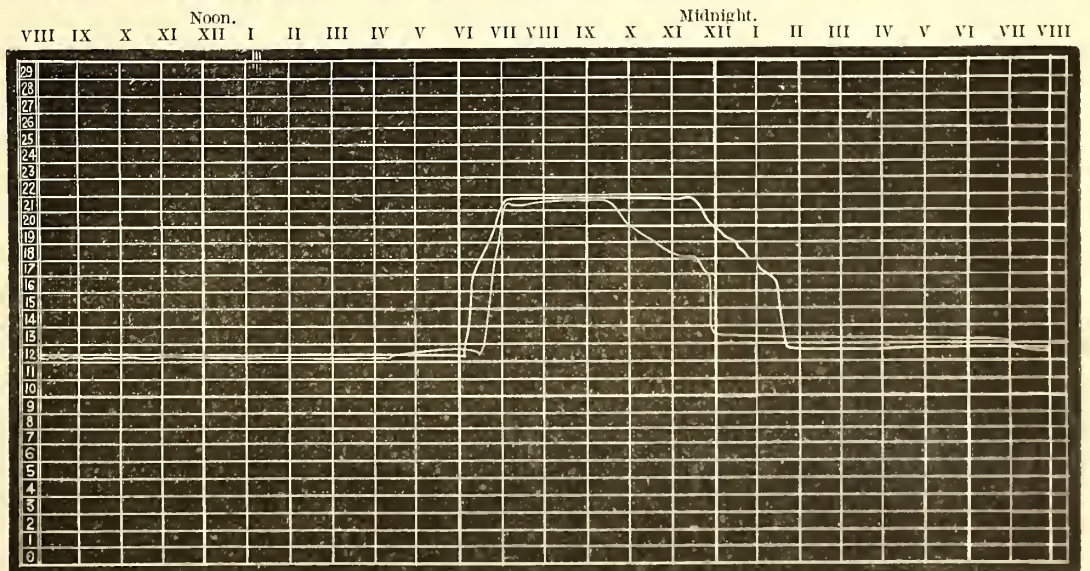

In calling the attention of our friends and patrons to our Automatic Governor we do so in full confidence that it will give most thorough satisfaction, and pay for itself in from one to ten months (depending upon the percentage of leakage), which any manager can easily estimate for himself. Certainly nothing can be placed in a gas works to-day that will pay for itself so soon. Correspondence solicited.

No. 407 Broadway, New York City. **CONNELLY & CO., Limited.** 33d & Smallman Sts., Pittsburgh.
New England Agent, C. H. SPRAGUE, 70 Kilby Street, Boston.

THE CLERK GAS ENGINE.

Highest Award American Institute, New York, 1883. Silver Medal American Institute, N. Y., 1884.
Gold Medal Awarded Crystal Palace Electrical Exhibition, London, 1882.
Highest Award for Motive Power British Section International Exhibition of Electricity, Paris, 1881.

Reliable.
No Boiler.
Steady.
No Coal.
Simple.
No Ashes.
Compact.

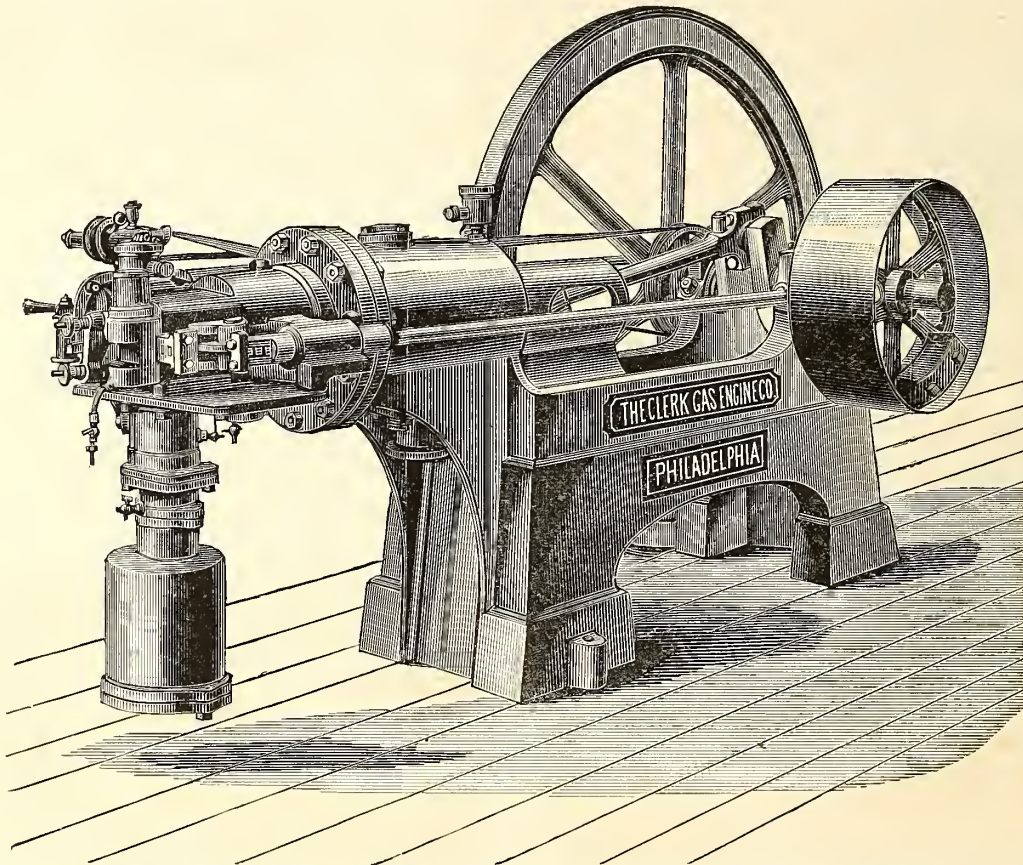

Economical.
No Engineer.
No Explosion
No Gearing
Wheels.
No Danger.
No Parts
requiring
frequent
renewal.

REQUIRING ONLY A MATCH TO START IT--GIVING ITS FULL POWER IMMEDIATELY.

We would inform the public that during the last few months we have improved THE CLERK GAS ENGINE to such an extent that we can now offer an engine vastly superior to our former pattern. These improvements have enabled us to sell our engine at a GREATLY REDUCED FIGURE, partly on account of the decreased weight (our engine weighing about half that of others giving the same Brake H. P.). The consumption of gas has been decreased to a considerable extent, and the Brake H. P. has been increased some 25 to 30 per cent. All parts of the old design that were considered defective have been remodeled and new designs added. We now have an engine second to none as regards power, consumption, and ease of working. With our new engine all trouble in starting has been removed, the noise reduced to a minimum, and the regularity of motion is now all that can be desired. We guarantee all we claim for it, and the material and workmanship being of the best, enables us to guarantee the engine for twelve months.

SOLE MAKERS,

THE CLERK GAS ENGINE CO.,

WM. W. GOODWIN, President. E. STEIN, Secretary. S. LEWIS JONES, Asst. Secretary. L. P. GARRET, Supt.

Main Office, 1012-1018 Filbert Street, Philadelphia, Pa.

BRANCH OFFICES,

142 Chambers St., N. Y.

4 West Fourteenth St., N. Y.

76 Dearborn St., Chicago

General Agents,

THE GOODWIN GAS STOVE & METER CO.

Of Philadelphia, New York, and Chicago.

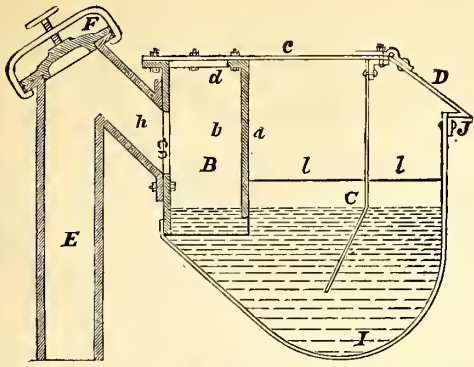

Boardman Hydraulic Main,
Patented October 7, 1884.

For description, see AM. GAS LIGHT JOURNAL of Feb. 2, 1884.
For terms, apply to

A. E. BOARDMAN, Macon, Ga.

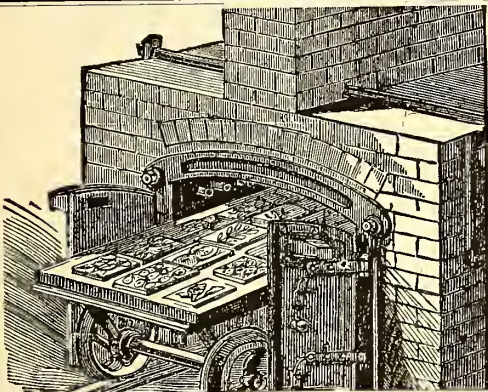

Glass-Staining Gas Kiln.
BAKERS' & CONFECTIONERS' OVENS (PAT.)
Thompson Gas Kiln & Oven Co.
59 Carmine St., N. Y.
Send for Circular by mail.

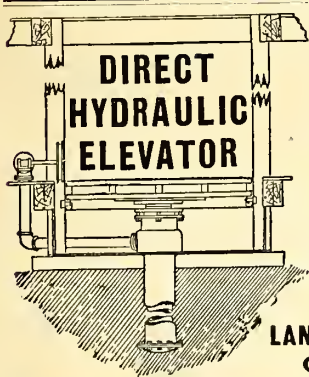

With Iron or Wood Platform.

Largely used by Leading Gas Co.s for Coal and Coke Lifts.

Adapted for use with city service, or special pumping and accumulator system. For prices address the

LANE & BODLEY CO.,
Cincinnati, O.

MITCHELL, VANCE & CO.,

MANUFACTURERS OF

Chandeliers

and every description of

GAS FIXTURES.

Also manufacturers of Fine Gilt Bronzes and Marble Clocks, warranted best time-keepers. Mantel Ornaments, etc.

Salesrooms, 836 Broadway, N. Y.

Special Designs furnished for Gas Fixtures for Churches, Public Halls, Lodges, etc.

Iron Sponge,
GAS EXHAUSTERS,
AUTOMATIC GAS GOVERNORS,
CONNELLY & CO., Limited,
No. 407 BROADWAY, NEW YORK CITY.

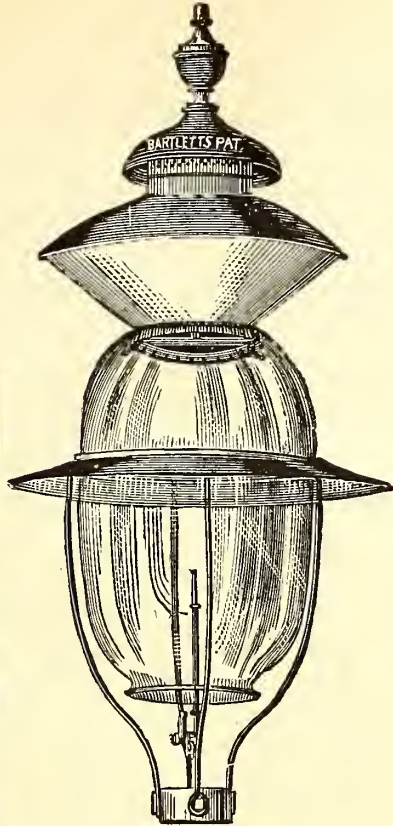

C. BARCALOW, PREST.

J. V. BARCALOW, SEC. & TREAS.

BARTLETT
Street Lamp Mfg. Co.

MANUFACTURERS OF

Bartlett's Patent

GLOBE LAMPS.

FOR

Streets, Parks, Railroad Stations, Public Buildings, Etc.

LAMP POSTS A SPECIALTY.

Office and Salesroom,

No. 35 Howard Street, N. Y. City.

Gas Companies and others intending to erect lamps and posts will do well to communicate with us.

F. M. ROOTS.

S. C. ROOTS

D. T. ROOTS.

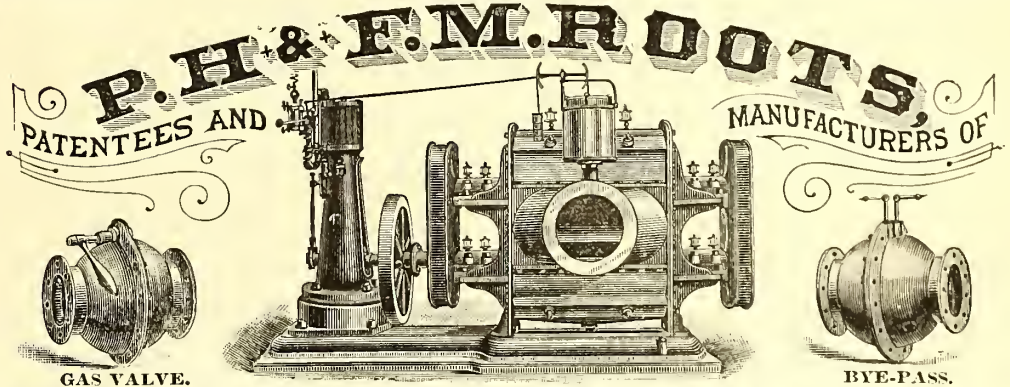

IMPROVED GAS EXHAUSTER,

WITH ENGINE ON SAME BED PLATE, OR WITHOUT.

BYE-PASSES, GAS VALVES, GOVERNORS, ELBOWS, PIPE-FITTINGS, Etc., FURNISHED TO ORDER,

P. H. & F. M. ROOTS, Patentees & Manufacturers, **CONNERSVILLE, IND.**

S. S. TOWNSEND, General Agent, 22 Cortland St. and 9 Dey St., N. Y.

JAS. BEGGS & CO., Selling Agents, 9 Dey St., N. Y.

COOKE & CO., Selling Agents, 22 Cortland St., N. Y.

✻ SEND FOR ILLUSTRATED CATALOGUE AND PRICE LIST. ✻

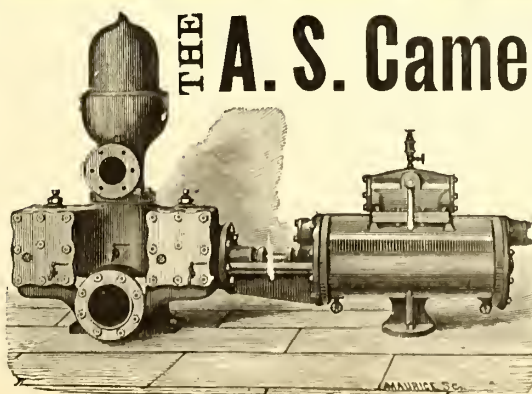

THE A. S. Cameron Steam Pump,

THE STANDARD OF EXCELLENCE.

Upward of 30,000 in Use.

BEST GAS WORKS PUMP

Ever Introduced.

Adapted to Every Possible Duty.

A.S. Cameron Steam Pump Works,

Foot East 23d St., N. Y.

J. H. GAUTIER & CO..

CORNER OF

GREENE AND ESSEX STREETS,
JERSEY CITY, N. J.

MANUFACTURERS OF

Clay Gas Retorts,
Gas House Tiles,
Fire Bricks, Etc. Etc.
Ground Clay, Fire Brick and
Fire Sand in Barrels,J. H. GAUTIER.
C. E. GREGORY.T. B. GAUTIER.
C. E. GAUTIER.**BROOKLYN**Clay Retort & Fire Brick Works,
(EDWARD D. WHITE & CO.)Manufacturers of Clay Retorts, Fire Brick,
Gas House and other Tile.VAN DYKE, ELIZABETH, RICHARDS & PARTITION STS.
Office, 88 Van Dyke St., Brooklyn, N. Y.**LACLEDE FIRE BRICK MFG. CO.,**

MANUFACTURERS OF

Fire Brick, Gas Retorts,

AND

ST. LOUIS STANDARD SEWER PIPE.

Blast Furnace and Cupola Linings, every description of Fire
Clay Material, Fire Clay Flue Linings, Chimney Tops
Dry Milled and Crude Fire Clays, etc.

OFFICE AND DEPOT

901, 903, and 905 Pine Street,
ST. LOUIS, MO.

ESTABLISHED IN 1845.

B. KREISCHER & SONS,

OFFICE FOOT OF HOUSTON ST., E. R., N. Y.

Gas Retorts,**TILES, FIRE BRICK.**

AND EVERYTHING IN THE FIRE CLAY LINE.

**MANHATTAN
FIRE BRICK & ENAMELLED CLAY
RETORT WORKS.****ADAM WEBER.**CLAY GAS RETORTS
AND RETORT SETTINGS
FIRE BRICKS, TILES, ETC.,

Office and Works, 15th Street and Avenue C., N. Y.

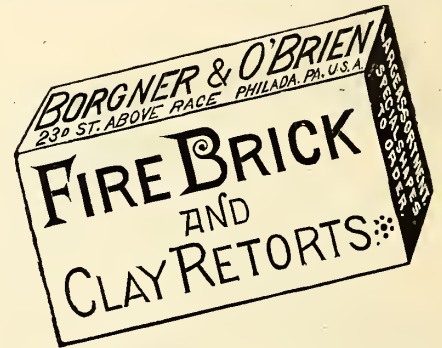

JAMES GARDNER, JR.

Works,
LOCKPORT STATION, PA.

—ESTABLISHED 1864.—

WILLIAM GARDNER & SON,

Successor to GARDNER BROTHERS.

WILLIAM GARDNER.

Office, COAL EXCHANGE,
PITTSBURGH, PA., P. O. Box 373.**Fire Clay Goods for Gas Works.**

C. H. SPRAGUE, No. 70 KILBY STREET, BOSTON, MASS., Agent for the New England States.

OFFICE, 418 to 422 East 23d St., New York.

ESTABLISHED 1856.

WORKS, PERTH AMBOY, NEW JERSEY.

HENRY MAURER,**Excelsior Fire Brick & Clay Retort Works**

CLAY GAS RETORTS, BENCH SETTINGS, FIRE BRICK, TILES, ETC.

STANDARD GAS RETORT AND FIRE BRICK COMPANY,

J. ANDERSON, Pres. & Mang'r.

OF IRONTON, OHIO.

C. PETERS, SECRETARY.

Clay Gas Retorts, Fire Brick, and Fire Clay Goods of Every Description.

Plans of Livesey-Somerville, McIlhenny, and other Furnaces, and Competent Workmen Supplied.

CHICAGO

Retort & Fire Brick Works,

OFFICE AND FACTORY,
Clark, Forty-Fifth, and La Salle Streets,
CHICAGO, ILL.

GEORGE C. HICKS, PRES. PAUL P. AUSTIN, SEC. & TREAS.

STANDARD

Clay Retorts and Settings.

BLOCKS & TILES

of every Shape and Size to Order.

Standard Fire Bricks.**CINCINNATI**

Gas Retort & Fire Brick Co.,

(ESTABLISHED 1872.)

CINCINNATI, OHIO.Manufacturers of Gas Retorts, Retort Set-
tings, Fire Brick, Tiles, Etc.**OAKHILL****GAS RETORT & FIRE BRICK**

COMPANY.

PARKER, RUSSELL & CO.

City Office, 711 Pine Street,

ST. LOUIS, MO.Our immense establishment is now employed almost entirely in
the manufacture of**MATERIALS FOR GAS COMPANIES.**We have studied and perfected three important points. Our re-
torts are made to stand changes of temperature, the strongest
heats of the furnace, and the abrasion of feeding and emptying.
Our customers are in almost every State of the Union, to all of
whom we refer.

THOS. SMITH, Presl.

AUGUST LAMBLA, Vice-Prest. & Sup

BALTIMORE**RETORT & FIRE BRICK CO.**

MANUFACTORY AT

LOCUST POINT, BALTIMORE, MD.

Connection with the City by Telephone.

Clay Retorts, Blocks & Tiles,

**FIRE BRICK, FIRE CLAY,
AND FIRE CEMENT.**Red and Buff Ornamental Tiles and Chim-
ney Tops. Drain and Sewer Pipe (from
2 to 30 inches). Baker Oven Tiles
12 x 12 x 2 and 10 x 10 x 2.

WALDO BROS., 88 WATER ST., BOSTON, MASS

Sole Agents for New England States

THE AMERICAN METER CO.,

MANUFACTORIES,

512 West Twenty-second Street, N. Y.

Arch and Twenty-second Street, Phila.

Nos. 244 & 246 North Wells Street, Chicago, Ill.

AGENCIES,

No. 177 Elm Street, Cincinnati, Ohio.

Nos. 122 & 124 Sutter Street, San Francisco Cal.

No. 810 North Second Street, St. Louis, Mo.

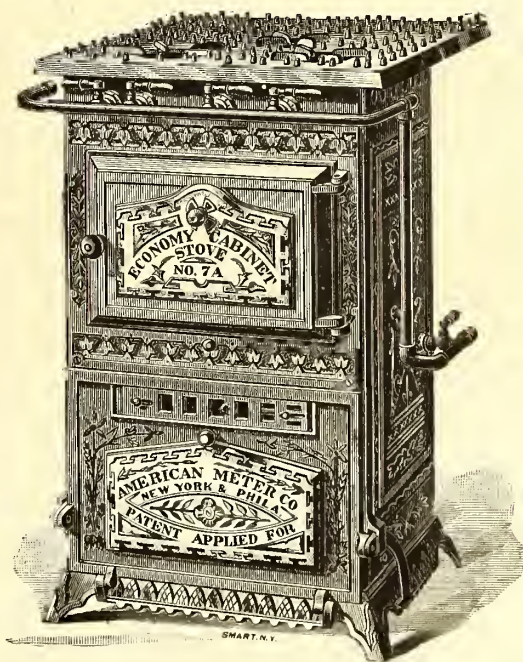

NEW DESIGN STOVES MADE IN CAST IRON, WITH EITHER OPEN OR CLOSED TOPS.

In presenting our "Economy" Gas Cooking Stoves and Ranges for the Season of 1885, we have the pleasure to inform our patrons that the increasing demand for these Stoves has encouraged us to make entirely new patterns, of HIGHLY ORNAMENTAL DESIGNS, for the popular sizes. We have also embraced the opportunity to increase the size of these Stoves, giving greater TOP PLATE AND OVEN capacity.

Full Lists and Catalogues are in preparation, and large stocks of Stoves will be kept at our Manufactories and Agencies for prompt shipment.

AMERICAN METER CO.

A. H. M'NEAL, BURLINGTON, N. J.

Flange-Pipes

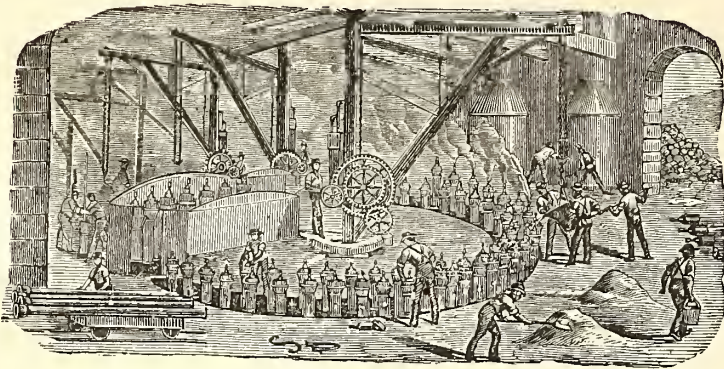

General Foundry Work.

CAST IRON PIPES FOR WATER AND GAS.

JAMES S. MOORE, Pres.
BENJAMIN CHEW, Treas.

JAS. P. MICHELLON, Sec.
WM. SEXTON, Supt.

GLOUCESTER IRON WORKS, GLOUCESTER CITY, N. J.

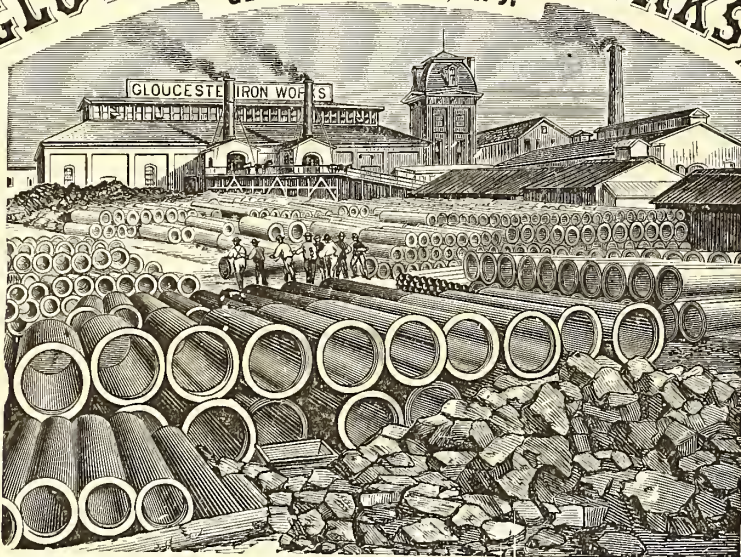

Cast Iron Gas & Water Pipes, Stop Valves, Fire Hydrants, Gasholders, &c.
Office No. 6 North Seventh Street, Philadelphia.

ESTABLISHED 1856.
WARREN FOUNDRY AND MACHINE CO.,
WORKS AT PHILLIPSBURGH, N. J.
NEW YORK OFFICE, 162 BROADWAY.

Cast Iron Water and Gas Pipe

FROM TWO TO FORTY-EIGHT INCHES DIAMETER.
ALSO ALL SIZES OF

FLANGE PIPE for Sugar House and Mine Work.
Branches, Bends, Retorts, Etc., Etc.

436-1

MATHEW ADDY, President.

W. L. DAVIS, Selling Agent.

GEO. P. WILSHIRE, Sec. & Treas.

Cincinnati and Newport Iron and Pipe Company, NEWPORT, KY.

Lamp Posts
AND
BENCH CASTINGS

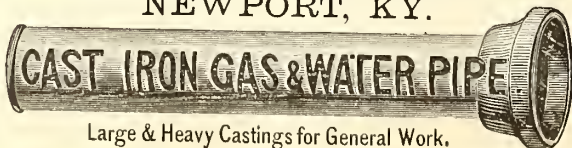

Branch
AND
SPECIAL CASTINGS

A Specialty.

Large & Heavy Castings for General Work.

FOR GAS & WATER CO'S.

Manufacture Pipe, from 2 to 48 inches. All work guaranteed first quality.

Mellert Foundry and Machine Co. Limited. Established 1848.

MANUFACTURERS OF



Specials—Flange Pipe, Valves and Hydrants,
Lamp Posts, Retorts, etc.
Machinery and castings for Furnaces, Rolling Mills, Grist and
Saw Mills, Mining Pumps, Hoists, etc.

GENERAL OFFICE, - - - READING, PA.

CAST IRON Gas and Water Pipes,

From 2 to 48 Inches in Diameter.

FOX & DRUMMOND,

160 Broadway, N. Y. City.

LUDLOW VALVE MFG. CO.



OFFICE AND WORKS,
938 to 954 River Street and 67 to 83 Vail Av.
TROY, N. Y.

Hydraulic Main Dip Regulators, also
Check Valves, Foot Valves, Yard-
wash and Fire Hydrants.
Send for Circulars.

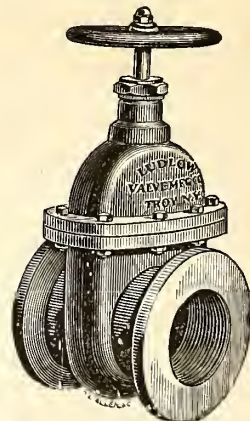

Valves.—Double and Single Gate, 1/2 in. to
48 in., outside and inside Screws. Indica-
tor, etc., for Gas, Water, Steam, and Oil.
Send for Circulars.

John McLean
Manufacturer of
GAS VALVES.
298 Monroe Street, N. Y.

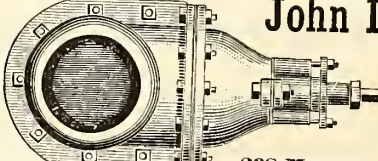

WELSH "ABERNANT"
Silica Dinas Fire Brick & Cement.
Unrivalled for Endurance Under Intense
Heat. Percentage of Silica, 95.64.

Also SCOTCH "BLOCHAIRN" FIRE BRICK.

A. T. CHUR,

SOLE AGENT FOR THE UNITED STATES,
Mills Building, Room 14, Fifth Story, New York.

Siemens's Regenerative Gas Burners, For Lighting and Ventilating.

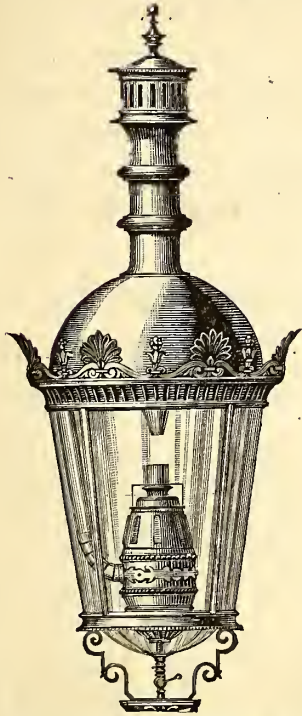

THE CHEAPEST, PUREST, AND MOST BRILLIANT OF ALL GAS LIGHTS.

Superior to the Electric Light in Economy, Beauty, & Steadiness.

SPECIALLY ADAPTED FOR LIGHTING HALLS, FACTORIES, OPEN SPACES, ETC.

Numerous Tests made by various Gas Companies in the United States show an Efficiency of Ten Candle Power per Cubic Foot of Gas.

General Agents:

- SIEMENS LIGHTING CO., 347 West Main St., Louisville, Ky.
- MEYER, MARSHALL & CO., 528 California St., San Francisco.
- DENNEHY, WOLF & O'BRIEN, 85 & 87 Dearborn St. Chicago, Ill.
- WILCOX & McGEARY, - No. 11 Bissel Block, Pittsburgh, Pa.
- T. T. RAMSDALL & CO., - 20 Swan Street, Buffalo, N. Y.
- SIEMENS GAS ILLUMINATING CO.,
Room 6, No. 157 Broadway, New York City.
- W. D. COLT, - - - - 1420 F Street, Washington, D. C.
- JOHN KIEFER, - - - 344 Lawrence, Street, Denver, Col.

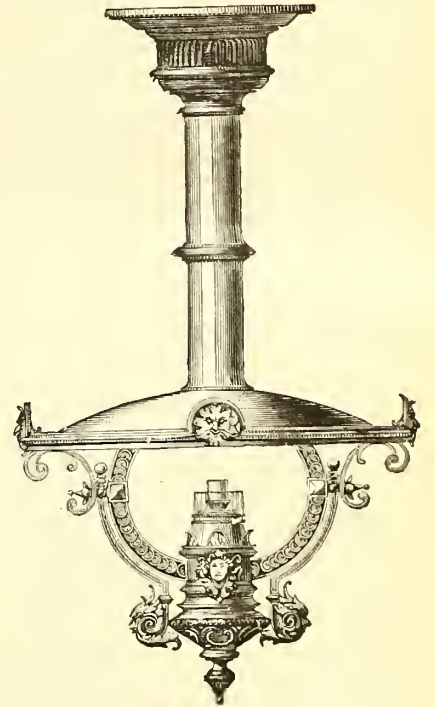

THE SIEMENS REGENERATIVE GAS LAMP COMPANY,

SOLE MAKERS FOR THE UNITED STATES,

N. E. Cor. 21st. St. and Washington Av., Philadelphia, Pa.

THE "STANDARD" WASHER-SCRUBBER,

KIRKHAM, HULETT & CHANDLER'S PATENT.

Total Capacity per 24 Hours of "Standard" Washers Ordered During the Following Years.

1877.....	4,000,000 cubic feet.
1878.....	4,750,000 "
1879.....	24,545,000 "
1880.....	42,967,500 "
1881.....	36,462,500 "
1882.....	39,300,000 "
1883.....	57,735,000 "
1884.....	26,177,500 "
Total.....	235,937,500 cubic feet.

Total Number and Capacity per 24 Hours of "Standard" Washers Erected and in Course of Erection in the Several Countries

	Number.	Cubic Feet per Day.
Great Britain..	151	157,070,000
Western Hemisphere.....	38	39,397,500
Australia.....	18	12,150,000
New Zealand.....	2	650,000
France.....	6	4,550,000
Belgium.....	8	5,420,000
Germany.....	16	8,300,000
Holland.....	4	4,100,000
Denmark.....	1	150,000
Russia.....	2	3,500,000
Spain.....	1	350,000
India.....	1	400,000
Total.....	248	235,937,500

THE CONTINUED POPULARITY

Of these Machines

Will be recognized from the following extracts from letters from representatives of some of the companies having them in use:

PROVIDENCE GAS COMPANY, }
PROVIDENCE, R. I., NOV. 24, 1884. }

GEO. SHEPARD PAGE, Esq., New York:

Dear Sir—We are now using less than a gallon of water per thousand in the "Standard," and the gas at the outlet will not color turmeric paper.

Yours, etc.,

A. B. SLATER, Treasurer.

PORTLAND GAS COMPANY, }
PORTLAND, ORE., NOV. 29, 1884. }

GEO. SHEPARD PAGE, New York:

Dear Sir—Our Scrubber appears to run to our entire satisfaction, and we are pleased to say that it takes out all the ammonia from the gas. This is very satisfactory to us, as we were ruining our meters at a fearful rate heretofore. The amount of water used is very inconsiderable as compared with our old process. The machine runs very smooth and still.

Very respectfully,

H. C. LEONARD, Secretary.

"Standard" Washers Ordered Recently.

	Cu. Ft. per Day
Anneberg Gas Co.....	200,000
Bombay Gas Co.....	400,000
Brussels Co.....	1,250,000
Chemnitz Gas Co.....	1,000,000
CITIZENS GAS CO., BUFFALO.....	750,000
Coke Works in Zabre, Ober-Schlesien.....	1,500,000
Cokereif der Friedeushutte, Upper Silesia.....	500,000
Dumfries Corporation.....	250,000
Dunedin Gas Co., New Zealand.....	400,000
GEORGETOWN, D. C.....	250,000
King's Lynn Gas Co.....	300,000
Leiden, Holland.....	600,000
Lincoln Gas Co.....	400,000
Liverpool Gas Co.....	2,000,000
" ".....	3,000,000
LOUISVILLE GAS CO.....	1,500,000
Nurea Gas Co.....	100,000
PITTSBURGH GAS CO.....	1,500,000
PAWTUCKET, R. I.....	500,000
PORTLAND GAS CO., OREGON.....	562,500
SAN FRANCISCO GAS CO.....	4,000,000
Sheepbridge.....	40,000
ST. LOUIS GAS CO.....	2,000,000
Sydney Gas Co.....	2,500,000
WASHINGTON, D. C. GAS CO.....	2,000,000
Whitechurch Gas Co.....	175,000
Total.....	26,927,500

GEO. SHEPARD PAGE, No. 69 WALL STREET, NEW YORK,

SOLE AGENT FOR THE WESTERN HEMISPHERE.

R. D. WOOD & CO.,

400 Chestnut Street, Phila., Pa.

Cast Iron Gas & Water Pipe, Water Machinery & Gas Apparatus

Cast Iron Pipe, Fire Hydrants, Eddy Valves, Lamp Posts, Large Loam Castings, Flanged Pipe, Sugar House Work, Iron Roofs and Floors, Wrought & Cast Iron Tanks, Turbine Water Wheels and Pumps.

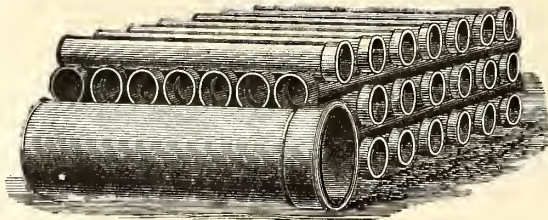

Casholders, Lime Trays, Center Valves, Purifiers, Bench Work, Exhausters, Condensers, Governors, Scrubbers, Gas Valves, Station Meters, Cast Iron Pipe Fittings.

Manufacturers of Heavy Castings and Machinery of Every Description.

ENGINEERS & CONTRACTORS FOR THE ERECTION OF GAS WORKS, & ALL MACHINERY CONNECTED THEREWITH

Estimates and specifications furnished for erection of new works or the extension or alteration of old ones.

Foundries and Works. - - Millville, Florence, and Camden, N. J.

SMITH & SAYRE MFG. COMPANY,

G. G. PORTER, Prest.

245 Broadway, N. Y. CHAS. W. ISBELL, Sec'y.

Machinery & Apparatus for Gas Works

Drawings, Plans, and Estimates Furnished for the Improvement, Extension, or Alteration of Gas Works, or for the Construction of New Works.

Mackenzie's Patent Rotary and Steam Jet Gas Exhausters, Governors, Compensators, Condensers, Washers, Scrubbers. Isbell's Patent Automatic Street Pressure Governor, Gas and Water Valves, Hydraulic Main Dip Regulator, Bench Castings, etc. Purifying Boxes and "Standard" Scrubbers. Isbell's Patent Self-Sealing Retort Doors.

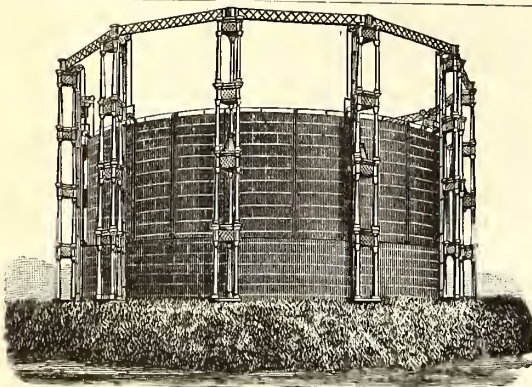
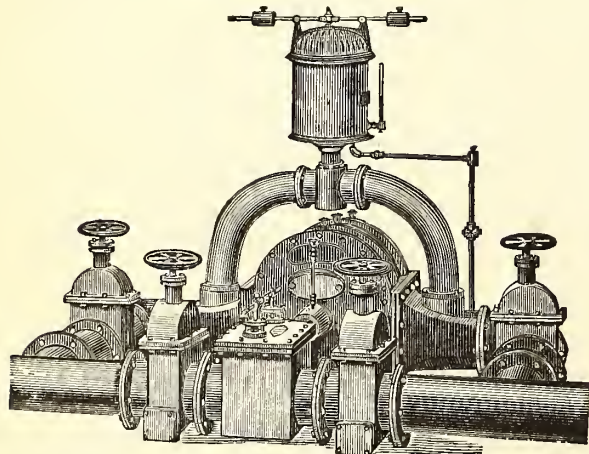

W. E. Tanner, Pres., W. R. Trigg, V.-Pres., A. Delaney, Supt.

Tanner & Delaney Engine Co. RICHMOND, VA.

Gas Apparatus,

INCLUDING

Condensers of various styles, Scrubbers, Holders, Purifiers, Castings for Retort Houses, Etc.

ALSO STEAM ENGINES AND BOILERS.
Plans, Specifications and Estimates Furnished.

MORRIS, TASKER & CO., Limited,

Builders of Gas Works,
PHILADELPHIA, PA.

To Gas Companies.

We make to order **CAP BURNERS** to burn any amount under a stated pressure. Send for samples.

Also, **SERVICE CLEANERS, DRIP PUMPS,** and **STREET MAIN PROVING APPARATUS.**

C. A. GEFROERER,
248 N. 8th Street, Phila., Pa.

SOUTHWARK FOUNDRY AND MACHINE COMPANY,

Successors to MERRICK & SONS. Established in 1836.

No. 430 Washington Avenue, Philadelphia, Pa.

MANUFACTURERS OF

Single and Telescopic Gasholders,

BENCH CASTINGS,

Washers, Scrubbers, Condensers, Purifiers,

And all apparatus necessary for the construction of improved new gas works and in the extension of established works. Also manufacturers of

Gas Engines, and of all descriptions of Steam and Hydraulic Machinery, and of Boiler and Tank Work.

Plans, specifications, and estimates furnished promptly on application.

WM. HENRY WHITE,

Consulting & Constructing

Gas Engineer & Contractor.

ESTIMATES, PLANS, AND SPECIFICATIONS FURNISHED FOR NEW WORKS OR EXTENSIONS OF EXISTING WORKS.

32 Pine St., New York City.

Correspondence solicited.

KERR MURRAY MFG. CO.,

MANUFACTURERS OF

Single Lift and Telescopic

GASHOLDERS.

Built, 1884:

Altoona, Pa.	Capacity, 160,000 cubic feet.
Pittsburgh, Pa.	" 250,000 "
"	" 220,000 "
Bellaire, Ohio.	" 50,000 "
Youngstown, Ohio.	" 60,000 "
Canton, "	" 60,000 "
Akron, "	" 80,000 "
Xenia, "	" 10,000 "
Adrian, Mich.	" 65,000 "
Ypsilanti, Mich.	" 25,000 "
Muskegon, "	" 70,000 "
South Bend, Ind.	" 70,000 "
Anderson, "	" 20,000 "
Plainfield, "	" 10,000 "
Springfield, Illinois.	" 100,000 "
Evanston, "	" 50,000 "
Freeport, "	" 35,000 "
Elgin, "	" 60,000 "
Sheboygan Wis.	" 20,000 "
Key West Fla.	" 10,000 "

Plans and estimates furnished for the erection of new and the rebuilding of old works. Address

Kerr Murray Mfg. Co.,
FORT WAYNE, IND.

JAMES R. FLOYD,
(SUCCESSOR TO HERRING & FLOYD)

Oregon Iron Works,
531 to 543 West 20th St., N. Y.

Practical Builders of Gas Works,
MANUFACTURERS OF
ALL KINDS OF CASTINGS
AND
APPARATUS FOR GAS-WORKS.

BENCH CASTINGS
from benches of one to six Retorts each.
**WASHERS: MULTITUBULAR AND
AIR CONDENSERS; CONDENSERS;
SCRUBBERS**

wet and dry), and
EXHAUSTERS
for relieving Retorts from pressure.

BENDS and BRANCHES
of all sizes and description.

**FLOYD'S PATENT
MALLEABLE RETORT LID.**

**PATENT
SELF-SEALING RETORT LIDS.**

**FARMER'S
PATENT BYE-PASS DIP-PIPE.**

**SABBATON'S PATENT
FURNACE DOOR AND FRAME.**

**BUTLER'S
COKE SCREENING SHOVELS.**

GAS GOVERNORS,

and everything connected with well regulated Gas Works at low price, and in complete order.

SELLER'S CEMENT

for stopping leaks in Retorts.

N. B.—STOP VALVES from three to thirty inches—
at very low prices.

Plans, Specifications, and Estimates furnished.

CONTINENTAL WORKS.

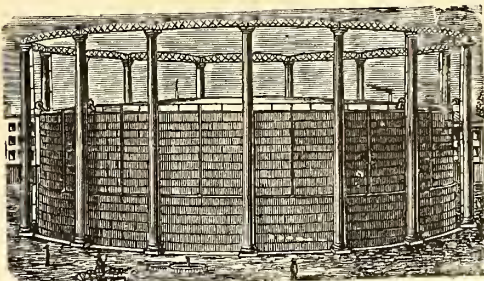

GASHOLDERS OF ANY MAGNITUDE.

T. F. ROWLAND, Proprietor,
GREENPOINT, BROOKLYN, N. Y.

ENGINEER AND MANUFACTURER OF

GAS-HOLDERS.

CONDENSERS, SCRUBBERS, VALVES,
PURIFIERS, RETORTS. and HY-
DRAULIC MAINS,

and all other articles connected with the Manufacture and Distribution of Gas. Plans and Specifications prepared and Proposals given for the necessary Plant for Lighting Cities, Towns, Mansions, and Manufactories.

H. RANSHAW, Prest. & Mangr. WM. STACEY, Vice-Pres. T. H. BIRCH, Asst. Mangr. R. J. TARVIN, Sec. & Treas.

STACEY MFG. CO.,

MANUFACTURERS OF

Single and Telescopic Gasholders,

IRON ROOFS, BRIDGES, LAMP POSTS,

**Water and Oil Tanks, Coal Elevator Cars,
COKE CRUSHERS, BENCH CASTINGS,**

And all kinds of Wrought and Cast Iron Work used in the erection of Coal and Oil Gas Works.
Rolling Mill Machinery and Heavy Castings a Specialty.

Foundry: 33, 35, 37 & 39 Mill Street. **Wrought Iron Works:** 16, 18, 20, 22, 24 & 26 Ramsey Street.

Cincinnati, Ohio.

BARTLETT, HAYWARD & CO.,

Office, 24 Light.

BALTIMORE, MD.

Works, Pratt &

PURIFIERS.

**Roofs.
Bench Castings.**

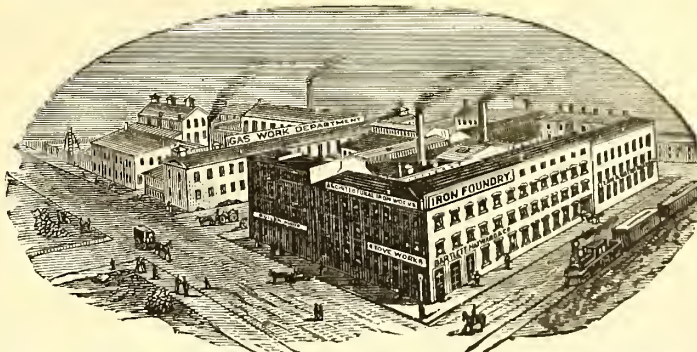

SCRUBBERS.

CONDENSERS.

GASHOLDERS.

CONSTRUCTING ENGINEERS AND BUILDERS OF GAS WORKS.

1842. **DEILY & FOWLER, 1884.**

Laurel Iron Works.

Address, No. 39 Laurel Street, Philadelphia, Pa.

MANUFACTURERS OF

GASHOLDERS,

Single or Telescopic, with Cast or Wrought Iron Guide Frames.

Holders Built Since 1880:

- | | | | | |
|--------------------------|---------------------|---------------------------|--------------------------|----------------------------------|
| Mount Joy, Pa. | West Point, N. Y. | Galveston, Texas (2d.) | Kalamazoo, Mich. (3d.) | Newport, R. I. |
| Rockaway B'ch, N.Y. (2) | Fitchburgh, Mass. | Marlboro, Mass. | Glen Island, N. Y. | Portland, Oregon. |
| Zanesville, O. (2d.) | New London, Conn. | Denver, Col. | Warren, Ohio. | Allegheny, Pa. (2d.) |
| Lancaster, O. | Derby, Conn. | Chicago, Ill. (West Side) | Bath, N. Y. | Atlanta, Ga. (2d.) |
| Blackwell's Island N. Y. | Bridgeport, Conn. | Pittsburgh, Pa. (S. Side) | Lynn, Mass. | N.Y. City (Central Ga) |
| Waltham, Mass., (1st.) | Altoona, Pa. (1st.) | Pawtucket, R. I. | New Bedford, Mass. | Lynchburg, Va. (2d.) |
| Dorchester, Mass. | St. Hyacinth, Can. | Brookline, Mass. | Waterbury, Conn. | Saylesville, R. I. |
| Wheeling, West Va. | Norwalk, O. | Sherbrooke, Can. | Deseronto, Can. | Rondout, N. Y. |
| Lansing, Mich. | Brattleboro, Vt. | Burlington, N. J. (2d.) | Hoosic Falls, N. Y. (2d) | Atlantic City, N. J. |
| Flint, Mich. | Waltham, Mass (2d.) | Bridgeton, N. J. | Bethlehem, Pa. | Augusta, Ga. |
| Galveston, Texas (1st.) | West Chester, Pa. | Bay City, Mich. | Atlanta, Ga. (1st.) | Waltham, Mass. (2 ^d) |
| Milton, Pa. | Baltimore, Md. | Erie, Pa. | Savannah, Ga. | |
| Scranton, Pa. | Hollidaysburg, Pa. | Jackson, Mich. | Montgomery, Ala | |

GAS COALS.

GAS COALS.

GAS COALS.

JAMES D. PERKINS.

PERKINS & CO.,

F. SEAVERN.

General Sales Agents for

The Youghioghenny River Coal Company's OCEAN MINE YOUGHIOGHENY GAS COAL.

The Coal from the Ocean Mine (recently operated by Messrs. W. L. Scott & Co., of Erie, Pa.,) is now used by all the leading Gas Companies in the United States from Maine to Texas, and is recognized as *the only reliable Youghioghenny Gas Coal.* (See Map on p. 87 of this Journal, Feb. 16, 1885.)

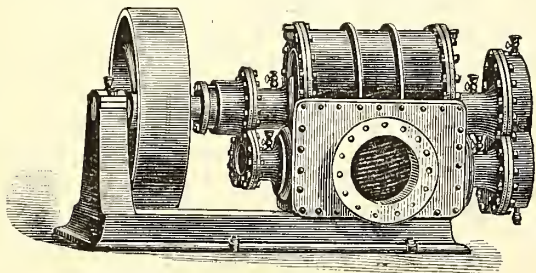
P. O. Box 3695,
New York.**PERKINS & CO., 228 and 229 N. Y. Produce Exchange**BEAVER STREET
ENTRANCE.

Gas Exhauster Driven by Belt.

The Wilbraham Gas Exhauster, "BAKER SYSTEM,"

WITH ENGINE ATTACHED, ON SAME BED PLATE OR WITHOUT.

Best, Cheapest and Most Durable Exhauster known.

WILBRAHAM BROS.,

No. 2320 Frankford Avenue, Philadelphia, Pa.

F. J. DAVIS & J. R. FARNUM,

TRUSTEES AND AGENTS FOR THE

SINUOUS FRICTION CONDENSER.

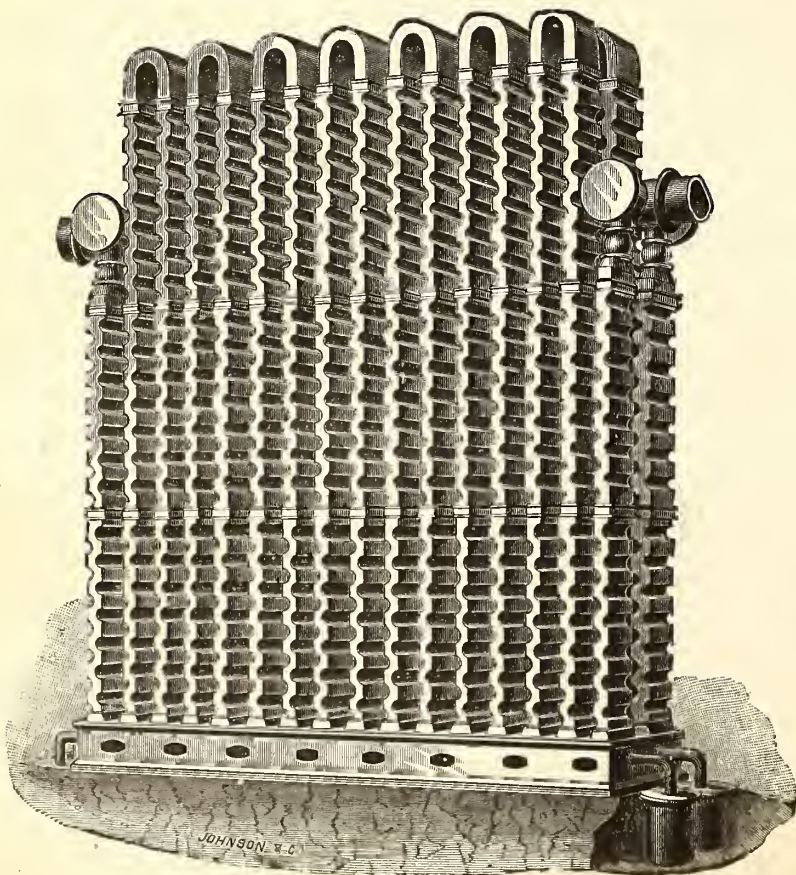

We desire to draw the attention of the gas community to the merits of the **SINUOUS FRICTION CONDENSER.** Companies intending to introduce new condensers into their works will do well to confer with us and examine plans and estimates before contracting for any other pattern. The **FRICTION CONDENSER** is now in use at the gas works located in the following places:

Portland, Me.	Brookline, Mass.	Pawtucket, R. I.	Frederickton, N. B.
Newport, R. I.	Chelsea, Mass.	Jamaica Plain, Mass.	St. John, N. B.
Gloucester, Mass.	Woburn, Mass.	Attleboro, Mass.	Paterson, N. J.
Newton & Water- town, Mass.	Peoria, Ill.	Calais, Me.	Dover, N. H.
	Clinton, Mass.	Fall River, Mass.	Waltham, Mass.
		Nassau Works, Brooklyn, N. Y.	

DAVIS & FARNUM MFG. CO.

MANUFACTURERS OF

Gas and Water Pipes,

AND

GAS AND WATER MACHINERY

OF THE MOST APPROVED PATTERN.

Also, Gasholders and Iron Roofing.

Orders from Gas and Water Companies promptly attended to.

WALTHAM, MASS.

Boston Office, Room 55, Mason Building, 70 Kilby Street.

GAS COALS.

Newburgh Orrel Coal Co.,
MINERS AND SHIPPERS OF
**Newburgh Orrel, Tyrconnell
 and Palatine Gas Coals.**

ALSO SHIPPERS OF FOUNDRY COKE.

Mines Situated at
Newburgh, Flemington & Fairmont, W.Va.

HOME OFFICE,
25 S. Gay St., Baltimore.

CHARLES MACKALL,
MANAGER.

CHAS. W. HAYS, Agent in New York,
Room 92, WASHINGTON BUILDING, No. 1 Broadway.

Shipping wharves at Locust Point. References furnished when required. Special attention given to chartering vessels.

THE DESPARD COAL COMPANY

OFFER THEIR SUPERIOR

DESPARD COAL

To Gas Light Companies and Manufacturers of Fire Clay Goods
 Throughout the Country.

ROUSSEL & HICKS, } AGENTS. { **BANGS & HORTON,**
 71 Broadway, N. Y. } { 16 Kilby St., Boston.

Mines in Harrison Co., West Va. Wharves, Locust Point, Balt.
 Company's Office, 15 German St., Baltimore, Md.

Among the consumers of Despard Coal we name: Manhattan
 Gas Light Co., N. Y.; Metropolitan Gas Light Co., N. Y.; Jersey
 City, (N. J.) Gas Light Co.; Washington (D. C.) Gas Light Co.;
 Portland (Maine) Gas Light Co. Reference to them is requested.

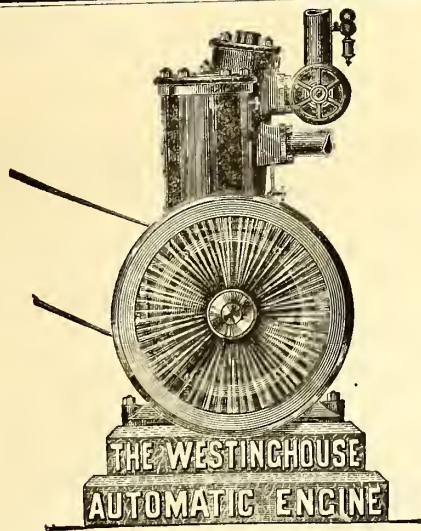

1,500 Engines Now in Use.

Our capacity being now equal to 100 Engines per
 month, we shall hereafter keep in stock for immediate
 shipment all sizes from 4 to 200 H.P.

SEND FOR ILLUSTRATED CIRCULAR AND REFERENCE LIST.

Westinghouse Machine Co.,
PITTSBURCH, PA.

SALES DEPARTMENT CONDUCTED BY

Westinghouse, Church, Kerr & Co., 17 Cortlandt
 Street, New York City.

Fairbanks, Morse & Co., Chicago, Cincinnati, Cleve-
 land, Louisville, and St. Paul.

Fairbanks & Co., St. Louis, Indianapolis, and Denver.

Parke & Lacy, San Francisco, and Portland, Or.

Parke, Lacy & Co., Salt Lake City, Utah, and Butte,
 Montana.

D. A. Tompkins & Co., Charlotte, N. C.

Keating Implement & Machine Co., Dallas, Texas

Imray & Co., Sydney and Melbourne, Australia.

Robert Middleton, Mobile, Ala.

H. Dudley Coleman, 9 Perdido St., New Orleans, La.

R. Rogers, 43 Rue Laflite, Paris.

GAS COALS.

GAS COALS,

THE

PENN GAS COAL CO.

OFFER THEIR

Coal, Carefully Screened & Prepared for Gas Purposes.

Their Property is located in the Youghiogheny Coal Basin, near Irwin and Penn Stations on the
 Pennsylvania Railroad, and on the Youghiogheny River.

Principal Office:

209 SOUTH THIRD STREET, PHILA., PA.

Points of Shipment:

Pennsylvania Railroad Piers; Greenwich Wharves, Delaware
 River; Pier No. 1 (Lower Side), South Amboy, N. J.

Chesapeake & Ohio Railway Coal Agency,

FOR THE SALE OF THE

Superior Kanawha Gas Coals, Cannelton Cannel,
Also, SPLINT AND STEAM COALS.

From the Kanawha and New River Regions, on the line of the Chesapeake & Ohio R'way.

C. B. ORCUTT, Sales Agent. | **OFFICE, 150 BROADWAY, N. Y.**

FRANCIS H. JACKSON, PRESIDENT.

EDMUND H. MCCULLOUGH, SEC. & TREAS.

THE WESTMORELAND COAL CO.

Chartered 1854.

Mines situated on the Pennsylvania and the Baltimore
 and Ohio Railroads, in Westmoreland County, Penn.

POINTS OF SHIPMENT:

PHILADELPHIA, BALTIMORE, SOUTH AMBOY, N. J.
 WATKINS (SENECA LAKE), N. Y.

Since the commencement of operations by this Company its well-known
 Coal has been largely used by the Gas Companies of New England and the
 Middle States, and its character is established as having no superior in gas-
 giving qualities, and in freedom from sulphur and other impurities.

Principal Office, 224 South 3d St., Phila., Pa.

The Bower Gas Lamp.

The Perfected Duplex-Regenerative Gas Burner, under
 the combined Patents of Anthony S. Bower,
 Geo. S. Grimston, and Thos. Thorp.

The First Gold Medal awarded at the Crystal Palace Exhibition in
 London, and two Gold Medals at the Stockport (Eng.) Exhibition of Gas
 Appliances. Both in 1883.

GEO. SHEPARD PAGE, JOHN BOWER,
 69 Wall Street, N. Y. City.

The Management of Small Gas Works.

By **C. J. R. HUMPHREYS.** Price, \$1.

A. M. CALLENDER & CO., 42 Pine St., N. Y.

INTERNATIONAL--1876--EXHIBITION.



The U. S. Centennial Commission.

HAVE DECREED AN AWARD TO

HARRIS, GRIFFIN & CO.,

Twelfth and Brown Streets, Philadelphia, Pa., No. 49 Dey Street, N. Y. City, and No. 75 North Clinton Street, Chicago, Ill.,

FOR THE FOLLOWING REASONS :

The Exhibit consists of a Series of METERS from the Largest Size Station Meters for the use of the MANUFACTURE OF GAS, to those for the use of the ORDINARY CONSUMER. The Instruments are WELL MADE, RELIABLE as to INDICATION, and embody a number of sundry improvements which, with the general character of the Exhibit, entitle the whole to commendation.

Attest—J. L. CAMPBELL,
Secretary, pro-tem.

Signed—A. T. GOSHORN,
Director General

J. B. HAWLEY,
President

CHARLES E. DICKEY.

JAMES B. SMALLWOOD.

CHARLES H. DICKEY.

Maryland Meter and Manufacturing Co.,

DICKEY, TANSLEY & CO.,

Established 1866.

Nos. 22 and 24 Saratoga Street, Baltimore, Md.
No. 46 La Salle St., Chicago, Ill.

MANUFACTURERS OF

DRY GAS METERS, STATION METERS, GLAZED METERS, TEST METERS, METER PROVERS, PRESSURE AND VACUUM REGISTERS, GOVERNORS, INDICATORS, SERVICE AND METER COCKS, AND METER CONNECTIONS.

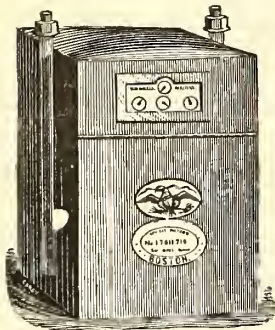

Dry Gas Meter.

With 39 years' experience and the best facilities for manufacturing, is enabled to furnish reliable work and answer orders promptly.

NATHANIEL TUFTS,

No. 153 Franklin Street, Boston, Mass.,

MANUFACTURER OF

DRY GAS METERS.

Station Meters of any Capacity.

Test and Experimental Meters, Pressure Registers, Pressure Gauges,
Pressure and Vacuum Gauges.

METER PROVERS, PHOTOMETERS, STREET LANTERNS, ETC., ETC.

Patent Cluster Lanterns for Street Illumination.

Pipe Coverings.

Fireproof, Non-Conducting Coverings for

STEAM PIPES, BOILERS, And all Hot Surfaces.

Made in sections three feet long. Easy to apply; light and cheap.

Asbestos Materials, Fibre, Braided Packing, and Cement. These goods are used at Continental Works, Br'klyn.

CHALMERS-SPENCE COMPANY, 419 & 421 EIGHTH ST., N. Y.

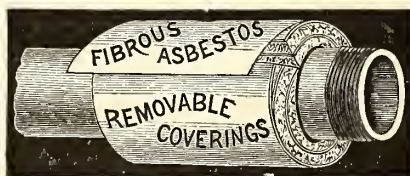

HODGE'S UNIVERSAL ANGLE UNION, Pat'd

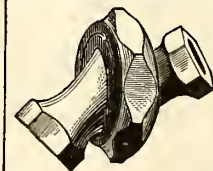

A new and important Pipe Fitting for Steam, Water, or Gas. Combining a variable angle or elbow and a union. Saves pipe, saves time, decreases friction and radiation, gives a union joint at every angle, and can be set at any angle at which it is desired to run the pipe.

HODGE'S SWIVEL FLANGE,

A common sense article, designed to save time and money.

MANUFACTURERS AND WHOLESALE AGENTS,

ROLLSTONE MACHINE CO.,
142 Water St., Fitchburg, Mass.

W. H. DOAN,

REFINER OF

NAPHTHA and GASOLINES

ALSO MANUFACTURER OF

A Special Grade of Naphtha for
Gas Companies

FOR ENRICHING COAL GAS.

Correspondence solicited.

No. 43 Euclid Avenue, Cleveland, Ohio.

Parson's Steam Blower,

FOR IMPROVING BAD DRAUGHT IN BOILERS, AND FOR BURNING BREEZE
OR OTHER WASTE MATERIAL.

PARSON'S TAR BURNER,

FOR UTILIZING COAL TAR AS FUEL.

PARSON'S AIR JET TUBE CLEANER,

FOR CLEANING BOILER TUBES.

These devices are all first-class. They will be sent to any responsible party for trial. No sale unless satisfactory. Manufactured by the WATERTOWN STEAM BLOWER COMPANY.

H. E. PARSON, Supt., 42 PINE ST., N. Y.

T. C. HOPPER, Pres. G. J. McGOURKEY, Vice-Pres. (New York). WM. N. MILSTED, Gen. Supt. & Treas. (New York). WM. H. DOWN Sec.

AMERICAN METER COMPANY,

WET AND DRY GAS METERS.
STATION METERS.
EXHAUSTER GOVERNORS.
DRY CENTRE VALVES.
GOVERNORS FOR GAS WORKS.

PRESSURE REGISTERS.
PRESSURE & VACUUM REGISTERS.
PRESSURE & VACUUM GAUGES.
CRESSON GAS REGULATORS.
MARSLAND WATER METERS.

METER PROVERS.
PORTABLE TEST METERS.
EXPERIMENTAL METERS.
AMMONIA TEST METERS.
BAR AND JET PHOTOMETERS.

Manufactories:
512 W. 22d St., N. Y.
Arch & 22d Sts., Phila.

GAS STOVES,
SUGG'S "STANDARD" ARGAND BURNERS,
SUGG'S ILLUMINATING POWER METER,
Wet Meters, with Lizar's "Invariable Measuring" Drum.

Agencies:
177 Elm Street, Cincinnati.
244 & 246 N. Wells Street, Chicago.
810 North Second Street, St. Louis.
122 & 124 Sutter St., San Francisco.

HELME & McILHENNY,

(Successors to Harris & Brother. Established 1848.)

GAS METER MANUFACTURERS,

CONTINUE AS HERETOFORE AT THE OLD ESTABLISHMENT,

Nos. 1115 and 1117 Cherry Street, Philadelphia, Pa.,

To Manufacture Wet and Dry Gas Meters, Station Meters, Experimental Meters, Meter Provers, Center Seals, Pressure Registers, GOVERNORS, INDICATORS, PHOTOMETERS, & ALL OTHER KINDS OF APPARATUS FOR USE IN GAS WORKS.

From our long practical experience of the business, and from our personal supervision of all work, we can guarantee all orders to be executed promptly, and in every respect satisfactorily.

WM. WALLACE GOODWIN, Prest. and Treas.

WM. H. MERRICK, V.-Prest.

S. L. JONES, Sec.

S. V. MERRICK, Supt.

THE GOODWIN GAS STOVE AND METER COMPANY,

Successors to W. W. GOODWIN & CO.

1012, 1014 and 1016 Filbert St., Phila., Pa. 142 Chambers St., New York.
76 Dearborn St., Chicago, Ill.

WALDO BROS., Agents, 88 Water St., Boston.

MANUFACTURERS OF THE "SUN DIAL" GAS STOVES, FOR COOKING AND HEATING PURPOSES.

Dry and Wet GAS METERS, Station Meters (Square, Cylindrical or in Staves) Glazed Meters, King's and Sugg's Experimental Meters, Lamp Post Meters, Etc., Etc., Meter Provers (sizes 2, 5 and 10 feet), Pressure Guages of all kinds, Pressure Registers, Pressure and Vacuum Registers, Pressure Indicators (sizes 4 inch, 6 inch and 9 inch), King's Pressure and Vacuum Gauges, Dry and Wet Centre Seals, Dry and Wet Govern- ernors, Exhauster Governors, Photometers of all descriptions. Lethby's Sulphur and Ammonia Test Apparatus complete—also Testing and Chemical Apparatus of all kinds, and of the most perfect description, for all purposes relating to Gas.

GOODWIN'S IMPROVED LOWE'S JET PHOTOMETER.

Agents for Bray's Patent Gas Burners and Lanterns.

Special attention to repairs of Meters, and all apparatus connected with the business.
All work guaranteed first class in every particular, and orders filled promptly.

G. B. EDWARDS, Mang'r, New York.
E. H. B. TWINING, Mang'r, Chicago.
A. B. STANNARD, Agent.

D. McDONALD & CO., GAS METER MANUFACTURERS.

(Established 1854.)

51 Lancaster St., Albany, N. Y. 34 & 36 West Monroe St., Chicago, Ill.

STATION METERS, EXPERIMENTAL METERS, METER PROVERS, PRESSURE & VACUUM REGISTERS, PRESSURE GAUGES, ETC.

Also STAR GAS STOVES, RANGES, and HEATING STOVES.

We use only the very best materials, and employ the most skilled labor, and by our long experience (29 years) and personal supervision of every detail, we feel justified in assuring the public that our goods will give perfect satisfaction. Every Meter emanating from our establishment will bear the State Inspector's BADGE, and will be fully warranted by us. Our Annual and Calendar will be sent to Gas Companies upon application.

WM. FARMER, ENGINEER,

32 Park Place, Room 36, New York.

THE CHEMIST'S ASSISTANT; OR, KINDERGARDEN SYSTEM OF CHEMISTRY.

A system by which the elements and their valences are represented by illustrations and solid bodies.
BOX AND PAMPHLET COMPLETE, \$2.50.

JOS. R. THOMAS, C.E.,

May be Consulted on all Matters Relating to Gas Works and Gas Manufacture.

ADDRESS THIS OFFICE.

The Management of Small Gas Works.

BY C. J. R. HUMPHREYS.

Price, \$1.

Orders to be sent to A. M. CALLENDER & CO.,

42 PINE STREET, NEW YORK.

THE GOODWIN GAS STOVE AND METER CO.,

1012-18 Filbert St., Phila., 142 Chambers St., N. Y., 76 Dearborn St., Chicago.

Agents, WALDO BROTHERS, 88 Water Street, Boston.

WM. W. GOODWIN, PRES. & TREAS.
W. H. MERRICK, VICE-PRES.
S. LEWIS JONES, SEC.
SAMUEL V. MERRICK, SUPT.

SOLE MANUFACTURERS OF THE

G. B. EDWARDS, Mang'r, N. Y.
E. H. B. TWINING, Mang'r, Chicago.
A. B. STANNARD, Agent.

"SUN DIAL" GAS STOVES

The Most Economical, Efficient, and Durable Gas Stove Made.

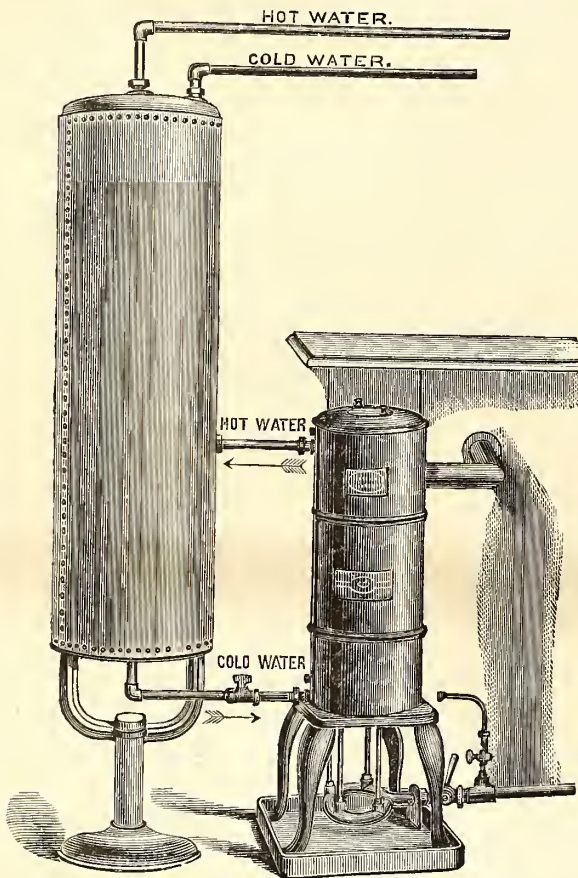

I.—Safety Hot Water Generator and Boiler.

Safety Hot Water Generator and Boiler.

Cut I. represents our Safety Gas Hot Water Generator and Boiler, arranged for home use. This most easy, quick, and economical way of preparing a warm bath, or for heating water for any domestic purpose, entirely supersedes any necessity for the use of ranges or stoves—a great comfort, particularly in hot weather. The boiler being self-filling, as the hot water is drawn off, can never become empty, thus preventing the possibility of any accident.

We beg to call attention to the cast iron pan which is now attached to the legs of the Generator (see illustration). This is to catch the drippings from the Coil, which many persons suppose come from a leak, when in fact they are produced by condensation. This condensation is caused by the hot flame coming in contact with the coil filled with cold water.

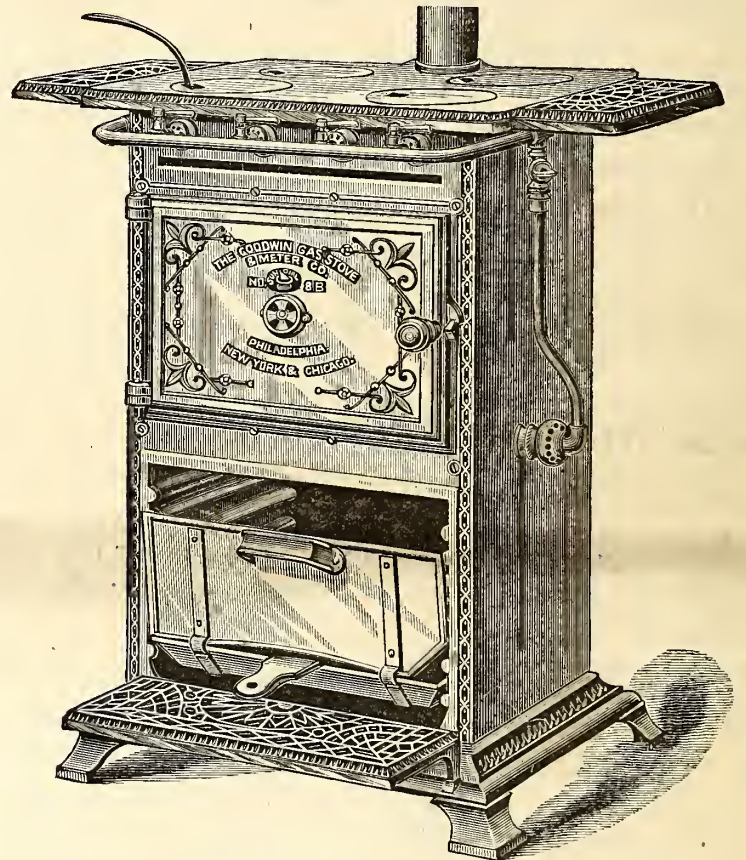

II.—Gas Cooking Stove No. 8 B.

New Style Gas Cooking Stove.

Cut II. represents our New Style Cooking Stove. As will be seen, it has an ornamented cast iron base and front, and extension shelves. The oven burner, which is atmospheric (unless otherwise ordered), is of an entirely new and improved pattern (patent applied for). The ovens are of greater capacity than those of the old style. The top, in conjunction with the outlet pipe, is designed to carry off all products of combustion; hence the outlet pipe must be connected with a flue, or the stove will not work properly.

This Stove has 4 boiling burners in top of hot plate. All fittings are nickel plated. We are making this style of Cooking Stove in the following sizes—viz., No. 7 B, No. 8 B, No. 9 B, and No. 10 B.

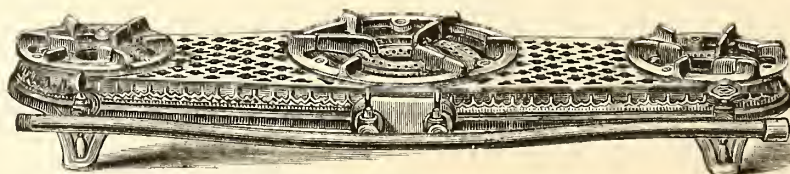

III.—Improved Hot Plate, No. 108.

New Style Hot Plates.

Cut III. represents our New Style of Hot Plates, of which we are making No. 106 (two small boiling burners), No. 107 (two medium sized boiling burners), and No. 108 (two medium and one large boiling burner). See new Catalogue and Price List for further particulars.

THE AMERICAN

GAS LIGHT JOURNAL

REDMAN & KENNY, N. Y.

PUBLISHING OFFICE NO. 42 PINE STREET

DEVOTED TO THE INTERESTS OF ILLUMINATION, VENTILATION, WATER SUPPLY AND DISTRIBUTION, & GENERAL SCIENCE.

VOLUME XLIII.—No. 2.
Whole No. 626.

NEW YORK, THURSDAY, JULY 16, 1885.

{ \$3 PER ANNUM
IN ADVANCE.

A. M. CALLENDER & CO., Proprietors. C. E. SANDERSON, Manager.
JOS. R. THOMAS, C. E., Editor.

ENTERED AT THE POST OFFICE AT NEW YORK, N. Y.,
AS SECOND CLASS MATTER.

Published on the 2d and 16th of each month, at No. 42 Pine Street, N. Y.

Terms of Subscription, Including Postage.—For the United States and Canada, \$3 per annum. European countries, \$3.50 (15 shillings—18 francs). All payments to be made in advance. Single copies, 15 cents.

Remittances should be made either by post-office order, registered letter, or bank draft on New York, payable to the order of A. M. Callender & Co.

CONTENTS.

An Asterisk (*) denotes an illustrated article.

OFFICIAL CIRCULAR—

American Gas Light Association..... 29

EDITORIALS—

Mr. McIlhenny's Experiments in the Direction of Improved Methods in Bench Firing..... 30

It is Well to Know What You are Buying..... 30

* The Thermophote, or Self-Registering Photometer..... 31

Eighth Annual Meeting of the Western Gas Association—Official Report—Continued from page 7..... 32

Stoppages in Small Gas Works, by V. L. Elbert—Discussion—The Question-Box—"Is there anyone present who can say anything about the Lowe incandescent gas burner?"—First Day, Evening Session—Question-Box Continued—"What is the yield of gas per retort, with tar as fuel as compared with coke, during the life of said retort?"—"If your town were piped with cast iron mains, laid in cement, what would you do to prevent breaks in them in winter time?"—Adjournment, First Day's Sessions.

Sixth Annual Meeting of the Central New York Gas Engineers Association—Official Report—Concluded from page 8..... 37

New Plant of the Syracuse Gas Light Company—Discussion—Dinner and Adieus.

Cooper's Coal Liming Process, by G. S. P..... 38

The Late M. Servier..... 38

Cambria Iron Company's "Crinoline" Chimneys..... 39

ITEMS OF INTEREST FROM VARIOUS LOCALITIES..... 40

Street Lighting at Detroit, Mich.—Personal—"It Served Him Right"—Natural Gas at Olean, N. Y.—Crying Aloud in Bitterness of Spirit—Glad to Know It—Mr. Monnett Responds—Certain Rumors Taking Tangible Shape—Would it not be Made Hot for Them?—Underground Wires in Brooklyn, N. Y.—Now for the New York City Commissioners—Streets Unlighted—A Mysterious Murder—Measuring the Candle Power of a Light—New Apparatus—Annual Meeting.

The Market for Gas Securities 41

[OFFICIAL CIRCULAR.]

American Gas Light Association.

OFFICE OF THE AMERICAN GAS LIGHT ASSOCIATION, }
32 PARK PLACE, NEW YORK CITY, July 13, 1885. }

The return of midsummer should remind us that the time for our annual convention is rapidly drawing near, and at the same time warn us that we must turn our thoughts toward Cincinnati if we wish to make our Thirteenth Annual Meeting a success. True, three months are ours during which all needful preparations may be made; but this period is not too much; on the contrary, every day remaining is needful, because our convocation cannot be of any value unless we have an ample supply of good papers—and essays of merit cannot be produced if their preparation be deferred to the last moment. Moreover, as I stated in my appeal to the members a year ago, papers com-

ing before a technical convention have a twofold value—firstly, that due from the information contained therein; secondly, that resulting from the discussion to which they give rise. It must also be clear that the intrinsic worth of the discussion is directly in proportion to the facts and figures presented by the speakers. A general conversation on any given branch of our business, during which mere expression of opinions are voiced, is of but scant worth when contrasted with a discussion in which the members are able to back up their remarks by abstracts from their books or by records of some experiment; and it is equally apparent that members cannot thus prepare themselves with facts and figures unless they know in advance the nature of the subjects to be discussed. Therefore, a paper to be read at our coming meeting, to be of the utmost value, must be prepared, or at least its title and general tenor must be determined upon, sufficiently in advance to permit the Secretary to transmit the information to the members ten days or so before the meeting.

As an instance of the increase in worth which attaches to a paper by reason of the publication of its title in advance, let me cite the essay read by Mr. C. H. Nettleton, at our Washington meeting, on "Testing Meters." There we had a paper of great merit, whose value was enhanced by the facts and figures given in the discussion; for the member, notebook in hand, gave to the meeting the actual results of meter testings as made by his company. Hence this paper and the discussion to which it gave rise form a most valuable addition to our knowledge of this subject. But if it had not been known in advance that a paper on this subject was to be presented, of what import would the remarks of the speakers have been if they had—speaking from memory rather than reading from the record—merely stated their general impressions of the results obtained by them?

From these considerations I am very earnest in urging on the members to turn their thoughts now, even in this hot weather, towards our autumnal meeting; and to select a theme for a paper so far in advance that I may have an opportunity to do my part by getting the members to prepare themselves for the discussions.

Though it is difficult to select a subject for an essay which is new, it is not a hard task to write something new on an old theme. The simplest matters in connection with our business present themselves differently to the various members; it is therefore but light work to present in a new phase even an old-time subject.

During the last year economy has been the watchword in the gas business more than ever before; and if, in the effort to produce cheap gas, any member has been able to make two blades of grass grow where but one grew before, let us all have the benefit of the information—provided that the combined value of the two blades at least equals the worth of the one which previously occupied the soil.

So many works have now adopted the improved furnaces, in some style or other, that surely we ought to have a most interesting discussion of this subject.

The proper relation which should exist between the size of a retort and the contained charge of coal is a theme which has but seldom been treated, and more rarely elucidated; it therefore offers an inviting opportunity for experimentation by some of our members.

The introduction of tar eliminators has made good progress of late, and it would be interesting to know if the theory held, but a few years ago, that such appliances were a preventative of naphthaline is borne out by actual results.

A man who would take for the subject of a thesis the simple words, "Cooling Gas," would indeed show some bravery, for how many members would imagine that such a title could stand at the head of an interesting paper? Yet the subject is one of great depth; for if gas is deteriorated by exposure to a very low temperature, there is possibly ground for the opinion that unnecessary lowering of the temperature of the gas by even a few degrees is harmful, and that, therefore, the degree of heat or cold to which the gas will be exposed in transit from the works to the burner should determine the degree of condensation.

In like manner through all departments of our business even the most threadbare subjects will be found, on close examination, to contain some new feature which might with advantage be made the subject of a paper for our coming meeting.

C. J. RUSSEL HUMPHREYS, Secretary.

MR. McILHENNY'S EXPERIMENTS IN THE DIRECTION OF IMPROVED METHODS IN BENCH FIRING.

While on a recent visit to the city of Washington, D. C., we had the great pleasure of meeting with that big-hearted gas man, Mr. Geo. A. McIlhenny, the President-Engineer of the Washington Gas Light Company. To say that our reception was of the right friendly and brotherly sort needs no chronicling here, and it gives us the most sincere pleasure to say that the health of our tried and trusty friend is making excellent progress. To his intimates in our common business this information will be received with joyous acclamation, for Gentleman George has been a patiently heroic sufferer; and to behold him with us once more in the full possession of his old-time sprightliness will be matter for general congratulation.

It has been and is well known that for some years past Mr. McIlhenny's attention has been largely directed to study and experiment in the line of working out the problems involved in the construction and operation of improved methods of bench firing. This investigator has met with the usual vicissitudes common to experimenters, but, with the energy characteristic of the man, partial success or seeming failure acted but as a spur to urge him on in his self-appointed task; and we may here say that his latest achievements are likely to bring him that satisfaction which accrues to one who, after long and wearisome attempt, "comes out of battle a conqueror." Knowing that a knowledge of Mr. McIlhenny's latter experiments has been waited with no small degree of expectancy, we availed ourselves of our recent visit to gather some few particulars concerning his work, and a personal inspection of the new benches in operation at the Washington plant revealed the following:

The two benches constructed on the new plan are in settings of sixes, the size of retorts being 15 in. by 26 in. by 9 feet in the clear. The first of these benches had been in operation, at the time of our visit, for a space of four months, while the second was under fire a trifle over five weeks. The furnaces are located in arches in cellar under benches, and are fed, through an opening in floor leading to furnace, with hot coke drawn from certain retorts at the time of drawing the charges. The primary air supply to furnaces is admitted through an opening in furnace door, and the quantity of air admitted is regulated by a slide that can be easily adjusted to the desired or requisite point.

The supplementary air supply is taken in at top of bench, passes up and down through flues built around the uptake flues from bench, then passes over top of bench, and down on each side of the arch about midway between front and rear of oven to the center flues. This supplementary supply is forced into a conveyer pipe, and thence into the heating flues by means of an ordinary blower; and its supply may be regulated as to quantity by an arrangement similar to that pursued in controlling the primary air supply. The gases from furnace combustion are delivered into a flue running the entire length of bench, the top of this flue being about 12 inches above floor level of retort house. The top section of this flue is provided with ports or openings for the escape or admission of the gases into the combustion chamber. These ports are about four inches square, and are divided in space between the front and rear of bench. On each side of this flue are the flues for carrying the supplementary air supply. The openings or ports out of these are about four inches by three-quarters of an inch, and are located on each side of furnace ports, thus bringing the heated air and furnace gases in immediate contact, thereby securing a most thorough combustion in the heating chamber.

From experience Mr. McIlhenny found that the ports for furnace gases as at first devised (or of the dimension mentioned above) were rather too large for the purpose. He afterwards corrected this by throttling them, and by this means obtained much better combustion and heating results. The throttling was done by sliding in bricks placed edgewise over the centers of openings, leaving their orifices of about the same size as those allotted for the supplementary air supply. Since this plan was adopted the combustion in combustion chamber is about as near perfection as it is possible to attain. We are inclined to think that a great portion of the benefit accruing from the

throttling system arises from the direction taken by the furnace gases after they impinge on the brick covering the ports. In consequence the furnace gases are thrown with greater directness and contact with the heated air—thus causing a more correct commingling of them with the air, and securing better combustion in the bench.

The furnace bars need shaking up once in 24 hours, and clinkering may be required once in 48 hours—although thus far but little clinker has been developed. The character of the heat produced is vastly different from that which one is accustomed to behold in benches worked under the old firing system. It is seemingly mild in appearance and action; but, at the same time, its intensity is vouched for by its thorough carbonization of the charges in the retorts. The heat is so uniform that it must add greatly to the life and durability of retorts and settings; and that such is the case is borne out by the benches under which the tests were made—the heats do not appear to have exerted any very destructive influence upon the materials used in their construction. There appears to be less loss from heat radiation under this system than from that of any other plan examined by us. Scarcely any indication of heat issuance from chimneys was perceptible; and this is all the more remarkable when it is noted the chimneys extend only perhaps 5 feet from top of benches. The heat is utilized in the bench, there to perform its proper function.

From Mr. McIlhenny's figures it is shown that, with four-hour charges, he carbonizes between 350 and 380 pounds of coal per retort—or from 5½ to 6 gross tons of coal per day per bench. This result is secured at an expenditure of 20 per cent. of coke product of bench. He asserts that, with the new practice, stopped stand-pipes, or pitchy accumulations in hydraulic main, are things of the past. Since the practical working of these two benches had been instituted he has had no trouble of that sort.

He is now preparing to erect a double stack on the new plan—the new construction to contain benches of sixes, as his present arches will permit of no more elaborate settings. It is his intention, in the near future, to erect a stack for the accommodation of benches of nines; and when such arrangement is a fixed fact, he claims that, judging from and being guided by results so far obtained, he will obtain a per diem yield of 100,000 cubic feet to the bench.

In conclusion we may state that we were very much impressed with and gratified at the working of the Washington system; and it was quite vigorously impressed on our mind that Mr. McIlhenny, in starting out "to see how to do it," had about accomplished his original purpose. It would seem as though he had not only discovered the correct principle and method of heating a bench, but had also been successful in attaining the desired end in a most economical manner.

It is Well to Know What You are Buying.

The latest sensations in gas and electric light circles are the incandescent gas lights of Otto Fahnehjelm and "Prof." T. S. C. Lowe. The former causes gas to impinge on a fragile magnesia comb; the latter applies water gas to a nameless metal of "his own" invention. The following is what the highest authority in the use of gases for heating and lighting (the distinguished Frederick Siemens, C.E., of London) said in an address delivered at Manchester, England, on June 9th, of this year:

"Flame destroys everything upon which it impinges—not by its heat, but by its mechanical action. Flame is a mixture of gases which are in a state of great agitation, the atoms moving with the rapidity of lightning; and as soon as this agitation is interrupted combustion ceases. Now, if a solid body were brought into such a flame the incessant action of the gaseous atoms destroyed it; and if it is continued everything becomes pulverized. This is clearly shown in the various efforts made to produce an incandescent light by means of gas. At one time water gas was much talked of as the agent; and it was considered by some to be the heating gas of the future. I do not share this view, because water gas has no power to radiate out light and heat. An attempt had been made to render it luminous by carburetting it; and also to use it for producing an incandescent light, by causing it to impinge on some solid material. In certain cases a good light had been obtained; but there was always a difficulty in maintaining the material. Lime answered very well at first, but it soon pulverized. Diamond was very hard, but would burn, whilst emery melted. Magnesia had been employed; and being a dense, hard body, which, the longer it was exposed to heat, contracted the more, it seemed the best for the purpose. But even it lasted only a week, or a fortnight at the most. For these reasons I do not think there is much chance of the ultimate success of incandescent lights."

Before gas managers or capitalists are induced to invest in these plausibly brilliant schemes, they will do well to consult the patent files of the United States, Great Britain, France and Germany. Within three years "Lewis' Platinum Incandescent," the most promising English invention, and "Clamond's Magnesia Incandescent," the much exploited French invention, have both proven failures.

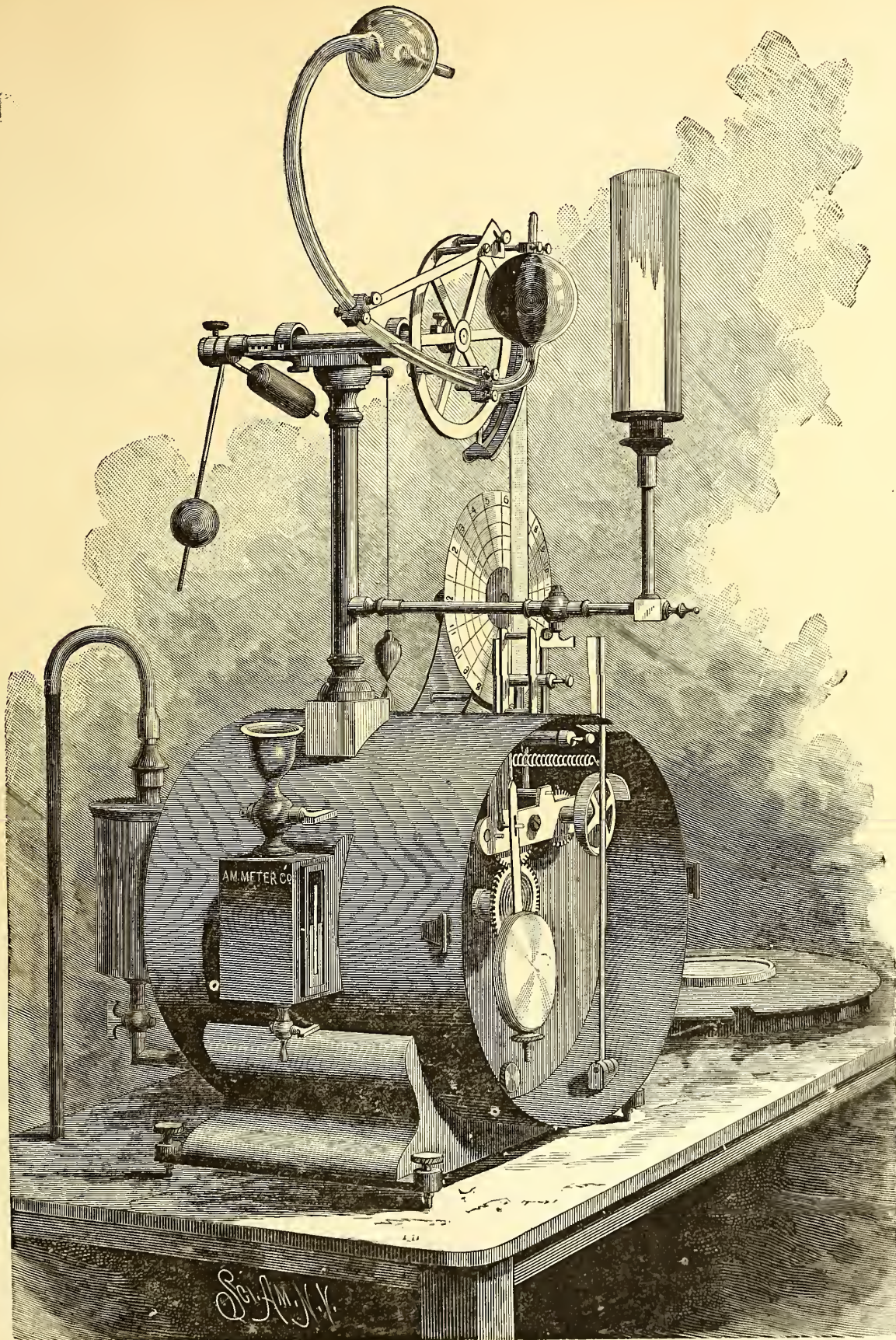

THE THERMOPHOTE, OR SELF-REGISTERING PHOTOMETER.

For years past a photometer that would do its own work, like a registering pressure gauge, has been longed for by the gas engineer. As executed in the dark room the photometric test merely discloses the illuminating power of gas at a given period; no continuous watch is kept upon the quality of the gas. The instrument shown in the cut is designed to effect this. It is the "last thing out" in photometry. It registers in an entirely automatic manner the varying illuminating power of gas, for 24 hours, upon a disc of paper. The principles upon which it is based are simple and well established. The central one is the probable identity of radiant heat and light. A flame of constant consumption is secured by the use of a regulating meter. The shaft of the meter-drum is geared into an escapement with pendulum. This, by the back pressure it creates when the drum tends to revolve too

fast. If, on the other hand, the drum revolves too slowly, the same valve opens; and thus the drum is caused to rotate at a constant speed. The connections are so arranged that the level of water inside the drum is sensibly constant; so accurate is this arrangement that the meter is made to act the part of time-keeper in revolving the indicating card once every 24 hours. Its rate is independent of the specific gravity of the gas and of pressure.

The heat radiated from the flame is received on one of the bulbs of a differential thermometer. The thermometer contains a column of mercury that occupies the bend of the tube; as the gas increases in illuminating power it causes the air in the bulb to expand, pushing out the mercury. If the illuminating power diminishes the reverse action takes place. The thermometer is delicately balanced on knife edges directly behind the center of the heated bulb. As the mercury is pushed outward it carries down the

other bulb of the thermometer, imparting a motion of rotation to the system. By means of a suspended marking apparatus the positions thus assumed are marked on the indicating card. These positions correspond to candle powers.

As it is essential to avoid friction no pencil is used; but a needle is carried in its place, which is periodically struck by a hammer that is also worked by the meter. This causes the needle to perforate the paper at short intervals, thus indicating the candle power at the given instant.

This is the first practical registering photometer ever constructed. The first 24 hours' indicating card is carefully preserved by Dr. Sloane as representing the first mechanical registry of illuminating power of gas ever produced. One incidental feature of the apparatus is its extreme simplicity. All the attention it requires is that the water level be maintained, and that the card be renewed as required. There is no clock requiring to be wound. If the water level falls too low, nothing happens except that the gas is extinguished and automatically shut off, so that even in such a case of neglect only a few hours' record of candle power is lost. The attention it requires is less than what is bestowed upon a registering pressure gauge. Its accuracy has been exhaustively tested, and on coal gas is really remarkable. To increase this accuracy an alum or distilled water cell may be added, which may prove useful for water gas, though hardly needed even for such.

It is the invention of Dr. T. O'Connor Sloane, late Engineer of the Citizens' Gas Light Company, of Brooklyn, N. Y. It is manufactured by the American Meter Company. One of the instruments is now in this city, and it is well worthy of careful examination. It is destined to prove of great value to the profession as a solution of so long pending a problem.

[OFFICIAL REPORT—Continued from page 7.]

Eighth Annual Meeting of the Western Gas Association.

HELD AT THE TREMONT HOUSE, CHICAGO, ILLS., MAY 13, 14, and 15, 1885.

FIRST DAY—AFTERNOON SESSION.

Upon conclusion of discussion on Mr. Jenkins's paper the Chairman introduced Mr. V. L. Elbert, of Jackson, Mich., who read the following paper on the subject of—

STOPPAGES IN SMALL GAS WORKS.

Mr. President and Gentlemen:—The subject upon which I write possesses one prominent quality or feature—and one not in manner conducive to the fostering of pious feelings—that of very often causing our gas superintendent to forget his prayers, and what is still worse, leading him to substitute therefor rather vigorous and emphatic language in the ventilation of his pent up wrath.

Gas works stoppages, like many another feature connected with the trade of the gas maker, are attributed, and no doubt rightly so, to a great variety of causes. Believing as I do that naphthaline is the most frequent, if not the prime source of stoppages in small gas works, it will be my object in this brief note to recount my experience with this great "choker-up;" and I might further qualify a portion of the above assertion by saying that large gas plants have good and sufficient reason to fear the naphthaline visitor. Not being familiar with the mysteries of chemistry, I am unable to go into the details or causes of naphthaline formation; but since the ill-smelling compound has every appearance of "coming to stay," it perhaps may not be long ere some professor of the subtle art will solve the complex problem for us.

Upon returning home from our last annual gathering (May, 1884) at St. Louis, Mo., and after having listened there to the recital of the "naphthaline woes" of some brother gas men, I congratulated myself heartily that my Jackson experience was not like unto that of others—although I should have known better than to indulge in such empty boastings, since a prior experience in Canada had made me intimately acquainted with the miseries of the naphthaline pest. I arrived home from the St. Louis convention about the 17th of May, and everything around the works was proceeding smoothly. This state of affairs kept right along until toward the last day or two of same month. At that time I was preparing to put a gang of pipe layers at work on street main extensions, when, almost without warning, the works were closed so tight that we could not pass a foot of gas to our holders. A hurried search revealed the seat of trouble to be located in the goose-neck over condensers. An application of steam removed the stoppage, and then I started the men (about thirty hands) at work on the street mains. Everything went along smoothly for the balance of that twenty-four hours; but at midnight I received a summons calling me down to the works, and there found that the trouble had reappeared. This time the stoppage was found in the 10-inch inlet to holder. This was bye-passed to outlet, and next morning steam was once more called to our aid, and the "way made clear." Since then we have had no particularly bad case of naphthaline stoppage at Jackson.

You will remember that previously I spoke about having had an experience with naphthaline deposit in a Canada works with which I had been connected as superintendent over a space of four years. That Canada plant had many features or points that resembled those of the Jackson works, and from this similarity I hope to establish a theory in regard to the subject in hand.

At the Canada works, during the first year of their operation, we had a regular "picnic" with naphthaline at least once every 30 days. Finally I noticed that the water supply connections to condensers were put together in such a manner that the gas was suddenly cooled and then allowed to heat up again. My theory is that such sudden changes will inevitably produce or cause naphthaline deposits.

The condenser connections were altered, and the deposit never appeared at that point again, but selected as its next stamping ground the vicinity of the center-seal. Here it would form above the water-line, and in bottom of seal, in cakes as hard as bricks. The overflow to center-seal was enlarged, enabling us to keep the seal tolerably clean; but still stoppages would occur at that place two or three times in the twelvemonth. This bothersome condition of affairs, I am told, prevails there to this day.

Now, here are two works built on nearly the same principles, designed by the same constructing engineer, and erected by the same builders—the one has but slight trouble, while the other is constantly affected, from naphthaline deposit. Why should it be so? In the endeavor to account for it I shall attempt a partial description of the machinery of each works.

Following the hydraulic main of both plants comes a steam-jet exhauster; then two tar scrubbers, composed of two vertical cylinders filled with perforated plates about three inches apart; then two condensers, consisting of two vertical cylinders fitted with boiler tubes, and arranged for thorough water circulation. All four of these cylinders are on one box base. In the Canada works from that point the gas passes into a scrubber, then underground to purifying house, some 20 feet away, then through lime purifiers.

In the Jackson works, instead of using water in condensers, after the gas passes the cylinder condenser it passes through some 300 feet of atmospheric condensers, then into scrubber, on to iron sponge purifiers, and finally reaches holder. All the apparatus—excepting, of course, the holder—are under one roof; and the gas in its passage is not required to make any underground travel. Bearing this arrangement of machinery in mind, we now come to the gas manufacturing details, which are not identical at both works.

At Canada we used Youghioghenny nut coal, without enricher of any kind. This coal came to us by boat, was dumped into wagons at unloading wharf, was hauled a mile over rough roads, and finally was shoveled into coal shed. By the time it was housed it was in a pretty fine state of division. Placing this material into a retort at bright orange heat, the resultant gas passed through a steam-jet exhauster, tar scrubbers, condensers, washer, and, by underground conduit, to purifying house—all the travel being accomplished over a route of only 40 feet—naphthaline naturally formed in the coolish and damp center-seal, and was taken therefrom, as before mentioned, in the shape of cakes about as hard as bricks. If the deposit was formed in the condensers, it then resembled fish scales.

At the Jackson works we carbonize the best quality of lump coal—size that will result from screening over 1½-inch mesh—adding about 10 per cent. of cannel; do not work under as high a heat as the orange-red; pass the gas through a steam-jet, but cool the product gradually; have used both iron sponge and lime in purification; and, except the May incident of a year ago, have never had any naphthaline bother that could really be classed as serious. Indeed, that May experience of mine with the great "rock candy" pest happened under the following circumstances.

We had had ten carloads of a certain coal sent us for trial. Instead of the shippers forwarding us the material that we ordered they sent us a rather poor quality of steam coal. Not only was it poor in quality, but it was also full of dirt; and to make matters worse we had just run out of cannel. The "dirty" steam coal was heard from in the shape of the May stoppages. We dropped the use of the steam coal for a space; then tried it again, with the result that we would "have no more of it," and rested content in the carbonization of the sort formerly used.

Putting everything together, I am satisfied that one cause—and a leading one—of naphthaline stoppages or deposits is too sudden cooling of the gas; and that "stoppages in our small gas works" may be charged to naphthaline and a too free use of "lean" coal.

Many theories have been advanced as to wet coal, dry coal, and wet and dry coal. Our coal shed sends out the former in rainy seasons, the latter in dry periods; we have used lime and iron in purification; have fed large and small doses of water to our scrubbers; the works went on well enough at all seasons, unless it so happened that we were working on a poor quality of coal.

Allow me to thank you, gentlemen, for your kind attention to this, my "maiden speech."

Discussion.

The President—I was not aware that our smaller works were having so much trouble with naphthaline. In my experience, when using Western coals, I did not know what it was. Naphthaline was a stranger to me until I began to carbonize Youghiogheny coals.

Mr. J. B. Howard—What is the name of that "dirty" steam coal that Mr. Elbert complained of?

Mr. Elbert—It was sold as "Newton's Westmoreland;" but I do not believe it was that sort of coal.

Mr. Howard—I will state that when using Brier Hill coal I did not know what naphthaline was.

Mr. J. R. Thomas—The naphthaline question appears to have become a permanent one. I suppose no other topic or feature connected with gas manufacture has received a similar amount of investigation. In the works that I formerly managed we were frequently troubled with naphthaline; invariably I found that by increasing our cannel we got rid of the pest. Its eccentricity is well known; when we did not have a sign of it in the works we would have it in our street mains. On the services to one particular stretch of pipe we had a lot of bother; at last we traced the cause to the fact that the formations occurred at the foot of a street occupied as a street railway terminus, where the pavement was kept continually wetted. We could not prevent them from wetting the pavement; but by increasing the size of the services we got over the difficulty to a great extent. In some places, and particularly in the East, where they have been greatly troubled with naphthaline, they had their hydraulic mains placed very close to the benches; and it was supposed that this style of construction had much to do with the deposit. In other cases that I have known of the dip-pipe has gone almost down to the bottom of the hydraulic main; increasing the depth of main has given great relief. My experience has been that naphthaline forms in greater abundance with a steam-jet than with a rotary exhauster; and I might add that such is the universal experience—always, of course, excepting Brother Howard's trials. The eccentricity of naphthaline appearance is its greatest peculiarity. Just previous to the time of my leaving the Williamsburgh works we had more trouble in our valve house than in any other place, and not a trace of the deposit showed in the purifiers. We have had occasions where out of three services the center one would be free and clear, while those to its right and left were solidly plugged up. Indeed, this matter of naphthaline formation appears to be "one of those things that no fellow can find out." An increase of one or two per cent. in the quantity of cannel coal that we were using would invariably free us from the pest.

Mr. R. Spencer—Speaking in reference to the use of Western coals in small gas works, I would like to inquire if any of the gentlemen here, who have exclusively used the coals of Illinois and Iowa, have ever been troubled with naphthaline? I have had a similar experience to that recounted by the President when he spoke of using Western coals; and I may say that I never saw anything like naphthaline when using such coals. The general idea seems to be (and because they are poor coals) that by using a certain percentage of cannel with the lean coal the likelihood of naphthaline formation is, to a certain extent, done away with. How can you reconcile the idea that with a very poor coal and cannel enricher you do not get naphthaline, as against the assertion that in the use of a rich Youghiogheny coal without cannel you do get naphthaline?

The President—It is one of the vagaries of experience.

Mr. Howard—In answer to Mr. Spencer's question I will state that for over ten years I have used nothing else but Illinois coals, and never knew what naphthaline was—never even saw it. I also used Youghiogheny coal and never had naphthaline. Then I have used ten per cent. of a cannel enricher and did have naphthaline.

Mr. W. H. Odiome—In Springfield, Ills., we used oxide of iron for purification, and had a steam-jet exhauster; yet we never knew what naphthaline was then. Next we carbonized Pittsburgh coal to the entire exclusion of the native coal, and our naphthaline experience commenced. We then tried a mixture of Illinois and Pittsburgh coals, (using, say, 6 per cent. of the former), and the naphthaline formations disappeared. During the summer season we use no cannel whatever, and are not troubled with naphthaline.

The President—I am glad that this phase of the question has come up. A few days ago I suggested that the experiment of mixing Youghiogheny and native coals be tried for the very purpose of determining that which Mr. Odiome has affirmed.

Mr. Odiome—I further find that the exclusive use of Pittsburgh coal causes the stand-pipes to stop up. With native coal these stoppages are of rare occurrence.

Mr. W. H. Levings—Our works at Paris, Ills., are quite small, and during the first year of their operation the only stoppages experienced were in the stand-pipes. The second year we used Youghiogheny coal exclusively, and then had naphthaline. In the first quarter of the following year we used Western Indiana coal, and did not have naphthaline. We are now using

about half Youghiogheny and half Indiana coals, with a small percentage of cannel, and naphthaline has not yet been developed.

Mr. Elbert—We have plenty of native coal almost at our doors, but we cannot use a pound of it; it would stop our works right up.

The President—Is that coal too rich?

Mr. Elbert—It possesses great richness in something or another; and what that something is I cannot tell. I do know, though, that we cannot use it.

Mr. E. H. Jenkins—It may be that in time, through an examination of the properties of the different coals, we may be better posted in regard to naphthaline formation and deposit than is the case now. I will say that at Columbus, Ga., we are using the Alabama coal, and its grade is quite similar to the native Western coals spoken of. It is a light grade of coal; but we do get plenty of naphthaline from it. I have taken three or four bushels of the pest out of one purifier; but still I think, on the other hand, that our naphthaline deposits are not altogether traceable to the coal, since I must admit that the construction of our works is such as to qualify them as a first-class naphthaline producer. My query is whether a careful analytical test of the different sorts of coals will enable us to find out what is the peculiar property of the coal that gives birth to naphthaline.

The President—During the last 20 years I have tested 75 samples of Illinois coal in the way of practical gas making, and naphthaline never made its appearance with them. I know that different works are constructed so that the circumstances vary as to manner of condensation—and this latter I think goes a long way towards forming naphthaline; but taking the ordinary small works—one operating, say, two benches—the condensing area is sufficiently large to admit of working along all right until that period in their capacity is reached where the plant has to be "driven" to supply the demand for gas. I have known of engineers making the claim that they never had naphthaline until they got to sending out twice as much gas as the plant was calculated for, or when the works were first started. I think the naphthaline difficulty is a matter of individual experience with each one, dependent upon different coals and different surroundings. This is a real good "experience meeting;" and we would like to hear from several more whom I know are using mixed coals. These are the footprints (spoken of by me this morning) that we may leave; and although there are some here who may not be inclined to talk, yet they willingly pick up these items. Now, I hope that all will express themselves freely on this subject.

Mr. J. W. Dunbar—When using a steam-jet at our New Albany (Ind.) works we were troubled with naphthaline. I once heard Mr. Somerville make a remark that I think cured the naphthaline scourge with us. It was something similar to this: He said, "Deal with gas gently, and very likely you will not have naphthaline; but deal with it *not* gently, and you are sure to have it." Prior to hearing this the gas at our works was not dealt with very gently, and so we had naphthaline; but Mr. S.'s admonition set me at work on the matter. I increased the size of our hydraulic main, and instead of running the gas through the scrubber I changed the plan so as to run through the condenser and then through the scrubber. We are now working at higher heats than ever before; but are not troubled a particle from the pest. Under the old style, out of a total of 450 consumers, we would have a dozen complaints per diem about the service pipes. Now we do not hear any of this. I think that the trouble or cause of naphthaline, more than anything else, is dealing with gas harshly. Give your gas sufficient time to cool off gradually.

Mr. John Fullagar—For the last twelve years I have heard of many cures for naphthaline. Everybody has a cure. Mr. Patterson, of London, in 1873, stated that slow condensation caused stoppages, and tried an expensive system of gradual cooling off through long lines of large conducting pipe. We never had any trouble with naphthaline, except at the holders; and we know now almost the very day that it will make its appearance. We may look for it about the 3d of November, and may expect it to remain for 15 days. Then again it will appear about the 10th day of March, when we will have, perhaps, a ten days visit; and I submit that that upsets your slow condensation theory. On one occasion we had only four benches running at our new station, while the total capacity of the plant is four millions cubic feet per 24 hours. The superintendent reported to me one day that he had a stoppage. I said it was impossible to have a stoppage while running at such a low figure; but investigation proved that the multiple condenser was completely stopped up. The gas was almost at the freezing point, and there was an evidence of the beauty of slow condensation, or rather it would show that it did not count for much as a preventer of naphthaline. Some of the brightest chemists both of England and this country have been puzzling over the matter for twelve years and have not yet found a remedy. Some of our members here will remember that, up to 1872, we never knew what naphthaline was; it never troubled us then for the simple reason that we were satisfied with a yield of 9,000 feet per ton of coal. When we carried the make up to ten and twelve thousand the trouble commenced. You will find, from the English reports, that before the government made com-

pulsory the practice of close purification English gas engineers did not know what naphthaline was. When the sulphur and ammonia restrictions were enacted the naphthaline pest showed itself. The cause of it all is, according to my view, close purification, and making too much gas from a pound of coal.

Mr. James Somerville—This subject of naphthaline is like Banquo's ghost—"it will not down," but is ever ready to shake its "gory" (or hoary) locks at us. I thought our friend Howard had put a quietus to it; but from the testimony brought out here it would seem that it is livelier than ever. The remark of friend Fullagar that with a production of 9,000 feet per ton of coal we would not have naphthaline, does not necessarily follow, and because over-production of gas is exactly the same as high heats. There are three things responsible for naphthaline production. First, poor coal; second, high heats; third, over-condensation. You can produce naphthaline under any one of those three heads, and I will ask the members which of them it is that they are doing. Our friend Jenkins may attribute his trouble to over-condensation. Six years ago, on taking charge of the Indianapolis works, this item of naphthaline was not only a cause of great expense to the company, but also of vexation to its consumers. I would not put up with that state of affairs, and I determined that the gas was not properly washed. I took the washing business into my own hands, and had a set of cocks arranged so that I could manipulate it to the point of allowing only a sufficiency of water to make contact with the gas. From that time to this I have not seen a trace of naphthaline about the works. This is an "experience" meeting, and what I have said has been my experience. I hope it may help some of you.

THE QUESTION-BOX.

Mr. J. B. Howard here assumed the chair, and said that, as the lateness of the hour would preclude the reading of another paper, he would open the question-box, so that one or two of the contained questions might be answered before adjournment. This was agreed to, and the first question was found to be—

"Is there anyone present who can say anything about the Lowe incandescent gas burner?"

Mr. Walton Clark—I received this morning a letter from a gas engineer on that very subject, in which the writer said, "I had no chance to make any investigation; I can only say it made an excellent show, and lit up the room beautifully." I had heard from this correspondent once before in reference to it. He said that the light was a beautiful one, but that he had had no means of finding out the cost of same, the durability of the burner, or the amount of gas that was being consumed in the production of the illumination.

The President—If the gentleman will allow me I will give some information received by me since my arrival in Chicago. A Mr. Loomis, who is connected with the Lowe organization, and is operating the Lowe Gas, Fuel and Heating Company, at Lynn, Mass., was in the city yesterday, and said he wanted to give me some information with regard to Lowe gas. At Dubuque, Iowa, we have the apparatus of a steam heating company, and his idea was to do away with that apparatus, substituting therefor the Lowe gas system in the attempt to furnish heat as well as light. He informed me that they had got the process in good working order, and that they could use a poor quality of bituminous coal instead of anthracite, and obtain therefrom 75,000 cubic feet of gas per ton. I asked him a question in regard to the durability of the incandescent burners. He replied that he could not exactly tell me what material was employed in their construction; but assured me that it was indestructible. He did say it was not platinum. He also stated some of the burners would give a light equal to 2,000 candle power—in fact, there was no limit to their illuminating value. I next asked him the question whether they had adjusted the burners to a lighting value of 5, 10, or 15-candle power. His reply was in the affirmative. He averred that was one of the things that had been successfully worked up. He said Mr. Lowe had been using burners varying from 5 to 20-candle power over an experimental period of four months, and that their power was not seemingly diminished at the end of that time. I mention this for what it is worth; for of my own knowledge I cannot speak.

The hour for adjournment having arrived, a recess was taken with the understanding that the Convention would reassemble at eight P.M.

FIRST DAY—EVENING SESSION.

At eight P.M. Chairman Lansden called the members to order, and said—This evening, if agreeable, we will have an experience meeting, and I think we had better keep on with a consideration of contents of question-box. The second question is—

"What is the yield of gas per retort, with tar as fuel as compared with coke, during the life of said retort?"

Here is a practical question for those of you who have had experience in

the burning of tar, as compared with the burning of coke, under your retorts.

Mr. E. J. King—I am considerably interested in that matter, and it is one that I want information in regard to. At one time I asked Mr. Fullagar about tar burners, and his reply was, "I can only answer that by asking whether you take the amount of gas that the retort yields when under coke or tar fires. A retort will make more gas with tar, because of the higher heat; but then it will not last as long as when fired with coke." I would like to hear the question freely discussed.

Mr. E. McMillin—As this is to be an experience meeting, I am, perhaps, out of order. I doubt very much if you get as great a gas production, in the lifetime of a retort, when firing with tar as fuel compared with coke. If you could run at uniformly high heats with tar fuel, provided also that the retort would stand for a twelvemonth, then possibly you might equal the yield secured under a 15-months' run with coke. It is a most difficult thing to secure a steady feed of tar to the fire. At one time the feed is too great; at another period it is too small. The great draft incurred through the large openings that allow the air to pass in around the tar burner in such excessive quantities is destructive to outer shell of retort—the cold air strikes its surface, and cools it off in the contact at one moment, while almost immediately the retort is again at a high heat. That constant changing of temperature would cause the burning out of a retort before it could be made to produce as many feet of gas as would be obtained with a coke fire. I have burned tar for a good many years, and up to the time we put in our regenerator furnaces I thought it paid to follow the practice. On the whole, if I were not using the improved furnaces I would still burn our tar; and for the reason that tar with us is probably worth \$1.50 per barrel, while we can get ten cents per bushel for our coke.

The President—Do you think \$1.50 per barrel for tar, and ten cents per bushel for coke, is the proper comparison to make in estimating the fuel value?

Mr. McMillin—I am only speaking from memory; but I think that was the basis on which I figured it.

Prof. S. H. Douglas—During the last four or five years I have burned up about all the tar that was produced in the works. We do not get enough in quantity to fire a bench continually, and from that intermittent sort of working I could not offer a positive answer to the question proposed. I may say that I find no difficulty in keeping up a perfectly uniform and very intense heat; but, however, I do not allow any considerable passage or entrance of atmospheric air into the bench. When using tar I bank the ashpan in front of the furnace in the attempt to preclude the too free admittance of air. I cannot say that a tar fire is more destructive to a retort than one generated from coke—provided, of course, that due care is exercised. Tar produces an intense heat; and if the man in charge of the burner permits too free a feed, then the retorts will suffer. I have inquired into the subject of the money value of tar fuel with some exactness. Formerly we sold our tar at such price as we could get, and latterly all gas men have learned that the tar market is a very doubtful quantity. The small lot that we now dispose of is sold at \$5 per barrel. I calculate that, with coke at 12½ cents per bushel, a barrel of the tar has a fuel value equal to \$4 worth of the coke. We experience no difficulty in disposing of our coke; but we did have considerable difficulty in disposing of our tar. Now we burn all the tar that we cannot sell at the rate of \$5 per barrel. Tar makes a very excellent fire, and my experience goes to show that the fire is an even one. Certainly it requires experience and care in operating, and an inexperienced man might allow the retorts to be materially damaged through failure in the observance of common-sense precaution. There is one thing that we do escape in running tar fires—the walls of the fire pit are not injured by clinkering; and while you may lose a trifle in the life of a retort, on the other hand, you gain in decreased wear and tear of firebrick. After our first year of burning tar I made an estimate as to what gain had accrued, and I found that, under a single bench, we had made a net profit of about \$500. That is, we sold \$500 worth more of coke and tar than we did in the corresponding months of the previous year, or when we were using coke exclusively. As near as I can give it that has been my experience in the use of tar.

Mr. J. M. Starr—Do you have grate bars?

Prof. Douglas—Yes; we put ash and breeze on top of the bars; then close up the front with ashes under the grate bars so as to exclude the air. We place on top of the breeze a little of the ash that comes from the adjoining retorts, simply to keep a mass of compact material for containing the tar. I consider it a very important point to close out the current of atmospheric air. The opening through which the tar is burned is about four inches square. Of course it is burned in connection with steam.

A Member—About what is the life of a retort?

Prof. Douglas—I answered that question when I said that, inasmuch as we do not burn tar constantly under any bench, I could not state precisely. Possibly the life of the retort may be shortened; but of that I am not altogether certain when the contingency of careful operating is remembered. On one occasion the man in charge allowed a too great tar feed, and the re-

sult was an injury occurred to upper retort from overheating. What I have detailed has been the result of five years' experience.

A Member—How long do your retorts last?

Prof. Douglas—From 3 to 3½ years.

A Member—What quantity of tar do you use in 24 hours?

Prof. Douglas—About 100 gallons to a bench of threes. I thought that, as long as we could sell coke at 12½ cents per bushel, and could get something less than \$5 per barrel for the tar, we had better burn the latter.

The President—I am afraid some of the tar men will inquire into the cost of freight up your way in the attempt to ship you some from the smaller works in this section of the country. Tar has been a drug in a great many of our markets.

Prof. Douglas—We make it net us \$5; when we cannot get that we burn it.

Mr. James Somerville—Suppose you wanted to sell it all; could you then get \$5?

Prof. Douglas—No; under those circumstances we might get \$1.75 per barrel.

Mr. Jenkins—Do you estimate that a barrel of tar is equal to 40 bushels of coke?

Prof. Douglas—Yes, sir; about that.

Mr. Jenkins—I have had some experience in the use of tar as fuel, and the figure as to relative value I finally decided upon was that one barrel of tar equaled 20 bushels of coke. I thereupon made as a rule that where tar was worth \$2 per barrel, and coke was worth less than 10 cents per bushel, it would be better to burn the coke and sell the tar. When tar was worth \$2 per barrel, and coke could be sold for ten cents per bushel, I thought it better to reverse the proceeding.

Prof. Douglas—My impression is that we used more than 20 bushels of coke per bench—I should put our figure at between 30 and 40 bushels.

Mr. Jenkins—We have had no trouble in the heating of our furnaces with tar. I do not consider there is any more wear and tear on a bench when using tar than when using coke. In the very matter of clinking alone—with tar quite a saving in the lifetime of the bench is effected.

Mr. J. B. Howard—I have burned a good deal of tar; and my experience goes to show that the best time to use it is toward the last year of the duration or lifetime of the bench. When the furnace is enlarged through wearing away, I find that the yield of gas is increased by operating tar fires. I can get stronger heats with tar. I follow the same method as that pursued by Prof. Douglas. I close up the ashpan; but I allow a larger opening for the air space than he does—about six inches square. I do not use as much tar as he does. I think my maximum limit is about 80 gallons, with about 5 bushels of coke or breeze, per day. I find no difficulty in keeping up a steady heat. At one time I had difficulty in keeping the tar flowing all the time. It was in the winter season, and the cold air rushing through when doors were opened would affect the supply pipe to such an extent that the tar would chill and its flow would cease. I remedied that by running a steampipe on tar pipe leading to burner; and whenever, through chilling, the flow became deficient, turning on steam would immediately reduce the tar to the proper consistency. To me there is no question that you can get up a great deal stronger heat with tar than with coke. I never fire up a new bench with tar heat, since I do not believe that the duration of a retort would be as great were it initially fired with tar instead of coke.

Prof. Douglas—Perhaps I ought to state one fact in connection with the use of tar as fuel, and perhaps it may also have occurred to others. The tar from condensers is worthless (or nearly so) as a fuel. We use only that which is taken direct from the hydraulic main.

Mr. Howard—That is my case.

Mr. Starr—It is said that "one man's meat is another man's poison." I have been burning tar for about 12 years, and instead of closing the front of the furnace, and thus excluding the air, I leave it open. I do not use any breeze on the grate bars, but drop the tar right down to the bottom. When I tried the breeze plan I could always notice flame and smoke issuing from chimney top; but the very moment I tried the other system the chimney gave no more evidence of that great waste. In fact, I may say that if I had a regenerator furnace the chimney could not show to better advantage. I use from 75 to 80 gallons, and get splendid heats. I think you need plenty of air supply for the proper combustion of tar fuel. Now, as to the lifetime of the retort: I had two benches built with the idea of using tar as the fuel to heat them with, and did so because, owing to their situation, I could not put in regenerator furnaces. These benches last as long as the coke-heated ones. I got the idea from Mr. Light, of Dayton, Ohio, who has met with great success in the employment of tar fuel. I keep the tar limpid in this way. I put in a two-inch pipe, and through that run an inch pipe—steam is fed to the larger pipe, and the tar flows through the smaller one. Of course, that plan keeps the tar in a fluid state. The opening that Mr. Light burns his tar through is not larger than the sixteenth of an inch—perhaps

even less than that. Perhaps I may not have been successful in that direction because my tar is not clean enough.

A Member—Perhaps Mr. Light uses a strainer.

Mr. Starr—I use a strainer, but still have trouble. Mr. Light uses no breeze. Our tar benches last for three, and even four, years.

The President—Do you inject it in with steam?

Mr. Starr—Yes; with a Watertown blower.

Prof. Douglas—The principle followed by you in burning tar is very different from ours. We depend upon the decomposition of steam to furnish oxygen for the combustion of the tar—closing out the atmospheric air.

Mr. Starr—You use a steam blower?

Prof. Douglas—Yes. The tar is carried out of opening inside a ring-jet of steam, and passes into the bench as spray. An intensely white flame fills the bench.

Mr. Starr—Do you have flame coming out of chimney top?

Prof. Douglas—Yes; at night the chimney might emit a flame two feet in height. It depends somewhat upon the manipulation of the valve. If the man in charge is careless the chimney top will show it.

Mr. Harry E. Clarke—We used tar in heating benches at Kansas City, Mo., a few years ago, but used it rather differently to that here spoken of. We injected it with steam—atomizing it. We carried it down through an inch pipe from under the stack to the bench, injecting it with what is known as the Carroll injector. The heats were always quite uniform. I do not see any reason for supposing that the life of a retort will be shortened from using tar as fuel. The care of the jet was left to the foreman of the retort house; and it was but rarely you could perceive smoke issuing from the chimney. I closed up the ashpit, and employed neither dust nor breeze. Air was admitted from front of bench through an aperture fitted with a damper, so that the air supply could be regulated at will. I am now burning the tar from oil gas (injecting it under the boiler) with great success. This tar is considerably lighter than coal tar.

Mr. G. A. Hyde, Jr.—I have had some experience in tar burning, and my trouble has been that after a few months' of running the supply source clogs up. I have tried various sorts of valves; have heated the tar; have injected it under pressure; and have blown it in in every way; but the valves will stop. If there is any way of preventing this bother I would like to know of it.

Mr. Howard—I use a tar burner as an injector. It is made out of 1½-inch pipe through which the steam passes. There is no trouble in keeping the supply steady provided you use a proper cock instead of a valve. By using a cock with an oblong opening the supply cannot be regulated as well as can be done with one having a round hole. The cock (it is the ordinary steam engine cylinder cock) that supplies our tar burner is right close to the burner itself, and has a quarter-inch opening. There is no trouble in regulating it.

Mr. Hyde, Jr.—I did not try the cock arrangement; but I did use a quarter-inch valve, and was not successful. I afterwards tried a small throttle valve, but that would also clog up.

Prof. Douglas—I use a slide-valve with knife edges so as to get rid of all friction. With such a valve I have no difficulty in regulating the tar flow.

Mr. J. H. Woodmansee—I have had some experience in tar burning at the Danville (Ills.) works, and the main trouble I had was in the matter of getting a proper supply. At last I threw away all valve work with small openings, and put in an ordinary three-quarter street cock. My retort house foreman now regulates it, and seems to have no trouble at all. It turns easily. The tar will clog occasionally; but that, I think, is on account of dirt that may have fallen into the tank or lodged in the cock, and is easily remedied. I had no trouble in burning it out. I like the action of tar fuel very much.

The President—For about two years I burned tar under 16 benches, and had the same trouble. I took an ordinary cock and drilled an inch round hole in it; then I got eight-inch diameter (or the ordinary small mesh domestic flour) sieves, and hung them as strainers over the tank where the siphon from the hydraulic main entered. The sieves required cleaning about once a week. Tar was worth 35 cents per barrel when I commenced burning it; afterwards we were offered \$1.50 per barrel for it, and then we went back to coke.

The President—The next question is—

"If your town were piped with cast iron mains, laid in cement, what would you do to prevent breaks in them in winter time?"

A Member—There is nothing you could do.

Mr. Starr—I would take it up and lay it with lead.

Mr. Hyde—Suppose the pipes broke with leaden joints; what would you do then?

Mr. Starr—I should lay them properly. If you put pipe down in gravel, or in soft, spongy soil, a foundation should be put in. I once laid pipe right through a swamp, and was obliged to put a bridge foundation under each

length, filling it in with gravel and cement on the side. It has not settled in the least. It is covered with water to a distance of a quarter mile of its length, and there has been neither condensation nor leakage. Plenty of pipe work is done in this manner. The trench is dug six inches deeper than necessary, and then a quantity of dirt to make the coffin pit is thrown in. Miles of pipe have been laid in that way. Dig the ditch to the proper depth and then bring it to a level. I have hauled many a load of gravel, put it alongside of the pipe and tamped it under, so that the bearing shall be even all along its line.

Mr. Hyde, Sr.—I submit that the question does not refer to improperly laid foundation, but rather to the remedying of contraction.

Mr. Starr—I do not allude to drawing out. I think that pipes seldom break from contraction; these breaks are the result of foundations giving way. I had pipe broken last year that was laid over a tract where the ground was soft. I think sufficient allowance should be made for the contraction of each joint. The groove in front of the bell takes the length there, and it will not pull out. Before that groove was placed in the mouth of the bell the lead would pull out. The groove prevents this, for if the pipe contracts it will draw up on the portion that is behind it. I think the breaking of pipe is the result of poor foundations.

Mr. Jenkins—If your pipe were laid at a depth of but three feet, and the frost went down below that, would it not pull apart? This last winter I received two letters from Cedar Rapids, Iowa, stating that two breaks had occurred on the mains there. At that place I know, as a rule, frost sinks some 18 inches below their mains. The breaks spoken of were on Main street, and that pipe had been down a long while. I am confident that the Cedar Rapids fractures were the result of simple pulling apart.

Mr. Starr—Of course, fractures may occur from that cause; but I have never yet had any such trouble. I have recently put down pipe at a depth of 3½ feet.

Mr. Hyde, Jr.—I would put pipe down out of way of frost, even if I had to bury it 10 feet.

The President—This question has probably been asked by some superintendent who has charge of a works the main system of which was originally laid with cement joints. There are quite a number of such cases in the Western country.

Mr. Somerville—I would suggest that expansion joints be put in—provided the old cement joints are sound and good.

Mr. Starr—What distance apart would you place these joints?

Mr. Somerville—That would be a question of situation.

Mr. Woodmansee—An expansion joint would take up the expansion of what length of main? How far apart should they be located?

Mr. Somerville—I would say about one to each quarter of a mile.

A Member—About four years ago we laid some pipe, and tried both lead and cement joints. Two years ago we put in pipes with all lead joints. The past winter frost penetrated very deep, and we had much trouble from main leakage; and it was particularly bad on the mains laid in all lead joints. The pipe has the groove spoken of by Mr. Starr; but notwithstanding all that the lead was pulled half an inch out of the bell. The pipe laid in cement joints was perfectly sound. Such is my experience. The pipe was laid beneath a covering of four feet, and the frosts of the past winter went to a depth of five feet.

Mr. Odiorne—At Springfield, Ills., we have about 20 miles of main—12 of it being in cement and the balance in lead. All the old pipe was originally laid in lead; but for the last 15 years the practice has been to use cement. We find that more breakages occur on the lines laid in lead than on those laid in cement.

A member—Are they laid at about the same depth?

Mr. Odiorne—We try to place the pipe out of the way of frost, or at a depth of about three feet. That is our rule.

Mr. McMillin—To me it seems possible to prevent the breaking of pipes laid in cement, provided they are laid where frost will not reach them. Pipes are usually put down in the warm season, and are often laid in the trenches when the temperature is at 70° to 90°, and covered over with earth. By midnight they are already beginning to leak, because of pulling out or shortening up. I do not see that the expansion joint suggested by Mr. Somerville would answer, unless there was one between every cross pipe. If you had cross pipes every 300 feet, and the expansion joints were a fourth of a mile away, the case would not be met. The cross pipes would prevent carrying off the expansion to the expansion joint. On ten, fifteen, or twenty miles of main, if one will stop to think of the difference between the temperatures he will find that several feet of main must find a place somewhere; and as the cement joints will not give the pipe must go. The argument used that the joints were pulled out seems to me to be a good one.

Mr. Odiorne—Five years ago this summer we laid three miles of 6-inch mains, and reinforced our small mains extending out in all directions from the city. On that three miles of main we have not had a single breakage.

Mr. McMillin—You were below frost?

Mr. Odiorne—Yes, I think so.

Mr. Starr—In placing pipes I put them in the trenches, but do not cover them up in the heat of the day. At nightfall I test them, and early next morning replace the soil. I try to have them cooled out before they are covered.

Mr. L. K. Scofield—This matter of pipe laying is of interest to me. I had been out of the gas business for several years, but finally drifting back to it, I had occasion last year to put down a goodly length of mains, in sizes of 6 and 8 inch. The pipe was carefully laid, and the packing of each joint was cautiously watched. When the work was finished my foreman "guessed we had one section of pipe that would not leak." After 1½ months had passed we had a rather suspicious rise in our output, and the meters failed to record that our consumers were responsible for the increase. We quickly ascertained that our gas was passing out through almost every joint of the newly laid pipe. We had put in pipe that was heavily coated with oil and pitch; this coating had dissolved, and the joints leaked like sieves.

The President—What quantity of lead did you use in proportion to the packing?

Mr. Scofield—I cannot tell that; but we were not at all chary of it.

A Member—Did the coating extend to the bell and spigot?

Mr. Scofield—Yes.

Mr. Hyde, Sr.—We had some experience of that kind, and at the Washington meeting of the American Association I presented a paper on that very subject; in which I called the attention of the fraternity to what I regarded as very important information. This is a matter which every gas man ought to know of. Never put down a piece of pipe that has a speck of tar in the spigot end.

Mr. Scofield—It was through reading Mr. Hyde's paper that my superintendent concluded our difficulty arose from a similar circumstance. I would like to ask Mr. Hyde if this pipe can be released and made tight?

Mr. Hyde, Sr.—I do not know as to that.

The President—I would like to ask Mr. Hyde upon what he places his dependence for the making of a tight joint—the packing or the lead?

Mr. Hyde, Sr.—We drive the packing up tight, and afterward drive the lead home. I suppose that a joint can be made almost tight with packing alone; but I would not care to trust it.

Mr. Spencer—I have no suggestion to make to Mr. Scofield in regard to repairs; but as a future practice I would suggest that he try cement.

Mr. Baxter—About two years ago I put some cement joints in a 4-inch pipe. It was late in the fall, and, frost and snow coming early that season, we finished up the balance of the main in lead joints. Next spring we had considerable leakage. In our examination we found that the majority of the lead joints were leaking; on the other hand the cement joints were perfectly tight. I use the Rosendale cement.

Mr. Somerville—How did you make the cement joints?

Mr. Baxter—I drove in packing, filled in with cement flush to the bell, tested the joints, and then put a slight packing around the outside of the bell. I have done that for thirteen or fourteen years.

Mr. Spencer—In reply to the argument between our President and Mr. Hyde, I think the soundness of a joint, whether of cement or lead, depends pretty much upon the style of packing pursued. I know of one strange instance that happened on a line of small pipe in our town. We were overhauling pipe that had been in the ground some six or seven years, and found in one case that a slight escape of gas followed the insertion of the probe. In digging we uncovered a joint that was bare of either lead or cement. There was nothing in it but ordinary packing yarn; and the leak was so slight that a match would not cause it to burn. It would flash a trifle.

Mr. H. T. Gerould—At Mendota, Ills., we put in some of that tarred pipe, using cement joints, and our leakage was excessive.

Mr. Hyde—The joints were made of cement?

Mr. Gerould—Yes, sir.

The President—Are your pipes out of the reach of the frosts of winter?

Mr. Gerould—No; frost with us goes down from 5 to 7 feet, and the pipe is laid at a depth of 3½ feet.

A Member—How do you make your joints?

Mr. Gerould—We make them of cement, and use jute packing.

A Member—What proportion of sand do you use in the cement?

Mr. Gerould—None; we use pure cement. We put in a good jute packing, solidly driven up, then add a second packing, and afterward put on the bell.

Mr. Spencer—At Burlington, Iowa, we favor the cement joint, and I follow the plan pursued by Mr. Gerould.

At this point the Association, on motion of Mr. E. McMillin, adjourned to reconvene at 10 A.M. of the following day—Thursday, May 12.

[To be continued.]

DURING the six months ended June 30, the Labor Bureau at Castle Garden found employment for no less than 8,615 persons.

[OFFICIAL REPORT.—Concluded from page 8.]

Sixth Annual Meeting of the Central New York Gas Engineers Association.

HELD AT SYRACUSE, N. Y., THURSDAY, MAY 21, 1885.

In response to the Chairman's invitation, Mr. A. C. Wood gave the following interesting particulars regarding the

NEW PLANT OF THE SYRACUSE GAS LIGHT COMPANY.

Gentlemen of the Association;—The new erections, as you have seen, have made an extensive addition to our plant as it formerly existed, and it may interest you to hear something regarding the details of the new construction, particularly as these embrace some novel features, and which, I think, without any appearance of self-laudation, I may claim will not be found in many other gas works of this country.

Although we do not claim any extraordinary results from the novel construction of buildings, or disposition of apparatus; yet from our experience with these special appliances, as previously shown in our old works during the past four or five years, we were satisfied to duplicate them in the new, and without material change, except in the direction of increasing their capacity. The practical benefits we have derived from their use have been a freedom from "stopped stand-pipes," almost an entire absence of stoppage of connecting pipes from naphthaline deposit—and the results obtained from the distillation of the coal in quantity and quality of gas made, and amount of enricher used, will compare most favorably with results obtained in other gas works. In view of this we were content to "let well enough alone," and duplicate our old apparatus. The wisdom of this course is apparent from our experience in their workings for the past five and a half months. These have been most satisfactory.

Retort House and Appliances.—In the erection of the new plant we desired to introduce all modern appliances that were of utility; and being satisfied with our own scrubbing and washing apparatus, we turned our attention to an investigation of the different regenerative furnaces in use, and this investigation resulted in our adoption of the "Stedman-Stanley furnace" system. In the construction of a retort house of the desired capacity, adapted to its use, and to carry out our plans for the handling of hot coke from the retorts, we erected a building 63 ft. by 72 ft. 6 in. inside the walls, and 32 ft. in height from ground to wall plate, with firing floor 10 ft. above the ground line. The house to contain two stacks of seven benches of six retorts each—the benches being 7 ft. 6 in. by 9 ft. 4 in., and the retorts 14 in. by 26 in. by 9 ft. inside. The building is covered with a steel-trussed roof and Bangor slate, with the usual ventilation at the apex, and is provided with iron stairs to second story. The building of these benches in single stacks, instead of in double ranges with the retorts back to back, is out of the usual order of things. My reason for this is that in small works (or even up to the contemplated future capacity of this plant—say 1,500,000 cubic feet per day) we can handle the single stacks to better advantage. With the minimum summer make all the gas can be made in, say, seven benches; with a double range you would usually work the benches through and through, thus leaving a portion of the range idle, and wearing it out unequally. With the single stacks we can run from end to end until the retorts are used up, when the bench can be let down, a new setting put in, the stand, bridge, dip pipes, and hydraulic main cleaned out; the result being that after every new setting of retorts is made you start up the bench the same as if it were entirely new. Of course, in large works a double range can be treated in this way. The mouthpieces are of the same size as the retorts, thus facilitating drawing the charges. The stand, bridge, and dip pipes are all 7 in. diameter. The hydraulic main is of wrought iron, provided with a pocket or chamber on the rear side for facilitating the removal of any tar or pitch that may accumulate. This removal can be effected without any stoppage to the making of gas. The main is supported on adjustable chains resting on brackets thrown out from the front buckstaves, thus enabling the main to be adjusted and kept level. A row of iron framed window sashes are placed in the walls of the building directly in rear of and over each stack of benches, giving all the light and ventilation required for the performance of any work necessary to be done on top of the stack.

Each stand-pipe is furnished with a water supply—the water being siphoned into the pipe as has before been described to you, and which we find of great efficacy in relieving us from stopped stand-pipes.

Working the Stedman-Stanley Furnaces.—The operation of working these benches is as follows: All the coke required for the fires is drawn, from the two lower retorts in each bench, directly into the furnaces. As the coke in the other retorts is drawn out it falls through an opening in floor into a car placed below to receive it. The coal is elevated to the charging floor by means of a hydraulic lift of simple construction, and one-half of the retorts in each bench are charged every two hours. The fires are cleaned from the lower floor once every four hours, or previous to each alternate charge. The grate bars are shaken up and the ashes thoroughly shaken out;

but little, if any, coke is shaken out with the ashes. Once in four to six weeks the fires are clinkered, when the grate bars are drawn and the furnace cleaned out. We find but little hard clinker, most of it being so soft, or rather that it falls to pieces from slight blows of the clinkering bar; and but little, if indeed any, clinker adheres to the sides of the furnace. That which does adhere is easily detached. After five and one-half months' use the furnaces seem to be in as good condition as when originally started.

We can easily make from 56,000 to 60,000 feet of gas per day in these benches, in accordance with the demands made upon us for gas, condition of the retorts, etc.; and this result is accomplished with a fuel consumption of 25 per cent. of the coke made.

As to the construction and operation of these furnaces I will refer you to the several statements regarding them made by Mr. Stedman at the meetings of the New England Gas Engineers, and the American Gas Light Association, which you will find in the published proceedings of those bodies, as also in the columns of the AMERICAN GAS LIGHT JOURNAL.

The Coke Conveyor—This apparatus is constructed as follows: An H iron beam is fastened to the under side of the upper floor beams in front of the benches, and parallel with them, extending the whole length of the retort house, and into the yard a sufficient distance to accommodate the storage of the coke. In the yard the beam is supported on iron columns and cross beams properly braced. The wheels of a carriage run on the lower flange of the H beam, and from the carriage is suspended the car, which is of a capacity to receive the coke from six retorts. The coke, on being drawn from the retorts, falls directly into the car, and when loaded is run out into the yard, there dumped and quenched. One man attends to the fires inside, and one to the coke in the yard; those two men also operate the coke conveyor.

Separator and Friction Scrubber.—The gas is taken off at both ends of the hydraulic main and conveyed through a 16-inch wrought iron pipe to the separator and friction scrubber, which are placed in a suitable annex to the retort house.

The separator is a wrought iron tank, 4 ft. by 4 ft. by 6 ft., and receives all the contents of the hydraulic main. It is so constructed as to separate the heavy tar (which passes off to the tar tank in the yard) from the lighter hydrocarbon oils, ammoniacal liquors, etc., which, together with the gas, flow into and through the friction scrubber.

You are, of course, familiar with the construction of this friction scrubber. It is of the same style as that formerly used in our old works for several years, and which we have found to be very effective. To its use we attribute our almost entire exemption from naphthaline troubles. From the absorption by the gas of the hydrocarbon vapors in the oils, condensed during its long passage through the scrubber, we find that it adds largely to the illuminating power of the gas. Before putting this scrubber into our old works we used 10 to 12 per cent. of cannel coal to bring our gas up to 20 candles. Since using the scrubber we maintain the same candle power with the use of but 2½ to 6 per cent. of cannel. The connections to the new scrubbers are 16 in., and the gas way through them is of the same capacity; as a consequence we get no back pressure from them. The gas is discharged from the scrubber into a 20-in. main, where it joins the gas made in the old retort house, and thence it passes (under ground) to the exhauster building. There being no back pressure from the scrubber the exhauster is practically at the end of hydraulic main.

Connections.—A 20-in. main extends right through the works, taking off from it 16-in. connections for exhauster, multitubular condenser, tower scrubber, station meter, etc., leaving 16-in. blanks on the branches for the purpose of duplicating these several pieces of apparatus whenever the demand for gas may require such action.

Exhauster.—The exhauster is a Mackenzie rotary, driven by a vertical engine built in this city for the purpose, and is most complete in all its parts.

Condensers and Scrubbers.—The multitubular condenser is of the usual type, with one of Isbell's automatic water valves attached. The tower scrubbers are of our own construction, and are quite effective.

They consist of four towers of cast iron boxes, each tower being made up of 17 boxes, which are 2 ft. deep by 2½ ft. by 5 ft. in size. The boxes being flanged and put together with bolts, makes the total height of each tower 34 ft. For the internal arrangement there are a series of wooden trays, placed one over the other, leaving a space of 8 inches between them. The trays being 4 ft. 4 in. long, or 8 in. shorter than the inside of the box, and placed in the towers so that the short end of the trays are alternately at opposite ends of the box. The gas entering at the bottom of the first tower, flows along through the space below the bottom of the lower tray until it arrives at end of that tray, where it ascends into passage between the lower and next tray above—flowing along that space in opposite direction, and thus continues alternately flowing to the right and left between the trays, and passing up at alternate ends to next space above until the gas arrives at the top of the tower, from which it is conducted through a pipe to the bottom of the second tower. The gas here ascends in the same manner, and so

passes through the remaining towers. Ammoniacal liquor and fresh water is introduced at top of tower, and the trays are so constructed as to hold a half inch depth of liquor or water, which overflows at the short end of tray, dripping from the upper tray to the next one below, and so continuing to the bottom of tower, from which it flows through connecting pipes to the liquor tank. The gas, as it passes over the liquor held in the trays, and through the drippage at the ends, gives up its ammonia, leaving it quite free from that ingredient, and yielding a strong liquor. In three of the four towers we wash with the liquors that have condensed from the balance of the works, together with that from the fourth tower, into which fresh water has been introduced. By using one-half gallon of water to each thousand feet of gas made we get a 12 to 15 ounce liquor, and a gas showing scarce a trace of ammonia. Tanks for water and liquor are provided in the attic over the tower scrubbers, both for them and the multitubular condenser. For the latter the water is pumped from one of the holder tanks into the tank in attic, from thence into the condenser in desired quantities. The water being pumped from the holder tank 18 inches below the surface, is of evenly cold temperature at all times. From the condenser it flows back to, and is discharged on, the surface of the water in holder tank—thus a constant current of warm water running into tank assists largely in keeping the seal water free from ice. From the tower scrubbers the gas is conveyed to our old purifying house, which we still have in use, and from thence sent on to the station meters and holders.

Station Meters, etc.—Two station meters are provided, one (of 1,000,000 cubic feet daily capacity) purchased last year, the other (of 500,000 cubic feet daily capacity) has been in use for a few years. These are placed side by side, with their fronts in engine room, while their bodies and connections are in the next or condensing room. The meters were so placed that the engineer could at all times "have an eye" to the gauges without leaving the room. In the engine room we also propose to erect an annunciator, which will be joined with every connection to the different apparatus throughout the works, thus instantly locating a stoppage and attracting the engineers attention to same.

The boiler house is provided with two horizontal flue boilers, either of sufficient capacity to drive the exhauster at the maximum make of gas; also to furnish all necessary steam for heat, and pumping liquor, water, etc., about the works.

The shop is provided with a steam engine for the forges, drills, lathes, etc. This engine can also be used as an auxiliary for driving the exhauster in case of need—a line of shafting being run to exhauster room for that purpose. The shop is also provided with all tools and machines for effecting necessary repairs required about the plant.

There are storerooms for supplies and materials. In the second story, over the exhauster room, is a private office for the superintendent; also draughting, experimental, and photometer rooms. The cellar under exhauster and condensers is 11 ft. in the clear, thus securing head room under connecting pipes, also light and ventilation. Wall lights are so placed that all parts of the works can be inspected in the night time.

Conclusion.—We have erected this plant with an estimated capacity to manufacture and supply 750,000 cubic feet of gas daily; and have arranged the buildings and connections so as to double that amount. This can be accomplished by duplicating the present new retort house and appurtenances, together with duplication of exhauster, condenser, tower scrubbers, station meters (as arranged for in the present buildings), and a new purifying house and purifiers. This will enable us to make at least 1,500,000 cubic feet daily. When we shall require to meet that send-out of gas our apparatus will be so arranged that we will not be obliged to run our summer make of gas through an apparatus of double the required capacity. So far as I am concerned there are no patents on these appliances nor their arrangement; and if any one of you should be desirous of adopting either the whole or any part thereof you are welcome so to do. We certainly have obtained most satisfactory results from their use.

Discussion.

Mr. Harbison—You state that it requires about 25 per cent. of the coke made for fuel supply to the furnaces. Does not Mr. Stedman claim to run his with, say, 22½ per cent. of the coke made? And can you not obtain equally as good results?

Mr. Wood—Yes; without doubt, under the same conditions that Mr. Stedman operates his benches in the handling of coke, etc. The surplus coke, as it is drawn from our retorts, falls some 8 or ten feet into the car below, and as a result of that fall it is somewhat broken up. Perhaps you noticed that the coke pile in the yard contained no large pieces, as is the case when it is drawn from the retorts in the ordinary way. It is of more uniform size, and is in better merchantable condition. Being of smaller size, it will not measure quite as many bushels as that which Mr. Stedman claims for his surplus. Again, there is more or less breeze left on the ground where the coke is dumped from the car. This breeze we use under our boilers, and in my

statement was not taken into account. The 75 per cent. of surplus coke is that in merchantable shape for sale and use. I presume this will account for the difference of, say, 2½ per cent. that you have spoken of.

Mr. Harbison—I have no doubt this accounts for the difference.

The President—Is there any other member of the Association who desires to ask Mr. Wood any questions?

Mr. Hequembourg—I think, with the inspection of the works and listening to the paper read by Mr. Wood, that we have an understanding of the matter; and I move a vote of thanks be tendered him. (Carried.)

The question-box was then opened, and a profitable hour was occupied in a discussion of its contents. When the last query had been answered, on motion, a hearty vote of thanks was given Mr. Wood for his hospitality and kindly attention to the wants of the Society and its guests.

On motion, the Association adjourned subject to the call of Chairman and Secretary.

DINNER AND ADIEUS.

After adjournment of business session the party proceeded to the Globe Hotel, where an elegant dinner awaited them. The substantial demolished, Mr. Wood, acting as toastmaster, spurred on the flow of wit and merriment; and his efforts were ably seconded by the members and their guests. When the festivities terminated and the hour for parting had arrived, all concurred in the view that the Sixth Annual Meeting of the Central New York Gas Engineers Association had been about the most successful one in its history; and this fact has nerved its members to continue on in the good work, so that the records of 1886 will even eclipse those of its predecessors.

Cooper's Coal-Liming Process.

By G. S. P.

This process has now been in continuous operation at the Tunbridge Wells (England) gas works for a period of nineteen months. The make of gas at this plant is about 120,000,000 cubic feet per annum. Practically all the work of purification has been done through a single purifier. At the end of thirteen months the purifier was opened and emptied, one-half of the oxide being at once returned to the trays (the object being to allow greater space for its expansion), and the other half was placed in store for future use. The quantity or weight of oxide originally placed in purifier box was 30 tons, and that weight, as noted above, was reduced to 15 tons. The cost of purification material is placed at \$15 for a period of nineteen months. The nuisance formerly caused by the opening of purifier boxes is now wholly avoided, and the atmosphere in the vicinity of the works is not affected in the slightest degree. Recent experience, it is claimed, has shown that with coal containing about twice the usual quantity of sulphur the sulphur compounds will be increased proportionally, and the simple remedy of increasing the percentage of lime used in the charges to retorts has been found effectual in reducing the impurity to about 12 grains per hundred cubic feet. The production of ammonia has been increased by over 30 per cent., which increase nearly compensates for the reduced market value of that product. The calorific value of the coke is greater than that produced from unlimed coal; and this fact has increased the demand for it as a fuel, while it has also reduced the fuel weight required in the carbonization of the charges. As neither preparation nor outlay of any sort is needed for the introduction of this process, immediate relief could be obtained in small works, or where the purifying boxes are not equal to present requirements, without the expense of further addition to the plant.

The Late M. Servier.

The *Journal of Gas Lighting* for June 9th contains the following statement containing the life and work of that justly celebrated French engineer and editor—M. Edouard Servier:

Our readers will remember that in the *Journal* for the 26th ult. we briefly announced the death of M. Edouard Servier, Editor of the *Journal des Usines a Gaz*, which sad event took place on the 16th ult., as the result of a long and painful disease. We have just received the following particulars in regard to the life and work of the deceased (from the pen of his colleagues, MM. Jordan and Mounier), which appear in the current number of the above-named journal. These two gentlemen were intimate friends of M. Servier for a period of thirty years, having been fellow-students with him at the Ecole Centrale, while later in life they found themselves working in the same direction—all three being engaged in the gas industry. In 1877, when several members of the Société Technique decided to start the *Journal* (which commences its ninth year of existence with marks of mourning), MM. Jourdan and Monnier accepted with M. Servier the mission of forming the administration of the modest Society by whom it is published; his part of the work being, however, necessarily the more important, since he was

charged with the editing and general management of the paper. His *colleagues* remark that it is not for them, nor is the present the time, to refer to his success in the career of technical journalism in which he had embarked. The readers of our contemporary have, they say, been able themselves to appreciate the value of the productions from his pen—at once learned and brilliant; but the duty devolves upon them to express the gratitude of those by whom the *Journal* has been issued for the distinguished and disinterested services rendered to it by their late friend. The desire to be useful to his colleagues in the industry in which he was engaged was the single motive by which he was actuated, as the satisfaction of having been of service to them was the only remuneration which he desired for his work. The *Journal* was not for him, any more than for its founders and proprietors, an undertaking which was intended to be a source of pecuniary gain. Until the last moment M. Servier fulfilled his editorial functions; and in the number for the 5th ult. appeared the last article written by him—viz., that on the gigantic tower project of M. Bourdais, which showed that his intelligence was still quick and his animation unaffected.

On Monday, the 18th ult., a large assemblage of relatives, friends, and colleagues followed Edouard Servier to his last resting place. The Paris Gas Company were represented by MM. Camus and Godot, Director and Sub-Director of the Company, M. Arson, Engineer-in-Chief, and many of their engineers and officials. A large number of directors and managers of provincial and foreign gas companies were also present. The Committee of the Société Technique, and many gentlemen connected with the manufacture of gas and of the appliances used therein, joined in the long cortege, which proceeded first to the Temple de l'Oratoire, where M. le Pasteur Vignié (who presided at the religious ceremony) recalled in touching language the principal traits of the character and career of him around whose remains they were assembled. At the cemetery of the Père-Lachaise, where the interment took place, M. Eugene Breittmayer, President of the Société Technique, delivered the following address:

"It is in the name of the Société Technique de l'Industrie du Gaz en France, of which Edouard Servier was one of the founders and also one of the Presidents, that I am about to address a few parting words to the friend whom we have just accompanied to his last resting place. Servier was a child of Paris. After having passed through a course of severe study he entered, at the age of 20, the Ecole Centrale, which has given to France so many distinguished engineers and eminent men. There he was a prominent pupil, and left the school in 1855 with a first diploma of 'engineur chimiste.' He subsequently entered into the service of the Paris Gas Company, where during twelve years, under the supervision of that eminent engineer M. de Gayffier, and under the immediate orders of M. Arson, he studied and acquired a knowledge of all the details of the important industry of gas supply, not only in regard to the construction, but the management of gas works. Notwithstanding his occupations he found time to translate and write a commentary upon the great work of the English engineer Clegg, and of the still more important one of the German savant Dr. Schilling—two works of the highest value, which were absolutely wanting in France, and which every engineer and manager of gas works should have constantly upon his table. When Servier left the Paris Gas Company he started, on his own account, as consulting engineer, and was entrusted with the construction and management of several works. Afterward, in 1869, he undertook the direction of the Metz Gas Works, and this position he held for seven years. He was at Metz during the siege, and took service in the artillery as a volunteer, employing himself energetically, in company with other engineers, in the manufacture of projectiles, in the hope of making a long defence. Returning to Paris after the war, he resumed his professional duties as consulting engineer, and became the adviser of several gas companies and financial establishments in regard to the conduct of their works. In 1874, having recognized, with a certain number of colleagues in the gas industry, the utility as well as the necessity of studies made in common, he became one of the founders of the Société Technique, of which he was President in 1878. In the previous year he undertook, in association with a few friends, the publication of the *Journal des Usines à Gaz*, which was intended to be the organ of the Société Technique. In 1878 he was a very active member of the juries of the exhibition held in Paris in that year, and later he was appointed on those of the exhibitions of Rouen and Amsterdam. An indefatigable worker, Edouard Servier had reached an important and honored position in the gas industry when a terrible malady struck him in the vigor of life and in the full possession of his talents.

"But, besides the engineer, there was the man—loyal and benevolent—whom we all knew. I still see him with his cheerful countenance, his intelligent eye, and his bright smile, as he gave one a cordial shake of the hand. He was quick to discern the weak sides of men and things, and always expressed his views in telling and humorous language (for he had a great fund of humor—in fact, enough and to spare); but he was never malicious, and I never heard him speak ill of anyone. It will be a consolation—at least it will alleviate the grief of his family and those belonging to him to know

what unanimous regrets and what an excellent souvenir he leaves behind him."

MM. Jordan and Monnier conclude their brief notice of the late M. Servier by remarking that they will not add anything to M. Breittmayer's words, as they intend to publish, in an early number of the *Journal*, an obituary notice of the life and labors of their deceased friend.

Cambria Iron Company's "Crinoline" Chimneys.

The American Society of Civil Engineers has been discussing, to some extent, the design and construction of chimneys. Mr. Geo. Webb, of the Cambria Iron Company, of Johnston, Pa., gave the following particulars in regard to the "crinoline" chimneys of that company:

The chimneys are connected to the boiler house by underground brick conduits, and are intended as "uptakes" for the unused gases. The surplus gases are used for generating steam, and but little is left after passing under the boilers. Sometimes the fires under the boilers must be reinforced with raw coal, in which case the chimneys convey some smoke. The ground is bad, and hence there is a deep foundation of masonry below the surface. From the entrance of the conduit to about 8 feet above the surface the base of the chimney is hexagonal, of hammered stone, surmounted by a cut stone coping. Six 3-inch anchor bolts are built into this base, and provided with suitable nuts to hold down a base plate 4 inches thick, and with an upward projecting rim 6 inches high around a circle 12 feet in diameter. From this base-plate it is 140 feet to the top of chimney. At the top is a molded cast iron plate similar to the base-plate, with the rim projecting downward, 10 feet 2 inches in diameter. The batter, therefore, is 22 inches in 140 feet. Between these two plates the "crinoline" is constructed. It consists of 16 vertical lines of ordinary wrought iron railroad rails, 4-inch base, with the base outward, surrounded by 45 hoops. The rails may be in sections of any length which will allow of the splice being riveted to a hoop, care being taken to avoid having more than one rail splice on the same hoop. Well-selected old iron rails with good bases, or sound sections of No. 2 or No. 3 rails, are as good as any.

The hoops are of wrought iron rolled from iron $\frac{3}{4}$ -inch thick. Each hoop is in two pieces, bent cold to a true segment in a wedge-adjusting bending machine, which allows any desired delicacy of touch. The piece lies on edge while being bent, the "former" being more readily tried in that way. If bent hot the curve cannot be maintained while cooling. The two halves of each hoop are spliced on the inside with flat plates, secured with four rivets and one bolt in each end of each section, care being taken that at least three hoops shall intervene solid before another hoop splice is made between the same verticals. There are 45 hoops, the bottom one being near the base-plate projection, and therefore about 12 feet in diameter. The distance in the clear from this hoop to the next one above is 22 inches. The clear distance between each pair of hoops gradually increases from the bottom to the top, the distance in the clear between the top hoop and the next below being 54 inches. Each hoop is riveted to each rail with two rivets—one in the upper flat space of the hoop, and the other on the other flange of the rail in the lower flat space of the hoop.

The iron skeleton thus made is so stable that no scaffolding is used in construction. Two boards across a lower ring will hold a portable forge. A rail section is hauled up, put in place, adjusted and riveted; then others in the same way. The center opening of the chimney is 8 feet, which is preserved throughout. The bricks fill from this center opening to the inner side of the hoops, special bricks being molded to fit around the rail heads, and thus save time and waste of cutting. To save cutting bricks the masons carried the inside parallel with the outer batter, and when the inside got to 8 feet in the clear they set back on the inside to an even brick, and then followed the outer batter until the inner diameter reached 8 feet again, and so on. There are about 1,000 bricks average to 1 foot in height of stack. Five bricklayers and nine laborers lined the first chimney built in 21 days; the next in 18½ days. They used no scaffolding but two scantlings and a few boards on the inside at convenient intervals, thus leaving a well-hole open the entire height. These were removed from the top downward after completion. A light iron ladder is riveted to, say, every 3d hoop the entire height. The convenience of this for construction, examination and repairs, if needed is obvious.

The strength of this chimney is in the "crinoline." The bricks are merely for inclosure of the gases. Their mass is so small and their walls so thin that they are never hot. The "crinoline" of the first chimney was built the entire height before the brickwork was begun. Some heavy storms occurred while it stood thus, and it never wavered.

WILLIAMSPORT, (PA.) CAPITALISTS have invested \$100,000 in the establishment of a central incandescent lighting station on the Edison system. They started in with the Edison meter, but abandoned it after a short trial.

ITEMS OF INTEREST FROM VARIOUS LOCALITIES.

STREET LIGHTING AT DETROIT, MICH.—The Detroit Gas Light Company, in response to invitation extended by city authorities for proposals for maintenance of street lighting, as also illumination of public buildings, for a period of one year, offered to supply gas to city gas lamps in the number of 2,000, and maintain and light 1,782 naphtha lanterns, at a gross total cost of \$40,000 for the twelvemonth. The company also offered to supply gas in public buildings, markets, etc., at the figure of \$1.50 per thousand. The Brush Electric Light Company agreed to supply light from 90 towers (359 lights), 23 single arcs, and light public buildings and markets with gas (so our information goes) at a total annual cost of \$89,300. It seems surprising, to say the least of it, that an electric lighting company should agree to furnish gas after all we have heard about the superiority of electricity, etc. It would not be such a wonderful thing, after all, if it did turn out that Detroit finally decided upon "doing away with the towers." The difference in the cost of electricity over gas is certainly very great, and the Wolverines know by this time, from their practical experience of the past year, that arc street lighting is at once a "delusion and snare."

PERSONAL.—Mr. W. E. Seip, formerly in charge as superintendent of the Eau Claire (Wis.) Gas Light Company's plant, has removed to Bloomington, Ills., where he will have direction over gas affairs. About the first move made by Mr. Seip at Bloomington was to start up the old coal gas system, in order that the water gas works might be made the subject of extensive repairs, which they sadly needed. When Mr. Gridley was alive things went on smoothly at Bloomington; but Mr. Gridley was a firm believer in the sterling value of a good article of coal gas. We hope Mr. Seip will succeed in "taking the tangle" out of the Bloomington situation. He is a clever and "plucky" member of the fraternity, and we wish him all prosperity in his new field of labor.

"IT SERVED HIM RIGHT."—A correspondent writes as follows: "Mr. Editor:—In JOURNAL for July 2d a portion of Mr. E. J. King's remarks, when discussing the subject matter of Mr. G. A. Hyde's paper 'On the Pressure of Gas in Street Mains,' is very interesting, and particularly so where he speaks of the meat being 'maggoty;' but I note that he speaks of it as a mystery. Now, I am not a 'scientific cuss,' yet it strikes me that what he deems so fraught with mystery may be quite easily explained. The meat was 'blown'—at least I should so infer from the balance of his remarks; there evidently was a 'mity' wind. The genius who perpetrated the above has since succumbed to a visitation of Providence—i. e., an attack of water gas. Yours, etc., CO."

NATURAL GAS AT OLEAN, N. Y.—The Keystone Gas Company, of Olean, N. Y., which is a purveyor of natural gas, charges \$4 per month for the gas supplied to an ordinary cooking stove; heating stoves, when kept in connection during the entire year, are charged for at the rate of \$1.60 per month each during the heated term. Consumers, should they so elect, may receive their supply of gas for heating and illumination at the rate of 50 cents per thousand cubic feet.

CRYING ALOUD IN BITTERNESS OF SPIRIT.—The water gas gentry at St. Louis, Mo., are in a pretty mean state of mind over the action taken by the members of the city councils toward the last of June. The St. Louis *Republican*, of date of June 20th, in reporting the matter, said: "The recent history of the gas question can be briefly told. A few days after both houses of the newly-elected Assembly were chosen they were convened in special session by Mayor Francis, and a bill was then introduced in the house of delegates authorizing the water gas company to supply the city with illuminating gas after 1890. This bill passed through the usual course, was read, referred, and favorably reported upon by the committee who had charge of its consideration. It came up for final reading and passage last Friday night, and the greatest interest was felt in the fate of the measure. Prior to its debate, however, Mr. Monahan introduced a resolution, as a kind of substitute, providing for the appointment of a joint committee to consider the subject of the manufacture and sale of gas, and authorizing the committee to sit during the summer. It was understood that this measure was satisfactory to the managers of the old St. Louis Gas Company. The debate was stormy, and the deliberations were marked by the usual criminations and re-criminations. The course of every delegate was eagerly watched, and when the vote was finally reached a careful tally was kept by the representatives of the gas companies interested. Mr. Monahan's resolution was defeated by a tie vote—13 to 13. The water gas men were highly elated with this victory, and in the glow of their triumph the water gas bill was taken up and passed. In the meanwhile the coal gas people were not idle, and on the following Thursday (June 18) Mr. Monahan's resolution was introduced in the Council and easily passed, and the water gas bill, reported from the house,

was referred to the committee of the whole. The house of delegates met on night of 19th, and passed the Monahan resolution, thus completely reversing their action of the previous week. The vote this time was 15 ayes to 12 noes. This was a terrible defeat for the water gas people, and they made no effort to conceal their chagrin." Now, as is usual with these odoriferous operators, they were not slow in making insinuation to the effect that corrupt motives induced this change of front (or vote) on the part of the delegates. It is to be expected that they would reason in this manner, knowing full well themselves that "potent arguments" are often advanced by those anxious to secure opposition charters. In regard to Mr. Keenan, representative from the 4th St. Louis ward, and who changed his vote on the Monahan resolution, it may be said that he voted originally under a misconception of the matter; and when the thing was explained to him he (Keenan) determined to accede to the wishes of his constituents. The Laclede Gas Light Company's works are situated in the Fourth ward, and one of the employes of that company was originally selected as delegate for the district, but resigned in favor of Keenan. Now, be it known that the Laclede Company is not a supporter of the St. Louis water gas prowlors, and also be it known that the men employed by that company are in no way desirous of being deprived of their living, consequently it required but little argument to convince delegate Keenan of the error of his way, provided he had the ambition or desire to succeed himself as the representative from that district. Certainly, the first thought that occurs to the minds of the water gas operators, when they experience a check in council boards to the passage of their schemes, is to cry fraud. They know the sort of "arguments" that are often employed; indeed, they do.

GLAD TO KNOW IT.—As an evidence that all departments of trade are not at a standstill, Messrs. Connelly & Co. (Limited), of Pittsburgh, Pa., furnish the following convincing testimony in the nature of shipments made by them during the two weeks ended July 3d:

One 20-inch governor to Consolidated Gas Light Company, of Baltimore, Md.; one of same dimension to Milwaukee (Wis.) Gas Light Company; one 10-inch governor to Capital City Gas Light Company, of Des Moines, Iowa; one 8-inch governor to Keokuk (Ia.) Gas Light Company; 6-inch governors to the Shelbyville, Columbus and Greenville (Ind.) Gas Light Companies; and instruments of same size to Pekin and Danville (Ills.) Gas Light Companies. One exhauster went to Greenville, Pa., and two carloads of iron sponge were shipped to Boston, Mass. Later orders include the following: A 20-inch governor to the Cincinnati (Ohio) Gas Light and Coke Company; a 6-inch exhauster to the South Bethlehem (Pa.) Gas Company; and one carload of sponge to the Charlestown (Mass.) works. Beyond a doubt the gas men of the United States mean to do some business this coming winter; and Connelly & Company have our congratulations.

MR. MONNETT RESPONDS.—In response to our invitation contained in last number of the JOURNAL, Mr. O. B. Monnett, of the Bucyrus (Ohio) Gas Works, writes that the "dip" is made from a leaching of the waste lime of gas purification. The leach is carried on as long as the resultant liquor possesses a certain strength. To 40 gallons of the liquor a certain proportion of blue vitriol is added. The inventor concludes with the statement that no better preparation for the curing of foot-rot, scab, removing lice from the bodies of all classes of live stock, healing sores on horses, etc., is at present on the market. Mr. Monnett claims that there is a large profit on its manufacture and sale, and adds that any gas company doing business in stock raising districts would find it advantageous to investigate the merits of the "dip." Mr. Monnett will sell the right to manufacture it over any section of the country.

CERTAIN RUMORS TAKING TANGIBLE SHAPE.—For some time back Dame Rumor has been busy in the promulgation of mysterious hints as to a deal that was about to take place between the shareholders of the South Boston (Mass.) Gas Light Company and that sweet-scented philanthropist, Mr. Addicks, of the Bay State Gas Company. While it was pretty well understood that "something was going on," no tangible evidence was presented until some few days ago, when the following appeared in a Boston newspaper. We give it for what it is worth, and are inclined to believe that the statement contains much of truth:

"The rivalry between the different gas interests of this city promises to take on a new phase by the transfer of the control of the South Boston Gas Light Company from the conservative stockholders who have held it to some parties in Philadelphia, Pa., who are said to be backed by the Standard Oil Company. This is the outcome of several attempted negotiations, and is thought by gas men to have some bearing on the contest in this city. Several weeks ago a meeting of the directors of the South Boston Company was held, and a motion was passed authorizing the Treasurer (Mr. R. J. Monks) to sell the stock represented, at the price of \$110 per share, to Mr. Addicks, of the Bay State Company, provided that Mr. Addicks would agree to take,

at this price, all the stock that might be brought to him within sixty days. Mr. Addicks at the time would offer no higher figure than par, and, further, was only desirous of purchasing a mere controlling interest in the company without taking all the stock that might be tendered him. Accordingly the trade fell through. The stock of the South Boston Company some time ago was held at as high a valuation as 140; but the electric lighting competition caused something of a decline, and the efforts of rival organizations to obtain a footing in the city accelerated this shrinkage until the price had dropped to 120, and in some cases even par was reached, although the less timid shareholders held their stock as worth a higher rate. Acting under the vote of the directors authorizing him to sell at 110, Mr. Monks went about among the stockholders and easily obtained power of attorney to sell a majority of the stock at 110, with a condition that the new purchasers should take all that might be offered in 60 days, and that the July dividend should accrue to the old holders. A former stockholder recently said that Mr. Monks had probably secured eight-tenths of the stock for transfer to the new purchasers. By the reported terms of the bargain the purchasers were to pay for the stock on July 10th, provided Mr. Monks had secured control by July 6th. The whole number of shares in company is 4,400, or a total par value of \$440,000. The purchaser is understood to represent a syndicate that already owns gas works in several cities of the country; and, as said before, this syndicate is reported to be connected with the Standard Oil Company. It is further reported that this movement is instigated by some of the parties interested in the Consumers Company. It is asserted that Mr. Monks will retain his position as Treasurer under the new management. The South Boston Gas Light Company has, by its charter, the right to lay pipes throughout the city, and the same right belongs by charter to the Boston Gas Light Company. The consent of the new State Gas Commission would have to be obtained before the streets could be dug up; but should that consent be given it might result in a very spirited contest between the rival companies. It has been, by courtesy and agreement, that the several coal gas companies in the city have heretofore respected each other's territory, and now that one of them is in hostile hands, there will very likely be an effort made by one to invade the territory of the other, with natural retaliatory action on the part of the threatened company. It is intimated that Mr. Addicks would have been willing to increase his bid had he known that a strong competitor was in the field. It is now stated, however, that the bargain has been practically consummated. We cannot quite understand on what ground Mr. Monks justifies his action, unless the stock of the South Boston Company was no longer worth \$110 per share to the people who had controlled it for such a length of time—and who had made so much money out of it, too. If it were not worth that price to the insiders, how could it possibly have such value to outsiders. We also suppose that the stockholders, who parted with their shares so readily on the representations made to them by Mr. Monks, will not receive any solace in the shape of lucrative positions or berths under the new management. Truly, if the report given above be correct, it looks like a cowardly sell-out on the part of the South Boston Company, and the old Boston Gas Light Company has received a rather mean stab from those whom it had every moral reason to suppose were staunch friends.

WOULD IT NOT BE MADE HOT FOR THEM?—Some of the wisacres have been busying themselves by asserting that Eastern capital was about to knock at the doors of the Cincinnati (Ohio) Councils in the attempt to establish an opposition gas plant within the precincts of the "big city of the Buckeye State." Rumor had it that the aforesaid capital was willing to go on with *bona fide* opposition measures, or would be willing to make something out of the Cincinnati Gas Light and Coke Company by selling out. If General Hickenlooper and Lieutenant Ross could not make it hot for that Eastern capital—yea, verily; even though it were in the middle of an Ohio winter—we are out of our reckoning. The managers of the "Imp." companies "know a thing or two" about the General.

UNDERGROUND WIRES IN BROOKLYN, N. Y.—The three Commissioners who have been appointed to take charge of placing underground the telegraph and other electrical conductors in Brooklyn, within the time specified by law, met on the evening of July 9th and organized for duty. The Commissioners are, beyond a doubt, excellent men, and Brooklyn is to be congratulated thereupon. The *personnel* of the Commission is as follows: George W. Plympton, Prof. Rossiter W. Raymond, and John Reynolds. At the meeting spoken of Mr. Plympton was chosen President, and Mr. Reynolds named as Secretary. A resolution was passed to the effect that each company should furnish to the Commission, on or before August 12th, a description of the plant in which it proposed to place its electrical conductors underground, together with a full statement of the nature, location and extent of its conduit system. If a company failed to supply this statement within the prescribed time limit, reasons for such failure must be filed. The same resolution provided that no new wires or poles could hereafter be erected without permission of the Board acting in conjunction with the Department of

City Works. Mr. Reynolds suggested that the Board should make as full an inquiry, as the limited time would admit of, into the subject before it; and he also secured the adoption of a resolution inviting all persons or corporations interested in the adoption of a general underground electrical system to present their views in writing, or otherwise, as speedily as possible. We have great hope that the Brooklyn Commission will attend to its duties with promptitude and fairness. Its members are honest-minded and capable gentlemen.

NOW FOR THE NEW YORK CITY COMMISSIONERS.—If we may congratulate Brooklyn over the composition of her electrical commission, we certainly can condole with the sister city of New York in regard to the "eminent" worth and "professional" capacity of the old political hacks appointed to take charge of similar matters in the Metropolis. Here they are, with their occupations: Theodore Moss, theatrical manager; Jacob Hess, butcher; and Charles E. Loew, steamboat excursion manager. Of course all of the three were appointed because they each possessed an enormous fund of electrical acumen, and were entirely conversant with the features of the work they were appointed to order and supervise. Jacob Hess, butcher, is to receive \$5,000 per annum (his associates receive the same salary), and he knows—well, he will know how to draw the monthly stipend, and "spend a portion of it on the boys."

STREETS UNLIGHTED.—It was expected that the new electric lights would be put in operation in the Eastern District of Brooklyn (at any rate those on First street and Broadway) on the evening of July 7, and the authorities instructed the Williamsburgh Gas Light Company not to light the gas lamps on those thoroughfares on that date. The gas lamps were unlighted, but the arcs failed to shine; and the two streets were left to gloomy darkness. The Western District arcs (or at least a certain number of them) were lighted for the first time on the evening of Wednesday, July 8. They were the 1,200-candle power article, paid for at the rate of \$182.50 per annum each; and without the slightest exaggeration two 5-foot gas burners would have given a much superior illumination. Beyond a doubt the Brooklyn specimen of arc street illumination is the weakest one that was ever presented in this or any other country. It must be seen in order that its true wretchedness may be appreciated.

A MYSTERIOUS MURDER.—Mr. Geo. S. Dunbar, a native of Pittsfield, Mass., and Superintendent of the Pittsfield Gas Company since date of 1869, has been made the victim of a most atrocious and mysterious murder. The crime was perpetrated on the night of July 4, the dead body of the Superintendent being found in the street at only a short distance from the gas works. The left eye was bruised, and a pistol ball had penetrated the skull at the base of the brain. A five-chambered 32-calibre revolver was found near the corpse, and one of the chambers contained an unexploded cartridge, while a second chamber held the cap of the cartridge that had done its fatal work. At about 9:30 P.M. of July 4 Mr. Dunbar explained to his wife he would pay a short visit to the works, in order that he might assure himself as to the condition of affairs there, and it was while returning from this visit that he met his death at the hands of some vile assassin. The object of the murderer was robbery, as deceased usually collected the accounts due the company, and the July quarterly collection had been pretty well advanced. Up to present advices (July 11) no clue to the author of the crime has been discovered. The selectmen of the town have offered a reward for the detection of the assassin; the gas company and widow of deceased having supplemented that action. Mr. Dunbar was 48 years of age, and possessed a great turn for mechanics. He was well known among the Eastern fraternity, and had amassed a competence. We would ask the officials of the Pittsfield Company to forward us the developments as they appear in the future history of this mysterious case.

MEASURING THE CANDLE POWER OF A LIGHT.—The *Electrician* says that "the candle power of a light may be approximately calculated by comparing the shadow cast by a rod in the light of a standard candle with the shadow cast with the light to be tested. By moving the latter toward or away from the rod a point will be reached at which the shadow cast by both lights will be of the same intensity. The intensities of the two lights are directly proportional to the squares of their distances from the shadows—*i. e.*, suppose the light to be tested is three times the distance of the candle, its illuminating power is nine times as great." Perhaps.

NEW APPARATUS.—The Chicago (Ills.) Gas Light and Coke Company's managers have ordered two "Standard" washer-scrubbers, each to be of one million cubic feet capacity. The machines are to be constructed at once, and when completed will be installed in the extension made to that section of the plant known as the "North Side Station."

ANNUAL MEETING.—The 34th meeting of the American Association for the Advancement of Science will be held at Ann Arbor, Mich., beginning August 21st and terminating September 1st.



A. M. CALLENDER & CO.,
PROPRIETORS.

Editor—JOS. R. THOMAS, C.E

Manager—C. E. SANDERSON.

PUBLISHED ON THE 2ND AND 16TH OF EACH MONTH

At No. 42 Pine Street, New York.

This is a recognized official organ of—
LIGHT, HEAT, STEAM, WATER-SUPPLY,
VENTILATION, SANITARY IMPROVEMENT,
AND GENERAL SCIENCE.

TERMS

SUBSCRIPTION—Three Dollars per annum, in advance.

AGENTS

NEW YORK—AMERICAN NEWS Co. 39 and 41 Chambers St.
BOSTON—S. M. PETTINGILL & Co., 6 State Street.
PHILADELPHIA—PRATT & Co., Corner 9th and Arch Streets.
England—C. W. HASTINGS, 22 Buckingham St., London, W. C
Germany—B. WESTERMANN & Co., of New York

THURSDAY, JULY 16, 1885.

The Market for Gas Securities.

The city share market has been quite listless and weak. We quote Consolidated (July 14) at 94 bid, offered at 95. The Equitable "peggers" stick to their figures. Fulton Municipal (Brooklyn) has declared a quarterly dividend of 3 per cent.; Nassau (Brooklyn) pays a 2 per cent. quarterly. St. Louis (Mo.) Gas Company managers divided up \$90 per share.

Gas Stocks.

Quotations by Geo. W. Close, Broker and Dealer in Gas Stocks.

16 WALL ST., NEW YORK CITY.

JULY 16.

All communications will receive particular attention.
The following quotations are based on the par value of \$100 per share.

	Capital.	Par.	Bid	Asked
Consolidated.....	\$35,430,000	100	94	95
Central.....	440,000	50	60	70
“ Scrip.....	220,000	—	47	57
Equitable.....	2,000,000	100	136	140
“ Bonds.....	1,000,000	—	107	110
Harlem, Bonds.....	170,000	—	—	—
Metropolitan, Bonds....	658,000	—	110	113
Mutual.....	3,500,000	100	130	132
“ Bonds.....	1,500,000	1000	104	107
Municipal, Bonds.....	750,000	—	—	—
Northern.....	125,000	50	50	—
“ Scrip.....	108,000	—	—	—
Gas Co's of Brooklyn.				
Brooklyn.....	2,000,000	25	129	131
Citizens.....	1,200,000	20	86	88
“ S. F. Bonds....	320,000	1000	106	110
Fulton Municipal.....	3,000,000	100	158	160x
“ Bonds....	300,000	—	104	108
Peoples.....	1,000,000	10	82	83
“ Bonds.....	290,000	—	105	110
“ “.....	250,000	—	90	95
Metropolitan.....	1,000,000	100	94	96
Nassau.....	1,000,000	25	125	127x
“ Cfs.....	700,000	1000	98	99
Williamsburgh.....	1,000,000	50	151	153

“ Bonds...	1,000,000	—	111	114
Richmond Co., S. I.	300,000	50	64	75
“ Bonds.....	40,000	—	—	—
Out of Town Gas Companies.				
Buffalo Mutual, N. Y....	750,000	100	80	85
“ Bonds....	200,000	1000	95	100
Citizens, Newark.....	918,000	50	103	115
“ “ Bonds.	124,000	—	105	110
Chicago Gas Co., Ills....	5,000,000	25	128	132
Peoples G. L. & C. Co.,				
Chicago, Ills.....			8	12
Cincinnati G. & C. Co..			180	182
Consolidated, Balt.....	6,000,000	100	42	43
“ Bonds....	3,600,000	—	107	107½
Central, S. F., Cal.....			—	58
Capital, Sacramento, Cal.			56	—
Hartford, Conn.....	750,000	25	123	129
Jersey City.....	750,000	20	145	—
Laclede, St. Louis, Mo.	1,600,000	100	100	105
Louisville, Ky.....	1,500,000	50	95	100
Montreal, Canada.....	2,000,000	100	181	182½
New Haven, Conn.....		25	166	170
Oakland, Cal.....			29	30
Peoples, Jersey City ...			—	45
“ “ Bonds.			—	—
Paterson, N. J.....		25	90	—
Rochester, N. Y.....		50	75	80
Washington, D. C.....	2,000,000	20	212½	—
Wilmington, Del.....		50	199	210
Yonkers.....		50	41	44
St. Louis, Missouri.....	600,000	50	—	315x
San Francisco Gas Co.				
San Francisco, Cal....			56¾	57½
Havana (Cuba) Gas Co.	3,000,000	100	8	—
“ Bonds.....	550,000			

Advertisers Index.

	Page
GAS ENGINEERS.	
Jos. R. Thomas, New York City	43
Wm. Henry White, New York City.....	50
GAS WORKS APPARATUS AND CONSTRUCTION.	
James R. Floyd, New York City	51
T. F. Rowland, Greenpoint, L. I.....	51
Deily & Fowler, Phila., Pa.....	51
Kerr Murray Mfg. Co., Fort Wayne, Ind.....	51
Stacey Mfg. Co., Cincinnati, Ohio.....	51
Bartlett, Hayward & Co., Baltimore, Md.....	51
Morris, Tasker & Co., Limited, Phila., Pa.....	50
Davis & Farnum Mfg. Co., Waltham, Mass.....	24
Tanner & Delaney Engine Co., Richmond, Va.....	50
R. D. Wood & Co., Phila., Pa.....	50
Southwark Foundry and Machine Co., Philadelphia, Pa.....	50
GAS AND WATER PIPES.	
A. H. McNeal, Burlington, N. J.....	48
Gloucester Iron Works, Phila., Pa.....	48
Warren Foundry and Machine Co., Phillipsburgh, N. J.....	48
Mellert Foundry and Machine Co., Reading, Pa.....	48
Cincinnati and Newport Iron and Pipe Co., Newport, Ky....	48
PIPE JOINTS.	
Pancoast & Maule, Philadelphia, Pa	43
Rollstone Machine Company, Fitchburg, Mass.....	43
SCRUBBERS AND CONDENSERS.	
G. Shepard Page, New York City.....	49
REGENERATOR FURNACES.	
Charles F. Dieterich, Baltimore, Md.....	52
GAS ENGINES.	
Schleicher, Schumm & Co., Phila., Pa.....	56
Clerk Gas Engine Company, Phila., Pa.....	44
RETORTS AND FIRE BRICK.	
J. H. Gautier & Co., Jersey City, N. J.....	46
B. Kreisler & Sons, New York City.....	46
Adam Weber, New York City	46
Laclede Fire Brick Works, St. Louis, Mo.....	46
Brooklyn Retort and Fire Brick Works, Brooklyn, N. Y.	46
Borgner & O'Brien, Phila., Pa.....	46
William Gardner & Son, Pittsburgh, Pa.....	46
Henry Maurer, New York City.....	46
Chicago Retort and Fire Brick Works, Chicago, Ills.....	46
Baltimore Retort and Fire Brick Co., Baltimore, Md.....	46
Standard Gas Retort and Fire Brick Co., Ironton, Ohio.....	46
Oakhill Gas Retort and Fire Brick Co., St. Louis, Mo.....	46
Cincinnati Gas Retort & Fire Brick Co., Cincinnati, O.....	46
A. T. Chur, New York City.....	48
GAS STOVES.	
American Meter Co., New York and Philadelphia.....	47
The Goodwin Gas Stove and Meter Co., Philadelphia, Pa. ..	28
GAS METERS.	
Harris, Griffin & Co., Phila., Pa.....	54
American Meter Co., New York and Philadelphia.....	55
The Goodwin Gas Stove and Meter Co., Phila. Pa.....	55
Helme & McIlhenny, Phila., Pa.....	55
Maryland Meter and Mfg. Co., Baltimore, Md.....	54
D. McDonald & Co. Albany, N. Y.....	55
Nathaniel Tufts, Boston, Mass.....	54
EXHAUSTERS.	
P. H. & F. M. Roots, Connersville, Ind.....	45
Smith & Sayre Manufacturing Co., New York City.....	50
Wilbraham Bros., Philadelphia, Pa.....	52
GAS COALS.	
Penn Gas Coal Co., Phila., Pa.....	53
Perkins & Co., New York City.....	52
Newburgh Orrel Coal Co., Baltimore Md	53
Despard Coal Co., Baltimore, Md.....	53
Chesapeake and Ohio R.R. Coal Agency, N. Y. City.....	53
Westmoreland Coal Company, Phila., Pa.....	53
GAS ENRICHERS.	
W. H. Doan, Cleveland, Ohio.....	43
VALVES.	
Ludlow Valve Manufacturing Co., Troy, N. Y.....	48
John McLean, New York City.....	48
GAS LAMPS.	
Siemens Regenerative Gas Lamp Co., Philadelphia, Pa.....	49
G. Shepard Page, New York City.....	25
GAS KILNS AND OVENS.	
Thompson Gas Kiln and Oven Co., New York City.....	45
PURIFIER SCREENS.	
John Catot, Lawrence, Mass.....	43
STREET LAMPS.	
J. G. Miner, Morrisania, New York City.....	45
Bartlett Street Lamp Mfg Co., New York City.....	45
BURNERS.	
G. Gefroerer, Phila., Pa.....	50
PURIFYING MATERIAL.	
Connelly & Co., New York City	43
STEAM BLOWER FOR BURNING BREESE.	
H. E. Parson, New York City.....	26
PIPE COVERINGS.	
Chalmers-Spence Company, N. Y. City.....	26
GAS FIXTURES.	
Mitchell, Vance & Co., New York City.....	43
STEAM ENGINES.	
Westinghouse Machine Co., Pittsburgh, Pa.....	53
STEAM PUMPS.	
A. S. Cameron Steam Pump Works, N. Y. City.....	45
HYDRAULIC ELEVATOR.	
Lane & Bodley Company, Cincinnati, Ohio.....	45
SHAFTING, PULLEYS, ETC.	
A. & F. Brown, New York City.....	43
HYDRAULIC MAIN.	
A. E. Boardman, Macon, Ga.....	45

Situation Wanted.

A practical man of long experience desires a position

In a Gas Company's Meter Shop.

Can do jobbing and indexing. No objection to the country. Best of references. Address 626-It "R. O. C.," 508 Hudson Street, N. Y. City.

SITUATION WANTED

As Meter Repairer.

A practical meter maker of 17 years' experience, for some time foreman of one of the largest meter factories in Europe, desires a situation as meter repairer in a gas works. Can furnish first-class testimonials. Address 626-It "R. R.," care this Journal.

Situation Wanted.

A good, faithful man, having an experience of 28 years in the practical operation of gas works, is desirous of obtaining a situation as Superintendent of a small plant. Can attend to all details of manufacture, street work, meter repairs, etc. Can furnish sufficient reference as to ability. Address

N. MALMQUIST, 56 Hudson Avenue, Brooklyn, N. Y.

**WANTED, TO PURCHASE OR LEASE,
A Gas Works.**

State terms and particulars in full. Address
625-2t GAS WORKS, care this Journal.

SITUATION WANTED

As Manager or Assistant

in a gas works. Twenty-nine years' experience; entire management last thirteen years; references on application. Address
625-2t P. O. Box 181, Brockton, Mass.

GEROULD'S IMPROVED RETORT CEMENT.

Used by most of the Gas Companies of the United States with perfect satisfaction. Manufactured by

**C. L. GEROULD,
Manchester, N. H.**

N. B.—As Manchester is a shipping point, all freight can be shipped as cheaply as from Boston or New York.

FOR SALE.

Second-Hand Gas Apparatus.

One Condenser, 4½ ft. diameter by 13 ft. in length over all, containing 150 two and one-half inch tubes, 8 ft. long with 12-in. connections and bye-pass.

Two Smith & Sayre (12-inch) Steam-Jet Exhausters, with 3 Self-acting Bye-Passes.

Four Purifying Boxes, 10 ft. by 14 ft. by 3 ft., with 12-inch connections and center seal.

All in good order, and will be sold cheap. Address

PETER P. MILLER, Manager Citizens Gas Co.,
Buffalo, N. Y.

FOR SALE,

Second-Hand Gas Apparatus.

The Louisville (Ky.) Gas Light Company wishes to dispose of the following:

15 Sixteen-Inch Chapman Valves.

6 Twelve-Inch Chapman Valves.

2 Twelve-Inch Center Seals & Connections.

2 Smith & Sayre Gas Steam Governors.

All in good order, and will be sold at low figures. Address inquiries to

A. H. BARRET,
Engineer's Office, Louisville (Ky.) Gas Company.

JOS. R. THOMAS, C.E.,

May be Consulted on all Matters Relating to Gas Works and Gas Manufacture.

ADDRESS THIS OFFICE.

WM. FARMER, ENGINEER,
32 Park Place, Room 36, New York.

THE CHEMIST'S ASSISTANT; OR, KINDERGARTEN SYSTEM OF CHEMISTRY.

A system by which the elements and their valences are represented by illustrations and solid bodies.

BOX AND PAMPHLET COMPLETE, \$2.50.

**Iron Sponge,
GAS EXHAUSTERS,
AUTOMATIC GAS GOVERNORS,
CONNELLY & CO., Limited,
No. 407 BROADWAY, NEW YORK CITY.**

W. H. DOAN,

REFINER OF

NAPHTHA and GASOLINES

ALSO MANUFACTURER OF

A Special Grade of Naphtha for Gas Companies

FOR ENRICHING COAL GAS.

Correspondence solicited.

No. 43 Euclid Avenue, Cleveland, Ohio.

HODGE'S UNIVERSAL ANGLE UNION, Pat'd

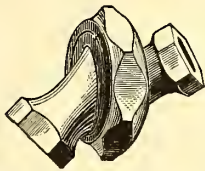

A new and important Pipe Fitting for Steam, Water, or Gas. Combining a variable angle or elbow and a union. Saves pipe, saves time, decreases friction and radiation, gives a union joint at every angle, and can be set at any angle at which it is desired to run the pipe.

HODGE'S SWIVEL FLANGE,

A common sense article, designed to save time and money.

MANUFACTURERS AND WHOLESALE AGENTS,

ROLLSTONE MACHINE CO.,

142 Water St., Fitchburg, Mass.

MITCHELL, VANCE & CO.,

MANUFACTURERS OF

Chandeliers

and every description of

GAS FIXTURES.

Also manufacturers of Fine Gilt Bronzes and Marble Clocks, warranted best time-keepers. Mantel Ornaments, etc.

Salesrooms, 836 Broadway, N. Y.

Special Designs furnished for Gas Fixtures for Churches, Public Halls, Lodges, etc.

It will "Pay the Piper,"



If he aims to pipe well for STEAM, WATER, GAS, ACIDS, OILS, AMMONIA, &c., to examine this UNION, which requires no packing, but is always ready for instant use. When

you next order Fittings of any Dealer, ask for a sample American Union to come with them, and it will tell you the whole story, or we will, if you write us for particulars.

PANCOAST & MAULE,
PHILADELPHIA, PA.

GAS CO. OFFICERS,

READ AND REFLECT.

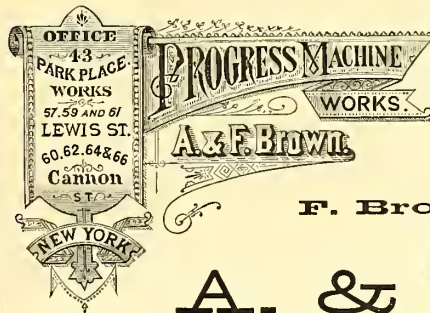

**Shafting, Pulleys,
HANGERS.**

F. Brown's Patent Friction Clutch.

Send for Illustrated Catalogue and Discount Sheet to

A. & F. BROWN,

No. 43 Park Place, New York City.

Pipe Coverings.

Fireproof, Non-Conducting Coverings for
**STEAM PIPES, BOILERS,
And all Hot Surfaces.**

Made in sections three feet long. Easy to apply; light and cheap. Asbestos Materials, Fibre, Braided Packing, and Cement. These goods are used at Continental Works, Br'klyn.

CHALMERS-SPENCE COMPANY, 419 & 421 EIGHTH ST., N. Y.

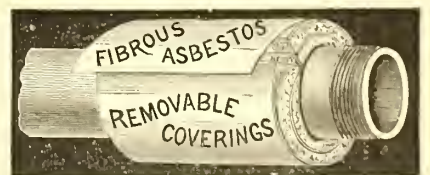

CHURCH'S REVERSIBLE SCREEN FOR GAS PURIFIERS

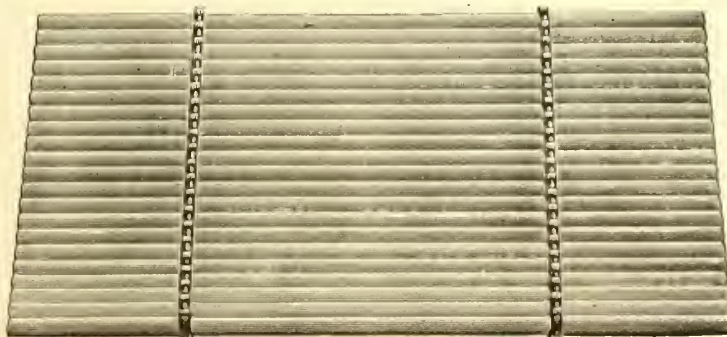

PATENTED JULY 9, 1878.

References in all parts of the country. Send for circular and list of companies who now have the Screen in use.

**Very Durable
Easily Repaired.**

**Oval Slats, with
Malleable Iron
Cross Bars.**

Apply to

**JOHN CABOT,
LAWRENCE, MASS.**

THE CLERK GAS ENGINE.

Highest Award American Institute, New York, 1883. Silver Medal American Institute, N. Y., 1884.

Gold Medal Awarded Crystal Palace Electrical Exhibition, London, 1882.

Highest Award for Motive Power British Section International Exhibition of Electricity, Paris, 1881.

Reliable.
No Boiler.
Steady.
No Coal.
Simple.
No Ashes.
Compact.

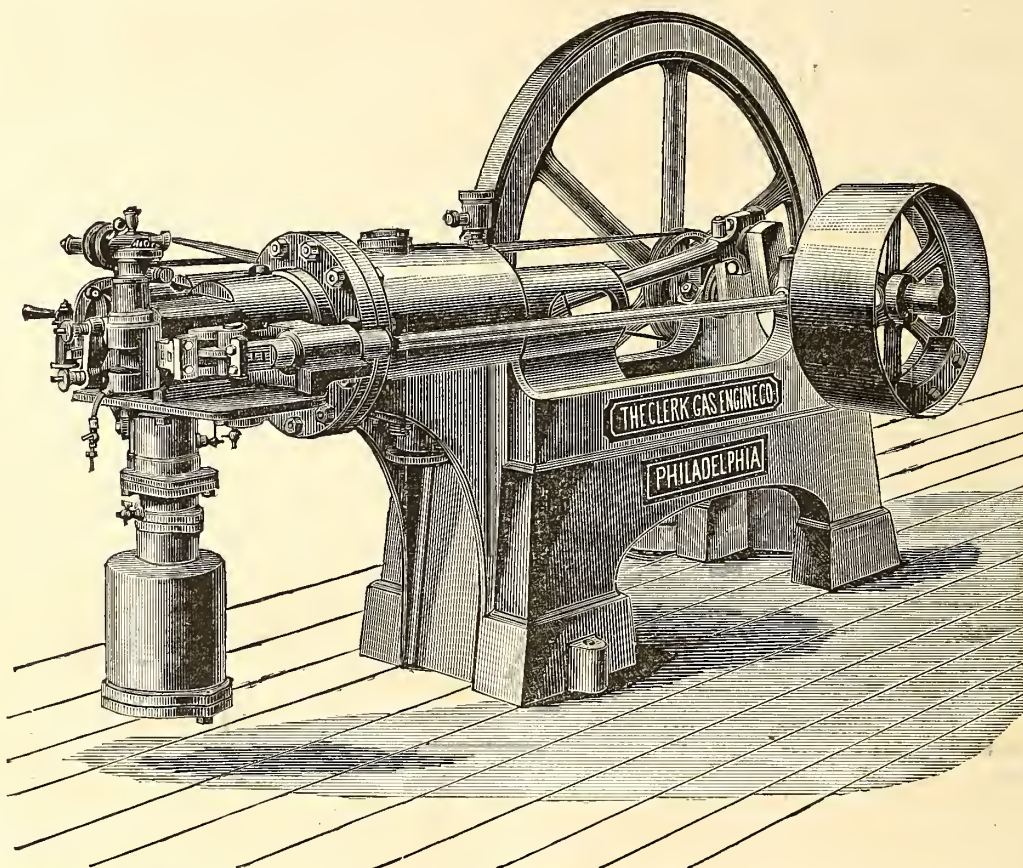

Economical.
No Engineer.
No Explosion
No Gearing
Wheels.
No Danger.
No Parts
requiring
frequent
renewal.

REQUIRING ONLY A MATCH TO START IT--GIVING ITS FULL POWER IMMEDIATELY.

We would inform the public that during the last few months we have improved THE CLERK GAS ENGINE to such an extent that we can now offer an engine vastly superior to our former pattern. These improvements have enabled us to sell our engine at a GREATLY REDUCED FIGURE, partly on account of the decreased weight (our engine weighing about half that of others giving the same Brake H. P). The consumption of gas has been decreased to a considerable extent, and the Brake H. P. has been increased some 25 to 30 per cent. All parts of the old design that were considered defective have been remodeled and new designs added. We now have an engine second to none as regards power, consumption, and ease of working. With our new engine all trouble in starting has been removed, the noise reduced to a minimum, and the regularity of motion is now all that can be desired. We guarantee all we claim for it, and the material and workmanship being of the best, enables us to guarantee the engine for twelve months.

SOLE MAKERS,

THE CLERK GAS ENGINE CO.,

WM. W. GOODWIN, President. E. STEIN, Secretary. S. LEWIS JONES, Asst. Secretary. L. P. GARRET, Supt.

Main Office, 1012-1018 Filbert Street, Philadelphia, Pa.

BRANCH OFFICES,

142 Chambers St., N. Y.

4 West Fourteenth St., N. Y.

76 Dearborn St., Chicago

General Agents,

THE GOODWIN GAS STOVE & METER CO.

Of Philadelphia, New York, and Chicago.

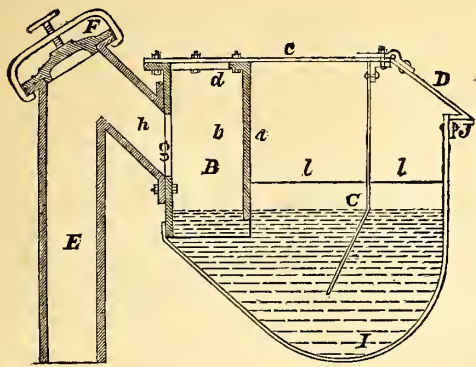

Boardman Hydraulic Main,

Patented October 7, 1884.

For description, see AM. GAS LIGHT JOURNAL of Feb. 2, 1884.
For terms, apply to

A. E. BOARDMAN, Macon, Ga.

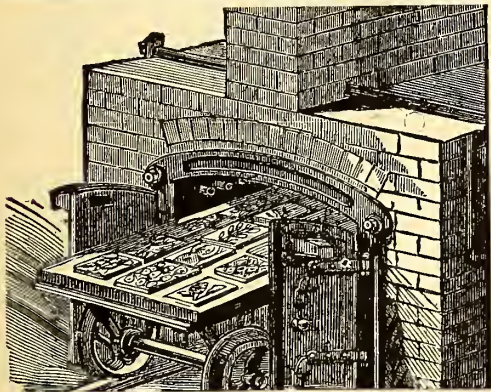

Glass-Staining Gas Kiln.

BAKERS' & CONFECTIONERS' OVENS (PAT.)

Thompson Gas Kiln & Oven Co.

59 Carmine St., N. Y.

Send for Circular by mail.

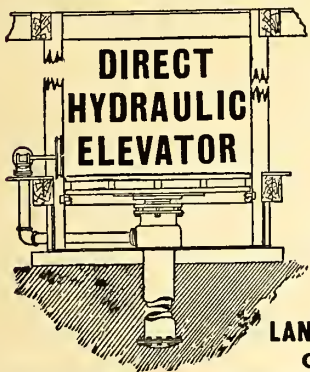

**DIRECT
HYDRAULIC
ELEVATOR**

With Iron or Wood Platform.

Largely used by Leading Gas Co.s for Coal and Coke Lifts.

Adapted for use with city service, or special pumping and accumulator system. For prices address the

LANE & BODLEY CO., Cincinnati, O.

THE GLOBE STREET LAMP.



MINER'S PATENT STREET LAMPS.

Are adapted for use of Streets, Parks, Depots, Ferries, & Private Grounds.

WITH POSTS OR BRACKETS.

Jacob G. Miner,

No. 823 Eagle Ave., New York N. Y.

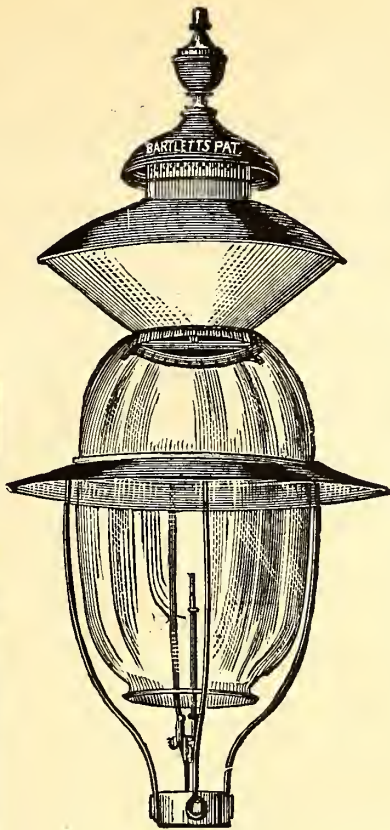

I. C. BARCALOW, PREST.

J. V. BARCALOW, SEC. & TREAS.

**BARTLETT
Street Lamp Mfg. Co.**

MANUFACTURERS OF

Bartlett's Patent

GLOBE LAMPS,

FOR

Streets, Parks, Railroad Stations, Public Buildings, Etc.

LAMP POSTS A SPECIALTY.

Office and Salesroom,

No. 35 Howard Street, N. Y. City.

Gas Companies and others intending to erect lamps and posts will do well to communicate with us.

F. M. ROOTS.

S. C. ROOTS

D. T. ROOTS.

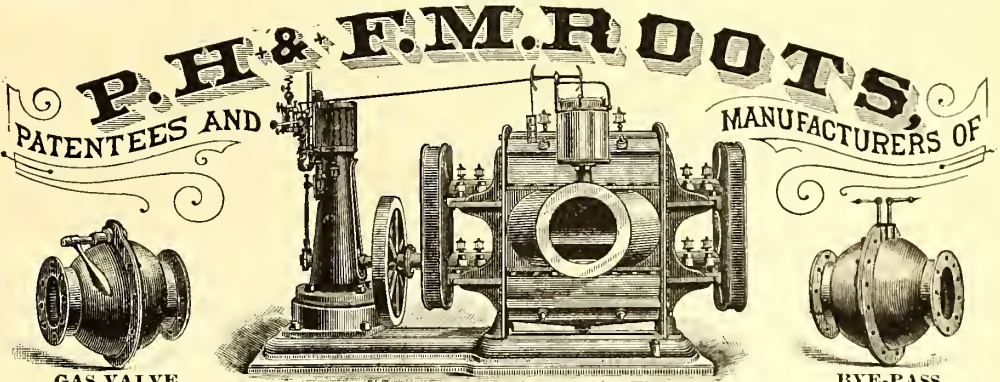

IMPROVED GAS EXHAUSTER,

WITH ENGINE ON SAME BED PLATE, OR WITHOUT.

BYE-PASSES, GAS VALVES, GOVERNORS, ELBOWS, PIPE-FITTINGS, Etc., FURNISHED TO ORDER,

P. H. & F. M. ROOTS, Patentees & Manufacturers, **CONNERSVILLE, IND.**

S. S. TOWNSEND, General Agent, 22 Cortland St. and 9 Dey St., N. Y.

JAS. BEGGS & CO., Selling Agents, 9 Dey St., N. Y.

COOKE & CO., Selling Agents, 22 Cortland St., N. Y.

✽ SEND FOR ILLUSTRATED CATALOGUE AND PRICE LIST. ✽

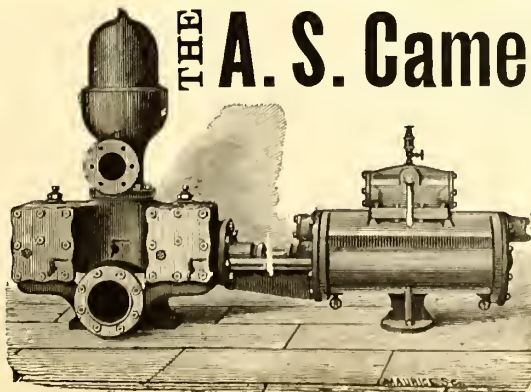

THE A. S. Cameron Steam Pump,

THE STANDARD OF EXCELLENCE.

Upward of 30,000 in Use.

BEST GAS WORKS PUMP

Ever Introduced.

Adapted to Every Possible Duty.

A.S. Cameron Steam Pump Works,

Foot East 23d St., N. Y.

J. H. GAUTIER & CO.,

CORNER OF
GREENE AND ESSEX STREETS,
JERSEY CITY, N. J.

MANUFACTURERS OF

**Clay Gas Retorts,
Gas House Tiles,
Fire Bricks, Etc. Etc.**
Ground Clay, Fire Brick and
Fire Sand in Barrels,

J. H. GAUTIER.
C. E. GREGORY.

T. B. GAUTIER.
C. E. GAUTIER.

BROOKLYN

Clay Retort & Fire Brick Works,
(EDWARD D. WHITE & CO.)

Manufacturers of Clay Retorts, Fire Brick,
Gas House and other Tile.

VAN DYKE, ELIZABETH, RICHARDS & PARTITION STS.
Office, 88 Van Dyke St., Brooklyn, N. Y.

LACLEDE FIRE BRICK MFG. CO.,

MANUFACTURERS OF

Fire Brick, Gas Retorts,

AND

ST. LOUIS STANDARD SEWER PIPE.

Blast Furnace and Cupola Linings, every description of Fire
Clay Material, Fire Clay Flue Linings, Chimney Tops
Dry Milled and Crude Fire Clays, etc.

OFFICE AND DEPOT

901, 903, and 905 Pine Street,
ST. LOUIS, MO.

ESTABLISHED IN 1845.

B. KREISCHER & SONS,

OFFICE FOOT OF HOUSTON ST., E.R., N.Y.

Gas Retorts,

TILES, FIRE BRICK.

AND EVERYTHING IN THE FIRE CLAY LINE.

**MANHATTAN
FIRE BRICK & ENAMELLED CLAY
RETORT WORKS.**

ADAM WEBER.

**CLAY GAS RETORTS
AND RETORT SETTINGS
FIRE BRICKS, TILES, ETC.,**

Office and Works, 15th Street and Avenue C., N. Y.

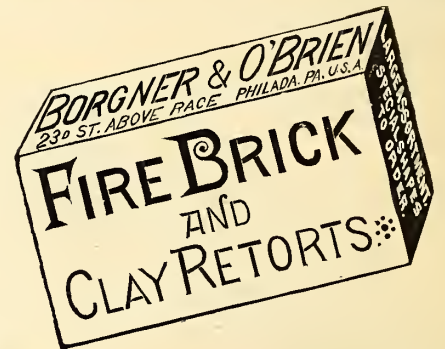

JAMES GARDNER, JR.
Works,
LOCKPORT STATION, PA.

—ESTABLISHED 1864.—

WILLIAM GARDNER & SON,
Successor to GARDNER BROTHERS.

WILLIAM GARDNER.
Office, COAL EXCHANGE,
PITTSBURGH, PA., P. O. Box 373.

Fire Clay Goods for Gas Works.

C. H. SPRAGUE, No. 70 KILBY STREET, BOSTON, MASS., Agent for the New England States.

OFFICE, 418 to 422 East 23d St., New York.

ESTABLISHED 1856.

WORKS, PERTH AMBOY, NEW JERSEY.

HENRY MAURER,

Excelsior Fire Brick & Clay Retort Works

CLAY GAS RETORTS, BENCH SETTINGS, FIRE BRICK, TILES, ETC.

STANDARD GAS RETORT AND FIRE BRICK COMPANY,

J. ANDERSON, PRES. & MANG'R.

OF IRONTON, OHIO.

C. PETERS, SECRETARY.

Clay Gas Retorts, Fire Brick, and Fire Clay Goods of Every Description.

Plans of Livescy-Somerville, McIlhenny, and other Furnaces, and Competent Workmen Supplied.

CHICAGO

Retort & Fire Brick Works,

OFFICE AND FACTORY,
Clark, Forty-Fifth, and La Salle Streets,
CHICAGO, ILL.

GEORGE C. HICKS, PRES. PAUL P. AUSTIN, SEC. & TREAS.

STANDARD

Clay Retorts and Settings.

BLOCKS & TILES

of every Shape and Size to Order.

Standard Fire Bricks.

CINCINNATI

Gas Retort & Fire Brick Co.,

(ESTABLISHED 1872.)

CINCINNATI, OHIO.

Manufacturers of Gas Retorts, Retort Set-
tings, Fire Brick, Tiles, Etc.

OAKHILL

**GAS RETORT & FIRE BRICK
COMPANY.**

PARKER, RUSSELL & CO.

City Office, 711 Pine Street,

ST. LOUIS, MO.

Our immense establishment is now employed almost entirely in
the manufacture of

MATERIALS FOR GAS COMPANIES.

We have studied and perfected three important points. Our re-
torts are made to stand changes of temperature, the strongest
heats of the furnace, and the abrasion of feeding and emptying.
Our customers are in almost every State of the Union, to all of
whom we refer.

THOS. SMITH, Prest. AUGUST LAMBLA, Vice-Prest. & Sup

**BALTIMORE
RETORT & FIRE BRICK CO.**

MANUFACTORY AT

LOCUST POINT, BALTIMORE, MD.

Connection with the City by Telephone.

Clay Retorts, Blocks & Tiles,

**FIRE BRICK, FIRE CLAY,
AND FIRE CEMENT.**

Red and Buff Ornamental Tiles and Chim-
ney Tops. Drain and Sewer Pipe (from
2 to 30 inches). Baker Oven Tiles
12 x 12 x 2 and 10 x 10 x 2.

WALDO BROS., 88 WATER ST., BOSTON, MASS

Sole Agents for New England States

THE AMERICAN METER CO.,

MANUFACTORIES,

512 West Twenty-second Street, N. Y. Arch and Twenty-second Street, Phila.
Nos. 244 & 246 North Wells Street, Chicago, Ill.

AGENCIES,

No. 177 Elm Street, Cincinnati, Ohio. Nos. 122 & 124 Sutter Street, San Francisco Cal.
No. 810 North Second Street, St. Louis, Mo.

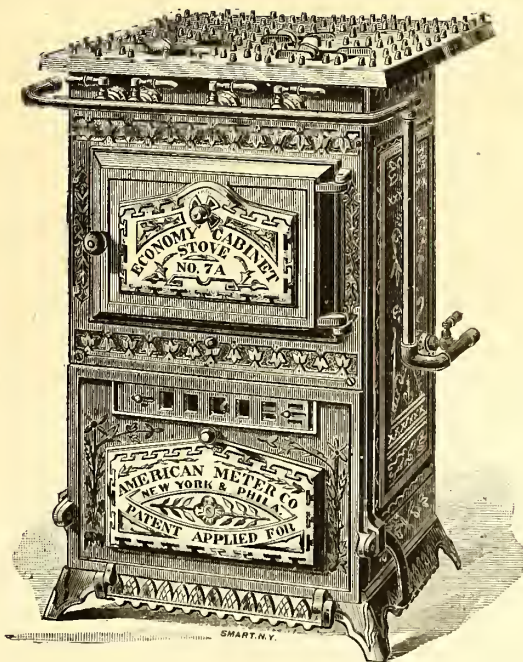

NEW DESIGN STOVES MADE IN CAST IRON, WITH EITHER OPEN OR CLOSED TOPS.

In presenting our "Economy" Gas Cooking Stoves and Ranges for the Season of 1885, we have the pleasure to inform our patrons that the increasing demand for these Stoves has encouraged us to make entirely new patterns, of HIGHLY ORNAMENTAL DESIGNS, for the popular sizes. We have also embraced the opportunity to increase the size of these Stoves, giving greater TOP PLATE AND OVEN capacity.

Full Lists and Catalogues are in preparation, and large stocks of Stoves will be kept at our Manufactories and Agencies for prompt shipment.

AMERICAN METER CO.

A. H. M'NEAL,
BURLINGTON, N. J.

Flange-Pipes

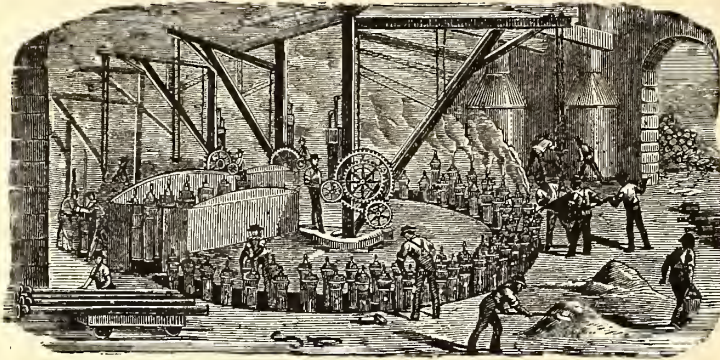

General Foundry Work.

CAST IRON PIPES
FOR WATER AND GAS.

JAMES S. MOORE, Pres.
BENJAMIN CHEW, Treas.

JAS. P. MICHELLON, Sec.
WM. SEXTON, Supt.

GLOUCESTER IRON WORKS,
GLOUCESTER CITY, N. J.



Cast Iron Gas & Water Pipes, Stop Valves, Fire Hydrants, Gasholders, &c.
Office No. 6 North Seventh Street, Philadelphia.

ESTABLISHED 1856.

WARREN FOUNDRY AND MACHINE CO.,

WORKS AT PHILLIPSBURGH, N. J.
NEW YORK OFFICE, 162 BROADWAY.

Cast Iron Water and Gas Pipe

FROM TWO TO FORTY-EIGHT INCHES DIAMETER.
ALSO ALL SIZES OF

FLANGE PIPE for Sugar House and Mine Work.
Branches, Bends, Retorts, Etc., Etc.

MATTHEW ADDY, President.

W. L. DAVIS, Selling Agent.

GEO. P. WILSHIRE, Sec. & Treas.

Cincinnati and Newport Iron and Pipe Company,
NEWPORT, KY.

Lamp Posts
AND
BENCH CASTINGS



Branch
AND
SPECIAL CASTINGS

A Specialty.

Large & Heavy Castings for General Work.

FOR GAS & WATER CO'S.

Manufacture Pipe from 2 to 48 inches, All work guaranteed first quality.

Mellert Foundry and Machine Co.
Limited. Established 1848.
MANUFACTURERS OF



Specials—Flange Pipe, Valves and Hydrants,
Lamp Posts, Retorts, etc.
Machinery and castings for Furnaces, Rolling Mills, Grist and
Saw Mills, Mining Pumps, Hoists, etc.
GENERAL OFFICE, - - - READING, PA.

CAST IRON
Gas and Water Pipes,

From 2 to 48 Inches in Diameter.

FOX & DRUMMOND,

160 Broadway, N. Y. City.

LUDLOW VALVE MFG. CO.

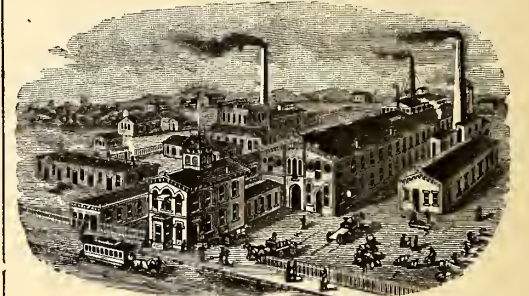

OFFICE AND WORKS,
938 to 954 River Street and 67 to 83 Vail Av.
- TROY, N. Y.

Hydraulic Main Dip Regulators, also
Check Valves, Foot Valves, Yard-
wash and Fire Hydrants.
Send for Circulars.

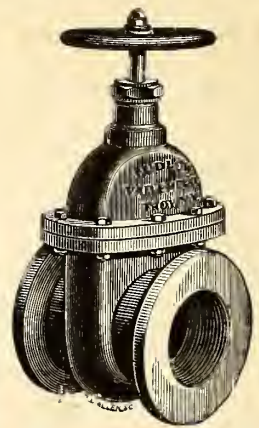

Valves.—Double and Single Gate, 1/2 in. to
48 in., outside and inside Screws. Indica-
tor, etc., for Gas, Water, Steam, and Oil.
and for Circulars.

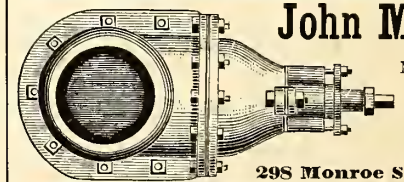

John McLean

Man'facturer of

GAS
VALVES.

298 Monroe Street, N. Y.

WELSH "ABERNANT"
Silica Dinas Fire Brick & Cement.

Unrivalled for Endurance Under Intense
Heat. Percentage of Silica, 95.64.

Also SCOTCH "BLOCHAIRN" FIRE BRICK.

A. T. CHUR,

SOLE AGENT FOR THE UNITED STATES,

Mills Building, Room 14, Fifth Story, New York.

R. D. WOOD & CO.,

400 Chestnut Street, Phila., Pa.

Cast Iron Gas & Water Pipe, Water Machinery & Gas Apparatus

Cast Iron Pipe, Fire Hydrants, Eddy Valves, Lamp Posts, Large Loam Castings, Flanged Pipe, Sugar House Work, Iron Roofs and Floors, Wrought & Cast Iron Tanks, Turbine Water Wheels and Pumps.

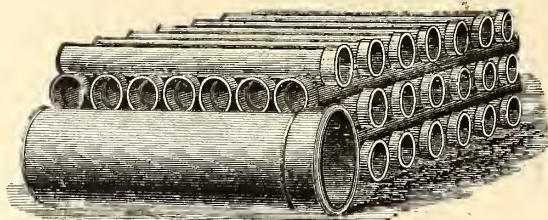

Casholders, Lime Trays, Center Valves, Purifiers, Bench Work, Exhausters, Condensers, Governors, Scrubbers, Gas Valves, Station Meters, Cast Iron Pipe Fittings.

Manufacturers of Heavy Castings and Machinery of Every Description.

ENGINEERS & CONTRACTORS FOR THE ERECTION OF GAS WORKS, & ALL MACHINERY CONNECTED THEREWITH

Estimates and specifications furnished for erection of new works or the extension or alteration of old ones.

Foundries and Works. - - Millville, Florence, and Camden, N. J.

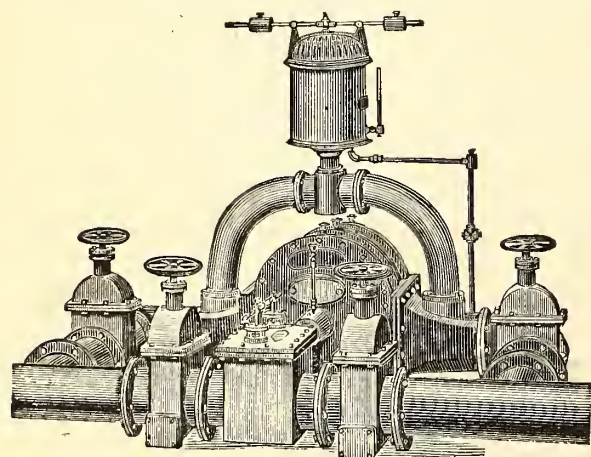

SMITH & SAYRE MFG. COMPANY,

G. G. PORTER, Prest.

245 Broadway, N. Y. CHAS. W. ISBELL, Sec'y.

Machinery & Apparatus for Gas Works

Drawings, Plans, and Estimates Furnished for the Improvement, Extension, or Alteration of Gas Works, or for the Construction of New Works.

Mackenzie's Patent Rotary and Steam Jet Gas Exhausters, Governors, Compensators, Condensers, Washers, Scrubbers. Isbell's Patent Automatic Street Pressure Governor, Gas and Water Valves, Hydraulic Main Dip Regulator, Bench Castings, etc. Purifying Boxes and "Standard" Scrubbers. Isbell's Patent Self-Sealing Retort Doors.

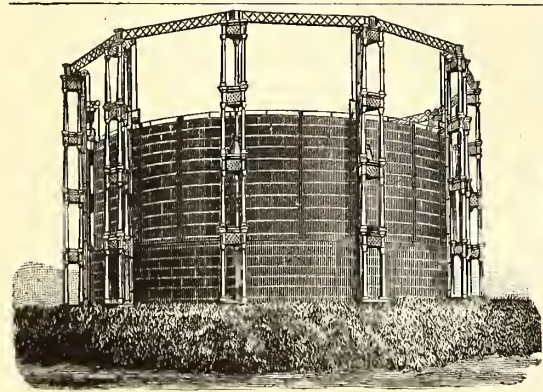

W. E. Tanner, Pres., W. R. Trigg, V.-Pres., A. Delaney, Supt.

Tanner & Delaney Engine Co. RICHMOND, VA.

Gas Apparatus,

INCLUDING

Condensers of various styles, Scrubbers, Holders, Purifiers, Castings for Retort Houses, Etc.

ALSO STEAM ENGINES AND BOILERS.
Plans, Specifications and Estimates Furnished.

MORRIS, TASKER & CO., Limited, Builders of Gas Works, PHILADELPHIA, PA.

To Gas Companies.

We make to order CAP BURNERS to burn any amount under a stated pressure. Send for samples.

Also, SERVICE CLEANERS, DRIP PUMPS, and STREET MAIN PROVING APPARATUS.

C. A. GEFROER,
248 N. 8th Street, Phila., Pa.

SOUTHWARK FOUNDRY AND MACHINE COMPANY,

Successors to MERRICK & SONS. Established in 1836.

No. 430 Washington Avenue, Philadelphia, Pa.

MANUFACTURERS OF

Single and Telescopic Gasholders,

BENCH CASTINGS,

Washers, Scrubbers, Condensers, Purifiers,

And all apparatus necessary for the construction of improved new gas works and in the extension of established works. Also manufacturers of

Gas Engines, and of all descriptions of Steam and Hydraulic Machinery, and of Boiler and Tank Work.
Plans, specifications, and estimates furnished promptly on application.

WM. HENRY WHITE, Consulting & Constructing Gas Engineer & Contractor.

ESTIMATES, PLANS, AND SPECIFICATIONS FURNISHED
FOR NEW WORKS OR EXTENSIONS OF
EXISTING WORKS.

32 Pine St., New York City.

Correspondence solicited.

KERR MURRAY MFG. CO.,

MANUFACTURERS OF

Single Lift and Telescopic

GASHOLDERS.

Built, 1884:

Altoona, Pa.....	Capacity, 160,000 cubic feet.
Pittsburgh, Pa.....	250,000 "
" ".....	220,000 "
Bellaire, Ohio.....	50,000 "
Youngstown, Ohio.....	60,000 "
Canton, ".....	60,000 "
Akron, ".....	80,000 "
Xenia, ".....	10,000 "
Adrian, Mich.....	65,000 "
Ypsilanti, Mich.....	25,000 "
Muskegon, ".....	70,000 "
South Bend, Ind.....	70,000 "
Anderson, ".....	20,000 "
Plainfield, ".....	10,000 "
Springfield, Illinois.....	100,000 "
Evanston, ".....	50,000 "
Freeport, ".....	35,000 "
Elgin, ".....	60,000 "
Sheboygan Wis.....	20,000 "
Key West Fla.....	10,000 "

Plans and estimates furnished for the erection of new and the rebuilding of old works. Address

Kerr Murray Mfg. Co.,
FORT WAYNE, IND.

JAMES R. FLOYD,

(SUCCESSOR TO HERRING & FLOYD)

Oregon Iron Works,

531 to 543 West 20th St., N. Y.

Practical Builders of Gas Works,

MANUFACTURERS OF

ALL KINDS OF CASTINGS

AND

APPARATUS FOR GAS-WORKS.

BENCH CASTINGS

from benches of one to six Retorts each.

WASHERS: MULTITUBULAR AND AIR CONDENSERS; CONDENSERS; SCRUBBERS

wet and dry, and

EXHAUSTERS

for relieving Retorts from pressure.

BENDS and BRANCHES

of all sizes and description.

FLOYD'S PATENT

MALLEABLE RETORT LID.

PATENT

SELF-SEALING RETORT LIDS.

FARMER'S

PATENT BYE-PASS DIP-PIPE.

SABBATON'S PATENT

FURNACE DOOR AND FRAME.

BULLER'S

COKE SCREENING SHOVELS.

GAS GOVERNORS,

and everything connected with well regulated Gas Works at low price, and in complete order.

SELLER'S CEMENT

for stopping leaks in Retorts.

N. B.—STOP VALVES from three to thirty inches—

at very low prices.

Plans, Specifications, and Estimates furnished.

CONTINENTAL WORKS.

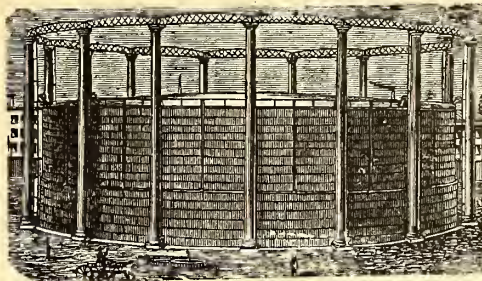

GASHOLDERS OF ANY MAGNITUDE.

T. F. ROWLAND, Proprietor,

GREENPOINT, BROOKLYN, N. Y.

ENGINEER AND MANUFACTURER OF

GAS-HOLDERS.

CONDENSERS, SCRUBBERS, VALVES,

PURIFIERS, RETORTS, and HY-

DRAULIC MAINS,

and all other articles connected with the Manufacture and Distribution of Gas. Plans and Specifications prepared and Proposals given for the necessary Plant for Lighting Cities, Towns, Mansions, and Manufactories.

H. RANSHAW, Prest. & Mangr. WM. STACEY, Vice-Pres. T. H. BIRCH, Asst. Mangr. R. J. TARVIN, Sec. & Treas.

STACEY MFG. CO.,

MANUFACTURERS OF

Single and Telescopic Gasholders,

IRON ROOFS, BRIDGES, LAMP POSTS,

Water and Oil Tanks, Coal Elevator Cars,

COKE CRUSHERS, BENCH CASTINGS,

And all kinds of Wrought and Cast Iron Work used in the erection of Coal and Oil Gas Works. Rolling Mill Machinery and Heavy Castings a Specialty.

Foundry:

33, 35, 37 & 39 Mill Street.

Wrought Iron Works:

16, 18, 20, 22, 24 & 26 Ramsey Street.

Cincinnati, Ohio.

BARTLETT, HAYWARD & CO.,

Office, 24 Light.

BALTIMORE, MD.

Works, Pratt &

PURIFIERS.
Roofs.
Bench Castings.

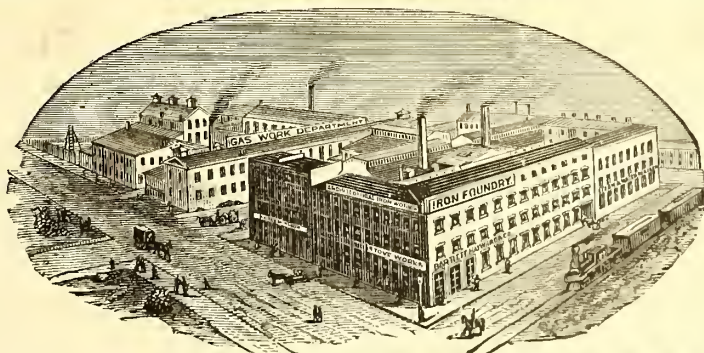

CONDENSERS.
BOILERS.
SCRUBBERS.

GASHOLDERS.

CONSTRUCTING ENGINEERS AND BUILDERS OF GAS WORKS.

1842. DEILY & FOWLER, 1884.

Laurel Iron Works.

Address, No. 39 Laurel Street, Philadelphia, Pa.

MANUFACTURERS OF

GASHOLDERS,

Single or Telescopic, with Cast or Wrought Iron Guide Frames.

HOLDERS BUILT SINCE 1880:

Mount Joy, Pa.	West Point, N. Y.	Galveston, Texas (3d.)	Kalamazoo, Mich. (3d.)	Newport, R. I.
Rockaway B'ch, N.Y. (2)	Fitchburgh, Mass.	Marlboro, Mass.	Glen Island, N. Y.	Portland, Oregon.
Zanesville, O. (2d.)	New London, Conn.	Denver, Col.	Warren, Ohio.	Allegheny, Pa. (3d.)
Lancaster, O.	Derby, Conn.	Chicago, Ill. (West Side).	Bath, N. Y.	Atlanta, Ga. (3d.)
Blackwell's Island N. Y.	Bridgeport, Conn.	Pittsburgh, Pa. (S. Side).	Lynn, Mass.	N.Y. City (Central Ga.)
Waltham, Mass. (1st.)	Allentown, Pa. (1st.)	Pawtucket, R. I.	New Bedford, Mass.	Lynchburg, Va. (2d.)
Dorchester, Mass.	St. Hyacinth, Can.	Brookline, Mass.	Waterbury, Conn.	Saylesville, R. I.
Wheeling, West Va.	Norwalk, O.	Sherbrooke, Can.	Deseranti, Can.	Rondont, N. Y.
Langsling, Mich.	Brattleboro, Vt.	Burlington, N. J. (2d.)	Hoosic Falls, N. Y. (3d.)	Atlantic City, N. J.
Flint, Mich.	Waltham, Mass (3d.)	Bridgeport, N. J.	Bethlehem, Pa.	Augusta, Ga.
Galveston, Texas (1st.)	West Chester, Pa.	Bay City, Mich.	Atlanta, Ga. (1st.)	Waltham, Mass. (2)
Milton, Pa.	Baltimore, Md.	Eric, Pa.	Savannah, Ga.	
Scranton, Pa.	Holidaysburg, Pa.	Jackson, Mich.	Montgomery, Ala.	

GAS COALS.

GAS COALS.

GAS COALS.

JAMES D. PERKINS.

PERKINS & CO.,

F. SEAVERNS.

General Sales Agents for

The Youghioghenny River Coal Company's OCEAN MINE YOUGHIOGHENY GAS COAL.

The Coal from the Ocean Mine (recently operated by Messrs. W. L. Scott & Co., of Erie, Pa.,) is now used by all the leading Gas Companies in the United States from Maine to Texas, and is recognized as *the only reliable Youghioghenny Gas Coal.* (See Map on p. 87 of this Journal, Feb. 16, 1885.)

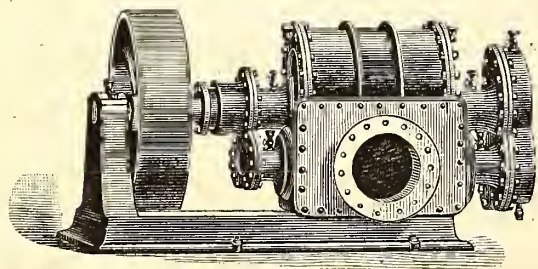
P. O. Box 3695,
New York.**PERKINS & CO., 228 and 229 N. Y. Produce Exchange****BEAVER STREET
ENTRANCE.**

Gas Exhauster Driven by Belt.

The Wilbraham Gas Exhauster,

"BAKER SYSTEM,"

WITH ENGINE ATTACHED, ON SAME BED PLATE OR WITHOUT.
Best, Cheapest and Most Durable Exhauster known.

WILBRAHAM BROS.,

No. 2320 Frankford Avenue, Philadelphia, Pa.

Chas. F. Dieterich's Regenerator Furnace.

CAN BE ADAPTED TO ANY BENCH WITHOUT DISTURBING THE ORDINARY SETTINGS.

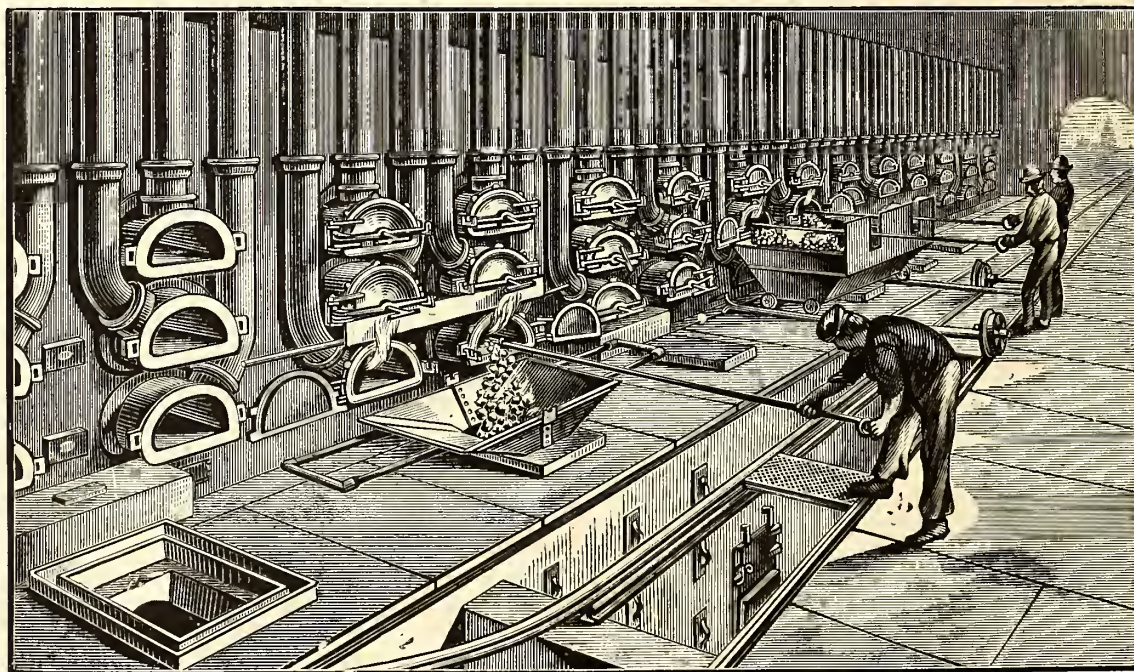

These Furnaces have been in operation at the works of the People's Gas Company, Baltimore, since June, 1878. A bench of sixes, with retorts 20 in. by 12 in. by 8 ft. 6 in. will burn off 1,350 pounds of coal in 3 hours. Twenty-five per cent. of the coke is sufficient to thoroughly burn off the charges.

We refer by permission to the following Companies who are using these Furnaces:

A. B. SLATER, Providence Gas Co. S. G. STINESS, Pawtucket Gas Co. JAS. H. ARMINGTON, Brooklyn Gas Lt. Co.

State, city, and factory rights granted on reasonable terms. For full particulars apply to

CHAS. F. DIETERICH, Engineer P. O. Box 512, BALTIMORE, MD.

GAS COALS.

GAS COALS.

GAS COALS.

Newburgh Orrel Coal Co.,

MINERS AND SHIPPERS OF

**Newburgh Orrel, Tyrconnell
and Palatine Gas Coals.**

ALSO SHIPPERS OF FOUNDRY COKE.

Mines Situated at

Newburgh, Flemington & Fairmont, W.Va.

HOME OFFICE,

25 S. Gay St., Baltimore.

**CHARLES MACKALL,
MANAGER.**

CHAS. W. HAYS, Agent in New York,

Room 92, WASHINGTON BUILDING, No. 1 Broadway.

Shipping wharves at Locust Point. References furnished when required. Special attention given to chartering vessels.

THE DESPARD COAL COMPANY

OFFER THEIR SUPERIOR

DESPARD COAL

To Gas Light Companies and Manufacturers of Fire Clay Goods
Throughout the Country.

ROUS EL & HICKS, } AGENTS. { BANGS & HORTON,
71 Broadway, N. Y. } 16 Kilby St., Boston.

Mines in Harrison Co., West Va. Wharves, Locust Point, Balt.

Company's Office, 15 German St., Baltimore, Md.

Among the consumers of Despard Coal we name: Manhattan Gas Light Co., N. Y.; Metropolitan Gas Light Co., N. Y.; Jersey City, (N. J.) Gas Light Co.; Washington (D. C.) Gas Light Co.; Portland (Maine) Gas Light Co. Reference to them is requested.

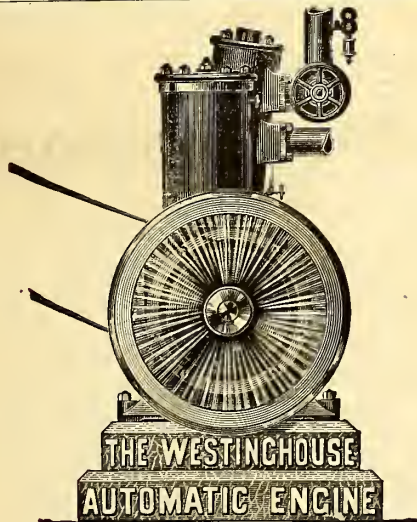

1,500 Engines Now in Use.

Our capacity being now equal to 100 Engines per month, we shall hereafter keep in stock for immediate shipment all sizes from 4 to 200 H.P.

SEND FOR ILLUSTRATED CIRCULAR AND REFERENCE LIST.

**Westinghouse Machine Co.,
PITTSBURCH, PA.**

SALES DEPARTMENT CONDUCTED BY

Westinghouse, Church, Kerr & Co., 17 Cortlandt Street, New York City.

Fairbanks, Morse & Co., Chicago, Cincinnati, Cleveland, Louisville, and St. Paul.

Fairbanks & Co., St. Louis, Indianapolis, and Denver.

Parke & Lacy, San Francisco, and Portland, Or.

Parke, Lacy & Co., Salt Lake City, Utah, and Butte, Montana.

D. A. Tompkins & Co., Charlotte, N. C.

Keating Implement & Machine Co., Dallas, Texas

Imray & Co., Sydney and Melbourne, Australia.

Robert Middleton, Mobile, Ala.

H. Dudley Coleman, 9 Perdido St., New Orleans, La.

R. Rogers, 43 Rue Laffitte, Paris.

**THE
PENN GAS COAL CO.**

OFFER THEIR

Coal, Carefully Screened & Prepared for Gas Purposes.

Their Property is located in the Youghioghny Coal Basin, near Irwin and Penn Stations on the Pennsylvania Railroad, and on the Youghioghny River.

Principal Office:

209 SOUTH THIRD STREET, PHILA., PA.

Points of Shipment:

Pennsylvania Railroad Piers; Greenwich Wharves, Delaware River; Pier No. 1 (Lower Side), South Amboy, N. J.

Chesapeake & Ohio Railway Coal Agency,

FOR THE SALE OF THE

**Superior Kanawha Gas Coals, Cannelton Cannel,
Also, SPLINT AND STEAM COALS,**

From the Kanawha and New River Regions, on the line of the Chesapeake & Ohio R'way.

C. B. ORCUTT, Sales Agent. | OFFICE, 150 BROADWAY, N. Y.

FRANCIS H. JACKSON, PRESIDENT.

EDMUND H. MCCULLOUGH, Sec. & TREAS.

THE WESTMORELAND COAL CO.

Chartered 1854.

**Mines situated on the Pennsylvania and the Baltimore
and Ohio Railroads, in Westmoreland County, Penn.**

POINTS OF SHIPMENT:

PHILADELPHIA, BALTIMORE, SOUTH AMBOY, N. J.
WATKINS (SENECA LAKE), N. Y.

Since the commencement of operations by this Company its well-known Coal has been largely used by the Gas Companies of New England and the Middle States, and its character is established as having no superior in gas-giving qualities, and in freedom from sulphur and other impurities.

Principal Office, 224 South 3d St., Phila., Pa.

The Management of Small Gas Works.

By C. J. R. HUMPHREYS. Price, \$1.

A. M. CALLENDER & CO., 42 Pine St., N. Y.

**CATHELL'S
Gas Consumer's Manual.**

Enables every gas consumer to ascertain at a glance, without any previous knowledge of the gas meter, the quantity and money value of the gas consumed. Also the best method of obtaining from gas the largest amount of its light. It will be to the advantage of Gas Companies to supply their consumers with one of these Guides, as a means of preventing complaint arising from their want of knowledge in regard to the registration of meters.

A. M. CALLENDER & CO., 42 Pine St., N. Y.

King's Treatise on Coal Gas.

The most complete work on Coal Gas ever published.

Three Vols. Bound, \$30.

A. M. CALLENDER & CO., 42 Pine St., N. Y.

**AMERICAN
GAS LIGHT JOURNAL.**

\$3.00 per Annum.

**A. M. CALLENDER & CO.,
42 Pine Street, N. Y. City.**



INTERNATIONAL--1876--EXHIBITION.

The U. S. Centennial Commission

HAVE DECREED AN AWARD TO

HARRIS, GRIFFIN & CO.,

Twelfth and Brown Streets, Philadelphia, Pa., No. 49 Dey Street, N. Y. City, and No. 75 North Clinton Street, Chicago, Ill.,

FOR THE FOLLOWING REASONS :

The Exhibit consists of a Series of METERS from the Largest Size Station Meters for the use of the MANUFACTURE OF GAS, to those for the use of the ORDINARY CONSUMER. The Instruments are WELL MADE, RELIABLE as to INDICATION, and embody a number of sundry improvements which, with the general character of the Exhibit, entitle the whole to commendation.

Attest—J. L. CAMPBELL,
Secretary, pro-tem.Signed—A. T. GOSHORN,
Director GeneralJ. R. HAWLEY,
President

CHARLES E. DICKEY.

JAMES B. SMALLWOOD.

CHARLES H. DICKEY.

Maryland Meter and Manufacturing Co.,**DICKEY, TANSLEY & CO.,**

Established 1866.

Nos. 22 and 24 Saratoga Street, Baltimore, Md.

No. 46 La Salle St., Chicago, Ill.

MANUFACTURERS OF

DRY GAS METERS, STATION METERS, GLAZED METERS, TEST METERS, METER PROVERS, PRESSURE AND VACUUM REGISTERS, GOVERNORS, INDICATORS, SERVICE AND METER COCKS, AND METER CONNECTIONS.

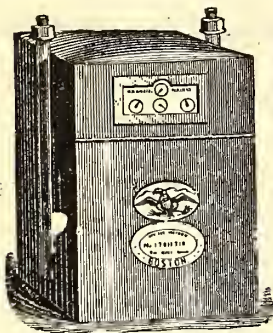

Dry Gas Meter.

With 39 years' experience and the best facilities for manufacturing, is enabled to furnish reliable work and answer orders promptly.

NATHANIEL TUFTS,

No. 153 Franklin Street, Boston, Mass.,

MANUFACTURER OF

DRY GAS METERS.

Station Meters of any Capacity.

Test and Experimental Meters, Pressure Registers, Pressure Gauges, Pressure and Vacuum Gauges.

METER PROVERS, PHOTOMETERS, STREET LANTERNS, ETC., ETC.

Patent Cluster Lanterns for Street Illumination.

SCIENTIFIC BOOKS.

We are prepared to furnish to Gas Managers, and others interested in the topics treated of, the following books, at prices named :

KING'S TREATISE ON THE MANUFACTURE OF COAL GAS. Three vols.; \$10 per vol.

GAS MANUFACTURE, by WILLIAM RICHARDS. 4to., with numerous Engravings and Plates, in Cloth binding. \$12.

THE GAS ANALYST'S MANUAL, by F. W. HARTLEY. \$2.50.

ANALYSIS, TECHNICAL VALUATION, PURIFICATION, and USE OF COAL GAS, by REV. W. R. BOWDITCH, M.A.; with Engravings; 8vo., Cloth. \$4.50.

GAS MEASUREMENT AND GAS METER TESTING by F. W. HARTLEY. \$1.60

GAS CONSUMER'S HANDBOOK, by WILLIAM RICHARDS, C.E.; 18mo., Sewed. 20 cents.

GAS CONSUMER'S MANUAL, by E. S. CATHELS, C.E. 10 cts.

PRACTICAL TREATISE ON HEAT, by THOMAS BOX. Second edition. \$5.

GAS WORKS—THEIR ARRANGEMENT, CONSTRUCTION, PLANT, AND MACHINERY. \$8.

COAL; ITS HISTORY AND USE, by PROF. THORPE. \$3.50.

THE GAS WORKS OF LONDON, by COLBURN. 60 cents.

THE GAS FITTER'S GUIDE, Showing the Principles and Practice of Lighting with Coal Gas, by JOHN ELDREDGE. 40 cents.

GAS WORKS, AND MANUFACTURING COAL GAS, HUGHES. \$2.20.

THE MANAGEMENT OF SMALL GAS WORKS, by C. J. R. HUMPHREYS. \$1.

A PRACTICAL TREATISE ON GAS AND VENTILATION with Special Relation to Illuminating, Heating, and Cooking by Gas, by E. E. PERKINS. \$1.25.

PURIFICATION OF COAL GAS, by R. P. SPICE. 8vo. \$3.

HOW TO MANAGE GAS, by F. WILKINS. Paper. 20 cents.

THE GAS MANAGER IN THE LABORATORY, by a Practical Student. 8vo., Cloth. \$1.50.

THE DOMESTIC USES OF COAL GAS, AS APPLIED TO LIGHTING, by W. SUGG. \$1.40.

DISTILLATION OF COAL TAR AND AMMONIACAL LIQUOR, by GEO. LUNGE. \$8.50.

A TREATISE ON THE COMPARATIVE COMMERCIAL VALUES OF GAS COALS AND CANNELS, by D. A. GRAHAM 8vo., Cloth. \$3.

The above will be forwarded by express, upon receipt of price. We take especial pains in securing and forwarding any other Works that may be desired, upon receipt of order. All remittances should be made by check, draft, or post office money order.

A. M. CALLENDER & CO., No. 42 Pine Street, New York.

T. C. HOPPER, Pres. G. J. MCGOURKEY, Vice-Pres. (New York). WM. N. MILSTED, Gen. Supt. & Treas. (New York). WM. H. DOWN Sec.

AMERICAN METER COMPANY,

WET AND DRY GAS METERS. STATION METERS. EXHAUSTER GOVERNORS. DRY CENTRE VALVES. GOVERNORS FOR GAS WORKS.

PRESSURE REGISTERS. PRESSURE & VACUUM REGISTERS. PRESSURE & VACUUM GAUGES. CRESSON GAS REGULATORS. MARSLAND WATER METERS.

METER PROVERS. PORTABLE TEST METERS. EXPERIMENTAL METERS. AMMONIA TEST METERS. BAR AND JET PHOTOMETERS.

Manufactories:
512 W. 22d St., N. Y.
Arch & 22d Sts., Phila.

GAS STOVES,
SUGG'S "STANDARD" ARGAND BURNERS,
SUGG'S ILLUMINATING POWER METER,
Wet Meters, with Lizar's "Invariable Measuring" Drum.

Agencies:
177 Elm Street, Cincinnati.
244 & 246 N. Wells Street, Chicago.
810 North Second Street, St. Louis.
122 & 124 Sutter St., San Francisco.

HELME & McILHENNY,

(Successors to Harris & Brother. Established 1848.)

GAS METER MANUFACTURERS,

CONTINUE AS HERETOFORE AT THE OLD ESTABLISHMENT,

Nos. 1115 and 1117 Cherry Street, Philadelphia, Pa.,

To Manufacture Wet and Dry Gas Meters, Station Meters, Experimental Meters, Meter Provers, Center Seals, Pressure Registers, GOVERNORS, INDICATORS, PHOTOMETERS, & ALL OTHER KINDS OF APPARATUS FOR USE IN GAS WORKS.

From our long practical experience of the business, and from our personal supervision of all work, we can guarantee all orders to be executed promptly, and in every respect satisfactorily.

WM. WALLACE GOODWIN, Prest. and Treas.

WM. H. MERRICK, V.-Prest.

S. L. JONES, Sec.

S. V. MERRICK, Supt.

THE GOODWIN GAS STOVE AND METER COMPANY,

Successors to W. W. GOODWIN & CO.

1012, 1014 and 1016 Filbert St., Phila., Pa. 142 Chambers St., New York.
76 Dearborn St., Chicago, Ill.

WALDO BROS., Agents, 88 Water St., Boston.

MANUFACTURERS OF THE "SUN DIAL" GAS STOVES, FOR COOKING AND HEATING PURPOSES.

Dry and Wet GAS METERS, Station Meters (Square, Cylindrical or in Staves) Glazed Meters, King's and Sugg's Experimental Meters, Lamp Post Meters, Etc., Etc., Meter Provers (sizes 2, 5 and 10 feet), Pressure Guages of all kinds, Pressure Registers, Pressure and Vacuum Registers, Pressure Indicators (sizes 4 inch, 6 inch and 9 inch), King's Pressure and Vacuum Gauges, Dry and Wet Centre Seals, Dry and Wet Governors, Exhauster Governors, Photometers of all descriptions. Letheby's Sulphur and Ammonia Test Apparatus complete—also Testing and Chemical Apparatus of all kinds, and of the most perfect description, for all purposes relating to Gas.

GOODWIN'S IMPROVED LOWE'S JET PHOTOMETER.

Agents for Bray's Patent Gas Burners and Lanterns.

Special attention to repairs of Meters, and all apparatus connected with the business.
All work guaranteed first class in every particular, and orders filled promptly.

G. B. EDWARDS, Mang'r, New York.
E. H. B. TWINING, Mang'r, Chicago.
A. B. STANNARD, Agent.

D. McDONALD & CO.,

GAS METER MANUFACTURERS.

(Established 1854.)

51 Lancaster St., Albany, N. Y. 34 & 36 West Monroe St., Chicago, Ill.

STATION METERS, EXPERIMENTAL METERS, METER PROVERS, PRESSURE & VACUUM REGISTERS, PRESSURE GAUGES, ETC.

Also STAR GAS STOVES, RANGES, and HEATING STOVES.

We use only the very best materials, and employ the most skilled labor, and by our long experience (29 years) and personal supervision of every detail, we feel justified in assuring the public that our goods will give perfect satisfaction. Every Meter emanating from our establishment will bear the State Inspector's Badge, and will be fully warranted by us. Our Annual and Calendar will be sent to Gas Companies upon application.

KING'S TREATISE ON COAL GAS.

The most complete work on Coal Gas ever published. Three vols., bound, \$30.

A. M. CALLENDER & CO., No. 42 Pine Street, New York.

THE "OTTO" GAS ENGINE.

Guaranteed to Consume 25 to 75
Per Cent. LESS GAS than ANY OTHER GAS ENGINE
PER BRAKE HORSE POWER.

TWIN ENGINES Impulse every revolution.
THE STEADIEST RUNNING GAS ENGINE YET MADE.

ENGINES AND PUMPS COMBINED,

For Hydraulic Elevators, Town Water Supply, or Railway Service.

Special Engines for Electric Light Work.

OVER 15,000
IN USE.

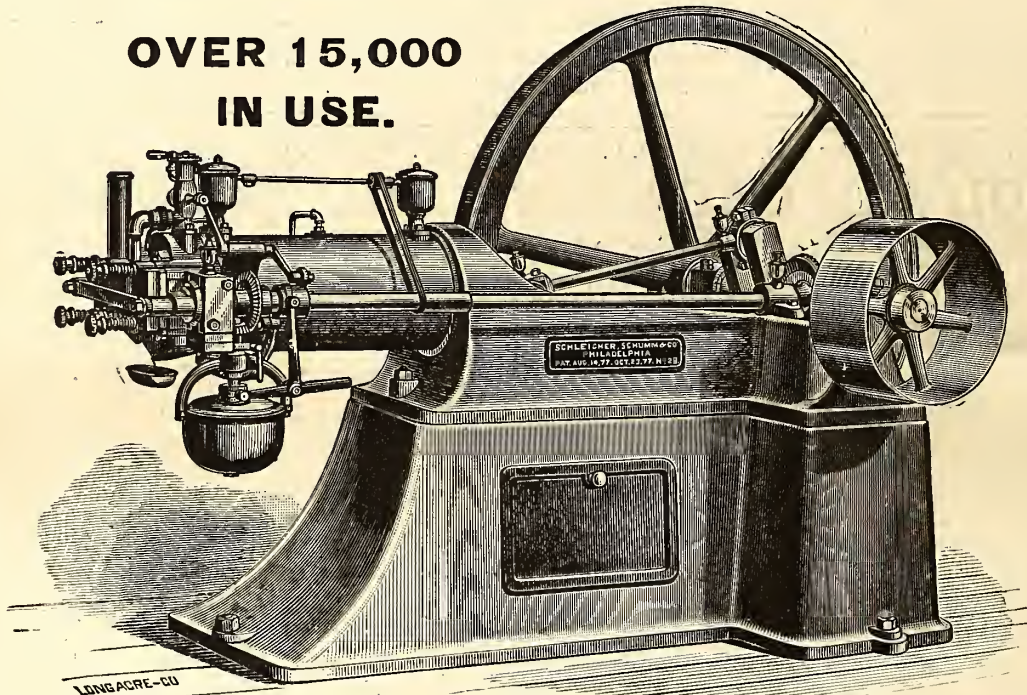

The Otto Gas Engine is now consuming, at a moderate computation, 2000 millions cubic feet of gas per year, nearly all of which is furnished during day time only.

**THE ONLY HIGHEST AWARD, ONLY GOLD MEDAL,
AT ELECTRICAL EXHIBITION, PARIS, 1881.**

MADE IN SIZES FROM 1 TO 25 HP. INDICATED.

FOR PARTICULARS, PRICES, ETC., APPLY TO

SCHLEICHER, SCHUMM & CO.,

Works:

N. E. Cor. 33d & Walnut Sts., Phila., Pa.

Branch Office:

214 Randolph Street, Chicago, Ill.

THE AMERICAN GAS LIGHT JOURNAL

PUBLISHING OFFICE NO. 42 PINE STREET

DEVOTED TO THE INTERESTS OF ILLUMINATION, VENTILATION, WATER SUPPLY AND DISTRIBUTION, & GENERAL SCIENCE.

VOLUME XLIII.—No. 3.
Whole No. 627.

NEW YORK, MONDAY, AUGUST 3, 1885.

\$3 PER ANNUM
IN ADVANCE.

A. M. CALLENDER & CO., Proprietors. C. E. SANDERSON, Manager.
JOS. R. THOMAS, C.E., Editor.

ENTERED AT THE POST OFFICE AT NEW YORK, N. Y.
AS SECOND CLASS MATTER.

Published on the 2d and 16th of each month, at No. 42 Pine Street, N. Y.

Terms of Subscription, Including Postage.—For the United States and Canada, \$3 per annum. European countries, \$3.50 (15 shillings—18 francs). All payments to be made in advance. Single copies, 15 cents.

Remittances should be made either by post-office order, registered letter, or bank draft on New York, payable to the order of A. M. Callender & Co.

Collections are invariably made directly from this office, for subscriptions, advertisements, etc. We have agents to solicit the same, but they are not authorized to receipt for money.

Correspondence.—Wishing to make this JOURNAL a gazette of intelligent discussion to those of our readers who may wish to gain or give information on the subjects to which its columns are devoted, correspondence is solicited for publication from all who make the study of those subjects a pleasure or a profession.

The American News Company, Nos. 39 and 41 Chambers street, New York, are agents for this JOURNAL. Newsdealers will send orders to them.

Books.—We will mail, post-paid, at publisher's lowest rates, any book—scientific or otherwise—to any address in the United States or Canada. No books will be sent C. O. D.

CONTENTS.

An Asterisk (*) denotes an illustrated article.

Official Circular and Letter of Invitation, Iowa Gas Association..... 57

EDITORIALS—

Electric Lighting at Lawrence, Mass..... 58

A Disastrous Pleasure Trip..... 58

Eighth Annual Meeting of the Western Gas Association—Official Report—Continued from page 36..... 59

Second Day, Morning Session—Treasurer's Report—In the Matter of Annual Banquets—Report of Committee on the Formation of Gas Commissions—Success in the Gas Business; Amenity a Requisite, by E. Lindsley—Discussion—Gas Bills vs. Gas Light, by Byron E. Chollar—Discussion—The Cooper Coal Lining Process, by G. Shepard Page.

Condensation, or, the Elimination of Tar from Coal Gas, by A. B.

Slater..... 65

Special English Correspondence..... 66

The Use of Sulphate of Ammonia as a Manure..... 67

ITEMS OF INTEREST FROM VARIOUS LOCALITIES..... 67

Gas Rates at Beaver Falls, Pa.—Personal—Of Interest to Contractors—We do not Charge Them for This—Our Alert Health Board—Cheaper Gas for Altoona, Pa.—Shutting Down a Gas Works—They Did Not Shut Down—Putting it in Plain Terms—Projected Opposition at Albany, N. Y.—Promoted—Awarded a Contract—Cheaper Gas for Lawrence, Mass.—Baxter Beat Them—The Circleville (Ohio) Gas Light Company Vanquishes the Electrical Promoters—Fatal Accident—Carbonic Oxide was the Cause—Nothing New in the Dunbar Case—Cheaper Gas for Nashua, N. H.—Appointing a Massachusetts Board of Gas Commissioners—An Amusing Interview—Another Death—Determining the Increase of the Earth's Temperature Toward Its Interior.

The Market for Gas Securities 70

[OFFICIAL CIRCULAR.]

Iowa Gas Association.

By invitation of Mr. A. T. Averill, of the Cedar Rapids Gas Company, the following gentlemen met at the Grand Hotel, in Cedar Rapids, on December 17, 1884, to consider the propriety of organizing for the mutual advantage of the gas interests of this State:

W. A. Agard.....	Des Moines.
A. T. Averill	Cedar Rapids.
J. B. Howard.....	Dubuque.
C. Weare.....	Marshalltown.
L. H. Ellsworth.....	Ottumwa.
J. N. Coldron.....	Iowa City.
C. L. Williams.....	Cedar Rapids.
— Moore.....	Fairfield.
— Bowen.....	Oskaloosa.
R. Spencer.....	Burlington.

Omitting details—the question was fully considered, and it was unanimously agreed that we organize under the name of the "Iowa Gas Association," which was done by electing R. Spencer, of Burlington, President, and C. L. Williams, of Cedar Rapids, Secretary.

It was also decided to hold the next meeting at Burlington, on the third Wednesday (16th) of September, 1885, and the President was directed to give notice to the gas men of the State, cordially inviting all to attend and co-operate with us in this desirable undertaking.

In accordance with the above, the undersigned has issued this and the inclosed circular of invitation, and has sent copies of the same to such addresses as could be obtained.

We should be glad if persons receiving this circular would, in answering, give names of those in their neighboring towns who may not be known to us, to the end that none may fail to receive invitations.

Respectfully,

R. SPENCER, President.

LETTER OF INVITATION.

BURLINGTON, IOWA, July, 1885.

MR.....

DEAR SIR:—You are hereby cordially invited to meet your brethren of the gas fraternity of the State of Iowa, at Burlington, on the third Wednesday (16th) of September, next, to complete the organization of the Iowa Gas Association, to confer together upon matters of interest connected with the gas business in this State, and to promote a more intimate acquaintance and fraternal relationship than has heretofore existed among us.

The meeting will be organized at 10 o'clock A.M., at the Barret House, where provision has been made for the accommodation of all.

Please be good enough to indicate by letter, addressed to the undersigned at an early date, of the acceptance of this invitation.

R. SPENCER, President.

ELECTRIC LIGHTING AT LAWRENCE, MASS.

Edison and his followers are in their element when trying to carry out some scheme the distinguishing feature of which is its novelty; that it has or has not any inherent worth is of no consideration; that it possesses any value to mankind, or be totally void in this regard, or whether the carrying out of the scheme will be remunerative in a commercial sense, are matters of no importance so long as the scheme has the charm of novelty. How many exemplifications of this statement do we find in the history of the many enterprises emanating from the "magician" of Menlo Park. Let one example suffice—the scheme of lighting New York city by the incandescent lights from central stations. That the idea appeared on the face of it to be without commercial value was, in the opinions of the Edisonians, of no moment when contrasted with the extreme novelty of the scheme; so one central station was established, but we do not see that anyone has been benefited by the enterprise.

The latest illustration of the Edisonian love for the novel and the marvelous comes to us from the thriving city of Lawrence, Mass., where there is a company engaged in lighting some of the stores and buildings on the main street, by the Edison lamps, fed from a central station. The latest craze consists of a proposition made by this company to the city government to do all the lighting of the public lamps, both gas and oil, by the incandescent electric lamps. Was there ever anything so charmingly unique as this idea? Heretofore sane men have argued that as the arc light was cheaper than the glow lamps, and as gas was less expensive than the former, it naturally followed that the incandescent lamp was dearer than gas. But the disciples of Edison are above such common sense considerations as these, hence their proposition to illuminate the streets of Lawrence. In their letter to the Board of Aldermen they proposed to replace all the gas and oil lamps throughout the city—about 500 in all—with the electric light, and to supply the current to the same; one hundred of them to be kept lit all night, the balance till 11 o'clock, for the sum of \$650 a month.

At the hearing on this matter before the City Council the agent of the electric light company dwelt upon the novelty of the plan. The street lamps would be divided into six circuits, each one of which would be lighted and extinguished instantly from the central station; so, in case of a fire occurring in any part of the city after eleven o'clock, the lights in that section could be turned on immediately; or in case of a riot, the streets could be illuminated at once. Further, the streets would be much more brilliant if the electric light were used, according to the witness, and the process of reasoning by which this point was established (?) was decidedly Edisonian; for the gentleman argued as the State law requires gas companies to make gas of 15-candle power when burned from an Argand burner; therefore four feet of gas consumed through a batswing burner would give a light of eight and three-fourths-candles.

On cross-examination by the counsel of the gas company the witness admitted that he had not obtained his information on this point from personal experiments, but had acquired his knowledge from his general reading. He also admitted that the wires to the electric lights would be on the overhead system—that is, stretched on poles. He likewise, in answer to further questions, stated that it would take about thirty miles of wire to reach all the lamps. He was then questioned sharply as to the purposes of the company—if it were not their intention as soon as the wires were stretched through the streets to use them for lighting houses, but he insisted that was no part of their plan, as the street lighting system was not applicable to interior illumination. In continuation, he asserted that not even the poles could be used for the purpose of carrying wires for house lighting requirements, as they were not heavy enough. For the street lighting system only one wire is necessary, as the high current is employed, but several wires are required for inside lighting.

In answer to another question he was, and with a sorrowfully reluctant manner, compelled to admit that the system was not in use anywhere in New England; but immediately sought to soften the asperity of that confession by stating that "a town in Maryland" had adopted it, and the Lockport (N. Y.) gas company used it for lighting the lamps in the suburbs, or in those situations not reached by the gas mains.

One of the directors of the Edison Company then took the stand and held forth on the darkness of the streets at night, by reason of the lamps not being lighted when the moon was shining according to the almanac, but was actually obscured by clouds; and also on account of the dirty condition of the globes and lanterns.

Mr. Humphreys, the agent of the gas company, then took the stand, and quickly demolished the former witnesses' testimony on the amount of light to be obtained from four feet of gas. Mr. Humphreys stated that his company did not hide behind the State law and supply a 15-candle gas, but sold a gas of from 18½ to 19½ candles; and therefore four feet of gas would give a light of over 15 candles instead of 8½ candles.

Mr. Humphreys explained fully that his company was in no wise respons-

ible for the poor lighting of the thoroughfares, as the care of the lamps was entirely in the hands of the city, who lit and extinguished the lamps at their own pleasure, and cleaned or failed to clean the glass and burners. These were matters which were entirely beyond the control of the gas company; all that the latter did was to supply the gas to the lamps; the time of lighting and putting out was under the control of the street commissioner, who at the end of each month rendered the gas company a memorandum of the number of hours the lamps were lighted, and from this statement the bills for the gas used by the lamps were made out. Thus the entire matter of lighting was in the hands of the city, and if the work had not been properly performed the city had no one but itself to blame.

Mr. Humphreys also called attention to the fact that the gas company had frequently endeavored to get the city to adopt some better system for lighting and caring for the gas lamps, but without success.

Mr. Humphreys also exploded the theory, advanced by the Edisonians, that the adoption of the electric light would be of benefit to the city from a pecuniary standpoint, by showing that heretofore the main expense of the lighting department was for labor, etc., and not for the gas itself; that of the \$9,000 expended by the department last year the gas company received only about \$3,500. This matter of attendance, in Mr. Humphreys' opinion, cost the city too much; and to show that he had the courage of his opinion, he submitted a formal proposition to the City Council, to the effect that the gas company would light and take entire charge of all the gas and oil lamps throughout the city, do all the lighting and extinguishing, and make all repairs, for the sum of \$500 per month. Consequently the proposition of the electric light company, instead of resulting in a saving to the city, if accepted, would be an actual extravagance; for by the proposition of the gas company the latter would supply a better illumination than that furnished by the electric light folks, at a saving to the city of \$1,800 per year.

However, the love for the new and marvelous had extended to the Council; for, though every point advanced by the electric people was fully met by the evidence of Mr. Humphreys, yet the authorities, on the very evening of the hearing—without so much as sleeping on the proposition of the gas company—accepted the offer of the Edison Company, which was, as before stated, to do the street lighting for \$650 per month, the contract to run for five years.

The Edison people have not yet, we understand, commenced the erection of the posts, and we do not think anyone will be benefited if they do commence, unless it be some stockholder who may take advantage of the occasion to get from under.

A DISASTROUS PLEASURE TRIP.

At about half past four o'clock on the afternoon of Sunday, July 12th, the steam pleasure yacht Minnie Cook, while cruising on Lake Minnetonka, Minn., was overtaken by a severe storm of wind and rain. The yacht was overturned, and her occupants (with one exception) lost their lives. The persons comprising the ill-fated party consisted of Mr. and Mrs. A. C. Rand, their sons, Harvey and Frank (the former succeeded in reaching shore), Mr. and Mrs. Jno. R. Coykendall, Miss Kate Coykendall, and Geo. McDonald—the last named was the engineer in charge of the pleasure boat. Mr. A. C. Rand was well known to the gas fraternity of this country, his principal fame arising from his connection with the largely-advertised patented process of gas manufacture called the Gale and Rand. It will be remembered that this system attracted much attention at the hands of American gas engineers some twelve or fifteen years ago, and although its claimed merit was subsequently shown to be but vague, it is matter of common understanding that its monetary value to Messrs. Gale and Rand was eminently substantial.

After disposing of his interest in the above-named patented rights, Mr. Rand became connected with the Minneapolis (Minn.) Gas Light Company—the exact date of his accession to that company is unknown to us, save that it occurred between the years of 1875 and '78—acting as President and Treasurer of the corporation. Subsequently Mr. H. W. Brown was made Treasurer, Mr. Rand, as before, occupying the presidential chair. Deceased was a very popular citizen of Minneapolis, and served two terms as Mayor of that city. He was genial in manner, and had the happy knack of making friends and keeping them; but as honest chroniclers of gas history we are obliged to record that much of the present piracy in the business of gas manufacture may be traced back to him; for it was his fertile brain that originated the scheme of offering a gas company the choice of purchasing the patent rights, or else taking the chances presented by an opposition war of rates. The best evidence we can give regarding the intrinsic worth of the Gale and Rand patents is submitted when we call attention to the fact that coal gas is and has been made at Minneapolis. Be that as it may, the dreadful accident that brought such disaster to the Rand household cannot fail to arouse the most sincere regret, and friend and foe will alike join in tendering sympathy to the survivors of that afflicted family.

[OFFICIAL REPORT—Continued from page 36.]

Eighth Annual Meeting of the Western Gas Association.

HELD AT THE TREMONT HOUSE, CHICAGO, ILLS., MAY 13, 14, and 15, 1885.

SECOND DAY—MORNING SESSION.

The President's gavel rapped for order at 9:30 o'clock on morning of second day (Thursday, May 14), and proceedings were commenced by the presentation of Secretary and Treasurer's annual report, which was as follows:

TREASURER'S REPORT.

Receipts.

To balance from 1884.....	\$272 05
“ annual dues.....	327 00
“ initiation fees.....	175 00
	\$774 05

Expenditures.

By Secretary's salary.....	\$250 00
“ stenographic report proceedings Seventh Annual Meeting.....	162 50
“ printing of bye-laws (250 copies).....	31 50
“ membership, etc., badges.....	36 55
“ miscellaneous printing, stationery, supplies, expressage, postage, etc.....	35 00
	\$515 55

Balance on hand May 1, 1885..... 258 50

Total..... \$774 05

Mr. J. B. Howard, on behalf of Auditing Committee, reported that the Treasurer's statement and vouchers therefor had been duly audited; the accounts had been rendered in proper order, and everything relating to the duties of Mr. Littleton's dual office were found in perfect condition. On motion, the report (as also the certification of Auditing Committee) was accepted and filed.

IN THE MATTER OF ANNUAL BANQUETS.

Mr. G. A. Hyde, Sr., offered the following:

Resolved, That while we present our most hearty thanks to our friends and associates in the different cities in which we have held our past conventions, for their great courtesy in providing bountiful banquets for the gratification of the inner man, we feel that the practice imposes upon them an excessive expense, and for which they receive no adequate return. As we meet expressly for mutual interchange of practical experience on subjects pertaining to our business, and not for feasting, therefore be it further

Resolved, That we do most earnestly and positively request that in the future the banquet feature of our meetings be omitted.

The mover of the resolution thus further explained himself: With reference to this topic, speaking for myself, I hope the present banqueting system be done away with. As the resolution states, the feature is the cause of unnecessary expense to our entertainers; and if the members must have a banquet let them be assessed so much per plate for it. I am opposed to the idea of banquets at these annual gatherings.

Mr. Spencer, of Burlington, Iowa, seconded the resolutions, and the discussion now became general. Mr. Scofield favored the resolutions; Messrs. Howard, H. E. Clarke, T. Smith, H. Pratt, W. McDonald, the Chairman, G. G. Ramsdell, and E. J. King were decidedly in favor of the annual banquet, although the greater number of these speakers thought the annual entertainment should be given by the Association itself. Mr. Pratt offered, as an amendment to the original resolutions, the following:

Resolved, That while the Western Gas Association appreciates and desires to continue the good effects of the social features of the annual meeting, it is its opinion that hereafter they should be at the expense of the Association.

Mr. Pratt, continuing, said: That resolution will effectually do away with the objection urged by some of the speakers, while at the same time it will not prevent our annual social gathering.

The President—Does Mr. Hyde accept that as a substitute for his resolution, or does he prefer that it should be treated as an amendment?

Mr. Hyde—Personally I have no objection; I simply desired to bring the matter before the Convention.

The President—Then I will put the question as an amendment to the original resolution.

A vote was taken, and the President declared that he was unable to determine the result. A division was then called for. Before roll call could be proceeded with Mr. Spencer moved that the entire question be tabled. The motion was carried without a dissenting voice.

REPORT OF COMMITTEE ON THE FORMATION OF GAS COMMISSIONS.

The President—We will now listen to a report from the committee appointed to consider the topic of “gas commissions.”

Mr. E. J. King, of Jacksonville, Ills., then read the following report:

Your committee beg leave to report, and respectfully recommend, that the President, before final adjournment, be empowered to appoint a committee of three, whose duty it shall be to as thoroughly as possible investigate this subject, and report their conclusions thereon at the next annual meeting. We deem this matter of such importance as to demand more careful and serious investigation than can be given it at this meeting.

E. J. KING, G. G. RAMSDELL, CARROLL COLLINS, G. A. HYDE, SR., Z. T. F. RUNNER,	}	Committee.
--	---	------------

On motion, the report was received and the contained recommendations adopted.

The President subsequently named the following gentlemen as the members to compose the special committee of three: Messrs. Samuel Prichitt, Nashville, Tenn.; Geo. G. Ramsdell, Vincennes, Ind.; and T. A. Cosgrove, Evanston, Ills.

Mr. Edward Lindsley, of Cleveland, Ohio, then claimed the attention of the Association with a reading of the following paper, entitled—

SUCCESS IN THE GAS BUSINESS—AMENITY A REQUISITE.

Mr. President and Gentlemen of the Association:—It has been frequently and broadly stated that the dividends of a gas enterprise are made in the retort house; and it is presumed that no one competent to appreciate the force of the remark will deny the necessity for exercising the utmost care in the conduct of this initiatory department of the business, or fail to recognize the need for similar care in the after processes, even to the final delivery of the main product through the consumer's meter, nor forget to bestow such consideration upon the bye-products as the circumstances in individual cases may warrant.

It has been the writer's good fortune, while attending the sessions of this and other gas associations, to listen to the reading of many valuable practical papers, and of often hearing the no less valuable discussion which followed; while after-reflection upon both has frequently provoked still further elaboration of the ideas then presented.

It is hoped, however, that it will not be construed as an adverse criticism if the thought is indulged that, to a listener unacquainted with the details of our profession, it might almost appear that upon the details of manufacture and distribution (mechanical, scientific, and otherwise) mainly depend the successes of gas enterprises. That these are matters of the gravest importance, and that in proportion to neglect thereof is success imperiled, none will attempt to deny. But, on the other hand, it has been forcibly suggested to the writer—and probably to all present—that, with every detail of manufacture and distribution carefully carried out, there still remains a something beyond upon which largely depends *complete* success. May I call it *amenity*—which Webster defines as “the quality of being pleasant or agreeable, whether in respect to situation, climate, manners, or disposition.”

May I inquire—Is it not the very essence of that highly desirable qualification of the business man, known as a good address, which to its possessor is a key to the grace, goodwill, favor, and confidence of his fellows, opening up to him what would be otherwise, or without it, the closed door to success? As a factor of success in our business does it not embrace the idea of the necessity of a proper relation between the company and the consumer—each toward the other, and without which the highest success may not be achieved?

It is not at all in the mind of the writer to attempt the presentation of any radically new idea in this connection; but it is recognized that many commonplace, yet essential, matters often fail of the consideration their importance demands, by virtue of the fact that they are so familiar—and this suggests my apology, if it be necessary to make one, for presuming to present so commonplace a subject for your consideration. Permit me, then, the question, “What sometimes is, and, on the other hand, what ought to be, the attitude of the company and consumer towards each other; and how shall the latter be attained?”

As a preface to the consideration of the first part of our tripartite question, it may be said that gas, from being a luxury, has become almost a necessity where its use is at all attainable; and from being an expensive article it has become, comparatively and almost universally, cheap, with a tendency to become still cheaper. A more thoroughly convenient thing could hardly be imagined for the uses to which it has been applied. Yet, in a sense, this very convenience works to its disadvantage. The minimum of physical exertion and a friction match, or the weight of a finger upon a button and the electric spark, serve to ignite it when wanted, while still less effort extin-

guishes a jet when its use is no longer demanded. Slight as it is, for some reason (or want of reason), that effort is not always put forth, and the gas remains alight to serve no useful purpose. True, a well lighted room is more cheerful to return to than a dark one; and it is easy to say to one's self, "I shall be gone but a moment;" but while that may do for one's self, the average servant is, as a rule, oblivious of the fact that gas costs anything. These are considerations, however, that exert a marked influence on the general aggregate of the bill. A worn out burner or broken tip may still pass gas, and more than enough to serve for an economical illumination. Gas is usually delivered at a moderate pressure, so that a bit of string, putty, or hard soap, which are almost always at hand, is made to serve permanently in closing a leak in pipe or fixture.

We might go on at greater length in suggesting makeshift devices that might be, and often are, used, with the original design of temporarily bridging over a defect; but which in fact become a permanent repair, operating to the manifest financial disadvantage of the consumer, and to the great discredit of the company.

Then the meter, that cabalistic device which, according to *The Judge*, of Feb. 21, 1885, "So inexorably registers so many thousand feet, which is a fixed quantity immutable as a law of nature, and probably regulated beforehand by the gas company, on a system dependent on the number of burners in the house, no matter whether they be lighted or not, is a mystery to most consumers, and a source of anguish to all." Very few care to undertake the solution of so intricate a problem as reading the index, and still fewer are persuaded to understand its admirable construction. The most charitable regard it with more or less incredulity and aversion; while not a few declare, and apparently believe, it to be the champion liar, conceived in sin and brought forth in iniquity. To the ordinary observer the physical characteristics of illuminating gas are pretty well indicated by the word *evanescence*. It can neither be weighed nor measured by ordinary methods, and in its pure and natural state appeals to no sense save that of smell. Unlike most other articles of merchandise, it is, to the average consumer, almost an intangible myth. What wonder, then, that one not an expert in gas matters sometimes finds it hard to realize that the proper ratio exists between the figures presented in his bill and the service rendered—which those figures represent. And correspondingly easy to jump to the conclusion that it is quite the correct and proper thing to denounce the gas company as a fraud, a cheat, and a rapacious monopoly withal.

Does the foregoing suggest an overdrawn picture of the relations existing betwixt some consumers and the gas company that serves them? And if not, are they desirable to either party; or calculated to promote the comfort of one or the profit of the other? And again—if not, how shall the proper attitude of each toward the other be attained and maintained? Will not the exercise of those qualities, which Webster gives when defining amenity, tend toward the attainment of the desired end; and work correspondingly to the comfort of the one party and the profit of the other?

In illustration of our idea, let us suppose a case which we know may occur, and which possibly does occur oftener than we do know: The index taker records a meter statement 1,000 feet too great or too small, and a bill is presented in accord therewith. The discrepancy may be a glaring one, riveting the consumer's attention, arousing his distrust and ire at once, while the man who made it, with perhaps hundreds of others for the corresponding period, may easily fail to observe even the possibility of a mistake.

Now, if that consumer happened to be a man with certain peculiarities of temperament, he may appear at the company's office in the shape of a difficult and unpleasant problem to solve. Fire may be in his eye; his general demeanor beligerent, while bitter invective may characterize his speech; and, in short, he may be wholly unreasonable until he experiences a change of heart. Of course the sooner this change can be wrought the better; but in some cases, and probably in this, it will be best to make haste slowly. Let the man sit at the desk "in patience possess his soul," and listen quietly and attentively to the recital of grievance, both real and imaginary. By so doing surplus steam will most likely be blown off without danger of explosion, the aggrieved party meantime becoming amenable to reason.

If, as supposed, it is a case of simple error in indexing, ninety-nine men in a hundred will, under such management, soon come to a frame of mind capable of appreciating that a mistake need not of necessity be a capital offense; and that in the case supposed the mistake effects nothing more than payment in advance, or an extension of credit, according to the direction in which the error was made. Heat, anger and impatience are generally unreasonable, and if met by similar qualities, a proper understanding in case of difference is very slowly, if ever, effected. Add to these want of intelligence, or downright ignorance, and the difficulties of adjustment become almost hopeless—especially so if a cloud of obscurity surround the case. And who of us have not at one time or another come in contact with cases that, at first, seemed wholly unexplainable—indeed almost analogous to that oft-repeated tale where the meter cock was closed on index day, and kerosene

installed as an illuminant for the succeeding month—but with an undiminished gas bill at the end.

May I indulge in one little reminiscence? Some years since a customer of the People's Gas Light Company, of Cleveland, Ohio, entered the office and announced that his house would be closed for a time (as his family were to take a summer trip), and desired that the index be taken. It being but a short distance from the office the customer waited for the index return, and paid the bill, saying, as he departed, that he would call and have the meter indexed again when the family returned, "as he had little confidence in the thing."

True to his word he called again in five or six weeks, handed the secretary the key to his house, with the request that the meter be indexed, as the family would be home in the morning. The secretary's remark that he supposed the meter cock was closed availed nothing. The index must be, and was, taken. The customer remained at the office until the messenger returned.

A comparison of the readings and the usual mathematical calculations revealed a bill, as my memory goes, of some ten or twelve dollars—gas was \$3.00 per thousand at the time. The explosion and tirade that promptly followed I shall not attempt to describe; sufficient to say for a moment the secretary had little to utter, and being young in the business, hardly knew what to think. Finally that official proposed a personal visit of inspection; whereupon the two repaired to the house together—one reflecting, and the other talking until they stood before the meter. The secretary gazed anxiously at the dial—the other waited and fumed impatiently, indulging the while in sarcastic and derogatory remarks. Said the secretary: "It moves." Said the consumer: "Of course it does; that's what it was made for." Said the secretary: "Gas must be escaping." Said the consumer: "Then we ought to smell it."

A careful search of the lower part of the house revealed nothing. They ascended the rear staircase—passing through a hall, an ordinary looking glass was observed through a door opening into an adjoining room. In that mirror was the reflection of a burning gas-jet. That room was occupied by the servant girl, and she locked the house when the family left it.

This case, with slightly varying conditions at the last, might never have been satisfactorily explained. But, as a rule, will not patient, careful investigation disclose the cause of seeming discrepancies? I think so; and would respectfully suggest—it is not enough that in justice to ourselves and our customers we pass into our mains gas of a high standard in quality, and deliver it by a nicely adjusted pressure, in fair and honest measure. It is our consumer's right to feel assured that we do this, and it is for us to give the assurance.

Does he manifest a doubting or incredulous spirit, presume not to satisfy him with impatient words or gestures of ridicule. We ought to know more than he of the intricacies of this business; and if he show never so slight a desire for information, it should be both our duty and privilege to impart to him, pleasantly and agreeably, both in manner and disposition, the knowledge that he asks, and by so doing realize the surest way to make him our friend, and an added element of success to our business, from the practice of the virtues and beauties of amenity.

Discussion.

The President—If any of the gentlemen here are disposed to take issue with Mr. Lindsley, we would like to hear from them.

Mr. Jenkins—I do not care to take issue with him; but I do say I think this is about the most important subject we have yet had brought up before the meeting; and it has especial value to the superintendents from the small towns. I believe that if a superintendent of a small works can make himself thoroughly agreeable, and treat his customers in the way suggested by the writer, the outcome of the policy would pretty nearly equal anything he could do in his retort house. I have found that out as the result of experience. I am confident that one must follow the Lindsley plan if he would secure and keep the good will of his customers. As a matter of common policy it is profitable to adhere to his advice. Let me relate a case of my own. One of my customers, a clever woman, too, was very much put out through a failure in the gas supply on an evening when she particularly desired to illuminate her house. Unfortunately she sent me word on the next morning, and not at the time of the failure. I did not go to the house myself, as I learned she was not in very good humor, but sent a man to remedy the stoppage, which was caused by a very simple matter. About a week afterwards I called, as usual, to take the meter. While at the house I met the mistress of the mansion, talked to her very pleasantly, asked her about the children's health, and so on, showed her the meter statement—this we usually do—and, to sum it all up, had quite a pleasant little conversation. I did not hear a word about the anticipated "lecture." A mutual friend who shortly afterwards called at the house told me that she said, "I had a first-rate lecture prepared for Jenkins; but when he came in he was so agreeable I could not say anything about it." That style of procedure will be success-

ful nine times out of ten. I think Mr. Lindsley's suggestion in regard to the treatment of irate customers when they come to the office is a great "card."

Mr. James Somerville—I take some issue with friend Lindsley. I do not understand how it was when that gentleman came over to the gas office and told them to come and take the meter index that the inspector did not shut the gas off at the meter. The entire after trouble would have been obviated had that course been taken. Nine consumers out of ten do not know that they have a certain and easy means of controlling pressure at their meters, and this is where half the trouble comes. Did they understand that the control of the pressure was in their own hands, and that they could regulate it as they saw fit, I think it would be better for all of us. Doubling of pressure means doubling of gas bills. I will take this opportunity of saying to the superintendents of small works—impress upon the minds of your consumers that they can turn the gas off and on at their own will and pleasure. The gas company has nothing to do with it; it is in their own hands.

Mr. Lindsley—I will add a word in reference to the point made by Mr. Somerville, that at the time the occurrence took place the managers of the People's Gas Light Company were all very young in the business. Of course, if the meter cock had been closed there would have been no trouble. I quite agree with Mr. Somerville's suggestion that it is a good point to have a consumer understand how to close and open the meter cock at will. I hold that we cannot take too much pains to give information to our consumers, so far as they are willing to learn, in respect to the ordinary working and principle of the gas meter.

Mr. T. G. Foster—I would like to ask a question as to the policy or propriety of allowing the index taker to give the consumer a statement concerning the gas consumed for the month—*i. e.*, while the index taker is making his usual round. The reason I ask the question is that I have tried that plan, and I find it creates a good deal of dissatisfaction, simply from the fact that the index taker, in his hurry to get through with his work, will sometimes, and as consequence of his hurry, make a mistake in repeating the figures. Suppose the indexer tells the consumer that he has burned 1,000 cubic feet, and when the consumer gets his bill from the office he finds that he is charged with 1,500 cubic feet, this discrepancy naturally impresses the consumer with the belief that there is something wrong, when in reality did the indexer state the case properly the amounts would tally. I think it is always best to refer the consumer to the office for a statement of gas used.

Mr. Lindsley—In reply to Mr. Foster I would say, speaking from personal experience in regard to that matter, that the proper place for a consumer to find out the amount of his bill is at the office of the gas company. We have never yet been successful in securing the services of an indexer who was able to do much more than record, in a mechanical or perfunctory way, the figures as he found them indicated by the dials. We have had indexers who I think really understood why the third hand on an ordinary dial had a reverse motion to the others, but beyond that their intelligence did not go. These men are exceedingly liable to make mistakes, and this, I suppose, is not much to be wondered at, as they are continually on the "go," and really have but scant time wherein to tell long stories or enter into long-winded explanations. If the nature of the service would warrant the employment of a more intelligent class of men, I do not know that there would be so great an objection to an indexer being instructed to state the meter reading, or even to making out a bill on the spot, as has been suggested by one gentleman. Ordinarily, I believe the better way is to have the bill made out at the office.

Mr. Foster—That is all very well in large cities; but in small places a different state of affairs prevails. Our town is but a small place. We have a rule for allowing a certain discount when payment is made within a certain time from presentation of bill. We tried the plan of allowing the meter taker to make out the bill; but soon found out that if he stopped to make out the bill, received pay, and made change, it would probably use up two weeks before all the statements were in. Then we made a rule requiring consumers to visit the office, and forbade the indexer to receive any money. We have had a great deal of trouble in consequence of permitting the index taker to give the figures at consumers' houses, which often had to be readjusted afterwards at the office.

Mr. Hyde—The custom at Cleveland, Ohio, on the east side of the river, has been to refuse making known to the consumer the monthly or quarterly value of bills in dollars and cents. If consumers desire it we give them the correct reading of the meter as taken from the dials.

Mr. V. L. Elbert—We adopted this plan at Jackson, Mich., in September, 1884. The index taker has an index book arranged with stubs for the bill and for the figures of his statement; on that statement is placed the previous reading—copied in ink at the office. When the present reading is made the figures are placed underneath those in ink, and the subtraction made; but no figures as to the money value of the bill are given. We never put a money figure on the statements, because they are apt to be carried out incorrectly or left incomplete. With us there is yet another reason. Our

bills are subject to a discount if paid at the office within a certain time. On the back of this statement the figures explaining what the discount will be, if account is settled within a certain time, are plainly carried out. Our experience has been very satisfactory under the new scheme, and we have had no trouble whatever. Prior to the adoption of that plan, however, there was constant distrust among the consumers. I would say that we do not permit any inexperienced person to take our statements of meters; we have done so once or twice under pressing necessity, but have suffered from it.

Mr. Foster—Do you collect the bills when you present them?

Mr. Elbert—No; we do not permit any collection at that time. When the bills are brought to the office we can tell if a mistake has been made, as we know about what the consumption should be.

Mr. Foster—You require that the bill be sent to the office for payment?

Mr. Elbert—Yes, sir.

Mr. Foster—In our town we receive considerable money on the first two or three days of the month. In small towns the consumers cannot understand the idea of the gas company requiring that bills be paid at the office; they look upon it as rather arbitrary. They want you to present the bill and collect it.

Mr. Jenkins—At one time I read all the meters myself and left the statements at consumers' houses, making them out off-hand from the meter readings. I soon found that a large number of the consumers wanted to settle right there and then; consequently too much time was taken up in making the circuit. The trouble occasioned by the method was so great that I discontinued it. I afterward adopted the method of reading the meter, then made the bills out, and presented them at once; if paid on presentation I discounted them; in cases where I was told to "call again" no discount was granted. Under the first plan so many wished to settle immediately that I would not care to incur the danger of trusting the average indexer with the business of collection.

Mr. Somerville—Mr. Lindsley insisted, and I thought very properly, upon the point that the officers of a gas company should be filled with "the milk of human kindness" at all times. It would be very agreeable indeed if they were. And yet he says that the person who takes the index must not tell the consumer the amount of his bill. If they ask that very natural question he is instructed to tell them to go to the office, which may be three miles away. "Come down to the office, and they will tell you what the bill is." Now I do not think that is altogether agreeable—I certainly would not think it so. This matter of inspectors is a most important one, since it very often happens that these men are the only gas officials whom the people know. They are the men most often brought in contact with your consumers; and if they are not gentlemanly in their address—all I have got to say is that they should be, and the gas company should have only just such men. You have no right to send an unclean man into the house of a consumer. I will state what the London practice is—and it is just possible that that system prevails all over Great Britain. By the side of the meter a card, ruled out with the day of the month, the reading of the index, and the amount of gas consumed, is hung up. The indexer has to remove that card, carefully place thereon the present statement, and subtract it from the total of past readings, place the money value of gas consumed on the card, and replace it where the consumer may come and look at it. I think it a very good plan; and I do not believe that it is altogether right to bluff a consumer off with "Go to the office."

Mr. W. H. Odiorne—I will mention the plan adopted by us at Springfield, Ills., and may preface it with the assertion that the method works well. In the first place all our bills contain a printed statement of the meter as read on the first of the month. When the indexer visits a house to read the meter, should he, on emerging therefrom, be asked by one of the occupants as to the quantity of gas that had been burned, instead of replying, "I don't know; go to the office, and they will enlighten you," he says, "I cannot tell you how much you have burned; but I can give you the statement I have just taken. If you compare that with the statement taken on the first of last month, and now in your possession, you may determine for yourself." This satisfies them, and many of our consumers now make regular monthly comparisons on their own account.

Mr. Michael Moran—I think that one of the best things that can be done by any and all of our gas companies is to teach the consumer how to read the meter. It would pay us to have the services of an expert for this very purpose. I have tried it in our city of Joliet, Ills., and I may safely say that nine in ten of my consumers can read their meters with as much ease as they can tell the hour by looking at a watch or clock.

With termination of discussion on subject introduced by Mr. Lindsley, President Lansden proclaimed that the next paper on the list was that presented by Mr. Byron E. Chollar, of Topeka, Kansas. This contribution was entitled—

GAS BILLS VS. GAS LIGHT.

The author read as follows:

In his lecture on the art of money getting, Mr. Barnum, the so-called

prince of showmen, told his audiences that the great secret of continued success in business was always to give people their money's worth. The idea that he intended to convey is not that close margins of profit are always demanded; but really that one's patrons should be made so well satisfied that they would naturally consider themselves as the real gainers.

To gas manufacturers the above idea is especially applicable; for if there be but one industry in the world whose supporters are inclined to think that they do not get value received for their money, that one is certainly the business of gas supplying.

What we manufacture and sell is an actual physical substance that can be weighed and measured. What our customers require is not a substance at all, but only a force that we can neither weigh nor measure. Its value can be estimated by comparison with a similar force. We can speak of a cubic foot of gas, or of a pound of gas; while to speak of a foot or a pound of light would be sheer nonsense.

Our consumers, therefore, purchase our gas only for the light afforded—the question of cubic feet does not enter into their computations. The cost of a required amount of lighting is what they look at; yet they give little or no attention to economical methods of using the article. As long as gas furnishes them with what seems to them to be the most suitable and satisfactory light for their requirements, just for that length of time will they remain patrons of gas companies; but when some other source of light, that strikes them more favorably, is brought to their notice, they will immediately adopt it and "drop the gas."

If, therefore, we can enhance the value of the services which our goods render to our customers, without a corresponding increase in cost to them, they will by just that increase be more likely to remain with us. It matters not to them how such result is effected—whether it be by improvement in actual quality, or by placing them in the way of using the same quality to better advantage.

The latter plan would appear as affording the better field for eventual profit to gas companies, and this for the reason that much can be done in that direction at comparatively small cost. There is probably little or no exaggeration in saying that the average gas burner develops not to exceed two-thirds of the light that it ought to afford.

This is easy to understand when we consider the fact that, with common coal gas, about 94 per cent. of its volume gives no light at all—the lighting service being derived from the remaining six per cent. Now, as we cannot destroy what is not there, the action of bad burners, or of good ones, burning at a wrong rate, must necessarily operate entirely upon this six per cent. of illuminants. It follows, therefore, that a destruction of two of these parts, amounting to but two per cent. of the whole volume, will effect a loss of 33 per cent. in light. If three of the parts are destroyed, the loss of light will be one-half.

The following are notes of experiments with various burners, nearly all of them taken directly from consumers' fixtures. In none of the cases had complaint been made that these burners were especially bad. The opinion was general, however, that the gas was bad, and its price too high; and also, of course, that the meters registered more gas than was actually consumed. The illuminating value of the gas ranged between $16\frac{1}{2}$ and $17\frac{1}{2}$ candles; in making the computations it was assumed to be 17.

A "No. 6" burner, at 5 feet per hour, gave 248 per cent. more light than a smaller one using 3.7 feet per hour; 35 per cent. more gas gave 248 per cent. more light. One dollar's worth of light cost the consumer \$2.60—or developed $6\frac{1}{2}$ -candle light from 17-candle gas.

A "No. 6," at 5 feet per hour, gave 172 per cent. more light than did a "No. 3," at $4\frac{1}{2}$ feet per hour—a gain of 143 per cent. on the bad burner. This one made a dollar's worth of light cost \$2.43; or reduced 17-candle gas to 7-candle.

A "No. 5," at 5 feet per hour, gave 105 per cent. more light than did a "No. 3," at 3 feet per hour—or caused a dollar's worth of light to cost \$1.23; or reduced the candle power from 17 to 14.

A "No. 5," at 5 feet per hour, gave 875 per cent. more light than did a "No. 1," at 1.2 feet per hour—making a dollar's worth of light cost \$2.30; or reduced a 17-candle gas to $7\frac{1}{2}$ candles.

A burner, consuming 9.7 cubic feet, was replaced by one affording the same light with a consumption of but 7.2 cubic feet—or a saving of nearly 26 per cent. to the consumer.

A burner, consuming 7.2 cubic feet, was replaced by one rated at 7 cubic feet, and 70 per cent. more light obtained therefrom; or a net gain of 66 per cent. in light being secured to the consumer.

An old "No. 3" tip, in an opal globe, was compared with a "No. 6," at 5 cubic feet per hour, with the following result: The "No. 6" consumed 10 per cent. less gas, and gave 640 per cent. more light. When the "No. 6" was turned down so as to give a light equal to the one in the globe, it consumed but two cubic feet per hour.

A "No. 6," at 5 feet per hour, gave 160 per cent. more light than did a

"No. 4," at $9\frac{1}{2}$ feet in an opal globe. The consumer had the pleasure (?) of paying one dollar for about 20 cents' worth of light.

The following few experiments will give an idea of the amount of gain arising from the use of moderately large burners. They are not now given as showing something not known before, but are merely offered as notes of actual everyday practice.

A "No. 10" tip, at 11.2 feet, gave 160 per cent. more light than that afforded by a Sugg's "No. 1, London Argand," rated at 5 feet per hour—a gain of 13 per cent. over the Argand; and increased the candle power of the gas from 17 to 19.25.

A "No. 6," at 5.8 cubic feet, gave 18 per cent. more light than did a sample of Sugg's "No. 1," at 5 feet—a gain of about 2 per cent. for the flat flame.

Another "No. 10" tip, at 11.4 cubic feet per hour, gave 200 per cent. more light than did a specimen of Sugg's "No. 1," at 5 feet—a gain of 32 per cent. for the flat flame. The same burner, at 11.6, gave 220 per cent. more light than that developed by the Argand—a gain of 38 per cent. for the flat flame.

In the face of such facts is it at all surprising that gas consumers doubt the reliability of gas meters, or dispute the fairness of gas bills? If gas companies expect to hold their own against the sharp competition of other lights, which competition is sure to come in the near future, they will have to see to it that their customers get somewhere near the maximum of value for their money; or, to use a slangy, but forcible, expression, "to work their gas for all it is worth."

Discussion.

Mr. E. McMillin—What pressure did you carry when making the experiments?

Mr. Chollar—I paid no attention to pressure conditions. I simply noted the quantities of gas consumed by the burners. The important thing to determine is the quantity of gas that the burner consumes under ordinary conditions.

Mr. M. Moran—Did your experiments cost your company anything.

Mr. Chollar—No, sir.

Mr. T. Smith—Did you test by jet photometer?

Mr. Chollar—No, sir; I employed a bar photometer.

Mr. M. McMillin—How did you adjust the pressure?

Mr. Chollar—I adjusted the pressure according to the rate of burner. I think you will find it much better to rate the burner, because then the pressure is rated at the same time.

Mr. M. McMillin—To deliver a certain quantity of gas under a certain pressure the burner aperture must be of a given size. Suppose you increase the aperture—then to maintain the same rate of consumption as before the pressure must be increased. That the best results from any burner may be obtained requires the maintenance of a certain pressure.

Mr. Chollar—It requires a certain rate, which is the same thing. If you change the rate you change the pressure.

Mr. McMillin—Say you have an aperture of a certain size, or one at which the gas is burning under inch and a-half pressure—do you mean to claim that you would have the same rate when that quantity of gas was burned under $2\frac{1}{2}$ inches of pressure?

Mr. Chollar—Not at all. The question is, how much gas have you got to burn in order that the maximum light be developed. The pressure is included in the rate of burning. It, of course, requires a certain pressure; but I do not care what the pressure is. What I want to know is how much gas that burner will consume. It is not necessary to take the pressure.

Mr. Jenkins—A burner working under one inch pressure consumes five feet of gas per hour; now, if you double that pressure it will consume $7\frac{1}{2}$ feet per hour. What is the difference in lighting value, or cost of same to consumer?

Mr. Chollar—It would seem as though that question answered itself. The great trouble with burners is their irregularity. If you buy two packages of "No. 6" burners, and test them by the photometer, you will find that although rated the same, they do not consume equal quantities of gas. One will burn 5 feet, while another may take up 6 feet.

Mr. M. McMillin—The fishtail burner can be used to advantage under high pressures, because you may turn it down to a point where there will be neither whistling nor blowing, and yet have a pretty good illumination.

Mr. Chollar—I found that the fishtail burner worked best under an especially low pressure.

Mr. M. McMillin—That may be; but you can employ it under high pressures in the way spoken of. These burners are rated 1, 2, 3, 4, and up, and they will burn about the rated quantity of gas. We know that if ten feet of gas are passed through a two-foot burner it will give the same light under similar pressure. What I want to get at is how you can say that the pressure is immaterial.

Mr. Chollar—If you take a "No. 1" burner and allow it to burn one foot

an hour a certain pressure is required. If you force it to consume ten feet per hour, then another certain pressure is necessary. Now, what is the difference whether you know it is five-tenths or seven-tenths, or that the consumption is one foot or five feet? It is the same thing; one implies the other. The rate depends upon the pressure; and if you have the rate the idea of pressure is also conveyed. As a rule, a medium size excavated head requires less pressure than other sorts—the rate of consumption is better.

Mr. M. McMillin—According to tests made by me some years ago I found that the ordinary excavated head was not reliable.

Mr. Chollar—I do not find anything better, provided they are burned at the proper rate.

Mr. M. McMillin—My experience is that, for 16-candle gas, eighteenth-tenths pressure gives the best results. In the case of the experiments which I have just mentioned the pressure in any case did not exceed two and three-tenths. I deemed it very essential to determine what the pressure was.

Mr. Chollar—What quantity of gas did that excavated head consume in an hour?

Mr. M. McMillin—I do not remember now.

Mr. Chollar—You did not estimate the rate, and I did not estimate the pressure.

Mr. M. McMillin—A burner consuming $2\frac{1}{2}$ feet per hour would not give the same light that it would when consuming double that quantity.

Mr. Chollar—I suppose not. It is like buying a bushel of wheat—what is the difference between measuring it and weighing it? You get the same final result.

Mr. McMillin—Suppose your burners are accommodated to the rate of consumption desired—then does it not make any difference whether the pressure in the street be at one-tenth or five-tenths?

Mr. Chollar—Yes, it does; you change the rate and you change the pressure.

Mr. Jenkins—How do you determine the pressure at which your burners should be adjusted?

Mr. Chollar—I use a pocket meter, which is in the main quite reliable, although sometimes the graduation is not to be depended upon.

Mr. E. J. King—At Jacksonville, Ills., in dealing with our consumers in the matter of burners, we take one of the old specimens, screw it on a bracket, and ignite the gas. After the consumer has noted the light we then put on the bracket a sample of an improved burner. He makes his comparisons, and the effect is evident, even though no figures regarding hourly consumption are there shown. This test or plan has been of great value to us.

Mr. Howard—I do not know of any reason why the managers of small works should allow their consumers to use poor burners. At Dubuque we purchase the best burners that the market affords—those that will give the best lighting effect in connection with the least possible expenditure of gas. We present these burners to our customers, and it pays to do it. We even go further than that, as in the evening we frequently send a man to visit the storekeepers' premises, instructing him to observe those burners which are not working properly. Next day he replaces the defective burners with sound ones. I believe that if every small company in the country would spend about \$50 in furnishing their consumers with the best burners obtainable they would have much less bother while collecting their gas accounts.

Mr. L. K. Scofield—Mr. Howard, what style of burner do you use?

Mr. Howard—I buy the check burner, with straight tip. We instruct the consumer that he can regulate the burner so as to obtain whatever quantity of light he requires, by simply turning down the check. One consumer instructs another in regard to it. We charge nothing for the burners, nor for the labor of attaching them. The practice pays us right well.

On motion of Mr. Howard, a vote of thanks was tendered to Mr. Chollar.

Mr. Geo. Shepard Page, of New York city, then read the following paper on—

THE COOPER COAL LIMING PROCESS.

A constant subject for discussion among gas engineers during many years has been the possibility or probability of the discovery of some process by which the purification of gas could be economically effected in closed vessels. Many experiments have been tried, some of them on a large scale, based on the introduction of chemical compounds into the washing and scrubbing apparatus. Within the past seven years it has been demonstrated that ammonia could be removed entirely in closed vessels; but the sulphur compounds and carbonic acid have been more difficult to deal with.

During the past two years the technical journals have contained communications, letters, discussions, and editorial comment referring to the process (identified with the name of Mr. W. J. Cooper, of England) known as "Cooper's coal liming process." The name indicates, to some extent, the plan pursued, which is to incorporate with the coal, before charging the retorts, a certain percentage of lime. The process of mixture is as follows:

To the coal, either in a lumpy condition—such as that of coal used in gas

manufacture—or, by preference, in a state of fine division, is added hydrate of lime, and the mixture is well incorporated. The quantity of lime used is between 50 and 60 pounds to every ton of coal, the lime being slaked with about its own weight of water—5 gallons—whereby it is brought into such condition as to admit of ready commingling or mixture with the coal.

The products which arise in the distillation of limed coal differ materially from those obtained in the ordinary course of gas manufacture, or by the distillation of coal pure and simple. Limed coal yields a larger fraction of its nitrogen in the form of ammonia, a slightly larger fraction of its carbon being in the form of volatile compounds—that is, there is an increase in the tar and gas taken conjointly—a smaller fraction of its sulphur is in volatile form; and it yields limed coke instead of common coke. There are, however, hardly any physical differences between limed coke and common gas coke; an occasional white speck, where the lime has failed to mix perfectly with the coal, being the only apparent distinguishing feature. The differences show themselves when the coke is burned. Common coke, as most persons know from experience, gives off an abundance of the fumes of sulphurous acid during its combustion. Limed coke, on the other hand, evolves very little sulphurous acid during combustion; and if the original mixture of lime and coal were absolutely perfect there would positively be no sulphurous acid. The limed coke has another advantage, inasmuch as lime and calcium compounds generally are pre-eminently non-volatile. The addition of lime to the coal before the distillation must be equivalent to the addition of so much mineral matter to the ash of the coke given by the coal.

Limed coke manufactured from a given quality of coal must necessarily contain more fixed matter or ash than common coke from the same quality of coal. Fuel which leaves much ash is considered objectionable; it was anticipated, therefore, that limed coke would not burn as well as common coke. This anticipation has been negated by the very large quantity of limed coke produced and burned under a great variety of circumstances; and it has been observed that the limed coke burns brighter, quicker, and readier than common coke. The explanation of this is that the thin film of calcium compound which coats the coke acts as an oxygen carrier as it is gradually burned away in the fire. Limed coke is thus well adapted for domestic use.

The additional advantage claimed for the carbonization of limed coal is that it yields a larger percentage of nitrogen in the form of ammonia. It will be of interest to state in this connection that the production of ammonia from the London gas works—in which city about 2,000,000 tons of coal are carbonized annually, and from which 5 to 6 pounds of ammonia (NH₃) are produced from each ton of coal—reaches an annual total of over 10,000,000 pounds; but if all of the nitrogen in the coal were obtained in the form of ammonia, the yield would be from 25 to 50 pounds of ammonia per ton of coal carbonized, the value of which, even at the present low price of sulphate of ammonia, would be \$7,000,000, or \$3.50 per ton of coal carbonized.

It is claimed that Cooper's process increases the yield of ammonia very considerably without sacrificing the coke. It is asserted that from 12 to 15 pounds of ammonia per ton of coal can be obtained from coal when thus limed. As has been stated, the apparatus for the removal of ammonia has been so thoroughly perfected within the past few years that this product can be entirely removed before the gas reaches the purifiers.

The next most important impurities with which the gas manager must deal are the sulphur compounds. It is well known to chemists that the sulphur present in organic compounds can be made to attach itself to calcium by simply heating the organic compounds in contact with lime. It will therefore be understood that limed coal should yield little or no volatile sulphur compound when it is employed in gas making.

Sulphur occurs in crude gas partly and mainly in the form of sulphuretted hydrogen, and partly in the form of sulphur compounds other than the sulphuretted hydrogen—which consists mainly of bisulphide of carbon; but it is well known that there are other sulphur compounds as yet but little understood. Both the sulphuretted hydrogen and the other sulphur compounds are diminished by the Cooper process of manufacture.

The percentage of sulphuretted hydrogen in crude coal gas varies from 0.6 to 1.5 volumes. The sulphur other than the sulphuretted hydrogen in crude coal gas competent authorities have claimed to be less than 0.3 volume per 100 volumes of gas.

The following experiments at the Vauxhall station of the South Metropolitan Gas Company, where in one retort house limed coal was used and in another unlimed coal, the comparative testings of the gas gave the following results: First experiment—limed coal, 11.4 grains of sulphur in 100 cubic feet of the gas; unlimed coal, 26.3 grains of sulphur in 100 cubic feet. On another occasion the limed coal gas product showed the presence of 10.4 grains, while the unlimed specimen contained 27 grains of sulphur per 100 cubic feet.

At the Tunbridge Wells (Eng.) gas works, using a coal which contained 1.7 per cent. sulphur, an average of 3 grains of sulphur per 100 cubic feet of

gas was maintained for three weeks. The lime purifier has been discontinued at these works and oxide of iron used exclusively, with the result before stated—that is, but 3 grains of sulphur to the hundred feet of gas.

An important feature of this process, and one that very rarely can be claimed for experiments in any branch of manufacture, is that no new plant is required; but, on the contrary, the plant is diminished. Neither is any new material brought into the works, for lime has been used ever since gas manufacture began.

The cost of the lime used, including slaking and application of same to the coal, is about 12 cents per ton. A small allowance for extra retort room is to be made, for a ton of coal without lime gives, practically, about the same amount of gas as is obtained from a ton of the limed coal. This allowance is, say, 5 cents. The debit side of the account is therefore 17 cents. On the other side there are several items. The cost of the lime is to a great extent covered when the coke is sold, and consumers have acknowledged the advantage of lime in the coke by paying for it; but the chief item is the saving in the cost of gas purification. It is claimed that this amounts to 90 per cent. in the labor, and almost an entire saving of the purifying material. Economy in the purification may be reckoned at 14 cents per ton of coal carbonized, a gain in ammonia of 20 cents per ton of coal, and in tar a gain of 5 cents. There is a net gain, therefore, of over 25 cents per ton of coal carbonized; and this gain has been greatly exceeded at Tunbridge Wells.

In addition to the preceding advantages there is added the saving in purifying plant. Many gas works find great difficulty in keeping pace with the demands for purifying plant to meet the requirements of the winter make of gas. In such cases the adoption of the liming process would save a large expenditure. Again, the abatement of the nuisance caused by exposing the boxes to the open air would be entirely avoided. The possibility of doing away with the lime purifiers will permit many gas works now located in the vicinity of residences to continue without complaint.

The question will be asked, "What becomes of the carbonic acid?" To which the answer is given that the use of the lime in retorts does not diminish the proportion of carbonic acid which comes out of the gas, but the extra ammonia which was formed absorbed some of it, and thus reduced the carbonic acid to a minimum.

The following theoretical explanation of the chemical action has been given: Gas as it left the retorts contained 0.4 per cent. sulphuretted hydrogen, and 1 per cent of air entering the gas would give sufficient oxygen to consume it. What was really done by the process when properly managed was to make use of this trace of air—to practically do all the purification by its aid. The oxide of iron purifier became the sulphuret of iron sponge, the function of which was to transfer oxygen from the trace of air to the sulphuretted hydrogen. This explains the process as one operating in closed vessels.

To refer again to the advantages in the purification department which will result from the use of limed coal, it is asserted on competent authority that about half the work of purification was done in the retorts, so that nearly half the sulphur goes forward to the purifiers. In consequence of this the oxidation or revivification of the oxide of iron may be effected without the cost of removal for a very long period, and then it may be further prolonged by the admission of a small percentage of common air into the first purifier of the series, the exact proportion being defined and passed in through a meter. The only drawback is the reduction of the illuminating power to the extent of about two-tenths of a candle.

In May, 1884, the manager of the Tunbridge Wells gas works stated that the process of oxidation in the purifiers was commenced on the preceding 31st of January, and was still going on—number one of the purifiers being still number one of the series of three, and showed no sign of diminished activity, though the gas product of 6,400 tons of coal had been passed through in six months; and that there was no apparent reason why the action might not continue efficiently through the entire year, in which event the coal liming process would have to be credited with the purifying of the gas from more than 12,000 tons of coal, through a period of 14 months, without opening a single purifier. The importance of this statement will be realized by every gas manager who has been worried by the great nuisance and expense of frequently, and in some instances daily, opening purifiers and emptying and refilling them with revived material, or supplying them with fresh lime. Under this same date Mr. Spice claims an increase in ammoniacal liquor from 28½ gallons of 10-ounce, obtained regularly from unlimed coal, to 37 gallons of the same strength per ton of limed coal—an increase of over 30 per cent. The net income from those works in one year, properly credited to the coal liming process, in the added ammonia, amounted to \$1,800.

With regard to the product of gas per ton of coal carbonized, a slight increase is shown. The candle power of the gas remains about the same. In the consumption of limed coke less air is required for its combustion, and with attention to this point in the regulation of the flue dampers there will be no fear of the fluxing or destruction of furnace settings or of grate bars.

While burning it gives greater light and brilliancy than the ordinary coke fire.

It may be of interest at this point to refer to the statement made by Prof. W. Foster, a distinguished London chemist, that of the total nitrogen in coal it was found that, in gas manufacture, 14.5 per cent. was available as ammonia, and 1.56 per cent. as cyanogen; 35.26 per cent. was left in its elementary condition in the gas, and 48.68 per cent. was left in the coke. A pertinent question, then, is that of Prof. Foster: "How can gas engineers increase the yield of ammonia in their gas manufacture?—a question in which we are all deeply interested, in view of the fact that any increase in product of obtainable ammonia adds materially to the income of every gas company." It is possible that in this new process of carbonization the key to this hitherto lost ammonia has been found.

Some notable authorities may properly be quoted here who have experimented practically with the Cooper coal liming process, and who report the following gains in ammonia obtained: Mr. G. E. Stevenson, 22.5 per cent.; Mr. Eastwood, 18.8 per cent.; Mr. R. O. Paterson, 20 per cent.; Mr. Wright, 20 per cent.; Mr. Wilton, 35 per cent.; Mr. Leicester Greville, 28 per cent.; Mr. Botley, 100 per cent.; and Mr. Dougal, 30 per cent.

The following is a concise statement of the effect of lime upon the sulphur in the coal: Coal used in gas works contains about one per cent. sulphur; when gas is made, part of this sulphur goes into the gas in the form of sulphuretted hydrogen, and part remains behind in the coke. It costs from 16 to 20 cents in labor and material per ton of coal carbonized, and about the same amount in interest on the plant, to remove this sulphuretted hydrogen, and entails upon the gas works the creation of one of the worst nuisances in the whole range of manufacturing industry.

It is claimed that Cooper's coal liming process supplies a remedy for manufacturing gas up to the London standard of purity—that is, with less than 20 grains of sulphur in 100 cubic feet of gas—saving 90 per cent. of the cost, and abstaining from the creation of the nuisance.

If we can have an unsulphurous coal, or if we could extract the sulphur before carbonizing the coal, the difficulty would be done away with; but there is no probability of either of these tasks being accomplished, and Cooper's process aims to work in the way of neutralizing the sulphur in the coal by means of a slight excess of the lime.

At the Tunbridge Wells gas works, where the process has been in operation for 18 months, the lime and coal, in the proportions stated, are fed into an incorporating mill, in which they are blended by being passed between two toothed rollers. The limed coal falls into a receiver, from whence it is lifted by elevators to fixed hoppers in the retort house, where it is stored for use.

It is a well-known chemical fact that at the temperatures and under the conditions realized in the interior of the gas retort sulphur has a greater tendency to unite with calcium than to unite with hydrogen, with carbon or with oxygen; and if there were an absolutely perfect mixture of lime with coal there would be absolutely no escape of any sulphur into the gas.

In practice the mixture is only approximate, and accordingly in practice the purity of the gas is only approximate; but the approximation is good enough to insure the most important results. This process is rapidly gaining ground in England, and has been adopted by many gas companies.

In conclusion, the following letter from one of the most distinguished of England's gas engineers, Mr. R. P. Spice, of London, will give particulars of twelve months' working of the Cooper coal liming process, at Tunbridge Wells, for the year ending the 31st of December, 1884:

"21 PARLIAMENT ST., WESTMINSTER, March 25, 1885.

"Dear Sir:—In reply to your inquiry concerning the working of this process at the Tunbridge Wells works, I am happy to say that my early estimates of its value have been abundantly confirmed by prolonged experience.

"It has now been in operation 17 months without intermission, and has stood the test of two winters without giving the slightest cause for uneasiness as to the certainty of the chemical action in minimizing the quantity of sulphur compounds.

"The particulars you desire may be stated thus: When at these works purification was effected by the usual method of sulphide of calcium and oxide of iron, a purifier would only last ten days in the winter months before it became inoperative, and had to be thrown out of action, its contents discharged, the oxide revived and returned to the vessel; or, in the case of a lime purifier, the foul lime, in a noxious state, giving off into the surrounding atmosphere the most abominable odors, was deposited on the open ground within the works, because in that district there were no means of getting rid of it; the purifier from which it had been removed was then recharged with fresh lime. And this system of purification, which has been the only known method of effecting that degree of purity now commonly imposed and required by acts of Parliament, a printed list of which I send you herewith, can only be regarded as a great nuisance when the work is done within a mile or so of residential districts.

"At Tunbridge Wells, however, all this nuisance and its attendant expense, which adds, under general circumstances, about two pence per 1,000 feet to the cost of gas, has been entirely abolished; only one oxide of iron purifier having been opened in the last 17 months. This was done at the end of 11 months, because it was then discovered that sufficient space had not been left in the vessels, upwards, to allow for the expansion of the material, due to the accretion of the sulphur which was arrested.

"When opened, and the lesson thereby taught was duly weighed, it was acted upon by removing the whole of the 30 tons of oxide, which was found to contain 40 per cent. of sulphur, and returning only one-half of it to the purifier, the other half of it being put into store for future use; this being done, the same purifier and its 15 tons of oxide has been doing all the work as efficiently as before.

"At the time this purifier was opened it had purified 101,627,000 cubic feet of gas; and in the last six months it has purified about 60,000,000 feet in addition, making in all, say, 160,000,000 feet of gas purified as fully and efficiently as is done by the sulphide of calcium process. This one vessel, which has been opened only once in 17 months, is still doing all the work which formerly required five to be used, and will probably not require to be opened again for several months to come.

"The efficiency of its action may be judged of by the fact that the sulphur compounds, in the three most trying months of the year—namely, November, December and January last, were, the mean between the highest and the lowest, 10.17 grains per 100 feet of gas, the extreme variations being only 2.05 grains higher or lower.

"There is, therefore, no pretence for the continuance of the contention that these objectionable impurities cannot be kept down without the use of the foul lime purifier, which involves a nuisance; and I contend that the coal liming process is by far the more reliable and preferable method of the two. It is indeed notorious that the greatest care, skill and constant attention is indispensable to the complex system of lime and oxide purification; and with all the care and skill of competent and experienced men it does sometimes happen, as it did, not long since, at the gas works, Newcastle-upon-Tyne, where the sulphur compounds were suddenly found to be 28.98 grains in the 100 feet—in round numbers 9 grains more than is allowed by the company's special act of Parliament; and for this accidental delinquency the company was fined ten pounds and costs, the full penalty of 20 pounds being mitigated; and although this is a well managed concern, nobody in the employ of the company could "tell the reason why," or how the impurity had been caused.

"Now let me assure you seriously that there is one thing which I do not understand, and have not been able to comprehend, in connection with this matter. If the new process had involved more trouble or care on the part of gas managers, I could understand its being frowned upon; or if it had cost more than the old system, which, after all, is not really old and venerable, I could imagine economical considerations to have stood in the way of its adoption; but as simplicity and economy and sanitary advantages are all in its favor, it is to me amazing that it should be so much maligned.

"It has been proved to be a great success at Tunbridge Wells, and this success I venture to think will be made plain by the following statement of facts concerning the actual working results of the year ending 31st December, 1884:

Summary of Twelve Months' Working of the Cooper Coal Liming Process at Tunbridge Wells.

"11,473 tons of coal carbonized in 1884 would have cost, for purification, on the London method.....	£573 13 0		
"The actual cost of purification up to the London standard of purity was.....	3 0 0		
"The saving in purification being.....	£570 13 0		
"Additional cost of carbonizing, for lime used in the retorts.....	£243 18 4		
"Less the value of the lime added to the weight of the coke.....	139 4 0	104 14 4	
"Net saving in purification.....	£465 18 8		
"Increased value of sulphate, estimated on the average market price of the last ten years, ending the 31st December, 1884.	£282 3 9		
"Net money advantage.....	748 2 5		
"Equivalent to 1s. 3½d. per ton of coal carbonized.			

"I have said nothing about other economical advantages which are obvious; but in conclusion I will refer to one fact which cannot be denied, and that is the saving which may be effected in the cost of the expensive purifying plant required to enable gas managers to keep the sulphur compounds down on the old system of working. Mr. Geo. Livesey put this at a penny per thousand feet on the gas sold, and I quite agree with him.

"At Tunbridge Wells three-fourths of the plant is not now required; five sixths of all the impurities which are contained in crude gas when carbonized on the old plan, are now so acted upon that they do not get beyond the retort, hence the purifiers have only one-sixth of the work to do which they formerly did.

I am, dear sir, yours faithfully,

"R. P. SPICE."

[To be continued.]

[A Paper read before the Guild of Gas Managers.]

Condensation; or, the Elimination of Tar from Coal Gas.

By A. B. SLATER.

A fact well known to all gas engineers is that in the distillation of coal for the manufacture of illuminating gas under the ordinary methods, during the first portion of the time, whether it be three, four or five hours, in which the coal remains in the retorts, large quantities of heavy hydrocarbon vapors are carried over, the quantities depending upon the temperature maintained in the retort, as also the weights of coal used in the charges. These vapors are, to a considerable extent, condensed or deposited in the hydraulic main; but in any case a large portion of them are carried along, and their elimination secured by apparatus specially designed for the purpose.

It is highly important that the greatest possible quantity of the tarry matter be removed from the gas before it reaches the purifiers, since, if the tar be allowed to effect lodgment in the boxes, the purifying material becomes clogged, the result being an undue back pressure, and loss of duty, which, under proper conditions, should be secured from the purifying material employed.

Until within a few years the ordinary method adopted for the elimination of tar from crude gas was obtained under various forms of apparatus; but all these were designed to accomplish the desired result through the application of the principle of condensation of vapors by reduction of the temperature; hence the apparatus was of any convenient form (according to the judgment of the engineer) which would present surfaces of large area to be cooled by water or air.

While the application of this principle in the condensation of simple watery vapors was perhaps efficient enough, still it was never successful in eliminating the heavy hydrocarbon vapors from crude coal gas; and probably one of the most lamentable instances of such failure was that which resulted in the death of Mayor Blake,* of Worcester, Mass., in December, 1870. That disaster was thus occasioned: A considerable quantity of these condensed vapors had accumulated in the bottoms of the purifiers; instead of taking the necessary means of securing their effective removal, pipes, with valves or stopcocks fitted to their lower ends, were introduced into the bottoms of the purifiers, the idea being that these were to be opened when the boxes were changed, in order that whatever product of condensation which might have accumulated there could be drawn off. At one such time, or when a purifier, after having been changed, was again put in action, the workman forgot to close the valve in the "draw-off pipe," and the entire volume of gas, instead of going on in the proper direction, passed rapidly through the "draw-off pipe" into the purifying house cellar. When the door was opened the gas which had accumulated in the cellar rushed out and communicated with the light of a lantern in the hands of a workman who happened at the time to be near the door—it was just at dark—and the explosion at once followed that was accompanied with such disastrous consequences.

Gas engineers, not being entirely satisfied with the results accomplished by any of the apparatus designed upon the principle of condensation by reduction of temperature, have gradually made improvements in the apparatus, as also in the adaptation and application of other and more scientific principles. As a result we now have air condensers, multitubular or water condensers, hot scrubbers, dry scrubbers, friction scrubbers, etc., etc., most of which are, in one respect or another, improvements over the old condensation method or procedure.

Probably the most successful results in the removal of tar from crude gas have been accomplished by the apparatus invented by Messrs. Pelouze and Audouin, of Paris, France, and patented by these gentlemen in that country in 1872. The action of this apparatus, in the removal of tar, "is based on Halley's vesicular theory of vapors, and upon the principle that the liquefaction of the globules thus held in suspension is brought about by contact of the particles either with solid substances or with each other." The first trial of this apparatus or machine was made at one of the stations of the Paris Gas Company, where, "after many months' trial, and some discussion of its theory and merits before the French Academy of Science, and by the gas journals of France, an illustrated article translated from the *Comptes Rendus*, was published in the *London Journal of Gas Lighting*, for October 7th, 1873, and most favorably commented upon by the editor." In May,

* For an account of the disaster that occasioned the death of Mr. James B. Blake, who, besides being the chief executive officer of the city of Worcester, Mass., was Supt. of the Worcester Gas Light Company, see *JOURNAL*, Vol. XIV., No. 1., pp. 3, and 4.

1874, a patent (No. 151,263) was taken out in the United States, and afterwards, in July, another patent (No. 153,886), for certain novelties in construction, was granted to Mr. James R. Smedberg.

The first trial of the machine in this country was made by the San Francisco Gas Light Company, in 1874, since which time numerous other machines have been introduced into some of the largest works of this country. Aside from its effectiveness in removing the tar from the crude gas, another great recommendation for this condenser is its compactness, and the small space it occupies in relation to the work it performs—especially in comparison with the old, cumbrous and expensive machinery formerly in use, and of which it may be said never successfully accomplished the end sought after. On the 6th of October, 1884, the Providence Gas Company introduced a Pelouze and Audouin condenser at their South Station, which has been in successful operation since that time. Aside from reducing the temperature of the gas to the normal standard, the use of the Pelouze and Audouin condenser simplifies the treatment of the gas, practically, to two operations—the removal of the tar, and facilitation of purification; the latter being easily accomplished when once the tar is eliminated. I think we all agree that the application of a large quantity of cold water at any stage of the process of manufacture is highly detrimental, and probably never would have been practiced had the removal of the tar been successfully accomplished.

It is now well known that the proper application of a small quantity of water, at the proper temperature, will eliminate the ammonia, and lime can be depended upon for the removal of the carbonic acid and the sulphur compounds.

SPECIAL ENGLISH CORRESPONDENCE.

COMMUNICATED BY NORTON H. HUMPHRYS.

LONDON, July 10, 1885.

The Recent Meeting of the Gas Institute.—The President's Address.—The North British Association of Gas Managers.—Murdoch Memorial.—Prize Competition.—Sanitary Gas Making.—A Correction.—Public Lighting with Oil.

Having given a general outline of the programme arranged for the proceedings of the recent annual meeting of the Gas Institute, it only remains for me to add that the whole passed off satisfactorily, and to congratulate the Council of the Institute, the local Reception Committee, and their Honorary Secretaries, Messrs. Thomas and Hutchinson, on the success that covered their efforts. The weather was favorable throughout, which was an important item, seeing that the afternoon of each day was devoted to outdoor excursions to various works, etc. It is, perhaps, to be regretted that of the twelve papers submitted to the meeting no less than four were taken as read, for lack of time; but it is difficult to see how this can be avoided. The proceedings, both with regard to the reading of papers and the discussions, start at an easy pace; as time passes they increase in rapidity; and towards the close symptoms of a desire to hurry the papers, and take short cuts through the discussions, manifest themselves in a manner that is hardly complimentary to the readers of the papers, who have devoted as much time and trouble to the preparation of the same as their more fortunate brethren whose papers happen to come early in the list. It sometimes happens, too, that the papers are not arranged in order of sequence, according to the plan that would appear best in the interests of the members, to whom, of course, the discussions are the principal consideration, seeing that they can read the papers in print at their leisure. This plan would be to put the paper likely to bring out the most useful discussion first, and so on, entirely irrespective of the names of the readers; if this was adhered to the meeting would not lose an hour or more of valuable time discussing a philosophical problem, remote so far as the objects of the Institute are concerned, although very interesting from a scientific view; whilst such important questions of the day as "lighting and ventilating" and "gaseous fuel" are hurried over with no discussion worth the name, and other strictly practical subjects are left out altogether. * * * But it is so easy to find fault, and so difficult to suggest a real improvement!

The premiums for papers read at last year's meeting were awarded as follows: First prize and president's medal, to Mr. W. A. Valon, for his paper on "Generator Furnaces," to which I have frequently had occasion to refer during the past year; the second prize to Mr. F. S. Cripps, for his paper on "Gasholder Crowns;" and the third to Mr. W. J. Booer, of bakers oven notoriety, for a paper describing his gas apparatus capable of being adapted to any baker's oven. The sums dispersed as premiums are scarcely commensurate with the importance of the Institute, this item appearing in last year's balance sheet as £23 (\$115), and being divided, as on this occasion, between three recipients. So it barely represents an adequate remuneration for the preparation of the paper, far less anything like a prize or reward, so far as actual pecuniary benefit is concerned.

The inaugural address of the President, Mr. Thomas Newbigging, has attracted much more attention outside the Institute than is usually accorded to these productions; and this, apart from the author's eminence, both as a *litterateur* and a gas engineer, purely on account of its intrinsic merit. For it is a masterpiece of presidential addresses, both in respect to the soundness of its facts and the elegance of its composition; as such it commends itself to the practical man, and also to the classical scholar. It is a pleasing combination of graceful poetical fancy, with stern, rugged truth. Anything like a detailed notice of the various points touched upon is out of the question here, since a special feature of the address is its completeness, scarcely any current topic passing untouched; but the manner in which the electric light was dealt with should be especially mentioned. Probably no one else could have so clearly represented the views of gas engineers on this subject. Many of the daily newspapers are disposed to question Mr. Newbigging's views, as is only to be expected, seeing that most of them aim at tickling the public mental palate rather than administering wholesome food for the mind; and the man who tells the plain, unvarnished truth about the electric light dodges of the last few years, must not expect to please the representatives of public opinion.

But we must pass on from the meeting of the Gas Institute to the forthcoming meeting of the North British Association of Gas Managers, to be held on the 23d and 24th inst., and in connection with which there are one or two special features to be noticed. In the first place a spirited endeavor is being made by this Association to raise a memorial fund for the purpose of perpetuating the memory of William Murdoch, the founder of gas lighting. This, of itself, would constitute a good reason for offering exceptional honor; but according to a brief epitome of Murdoch's life, attached to the subscription list which has been widely circulated amongst the profession, it appears that he has many other claims, and that he is indeed entitled to be styled "a great Scotch inventor." One or two inventions with which he has been generally identified—the mechanical movement known as the "eccentric," for instance, do not appear in this list; and Murdoch is credited with having freely given his inventions in connection with gas lighting to the world, but so far as may be judged from the published accounts of his life, it appears to have been rather through inadvertence than intentional generosity that he failed to protect his system of gas lighting by letters patent. He was so much engaged with steam engines and other matters that he does not appear to have appreciated the important position to be occupied by the gas industry. However, all will agree that a handsome monument to his memory would be but a simple act of justice; and the work he did in connection with steam engines entitles the movement to liberal support from all users of steam power.

In connection with this meeting there is another feature, also of a cosmopolitan character, in the shape of an open competition for the best papers on, "How best to utilize gaseous fuel and coke for domestic and industrial purposes, with a view to abate the smoke nuisance in towns." The first prize (value £50) has been offered by Mr. Allan, proprietor of *Gas and Water*, and the second prize (£20) by Mr. Ellis Lever, of Liverpool; in addition, the adjudicators have the right of recommending a third paper for a special prize. This system of open competition, in connection with essays treating of particular subjects, appears to be gaining favor. It has been applied several times lately in connection with various subjects, though never before, so far as I am aware (perhaps the small premiums offered by the Gas Institute should be mentioned as in some sense exceptions), in connection with the gas industry; and it will be interesting to watch the result of this innovation. It can scarcely be otherwise than satisfactory; but, in any case, the North British Association deserves credit for the energetic way in which they have taken the matter up. The extra work thrown upon the Honorary Secretary, Mr. David Terrace, by these special features will also receive proper appreciation, and, I may almost venture to add, substantial recognition.

Prof. Wanklyn, ever indefatigable in the interest of Cooper's coal liming process, has appeared before the Association of Municipal and Sanitary Engineers and Surveyors, with a paper on, "Sanitary Gas Making." He is rather severe on the gas industry. To say that certain parts of the process of gas making are "peculiarly disgusting," and consequently that a gas works has to be banished as far as possible from human habitations, is stepping outside the bounds of strict veracity, seeing that numbers of gas works are closely surrounded on all sides with "human habitations," and the only disadvantage (?) due to close proximity to the "peculiarly disgusting" works is that the people enjoy a marked freedom from cholera; and also, though perhaps in a less extent, from other zymotic diseases. Then the Professor ventures the statement that, up to the introduction of Cooper's process, "very little had been done in the way of rendering gas manufacture cleanly." But, while Cooper's process is to prevent the pollution of the atmosphere by foul purifying material, it is with some surprise that I find, after the above statement, that it is not equal to the entire cure of the present dirty habits of gas engineers. It is not the real "Pear's soap" that is to wash the black man white; but, of course, it is indispensable to that process, for under the

ennobling influence of Cooper, the Professor infers that the gas engineers' present slovenly habits and feeble intellectual powers will be stimulated and strengthened to the perception of nuisances and defects to which he is at present blind. One of these is the emission by the chimneys of yellow smoke at short intervals, due to the combustion of small quantities of tar in the retort house. When the retort is opened, we are told, the small quantity of tar in the mouthpiece is partly burned, and partly mixed with the coke, rendering it dirty. The action of mixing tar with red-hot coke, by-the-way, must be a peculiar one. The remedy for this serious nuisance (?) is a descending ascension pipe and an underground hydraulic main. The next thing is that gas liquor is allowed to leak into the ground and evaporate into the air; and this is due to "bad habits which date from the time when gas liquor had no commercial value." After this what board of directors can have the temerity to avoid insisting on the adoption of Cooper's process, with the attendant benefits of no yellow smoke or waste of liquor?

Coming down to sober fact, it appears that the Cooper process proper is entitled to some credit, not for avoiding altogether the nuisance attendant upon the exposure of foul purifying material, but for enabling the purifiers to go longer and require less frequent changing. It is true that at Tunbridge Wells the purifiers have gone a year or so without opening; but this was effected by the admission of air into the gas—a process which is in no way related to Cooper's process, and which, with the precaution of ample washing and large purifiers, might be adopted at any gas works. And without these precautions, the necessity for which, in ordinary working, has been generally known for many years, it is impossible to avoid nuisance under any circumstances. There is no reason to doubt the claim that the Cooper process retains a considerable proportion of sulphur in the retort, leaving a proportionally less amount of work for the oxide purifiers to do; but this fact has no bearing upon the nuisance question, except in degree—perhaps where a purifier was formerly opened every month, now it is only opened every three months, or something like that.

In my letter appearing in December last (Vol. XLL, p. 290), I stated that "on the authority of Prof. Vernon Harcourt it is said that the Cooper process retains five-sixths of the total quantity of the sulphur present, leaving only one-sixth to be recovered in the oxide purifier." The Professor has since pointed out to me that this was simply a computation made by him, based upon the claim that one per cent. of air admitted to the purifier was sufficient. "I think," he said, "that I am only responsible for the bit of chemical arithmetic."

I notice that one or two local authorities are going in for lighting the public lamps with oil in preference to gas. It is rather remarkable that this should be so, seeing it has been proved, over and over again, that oil lamps are not efficient, though cheaper than gas if the price of the latter is high. The real object is to bring some opposition to bear against the gas company, and it frequently arises from matters of a personal nature. This is very evident in the case of Slough, where complaint has been made as to the quality of the gas supplied; in which town it was stated, at a meeting of the Urban Sanitary authority, that the oil lamps appeared to give a good and steady light, sufficient for the purpose in view; and at the same meeting the surveyor stated, without contradiction, that the oil lamps were not so good as gas. The fact that gas remains the only efficient and reliable agent for street lighting cannot be gainsaid, and the Slough authorities will find that although they may possibly get along for a time with oil or electricity, it will only be—as was the case at Wimbledon, Winchester, Chesterfield, Poole, Dawlish, and many other places—at the expense of public comfort and convenience, if not safety. I do not say this for the purpose of encouraging gas companies to assume a high hand with local boards; for it cannot be otherwise than unfortunate in many ways to the former if a disagreement springs up between them and their customers. A liberal policy in regard to the public lighting is the best in the end.

The Use of Sulphate of Ammonia as Manure.

Mr. William Arnold, the Chairman of the Tamworth Gas Company (and who is also one of the Surveyors and Umpires of the Railway Department of the Board of Trade), has forwarded the following remarks upon the use of sulphate of ammonia as a manure, with general directions for its use, and the crops for which it is most suitable:

"Sulphate of ammonia is one of the most powerful fertilizers known to modern science. It is especially rich in nitrogen; and when used either by itself or in conjunction with farmyard manure its good effects are written so plainly, in better quality and largely increased yield of corn, that no farmer who has once used it will ever give it up, but will, on the contrary, annually increase its use upon his farm.

"When bought at first hand from a gas works sulphate of ammonia is guaranteed to contain more than *twenty per cent. of nitrogen*. Hence its excellent effect upon all corn crops, which is chiefly expended in increasing

the yield of grain, but not the straw; and there is, therefore, much less risk of 'lodging' from heavy rains. This is a very important advantage. Then manure rich in nitrogen increases the proportion of gluten in cereals; and this increase is stated by Boussingault to be as much as 10 per cent. With an increase, therefore, of 10 per cent. in quality and of 20 per cent. in yield, the use of sulphate of ammonia ought to be increased tenfold, to the great advantage of the English farmer, for both may be done.

"The most suitable dressing is one of from 2 to 3 cwt. per acre, mixed with an equal weight of fine dry earth or sand, and applied early in the spring (say March or April), in moist or showery weather. It should be thoroughly mixed in a barn or dry shed, and, if at all lumpy, beaten with a shovel and passed through a 45-mesh riddle. It should be carefully sown by hand, or, if in large quantities, with a manure drill. If wheat is to be grown entirely with sulphate of ammonia, it is best to put it on in two dressings—one half in autumn and the other half in spring.

"Upland or meadow grass, wheat, barley, oats, rye, colza, hemp, mangel-wurzel, cabbages, hops, garden produce generally, and beetroot (when grown for sugar), are the crops most largely benefited by this manure; simply because nitrogen, which is its dominant element, enters largely into their composition. For instance, colza, hemp, and beetroot, require each of them 70 pounds per acre of nitrogen to produce a full and healthy crop; wheat, 53 pounds; and barley, oats, and rye, 35 pounds per acre each.

"Beans, peas, sainfoin, or clover, in which potash is the dominant element, are not benefited by an application of sulphate of ammonia; but almost all other crops that can be grown will richly repay its use.

"In the case of a crop thinned out by wire worm, the ravages of birds or insects, or by a severe winter, the application of 2 cwt. of sulphate of ammonia early in the spring, and lightly harrowed in, will, in many cases, cause a crop that looked only fit to plough up to tiller freely, and grow away into a full yield of corn for the district."

When sending his communication (given above) Mr. Arnold wrote: "For many years I have bought sulphate of ammonia and other chemical manures from the manufacturers, and have *mixed them carefully myself at home*, with the result that I have saved about 33 per cent. in cost, and probably in many cases 20 to 25 per cent. in freedom from adulteration; and, in addition, the heavy commissions paid by manure manufacturers to agents. Even with the best of manure manufacturers, the scale of profit is so heavy that, for a manure costing the farmers, say, from £7 to £8 per ton, I do not think he obtains more than from £3 to £4 per ton manurial value. There is evidently a wide field here for the farmer to buy at first hand, and mix himself; or for co-operative farmers' associations to do so, and supply on much better terms, and to far greater advantage than now generally obtains."—*London Journal of Gas Lighting*.

ITEMS OF INTEREST FROM VARIOUS LOCALITIES.

GAS RATES AT BEAVER FALLS, PA.—Mr. J. M. Critchlow, Superintendent of the Beaver Falls Gas Company, has kindly furnished us the following list of rates charged for gas in that city; all figures apply to monthly consumption in thousand feet: 100 to 900 feet, \$1.80, with discount of 10 per cent.; 1,000 to 4,900, \$1.50, discount 10 per cent.; 5,000 to 9,900, \$1.50, discount 12½ per cent.; 10,000 to 24,900, \$1.50, discount 16½ per cent.; 25,000 to 49,900, \$1.50, discount 20 per cent.; 50,000 to 100,000, \$1.50, discount 25 per cent.; 100,000 to 200,000, \$1.50, discount 33½ per cent.; 200,000 and over, \$1.50, discount 40 per cent. Discounts apply only in cases where accounts are settled between third and tenth days of month in which bills are presented. It will be noted that the average consumer obtains his supply of gas at a very reasonable rate. Critchlow is an enterprising manager.

PERSONAL.—Mr. T. A. Bates, Superintendent of the Los Angeles (Cal.) Gas Light Company, has tendered his resignation of that position, and will sever relations with the company on August 1st. Bardstown, Nelson County, Ky., will in all likelihood be his future address.

OF INTEREST TO CONTRACTORS.—Judging from the character of the advertisements that have recently appeared in some of the Western newspapers, Waco, Texas, is desirous of erecting a new gas works. The advertisements call for bids for the construction of a plant equal to the requirements of a population of 15,000. It is stated that the city will need about 75 street lamps—rather a meager allotment, it would seem, considering the number of inhabitants. "T. L. Smith, Chairman, Gas Works," should be applied to—at least, so the advertisers put it.

WE DO NOT CHARGE THEM FOR THIS.—While the "National Gas Light and Fuel Company," with headquarters at Chicago, Ills. (and undoubtedly desirous of establishing outposts wherever they can secure a foothold), do not advertise in the columns of the JOURNAL—indeed, it is more than likely that they never will—we cheerfully accord them the following dishonorable

mention: Acting after the manner of another celebrated "Company," they are mailing to all points a very neatly arranged circular letter—one of the typewriter sort—describing the peculiar merits, beauties, and ultra-efficiency of the Springer system of gas manufacture. Of course these worthies adhere closely to the truth—that is, they would not stray from the path of honest statement any further than to say that "two-thirds of the city of Chicago are now lighted by gas made with this system." An elegantly compiled sentence; and so strikingly truthful! Perhaps Messrs. Watkins and Forstall have shut down the retort houses of the Chicago Gas Light and Coke Company. Still, we rather guess not. It has been reported that some short while since an attempt was made to effect one grand combination between "all sorts and conditions" of the water gas speculators, and that the scheme fell through. What a prize menagerie that collection would make!

OUR ALERT HEALTH BOARD.—The Health Commissioners of New York city, with that great regard for the public good which has always characterized their action, have notified the Directors of the Consolidated Gas Company that "deodorizers" must be placed in the stations of the Metropolitan and Knickerbocker plants, and have forbidden them to cart foul lime through the streets. Such material must hereafter be taken away in boats. We believe the Harlem station was also included in the notification, and not a foot of gas has been manufactured there for months. Sharp people, those Health Commissioners of ours. The managers of the Equitable Company were also directed "to abate the fouled lime nuisance."

CHEAPER GAS FOR ALTOONA, PA.—Mr. T. W. Cole, Superintendent of the Altoona Gas Company, writes us that on July 1st the price of gas in that city was reduced to \$1.60. We believe this means a reduction of 15 cents per thousand. Altoona is a growing place, and the gas works is a credit to the city.

SHUTTING DOWN GAS WORKS.—Mr. Daniel Leach, of Fulton, Mo., writes us, under date of July 15, that the gas works located at Fulton, for the supply of light to the buildings known as the "Deaf and Dumb Institution" and "Insane Asylum No. 1," are about to be shut down, in consequence of the fact that the managers of both establishments have decided to employ electricity hereafter as the lighting agent. The arrangement made authorizes the United States Electric Light Company to furnish plant and power for the maintenance of 500 sixteen-candle power burners at the Insane Asylum; while the Edison Company is to operate 326 burners, of similar candle power, at the Deaf and Dumb Institution. Wires are now being laid on in both buildings. The gas works was the common property of both institutions, and it is hard to arrive at a reason explanatory of the change, unless possibly the gas plant required the expenditure of considerable money in the line of betterments, etc. Even then the sagacity or economy of the new departure would seem more than questionable.

THEY DID NOT SHUT DOWN.—In the "item" referring to the statements conveyed by the "Springer circular" as to the "fact" that two-thirds of the gas made in Chicago was manufactured under the "Springer process," it was hinted that Mr. Forstall might have shut down the old Chicago works—the hint being advanced so as to save the Springer manipulators from the charge of untruthfulness. But it is of no avail; their Ananias-like reputation is more than ever sustained in view of late information forwarded us by the genial Mr. S. S. Townsend, of New York city. Mr. T. writes us that Messrs. P. H. & F. M. Roots, of Connersville, Ind., are constructing one of their largest size (No. 6) gas exhausters, with engine on bedplate, for the Chicago Gas Light and Coke Company. Could it be possible that the Springer typewriter is at fault; or that the indicter of the circular letter meant to say that the Springer folks would like to furnish two-thirds of the city of Chicago with gas? Mature reflection inclines us to believe that this also is a wrong view, since did he make an attempt at telling what they would "like" to do the entire supply of the Lake City would just about satiate his and their ambition.

PUTTING IT IN PLAIN TERMS.—The following circular, issued under date of July 10th, and headed, "How to Reduce Your Gas Bill," was handed to the consumers of the Fairfield (Ia.) Gas Works, by direction of Superintendent F. E. McMillin. We think the managers of small plants throughout the country will at once grasp the point contained without any further comment:

"While gas is cheaper now in Fairfield than in most other towns with same population in this State, it is possible to have the price still further reduced. The gas works can make no money at present price of gas; you cannot afford to pay a higher price. We know of but one expedient to remedy this that may be tried with any hope of success—a reduction in rates granted on account of increased consumption. We do not sell enough gas; we should have double the number of consumers we now have. In some towns a single

consumer will burn more gas than is burned by all our consumers. That is the case in some of the small towns of our State. Will you not assist us in trying to increase our output? Talk to your neighbor; perhaps he is almost persuaded now, and a few words from you will induce him to adopt gas for lighting his premises. We make the following proposition:

"If we can obtain 20 additional consumers on or before the 15th of September, the price of gas will be \$2.80 per 1,000 feet on and after the first of October—the discount remaining the same as heretofore. We further agree to make an additional reduction of ten cents per thousand feet for each additional ten new consumers, until the gross price shall be reduced to \$2.40, and net price for largest consumption to \$1.90. With us this will be an experiment. The new consumers may not burn enough to justify the reduction. With you it is a certainty. If the consumers are secured you get cheap gas whether it pays us or not." Looking at it from this distance, we are inclined to assert that the experiment is a pretty safe one to venture upon. We expect that Mr. McMillin will write us to that effect next fall.

PROJECTED OPPOSITION AT ALBANY, N. Y.—Articles of incorporation for a new gas company at Albany, N. Y., were filed with the Albany County Clerk, on date of July 13th. The incorporators are E. C. Benedict and A. L. Farr, New York city, and E. Murphy, jr., of Troy, N. Y. Capital stock is placed at \$700,000, divided into 7,000 shares, par value being \$100. An "improved" method of gas manufacture is to be employed. Mr. Battin may be counted upon to take care of these parties in proper style; and if blackmail pure and simple is at the bottom of their scheme they had better stop at once.

PROMOTED.—At a regular meeting of Board of Directors of the Metropolitan (Brooklyn, N. Y.) Gas Light Company, held Tuesday, July 14th, Mr. Chas. H. Stoddard was elected to the presidency of that corporation, succeeding Mr. John Williams, resigned. The choice is a good one, inasmuch as Mr. Stoddard had occupied the dual position of Secretary and Treasurer to the company for a number of years.

AWARDED A CONTRACT.—Mr. Adam Weber, proprietor of the Manhattan Fire Brick and Enamelled Clay Retort Works, New York city, is furnishing retorts and settings for 12 benches of "sixes," to the order of the Chesapeake Gas Light Company, of Baltimore, Md.

CHEAPER GAS FOR LAWRENCE, MASS.—Mr. C. J. R. Humphreys, in charge of the Lawrence Gas Light Company, has notified his consumers that all ordinary consumption of gas will in future be charged for at the rate of \$1.60 per thousand. Prior rate was \$1.90; and the new scale went into effect on July 1st. Humphreys is an advocate of cheap gas, and of good gas, too. With his deft management of the tiller the stockholders of the Lawrence Company can always count upon "making port."

BAXTER BEAT THEM.—Brother Wm. H. Baxter, of the Petersburg (Va.) Gas Light Company, has just been engaged in a "brush" with the would-be electrical promoters of his vicinity, and the returns show that he beat them. The electrical purveyors were anxious to secure a contract for lighting the streets, and made the usual promises concerning effectiveness, cheapness, etc. The Council was at first inclined to look with favor upon the scheme, but Baxter's arguments had such weight that the authorities finally concluded to make a contract with the Petersburg Gas Company, under the terms of which the streets and public buildings of the city are to be lit by gas for the next three years. Lamp posts are to be charged for at an annual price of \$25 each, and gas supplied to public buildings is to cost \$1.90 per thousand cubic feet. The new contract bears date of July 1st; and it is almost needless to add that the Petersburg gas folks are in "high feather."

THE CIRCLEVILLE (OHIO) GAS LIGHT COMPANY VANQUISHES THE ELECTRICAL PROMOTERS.—There has been a lively rumpus out in Circleville (between the local gas company and the local Edison electric lighting managers), and the first named participant therein has secured the honors—and a contract. At the Council meeting held July 15th the specifications to govern bids for street lighting for ensuing year were presented and adopted. The specifications (the arrangement of which had been known for some time) were decidedly favorable to the electric lighting promoters; indeed their provisions were such as to make the Edison men feel quite confident that the gas company would be unable to make any showing at all. As an instance, 9 lamps were required to be located in out-of-the-way places, and in such situations the Council forbade the maintaining of oil lamps, although oil lamps could be employed in other parts of the city. These 9 lamps entailed the laying of about one-half a mile of extra main; and it was also specified that all lamps should be lighted and extinguished at the exact time named in the agreement. In several minor ways it was also sought to harass the gas company, and the electric folks had the thing down so fine as to lead them to suppose that no competitive bid would be offered against them,

Here it may be incidentally remarked, on behalf of the Edison promoters, as a reason for their strenuous efforts to obtain the street lighting at Circleville, that they were in great financial straits, hence their activity—it appears really to have been a case of “contract or death.” The electricians called to their aid reinforcements of persuaders from Cincinnati; and the special services of “Mister” Fitch, of Louisville (Ky.) water gas fame—by-the-way, Barret ought to be making things hot enough for Fitch to keep him at home—were also enlisted. They made all sorts of propositions to Mrs. Moore (the widow of Mr. E. D. Moore, former proprietor of the Circleville Gas Company) in the attempt to prevent her from making a bid on the lighting; but Mrs. M. was “in the fight to stay.” Fitch, we believe, went so far as to make the claim that he (or his backers) had leased the Circleville works before her husband died, and absolutely forbade her from entering into the competition. He might as well have saved himself all bother in the premises; and, in passing, attention might be called to the close bond of sympathy that seems to exist between the water gas gentry and the electric lighting speculators in more than one section of the country. Mrs. Moore, after consultation with Mr. Emerson McMillin, of Columbus, Ohio, decided upon the action to be taken; and, in accordance therewith, through her agent, at the Council meeting spoken of above, submitted the figures at which the Circleville Gas Company would agree to perform the required lighting service. Below is given the aggregate bid price of the two competitors for the different contract periods. The gas company’s bid is for the lighting of 135 lamps, while that of the electric company is based on the furnishing of 99 lights, equal to 135 lights of 16-candle power each:

	Gas Company.	Electric Company.
For one year.....	\$1,344.60	\$2,000
For two years.....	3,020.10	4,995
For three “.....	4,634.55	7,695
For four “.....	6,208.65	10,530
For five “.....	7,558.65	13,500

The bids were based on a certain specified moon-table.

To say that Fitch’s partners were surprised at this state of affairs but very faintly describes “their state of mind;” and before they could recover a proper mental balance Councilman Salters moved that the City Solicitor be instructed to draw up a formal contract, in accordance with bid and specifications, between the city and gas company, binding the parties thereto for the term of five years. The motion was carried. The gas company also made a proposition in which it agreed to light the lamps all night and every night in the year during five years for a total sum of \$9,112—or at the rate of \$13.50 per post. It is possible that when the Council is called upon to finally ratify the instrument drawn up by solicitor the latter proposition may be substituted for the former. Should the city do its own lighting and extinguishing, the gas company will make a reduction of \$480 per year from its bid. Well done, Mrs. Moore!

FATAL ACCIDENT.—On the afternoon of Tuesday, July 14, a fatal accident occurred at the premises on which a new holder is being erected to the order of the Albany (N. Y.) Gas Light Company. The disaster was occasioned by the “kicking” of a derrick. The victims were Joseph Pernet (who had for years been in the employ of Messrs. R. D. Wood & Co., proprietors of the Camden Iron Works, Phila., Pa.), Michael Roach, and William McCarty, both of Albany.

CARBONIC OXIDE WAS THE CAUSE.—The New York *Daily Tribune*, date of July 4, contained the following: “A beardless young man entered the Richmond Hotel, No. 34 East Twelfth street, about 9 A.M. yesterday, and inquired for his sister, whom he had taken to the hotel late on the previous night. Being told that she had not left her room, he went upstairs with a porter to call her. At the door of the room a strong odor of gas was noticed, and repeated knocks failed to elicit any response. When the door was broken open Miss Kennedy was found dead in bed. She had been suffocated in her sleep by the gas emitted from a turned-on burner. She had arrived in the city on the 2d of July, and intended journeying to Philadelphia on the 3d, there to pay a visit to her aunt. She had been in vigorous health.” Vigorous health never stays the death dealing power of CO.

NOTHING NEW IN THE DUNBAR CASE.—Up to our present advices the murderer of Mr. Geo. S. Dunbar, of Pittsfield, Mass., still remains undiscovered. The intimation is made that deceased committed suicide, but not the slightest evidence tending to prove the assertion has as yet been offered. The police have a most unpleasantly ready style of making such a charge. It may save them trouble, and they do not appear in any way concerned about the fact that such an imputation serves but to throw a cloud of shame over the memory of the dead. Mr. Dunbar was undoubtedly the victim of an assassin.

CHEAPER GAS FOR NASHUA, N. H.—On more than one occasion it has been our pleasant duty to bear witness in these columns to the business tact

and cleverness of the gentlemen in charge of the Nashua Gas Light Company; and here they come with another sample or instance of how the thing should be done. Superintendent A. M. Norton (the gas man that was made a Mayor) is probably responsible for the policy pursued in the past, and more than likely is to be charged with the latest announcement that from and after October 1st, 1885, the Nashua gas consumer will obtain his supply at the figure of \$1.60 per thousand cubic feet. In 1873 the yearly output of the Nashua Company was, in round numbers, 7½ millions; in 1885 the total send-out may be put at 18 millions. In 1873 \$3.80 per thousand cubic feet was the selling price; 1885 will see it at \$1.60. Among other things, when dealing with the reduced gas rate, the Nashua *Daily Telegraph* says: “Good, square, liberal management like that illustrated in the case of the Nashua Gas Light Company has more than a local value; it is an example that shines like a light on the hill-top, and furnishes both a light and a hint to other corporate interests that deal with the public.” Who knows but that they might yet send Norton to Congress?

APPOINTING A MASSACHUSETTS BOARD OF GAS COMMISSIONERS.—The Hon. H. B. Pierce, Secretary of the Commonwealth of Massachusetts, gave notice that the Governor, on date of July 16, with advice and consent of the Council, had named the following gentlemen to serve on and compose a board of gas commissioners: Messrs. Starkes Whiton, of Hingham; Edward T. Rowell, of Lowell; and F. E. Barker, of Worcester. Mr. Walter S. Allen, of New Bedford, was named to serve as clerk to the board. These appointments are favorably commented upon.

AN AMUSING INTERVIEW.—A reporter of the Chicago *Inter Ocean* recently interviewed a certain Mr. C. R. Cummings, said to be a large holder of the bonds of the Consumers Company of that city, in regard to the bad financial outlook for that corporation. Mr. Cummings was in a decidedly chatty vein, and his remarks are quite amusing. In answer to the question as to why it was that gas sold at such a low price in Chicago, Mr. C. responded: “When the Consumers Company was organized and commenced doing business the old company was charging \$2 and \$2.50 per 1,000. It at once made the price \$1, and of course the new company could not expect to do very much business at a higher rate. I hear it stated that the old company has lost over one million dollars in its attempt to destroy the new company, and yet the plant of the new company remains, and when the new company is re-organized it will be in position to carry on the war, if necessary, indefinitely.” Now comes the little joker—just merely thrown out as a suggestion of the reporter’s. “Only that, and nothing more.” Reporter—“Would it be possible for the old company to get possession of the new one; and what would be the result if it should?” Cummings—“It has just as much right as anyone else to purchase the securities, and if I were the old company, and could get control, I would not sell gas for \$1 per 1,000 very long.” Mr. Cummings admits that the new company’s plant is still there, but seems to forget that the old Chicago plant is yet growing. President Watkins knows enough about agriculture to understand that too much water is a bad thing; and as Mr. Cummings is one of the later-day bondholders in the Consumers Company, he has probably found out by this time that the famous Chicago Construction Company of four years ago had an extra supply of watering-pots in its tool chests. The watering-pots were not always kept in the tool chests, though; many an active hour’s duty they saw. [Since the above was written we have received information that Mr. Judson, President of the Consumers Company, was recently appointed its receiver.]

ANOTHER DEATH.—A telegram from Cape May, N. J., dated July 11, conveys the news that Mr. Otto Fridberg, a member of the firm of Fridberg & Adler, doing business at 92 Reade street, New York city, was found dead in his bed at the new Columbia Hotel, on the night of July 10th. Death ensued from the inhalation of illuminating gas that had escaped through a turned on burner. The key to gas burner was defective.

DETERMINING THE INCREASE OF THE EARTH’S TEMPERATURE TOWARD ITS INTERIOR.—According to the London *Times* the German Government is sinking a deep shaft near Schladebach, with the especial object of obtaining trustworthy data concerning the rate of increase of the earth’s temperature toward the interior. At the beginning of this year the shaft had reached the depth of 1,392 meters. The temperature at successive stages is ascertained by a special thermometer, the principle of construction being that as the heat increases the mercury will expand so as to flow over the lip of an open tube. The difference of the overflows will give the rate of increase in temperature. At the depth of 1,392 meters the temperature was shown to be 49° C., or 120° F. Should this ratio of increase be maintained the boiling point of water ought to be reached at a depth of 3,000 meters, and at 75 kilometers (46+ U. S. miles) we should find the heat at which platinum melts. This would go to show that the earth’s crust cannot be more than about one-ninetieth of its radius.



MONDAY, AUGUST 3, 1885.

The Market for Gas Securities.

The market for city gas shares presents no special change, save in the case of Mutual. This security is decidedly stronger. Those in charge of the Equitable manipulation predict higher prices for their pet parchment. No doubt they can secure this result—they can move it up or down at their own sweet will. Consolidated gas shows no variation, and it may be noted that the market is almost lifeless, so far as actual business transactions are concerned. The brokers are complaining about the extreme dullness of the situation; but let them possess their souls in patience, the back end of October will see them busy enough.

Gas Stocks.

Quotations by Geo. W. Close, Broker and Dealer in Gas Stocks,

16 WALL ST., NEW YORK CITY.

AUGUST 3.

All communications will receive particular attention. The following quotations are based on the par value of \$100 per share.

	Capital.	Par.	Bid	Asked
Consolidated.....	\$35,430,000	100	94	95
Central.....	440,000	50	60	70
“ Scrip.....	220,000	—	47	57
Equitable.....	2,000,000	100	136	140
“ Bonds.....	1,000,000	—	107	110
Harlem, Bonds.....	170,000	—	—	—
Metropolitan, Bonds....	658,000	—	110	113
Mutual.....	3,500,000	100	135	137x
“ Bonds.....	1,500,000	1000	104	107
Municipal, Bonds.....	750,000	—	—	—
Northern.....	125,000	50	50	—
“ Scrip.....	108,000	—	—	—
Gas Co's of Brooklyn.				
Brooklyn.....	2,000,000	25	129	131
Citizens.....	1,200,000	20	86	88
“ S. F. Bonds....	320,000	1000	106	110
Fulton Municipal.....	3,000,000	100	158	160x
“ Bonds.....	300,000	—	104	108
Peoples.....	1,000,000	10	85	87
“ Bonds.....	290,000	—	105	110
“ “.....	250,000	—	90	95
Metropolitan.....	1,000,000	100	94	96
Nassau.....	1,000,000	25	125	127x
“ Cfts.....	700,000	1000	98	99
Williamsburgh.....	1,000,000	50	151	153
“ Bonds... ..	1,000,000	—	111	114
Richmond Co., S. I.	300,000	50	64	75
“ Bonds.....	40,000	—	—	—
Out of Town Gas Companies.				
Buffalo Mutual, N. Y. ...	750,000	100	80	85
“ Bonds... ..	200,000	1000	95	100
Citizens, Newark.....	918,000	50	103	115
“ Bonds.....	124,000	—	105	110
Chicago Gas Co., Ills... ..	5,000,000	25	128	132
Peoples G. L. & C. Co., Chicago, Ills.....			8	12
Cincinnati G. & C. Co..			180	182
Consolidated, Balt.....	6,000,000	100	42	43
“ Bonds.....	3,600,000	—	107	107½
Central, S. F., Cal.....			—	58
Capital, Sacramento, Cal.			56	—
Hartford, Conn.....	750,000	25	123	129
Jersey City.....	750,000	20	145	—
Laclede, St. Louis, Mo.	1,600,000	100	100	105
Louisville, Ky.....	1,500,000	50	95	100
Montreal, Canada.....	2,000,000	100	181	182½
New Haven, Conn.....		25	166	170
Oakland, Cal.....			29	30

Advertisers Index.

	Page
GAS ENGINEERS.	
Jos. R. Thomas, New York City.....	43
Wm. Henry White, New York City.....	78
GAS WORKS APPARATUS AND CONSTRUCTION.	
James R. Floyd, New York City.....	79
T. F. Rowland, Greenpoint, L. I.....	79
Deily & Fowler, Phila., Pa.....	79
Kerr Murray Mfg. Co., Fort Wayne, Ind.....	79
Stacey Mfg. Co., Cincinnati, Ohio.....	79
Bartlett, Hayward & Co., Baltimore, Md.....	79
Morris, Tasker & Co., Limited, Phila., Pa.....	78
Davis & Farnum Mfg. Co., Waltham, Mass.....	80
Tanner & Delaney Engine Co., Richmond, Va.....	78
R. D. Wood & Co., Phila., Pa.....	78
Southwark Foundry and Machine Co., Philadelphia, Pa.....	78
GAS AND WATER PIPES.	
A. H. McNeal, Burlington, N. J.....	76
Gloucester Iron Works, Phila., Pa.....	76
Warren Foundry and Machine Co., Phillipshurgh, N. J.....	76
Mellert Foundry and Machine Co., Reading, Pa.....	76
Cincinnati and Newport Iron and Pipe Co., Newport, Ky.....	76
Fox & Drummond, New York City.....	76
PIPE JOINTS.	
Pancoast & Maule, Philadelphia, Pa.....	71
Rollstone Machine Company, Fitchburg, Mass.....	71
SCRUBBERS AND CONDENSERS.	
G. Shepard Page, New York City.....	77
REGENERATOR FURNACES.	
Charles F. Dieterich, Baltimore, Md.....	52
GAS ENGINES.	
Schleicher, Sebumm & Co., Phila., Pa.....	56
Clerk Gas Engine Company, Phila., Pa.....	72
RETORTS AND FIRE BRICK.	
J. H. Gautier & Co., Jersey City, N. J.....	74
B. Kreisler & Sons, New York City.....	74
Adam Weher, New York City.....	74
Laclede Fire Brick Works, St. Louis, Mo.....	74
Brooklyn Retort and Fire Brick Works, Brooklyn, N. Y.....	74
Borgner & O'Brien, Phila., Pa.....	74
William Gardner & Son, Pittsburgh, Pa.....	74
Henry Maurer, New York City.....	74
Chicago Retort and Fire Brick Works, Chicago, Ills.....	74
Baltimore Retort and Fire Brick Co., Baltimore, Md.....	74
Standard Gas Retort and Fire Brick Co., Ironton, Ohio.....	74
Oakhill Gas Retort and Fire Brick Co., St. Louis, Mo.....	74
Cincinnati Gas Retort & Fire Brick Co., Cincinnati, O.....	74
A. T. Chur, New York City.....	76
RETORT CEMENT.	
C. L. Gerould, Manchester, N. H.....	70
GAS STOVES.	
American Meter Co., New York and Philadelphia.....	75
The Goodwin Gas Stove and Meter Co., Philadelphia, Pa. . .	84
GAS METERS.	
Harris, Griffin & Co., Phila., Pa.....	82
American Meter Co., New York and Philadelphia.....	83
The Goodwin Gas Stove and Meter Co., Phila. Pa.	83
Helme & McIlhenny, Phila., Pa.	83
Maryland Meter and Mfg. Co., Baltimore, Md.....	82
D. McDonald & Co. Albany, N. Y.	83
Nathaniel Tufts, Boston, Mass.....	82
EXHAUSTERS.	
P. H. & F. M. Roots, Connersville, Ind.....	73
Smith & Sayre Manufacturing Co., New York City.....	78
Wilbraham Bros., Philadelphia, Pa.....	80
GAS COALS.	
Penn Gas Coal Co., Phila., Pa.....	81
Perkins & Co., New York City.....	80
Newburgh Orrel Coal Co., Baltimore Md.....	81
Despard Coal Co., Baltimore, Md.....	81
Chesapeake and Ohio R.R. Coal Agency, N. Y. City.....	81
Westmoreland Coal Company, Phila., Pa.....	81
GAS ENRICHERS.	
W. H. Doan, Cleveland, Ohio.....	70
VALVES.	
Ludlow Valve Manufacturing Co., Troy, N. Y.....	76
John McLean, New York City.....	76
GAS LAMPS.	
Siemens Regenerative Gas Lamp Co., Philadelphia, Pa.....	77
G. Shepard Page, New York City.....	81
GAS KILNS AND OVENS.	
Thompson Gas Kiln and Oven Co., New York City.....	73
PURIFIER SCREENS.	
John Catot, Lawrence, Mass.....	43

STREET LAMPS.	
J. G. Miner, Morrisania, New York City.....	45
Bartlett Street Lamp Mfg Co., New York City.....	73
BURNERS.	
G. Gfroerer, Phila., Pa.....	78
PURIFYING MATERIAL.	
Connelly & Co., New York City.....	73
STEAM BLOWER FOR BURNING BREESE.	
H. E. Parson, New York City.....	71
PIPE COVERINGS.	
Chalmers-Spence Company, N. Y. City.....	71
GAS FIXTURES.	
Mitchell, Vance & Co., New York City.....	73
STEAM ENGINES.	
Westinghouse Machine Co., Pittsburgh, Pa.....	81
STEAM PUMPS.	
A. S. Cameron Steam Pump Works, N Y. City.....	73
HYDRAULIC ELEVATOR.	
Lane & Bodley Company, Cincinnati, Ohio.....	73
SHAFTING, PULLEYS, ETC.	
A. & F. Brown, New York City.....	71
HYDRAULIC MAIN.	
A. E. Boardman, Macon, Ga.....	73

GEROULD'S IMPROVED RETORT CEMENT.
Used by most of the Gas Companies of the United States with perfect satisfaction. Manufactured by
C. L. GEROULD,
Manchester, N. H.
N. B.—As Manchester is a shipping point, all freight can be shipped as cheaply as from Boston or New York.

FOR SALE.
Second-Hand Gas Apparatus.
One Condenser, 4½ ft. diameter by 13 ft. in length over all, containing 150 two and one-half inch tubes, 8 ft. long with 12-in. connections and bye-pass.
Two Smith & Sayre (12-inch) Steam-Jet Exhausters, with 3 Self-acting Bye-Passes.
Four Purifying Boxes, 10 ft. by 14 ft. by 3 ft., with 12-inch connections and center seal.
All in good order, and will be sold cheap. Address
PETER P. MILLER, Manager Citizens Gas Co., Buffalo, N. Y.

FOR SALE,
Second-Hand Gas Apparatus.
The Louisville (Ky.) Gas Light Company wishes to dispose of the following:
15 Sixteen-Inch Chapman Valves.
6 Twelve-Inch Chapman Valves.
2 Twelve-Inch Center Seals & Connections.
2 Smith & Sayre Gas Steam Governors.
All in good order, and will be sold at low figures. Address inquiries to
A. H. BARRET,
Engineer's Office, Louisville (Ky.) Gas Company.

W. H. DOAN,
REFINER OF
NAPHTHA and GASOLINES
ALSO MANUFACTURER OF
A Special Grade of Naphtha for Gas Companies
FOR ENRICHING COAL GAS.
Correspondence solicited.
No. 43 Euclid Avenue, Cleveland, Ohio.

WM. FARMER, ENGINEER,
32 Park Place, Room 36, New York.

THE CHEMIST'S ASSISTANT; OR, KINDERGARTEN SYSTEM OF CHEMISTRY.

A system by which the elements and their valences are represented by illustrations and solid bodies.
BOX AND PAMPHLET COMPLETE, \$2.50.

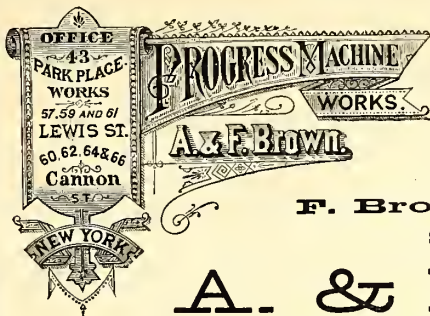

Shafting, Pulleys, HANGERS.

F. Brown's Patent Friction Clutch.
Send for Illustrated Catalogue and Discount Sheet to

A. & F. BROWN,
No. 43 Park Place, New York City.

It will "Pay the Piper,"

If he aims to pipe well for STEAM, WATER, GAS, ACIDS, OILS, AMMONIA, &c., to examine this UNION, which requires no packing, but is always ready for instant use. When you next order Fittings of any Dealer, ask for a sample American Union to come with them, and it will tell you the whole story, or we will, if you write us for particulars.

PANCOAST & MAULE,
PHILADELPHIA, PA.

GAS CO. OFFICERS,

READ AND REFLECT.

Pipe Coverings.

Fireproof, Non-Conducting Coverings for **STEAM PIPES, BOILERS,** And all Hot Surfaces.

Made in sections three feet long. Easy to apply; light and cheap. Asbestos Materials, Fibre, Braided Packing, and Cement. These goods are used at Continental Works, Br'lyn. **CHALMERS-SPENCE COMPANY, 419 & 421 EIGHTH ST., N. Y.**

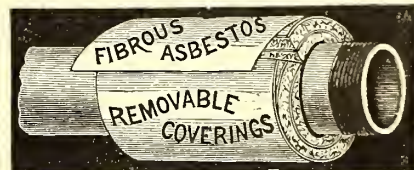

HODGE'S UNIVERSAL ANGLE UNION, Pat'd

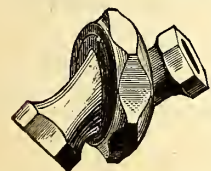

A new and important Pipe Fitting for Steam, Water, or Gas. Combining a variable angle or elbow and a union. Saves pipe, saves time, decreases friction and radiation, gives a union joint at every angle, and can be set at any angle at which it is desired to run the pipe.

HODGE'S SWIVEL FLANGE,

A common sense article, designed to save time and money.

MANUFACTURERS AND WHOLESALE AGENTS,
ROLLSTONE MACHINE CO.,
142 Water St., Fitchburg, Mass.

Parson's Steam Blower,

FOR IMPROVING BAD DRAUGHT IN BOILERS, AND FOR BURNING BREEZE OR OTHER WASTE MATERIAL.

PARSON'S TAR BURNER,

FOR UTILIZING COAL TAR AS FUEL.

PARSON'S AIR JET TUBE CLEANER,

FOR CLEANING BOILER TUBES.

These devices are all first-class. They will be sent to any responsible party for trial. No sale unless satisfactory. Manufactured by the WATERTOWN STEAM BLOWER COMPANY.

H. E. PARSON, Supt., 42 PINE ST., N. Y.

1885. The "Novelties" Exhibition 1885.

OF THE

FRANKLIN INSTITUTE, PHILADELPHIA.

Opens September 15th.

Closes October 31st.

This Exhibition will afford

INVENTORS

AND

Manufacturers

IN THE FIELD OF

Gas Lighting

a good opportunity



of bringing to public notice their

LATEST AND BEST

Appliances

AND

PROCESSES

for Manufacturing, distributing, & using Illuminating Gas.

For copies of Rules and Regulations, Blank Forms of Application for Space, and other information, address

COMMITTEE ON EXHIBITIONS,

Franklin Institute, Philadelphia, U. S. A.

THE CLERK GAS ENGINE.

Highest Award American Institute, New York, 1883. Silver Medal American Institute, N. Y., 1884.

Gold Medal Awarded Crystal Palace Electrical Exhibition, London, 1882.

Highest Award for Motive Power British Section International Exhibition of Electricity, Paris, 1881.

Reliable.
No Boiler.
Steady.
No Coal.
Simple.
No Ashes.
Compact.

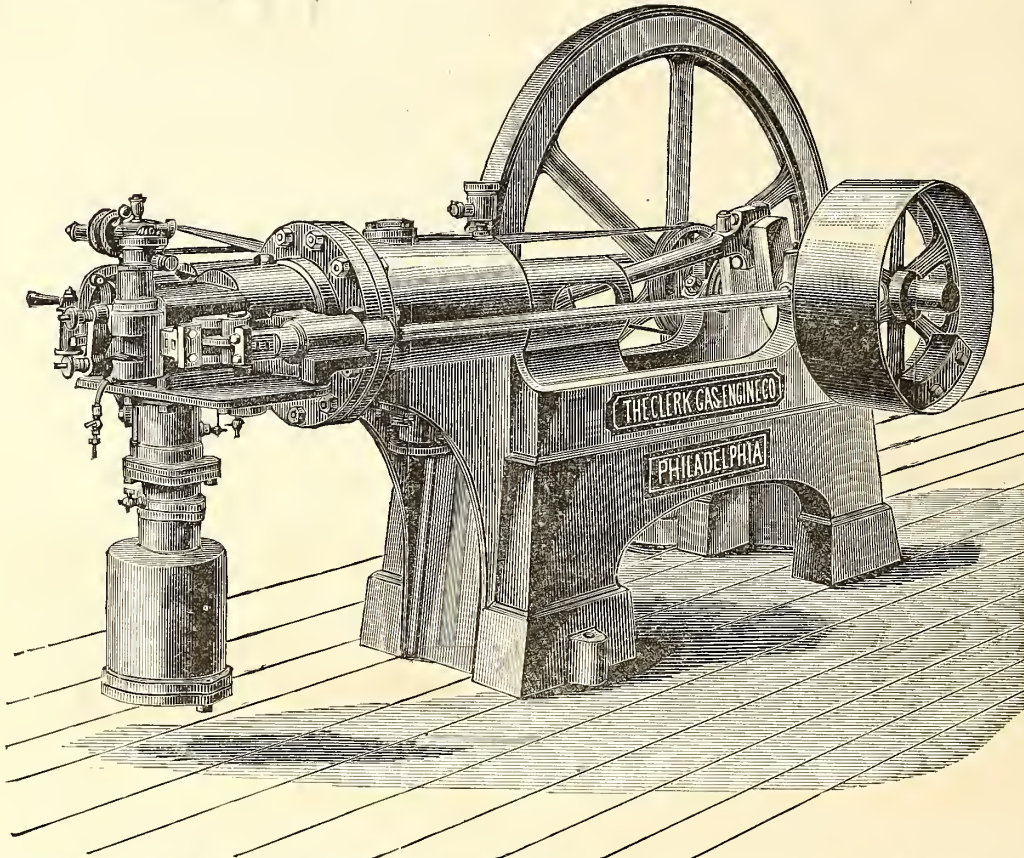

Economical.
No Engineer.
No Explosion
No Gearing
Wheels.
No Danger.
No Parts
requiring
frequent
renewal.

REQUIRING ONLY A MATCH TO START IT--GIVING ITS FULL POWER IMMEDIATELY.

We would inform the public that during the last few months we have improved THE CLERK GAS ENGINE to such an extent that we can now offer an engine vastly superior to our former pattern. These improvements have enabled us to sell our engine at a GREATLY REDUCED FIGURE, partly on account of the decreased weight (our engine weighing about half that of others giving the same Brake H. P). The consumption of gas has been decreased to a considerable extent, and the Brake H. P. has been increased some 25 to 30 per cent. All parts of the old design that were considered defective have been remodeled and new designs added. We now have an engine second to none as regards power, consumption, and ease of working. With our new engine all trouble in starting has been removed, the noise reduced to a minimum, and the regularity of motion is now all that can be desired. We guarantee all we claim for it, and the material and workmanship being of the best, enables us to guarantee the engine for twelve months.

SOLE MAKERS,

THE CLERK GAS ENGINE CO.,

WM. W. GOODWIN, President. E. STEIN, Secretary. S. LEWIS JONES, Asst. Secretary. L. P. GARRET, Supt.

Main Office, 1012-1018 Filbert Street, Philadelphia, Pa.

BRANCH OFFICES,

142 Chambers St., N. Y. 4 West Fourteenth St., N. Y. 76 Dearborn St., Chicago

General Agents,

THE GOODWIN GAS STOVE & METER CO

Of Philadelphia, New York, and Chicago.

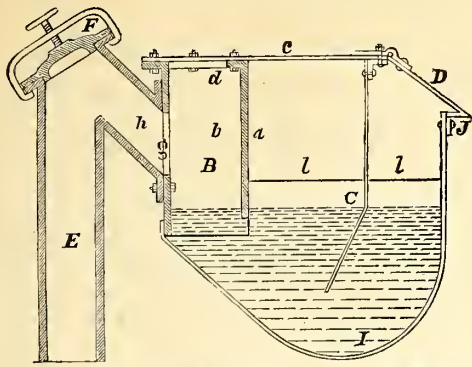

Boardman Hydraulic Main,
Patented October 7, 1884.

For description, see AM. GAS LIGHT JOURNAL of Feb. 2, 1884.
For terms, apply to

A. E. BOARDMAN, Macon, Ga.

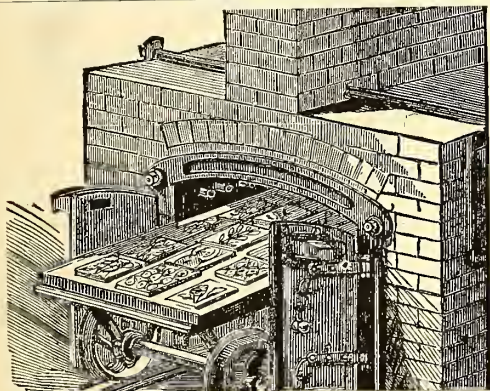

Glass-Staining Gas Kiln.
BAKERS' & CONFECTIONERS' OVENS (PAT.)
Thompson Gas Kiln & Oven Co.
59 Carmine St., N. Y.
Send for Circular by mail.

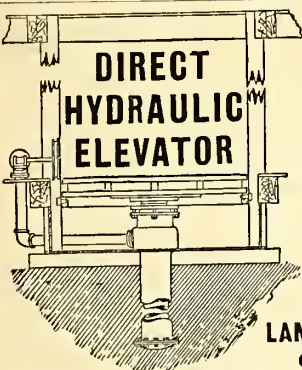

With Iron or Wood Platform.

Largely used by Leading Gas Co.s for Coal and Coke Lifts.

Adapted for use with city service, or special pumping and accumulator system. For prices address the

LANE & BODLEY CO.,
Cincinnati, O.

MITCHELL, VANCE & CO.,

MANUFACTURERS OF

Chandeliers

and every description of

GAS FIXTURES.

Also manufacturers of Fine Gilt Bronzes and Marble Clocks, warranted best time-keepers. Mantel Ornaments, etc.

Salesrooms, 836 Broadway, N. Y.

Special Designs furnished for Gas Fixtures for Churches, Public Halls, Lodges, etc.

Iron Sponge,
GAS EXHAUSTERS,

AUTOMATIC GAS GOVERNORS,

CONNELLY & CO., Limited,
No. 407 BROADWAY, NEW YORK CITY.

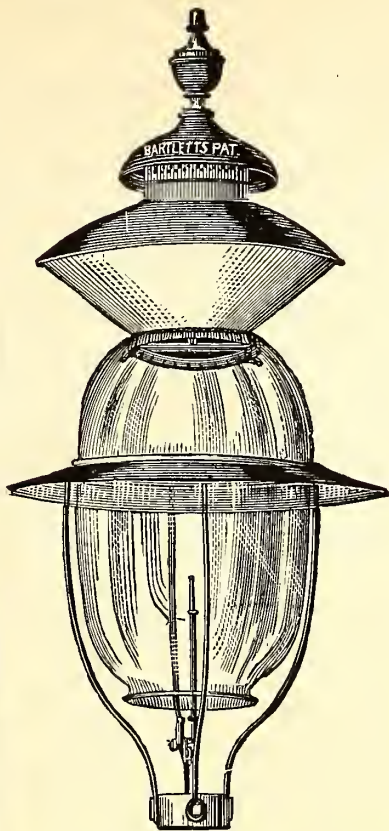

I. C. BARCALOW, PREST.

J. V. BARCALOW, SEC. & TREAS.

BARTLETT
Street Lamp Mfg. Co.

MANUFACTURERS OF

Bartlett's Patent

GLOBE LAMPS.

FOR

Streets, Parks, Railroad Stations, Public Buildings, Etc.

LAMP POSTS A SPECIALTY.

Office and Salesroom,

No. 35 Howard Street, N. Y. City.

Gas Companies and others intending to erect lamps and posts will do well to communicate with us.

F. M. ROOTS.

S. C. ROOTS

D. T. ROOTS.

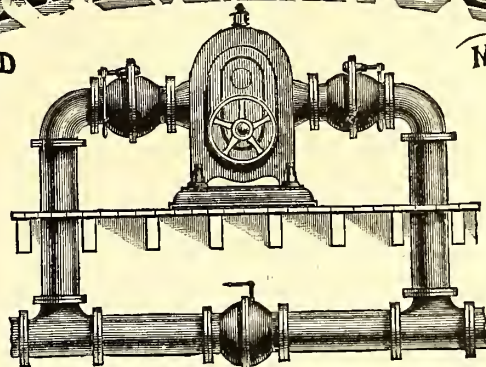

IMPROVED GAS EXHAUSTER,

WITH ENGINE ON SAME BED PLATE, OR WITHOUT.

BYE-PASSES, GAS VALVES, GOVERNORS, ELBOWS, PIPE-FITTINGS, Etc., FURNISHED TO ORDER,

P. H. & F. M. ROOTS, Patentees & Manufacturers, **CONNERSVILLE, IND.**

S. S. TOWNSEND, General Agent, 22 Cortland St. and 9 Dey St., N. Y.

JAS. BEGGS & CO., Selling Agents, 9 Dey St., N. Y.

COOKE & CO., Selling Agents, 22 Cortland St., N. Y.

✻ SEND FOR ILLUSTRATED CATALOGUE AND PRICE LIST. ✻

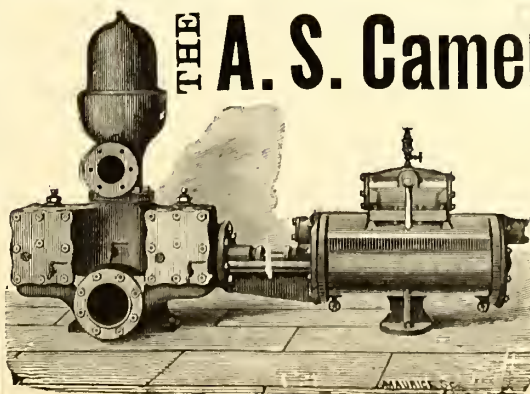

THE A. S. Cameron Steam Pump,

THE STANDARD OF EXCELLENCE.

Upward of 30,000 in Use.

BEST GAS WORKS PUMP

Ever Introduced.

Adapted to Every Possible Duty.

A. S. Cameron Steam Pump Works,

Foot East 23d St., N. Y.

J. H. GAUTIER & CO.,

CORNER OF

GREENE AND ESSEX STREETS,
JERSEY CITY, N. J.

MANUFACTURERS OF

Clay Gas Retorts,
Gas House Tiles,
Fire Bricks, Etc. Etc.Ground Clay, Fire Brick and
Fire Sand in Barrels,J. H. GAUTIER.
C. E. GREGORY.T. B. GAUTIER.
C. E. GAUTIER.**BROOKLYN**Clay Retort & Fire Brick Works,
(EDWARD D. WHITE & CO.)Manufacturers of Clay Retorts, Fire Brick,
Gas House and other Tile.VAN DYKE, ELIZABETH, RICHARDS & PARTITION STS.
Office, 88 Van Dyke St., Brooklyn, N. Y.**LACLEDE FIRE BRICK MFG. CO.,**

MANUFACTURERS OF

Fire Brick, Gas Retorts,

AND

ST. LOUIS STANDARD SEWER PIPE.

Blast Furnace and Cupola Linings, every description of Fire
Clay Material, Fire Clay Flue Linings, Chimney Tops
Dry Milled and Crude Fire Clays, etc.

OFFICE AND DEPOT

901, 903, and 905 Pine Street,
ST. LOUIS, MO.

ESTABLISHED IN 1845.

B. KREISCHER & SONS,

OFFICE FOOT OF HOUSTON ST., E.R., N. Y.

Gas Retorts,**TILES, FIRE BRICK.**

AND EVERYTHING IN THE FIRE CLAY LINE.

MANHATTAN

FIRE BRICK & ENAMELLED CLAY

RETORT WORKS.**ADAM WEBER.**

CLAY GAS RETORTS

AND RETORT SETTINGS

FIRE BRICKS, TILES, ETC.,

Office and Works, 15th Street and Avenue C., N. Y.

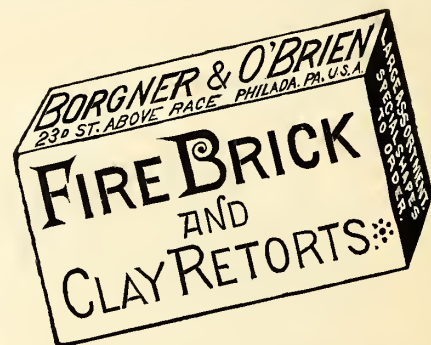

JAMES GARDNER, JR.

Works,

LOCKPORT STATION, PA.

—ESTABLISHED 1864.—

WILLIAM GARDNER & SON,

Successor to GARDNER BROTHERS.

WILLIAM GARDNER.

Office, COAL EXCHANGE,
PITTSBURGH, PA., P. O. Box 373.**Fire Clay Goods for Gas Works.**

C. H. SPRAGUE, No. 70 KILBY STREET, BOSTON, MASS., Agent for the New England States.

OFFICE, 418 to 422 East 23d St., New York.

ESTABLISHED 1856.

WORKS, PERTH AMBOY, NEW JERSEY.

HENRY MAURER,**Excelsior Fire Brick & Clay Retort Works**

CLAY GAS RETORTS, BENCH SETTINGS, FIRE BRICK, TILES, ETC.

STANDARD GAS RETORT AND FIRE BRICK COMPANY,

J. ANDERSON, PRES. & MANG'R.

OF IRONTON, OHIO.

C. PETERS, SECRETARY.

Clay Gas Retorts, Fire Brick, and Fire Clay Goods of Every Description.

Plans of Livesey-Somerville, McIlhenny, and other Furnaces, and Competent Workmen Supplied.

CHICAGO

Retort & Fire Brick Works,

OFFICE AND FACTORY,

Clark, Forty-Fifth, and La Salle Streets,

CHICAGO, ILL.

GEORGE C. HICKS, PRES. PAUL P. AUSTIN, SEC. & TREAS.

STANDARD

Clay Retorts and Settings.

BLOCKS & TILES

Of every Shape and Size to Order.

Standard Fire Bricks.**NEWBIGGING'S****Gas Manager's Handbook.**

Price, \$4.80.

EVERY GAS MAN SHOULD HAVE ONE.

Orders may be sent to this Office.

OAKHILL**GAS RETORT & FIRE BRICK**

COMPANY.

PARKER, RUSSELL & CO.

City Office, 711 Pine Street,

ST. LOUIS, MO.

Our immense establishment is now employed almost entirely in
the manufacture of**MATERIALS FOR GAS COMPANIES.**We have studied and perfected three important points. Our re-
torts are made to stand changes of temperature, the strongest
heats of the furnace, and the abrasion of feeding and emptying.
Our customers are in almost every State of the Union, to all of
whom we refer.

THOS. SMITH, Prest.

AUGUST LAMBLA, Vice-Prest. & Sup

BALTIMORE**RETORT & FIRE BRICK CO.**

MANUFACTORY AT

LOCUST POINT, BALTIMORE, MD.

Connection with the City by Telephone.

Clay Retorts, Blocks & Tiles,

FIRE BRICK, FIRE CLAY,

AND FIRE CEMENT.

Red and Buff Ornamental Tiles and Chim-
ney Tops. Drain and Sewer Pipe (from
2 to 30 inches). Baker Oven Tiles
12x12x2 and 10x10x2.

WALDO BROS., 88 WATER ST., BOSTON, MASS

Sole Agents for New England States

THE AMERICAN METER CO.,

MANUFACTORIES,

512 West Twenty-second Street, N. Y. Arch and Twenty-second Street, Phila.
Nos. 244 & 246 North Wells Street, Chicago, Ill.

AGENCIES,

No. 177 Elm Street, Cincinnati, Ohio. Nos. 122 & 124 Sutter Street, San Francisco Cal.
No. 810 North Second Street, St. Louis, Mo.

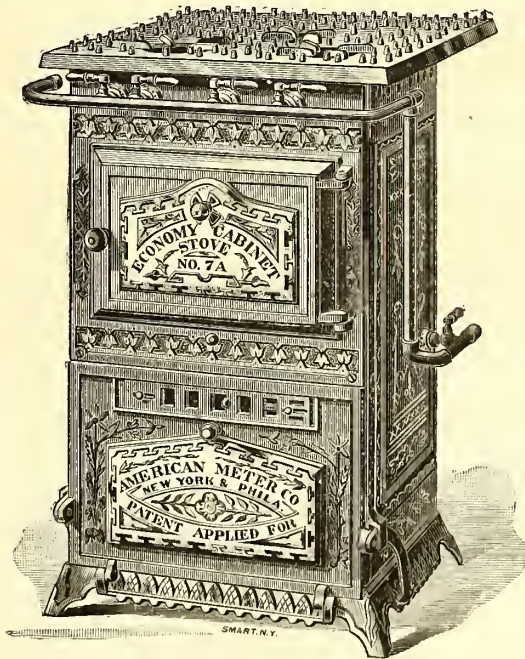

NEW DESIGN STOVES MADE IN CAST IRON, WITH EITHER OPEN OR CLOSED TOPS.

In presenting our "Economy" Gas Cooking Stoves and Ranges for the Season of 1885, we have the pleasure to inform our patrons that the increasing demand for these Stoves has encouraged us to make entirely new patterns, of HIGHLY ORNAMENTAL DESIGNS, for the popular sizes. We have also embraced the opportunity to increase the size of these Stoves, giving greater TOP PLATE AND OVEN capacity.

Full Lists and Catalogues are in preparation, and large stocks of Stoves will be kept at our Manufactories and Agencies for prompt shipment.

AMERICAN METER CO.

A. H. M'NEAL,

BURLINGTON, N. J.

Flange-Pipes

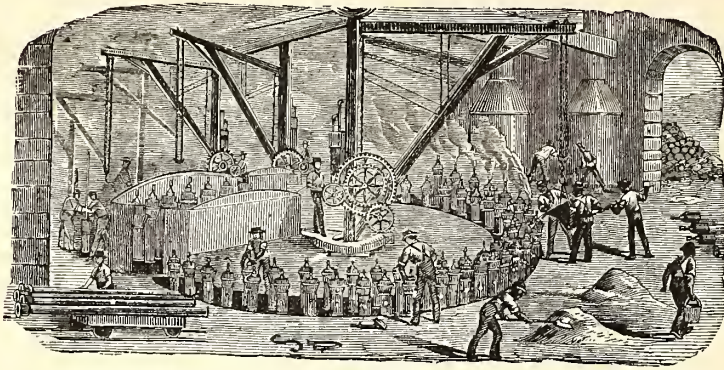

General Foundry Work.

CAST IRON PIPES FOR WATER AND GAS

JAMES S. MOORE, Pres.
BENJAMIN CHEW, Treas.

JAS. P. MICHELLON, Sec.
WM. SEXTON, Supt.

GLOUCESTER IRON WORKS, GLOUCESTER CITY, N. J.

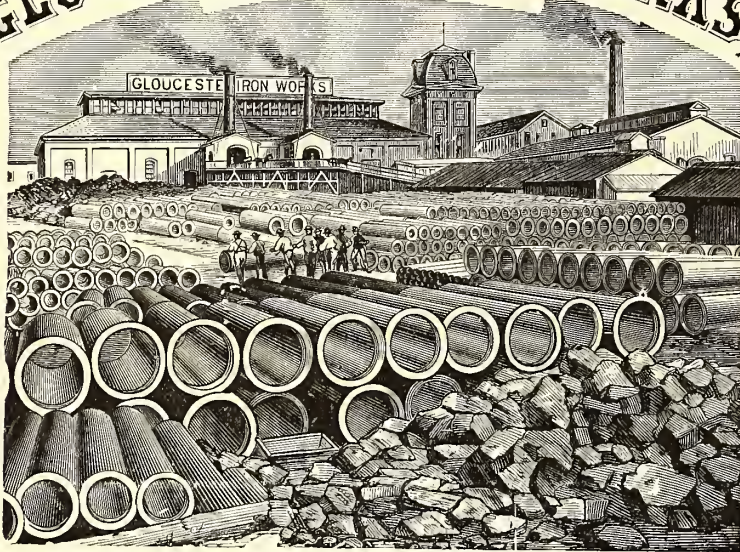

Cast Iron Gas & Water Pipes, Stop Valves, Fire Hydrants, Gasholders. &c.
Office No. 6 North Seventh Street, Philadelphia.

ESTABLISHED 1856.

WARREN FOUNDRY AND MACHINE CO.,

WORKS AT PHILLIPSBURGH, N. J.
NEW YORK OFFICE, 162 BROADWAY.

Cast Iron Water and Gas Pipe

FROM TWO TO FORTY-EIGHT INCHES DIAMETER.
ALSO ALL SIZES OF

FLANGE PIPE for Sugar House and Mine Work.
Branches, Bends, Retorts, Etc., Etc.

MATTHEW ADDY, President.

W. L. DAVIS, Selling Agent.

GEO. P. WILSHIRE, Sec. & Treas.

Cincinnati and Newport Iron and Pipe Company,

NEWPORT, KY.

Lamp Posts
AND
BENCH CASTINGS

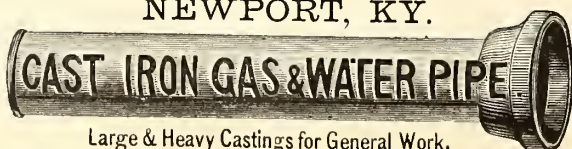

Branch
AND
SPECIAL CASTINGS

A Specialty.

Large & Heavy Castings for General Work.

FOR GAS & WATER CO'S.

Manufacture Pipe from 2 to 48 inches. All work guaranteed first quality.

Mellert Foundry and Machine Co. Limited. Established 1848.

MANUFACTURERS OF

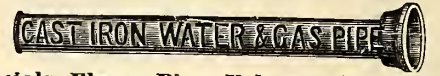

Specials—Flange Pipe, Valves and Hydrants,
Lamp Posts, Retorts, etc.
Machinery and castings for Furnaces, Rolling Mills, Grist and
Saw Mills, Mining Pumps, Hoists, etc.

GENERAL OFFICE, - - - READING, PA.

CAST IRON Gas and Water Pipes,

From 2 to 48 Inches in Diameter.

FOX & DRUMMOND,

160 Broadway, N. Y. City.

LUDLOW VALVE MFG. CO.

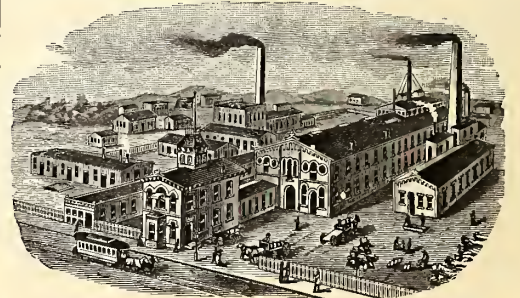

OFFICE AND WORKS,

938 to 954 River Street and 67 to 83 Vail Av.

TROY, N. Y.

Hydraulic Main Dip Regulators, also
Check Valves, Foot Valves, Yard-
wash and Fire Hydrants.
Send for Circulars.

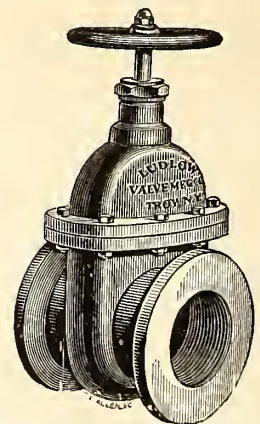

Valves.—Double and Single Gate, 1/2 in. to
48 in., outside and inside Screws. Indica-
tor, etc., for Gas, Water, Steam, and Oil.
Send for Circulars.

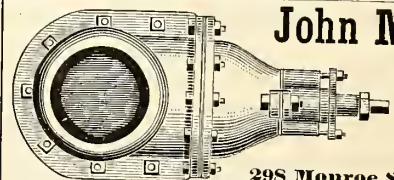

John McLean

Manufacturer of
GAS
VALVES.

298 Monroe Street, N. Y.

WELSH "ABERNANT" Silica Dinas Fire Brick & Cement.

Unrivalled for Endurance Under Intense
Heat. Percentage of Silica, 95.64.

Also SCOTCH "BLOCHAIRN" FIRE BRICK.

A. T. CHUR,

SOLE AGENT FOR THE UNITED STATES,

Mills Building, Room 14, Fifth Story, New York.

Siemens's Regenerative Gas Burners, For Lighting and Ventilating.

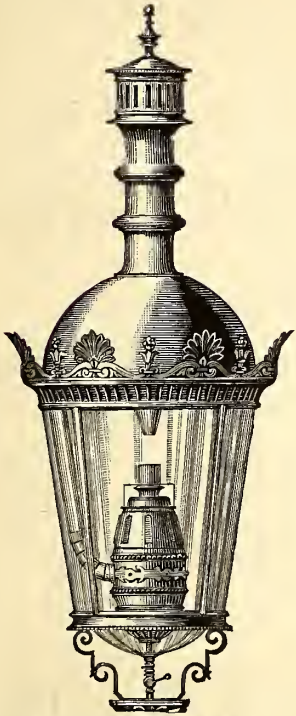

THE CHEAPEST, PUREST, AND MOST BRILLIANT OF ALL GAS LIGHTS.

Superior to the Electric Light in Economy, Beauty, & Steadiness.

SPECIALLY ADAPTED FOR LIGHTING HALLS, FACTORIES, OPEN SPACES, ETC.

Numerous Tests made by various Gas Companies in the United States show an Efficiency of Ten Candle Power per Cubic Foot of Gas.

General Agents:

- SIEMENS LIGHTING CO., 347 West Main St., Louisville, Ky.
- MEYER, MARSHALL & CO., 528 California St., San Francisco.
- DENNEHY, WOLF & O'BRIEN, 85 & 87 Dearborn St. Chicago, Ill.
- WILCOX & McGEARY, - No. 11 Bissel Block, Pittsburgh, Pa.
- T. T. RAMSDALL & CO., - 20 Swan Street, Buffalo, N. Y.
- SIEMENS GAS ILLUMINATING CO.,
Room 6, No. 157 Broadway, New York City.
- W. D. COLT, - - - - 1420 F Street, Washington, D. C.
- JOHN KIEFER, - - - 344 Lawrence, Street, Denver, Col.

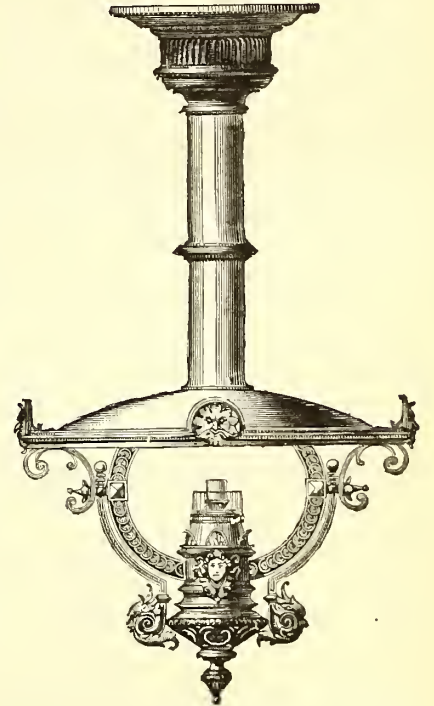

THE SIEMENS REGENERATIVE GAS LAMP COMPANY,
SOLE MAKERS FOR THE UNITED STATES,
N. E. Cor. 21st. St. and Washington Av., Philadelphia, Pa.

THE "STANDARD" WASHER-SCRUBBER, KIRKHAM, HULETT & CHANDLER'S PATENT.

Total Capacity per 24 Hours of "Standard" Washers Ordered During the Following Years.

1877.....	4,000,000 cubic feet.
1878.....	4,750,000 "
1879.....	24,545,000 "
1880.....	42,967,500 "
1881.....	36,462,500 "
1882.....	39,300,000 "
1883.....	57,735,000 "
1884.....	26,177,500 "
Total.....	235,937,500 cubic feet.

Total Number and Capacity per 24 Hours of "Standard" Washers Erected and in Course of Erection in the Several Countries

	Number.	Cubic Feet per Day.
Great Britain..	151	157,070,000
Western Hemisphere.....	38	39,337,500
Australia.....	18	12,150,000
New Zealand.....	2	650,000
France.....	6	4,550,000
Belgium.....	8	5,420,000
Germany.....	16	8,200,000
Holland.....	4	4,160,000
Denmark.....	1	150,000
Russia.....	2	3,500,000
Spain.....	1	350,000
India.....	1	400,000
Total.....	248	235,937,500

**THE CONTINUED POPULARITY
Of these Machines**

Will be recognized from the following extracts from letters from representatives of some of the companies having them in use:

PROVIDENCE GAS COMPANY, }
PROVIDENCE, R. I., Nov. 24, 1884. }
GEO. SHEPARD PAGE, Esq., New York:

Dear Sir—We are now using less than a gallon of water per thousand in the "Standard," and the gas at the outlet will not color turmeric paper.

Yours, etc.,
A. B. SLATER, Treasurer.

PORTLAND GAS COMPANY. }
PORTLAND, ORE., Nov. 29, 1884. }
GEO. SHEPARD PAGE, New York:

Dear Sir—Our Scrubber appears to run to our entire satisfaction, and we are pleased to say that it takes out all the ammonia from the gas. This is very satisfactory to us, as we were ruining our meters at a fearful rate heretofore. The amount of water used is very inconsiderable as compared with our old process. The machine runs very smooth and still.

Very respectfully,
H. C. LEONARD, Secretary.

"Standard" Washers Ordered Recently.

	Cu. Ft. per Day
Anneberg Gas Co.....	200,000
Bombay Gas Co.....	400,000
Brussels Co.....	1,250,000
CHICAGO, two, 1,000,000 each.....	2,000,000
Chemnitz Gas Co.....	1,000,000
CITIZENS GAS CO., BUFFALO.....	750,000
Coke Works in Zabre, Ober-Schlesien.....	1,500,000
Cokerei der Friedenshutte, Upper Silesia.....	500,000
Dumfries Corporation.....	250,000
Dunedin Gas Co., New Zealand.....	400,000
GEORGETOWN, D. C.....	250,000
King's Lynn Gas Co.....	300,000
Leiden, Holland.....	600,000
Lincoln Gas Co.....	400,000
Liverpool Gas Co.....	2,000,000
" " " ".....	3,000,000
LOUISVILLE GAS CO.....	1,500,000
Numea Gas Co.....	100,000
PITTSBURGH GAS CO.....	1,500,000
PAWTUCKET, R. I.....	500,000
PORTLAND GAS CO., Oregon.....	562,500
SAN FRANCISCO GAS CO.....	4,000,000
Sheepbridge.....	40,000
ST. LOUIS GAS CO.....	2,000,000
Sydney Gas Co.....	2,500,000
WASHINGTON, D. C. GAS CO.....	2,000,000
Whitechurch Gas Co.....	175,000
Total.....	29,677,500

GEO. SHEPARD PAGE, No. 69 WALL STREET, NEW YORK,
SOLE AGENT FOR THE WESTERN HEMISPHERE.

R. D. WOOD & CO.,

400 Chestnut Street, Phila., Pa.

Cast Iron Gas & Water Pipe, Water Machinery & Gas Apparatus

Cast Iron Pipe, Fire Hydrants, Eddy Valves, Lamp Posts, Large Loam Castings, Flanged Pipe, Sugar House Work, Iron Roofs and Floors, Wrought & Cast Iron Tanks, Turbine Water Wheels and Pumps.

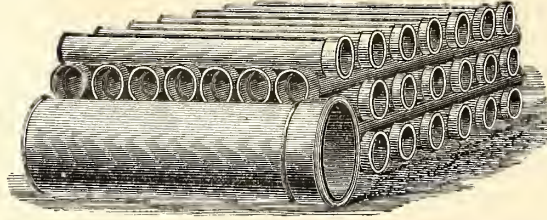

Casholders, Lime Trays, Center Valves, Purifiers, Bench Work, Exhausters, Condensers, Governors, Scrubbers, Gas Valves, Station Meters, Cast Iron Pipe Fittings.

Manufacturers of Heavy Castings and Machinery of Every Description.

ENGINEERS & CONTRACTORS FOR THE ERECTION OF GAS WORKS, & ALL MACHINERY CONNECTED THEREWITH

Estimates and specifications furnished for erection of new works or the extension or alteration of old ones.

Foundries and Works, - - Millville, Florence, and Camden, N. J.

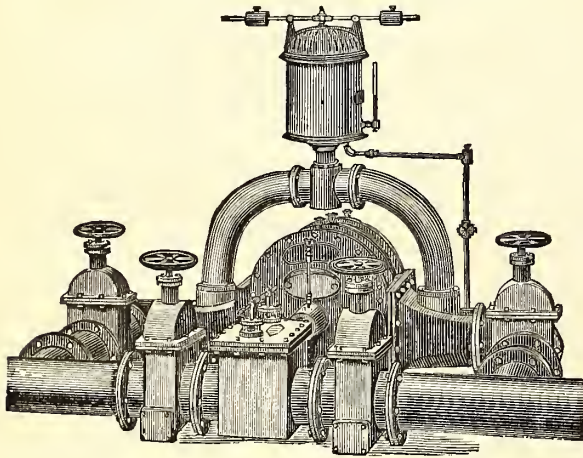

SMITH & SAYRE MFG. COMPANY,

G. G. PORTER, Prest.

245 Broadway, N. Y.

CHAS. W. ISBELL, Sec'y.

Machinery & Apparatus for Gas Works

Drawings, Plans, and Estimates Furnished for the Improvement, Extension, or Alteration of Gas Works, or for the Construction of New Works.

Mackenzie's Patent Rotary and Steam Jet Gas Exhausters, Governors, Compensators, Condensers, Washers, Scrubbers. Isbell's Patent Automatic Street Pressure Governor, Gas and Water Valves, Hydraulic Main Dip Regulator, Bench Castings, etc. Purifying Boxes and "Standard" Scrubbers. Isbell's Patent Self-Sealing Retort Doors.

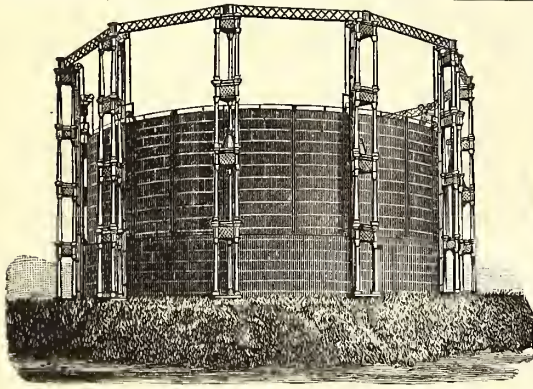

W. E. Tanner, Pres., W. R. Trigg, V.-Pres., A. Delaney, Supt.

Tanner & Delaney Engine Co.
RICHMOND, VA.

Gas Apparatus,

INCLUDING

Condensers of various styles, Scrubbers, Holders, Purifiers, Castings for Retort Houses, Etc.

ALSO STEAM ENGINES AND BOILERS.

Plans, Specifications and Estimates Furnished.

MORRIS, TASKER & CO.,

Limited,

Builders of Gas Works,

PHILADELPHIA, PA.

To Gas Companies.

We make to order **CAP BURNERS** to burn any amount under a stated pressure. Send for samples.

Also, **SERVICE CLEANERS, DRIP PUMPS, and STREET MAIN PROVING APPARATUS.**

C. A. GEFROER,

248 N. 8th Street, Phila., Pa.

SOUTHWARK FOUNDRY AND MACHINE COMPANY,

Successors to MERRICK & SONS. Established in 1836.

No. 430 Washington Avenue, Philadelphia, Pa.

MANUFACTURERS OF

Single and Telescopic Gasholders,

BENCH CASTINGS,

Washers, Scrubbers, Condensers, Purifiers,

And all apparatus necessary for the construction of improved new gas works and in the extension of established works. Also manufacturers of

Gas Engines, and of all descriptions of Steam and Hydraulic Machinery, and of Boiler and Tank Work.

Plans, specifications, and estimates furnished promptly on application.

WM. HENRY WHITE,

Consulting & Constructing

Gas Engineer & Contractor.

ESTIMATES, PLANS, AND SPECIFICATIONS FURNISHED FOR NEW WORKS OR EXTENSIONS OF EXISTING WORKS.

32 Pine St., New York City.

Correspondence solicited.

KERR MURRAY MFG. CO.,

MANUFACTURERS OF

**Single Lift and Telescopic
GASHOLDERS.**

Built, 1884:

Altoona, Pa.....	Capacity, 160,000 cubic feet.
Pittsburgh, Pa.....	" 250,000 "
" ".....	" 220,000 "
Bellaire, Ohio.....	" 50,000 "
Youngstown, Ohio.....	" 60,000 "
Canton, ".....	" 60,000 "
Akron, ".....	" 80,000 "
Xenia, ".....	" 10,000 "
Adrian, Mich.....	" 65,000 "
Ypsilanti, Mich.....	" 25,000 "
Muskegon, ".....	" 70,000 "
South Bend, Ind.....	" 70,000 "
Anderson, ".....	" 20,000 "
Plainfield, ".....	" 10,000 "
Springfield, Illinois.....	" 100,000 "
Evanston, ".....	" 50,000 "
Freeport, ".....	" 35,000 "
Elgin, ".....	" 60,000 "
Sheboygan Wis.....	" 20,000 "
Key West Fla.....	" 10,000 "

Plans and estimates furnished for the erection of new and the rebuilding of old works. Address

**Kerr Murray Mfg. Co.,
FORT WAYNE, IND.**

JAMES R. FLOYD,
(SUCCESSOR TO HERRING & FLOYD)

Oregon Iron Works,
531 to 543 West 20th St., N. Y.
Practical Builders of Gas Works,
MANUFACTURERS OF
**ALL KINDS OF CASTINGS
AND
APPARATUS FOR GAS-WORKS.**

BENCH CASTINGS
from benches of one to six Retorts each.
**WASHERS: MULTITUBULAR AND
AIR CONDENSERS; CONDENSERS;
SCRUBBERS**

wet and dry), and
EXHAUSTERS
for relieving Retorts from pressure.

BENDS and BRANCHES
of all sizes and description.

**FLOYD'S PATENT
MALLEABLE RETORT LID.
PATENT
SELF-SEALING RETORT LIDS.
FARMER'S
PATENT BYE-PASS DIP-PIPE.
SABBATON'S PATENT
FURNACE DOOR AND FRAME.**

**BUTLER'S
COKE SCREENING SHOVELS.**

GAS GOVERNORS,
and everything connected with well regulated Gas Works at low price, and in complete order.

SELLER'S CEMENT
for stopping leaks in Retorts.

N. B.—STOP VALVES from three to thirty inches—at very low prices.
Plans, Specifications, and Estimates furnished.

CONTINENTAL WORKS.

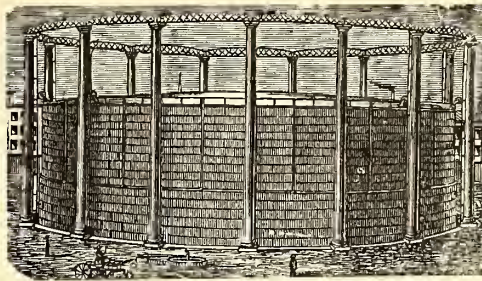

GASHOLDERS OF ANY MAGNITUDE.

T. F. ROWLAND, Proprietor,
GREENPOINT, BROOKLYN, N. Y.
ENGINEER AND MANUFACTURER OF
GAS-HOLDERS.
**CONDENSERS, SCRUBBERS, VALVES,
PURIFIERS, RETORTS, and HY-
DRAULIC MAINS,**
and all other articles connected with the Manufacture and Distribution of Gas. Plans and Specifications prepared and Proposals given for the necessary Plant for Lighting Cities, Towns, Mansions, and Manufactories.

H. RANSHAW, Prest. & Mangr. WM. STACEY, Vice-Pres. T. H. BIRCH, Asst. Mangr. R. J. TARVIN, Sec. & Treas.

STACEY MFG. CO.,

MANUFACTURERS OF

Single and Telescopic Gasholders,

IRON ROOFS, BRIDGES, LAMP POSTS,

**Water and Oil Tanks, Coal Elevator Cars,
COKE CRUSHERS, BENCH CASTINGS,**

And all kinds of Wrought and Cast Iron Work used in the erection of Coal and Oil Gas Works. Rolling Mill Machinery and Heavy Castings a Specialty.

Foundry: 33, 35, 37 & 39 Mill Street. **Wrought Iron Works:** 16, 18, 20, 22, 24 & 26 Ramsey Street.

Cincinnati, Ohio.

BARTLETT, HAYWARD & CO.,

Office, 24 Light. **BALTIMORE, MD.** Works, Pratt &

PURIFIERS.
Roofs.
Bench Castings.

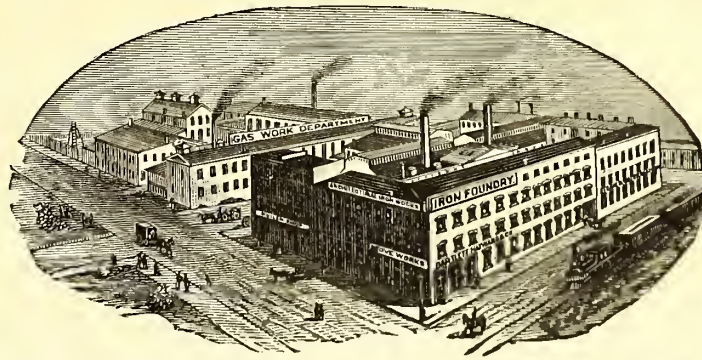

CONDENSERS.
BOILERS.
SCRUBBERS.

GASHOLDERS.

CONSTRUCTING ENGINEERS AND BUILDERS OF GAS WORKS.

1842. **DEILY & FOWLER, 1885.**

Laurel Iron Works.

Address, No. 39 Laurel Street, Philadelphia, Pa.

MANUFACTURERS OF

GASHOLDERS,

Single or Telescopic, with Cast or Wrought Iron Guide Frames.

Holders Built Since 1880:

Mount Joy, Pa.	West Point, N. Y.	Galveston, Texas (2d.)	Kalamazoo, Mich. (3d.)	Newport, R. I.
Rockaway B'ch, N.Y. (2)	Fitchburg, Mass.	Marlboro, Mass.	Glen Island, N. Y.	Portland, Oregon.
Zanesville, O. (2d.)	New London, Conn.	Denver, Col.	Warren, Ohio.	Allegheny, Pa. (2d.)
Lancaster, O.	Derby, Conn.	Chicago, Ill. (West Side)	Bath, N. Y.	Atlanta, Ga. (2d.)
Blackwell's Island N. Y.	Bridgeport, Conn.	Pittsburgh, Pa. (S. Side)	Lynn, Mass.	N.Y. City (Central Ga.)
Waltham, Mass., (1st.)	Allegheny, Pa. (1st.)	Pawtucket, R. I.	New Bedford, Mass.	Lynchburg, Va. (2d.)
Dorchester, Mass.	St. Hyacinth, Can.	Brookline, Mass.	Waterbury, Conn.	Rondout, N. Y.
Wheeling, West Va.	Norwalk, O.	Sherbrooke, Can.	Deseronto, Can.	Saylesville, R. I.
Lansing, Mich.	Brattleboro, Vt.	Burlington, N. J. (2d.)	Hooole Falls, N. Y. (2d.)	Atlantic City, N. J.
Flint, Mich.	Waltham, Mass (2d.)	West Chester, Pa.	Bethlehem, Pa.	Augusta, Ga.
Galveston, Texas (1st.)	Baltimore, Md.	Bay City, Mich.	Atlanta, Ga. (1st.)	Waltham, Mass. (2)
Milton, Pa.	Holidaysburg, Pa.	Erie, Pa.	Savannah, Ga.	
Scranton, Pa.		Jackson, Mich.	Montgomery, Ala	

GAS COALS.

GAS COALS.

GAS COALS.

JAMES D. PERKINS.

PERKINS & CO.,

F. SEAVERNS.

General Sales Agents for

The Youghioghenny River Coal Company's OCEAN MINE YOUGHIOGHENY GAS COAL.

The Coal from the Ocean Mine (recently operated by Messrs. W. L. Scott & Co., of Erie, Pa.,) is now used by all the leading Gas Companies in the United States from Maine to Texas, and is recognized as *the only reliable Youghioghenny Gas Coal.* (See Map on p. 87 of this Journal, Feb. 16, 1885.)

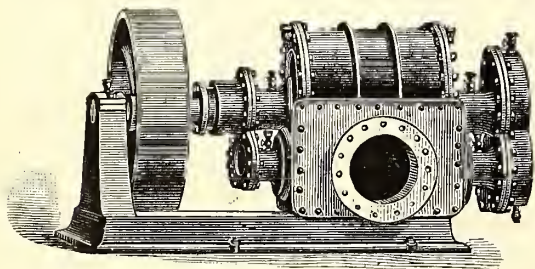
P. O. Box 3695,
New York.**PERKINS & CO., 228 and 229 N. Y. Produce Exchange**BEAVER STREET
ENTRANCE.

Gas Exhauster Driven by Belt.

The Wilbraham Gas Exhauster, "BAKER SYSTEM,"

WITH ENGINE ATTACHED, ON SAME BED PLATE OR WITHOUT.
Best, Cheapest and Most Durable Exhauster known.

WILBRAHAM BROS.,

No. 2320 Frankford Avenue, Philadelphia, Pa.

F. J. DAVIS & J. R. FARNUM,

TRUSTEES AND AGENTS FOR THE

SINUOUS FRICTION CONDENSER.

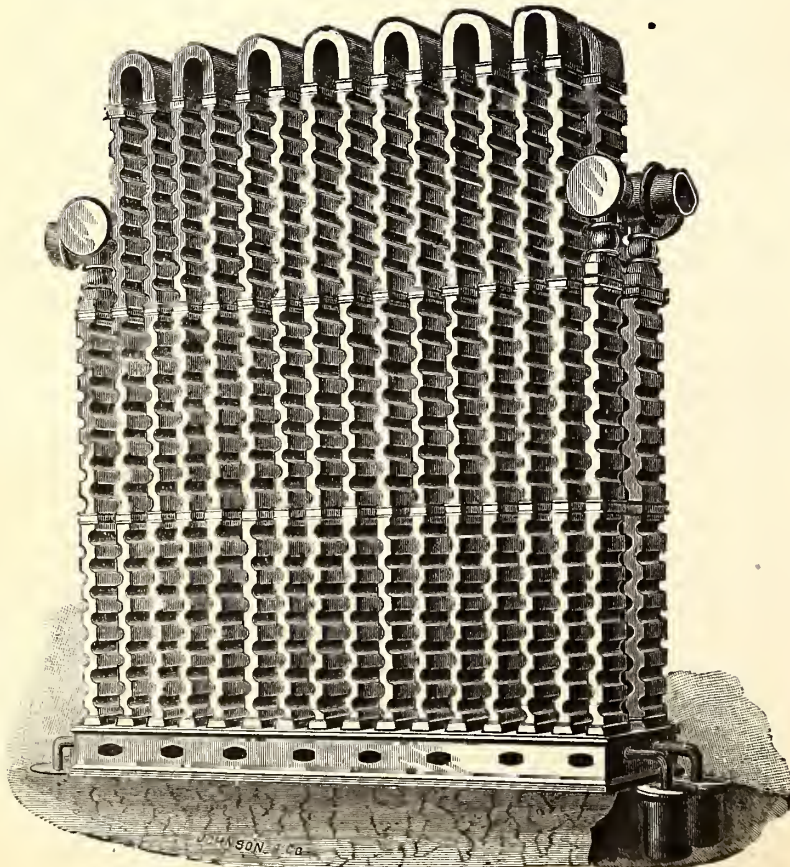

We desire to draw the attention of the gas community to the merits of the SINUOUS FRICTION CONDENSER. Companies intending to introduce new condensers into their works will do well to confer with us and examine plans and estimates before contracting for any other pattern. The FRICTION CONDENSER is now in use at the gas works located in the following places:

Portland, Me.	Brookline, Mass.	Pawtucket, R. I.	Frederickton, N. B.
Newport, R. I.	Chelsea, Mass.	Jamaica Plain, Mass.	St. John, N. B.
Gloucester, Mass.	Woburn, Mass.	Attleboro, Mass.	Paterson, N. J.
Newton & Water- town, Mass.	Peoria, Ill.	Calais, Me.	Dover, N. H.
	Clinton, Mass.	Fall River, Mass.	Waltham, Mass.
		Nassau Works, Brooklyn, N. Y.	

DAVIS & FARNUM MFG. CO.

MANUFACTURERS OF

Gas and Water Pipes,

AND

GAS AND WATER MACHINERY

OF THE MOST APPROVED PATTERN.

Also, Gasholders and Iron Roofing.

Orders from Gas and Water Companies promptly attended to.

WALTHAM, MASS.

Boston Office, Room 55, Mason Building, 70 Kilby Street.

GAS COALS.

Newburgh Orrel Coal Co.,

MINERS AND SHIPPERS OF

**Newburgh Orrel, Tyrconnell
and Palatine Gas Coals.**

ALSO SHIPPERS OF FOUNDRY COKE.

Mines Situated at

Newburgh, Flemington & Fairmont, W.Va.

HOME OFFICE,

25 S. Gay St., Baltimore.

**CHARLES MACKALL,
MANAGER.**

CHAS. W. HAYS, Agent in New York,

Room 92, WASHINGTON BUILDING, No. 1 Broadway.

Shipping wharves at Locust Point. References furnished when required. Special attention given to chartering vessels.

THE DESPARD COAL COMPANY

OFFER THEIR SUPERIOR

DESPARD COAL

To Gas Light Companies and Manufacturers of Fire Clay Goods
Throughout the Country.

ROUSSEL & HICKS, } AGENTS. { BANGS & HORTON,
71 Broadway, N. Y. } { 16 Kilby St., Boston.

Mines in Harrison Co., West Va. Wharves, Locust Point, Balt.

Company's Office, 15 German St., Baltimore, Md.

Among the consumers of Despard Coal we name: Manhattan Gas Light Co., N. Y.; Metropolitan Gas Light Co., N. Y.; Jersey City, (N. J.) Gas Light Co.; Washington (D. C.) Gas Light Co.; Portland (Maine) Gas Light Co. Reference to them is requested.

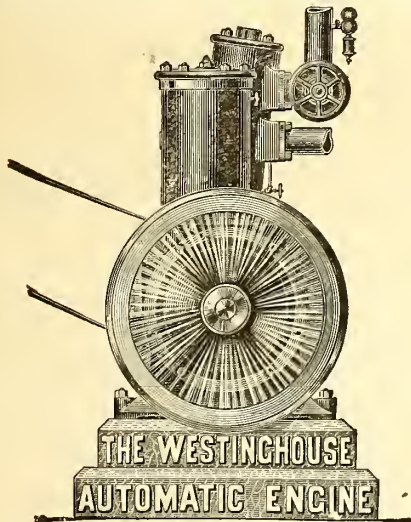

1,500 Engines Now in Use.

Our capacity being now equal to 100 Engines per month, we shall hereafter keep in stock for immediate shipment all sizes from 4 to 200 H.P.

SEND FOR ILLUSTRATED CIRCULAR AND REFERENCE LIST.

**Westinghouse Machine Co.,
PITTSBURCH, PA.**

SALES DEPARTMENT CONDUCTED BY

Westinghouse, Church, Kerr & Co., 17 Cortlandt Street, New York City.

Fairbanks, Morse & Co., Chicago, Cincinnati, Cleveland, Louisville, and St. Paul.

Fairbanks & Co., St. Louis, Indianapolis, and Denver.

Parke & Lacy, San Francisco, and Portland, Or.

Parke, Lacy & Co., Salt Lake City, Utah, and Butte, Montana.

D. A. Tompkins & Co., Charlotte, N. C.

Keating Implement & Machine Co., Dallas, Texas

Imray & Co., Sydney and Melbourne, Australia.

Robert Middleton, Mobile, Ala.

H. Dudley Coleman, 9 Perdido St., New Orleans, La.

R. Rogers, 43 Rue Laflite, Paris.

GAS COALS.

GAS COALS,

THE

PENN GAS COAL CO.

OFFER THEIR

Coal, Carefully Screened & Prepared for Gas Purposes.

Their Property is located in the Youghiogheny Coal Basin, near Irwin and Penn Stations on the Pennsylvania Railroad, and on the Youghiogheny River.

Principal Office:

209 SOUTH THIRD STREET, PHILA., PA.

Points of Shipment:

Pennsylvania Railroad Piers; Greenwich Wharves, Delaware River; Pier No. 1 (Lower Side), South Amboy, N. J.

Chesapeake & Ohio Railway Coal Agency,

FOR THE SALE OF THE

**Superior Kanawha Gas Coals, Cannelton Cannel,
Also, SPLINT AND STEAM COALS.**

From the Kanawha and New River Regions, on the line of the Chesapeake & Ohio R'way.

C. B. ORCUTT, Sales Agent. | OFFICE, 150 BROADWAY, N Y

FRANCIS H. JACKSON, PRESIDENT.

EDMUND H. MCCULLOUGH, SEC. & TREAS.

THE WESTMORELAND COAL CO.

Chartered 1854.

Mines situated on the Pennsylvania and the Baltimore and Ohio Railroads, in Westmoreland County, Penn.

POINTS OF SHIPMENT:

PHILADELPHIA, BALTIMORE, SOUTH AMBOY, N. J.
WATKINS (SENECA LAKE), N. Y.

Since the commencement of operations by this Company its well-known Coal has been largely used by the Gas Companies of New England and the Middle States, and its character is established as having no superior in gas giving qualities, and in freedom from sulphur and other impurities.

Principal Office, 224 South 3d St., Phila., Pa.

The Bower Gas Lamp.

The Perfected Duplex-Regenerative Gas Burner, under the combined Patents of Anthony S. Bower, Geo. S. Grimston, and Thos. Thorp.

The First Gold Medal awarded at the Crystal Palace Exhibition in London, and two Gold Medals at the Stockport (Eng.) Exhibition of Gas Appliances. Both in 1883.

GEO. SHEPARD PAGE, JOHN BOWER,
69 Wall Street, N. Y. City.

The Management of Small Gas Works.

By C. J. R. HUMPHREYS. Price, \$1.

A. M. CALLENDER & CO., 42 Pine St., N. Y.



INTERNATIONAL--1876--EXHIBITION.

The U. S. Centennial Commission

HAVE DECREED AN AWARD TO

HARRIS, GRIFFIN & CO.,



Twelfth and Brown Streets, Philadelphia, Pa., No. 49 Dey Street, N. Y. City, and No. 75 North Clinton Street, Chicago, Ill.,

FOR THE FOLLOWING REASONS :

The Exhibit consists of a Series of METERS from the Largest Size Station Meters for the use of the MANUFACTURE OF GAS, to those for the use of the ORDINARY CONSUMER. The Instruments are WELL MADE, RELIABLE as to INDICATION, and embody a number of sundry improvements which, with the general character of the Exhibit, entitle the whole to commendation.

Attest—J. L. CAMPBELL,
Secretary, pro-tem.

Signed—A. T. GOSHORN,
Director General

J. R. HAWLEY,
President

CHARLES E. DICKEY.

JAMES B. SMALLWOOD.

CHARLES H. DICKEY.

Maryland Meter and Manufacturing Co.,

DICKEY, TANSLEY & CO.,

Established 1866.

Nos. 22 and 24 Saratoga Street, Baltimore, Md.

No. 46 La Salle St., Chicago, Ill.

MANUFACTURERS OF

DRY GAS METERS, STATION METERS, GLAZED METERS, TEST METERS, METER PROVERS, PRESSURE AND VACUUM REGISTERS, GOVERNORS, INDICATORS, SERVICE AND METER COCKS, AND METER CONNECTIONS.

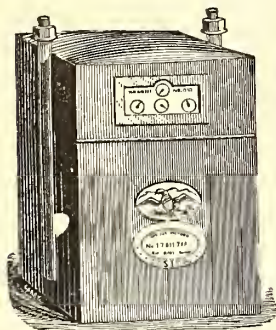

Dry Gas Meter.

With 39 years' experience and the best facilities for manufacturing, is enabled to furnish reliable work and answer orders promptly.

NATHANIEL TUFTS,

No. 153 Franklin Street, Boston, Mass.,

MANUFACTURER OF

DRY GAS METERS.

Station Meters of any Capacity.

Test and Experimental Meters, Pressure Registers, Pressure Gauges, Pressure and Vacuum Gauges.

METER PROVERS, PHOTOMETERS, STREET LANTERNS, ETC., ETC.

Patent Cluster Lanterns for Street Illumination.

SCIENTIFIC BOOKS.

We are prepared to furnish to Gas Managers, and others interested in the topics treated of, the following books, at prices named :

KING'S TREATISE ON THE MANUFACTURE OF COAL GAS. Three vols.; \$10 per vol.
GAS MANUFACTURE, by WILLIAM RICHARDS. 4to., with numerous Engravings and Plates, in Cloth binding. \$12.
THE GAS ANALYST'S MANUAL, by F. W. HARTLEY. \$2.50.
ANALYSIS, TECHNICAL VALUATION, PURIFICATION, and USE OF COAL GAS, by REV. W. R. BOWDITCH, M.A.; with Engravings; 8vo., Cloth. \$4 50.
GAS MEASUREMENT AND GAS METER TESTING by F. W. HARTLEY. \$1.60
GAS CONSUMER'S HANDBOOK, by WILLIAM RICHARDS, C.E.; 18mo., Sewed. 20 cents.

GAS CONSUMER'S MANUAL, by E. S. CATHELS, C.E. 10 cts.
PRACTICAL TREATISE ON HEAT, by THOMAS BOX. Second edition. \$5.
GAS WORKS—THEIR ARRANGEMENT, CONSTRUCTION, PLANT, AND MACHINERY. \$8.
COAL; ITS HISTORY AND USE, by PROF. THORPE. \$3.50.
THE GAS WORKS OF LONDON, by COLBURN. 60 cents.
THE GAS FITTER'S GUIDE, Showing the Principles and Practice of Lighting with Coal Gas, by JOHN ELDRIDGE. 40 cents.
GAS WORKS, AND MANUFACTURING COAL GAS, HUGHES. \$2.20.
THE MANAGEMENT OF SMALL GAS WORKS, by C. J. R. HUMPHREYS. \$1.

A PRACTICAL TREATISE ON GAS AND VENTILATION with Special Relation to Illuminating, Heating, and Cooking by Gas, by E. E. PERKINS. \$1.25.
PURIFICATION OF COAL GAS, by R. P. SPICE. 8vo. \$3.
HOW TO MANAGE GAS, by F. WILKINS. Paper. 20 cents.
THE GAS MANAGER IN THE LABORATORY, by a Practical Student. 8vo., Cloth. \$1.50.
THE DOMESTIC USES OF COAL GAS, AS APPLIED TO LIGHTING, by W. SUGG. \$1.40.
DISTILLATION OF COAL TAR AND AMMONIACAL LIQUOR, by GEO. LUNGE. \$8.50.
A TREATISE ON THE COMPARATIVE COMMERCIAL VALUES OF GAS COALS AND CANNELS, by D. A. GRAHAM 8vo., Cloth. \$3.

The above will be forwarded by express, upon receipt of price. We take especial pains in securing and forwarding any other Works that may be desired, upon receipt of order. All remittances should be made by check, draft, or post office money order.

A. M. CALLENDER & CO., No. 42 Pine Street, New York.

T. C. HOPPER, Pres. G. J. McGOURKEY, Vice-Pres. (New York). WM. N. MILSTED, Gen. Supt. & Treas. (New York). WM. H. DOWN Sec.

AMERICAN METER COMPANY,

WET AND DRY GAS METERS. STATION METERS. EXHAUSTER GOVERNORS. DRY CENTRE VALVES. GOVERNORS FOR GAS WORKS. PRESSURE REGISTERS. PRESSURE & VACUUM REGISTERS. PRESSURE & VACUUM GAUGES. CRESSON GAS REGULATORS. MARSLAND WATER METERS. METER PROVERS. PORTABLE TEST METERS. EXPERIMENTAL METERS. AMMONIA TEST METERS. BAR AND JET PHOTOMETERS.

<p>Manufactories: 512 W. 22d St., N. Y. Arch & 22d Sts., Phila.</p>	<p>GAS STOVES, SUGG'S "STANDARD" ARGAND BURNERS, SUGG'S ILLUMINATING POWER METER, Wet Meters, with Lizar's "Invariable Measuring" Drum.</p>	<p>Agencies: 177 Elm Street, Cincinnati. 244 & 246 N. Wells Street, Chicago. 810 North Second Street, St. Louis. 122 & 124 Sutter St., San Francisco.</p>
--	--	--

HELME & McILHENNY,

(Successors to Harris & Brother. Established 1848)

GAS METER MANUFACTURERS,

CONTINUE AS HERETOFORE AT THE OLD ESTABLISHMENT,

Nos. 1115 and 1117 Cherry Street, Philadelphia, Pa.,

To Manufacture Wet and Dry Gas Meters, Station Meters, Experimental Meters, Meter Provers, Center Seals, Pressure Registers, GOVERNORS, INDICATORS, PHOTOMETERS, & ALL OTHER KINDS OF APPARATUS FOR USE IN GAS WORKS.

From our long practical experience of the business, and from our personal supervision of all work, we can guarantee all orders to be executed promptly, and in every respect satisfactorily.

WM. WALLACE GOODWIN, Prest. and Treas. WM. H. MERRICK, V.-Prest. S. L. JONES, Sec. S. V. MERRICK, Supt.

THE GOODWIN GAS STOVE AND METER COMPANY,

Successors to W. W. GOODWIN & CO.

1012, 1014 and 1016 Filbert St., Phila., Pa. 142 Chambers St., New York.
76 Dearborn St., Chicago, Ill.

WALDO BROS., Agents, 88 Water St., Boston.

MANUFACTURERS OF THE "SUN DIAL" GAS STOVES, FOR COOKING AND HEATING PURPOSES.

Dry and Wet GAS METERS, Station Meters (Square, Cylindrical or in Staves) Glazed Meters, King's and Sugg's Experimental Meters, Lamp Post Meters, Etc., Etc., Meter Provers (sizes 2, 5 and 10 feet), Pressure Guages of all kinds, Pressure Registers, Pressure and Vacuum Registers, Pressure Indicators (sizes 4 inch, 6 inch and 9 inch), King's Pressure and Vacuum Gauges, Dry and Wet Centre Seals, Dry and Wet Governors, Exhauster Governors, Photometers of all descriptions. Letheby's Sulphur and Ammonia Test Apparatus complete—also Testing and Chemical Apparatus of all kinds, and of the most perfect description, for all purposes relating to Gas.

GOODWIN'S IMPROVED LOWE'S JET PHOTOMETER.

Agents for Bray's Patent Gas Burners and Lanterns.

Special attention to repairs of Meters, and all apparatus connected with the business.
All work guaranteed first class in every particular, and orders filled promptly.

G. B. EDWARDS, Mang'r, New York.
E. H. B. TWINING, Mang'r, Chicago.
A. B. STANNARD, Agent.

D. McDONALD & CO.,

GAS METER MANUFACTURERS.

(Established 1854.)

51 Lancaster St., Albany, N. Y. 34 & 36 West Monroe St., Chicago, Ill.

STATION METERS, EXPERIMENTAL METERS, METER PROVING, PRESSURE & VACUUM REGISTERS, PRESSURE GAUGES, ETC.

Also STAR GAS STOVES, RANGES, and HEATING STOVES.

We use only the very best materials, and employ the most skilled labor, and by our long experience (29 years) and personal supervision of every detail, we feel justified in assuring the public that our goods will give perfect satisfaction. Every Meter emanating from our establishment will bear the State Inspector's BADGE, and will be fully warranted by us. Our Annual and Calendar will be sent to Gas Companies upon application.

KING'S TREATISE ON COAL GAS.

The most complete work on Coal Gas ever published. Three vols., bound, \$30.

A. M. CALLENDER & CO., No. 42 Pine Street, New York.

THE GOODWIN GAS STOVE AND METER CO.,

1012-18 Filbert St., Phila., 142 Chambers St., N. Y., 76 Dearborn St., Chicago.

Agents, WALDO BROTHERS, 88 Water Street, Boston.

WM. W. GOODWIN, PRES. & TREAS.
W. H. MERRICK, VICE-PRES.
S. LEWIS JONES, SEC.
SAMUEL V. MERRICK, SUPT.

SOLE MANUFACTURERS OF THE

G. B. EDWARDS, Mang'r, N. Y.
E. H. B. TWINING, Mang'r, Chicago.
A. B. STANNARD, Agent.

"SUN DIAL" GAS STOVES

The Most Economical, Efficient, and Durable Gas Stove Made.

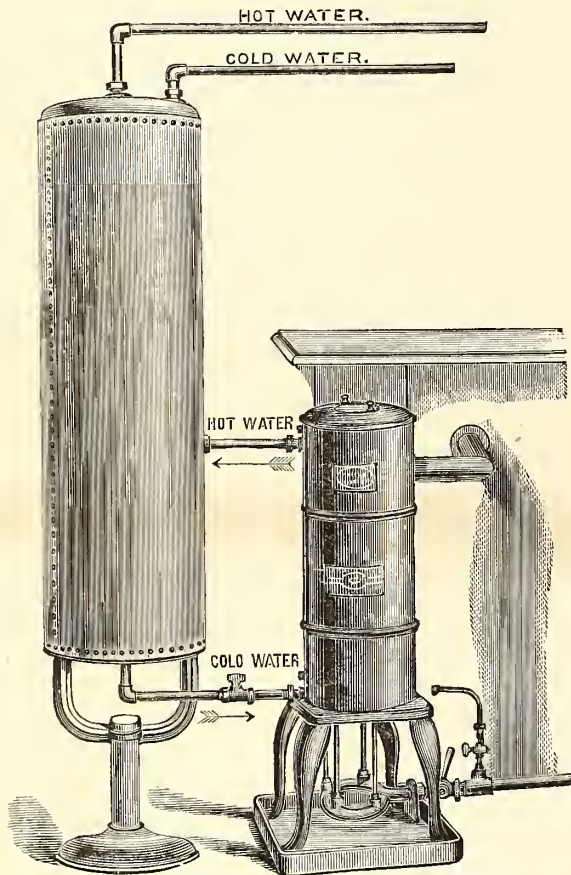

I.—Safety Hot Water Generator and Boiler.

Safety Hot Water Generator and Boiler.

Cut I. represents our Safety Gas Hot Water Generator and Boiler, arranged for home use. This most easy, quick, and economical way of preparing a warm bath, or for heating water for any domestic purpose, entirely supersedes any necessity for the use of ranges or stoves—a great comfort, particularly in hot weather. The boiler being self-filling, as the hot water is drawn off, can never become empty, thus preventing the possibility of any accident.

We beg to call attention to the cast iron pan which is now attached to the legs of the Generator (see illustration). This is to catch the drippings from the Coil, which many persons suppose come from a leak, when in fact they are produced by condensation. This condensation is caused by the hot flame coming in contact with the coil filled with cold water.

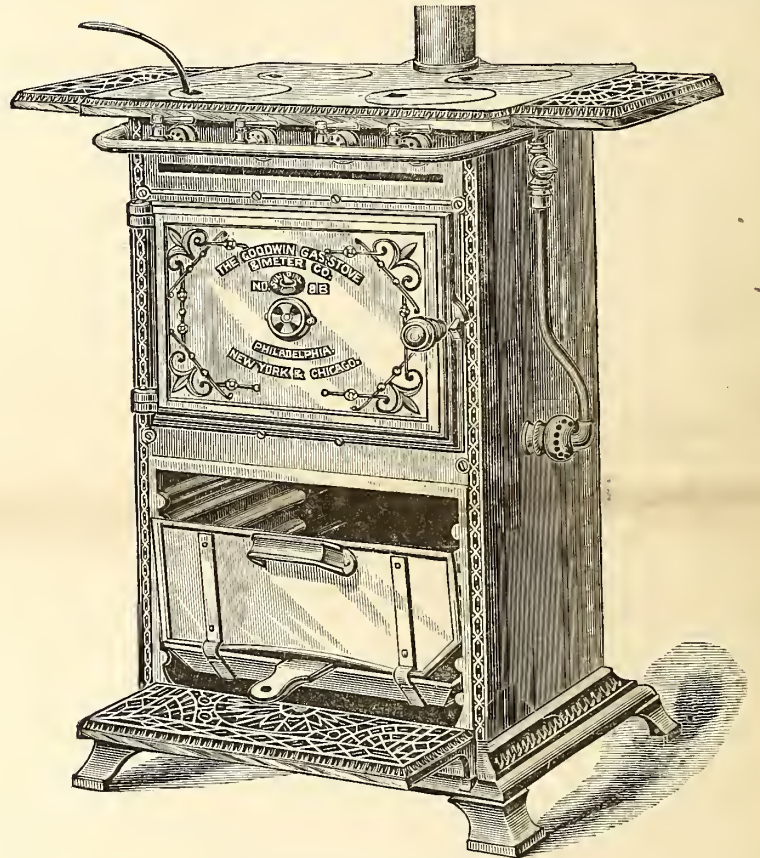

II.—Gas Cooking Stove No. 8 B.

New Style Gas Cooking Stove.

Cut II. represents our New Style Cooking Stove. As will be seen, it has an ornamented cast iron base and front, and extension shelves. The oven burner, which is atmospheric (unless otherwise ordered), is of an entirely new and improved pattern (patent applied for). The ovens are of greater capacity than those of the old style. The top, in conjunction with the outlet pipe, is designed to carry off all products of combustion; hence the outlet pipe must be connected with a flue, or the stove will not work properly.

This Stove has 4 boiling burners in top of hot plate. All fittings are nickel plated. We are making this style of Cooking Stove in the following sizes—viz., No. 7 B, No. 8 B, No. 9 B, and No. 10 B.

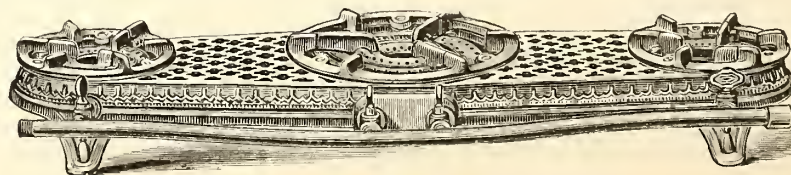

III.—Improved Hot Plate, No. 108.

New Style Hot Plates.

Cut III. represents our New Style of Hot Plates, of which we are making No. 106 (two small boiling burners), No. 107 (two medium sized boiling burners), and No. 108 (two medium and one large boiling burner). See new Catalogue and Price List for further particulars.

THE AMERICAN

GAS LIGHT JOURNAL

PUBLISHING OFFICE NO. 42 PINE STREET

DEVOTED TO THE INTERESTS OF ILLUMINATION, VENTILATION, WATER SUPPLY AND DISTRIBUTION, & GENERAL SCIENCE.

VOLUME XLIII.—No. 4.
Whole No. 628.

NEW YORK, MONDAY, AUGUST 17, 1885.

\$3 PER ANNUM
IN ADVANCE.

A. M. CALLENDER & CO., Proprietors. C. E. SANDERSON, Manager.
JOS. H. THOMAS, C.E., Editor.

ENTERED AT THE POST OFFICE AT NEW YORK, N. Y.,
AS SECOND CLASS MATTER.

Published on the 2d and 16th of each month, at No. 42 Pine Street, N. Y.

Terms of Subscription, including Postage.—For the United States and Canada, \$3 per annum. European countries, \$3.50 (15 shillings—18 francs). All payments to be made in advance. Single copies, 15 cents.

Remittances should be made either by post-office order, registered letter, or bank draft on New York, payable to the order of A. M. Callender & Co.

Collections are invariably made directly from this office, for subscriptions, advertisements, etc. We have agents to solicit the same, but they are not authorized to receipt for money.

Correspondence.—Wishing to make this JOURNAL a gazette of intelligent discussion to those of our readers who may wish to gain or give information on the subjects to which its columns are devoted, correspondence is solicited for publication from all who make the study of those subjects a pleasure or a profession.

The American News Company, Nos. 39 and 41 Chambers street, New York, are agents for this JOURNAL. Newsdealers will send orders to them.

Books.—We will forward by express, at publisher's lowest rates, any book—scientific or otherwise—to any address in the United States or Canada. No books will be sent C. O. D.

CONTENTS.

An Asterisk (*) denotes an illustrated article.

OFFICIAL CIRCULAR—	
Semi-Annual Meeting of the New England Association of Gas Engineers.....	85
OFFICIAL NOTICE—	
Iowa Gas Association.....	85
EDITORIALS—	
The Death and Burial of a Hero.....	86
The Lowe Incandescent Burner.....	86
The Market for Gas Securities	86
Eighth Annual Meeting of the Western Gas Association—Official Report—Continued from page 65.....	87
Second Day, Morning Session—Discussion on Paper Submitted by Mr. G. S. Page—Afternoon Session—Report of Committee Appointed to Name Place for Holding Next Annual Meeting—Natural Gas, by E. McMillin.	
Text of the Bill Creating a Board of Gas Commissioners for the State of Massachusetts.....	92
Results of a Trial with the "Chamberlain Gas," by Frederic Egnor	93
Regulation of Pressure in Elevated Districts.....	94
ITEMS OF INTEREST FROM VARIOUS LOCALITIES.....	
Increasing Its Capital Stock—But This Would not Seem very Sagacious—The Monkey and the Parrot—One or Two Corrections—Personal—They Might Consolidate—The New Superintendent—The Pintsch System—Carbolcrystal—Note—New Zealand Lignite—The Troy (N. Y.) Heating Gas Scheme—What the Mansfield (Ohio) Gas Men are Doing—A Slight Blaze—The Situation at Louisville, Ky.—A Note from Worcester, Mass.—Mortgaging the Works—They Still Own the Place—A Sample of Indoor Arc Electric Lighting—Reducing Gas Prices at Taunton, Mass.	
Pyrometers	98
Gas Engines of Large Power.....	98
Refrigerating Machines.....	98
Something Curious.....	98

[OFFICIAL CIRCULAR.]

Semi-Annual Meeting of the New England Association of Gas Engineers.

BIRMINGHAM, CONN., Aug. 10, 1885.

The next semi-annual meeting of the Association will be held at Point of Pines, on Tuesday and Wednesday, the 25th and 26th of August. This place was selected after careful consideration of the merits of all the other places suggested, and it seemed to the committee, one of whom visited the spot, that Point of Pines presented more attractions and gave promise of more enjoyment than any other that was brought to their attention.

It is proposed to hold a short meeting at 12 o'clock, Tuesday; the afternoon and evening to be spent in an informal manner—talking, walking, sight-seeing, sailing, etc., according to individual tastes and preferences. Wednesday morning a sail will be taken in some boat to be furnished by the Association. The boat will return about one o'clock, and the banquet, which will terminate the meeting, will be given at two.

The hotel bill for each person, including banquet (without wine), will be \$6. Deductions will be made from this sum for any portion of the entertainment which may be omitted.

It is hoped that the ladies who have so kindly favored us with their presence for several years past, and who have added so much to the enjoyment of the Semi-Annals, will not forget us this year; and to their number it is hoped others may be added, so that the family of each member will have at least one lady representative at the coming meeting.

Any member desiring to invite any friend or friends not members of the Association will please notify the Secretary, and an invitation will be forwarded at once.

Will all the members who are intending to be present kindly notify the Secretary at once of that fact and the number they will bring with them, so that accommodations can be secured at the hotel and arrangements made for the banquet, boat, etc.?

Trains leave Boston for Point of Pines via Eastern R. R., or Boston, Revere Beach and Lynn R. R., at short intervals.

M. S. GREENOUGH, }
C. L. GEROULD, } Committee.
C. H. NETTLETON, }

[OFFICIAL NOTICE.]

Iowa Gas Association.

BURLINGTON, IOWA, Aug. 8, 1885.

To the Fraternity of the State of Iowa:

You are hereby earnestly invited to meet together on the third Wednesday (16th) of September, next, to complete the organization of the Iowa Gas Association, to confer together upon matters of interest connected with the gas business in this State, and to promote a more intimate acquaintance and fraternal relationship than has heretofore existed among us.

The meeting will be organized at 10 o'clock A.M., at the Barret House, where provision has been made for the accommodation of all.

Please be good enough to indicate by letter, addressed to the undersigned at an early date, of the acceptance of this invitation.

R. SPENCER, President.

THE DEATH AND BURIAL OF A HERO.

The twenty-third day of July, 1885, will go down to history as marking the occasion of a most sorrowful event—the demise of our soldier-President, Ulysses S. Grant; and while we cannot wish, in view of his long-protracted and terrible sufferings, that another moment had been added to his great anguish, we also cannot but keenly feel the shock resulting from the reflection that our hero is no more. We write of the dead soldier and president as one who had saved his country and remember the way in which he served it best in his treatment of those who acknowledged their honorable defeat.

Did we need evidence of the feeling existing in the Southerners' hearts towards the nation's defender, could we find better than that afforded by their demeanor and action between the sorrowful days of July 23d and Aug. 8th, or by their united voice since? An emphatic "No!" must be the response. There is, then, one side of the gloomy picture that may be looked upon with a feeling akin to pleasure—our hero's life was not terminated until he had witnessed the blotting out of all sectional strife, and knew that the North and South were firmly reunited forever.

THE LOWE INCANDESCENT BURNER.

"Prof." Lowe and his wonderful "inventions" have occupied a large share of the attention of the gas engineers of the present day; and we must confess that the "Prof." and his adjuncts have not been altogether successful—at least it would so seem—in filling any appreciable measure of space, or of bestowing any decided amount of profit upon those who were venturesome enough to make purchases of patent rights, etc. From the foregoing we would not wish it to be inferred that the "Prof." himself, and his partners, have not been successful in heaping up quite a comfortable store of this world's goods—be the latter included under the different items of stocks, bonds, cash in bank, supplies on hand, or any other of the various well-known ledger headings of a really prosperous mercantile house. No; information and belief incline us to the idea that the "Prof." is "doing quite well" in this direction.

Of course, it is pretty well known at this time that the "Prof." professes to have made another great discovery in the application of "gas science;" and for some months past various journals, technical and otherwise, have published most glowing accounts as to how the "Prof." had solved the problem of an incandescent gas light. Heating gas, which could be made and sold at enormous profit when disposed of at the figure of 50 cents per thousand cubic feet, was hereafter to turn night into day when consumed through the medium of the "Lowe Incandescent Burner." The trouble about some of the gas men is that they are disposed to view the "Prof.'s" assertions with a certain amount of suspicion. Having heard him "profess" before, without beholding the fruit of the "professions" made practically manifest afterwards, it is but natural that doubters should be plentiful; and in the case of the incandescent burner these suspicions were not weakened when it was understood that a rather Keely-like air of mystery surrounded the details of the new invention. The material out of which the burner was constructed was "a secret known only to the inventor," etc. Now, all that sort of bosh may serve very well to satisfy holders of Keely motor stock; but holders of stock in gas companies, and in the habit of receiving dividends thereon, are not usually inclined to look with favor upon the proposed purchase of patent rights having only the initial merit (?) of mystery surrounding them, and that mystery put forward as one of the reasons why investigation should be made. We have received several communications from subscribers the writers of which seemed desirous that we should explain all about the Lowe incandescent light; but as we, at the time of their receipt, knew nothing at all about the subject, all such querists received the answer that when we were posted in the matter we would tell what we knew, and this promise we now propose to redeem.

The limits of Norristown, Pa., having become too small for the swelling importance of the new invention, the show quarters of the mysterious incandescent composition were removed to Lynn, Mass., where all the gas world was invited to pay a visit of inspection. Amongst the rest of the "ignorant" we were honored with the following:

"LOWE MANUFACTURING CO.,
LYNN, MASS., July 28, 1885. }

"AMERICAN GAS LIGHT JOURNAL, New York City:

"Gentlemen:—We now have the "Lowe" incandescent system of gas lighting in active operation at our place, No. 23 Market street, this city, and knowing you to be interested in some branches of the gas science, extend to you an invitation to inspect same at your convenience.

"I to-day send you a Lynn Transcript, which contains a notice of our light.

Very truly, etc.,

"L. P. LOWE."

Of course, we were glad to understand that the Secretary of the Lowe Manufacturing Company had arrived at the point of "knowing" that we were "interested in some branches of the gas science," and thought him to be justified in making the assertion when we remembered that our apprenticeship had been served years before Mr. L. P. Lowe had been added to the world's population. The Lynn newspaper also came to hand; but we really could not make use of the article contained therein, as it closely resembled—not in typographical appearance, but in contents—a reading notice at "so much per line." A trip to Lynn, with the necessary period to be allotted to the investigation, would take up more of our time than we could possibly spare at the particular juncture, and so we were compelled to cast about for a representative. It was our good fortune to secure the services of one of the brightest, cleverest, and most impartial gas engineers of the East to act for us in making the investigation. His instructions were to act simply as though he were making the examination on his own account; and the result thereof is the following:

"The burner consists of a strip or loop of wire about one inch in diameter. Looped over the tip, and secured to the sides of the burner near the tip, is a helical coil, such as would be formed by winding a fine wire around a small lead pencil. The flame impinges upon both loop and coil, heating them to a point of incandescence rather under that of the ordinary incandescent electric light.

"The effect produced is that of a horseshoe-shaped band of light, one inch across the circle, and of about the width of a lead pencil. It is perfectly steady, and almost white in color. The gas issues from burner tip, at a pressure, probably, of two inches. As neither meters nor pressure gauges were visible, I was obliged to estimate the amount of gas being consumed. As it appeared to me, the rate of consumption was over four feet per hour.

"In my judgment, each burner afforded the light of ten candles. They were shown mostly in clusters; one window contained a cluster of 16, and another one of 8 burners. In the body of the store were two clusters of 8 and 10 burners respectively—the gas being heated by the products of combustion. The light from these clusters was fully utilized, being thrown down by porcelain reflectors. Over 50 burners were employed in the lighting of an ordinary narrow city store, with white walls. The lighting effect was fair; it was far from being brilliant.

"The composition of the wire is a mystery to outsiders, but it is spoken of as being practically indestructible by heat. Three things point to its being platinum—at least for the most part; I might indeed say, if not entirely. First, its color, which is a greyish-white; second, its cost, which is high; third, its power of lighting the gas when at low heat—a characteristic, of all the metals, alone possessed by platinum.

"The failure of Lewis's platinum burner, and the results of Edison's experiments on incandescent wire, do not augur well for the success of the Lowe burner. As a means of lighting, taken by itself, there seems to be little chance for its competing with gas as ordinarily supplied. We should work under the disadvantage of high pressure, and a delicate and costly burner, to save not over 25 cents in the cost of gas in holder—the expense of distribution, etc., being of course the same in each case.

"When combined with heating gas, and considering the possibility of distributing an enormous quantity for fuel purposes, by which expenses may be averaged down, possibly another face may be put upon the matter. However, inquiry among the customers of the Lynn fuel gas company demonstrates that heating gas is there almost universally considered a failure—its cost to consumers, even at a charge of fifty cents per thousand, is deemed too great by them. The business now being done there is much less than when the company started, and is still gradually decreasing. A canvass of Lynn, even in the limited period allowed, convinced me that the time for heating gas has not arrived; while without the support of heating gas the incandescent light stands a poor chance of permanent success."

Our readers may rest assured that we will return to this matter again.

The Market for Gas Securities.

The city market for gas securities remains dull, although the records show that strength marks the situation. Consolidated gas rules at previous figures, but the transactions have just about been frequent enough to make a quotation. In our item columns we note the fact that the Equitable stockholders have decided to increase the capital stock of company in the sum of one million dollars. The East New York (L. I.) Company management have also decided to issue a first mortgage of a quarter million.

Brooklyn shares are strong. Williamsburgh is up to 156-160, and higher prices are predicted. Peoples' gas is stronger, while the only delinquent in the Brooklyn list, in the matter of ruling quotations, is instanced in the case of Citizens Company. Metropolitan, of Brooklyn, would seem to be a purchase.

In out-of-town shares but little change is recorded, save in the case of Chicago gas. In spite of the queer proceedings recently transacted in the Lake City municipal circles (reference is here made to the Equitable "deal" now in progress there), the stock of the Chicago Company is held at advancing figures. For regular list see page 98.

[OFFICIAL REPORT—Continued from page 65.]

Eighth Annual Meeting of the Western Gas Association.

HELD AT THE TREMONT HOUSE, CHICAGO, ILLS., MAY 13, 14, and 15, 1885.

SECOND DAY—MORNING SESSION.

After a vote of thanks (on motion of Mr. Somerville) had been tendered Mr. Page for his paper on the Cooper Coal Liming Process, President Lansden advanced the hope that a spirited discussion on the topic treated of would ensue. He said the paper brought up points that might be new to some of the members present, although the technical journals had contained copious mention of the matter. He (the President) further remarked that if the statements made by Mr. Page would bear the test of practice, the Cooper process could not fail to be of great value and importance to the gas men of the United States, and more particularly to those residing in the Western section of the country.

Discussion.

Mr. Geo. G. Ramsdell—I listened attentively to Mr. Page, but I failed to obtain an accurate impression as to the first cost of this process. About how expensive is it?

Mr. Page—I think that this was clearly outlined in my paper. Mr. Ramsdell will find it stated therein that not only is there no additional plant required, but that actually the plant is diminished.

Mr. Ramsdell—I mean as to the cost of material.

Mr. Page—That question is covered by the statement which puts the additional cost of the lime used at £244, or \$1,220. The value of the weight of lime found in the resultant coke, and sold as coke, is put at \$700, or, so far as these items go, showing a difference in first cost of \$520; but the saving in cost of purification is placed at £570—or a net saving over the old system of about £465—to which is also to be added the increased value of the greater weight of sulphate obtained (£282); making, in round numbers, £748 as the net profit returned in the course of twelve months' working at Tunbridge Wells, on the carbonization of 11,000 tons of coal. As Mr. Spice puts it, the net money value paid into the treasury amounted to 30 cents per ton of coal carbonized; or, in other words, as a consequence of introducing the Cooper process, the distillation of 11,000 tons of limed coal increased the Tunbridge Wells plant's receipts by the sum of \$3,300, to make no mention of doing away with the foul lime nuisance.

Mr. Thomas Smith—Toward the end of the seventeen months in which those purifiers were used, was there no increase in sulphuretted hydrogen shown?

Mr. Page—In regard to that point Mr. Spice says that during the seventeen months' working the average test showed but 10.17 grains per 100 cubic feet of gas—the variation was but 2.05 grains up or down. At Tunbridge Wells they are making much purer gas than is being put out by the London companies. According to the official tables in Examiner's report, these latter average 16 grains per 100 cubic feet.

Mr. E. McMillin—Did not Mr. Page say that the sulphur compounds were reduced one-half in the crude gas, the reduction being due to the use of limed coal?

Mr. Page—I believe that is the statement.

Mr. McMillin—These purifiers have only had half the work to do that was exacted from them before, and of this result one-half is to be attributed to the liming process, while the other half is due to the percentage of air that is admitted?

Mr. Page—The introduction of the one per cent. of air is claimed to be an important feature.

Mr. McMillin—Should we introduce air, those of us who are now using oxide would come within fifty per cent. of accomplishing what they are doing?

Mr. Page—I cannot see how that is; but you will probably try the experiment.

Mr. McMillin—I certainly will.

Mr. Page—I might perhaps explain my position in regard to this matter. My interest in the subject arose on account of an intimate personal acquaintance with Mr. Spice, which was formed when I met him in London, and fostered since by correspondence. He had been in this country, and is known to many of our gas engineers. In my opinion this is one of the most important aids that have recently come to the front as an assistant to coal gas. I have gathered this data as a result of correspondence and a scanning of the English and American gas light journals, in connection with other scientific papers.

Mr. Somerville—I was extremely glad when I noticed Mr. Page's name down to read this paper, because I knew he would present something very interesting. I have not been disappointed. I feel just now like putting that process into my works. Certainly the facts are astonishing. There are one

or two questions, though, that I would like to ask him. He spoke of the cost as being about 12 cents; does that sum include the royalty payments? I understand it is a patented process.

Mr. Page—I cannot answer that point.

Mr. Somerville—Mr. Page says that the lime was dampened with its own weight of water. The thought has just struck me—would not this be putting damp coal into the retorts? Still, there are the results. He mentioned also (and I noticed the distinction drawn) about the quality of the coke. Twice he drew attention to its value as a fuel for domestic purposes; still, it is well known that we have occasion to use the coke for other than domestic purposes. I would like to ask Mr. Page if there is any trouble in using that coke in our furnaces; does this lime cause any flux on the grate bars? Or why did he so carefully mention that it was good for domestic purposes? Is it not good also for use in our furnaces?

Mr. Page—The statement was made absolutely that there is no damage caused to settings or grate bars on account of fluxing. In domestic use the limed coke burns with a bright flame. It adds to the coke precisely that element needed to make it the very thing for use in open grates.

Mr. McMillin—I should think the limed coke would be objectionable for use in metallurgical operations, because of the fact that the sulphur, being contained as sulphate of lime, would not be vaporized. I take it for granted that Mr. Spice sells his coke by weight. The question whether coke should be sold by weight or by measure, formerly occupied a large portion of the time of our Association. That gentleman, I know, would advocate selling his coke by weight. Probably 60 pounds of lime would not add anything to the measure.

Mr. Page—I have found no reference in the technical journals to the use of limed coke in metallurgical operations. There need be no grave fears entertained on that head, however, since the coke of gas works is principally consumed in the household or in the retort house.

Mr. Somerville—Is it not also a fact that other English engineers have tried the Cooper process without securing a repetition or even an approach to the favorable results reported from Tunbridge Wells? And is it not the case that there is now a good deal of discussion going on there with regard to the subject?

Mr. Page—I believe I may say that no other subject brought up during the last two or three years at the meetings of the English Association of Gas Engineers has met with like opposition. Only nine months ago the editor of the *English Journal of Gas Lighting* made light of the Cooper process; but in a more recent issue, or when the year's working at Tunbridge Wells was reported, he commented more favorably upon it. Geo. Stevenson attacked it; your good brother John Somerville reported adversely; and others of the most distinguished men among the gas engineers in Scotland opposed it. Still, they cannot attack results. If it is successfully worked on 11,000 tons of coal at Tunbridge Wells, why should it not succeed when applied to the 3,000,000 tons of London? So, at least, I would be inclined to reason on the matter. Now that gas engineers are beginning to favor it, and the technical journals are saying that it is looking like a success, I think we must admit that what Mr. R. P. Spice (whose record from beginning to end as a gas engineer has never been questioned) says with regard to this can be accepted as a fact. With respect to the failures reported Mr. Spice shows conclusively that these occurred simply because the experiments tried, although on quite a large scale, were not properly attended to—their details were not given the attention and care that a new process, and one so entirely different from the ordinary mode of working, would seem to demand.

Mr. E. J. King—Mr. Page—considering the increased yield of ammonia under the liming process—can you state what effect that yield will have on its price?

Mr. Page—Here you may appreciate another reason why I should have an important interest in this process—it enlarges the production of ammonia hitherto secured from a ton of coal. When you increase the quantity of ammonia gained from a ton of coal, you increase the income of every coal gas company. Ammonia is sure to become a more extensive article of commerce than is the case at present. Nitrate of soda cannot long be sold at 1½ cents per pound (delivered) in the markets of London and New York. Even if sulphate continues at the figure of 3 cents per pound, with a 20 per cent. increase in the amount gained from a ton of coal secured, we see again that that which is lacking in the water gas process gives an important value to coal gas—viz., the residuals that are secured at by the water gas promoters. But when, as has been shown in a recent American case, the residuals pay for the coal delivered in the gas company's house, the matter becomes important.

The President—I would like to know of that place where the gas man's residuals are sold for what his coal costs him. I would like to go there and make gas.

The Association here took a recess, with the understanding that business would be resumed at 2 P.M.

AFTERNOON SESSION.

The President convened the members at the appointed hour. Mr. E. McMillin called attention to the fact that the second article of the by-laws read as follows :

"Any person directly or indirectly connected with the management of gas works or gas machinery, or who may be skilled therein, shall be eligible for election as an honorary member of this Association." He offered the following as an amendment thereto :

"Resolved, That article II. of the by-laws be amended by striking out the word 'honorary' in the fourth line, and inserting in lieu thereof the word 'associate.'"

Mr. McMillin then went on to say—We now have about as many honorary as active members. That is rather an anomalous condition of affairs, where a body elects a gentleman to membership, requires him to pay dues, and yet affords him no privileges. There would seem to be little of honor conferred by the process. It is on this account that I offer the amendment.

The President—The amendment offered by Mr. McMillin covers the purpose originally intended. A mistake occurred in the printing of the by-laws by which the original intention was nullified. As I understand it, this amendment will lie over until the first day of our next regular meeting, at which time it will come up for final action.

REPORT OF COMMITTEE APPOINTED TO NAME PLACE FOR HOLDING NEXT ANNUAL MEETING.

Mr. R. Spencer, from Committee to Name Place of Next Meeting, reported that Columbus, Ohio, was recommended as the choice of those having the matter in hand. After some discussion the Association ratified the selection. As a Committee of Arrangements the President named Messrs. E. McMillin, of Columbus; Eugene Printz, of Zanesville; and Geo. H. Taylor, of Warren.

The President also appointed Messrs. James Somerville, J. B. Howard, and Z. T. F. Runner, as a Committee to prepare and present resolutions of thanks to the gentlemen who had made such elaborate preparations for the comfort of the members during their visit in Chicago.

Mr. Emerson McMillin, of Columbus, Ohio, then read the following paper on the subject of—

NATURAL GAS.*

After the publication in the *Ohio Mining Journal* (last August) of the very interesting and instructive paper by Dr. Orton, Chief Geologist of the Ohio Survey, it may naturally occur to you that now there is but slight call for another paper bearing upon the same subject. The question, however, is one of so much interest that it will bear frequent discussion; and while I shall present neither original ideas nor startling developments, I possibly may be able to present enough of fact, as ascertained by others, to make this paper of some value. As all those present may not have been fortunate enough to have seen Dr. Orton's article in print, I will cover, hurriedly at least, a portion of the ground discussed in his paper.

We are told that the Chinese have for hundreds of years utilized the natural gas issuing from the crevices of the earth's surface in some portions of the Flowery Kingdom, and that they now drill, in some instances, 3,000 feet deep to strike the gas veins. Perhaps the oldest historical instance of which we have a record of the discovery and use of natural gas is that of the Apollo Oracle, at Delphi, Greece. Natural gas was used there a thousand years before the Christian Era. It has been utilized in many portions of Europe and Asia for hundreds of years. There are traditions that the red man smoked his pipe in the lurid light of burning springs before the advent of the white man to the American Continent. It was used at a very early day in the Kanawha Valley for the evaporation of salt water. In a letter recently received from the proprietor of the gas works at Fredonia, N. Y., he tells me that the gas has been in use there for more than sixty years; that it is necessary to drill only from 100 to 300 feet in order to obtain it; that some fifteen wells, mostly of recent date, are in use; and that increasing the number of new wells did not appear to diminish the supply in any of the old ones. A gas well was struck in boring for salt at Olive, Noble County, Ohio, in 1814. Residences in Lorain County, Ohio, have been lighted for fifteen or twenty years with natural gas. At East Liverpool, Ohio, the gas has been flowing for more than twenty years. At New Cumberland, W. Va., the gas has been utilized for twenty-five years, and the supply is still good. In scores of other places, in this and other States, natural gas has been utilized for the past twenty-five or even fifty years. Yet apparently the interest has not been great or general in this question until recent times.

To enumerate all the places and locations where gas has been found would require a volume itself. The records in this respect are not so complete as are the records respecting oil geographical locations and geological horizons.

I would assume, however, that wherever oil is found gas must almost of necessity be near. The following are a few of these locations and horizons: Oils and bitumen of the Pacific Slope, of Mexico, West Indies, and South America are tertiary; in California, miocene; and eocene in Trinidad. Nearly all far East productions may be, as far as known, accredited to the eocene epoch. The greatest part of the world's supply of petroleum comes from horizons in the rocks older than the carboniferous period, though the greatest number of localities and largest extent of oil bearing strata are of much more recent date, eocene rocks being the greatest reservoirs.

Gas has been found in quantities possessing economic value in or directly over the Utica shales of the lower silurian, as at Burkesville, Ky.; Collingwood, Canada; and in the lower gas veins of Findlay and Bowling Green, Ohio; in the Niagara shales of the upper silurian, as found in the upper gas veins at Findlay and Bowling Green; and in the Huron shales of the Devonian Age, as found in hundreds of places in Ohio, West Virginia, and at some points in Kentucky. In Pennsylvania the greatest gas horizon is in the Catskill rocks, while the greatest oil reservoir of Pennsylvania is in the Upper Chemung, 300 feet below the Catskill. That part of the Ohio shale designated the "Cleveland shale" is the gas and oil producer of Northern Ohio, along the lake region—as at Mecca, Grafton, etc. The gas and oil (some at least) of Washington County, Ohio, are obtained at the top of the lower coal measures; and even the lower oil rock of that locality, while being 300 or 400 feet below the first "sand" or oil rock, is still reported with a thin seam of coal a few feet above it. (See 2d Vol. Ohio Geological Survey, page 497.)

The territory in the United States in which we may expect, with some show of reason, to find gas, is quite large; and it has had its borders, so far as Ohio is concerned, materially extended during the past year. Western New York, Western Pennsylvania, Northeastern Ohio, much of West Virginia, limited parts of Kentucky and Indiana, are now producing gas. There is a possibility of finding it in any part of Ohio where the Huron shale exists with sufficient covering. The same remark probably applies to other States. It is said a good supply of gas is obtained in the neighborhood of Kansas City, at a depth of not over 300 feet. Harrison County, Indiana, seems to be a fairly good gas territory. The successful borings at Findlay and Bowling Green, Ohio, indicate that we may reasonably expect to find gas in the Trenton lime or Utica shales of the lower silurian, especially along the crest of the Cincinnati arch. The apparently favorable conditions for finding gas at this horizon extend across the western half of the State from north to south. The developments at Findlay are very encouraging, and are now sufficiently numerous to warrant predictions that success may reasonably be expected in a search for gas in the territory and at the horizon mentioned.

The southern part of our State possesses all the apparent requisites for finding gas in abundance in the Huron shale (aside from the absence of folds in the strata); and yet no wells put down in that territory have ever yielded gas in quantity to possess much if any economic value. A well drilled in the year 1865, at Rio Grande, Gallia County, starting at about the horizon, if I remember rightly, of the Upper Freeport coal, and going down 850 feet, struck gas which flowed for some years; and, for aught I know, is flowing yet. The quantity was not large, though this possibly might have been in a measure accounted for by the pressure of the water which flowed constantly from the salt rock up over the tubing. A well has been drilled during the past year by the Belfont Iron Works Company, at Ironton, Ohio. The well starts 160 feet below the horizon of the ferriferous limestone, and was driven more than 2,000 feet. But little gas, and no oil of consequence, was obtained. The parties ceased drilling when they could no longer keep out a vein of water struck at a depth of 2,000 feet, which water rose up some 800 feet in the hole, and emitted such a disagreeable odor that the workmen claimed they could no longer endure the smell, and so quit work. Just what stratum constitutes the bottom of the well is not quite clear. There were many indications that they were down into the Niagara, and the same indications would apply to the supposition that they were just through the corniferous and into the Helderberg. A sandstone was pierced, just before reaching the vein of water, saturated with sulphuretted hydrogen. Columbus is located on the horizon of the corniferous limestone, and by going down 90 feet and passing through a sand rock a vein of sulphur water, strongly impregnated with sulphuretted hydrogen, is struck, and the water flows to the surface in great quantities. To my mind the similarity is something more than a coincidence.

Some excitement prevails at Middleport, in Meigs County, at this date, over the finding of oil in that locality. A well put down for gas, across the river in West Virginia, failed to find oil or gas in quantity to possess much value.

The fact that the four gas wells at Findlay, and the three at Bowling Green, have developed new territory causes more than ordinary interest to attach to them. On page 366, 2d volume of Ohio Geology, is published an interesting letter from Dr. Carr, written in 1872, in which he says that his

* In the preparation of this paper I have received valuable suggestions from Col. T. P. Roberts, of Pittsburgh, Pa.; Prof. I. C. White, of West Virginia University; and Prof. Edward Orton, Chief Geologist of the Ohio Survey. I have drawn largely from the 10th Vol. of U. S. Census; the Petroleum Industry, prepared by Prof. Peckham, of Pennsylvania; and from Newberry's Ohio Reports.

house had then been lighted for nine or ten years from a well sunk but seven feet below the surface. Afterwards a well was drilled 135 feet into limestone; but the drill getting fast, the enterprise was abandoned, though the flow of gas was stronger than from the shallow wells. Gas was struck in small quantities in other parts of the town. In digging sewers through the town gas is struck, very foul with sulphuretted hydrogen. In drilling the second deep well at Findlay three veins of gas were struck in the gray slate—the first at 527 feet, the second at 623, and the third at 640 feet below the surface. These shales I have assumed are in the upper silurian, and belong to the Niagara group. Another and lower vein was struck at a depth of 1,200 feet, and while drilling in limestone. I assume that this is in the lower silurian, and that the gas comes from the Utica shales, or more probably from the Trenton limestones.

Many regard a good flow of gas from a well located in the vicinity of a manufacturing town as equal in value, as an investment, to a first-class gold mine. A demand is readily created for the gas at prices which must pay enormous profits upon the money expended. Nevertheless if one company were paying all the losses and reaping all the profits, up to this date it is a question upon which side of its ledger the profit and loss balance would appear.

During the year ending May 30th, 1880, there were oil and gas wells drilled to the number of 3,696. Of this number 3,541 were drilled in Pennsylvania, the remaining 155 being located in Ohio and West Virginia. The total cost of these wells, as reported to the Census Bureau, was \$9,149,907, or an average cost of \$2,475 for each hole put down. It is very probable that, under the impetus given to the business by the utilization of natural gas, and the greatly increased demand therefor, many more holes were drilled during the year 1884. The outlay for that year doubtless exceeded \$10,000,000. The total expense of putting down these wells is proportioned about as follows: Rigs, 15 per cent.; engines and boilers, 8 per cent.; drive pipes, 6 per cent.; casing, 8 per cent.; tubing, 11 per cent.; torpedoes, 10 per cent.; labor, 27 per cent. This leaves 15 per cent. for incidentals.

Col. T. P. Roberts, of Pittsburg, a gentleman who has given the subject much thought and investigation, estimates that there have been 50,000 wells drilled in Pennsylvania alone; that thousands and perhaps tens of thousands of these wells have been unproductive (failing to get oil in paying quantities, when oil was sought, and finding no gas when gas was desired) will not be questioned. Can this enormous expenditure be curtailed without interfering with or checking the development of the industry? Prof. I. C. White, of the University of West Virginia, a gentleman of much experience, and possessing rare scientific attainments in the field of geology, answers the question affirmatively.

The writer having understood that Prof. White was meeting with almost phenomenal success, both in accurately locating gas wells, and in condemning territory, asked him to give the readers of the *Ohio Mining Journal* the benefit of his knowledge and experience, to which request he kindly assented. Not having time to prepare an article for publication, he gave me the facts in a private letter, from which I shall quote liberally. He says:

"In 1883 I was engaged by Pittsburgh parties interested in natural gas to study up the question as to whether the presence or absence of gas could be determined by any geological features with a reasonable degree of certainty. In order to do this I visited the Murraysville, Tarentum, Butler, Washington, Wellsburg, and every other gas district that had been accidentally developed in drilling for oil. To my astonishment I found that every gas well in the region I was investigating was situated near or on the crown of a gentle uplift of the rocks, or on what we geologists term an anticlinal; while only a short distance (one-half to one mile) on either side, in the synclines, only salt water was found and no gas to amount to anything. For instance, the famous Murraysville well was exactly on the crest of the Pin-Hook anticlinal, of Stevenson's, Pennsylvania Report, 'K.' The Tarentum wells were near the line of the Bull Creek axis. The condition for the presence or absence of gas then seemed to resolve itself into one of structural geology. The tension of the arch of the anticline would, of course, in a loose, coarse, porous sand rock, open many fissures near the crest, and thus still further increase the capacity of the rock as a reservoir for gas, whether escaping upwards from beneath, or from the generation of gas within the rock itself, out of buried organic material. Of course, the reasons why the gas should seek the crown of the arch and the salt water be found in the trough, are self-evident from the nature of the two substances. Hence so far the theory and facts all agreed; but before practical men would take hold of the question the theory must be submitted to a practical test. To do this I traced the Murraysville arch southwestward to the Youghiogheny River, and located a test well on its crown more than ten miles from Murraysville, and where it was surrounded with water wells, one of which was one-fourth mile distant. Here certainly were the conditions for a satisfactory test. This well struck a large flow of gas (200 pounds pressure) in March of last year. On January 1st, 1884, I located gas territory for the Washington (Pa.) Heat and Light Company along the crest of the

Washington anticlinal, and the three wells they have since put down on my locations have all been good, though a well located by other parties, and bored one mile off my line, got no gas, but a small flow of oil.

"As yet I have made no failures, though some wells are much more productive than others, apparently depending both on the strength of the anticlinal and the thickness of the sand, or, in other words, the size of the reservoir."

The success in condemning territory by Prof. White has been quite as marked. He condemned the territory at Wheeling, Pittsburgh, Martin's Ferry, and other places; and in none of this condemned territory has subsequent drilling developed gas. Prof. White says the idea of finding gas at the crest of anticlinals was suggested to him by some one else.

Of course gas cannot always be found even where conditions appear to be favorable. The overlying material may not be porous enough to constitute a store-house, or fissures in the rock may permit the escape of the gas as generated; but Prof. White has certainly demonstrated that vast sums of money may be saved by intelligent investigation, and by the employment of persons with scientific knowledge—geologists—to make selections of locations for gas wells. As will be seen in another part of this paper, Dr. Newberry was governed ten years ago by the same rule in the location of oil wells. To my mind, however, the rule will not apply with the same probability of success to the location of oil as to the location of gas wells. Many writers mention the fact of the oils being located at the crest of the anticlinals. Prof. Minchell, in writing of the "oil break" of the volcano region of West Virginia, says: "Whether you strike gas, oil or water depends upon the comparative level of the point at which you strike the fissure." Dr. Orton says he has taught that idea to his classes for many years. Yet credit is due to Prof. White for making practical, thorough, and positive demonstration of the correctness of the theory, at least as applies to the location of gas wells.

It is generally conceded that natural gas, as well as petroleum, is generated from the carbonaceous material of the deeply-buried shales. There are many, however—whose opinions are worthy of consideration—who believe that the oil sands are the real producers, and still others who believe that the oil and gas come from the limestones. I think incontestable proof can be offered that all are right. I believe that the gases of the Devonian system come chiefly from the shales, but not exclusively. The corniferous lime at Chicago and Terre Haute are producers. Dr. T. Sterry Hunt estimates that the Chicago lime contains 7,750,000 barrels of petroleum to the square mile. The frequent occurrence of oil and bitumen found enclosed in geodes of limestone seems to establish the fact of its being indigenous.

The advocates of the idea that the sand rocks are not only the store-houses but the generators of the natural gases and oils have many facts to back up their theory; yet I am not sure that they have made out a clear case. To determine this point definitely it will be necessary to particularize a little more as to the real origin of the carbonaceous matter. What was it? Was it vegetable, similar to that which produced coal, or was it sea-weed debris? Or was it animal and not vegetable? Or was it both animal and vegetable? Or was it neither animal nor vegetable, but chemical? Instances may be cited in which an affirmative answer might be given to each of the inquiries. That the gases obtained from the Trenton, Niagara, and Corniferous limestones are animal admits no room for doubt in my mind. That the gases of the Utica shales, the Huron shales, and of the sandstones of the coal measures are partly animal and partly vegetable seems equally probable. That the gases of the volcanic regions are chemical may readily be believed. The writer has until recently supposed that Dr. Newberry (who was the first to suggest that the natural gases of Ohio and Pennsylvania were generated from the carbonaceous matter of the Huron shales) believed that the oils and gases were wholly of vegetable origin. A careful reading, however, of his second volume of "Ohio Geology" will show that he doubted that even at the date of that report (1874).

Speaking of the Cuyahoga shale, Dr. Newberry, in the 2d volume of the Ohio Survey, page 88, says it "is crowded with its characteristic mollusks, and with the bones, teeth, scales, and spines of fishes." The shale is described as dark gray or nearly black. On the same page he says, speaking of this same shale, that it is "literally made up of shells." On page 90, 2d volume, referring to the Berea grit, which is the oil sand of Grafton, Liverpool and Mecca, of Ohio, and the same rock is the oil sand of Oil Creek, Pa., he says, "it contains in large numbers the spine and teeth of fishes. Of these the most conspicuous are spines of a species of *Ctenacanthus*, of which more than two dozen were found upon a surface not larger than a square yard." Hundreds of quotations could be made from Newberry's Ohio Reports that would in a measure sustain the theory that the oils and gases were largely from animal matter; and many of these quotations would sustain the argument that at least some of the sandstones were producers as well as store-houses. In a paper read in February, 1882, Dr. Newberry says that the oils of the Niagara limestone are indigenous in that rock, and believes they are of animal origin. In this same paper he says the gases of the Hamilton shales are from the carbonaceous matter, apparently produced

from the decomposition of sea-weeds, these being abundant, and nearly all other fossils absent.

Very many eminent authorities may be quoted in maintenance of the claim that the natural oils and gases of some horizons at least are of animal origin. Peckham says Ohio and Pennsylvania oils are undoubtedly of vegetable origin; but thinks the Kentucky oils from the Trenton limestone are of animal origin. This statement was made, however, before the development of the new gas and oil field of Northwestern Ohio. Prof. T. Sterry Hunt attributes the origin to animal matter. There are others who reason that it is possible that they are neither of animal nor vegetable, but that the origin is purely chemical—that is, the result of chemical action upon inorganic matter. Byasson, of France, by experiment in 1871, produced petroleum from water and carbonic acid in contact with white-hot iron. A possible theory is suggested that sea water invades greatly heated portions of the earth, and comes into contact with unoxidized, highly heated metals. Berthelot, in 1866, suggested nearly the same theory, viz., the formation of acetylene by contact of carbonic acid with alkaline metals in the bowels of the earth, and then, through action of steam, carbides of hydrogen are formed. M. Mendeljeff, of Russia, in 1877, suggested that the law of gravity must put metals nearest the center of the earth. Water has reached the metallic carbides through crevices, and carburetted hydrogen is formed. In 1877 Mr. Cloez obtained oil by action of sulphuric acid on speigel-eisen.

It seems evident to me that gases are found in rocks to which they are indigenous, and in rocks where they have only been stored; that they are of animal, vegetable, and chemical origin; that the oils and gases of the older rocks are almost exclusively of animal origin; that the oils and gases of the shales are animal and vegetable—those of Devonian age in Ohio and Pennsylvania mostly vegetable; that the gases of the volcanic regions, issuing from the fumaroles, mostly chemical, with probably an intermingling of atmospheric gases or air, drawn into the earth by the chimney-like action of the volcanoes and of the fumaroles. That the oils of Ohio and Pennsylvania are not wholly derived from vegetable matter may be easily believed, when attention is called to the fact that the products of destructive distillation of coal have but few things in common with the products of oil distillation. Gas works that make gas from oil do not get a coal tar residual. I believe that neither alizarine nor anthracene, nor, in fact, any of the coloring matters of coal tar, are produced in the manufacture of oil gas. I am also under the impression that carbolic acid and cresylic acid are not found in the condensed liquids of oil gas. Little or no ammonia is produced. The heavy hydrocarbons belong to different series, and are in greater abundance. The percentage of free hydrogen is much less in oil than in coal gas. The advocates of the theory of vegetable origin may truthfully claim, however, that the valuable coloring matter obtained in the distillation of coal comes from the coal tar; that in the manufacture of oil gas the oil is really undergoing a second distillation; that the tar was left in the earth, and that the difference in quantity of ammonia present may be due to the modes of distillation. Pelouze, of France, obtained the same series of hydrocarbons from lime soap, made from fish oil, that are found in petroleum.

The distillation of the oils and gases from the fossils of the shales and limestones is a question that has not been so much discussed. The question is one that may be regarded by some as having no practical interest; and yet I am persuaded that if we had a more thorough knowledge of all these matters we would doubtless be able to reap some practical benefit from it. The temperature of the earth has been the principal factor in the distillation of the fossils. The pressure of the over-lying strata has probably been a prominent feature in the production of the oils. Could we ascertain the exact condition of the compounds when in the earth before the drill releases the pressure, it might assist us to guess what brings about liquefaction and gasification. It is the opinion of many that the natural gases of Pennsylvania exist in the earth as either solids or liquids, and that gasification occurs when the pressure is removed by the drill. Much may be said in support of this opinion, and something against it. If the gas was originally driven off from the fossils as marsh gas, does sufficient pressure exist in any of the gas wells, and especially the more shallow ones, to liquefy that gas? If the gas is compressed or distilled as an oil from the mass of fossiliferous material, and remains a liquid until the drill releases the pressure, would the gas go off so uniformly as marsh gas, or would there be vaporized the benzine series of carbon compounds, and the gases not be so permanent? It is easy to ask, but not to answer.

Dr. Newberry evidently believes that the distillation of the carbonaceous matter results in the direct production of gas, and that the liquid is produced by the condensation of the gases in the crevices of the overlying strata, as he uniformly advised searches for oil to be made at the crest of the anticlines. He says, in Vol. 2, page 504, "Ohio Geology," that the correctness of his ideas as to the proper place to drill for oil had been abundantly verified in practice. Had this statement been made by a less eminent authority I would have believed he was mistaken. Whether the gas is given off originally from solid matter, or escapes from the volatilization of the oil, in

either event it will seek the highest point, and will occupy the interstices at the crest of the anticlines; and, if in abundance, must crowd the oil to a lower level. To bore for and obtain oil at the top of the fold would, in my opinion, be to invite the expense of a pumping well (by letting the gases escape), while to drill to one side of the fold would be to utilize the pressure and tension of the gases in forcing the oil to the surface. The Pennsylvania oils are not found at the crest of anticlines, but the gases are.

To my mind the distillate of the shales was mostly a liquid; that the gases were vaporized by the long continued warmth of the earth; that the marsh gas naturally sought the highest store-house, and was constantly leaving behind the richer hydrocarbons that were no longer able to maintain a gaseous state after the lighter gas had escaped from them; and that this accounts, in a large measure, for the great variation in the illuminating power of the gases from different wells—the almost pure CH₄ being found furthest from, while the richest and best gas is found in close proximity to the oil; that by constant distillation and condensation new oil and gas "sands" are being created. The gases are doubtless becoming poorer in carbon as the pressure increases by reason of the condensation of the compounds richest in heavy hydrocarbons.

It seems hard to believe that marsh gas exists in the earth either as a solid or liquid, and yet it must of necessity be greatly reduced in bulk. By the law of the compression of gases the bulk of marsh gas that measures 1,000 feet at atmospheric pressure must have been reduced to only about 70 feet when under 200 pounds pressure in the fissures and pores of the sand rocks, and estimates of pressure many times greater are common. The idea that the gas exists as a liquid or solid is borne out, in some instances, by the great reduction of temperature resulting from the escape of gas from some of the Pennsylvania wells. A cold so intense is sometimes produced that solidification occurs of everything in the vicinity whence the gas escapes, so that in one instance, at least, a hundred feet of ice had to be drilled through to again open up a frozen well.

The chemical feature of the natural gas question is one of great interest and importance. The composition of gases from different wells varies greatly, and, as before suggested, their composition, so far as the absence or presence of illuminants is concerned, is governed by the immediate presence or absence of oil. For other features of distinction, however, we cannot so easily account. The following table gives the analyses from a number of wells in different sections of the country, chiefly, however, from wells in Pennsylvania. The figures are taken from the report of a Committee of the Engineers' Society of Western Pennsylvania, excepting only Nos. 10 and 11 (Findlay wells.)

Composition of Gas from Various Wells in Different Sections of the Country.

	No. 1.	No. 2.	No. 3.	No. 4.	No. 5.	No. 6.	No. 7.	No. 8.	No. 9.	No. 10.	No. 11.
Hydrogen	6.10	13.50	22.50	19.50
Marsh gas.....	82.41	96.50	75.44	80.11	60.27	78.24	47.37	93.09	96.49	85.690
Ethane	18.12	5.72	6.80
Carbonic acid	10.11	0.34	0.66	2.28	15.86	3.10	2.18	0.88	0.150
Carbonic oxide.....	0.50	1.00	0.375
Nitrogen.....	4.31	7.32	49.89	0.49	10.260
Oxygen.....	0.23	2.00	0.83	2.20	0.17	2.700
Illuminating hydrocarbons	2.94	1.00	3.26	0.50
Sulphuretted hydrogen.....	0.88	0.365
Carbon bisulphide	0.25	0.110

Copies of numerous other analyses might be given, but the above table is sufficiently extensive to give a fair idea of the various qualities of natural gas. These analyses would furnish a theme for a long discussion. Marsh gas largely predominates in all, with one exception, that of No. 8, and this was gas from marsh ground. In this the quantity of nitrogen exceeds 49 per cent.; and yet there is shown but 0.17 per cent. of oxygen, which is positive proof that the large per cent. of nitrogen was not due to an admixture of air. Whence came it? It will not do to assume that it is only air robbed of its oxygen, as upon that hypothesis there should be 14 per cent. of oxygen present in other combinations, while there is but 2.25 per cent. present in combination with carbon as carbonic acid. No. 7 was from Rogers' Gulch, Wirt County, W. Virginia. By reason of the very large per cent. of carbonic acid in that gas it would be worthless as an illuminant, and its calorific value would also be low as compared with most of the other samples. No. 1, from West Bloomfield, N. Y., shows more than 10 per cent. of carbonic acid. This carbonic acid gas probably comes from the partial calcination of the carbonates of lime and magnesia, or from the oxidation of the carbonates of the protoxide of iron.

The sulphur compounds are shown in but two samples, Nos. 10 and 11. While the per cent. of sulphuretted hydrogen is inconveniently large (especially in No. 10), still its presence adds an element of safety to the use of the gases, and possibly imparts to them a value that none of the other samples possess.

It seems probable that the gases that shall hereafter be found, in our State at least, at the horizon of the Findlay and Bowling Green wells, will contain sulphuretted hydrogen. The very strong odor from the Ironton well on the Ohio River, the artesian wells at Columbus, flowing water strongly impregnated with sulphuretted hydrogen, the sulphur springs of Delaware, and the gas wells at Findlay and Bowling Green complete the chain across the State, all in about the same strata, and all giving off sulphuretted hydrogen. When going still lower down into the lower silurian as developed by artesian wells at Cincinnati, the sulphur is still found strongly impregnating the water.

The following shows the composition of natural gas from Lago di Naftia, in the Val del Bove, of Etna:

	No. 1.	No. 2.
Carbonic acid.....	94.20	84.58
Sulphuretted hydrogen.....	—	6.17
Nitrogen.....	1.82	2.42
Oxygen.....	0.28	4.52
Loss.....	3.70	2.31

Gas evolved from the fumaroles on the Island of Saint Paul (temperature 78 to 80° F.) shows the following composition:

Carbonic acid.....	14.24	} Absolutely non-combustible.
Oxygen.....	17.01	
Nitrogen.....	68.75	

The presence of free oxygen and nitrogen in this gas, as also the proportions in which they are present, indicates to my mind that these gases are the result of air being drawn in by some unobserved means. A portion of the oxygen so drawn in has united with carbonaceous matter to increase the per cent. of carbonic acid. The natural gas from Campi Flegri, Vesuvius, is found to be mainly carbonic oxide; sometimes as high as 5 per cent. of sulphuretted hydrogen is present. The gas is changeable in its composition, at times containing as high as 50 to 60 per cent. of nitrogen. Nearly all of the gases of the volcanic regions are composed of carbonic acid, carbonic oxide, sulphuretted hydrogen and nitrogen. None possess hydrocarbon compounds in large quantities. This possibly may be the natural result of the free admission of air, and the conversion of hydrocarbons to carbonic oxide, carbonic acid, and water.

The pressure of the natural gas in the ground occasionally reaches a high figure—in some instances, in the wells of Pennsylvania, to that of more than thirty atmospheres. Prof. Peckham says it is even estimated at as high as 2,000 to 4,000 pounds per square inch. This, however, is with the pipes closed. With a free escape the pressure, of course, is greatly reduced. The Committee of Engineers' Report, before referred to, says that in no instance was the pressure found (in respect of the wells examined) to be more than two pounds per square inch with the pipe full open. That report was made a year ago. The Chairman of that Committee now writes me that there are authenticated instances of 25 pounds pressure at some wells. He describes the noise of the gas escaping from the Westinghouse well near Pittsburgh as exceeding that made by fifty locomotives blowing off steam. The temperature of the gases as they escape from the well is usually about 42° to 45° F.

One question of paramount interest is, will these wells continue to flow; and will the supply be equal to that of our subterranean coal stores? Sufficient data have not yet been furnished upon which to even base a good guess. The experience at Fredonia would lead us to expect the supply to

last a long time. On the other hand, the experience in Pennsylvania tends to show that there is a "gradual diminution" of the flow from a well, "tending ultimately to total extinction."

The following historical facts, in regard to wells drilled by Spang, Chalfant & Co., are of interest in this connection:

"No. 1 has been in use nine years, and is still a good well; No. 2, four years in use, still flowing, though with diminished force. Its location is three miles distant from any other gas belt; No. 3, yield insignificant; No. 4, pressure diminished from 1½ pounds to zero in one week; No. 5, failed after four years' use; No. 6, in use six years, gradually failing; No. 7, failed after five years' use; No. 8, good yet; drilled in 1883; No. 9, dry hole; No. 10 was a small well; No. 11, good well. Gas struck within the past few days." These wells are in Butler County, Pa.

It is claimed (why the claim is made I do not know) that the average life of a Pennsylvania well is about 11 years. However, recent investigation presents this question in a more favorable light. It has been discovered that some wells, which had been considered as exhausted, were only obstructed by paraffine deposits, and that when the obstruction was removed the gas again flowed in paying quantities. It is not only possible but altogether probable that many of the abandoned wells may be obstructed with paraffine deposit; also with lime, magnesia, and common salt.

Some interesting experiments were made by the Committee, from whose report I have quoted so freely, in connection with the velocity of the gas and pressure in the pipes. A well giving 3½ oz. pressure, with a free escape, gave 15 lbs. pressure when connected to 16,000 feet of pipe; and it took the gas 4½ minutes to travel the length of the pipe. Gas with 90 lbs. initial pressure occupied 2¼ minutes in traversing 16,000 feet of pipe. Gas from a well having a pressure of 20 oz. had a velocity of 23,400 feet per minute; a rubber ball was driven through three miles of 5½ casing pipe in 2½ minutes. The great variations in velocities here recorded are doubtless due to the different sizes of conductors, and perhaps to angles and bends in the conduits.

The great problem for solution now seems to be, "How can the natural gases be transported economically and safely to consumers?" The most intense excitement has prevailed in and about Pittsburgh at times during the past winter, growing out of the accidents that have occurred through the defective system of transporting natural gases. The escape of the gases, which there possess no odor, caused houses to be blown up and many persons to be injured; in some instances human life was lost. The danger became so great that the matter was taken into court, and an effort made to correct the evil. In the equity proceedings between the "City of Pittsburgh vs. the Fnel Gas Company et al.," the Court appointed a commission of five intelligent persons, skilled in the various branches of science and mechanics, to make a thorough and exhaustive investigation of the questions involved. Occasionally the testimony given before this commission has been made public. The full report is expected to be given to the public soon, and it will doubtless impart to the world much valuable information. The parties giving testimony were experts—engineers, pipe layers, chemists, and mechanics; and the testimony given has been of the most confusing and conflicting character. While there are many questions of detail to be settled by the investigation, there are two questions to be determined that transcend all others. First, how high a pressure can be carried in the pipes without endangering life and property; and, second, to how low a pressure may the gas be reduced without increasing its cost beyond the point where a profit commensurate with the risk of the business can be made on the money invested.

It is now estimated that about 60,000,000 feet of natural gas is being used in Pittsburgh every twenty-four hours. This equals 2,500,000 feet every hour. The consumption, however, will not be regular, and the capacity of the supply pipes must be equal to a maximum delivery of 5,000,000 feet per hour.

The testimony before the commission, so far as it has been made public, indicates that experts are inclined to believe that the old-established practice of companies supplying manufactured gas ought to be taken as the rule, guide, and government of the natural gas companies. Should this rule be accepted, and assuming that the 5,000,000 feet is now being delivered at an average of 40 lbs. pressure, the present capacity of the mains would have to be increased about 16 times in order to supply the desired quantity at the maximum night pressure of the old gas companies, and would need to be increased about 32 times to supply the gas at the average day pressure carried in the pipes of the companies supplying illuminating gas. This would so enormously increase the cost and consequent capital employed as to greatly curtail its use in competition with the cheap and good coal of Pittsburgh. Experience, however, has demonstrated that the best results in combustion are obtained with the consumption of the gas at a pressure that does not exceed 3 oz. per square inch.

One gentleman gave testimony before the court commission, who claims to have submitted a report to the city of Chicago, showing that two parallel

pipes, 7 feet in diameter, would convey gas enough, at an initial pressure of 4 oz. per square inch—from the Murraysville well above Pittsburgh to the city of Chicago, Ills., so that when the gas was sold at only one cent per 1,000 feet it would give a revenue sufficient to pay interest on a capital of \$35,000,000. It was proposed, however, to have intermediate storage points, and, I presume, to use exhausters. The rate of interest not being stated, we cannot accurately calculate the quantity of gas to be delivered; but, assuming the rate to be 4½ per cent. per annum, the daily interest would be more than \$4,000, and to equal this sum 400,000,000 feet must be sold every 24 hours of the year. We cannot imagine how it could take less than one-fourth of a cent per 1,000 feet to send this gas from Pennsylvania to Chicago, distribute it to consumers, do the office work, make collections, and pay the necessary expenses incident to the maintenance of an organization employing a capital of \$35,000,000; and if this estimate is not too high an additional 200,000,000 per day must be sold; or a total of 600,000,000 feet per day must be sent a distance of several hundred miles through two pipes each 7 feet in diameter. To the average gas man the scheme does not present a feasible aspect, neither in its practical working nor in its probable ultimate financial success.

The pipes that have heretofore been laid for transporting natural gas in and about Pittsburgh have not been laid much, if any, below a depth of 3 feet. The past winter was one of unusually low temperature, and the result was constant disturbance of the pipes by frost, with resulting enormous leakage and frightful destruction of property and life. The apparent absolute necessity for a better and safer system for transporting this dangerous vapor set inventors to work, and scores of plans and devices have been suggested; but, unfortunately, so far none of these seem equal to meet all phases of the demand. Some governors of great value have been invented; they control the pressure of the gas, preventing its rising above the desired point in the pipes, and if from any cause the gas flow ceases, causing extinguishment of fires or lights, the gas cannot again pass into the premises without being turned on by hand. This is probably the most useful invention yet brought out in connection with the natural gas question.

To prevent leaking at joints, innumerable plans have been suggested. The wrought pipes have been faced, and the threads made long enough so that the pipes can be butted together in the middle of the socket, practically making a good joint. Another plan was to chamfer the ends of the pipes, and screw them in against a gasket of lead in the center of the socket. Either of these plans would doubtless have given a good joint had the temperature of the pipe always remained the same as when put down; but, owing to the shallow depths at which the conduits were laid, the joints were failures. Screw joints, caulked with copper wire, also failed for the same reason. Had these joints been made with the pipe at about 42° temperature, and the mains buried 7 or 8 feet in the earth, it is my opinion that they would have been practically tight, even at 100 lbs. pressure. Pipe should not be laid in long, straight sections, but should form, when down, a slightly wavy line, to afford room for contraction without destruction of joints. Much of the trouble from leaky joints has been attributed to pressure variation. The register sheets show a constantly varying pressure, the variations generally being slight; but occasionally a drop of 5 lbs. will be noted, followed by a sudden leap to 90 or 100 lbs. per square inch. Now I do not believe that, with screw joints, this change of pressure causes undue leakage. The increased pressure must give an increase of temperature, and that in turn must cause expansion of the pipes, and a consequent tightening of the joints.

It has been suggested that all high pressure pipes should be brought into Pittsburgh overhead, when the leaking gas would be diffused in the atmosphere. That possibly might prevent accident—though I doubt it; and it would greatly add to the quantity of gas lost by leakage, as a result of constant change in temperature. One company has laid some lines of pipe at the usual depth in the ground, then placed a clay pipe along top of this pipe, with an occasional outlet leading to and up through a lamp post, where a light is kept constantly burning—the idea being to cause the gas escaping from the iron supply main to follow along in the clay pipe, and then escape to burner tip in lamp post, there to be consumed. This, of course, does not prevent leakage, but prevents accidents from such escapes. Opinions differ as to whether this plan will prove successful, the weight of opinion seeming to be against it. Another plan, suggested by Col. Roberts, is that of laying the main below frost, then putting a sleeve over each joint of the main; this sleeve to be tapped for, say, a ¾-inch pipe, and this pipe to be attached to a 2-inch pipe running parallel to and lying over the main pipe, the upper pipe being buried just under the street pavement. The gas leaking from the joint would enter the sleeve surrounding it, pass up the small pipe into the 2-inch, which pipe shall have stopcocks or valves between the joints, and by the aid of these valves the leaky joint can be located with but little trouble and little disturbance to the street.

The objects sought to be accomplished are—first, to prevent the escape of gas into cellars; and, second, to be able to locate the leaks with rapidity and certainty, and with the minimum disturbance to the surface of the streets.

Owing to the difference in the composition of the gases, that found in the vicinity of Pittsburgh is much more difficult to transport without leakage than is that of the oil regions. In the first place, its specific gravity is much less; second, there is an absence of the oily residuals, which aid in closing up the small interstices of the pipes and joints. The specific gravity of the Pittsburgh gas is given as 0.557, and that of Bradford as 0.850, air being 1.

Many strange ideas have been given out through the court investigation at Pittsburgh. It is said that chemists differ greatly respecting the characteristics of natural gas. It is possible, however, that some are classed as chemists by the newspapers who do not class themselves as such; and perhaps some style themselves chemists who would not be given that rating by competent judges. One of the claims set forth by a "chemist" was that natural gas has a great affinity for water, and that it seeks low levels in consequence; hence the penetration of gas to the cellars of buildings. One claims the absence of salt water, and another finds it in abundance. One says the gas has a strong odor, and another says it has no odor. To my mind the gas may or may not carry a strong odor, depending, first, upon the locality from which it comes; and, second, the distance and velocity of travel. If the gas is permitted to become motionless, it will doubtless drop the salt water and the solid particles or condensable vapors that impart odor to the gas from some wells.

The uses to which natural gas can be put are numerous. It can be used for any purpose for which coal is or can be used, with perhaps the exception of smelting iron ores; and it fails in this respect through no inherent defect, but for want of proper apparatus. It is used for puddling and heating iron, melting steel, raising steam, for melting crude material in glass works and for annealing glass, for domestic heating and cooking, and in lighting residences, offices, and factories. For the latter purpose it is not well adapted, especially when the gas does not flow from the vicinity of oil pools. It is said that a light of 24 candles may be obtained from the gas at Bradford, Pa., by the use of Argand burners; but not more than 8 or ten candles can be obtained by the use of open burners. This looks much as though the intensity of light depended upon the intensity of temperature. I have before suggested that an admixture of water gas, CO, and H would probably add to the illuminating power of natural gas, especially when consumed in an open burner. The Bradford gas contains a large percentage of heavy hydrocarbons; gases in other sections contain but little.

In a series of practical experiments made at Pittsburgh it was found that one pound of the natural gas (23.5 feet) would evaporate 20.31 pounds of water; or, in practice, it gave 83.40 per cent. of its theoretical value. On the other hand, the best Youghiogheny coal, under the same boiler, and with similar conditions, evaporated nine pounds of water, giving only 60.90 per cent. of its theoretical value. The result shows that 1,000 feet of natural gas will do about 25 per cent more work, in practice, than one bushel of the best Youghiogheny coal. If there were no other advantages, such as perfect control of temperature, absence of ashes and clinker, saving of stokers' wages, cost of hauling coal, etc., gas would have to be sold at a very low figure to compete with coal. The price now charged in Pittsburgh varies from 12 to 20 cents per 1,000 feet. One concern in Pittsburgh more than one year ago was paying \$8,000 per month for gas. The natural gas interest is yet in its infancy, and I predict for it rapid growth in the near future.

To the listeners who have followed me through this long and disconnected dissertation I can offer a little comfort and possible compensation by informing them of the fact that, barring accidents, Dr. Edward Orton will issue another (or supplemental) volume of economic geology during this year, in which this question will be given a very prominent place. His volume will be the latest, and unquestionably the best, publication on the subject of natural gas.

[To be continued.]

[CERTIFIED COPY.]

Text of the Bill Creating a Board of Gas Commissioners for the State of Massachusetts.

[The following are the terms of the Act creating a Board of Gas Commissioners for the State of Massachusetts. The measure was approved on June 11, 1885; and the Governor, on July 16 last, appointed the gentlemen who are to serve on the Board. For the names of the Commissioners see JOURNAL, date of August 3, p. 69, second column.]

COMMONWEALTH OF MASSACHUSETTS.

In the year One Thousand Eight Hundred and Eighty-five.

An Act to Establish a Board of Gas Commissioners.

Be it enacted by the Senate and House of Representatives in General Court assembled, and by the authority of the same, as follows:

SECTION 1. The governor, by and with the consent of the council, shall appoint three citizens of this Commonwealth, who shall constitute a board of gas commissioners, and the governor shall designate the chairman thereof.

Said board shall have a clerk, to be appointed by the governor, with the consent of the council, who shall keep a full and faithful record of its proceedings, and shall serve such notices and perform such other duties as the commissioners may require, and shall be sworn before entering upon the discharge of his duties.

SECT. 2. One of said commissioners shall be appointed for one year, one for two years, and one for three years from the first day of July, eighteen hundred and eighty-five; and annually thereafter the governor shall appoint, as hereinbefore provided, one commissioner to serve for three years from the first day of July in the year of his appointment and until his successor is appointed and qualified. If a vacancy occurs, by resignation or otherwise, the governor shall in like manner appoint a commissioner for the residue of the term, and may, with the consent of the council, remove any commissioner for cause, after notice and hearing.

SECT. 3. Said commissioners shall be sworn to the faithful performance of the duties of their respective offices before entering upon the discharge of the same; shall not be in the employ of or own any stock in any gas company, or be in any way, directly or indirectly, interested pecuniarily in the manufacture or sale of gas, or any article or commodity used by gas companies, or used for any purpose connected with the manufacture or sale of gas.

SECT. 4. The annual salary of the chairman of the board shall be three thousand dollars, and that of the other commissioners two thousand five hundred dollars each, to be paid monthly from the treasury of the Commonwealth. The commissioners shall be provided with an office in the state house, or in some other suitable place in the city of Boston, in which their records shall be kept.

SECT. 5. The board may expend a sum not exceeding one thousand dollars annually in procuring necessary books, statistics, and stationery, and in defraying expenses incidental and necessary to the discharge of their duties; and a sum not exceeding two thousand dollars annually, in defraying the compensation and expenses of their clerk, payable monthly from the treasury of the Commonwealth.

SECT. 6. The annual expenses of the commissioners and clerk, including salaries, shall be borne by the several gas companies in proportion to their gross earnings, and shall be assessed and recovered in the manner provided for the assessment and recovery of the expenses of the railroad commissioners.

SECT. 7. Every gas company shall annually make a return to said board in a form and at a time prescribed by said board, setting forth the amount of its authorized capital, its indebtedness and financial condition on the first day of January preceding, and a statement of its income and expenses during the preceding year, together with its dividends paid or declared, and a list containing the names of all its salaried officers, and the amount of annual salary paid to each; and said return shall be signed and sworn to by the president and treasurer of said company and a majority of its directors. Every such company shall also, at all times, on request, furnish any statement of information required by the board concerning the condition, management, and operations of the company, and shall comply with all lawful orders of said board.

SECT. 8. Said board shall have the general supervision of all corporations engaged in the manufacture and sale of gas for lighting and for fuel, and shall make all necessary examinations and inquiries, and keep themselves informed as to the compliance of the several corporations with the provisions of law.

SECT. 9. Upon the complaint, in writing, of the mayor of a city, or the selectmen of a town in which a gas company is located, or of twenty customers of such company, either of the quality or price of the gas sold and delivered by such company, the board shall notify the company of such complaint by leaving at their office a copy thereof, and shall thereupon, after notice, give a public hearing to such petitioner and such company, and after said hearing may order, if they deem just and proper, any reduction in the price of gas or improvement in quality thereof, and they shall pass such orders and take such action as are necessary therefor, and a report of the proceedings and the result thereof shall be included in their annual report to the legislature.

SECT. 10. In any city or town in which a gas company exists in active operation, no other gas company, nor any other persons, shall dig up and open the streets, lanes, and highways of such city or town, for the purpose of laying gas pipes therein, without the consent of the mayor and aldermen or selectmen of such city or town, after a public hearing before said mayor and aldermen or selectmen and notice to all parties interested, by publication or otherwise.

SECT. 11. The board shall, from time to time, ascertain with what degree of purity the gas companies can reasonably be required to make and supply gas; and if any change in the existing laws requiring purity in gas shall be, in their opinion, desirable or expedient, they shall so report to the legislature in their next report.

SECT. 12. The board, whenever any such company violates or neglects in any respect to comply with the provisions of any law, or refuses or neglects to comply with any lawful order of the board, shall give notice thereof, in writing, to such corporation and to the attorney-general, who shall take such proceedings thereon as he may deem expedient.

SECT. 13. Any court having jurisdiction in equity, in term time or vacation, may, on the application of said board, by any suitable process or decree in equity, enforce the provisions of this act and the lawful orders of said board.

SECT. 14. The board shall make an annual report of its doings to the legislature in January, with such suggestions as to the condition of affairs or conduct of the gas companies as may be deemed appropriate.

SECT. 15. Nothing in this act shall affect the office of gas inspector as constituted by chapter sixty-one of the Public Statutes, excepting that said inspector shall, whenever requested by the board, give to them such information and assistance as they may require, consistent with the duties of his office.

SECT. 16. Any gas company which, or any person who, is aggrieved by the decision of the mayor and aldermen or selectmen of a city or town under the provisions of the tenth section of this act may appeal therefrom to said board within thirty days from the notice of said decision, and said board shall thereupon give due notice and hear all the parties in interest, and its decision thereupon shall be final.

SECT. 17. This act shall take effect upon its passage.

Results of a Trial with the "Chamberlain Gas."

By FREDERIC EGNER.

An article entitled, "The Chamberlain Gas Process," by Mr. Wm. Farmer, appeared in the AMERICAN GAS LIGHT JOURNAL, date of April 2d, 1884, the closing sentence of which was the following: "Gentlemen, is this to be the gas of the future, or not?" If anyone ever had any doubt about that matter, and which is not yet settled, the following may possibly serve as a solution of the conundrum propounded by Mr. Farmer.

In January of this year certain parties called at the office of the Laeledge (St. Louis, Mo.) works—of which plant the writer has the honor to be Superintendent and Engineer—with the purpose of explaining all about a patented method of making gas. Slight conversation led to the discovery that the visitors were interested in what is known as the Chamberlain process. They claimed to have obtained astonishing results, or similar to those described in the issue of the JOURNAL mentioned above. When expostulated with because of the absurdity of the operation of that so-called process or scheme, they brought out the hackneyed story of Columbus and the egg, with more "evidence" of an equally trustworthy sort. They asserted that "Col." Chamberlain really had made a great chemical discovery, and clinched the whole argument by maintaining that they had—as a result of practical operation—positively proved all they claimed the process would accomplish. They only asked leave, *at their own expense*, to demonstrate these facts to us. It was evident these particular promoters of that process were thoroughly honest in their belief; and as they neither were nor claimed to be gas men, but only "thoroughly posted" as to that single process, it seems quite likely they themselves were deceived by that clever old gentleman, "Col." Chamberlain; judging so, at least, by the sequel, since this proved that out of the statements made by them, the "Col.," or contained in the article first referred to, none could be made good.

While our negotiations with these people were in progress it transpired that they were making efforts to obtain a footing in this city with some of the leading business houses, and they openly claimed to be doing the same thing in New York. So, bringing all things into consideration, it was thought best to let them demonstrate their claims—as they asked—at their own expense. They caused a 5,000 cubic feet gas holder to be built; bought a station meter and scrubber, and brought the rest of the apparatus on from the East; had it all set up in a place assigned them, and commenced operations. Their claim was, as may be seen by referring to the article mentioned before as having appeared in the JOURNAL, that with 10 gallons of refined petroleum, $2\frac{1}{2}$ gallons of water, with the necessary quantity of air, raised to a high temperature, 3,000 cubic feet of 18 to 20-candle power gas could be made and relied upon. Two bushels of coke was the quantity said to be required for fuel per 3,000 cubic feet of gas. A most valuable residual was to be secured. The residual was asserted to be worth, by the barrel, 75 cents per gallon, and it would make its appearance in the ratio of one-half gallon residual to each ten gallons of oil distilled. The process is covered by U. S. Letters Patent, Nos. 278,093, and 286,589.

A brief description of the apparatus may be interesting at this time. A cast iron retort, flat, about 4 feet six inches long, 26 inches wide, and 6 inches deep, was set into a furnace. Oil and water were run into the retort at one end, and the gas was taken off at the opposite end. When a certain quan-

tity of gas was thus made *air was pumped through the red-hot retort*. The gas passed from the retort through a water seal or washer, meter, and into the holder. A more utterly silly operation for gas making could scarcely be conceived; yet so convinced were the promoters of this folly that their patentee had really succeeded in changing one of the very fundamental laws of chemistry, that they looked on anyone who would try to undeceive them either in the light of an ignoramus or a foe. In order, however, to give the matter a fair trial, the "Chamberlain Gas" was brought through a special pipe directly into our photometer room. In another room a dozen jets were connected to a meter and left burning day and night for over 1,400 consecutive hours. The gas, which for the first 18 hours seemed to badly gum up the burners, did not do it after the expiration of that period, nor did it even show a sign of it again. The gas was brought to the burners in a very roundabout way, and showed no condensation nor sign of stratification whatever. The gas was slightly heavier than air, and the waving of an open hand near to a burner would extinguish the flame. It could not be tested with the London Argand, and a very wide slit, lava tip, flat flame burner was used at first; afterwards an Argand—especially made for that kind of poor gas—was obtained from the local water gas company and installed as a test burner. It was found that when 1,000 cubic feet of gas was made, using $3\frac{1}{2}$ gallons of refined petroleum, the illuminating value would be all the way from 7 to 10 candles. 150° oil, 112 (fire-test) oil, gas naphtha, and intermediate distillate, all were tried. The oil gas (with water and without water) was made, then air pumped in, as the "Col." directed. The gas and air went through together. The air was put in cold, and then hot; and in fact in all the intervening stages all the possible changes that could be rung in were made. The same man (and a very ingenious old, gentlemanly mechanic he is) who made gas for the "Col." in New York conducted the experiments here. But it was all to no purpose. They never could make 3,000 cubic feet of gas at one time, nor in one day, although the apparatus was far more than double the size of the New York apparatus, and was warranted to make 10,000 cubic feet per 24 hours—before it was tried. As stated, every conceivable change in operating the "apparatus" was made; nor was the regulation quantity of oil adhered to. The thing was tried with three, and any quantity of gallons of oil more, per thousand; but the results were not satisfactory. The residual product turned out to be a nasty, stinking, fatty liquid, of no value whatever. As might be expected, the retort and pipes leading from it were often filled with lampblack.

In the course of the experiment the ingenious mechanic before referred to developed out of this "Chamberlain Gas Apparatus" an entirely different one, with which he obtained some really good results—*i. e.*, compared with the parent process; but enough has been shown now, at least in the opinion of the writer, to fully warrant the statement, "No, gentlemen; the 'Chamberlain Gas' is not to be the gas of the future." Not much.

Regulation of Pressure in Elevated Districts.

[A paper read by Mr. Robt. Mitchell, of Edinburgh, Scotland, before the North British Association of Gas Managers. Paper and discussion reprinted from columns of *Gas and Water*.]

In accepting the invitation of your President to make a few remarks on the subject of "the regulation of pressure in street mains (especially in elevated districts), and the duty of gas companies and corporations to their consumers in this respect," I did so, not because I had any misgivings as to the manner in which gas managers attended to this branch of their duties in their respective towns, but with the desire that we might, by the free interchange of opinion, arrive at a moderately clear understanding as to what gas consumers in the more elevated portions of our districts have a right to expect from the gas companies and corporations.

From the varied positions of gas works, and the variations in the levels of the area to be supplied, no fixed rule can be laid down for any two works as to the initial pressure to be recognized at the station governor. Every manager must be guided by the circumstances in which he is placed and these alone. In the distribution of gas it is of the utmost importance, and demands our most careful attention and consideration, that all gas mains, cross connections, and the whole ramification of service pipes are of ample size and in perfect order, so that a sufficient supply may be given to the district without excessive initial pressure, alike in the interest of gas company or corporation, and the consumer. In towns where the alterations of levels occur (as in some cases they do) in stages or terraces, the only system of distribution which would be thoroughly successful and scientifically correct, would be to divide the town into zones. In order to do this it should be so arranged to have a trunk main through the one end of the town, or the center of it (whichever was most convenient), and the supply for these stages or terraces taken off at right angles to the trunk main, with the pressure controlled by differential governors. It is not always expedient, yet in some cases it is so, to have a separate main from the distributing station direct to the district

where the pressure is required to be greater or less than that on the larger portion of the town. Circumstances might necessitate special arrangements to be made to meet all the requirements; yet, where it can be applied, I am of the opinion that the trunk-main system would prove the only satisfactory method of distribution in districts where the variations of level were great. Where the supply is controlled by station governors alone, if the governors are correctly constructed, the area will be properly supplied, provided that there are but slight variations of level. Should variations occur of, say, from 40 to 50 feet, an alteration in the means of controlling the pressure should be adopted.

It is a well-known and recognized fact that where an increase or diminution in level to the extent of 10 feet occurs, an increase or diminution of pressure to the extent of one-tenth of an inch takes place, hence the desirability of this branch of our business receiving our careful consideration.

In laying out a new district you will make an approximation of the quantity of gas the district will require per hour at the heaviest season of the year, in setting out on the calculations necessary as to what size of pipe you will require to discharge the quantity at an initial pressure of not more than twenty-fifths, thus allowing what may be presumed a fair margin for increasing consumption in the locality. I will not trouble you by going into the formula by which any quantity of gas of varying specific gravities may be passed through pipes of various sizes and lengths. You are, no doubt, well acquainted with the elaborate tables compiled by the late Mr. T. G. Barlow, and which have recently been extended by Mr. Thomas Newbigging. To these tables I cannot do better than refer you. In them you will find much of interest, and I may add that a close acquaintance with them will enable you to treat in a thorough and practical manner whatever comes before you in this department of your work. One most important point is that the specific gravity to which these tables have been calculated is so very different from the specific gravity of the gas in Scotland (with few exceptions), that to arrive at the actual quantity of gas that would be discharged in every case, a correction requires to be made. The increased specific gravity being so great, a very greatly reduced quantity of gas per hour is discharged.

As an illustration of this I will revert to a statement made with reference to the introduction of 20-candle gas as a standard for Scotch gas, *viz.*, "the reduced specific gravity of 20-candle gas compared with 28-candle gas would allow the district to be supplied by existing mains as well as they are at present." If I take a 10-inch pipe, supplying a gas of .400 specific gravity, I find at 1,000 yards from where the initial pressure of 1.5 inches is applied, the discharge will be 26,055 cubic feet. The same pipe, under similar conditions, supplying a gas of .530 specific gravity (which may be taken as a fair specific gravity for 20-candle gas) will discharge 22,636 cubic feet. We again take the same pipe and like conditions, and supply a gas of from 28 to 30-candle power, having an average specific gravity of .670 (which may be taken as representing the gas supplied by the great majority of Scotch gas companies and corporations). The quantity will be reduced from 26,055 cubic feet in the first instance to 20,134 cubic feet, or from 22,636 cubic feet of 20-candle gas to 20,134 cubic feet of 28-candle gas. As our first duty to our consumers is to supply light, you will pardon me if I reduce these last two quantities to sperm value, and give the exact difference in the quantity of light conveyed to the consumer. Thus you have—

$$20.134 \div 5 \times 120 \times 28 \div 7,000 = 1,932.8 \text{ lbs.}$$

$$22.636 \div 5 \times 120 \div 28 \div 7,000 = 1,552.1 \text{ lbs.}$$

$$380.7 \text{ lbs.}$$

You will observe there is a deficit in illuminating power equal to 380.7 pounds of sperm. We would therefore require to have a delivery of 28,200 cubic feet of 20-candle gas to give an equal quantity of light as would be discharged by supplying 20,134 cubic feet of 28-candle gas. While making this reference I hope you do not mistake me. I have a great desire that a recognized standard should be adopted in Scotland, whatever that standard may be. Should it be agreed upon to introduce a uniform quality—say, 20-candle gas—then gas companies and corporations whose distributing plant is only equal to their present requirements, without much of a margin, must face the necessary cost of enlarging their mains and a considerable portion of the old service pipes, as well as their manufacturing plant, and those unfortunate consumers who have Wheatstraw fittings, will be compelled to have them enlarged, or content themselves with a proportionately small quantity of light. It may be said that this is a little outside of my subject, yet, if you have to force so much more inferior gas through existing mains, it simply comes to be a matter of pressure. Then the old rule that the discharge of gas from any main will be doubled by the application of four times the pressure must in part come into play. This mode of increasing the quantity of gas required to be passed to compensate for the reduced illuminating power I do not consider expedient, as it must be the experience of everyone here that, at low or medium pressures, we have least leakage and obtain the best photogenic results.

Having all main pipes, cross connections, and service pipes of sufficient size, the controlling of the pressure necessary to meet the requirements then commands your careful attention. Having decided upon what you may call the maximum or sunset pressure, it is not consistent with common reason that this pressure should be maintained throughout the entire evening as, I am sorry to say, it too frequently is the case in our smaller towns. I hold that to have one-tenth of an inch more pressure on your street mains than is actually necessary to meet the requirements of your consumers, is wasteful and wrong. Further, having once fixed the initial maximum pressure at which the various districts are to be supplied—and this should be done at least twelve times in a year, according to the seasons—the mode of increasing the pressure ought to be very gradual from the day pressure to the maximum of sunset pressure; the high pressure ought only to remain on until the heaviest hours of lighting are past, say, from 7:45 to 8 o'clock, according to the circumstances, when a reduction of two-tenths of an inch is made, and this operation is continued every half hour until 11:30; and at midnight the whole of the pressure ought to be reduced to as low as is safe. Were this care in the adjustment of pressures more generally adopted by gas managers the days of 15 to 30 per cent. of leakage would then become matters of history, and the consumers would not have to submit to excessive pressures, which in too many cases mean gas wasted, hence high gas bills. The last question is—what is the duty of gas companies or corporations to their consumers living in the more elevated parts of their districts who are subjected to excessive pressures? I hold it to be the duty of every gas company or corporation, whether by the system of zones, or by the use of differential governors, to use whatever means are best adapted to regulate the pressure on the whole elevated area, or in each individual case as may be considered most advantageous to the consumer. It ought to be that every gas engineer or manager should take for himself a higher platform than that of being merely a manufacturer of gas. His duty is, and his interest ought to be, in supplying his consumers with light in the very best possible manner. I would not for one moment entertain the idea that only a very small minority of gas managers are actuated merely by the desire to sell gas independent of its quality, and also independent of the comfort or satisfaction of the party supplied; yet we do find, now and then, the consumers receiving but very moderate consideration. I have long held the opinion, and as my experience increases I see more and more the advisability and the desirability of gas companies and corporations in their own interest, as well as in that of their consumers, taking the complete supervision of the internal fittings, in addition to that of their own street mains. Why should this not be so? I see no reason why gas companies and corporations should not have the power that water companies in a few of the large towns have, where all fittings must be of a given size and strength in conformity to a standard scale, and the whole work examined and passed by a qualified official before any water is allowed to pass through these pipes.

If this system of examination was exercised by gas companies and corporations (which I consider it is their duty to do), a very great amount of the inconvenience, loss, and annoyance to the consumers would be averted, not to mention the numerous and harassing complaints to the gas manager about inferior light supplied—the gas in many instances being condemned as bad when the whole cause of complaint, after it has been inquired into, has been found to result from inadequate or imperfect fittings, and, it may be, inferior workmanship.

Discussion.

Mr. Peebles said he had given some attention to governors, and he thought the division of the city into zones very commendable, for they had then the control over a certain limit of pressure and an easily got at system for controlling the particular zone. The differential governor, by the extended rises of gas, would not be of such use as they had been, as they responded only at the gas works. He thought the time had come when constant pressure governors would be a necessity. He had lately given his attention to that, and hoped to bring his invention before them next year, if not sooner. The governor he had in progress was a station governor, and by a small hand pump they could take up the load or reload it. There was now a great necessity for improvement in the day pressure, with the gas engines and cooking stoves now so widely introduced.

Mr. Burden (Musselburgh) said he had to put the pressure sometimes from two-tenths up to one and five-tenths, when there was a complaint of insufficient supply for gas stoves; but the real reason for complaint was the bad fittings. He held that before pipes were put into a house the gas manager should be consulted.

Mr. Somerville (London) said he knew a gas engineer who was in the happy condition of keeping up 25 tenths day and night, as so many gas apparatus had been introduced that they required just as much in the daytime as at night.

Mr. Key thought Mr. Mitchell had taken a very wise step in bringing this before the meeting, as the subject of street mains should be familiar to every student of gas manufacture, and they should know that meters registered

better under a low than under a high pressure. He thought those who had to supply the gas should have power to see that the consumers' houses were properly fitted up.

Mr. Anderson (Dysart) did not see how, where they had a district supplied over a trunk main, they could regulate it without a governor at each branch.

Mr. M'Gilchrist did not see how, in a district like Edinburgh, where there was a difference of upward of 300 feet in the levels, they could ever successfully compete with the pressures by station governors. Supposing the pressure was an inch at the gas works, at the top of the castle it would be more than four inches; that being altogether out of the power of a station governor to regulate. With regard to the consumers' fittings, he had taken a very great interest in that subject, and for the last eight years the Corporation of Dumbarton had issued a standard of sizes which they supplied to all contractors and builders. The Dean of Guild Court took special note of the matter, and he had known them compel the removal of the pipes where they were contrary to the standard. By this system they had been able to reduce the pressure considerably.

Mr. Key—Is there a clause in the Dumbarton Gas Act to enforce this regulation?

The Chairman—You hear the question?

Mr. M'Gilchrist—I hear the question; and Mr. Key knows it as well as I do.

The Chairman—You are answered, Mr. Key.

Mr. Mitchell, in briefly replying, remarked that it had been said this was an old story; but it was one which could not be too well impressed.

The Chairman said the paper presented to him many points of interest, particularly as the lighting in Dundee was carried on in much the same way as had been pointed out by Mr. Mitchell. In the higher parts they had a high-level main, and even with three tenths of pressure at the gas works, at the summit it was found from twenty-seven to thirty tenths; and they found they could supply them without any pressure at all, so great was the vacuum. Before the introduction of governors their waste had been as high as 24 per cent.; now he was happy to say it was only 10.5. A model of Cowan's automatic apparatus for registering and regulating the pressure exhibited in the hall was pointed to by the President, who, in conclusion, tendered a vote of thanks to Mr. Mitchell for his paper.

ITEMS OF INTEREST FROM VARIOUS LOCALITIES.

INCREASING ITS CAPITAL STOCK.—On the morning of Wednesday, August 5th, a directors' meeting of the New York Equitable Gas Light Company was held, the especial object of same being to determine whether a 50 per cent. increase should be made to the capital stock of the corporation. It is understood that the directors present at the meeting represented an ownership of 17,000 out of the total of 20,000 shares of stock in the company, and they were unanimous in advocating the proposed capital increase. The reason assigned for the action is that the funds were required for plant extensions, which necessitated the purchase of some valuable real estate. The property either acquired or to be acquired consists of two plots located on both extremes of the city's water boundaries—the first embracing a block lying between 41st and 42d streets and East river; the second parcel fronts on the North river, and is bounded by 58th and 59th streets. It is understood that holders of record have the option of taking up the new stock (in due proportion) at par, and this comfortable arrangement easily explains why the Equitable manipulators had so little difficulty in "boosting" the price of their shares up to the outrageously high figure of 140 or thereabout. When this security sells "ex-option," we venture to predict that the "boosters" will have some trouble in causing it to reach the '40 notch once more. Of course the 50 per cent. increase in the capital means that three millions of dollars now represents the company's total stock issue. We must say, however, the real estate secured is most valuable property, and its selection reflects great credit on the sagacity of the purchasing agent or agents who made the choice.

BUT THIS WOULD NOT SEEM VERY SAGACIOUS.—While we admit the sagacity of the gentlemen who negotiated for the New York city property mentioned in connection with the above item, we hold to the view that the "agent" or "adviser" who suggested to the managers of the Equitable Company that glory and money were to be made as a consequence of building an opposition gas works in Chicago, Ills., was woefully far from the mark. With the Consumers Company in charge of a receiver, and with Messrs. Forstall and Watkins selling a 20-candle gas at the figure of a dollar a thousand—and perfectly satisfied with the price, too—it would seem to a disinterested spectator, possessed of even slight knowledge of the gas business, that there was hardly "room" enough for an attempt by a third party to figure in the Lake City as the "champion of the oppressed gas consumer." Still, variety of opinion gives spice to living; and it also may be said that when the "living" is ended the "spice" can be turned to account as an aro-

matic souvenir of the dead—to say nothing at all about the fragrant memories sure to survive in the recollection of those who were “let in on the ground floor” in the item of stocks, bonds, etc. At any rate, it is on the cards that the Chicago council, by a vote of 30 to 4, granted the Equitable promoters the right to lay mains, etc., through the streets of the city. That of itself, however, may mean much or little.

THE MONKEY AND THE PARROT.—The Jersey City (N. J.) philanthropists—as represented by the United Gas Improvement Company on the one hand and Mr. Addicks on the other—have opened up hostilities. The Consumers Company commenced supplying gas some short while ago, and the Jersey City folks are reported to be now obtaining their gas supply at \$1.25 per thousand. Those financially interested in the gas companies of Massachusetts might find it worth their while to make note of the Jersey City imbroglio.

ONE OR TWO CORRECTIONS.—In an “item” that appeared in the columns of the JOURNAL for July 16, and entitled “Certain Rumors Taking Tangible Shape,” was conveyed the information that a controlling interest in the capital stock of the South Boston (Mass.) Gas Light Company had been secured by parties supposed to be interested in the Boston opposition gas scheme sailing under the name of the Consumers Company. Substantially the item was correct, the only inaccuracies in regard thereto being the following: The price paid for the shares was 110 dividend on, instead of 110 dividend off; or, the accrued dividend of 3 per cent. did not go to former owners. We have it on the best of authority that no meeting of the directors was held to consider the question; consequently “no vote was passed to sell the stock.” If that was the case—and we are inclined to positively assert that such is the fact—the gentlemen interested in obtaining stockholders’ assents to the scheme must have done some beautifully persuasive talking. In the meantime both Lowe and Addicks are “running loose” over Massachusetts in the attempt to persuade the stockholders of the Massachusetts gas companies that the latter should give their property away to either one of the former. The Messrs. Greenough, of Boston, J. C. Pratt, of Jamaica Plain; Pease, of East Boston; Dr. Estes Howe, of Cambridge; W. E. Fette, of Marblehead; W. Tarbell, of Waltham; and, in fact, numbers of other gentlemen who for years past have conducted the affairs of their companies on a thoroughly sound, honest and business-like basis, are not likely now to relinquish the fruits of their labors simply that the palates of the Standard Oil Company marauders may be tickled thereby. They got nettles in Chicago; and we hope that Massachusetts will afford them a mess of thistles. In the meantime do not forget that while Gibbs and Addicks are “running loose” in the Bay State, they are “running amuck” in New Jersey.

PERSONAL.—Mr. W. Elliot Fette, of Boston, Mass., has but recently returned from a trip across the ocean. While in England Messrs. Fette and M. S. Greenough (who also made a flying European trip) attended the sessions of the Twenty-second Annual General Meeting of the Gas Institute, and were greatly pleased at the reception accorded them.

THEY MIGHT CONSOLIDATE.—On the 26th day of May last a certain number of Brockton (Mass.) speculators obtained permission from the Brockton Board of Aldermen to maintain and operate a gas works in that city. The capital stock was fixed at \$50,000, and the management of the enterprise was entrusted to a board of five trustees. A certain personage named J. J. Whipple (he prefixes his cognomen with the title of “Colonel”) occupies the position of President. During the progress of the “moons” “Col.” Whipple and his “Trustees” gave no sign of activity; but recently the “Col.” has emerged from the shade of obscurity, and the “emerge” is traced to the fact that, like a true old war horse, he sniffed at the breezes springing from the Gibbs and Addicks gas war—and thought he “smelled a bone.” Did not the “Col.” have a charter? and the old Brockton Gas Company did not want it. Perhaps we misjudge him; but we base our opinion on the following, extracted from the Boston Journal, date of July 20th: “Col. Whipple said that while people had been of the opinion that the Economic Company”—for such is the name of the “Col.’s” corporation—“was sleeping, it would soon be shown that it was wide awake.” Colonel Whipple was rather reticent on the subject, but admitted that it was not improbable his company, which as yet possesses neither plant nor works, might consolidate with one of the Philadelphia companies for the purpose of opposition. Of course, “Col.,” why not? It would not cost you very much.

THE NEW SUPERINTENDENT.—The place made vacant in consequence of the murder of Mr. Geo. S. Dunbar, former Superintendent of the Pittsfield (Mass.) Coal Gas Company, has been filled by the appointment of Mr. Jno. F. Dunbar. The new incumbent bore the relation of brother to deceased, and was formerly in charge of the plant known as the Union Gas Works, of Pittsfield, the function of the latter being to furnish gas to several large mills located in the northerly portion of the city. We regret to say that the

slayers of Mr. Geo. S. Dunbar remain undiscovered. Mr. W. R. Plunkett, Secretary and Treasurer of the Pittsfield Company, will accept our thanks for the information furnished us.

THE PINTSCH SYSTEM.—The Pintsch system of illumination is surely and steadily gaining ground and favor. From a foreign source we learn that four more buoys on the Pintsch principle have been shipped to the Suez Canal to be there employed as beacons. This last shipment brings the total number in use on that canal up to 12. The first sample of a new pattern of gas beacon has just been placed in the Clyde on the Gantoch Rocks. This beacou shows two red lights, and will perform its duty over a period of five weeks with one charging of gas. Up to a recent date the following numbers of railway carriages and engines were illuminated by this system in the sections specified: Germany, 13,475; England, 2,926; other districts in Europe and America, 3,923, or a total of 20,324.

CARBOLCRYSTAL.—Mr. Wm. H. Childs, of 73 Maiden Lane, N. Y. city, is a gentleman who is recognized as one of the best authorities, in the matter of working up the products from the coal tar of gas works, in this country. He has recently succeeded in developing an excellent disinfecting material, to which he has given the name carbolcrystal. It is neither poisonous nor corrosive, and experts assert that it is eminently well adapted to take the place of carbolic acid in household use. It is put up in three distinct shapes—liquid, powder and solid.

NOTE.—The Flatbush (L. I.) Gas Light Company’s main system has been overhauled. Several improvements have also been instituted in and about the works proper. It is a well-kept establishment.

NEW ZEALAND LIGNITE.—Mr. D. A. Graham, Engineer to the Dunedin (New Zealand) Corporation Gas Works, contributed the following interesting particulars to a recent issue of the London Journal: “In the neighborhood of Dunedin there are large lignite coal fields. I have tested samples from one of the principal mines (Kiatangata) and various other lignites, and find their composition to be as follows:

Yield of gas.....	13,000 cubic feet.
Illuminating power.....	8 candles.
Water in coal.....	620 pounds.
Tar produced.....	51 “
Ash.....	5 per cent.

“In Dunedin, Kiatangata lignite is used to prevent the ascension pipes stopping, which, I am informed, it does very effectually. If the gas it produced were tested, I imagine it would be found principally of marsh gas and hydrogen. I was induced to give it a trial on a commercial scale, with very peculiar results. The whole of the condensing apparatus became so hot within two hours after the trial commenced that I could not bear my hands on the condenser. The charges were burnt out in less than three hours. The purifiers became hot and fouled; and, as a consequence, when 18-candle gas was reduced to 13, in three hours’ working, I had to abandon its use. It will be seen that the quantity of water present in the lignite is enormous. I have not renewed my experiments on a large scale, nor am I desirous of doing so; and I cannot state to what this abnormally high temperature was due. The facts were as I have stated them; and it is also the case that lignite cleans out and keeps clean stopped ascension pipes.”

THE TROY (N. Y.) HEATING GAS SCHEME.—On the afternoon of August 4 the directors of the Troy heating gas company (the concern which is understood to have succeeded to the property of the defunct Troy steam heating company) held a meeting for the purpose of organization. C. McVeagh, of New York city, was elected President; C. McCarthy, Vice-President; and G. Geer, Secretary; the two last named are residents of Troy. By resolution it was determined to purchase a plot of land (325 by 138 feet) on Douw street, at a cost of \$7,500; and it was further agreed that the erection of a gas plant on the selected site be immediately proceeded with. A holder, 50 feet diameter, will be put up at once, it being the intention of the proprietors to construct one of double that capacity “later on.” [We presume the “later on” means when the business of the company will justify the proceeding—a very indefinite outlook, that.] The main conduit, from works to old steam heating mains, will be 12 inches in diameter, and the initial main service of the company will be about six miles in length. It is expected that the company will be ready to send out gas for heating purposes in sixty days from time of starting in on erection of the buildings. The second meeting of the directors was to be held in New York city on August 15, and a Superintendent was then to be chosen. The cost of the projected work is placed at \$75,000.

WHAT THE MANSFIELD (OHIO) GAS MEN ARE DOING.—When the Northwestern Electric Lighting Company, of Chicago, Ills., announced its intention of instituting a branch plant at Mansfield, Ohio, Mr. George S. Harris,

Superintendent of the Mansfield Gas Light Company, did not show any marked symptoms of perturbation; and, in fact, rather welcomed the appearance of the enemy, since the advent of the newcomer would but serve to prove to the people of Mansfield what a good and cheap article of gas was really worth when compared with its would-be rival, electricity. Supt. Harris appears to have estimated rightly, for since the electrical promoters commenced supplying the "light of the future" the output of the gas company has been greatly increased. In fact the demand for gas has grown to such proportions as to make necessary an extensive system of additions to the old works, and these enlargements are now in vigorous progress. The new construction includes a brick retort house, 35 by 60 feet, with trussed roof and all modern improvements; a new holder, with a calculated capacity of 70,000 cubic feet; and new purifying apparatus. The per diem working capacity of the old plant was but 65,000 cubic feet, while the new apparatus will place the company in position to supply a daily send out of 150,000 cubic feet. Hancock & Dow, of Mansfield, are the contractors for the erection of the brickwork on retort house, as also for tank construction; Messrs. Wm. Gardner & Son, of Pittsburgh, Pa., having secured the award for all ironwork and supplies. The Mansfield gas folks are quite satisfied with the illuminating product afforded by Youghiogheny coal, and have resisted the cajolings and threats of the water gas marauders. Their consumers are satisfied, while the stockholders have nothing to grumble over. The following are the gentlemen who manage the affairs of the Mansfield corporation: Jno. B. Netcher, President; Leroy Parsons, Secretary; Geo. S. Harris, Superintendent; and Messrs. Jas. Gardner, of Cumberland, Md.; Jno. McIlhenny, of Philadelphia, Pa.; Lyman A. Strong, Jas. Hedges, and S. E. Bird, of Mansfield, Directors.

A SLIGHT BLAZE.—One evening toward the close of last July a large crowd of Bostonians gathered on a certain part of Winter street and watched, with much curiosity, the burning of the woodwork upholding an electric lamp. The flames had been started by some unexplained diversion of the electric current, and were not extinguished until that portion of the circuit was shut off from connection with the central station. These slight fires are of frequent happening in all American cities where arc street lighting is in vogue; and, although happily they do not often result in serious damage to property, still they go to prove that incessant watchfulness must be exerted in order that the vagaries of the current may be noted and corrected in time.

THE SITUATION AT LOUISVILLE, KY.—The opposition combination at Louisville does not seem to be making much headway, and in fact the outcome of the Chicago, Ill., situation appears to have caused great uneasiness in the camp (or menagerie) of the Louisville strikers. Quite naturally the old Louisville company was not slow in "posting" the home brokers as to the collapse of the Chicago Consumers' Company; and Mr. Fitch and his backers "awaking to the gravity of the situation," strove to offset the effect thus produced by the publication of an article in the local newspapers which explained that the promoters of the "enterprise" were "backed by unlimited means," etc., and that they were connected with people who "knew no such word as fail." Possibly not; but it does seem as though they would ere long have a thorough acquaintance with that very word. From a gentleman recently returned from a visit to the South and West, we obtain the following particulars regarding the Louisville situation. The capacity of the opposition plant approximates to a daily supply of 200,000 cubic feet, and its main system may be placed at a length of 10½ miles. That the latter was poorly laid will be shown further on. Upon this property one-half million dollars' worth of bonds were issued, and of this sum all were placed save about \$50,000. This remaining portion has been hawked about for some time, "in lots to suit purchasers' fancy," at the figure of 70 cents on the dollar, and even less. The "securities," however, remain undisposed of. The opposition has secured in the neighborhood of 600 consumers, 500 (in round numbers) of which it may be asserted were taken from the old company, the balance, of course, being chargeable to "new consumption." Of the 500 originally taken from the Louisville Company, about 5 per cent. (and they were the most desirable ones to secure) have voluntarily renewed their allegiance. The daily output of the opposition ranges between 75,000 and 80,000 cubic feet. As an instance of the grossly negligent manner in which the new company's mains were put down, it may be stated that, on one of the principal avenues in the city, 180 handsome shade trees, planted within a distance of 8 or 10 blocks, were killed. A florist, whose extensive greenhouses were located in the same territory, suffered to such an extent that he sued for \$2,500 damages—making both companies defendants to the suit. It is supposed he impleaded the Louisville Company simply that the testimony of its managers might be secured. Our informant bases his belief that the water gas folks were at fault on the ground that they stripped and repaired that section of their pipe, while the Louisville Company took no action in the premises—the result being that in due time after the water gas mains were made tight the contents of the greenhouses gradually resumed normal condition.

As to the old company's progress, it has made a *net* gain, as shown by its books, of 490 consumers. Its output for each month of year has made a gain—save in the case of last July; when (and presumably owing to the extremely warm weather experienced) a shrinkage of 40,000 cubic feet was recorded. The directors have declared a 2 per cent. dividend, and a good balance was carried over to the satisfactory side of profit and loss account. The company still maintains the 95 cents per thousand figure in the disputed district, and it would seem as though the rate might yet be further decreased. President Morris, the Board of Directors, and Engineer Barret, are of one opinion in this "fight," and the probability is that those bonds would be a rather bad sort of purchase at 70—or under.

A NOTE FROM WORCESTER, MASS.—Supt. J. H. Rollins, of the Worcester Gas Light Company, by way of seeking rest and recreation during the heated term, is busying himself with carrying out an extensive system of repairs and alterations to plant. Twelve of the old benches of fires have been torn down, and the stacks are to be reconstructed in accordance with the most advanced ideas. In the new order of things four of the Dieterich pattern furnaces are to be installed, as also two of the McIlhenny plan; the remaining benches to be heated under the old system. A new hydraulic main of wrought iron, constructed on the incline principle (incline 3 inches to the foot), is to be put in, and all auxiliary pipes are to be spiek and span new samples of the moulder's art. The Baltimore (Md.) Retort and Fire Brick Company, through their Boston agents, the Messrs. Waldo, are to furnish the fireclay goods; and Messrs. Davis & Farnum, of Waltham, Mass., are to furnish and erect the iron work. When the contractors have finished their work, it is estimated that about \$23,000 will have been expended. Now, the foregoing would appear to show that Brother Rollins and the Worcester Company's Directors are not disposed to give up the manufacture of coal gas just yet. The general verdict "down East" appears to drift in the direction that water gas is a pretty good thing—to have but little to do with.

MORTGAGING THE WORKS.—The stockholders of the Union Gas Light Company, East New York, L. I., have recently given their consent to have the property mortgaged in the sum of \$250,000. The object or purpose necessitating the mortgage issue has not transpired.

THEY STILL OWN THE PLACE.—In our issue of July 16th it was stated that the city authorities of Detroit, Mich., extended an invitation to the Detroit Gas Light Company to bid on the public lighting for ensuing year. The gas company's bid, including repairs, etc., was \$45,000; the Brush Electric Lighting Company's figure for same work, without repairs, was \$89,000. In spite of the disparity, amounting to the round sum of \$44,000 for a twelvemonth of public lighting, the electric folks will get the contract for '85. In our July 2d issue we also referred to this matter, and then said it was supposed the "Brush Company came pretty near to owning the public authorities at Detroit;" and, viewed in the light of subsequent developments, we fear the supposition still holds good.

A SAMPLE OF INDOOR ARC ELECTRIC LIGHTING.—Brooklyn, N. Y., in spite of the fact that it ranks as number three according to the U. S. Census Reports statement, or enumeration of dwellers in our large cities, and now boasts that her precincts contain at least 750,000 souls, has but one really good restaurant. It is designated the "Clarendon," and is located on the spot made famous through that terrible holocaust (known as the "Brooklyn Theater fire") of some years ago. The main dining room is most tastefully decorated, and attached to its ceilings are a number of elegant chandeliers, the burners of which are quite equal to the task of illuminating the premises with thorough efficiency. The proprietors of the place, however, decided that "one good, strong electric light would furnish all the lighting effect necessary," hence the installation of "a 2,000-candle power arc light." Between glare and somberness a "lighting effect," exasperatingly unique in its way, is now afforded the diner. The arc will persist in "going out" with great frequency; and if one did not care much as to whether or not he got anything to eat, it would be most amusing to follow the artists of the black jacket and white apron in their hasty endeavors to "turn on the gas." Then, again, one's ears are saluted with a hissing nocturne but poorly calculated to enhance the "pleasures of the banquet." The reason advanced by the proprietors for this disagreeable illumination is, "Gas makes the place so hot, you know." In view whereof we would suggest that Brother Stein, of Philadelphia, might be prevailed upon to suggest to the Brooklyn restaurateurs (via the Brooklyn Gas Light Company) that a Siemens high power lamp would do away with the "heating" objection, and thus enable people to peacefully enjoy the viands so skilfully prepared by the Clarendon's able *chef*.

REDUCING GAS PRICES AT TAUNTON, MASS.—Mr. H. B. Leach, Supt. of the Taunton Gas Light Company, notified the customers of that corporation, under date of July 23d, that from and after October 1st, 1885, the following charges would rule: A consumption of less than 125,000 cubic feet per quarter, \$1.75 per M.; over that quantity, \$1.50 per M. The Taunton folks are always "up to the times."



A. M. CALLENDER & CO.,
PROPRIETORS.

Editor—JOS. R. THOMAS, C.E
Manager—C. E. SANDERSON.

PUBLISHED ON THE 2ND AND 16TH OF EACH MONTH
At No. 42 Pine Street, New York.

This is a recognized official organ of—
LIGHT, HEAT, STEAM, WATER-SUPPLY,
VENTILATION, SANITARY IMPROVEMENT,
AND GENERAL SCIENCE.

TERMS

SUBSCRIPTION—Three Dollars per annum, in advance.

AGENTS

NEW YORK—AMERICAN NEWS Co. 39 and 41 Chambers St.
BOSTON—S. M. PETTINGILL & Co., 6 State Street.
PHILADELPHIA—PRATT & Co., Corner 9th and Arch Streets.
England—C. W. HASTINGS, 22 Buckingham St., London, W. C
Germany—B. WESTERMANN & Co. of New York

MONDAY, AUGUST 17, 1885.

Pyrometers.

The London *Journal of Gas Lighting* says: There is great need for a reliable pyrometer, capable of directly measuring and indicating the temperature of all kinds of furnaces. Herr Seger, speaking upon this subject at a recent meeting of the German Union of Manufacturers of Refractory Products, stated that, so far, no pyrometer had proved so satisfactory as to establish itself in general use among potters, etc. For temperatures above 500° C. all patterns of pyrometers cease to be reliable, and cannot be safely used for regulating the temperature of porcelain kilns and furnaces of a similar kind. The Siemens electric pyrometer is not trustworthy, as, even with the most careful handling, repeated use vitiates the action, so that different instruments hardly ever give corresponding indications. This apparatus also requires frequent repairs. There is only one other device—the circulating water pyrometer—for registering the temperature of closed furnaces; and this is a cumbrous and immovable arrangement susceptible of only limited use. For many purposes what are called pyroscopes are employed to give approximate indications of the temperature of ovens and flues the interiors of which are open to inspection. Fusible alloys of metals are sometimes used for this purpose; the more satisfactory (up to their limits of application) being inoxidizable alloys of gold and silver, or gold and platinum. These, however, are not recommended for temperatures above 1,200° C. In fire brick and porcelain works use is frequently made of a graduated series of mixtures of fire clay and ground felspar; also of felspar, quartz, and fire clay. These mixtures are moulded into cubes of about an inch, and are placed in the flues or kilns so that they can be inspected through sight-holes in the furnace walls. The approach of the fusion temperature is shown by the rounding off of the corners of the cubes. These indications are, of course, sufficient for immediate practical purposes,

but they do not show the temperature attained by any thermometric scale, and therefore fail in the desirable feature of registration.

Gas Engines of Large Power.

The Company engaged in the manufacture of the Otto gas engines at Deutz, Germany, have recently erected a water works to the order of the authorities of the city of Duren. The pumps of the establishment are driven by two Otto gas engines, each of forty-horse power. The same company have a similar contract which they are carrying out at Coblenz, where they will install two forty-horse engines; and in addition to the above they will equip the city of Quedlinburg with a water supply plant, and operate the pumps thereof with gas engines.

While, at the prices generally charged for gas in this country, it may not be in line with economy to employ gas engines in the running of water works pumps, exceptional prices, or those approximating to the cost of gas in holder, may make such plants possible even in the United States—especially in localities where the gas and water supply arrangements are in the hands of one corporation.

That there is economy in gas power over steam power—comparing, pound, for pound, the energy evolved from coal—has already been demonstrated through the medium of practical illustration. The most recent instance that we have of this fact is afforded by the Lead Mining Company of Metternich, Germany, the proprietors of which are now building a gas works, the function of same being to supply force to gas engines whose total horse power is estimated at 400.

Refrigerating Machines.

An exchange says that the great advantage of ammonia for refrigerating purposes, over ether, and more particularly over dry air, is that the required effect is gained by a smaller expenditure of fuel. Ammonia boils at a temperature of 30° F., at atmospheric pressure, and has a vapor tension of 120 pounds per square inch at 65° F. It has a latent heat (by equal weight) of 900. Ether, on the other hand, boils at 90° F., at atmospheric pressure, has a vapor tension of about 10 pounds, while the latent heat is, by equal weight, 162, and by equal volume, 369. Air, of course, is not condensable, and does not enter into the comparison on the same basis. Putting theory, however, on one side, Mr. Jno. Chambers, of New Zealand, states that his machine, which is designed to do the same work as a dry air machine delivering 60,000 cubic feet per hour, will work with about 1 ton of coal per 24 hours, while the air machine will require four tons for the same work. It will keep a storage space of 20,000 cubic feet, enough to hold 7,000 carcasses of sheep, at a temperature of zero, and occupies an area of 306 square feet, the cubical measurement required being 2,295 cubic feet. At a higher temperature, say, 15°, a larger space can be kept cool.

Something Curious.

Les Mondes avers it has been noticed that laborers who work barefooted upon asphalt pavements are subject to swelling of the limbs, which has been attributed to the vaporization by the heat of the feet of a small quantity of the petroleum or mineral oil which is contained in the asphalt. The nerves of the feet which govern muscular action and the contraction of the blood vessels form an extensive and very sensitive nervous net-

work under the arch of the foot, where the skin is always thin, and the nerves are consequently easily affected.

A REMARKABLE occurrence is reported from Glasgow, which, in spite of the approach of the gigantic gooseberry season, is probably true. A constant and brilliant flame, 4 or 5 ft. high, is ascending from the waters of the Clyde. For some time gas has been bubbling up through the water, and this was ignited a few days ago by an angler in lighting his pipe. It is supposed the gas comes from mineral working below.

Gas Stocks.

Quotations by Geo. W. Close, Broker and Dealer in Gas Stocks.

16 WALL ST., NEW YORK CITY.

AUGUST 17.

All communications will receive particular attention.
The following quotations are based on the par value of \$100 per share.

	Capital.	Par.	Bid	Asked
Consolidated.....	\$35,430,000	100	94	95
Central.....	440,000	50	60	70
“ Scrip.....	220,000	—	47	57
Equitable.....	2,000,000	100	136	140
“ Bonds.....	1,000,000	—	107	110
Harlem, Bonds.....	170,000	—	—	—
Metropolitan, Bonds....	658,000	—	110	113
Mutual.....	3,500,000	100	135	137x
“ Bonds.....	1,500,000	1000	104	107
Municipal, Bonds.....	750,000	—	—	—
Northern.....	125,000	50	50	—
“ Scrip.....	108,000	—	—	—
Gas Co's of Brooklyn.				
Brooklyn.....	2,000,000	25	130	132
Citizens.....	1,200,000	20	84	86
“ S. F. Bonds....	320,000	1000	106	110
Fulton Municipal.....	3,000,000	100	158	160x
“ Bonds....	300,000	—	104	108
Peoples.....	1,000,000	10	86	88
“ Bonds.....	290,000	—	105	110
“ “.....	250,000	—	90	95
Metropolitan.....	1,000,000	100	94	96
Nassau.....	1,000,000	25	125	127x
“ Cfts.....	700,000	1000	98	99
Williamsburgh.....	1,000,000	50	155	160
“ Bonds....	1,000,000	—	111	114
Richmond Co., S. I....	300,000	50	64	75
“ Bonds.....	40,000	—	—	—
Out of Town Gas Companies.				
Buffalo Mutual, N. Y...	750,000	100	80	85
“ Bonds....	200,000	1000	95	100
Citizens, Newark.....	918,000	50	103	115
“ Bonds....	124,000	—	105	110
Chicago Gas Co., Ills...	5,000,000	25	130	140
Peoples G. L. & C. Co., Chicago, Ills.....			8	12
Cincinnati G. & C. Co..			180	182
Consolidated, Balt.....	6,000,000	100	42	43
“ Bonds....	3,600,000	—	107	107½
Central, S. F., Cal.....			—	58
Capital, Sacramento, Cal.			56	—
Hartford, Conn.....	750,000	25	123	129
Jersey City.....	750,000	20	145	—
Laclede, St. Louis, Mo.	1,600,000	100	100	105
Louisville, Ky.....	1,500,000	50	95	100
Montreal, Canada.....	2,000,000	100	181	182½
New Haven, Conn.....			25	166
Oakland, Cal.....			29	30
Peoples, Jersey City...			—	45
“ “ Bonds..			—	—
Paterson, N. J.....			25	90
Rochester, N. Y.....			50	75
Washington, D. C.....	2,000,000	20	212½	—
Wilmington, Del.....			50	199
Yonkers.....			50	41
St. Louis, Missouri.....	600,000	50	—	625x
San Francisco Gas Co.				
San Francisco, Cal....			56½	57½
Havana (Cuba) Gas Co.	3,000,000	100	8	—
“ Bonds.....	550,000	—	—	—

Advertisers Index.

	Page
GAS ENGINEERS.	
Jos. R. Thomas, New York City	108
Wm. Henry White, New York City.....	106
GAS WORKS APPARATUS AND CONSTRUCTION.	
James R. Floyd, New York City	107
T. F. Rowland, Greenpoint, L. I.....	107
Delly & Fowler, Phila., Pa.....	107
Kerr Murray Mfg. Co., Fort Wayne, Ind.....	107
Stacey Mfg. Co., Cincinnati, Ohio.....	107
Bartlett, Hayward & Co., Baltimore, Md.....	107
Morris, Tasker & Co., Limited, Phila., Pa.....	106
Davis & Farnum Mfg. Co., Waltham, Mass.....	80
Tanner & Delaney Engine Co., Richmond, Va.....	106
R. D. Wood & Co., Phila., Pa.....	106
Southwark Foundry and Machine Co., Philadelphia, Pa.....	106
GAS AND WATER PIPES.	
A. H. McNeal, Burlington, N. J.....	104
Gloucester Iron Works, Phila., Pa.....	104
Warren Foundry and Machine Co., Phillipsburgh, N. J.....	104
Mellert Foundry and Machine Co., Reading, Pa.....	104
Cincinnati and Newport Iron and Pipe Co., Newport, Ky.....	104
Fox & Drummond, New York City.....	104
Ohio Pipe Co., Columbus, Ohio.....	104
PIPE JOINTS.	
Pancoast & Maule, Philadelphia, Pa.....	108
Rollstone Machine Company, Fitchburg, Mass.....	108
SCRUBBERS AND CONDENSERS.	
G. Shepard Page, New York City.....	105
REGENERATOR FURNACES.	
Charles F. Dieterich, Baltimore, Md.....	52
GAS ENGINES.	
Schleicher, Schumm & Co., Phila., Pa.....	112
Clerk Gas Engine Company, Phila., Pa.....	100
RETORTS AND FIRE BRICK.	
J. H. Gautier & Co., Jersey City, N. J.....	102
B. Kreischer & Sons, New York City.....	102
Adam Weber, New York City.....	102
Laclede Fire Brick Works, St. Louis, Mo.....	102
Brooklyn Retort and Fire Brick Works, Brooklyn, N. Y.....	102
Borgner & O'Brien, Phila., Pa.....	102
William Gardner & Son, Pittsburgh, Pa.....	102
Henry Maurer, New York City.....	102
Chicago Retort and Fire Brick Works, Chicago, Ills.....	102
Baltimore Retort and Fire Brick Co., Baltimore, Md.....	102
Standard Gas Retort and Fire Brick Co., Ironton, Ohio.....	102
Oakhill Gas Retort and Fire Brick Co., St. Louis, Mo.....	102
A. T. Chur, New York City.....	109
RETORT CEMENT.	
C. L. Gerould, Manchester, N. H.....	99
GAS STOVES.	
American Meter Co., New York and Philadelphia.....	103
The Goodwin Gas Stove and Meter Co., Philadelphia, Pa.....	84
GAS METERS.	
Harris, Griffin & Co., Phila., Pa.....	110
American Meter Co., New York and Philadelphia.....	111
The Goodwin Gas Stove and Meter Co., Phila. Pa.....	111
Helme & McIlhenny, Phila., Pa.....	111
Maryland Meter and Mfg. Co., Baltimore, Md.....	110
D. McDonald & Co., Albany, N. Y.....	111
Nathaniel Tufts, Boston, Mass.....	110
EXHAUSTERS.	
P. H. & F. M. Roots, Connersville, Ind.....	101
Smith & Sayre Manufacturing Co., New York City.....	106
Wilbraham Bros., Philadelphia, Pa.....	108
GAS COALS.	
Penn Gas Coal Co., Phila., Pa.....	109
Perkins & Co., New York City.....	103
ewburgh Orrel Coal Co., Baltimore Md.....	109
Despard Coal Co., Baltimore, Md.....	109
Chesapeake and Ohio R.R. Coal Agency, N. Y. City.....	109
Westmoreland Coal Company, Phila., Pa.....	109
GAS ENRICHERS.	
W. H. Doan, Cleveland, Ohio.....	99
VALVES.	
Ludlow Valve Manufacturing Co., Troy, N. Y.....	104
John McLean, New York City.....	104
GAS LAMPS.	
Siemens Regenerative Gas Lamp Co., Philadelphia, Pa.....	105
G. Shepard Page, New York City.....	81

GAS KILNS AND OVENS.	
Thompson Gas Kiln and Oven Co., New York City.....	101
PURIFIER SCREENS.	
John Catot, Lawrence, Mass.....	108
STREET LAMPS.	
J. G. Miner, Morrisania, New York City.....	101
Bartlett Street Lamp Mfg Co., New York City.....	101
BURNERS.	
G. Gefrorer, Phila., Pa.....	106
PURIFYING MATERIAL.	
Connelly & Co., New York City.....	108
STEAM BLOWER FOR BURNING BREESE.	
H. E. Parson, New York City.....	71
PIPE COVERINGS.	
Chalmers-Spence Company, N. Y. City.....	108
GAS FIXTURES.	
Mitchell, Vance & Co., New York City.....	99
STEAM PUMPS.	
A. S. Cameron Steam Pump Works, N. Y. City.....	101
HYDRAULIC ELEVATOR.	
Lane & Bodley Company, Cincinnati, Ohio.....	101
SHAFTING, PULLEYS, ETC.	
A. & F. Brown, New York City.....	99
HYDRAULIC MAIN.	
A. E. Boardman, Macon, Ga.....	101

WANTED,
A Competent Foreman,
 To take charge of a gas works. One who has held such a position, and can give references as to experience, capability, and character. Apply by letter to **FRANK F. JONES,** 628-1t 231 Broadway, N. Y. City.

Position Wanted
AS SUPERINTENDENT OF A GAS WORKS.
 Has had ten years' practical experience in the manufacture and distribution of gas. For particulars and references address 628-1t "T. U. V.," care this Journal.

WANTED,
A Second-Hand 6 or 8 Inch Steam-Jet Exhauster,
COMPLETE.
MIDDLETOWN GAS LIGHT CO., 628-2t Middletown, Orange County N. Y.

SITUATION WANTED
 As Secretary, or as Secretary and Manager. Good knowledge of gas companies' accounts; competent to design and superintend erection of works; good general knowledge of gas works management. Seven years Accountant and Asst. Engr. to an English company; two years manager of a gas company in the Brazils. References on application. Address "A. P.," Post Office, Quebec, Canada.

SUPERINTENDENT WANTED
 For a small gas works in a Western Territory. Mild, healthful climate. Gas made from soft coal. Applicant must be well recommended in all respects, and be competent and willing to set meters, repair leaks, keep fixtures in order, etc. Address 628-2t "A. B. C.," care this Journal.

FOR SALE.
Second-Hand Gas Apparatus.
One Condenser, 4½ ft. diameter by 13 ft. in length over all, containing 150 two and one-half, inch tubes, 8 ft. long with 12-in. connections and bye-pass.
Two Smith & Sayre (12-inch) Steam-Jet Exhausters, with 3 Self-acting Bye-Passes.
Four Purifying Boxes, 10 ft. by 14½ ft. by 3 ft., with 12-inch connections and center seal.
 All in good order, and will be sold cheap. Address **PETER P. MILLER,** Manager Citizens Gas Co., Buffalo, N. Y.

FOR SALE,
Second-Hand Gas Apparatus.
 The Louisville (Ky.) Gas Light Company wishes to dispose of the following:
15 Sixteen-Inch Chapman Valves.
6 Twelve-Inch Chapman Valves.
2 Twelve-Inch Center Seals & Connections.
2 Smith & Sayre Gas Steam Governors.
 All in good order, and will be sold at low figures. Address inquiries to **A. H. BARRET,** Engineer's Office, Louisville (Ky.) Gas Company.

GEROULD'S IMPROVED RETORT CEMENT.
 Used by most of the Gas Companies of the United States with perfect satisfaction. Manufactured by **C. L. GEROULD,** Manchester, N. H.
 N. B.—As Manchester is a shipping point, all freight can be shipped as cheaply as from Boston or New York.

MITCHELL, VANCE & CO.,
 MANUFACTURERS OF
Chandeliers
 and every description of
GAS FIXTURES.
 Also manufacturers of Fine Gilt Brouzes and Marble Clocks, warranted best time-keepers. Mantel Ornaments, etc.
Salesrooms, 836 Broadway, N. Y.
 Special Designs furnished for Gas Fixtures for Churches, Public Halls, Lodges, etc.

W. H. DOAN,
 REFINER OF
NAPHTHA and GASOLINES
 ALSO MANUFACTURER OF
 A Special Grade of Naphtha for Gas Companies
FOR ENRICHING COAL GAS.
 Correspondence solicited.
No. 43 Euclid Avenue, Cleveland, Ohio.



Shafting, Pulleys, HANGERS.

F. Brown's Patent Friction Clutch.

Send for Illustrated Catalogue and Discount Sheet to

A. & F. BROWN,
No. 43 Park Place, New York City.

THE CLERK GAS ENGINE.

Highest Award! American Institute, New York, 1883. Silver Medal American Institute, N. Y., 1884.
Gold Medal Awarded Crystal Palace Electrical Exhibition, London, 1882.
Highest Award for Motive Power British Section International Exhibition of Electricity, Paris, 1881.

Reliable.

Economical.

No Boiler.

No Engineer.

Steady.

No Explosion

No Coal.

No Gearing
Wheels.

Simple.

No Danger.

No Ashes.

No Parts
requiring
frequent
renewal.

Compact.

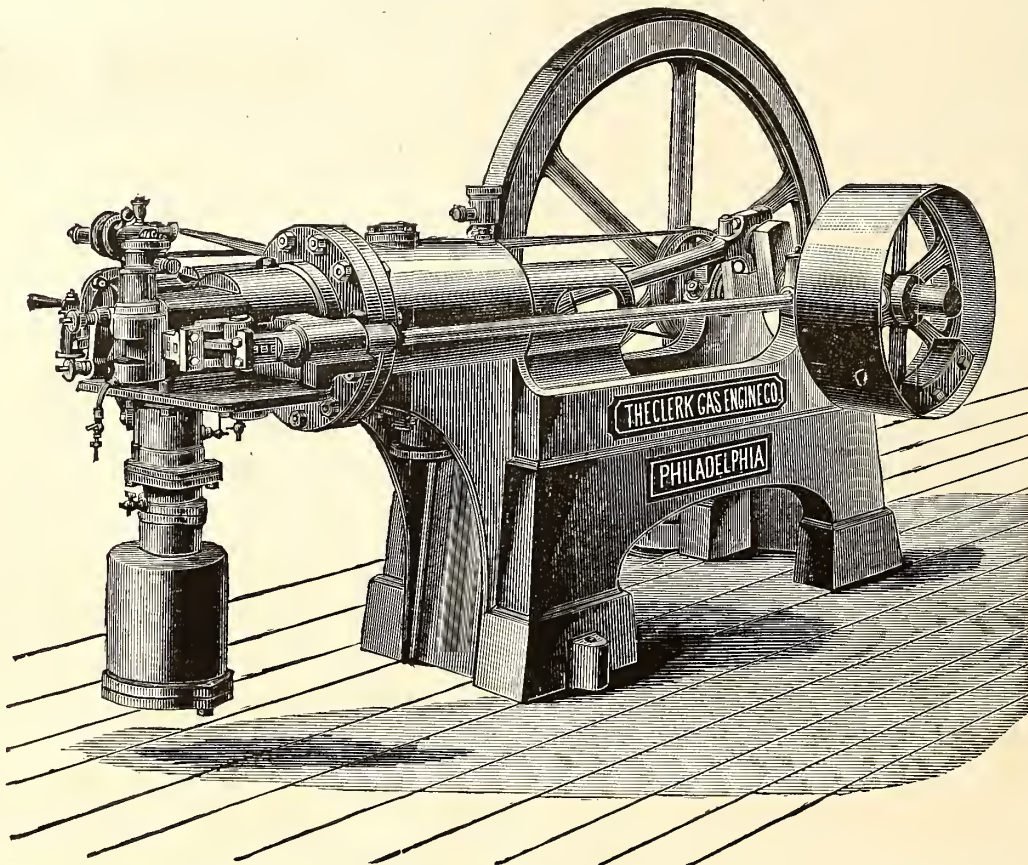

REQUIRING ONLY A MATCH TO START IT--GIVING ITS FULL POWER IMMEDIATELY.

We would inform the public that during the last few months we have improved THE CLERK GAS ENGINE to such an extent that we can now offer an engine vastly superior to our former pattern. These improvements have enabled us to sell our engine at a GREATLY REDUCED FIGURE, partly on account of the decreased weight (our engine weighing about half that of others giving the same Brake H. P). The consumption of gas has been decreased to a considerable extent, and the Brake H. P. has been increased some 25 to 30 per cent. All parts of the old design that were considered defective have been remodeled and new designs added. We now have an engine second to none as regards power, consumption, and ease of working. With our new engine all trouble in starting has been removed, the noise reduced to a minimum, and the regularity of motion is now all that can be desired. We guarantee all we claim for it, and the material and workmanship being of the best, enables us to guarantee the engine for twelve months.

SOLE MAKERS,

THE CLERK GAS ENGINE CO.,

WM. W. GOODWIN, President. E. STEIN, Secretary. S. LEWIS JONES, Asst. Secretary. L. P. GARRET, Supt.

Main Office, 1012-1018 Filbert Street, Philadelphia, Pa.

BRANCH OFFICES,

142 Chambers St., N. Y.

4 West Fourteenth St., N. Y.

76 Dearborn St., Chicago

General Agents,

THE GOODWIN GAS STOVE & METER CO

Of Philadelphia, New York, and Chicago.

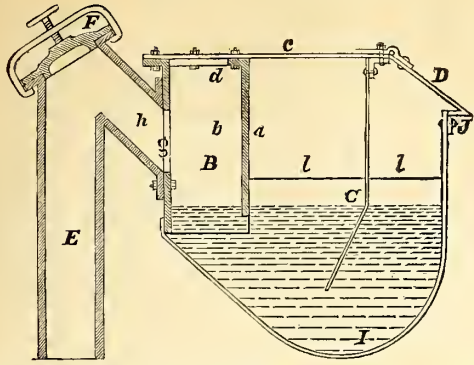

Boardman Hydraulic Main,

Patented October 7, 1884.

For description, see AM. GAS LIGHT JOURNAL of Feb. 2, 1884.
For terms, apply to

A. E. BOARDMAN, Macon, Ga.

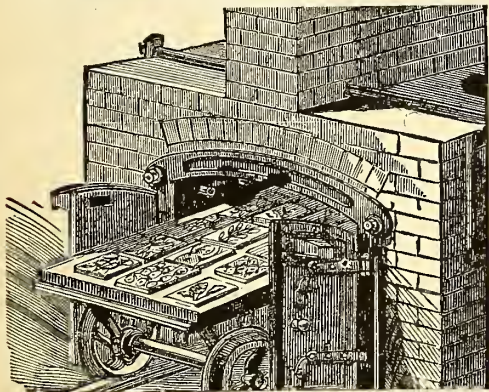

Glass-Staining Gas Kiln.

BAKERS' & CONFECTIONERS' OVENS (PAT.)

Thompson Gas Kiln & Oven Co.

59 Carmine St., N. Y.

Send for Circular by mail.

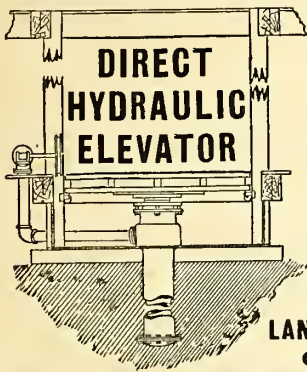

DIRECT HYDRAULIC ELEVATOR

With Iron or Wood Platform.

Largely used by Leading Gas Co.s for Coal and Coke Lifts.

Adapted for use with city service, or special pumping and accumulator system. For prices address the

LANE & BODLEY CO.,
Cincinnati, O.

THE GLOBE STREET LAMP.



MINER'S PATENT STREET LAMPS.

Are adapted for use of Streets, Parks, Depots, Ferries, & Private Grounds.

WITH POSTS OR BRACKETS.

Jacob G. Miner,

No. 823 Eagle Ave., New York N. Y.

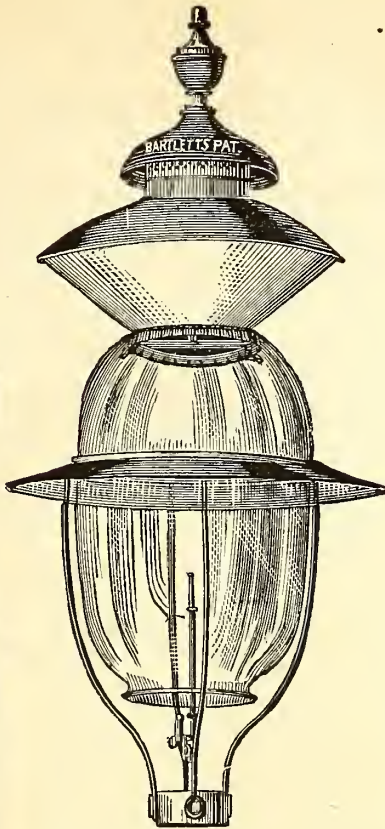

C. BARCALOW, PREST.

J. V. BARCALOW, SEC. & TREAS.

BARTLETT Street Lamp Mfg. Co.

MANUFACTURERS OF

Bartlett's Patent

GLOBE LAMPS.

FOR

Streets, Parks, Railroad Stations, Public Buildings, Etc.

LAMP POSTS A SPECIALTY.

Office and Salesroom,

No. 35 Howard Street, N. Y. City.

Gas Companies and others intending to erect lamps and posts will do well to communicate with us.

F. M. ROOTS.

S. C. ROOTS

D. T. ROOTS.

P. H. & F. M. ROOTS
PATENTEES AND MANUFACTURERS OF

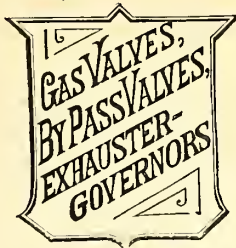

GAS VALVES, BY-PASS VALVES, EXHAUSTER-GOVERNORS

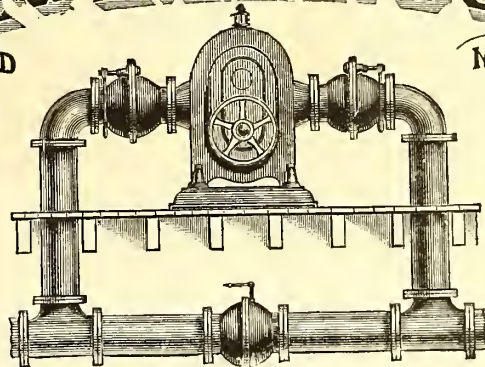

PIPE-FITTINGS, & ALL FIXTURES FOR EXHAUSTER ROOMS.

IMPROVED GAS EXHAUSTER,

WITH ENGINE ON SAME BED PLATE, OR WITHOUT.

BY-PASSES, GAS VALVES, GOVERNORS, ELBOWS, PIPE-FITTINGS, Etc., FURNISHED TO ORDER,

P. H. & F. M. ROOTS, Patentees & Manufacturers, CONNERSVILLE, IND.

S. S. TOWNSEND, General Agent, 22 Cortland St. and 9 Dey St., N. Y.

JAS. BEGGS & CO., Selling Agents, 9 Dey St., N. Y.

COOKE & CO., Selling Agents, 22 Cortland St., N. Y.

* SEND FOR ILLUSTRATED CATALOGUE AND PRICE LIST. *

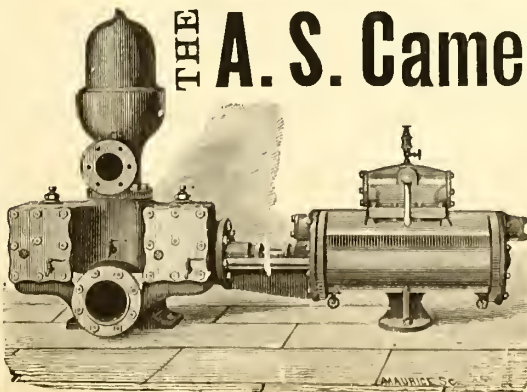

THE A. S. Cameron Steam Pump,

THE STANDARD OF EXCELLENCE.

Upward of 30,000 in Use.

BEST GAS WORKS PUMP

Ever Introduced.

Adapted to Every Possible Duty.

A. S. Cameron Steam Pump Works,

Foot East 23d St., N. Y.

J. H. GAUTIER & CO.
CORNER OF
GREENE AND ESSEX STREETS,
JERSEY CITY, N. J.
MANUFACTURERS OF
**Clay Gas Retorts,
Gas House Tiles,
Fire Bricks, Etc. Etc.
Ground Clay, Fire Brick and
Fire Sand in Barrels,**

J. H. GAUTIER. T. B. GAUTIER.
C. E. GREGORY. C. E. GAUTIER.

BROOKLYN
Clay Retort & Fire Brick Works,
(EDWARD D. WHITE & CO.)
Manufacturers of Clay Retorts, Fire Brick,
Gas House and other Tile.
VAN DYKE, ELIZABETH, RICHARDS & PARTITION STS.
Office, 88 Van Dyke St., Brooklyn, N. Y.

LACLEDE FIRE BRICK MFG. CO.,
MANUFACTURERS OF
Fire Brick, Gas Retorts,
AND
ST. LOUIS STANDARD SEWER PIPE.
Blast Furnace and Cupola Linings, every description of Fire
Clay Material, Fire Clay Flue Linings, Chimney Tops
Dry Milled and Crude Fire Clays, etc.
OFFICE AND DEPOT
901, 903, and 905 Pine Street,
ST. LOUIS, MO.

ESTABLISHED IN 1845.

B. KREISCHER & SONS,
OFFICE FOOT OF HOUSTON ST., E.R., N.Y.
Gas Retorts,
TILES, FIRE BRICK.
AND EVERYTHING IN THE FIRE CLAY LINE.

MANHATTAN
FIRE BRICK & ENAMELLED CLAY
RETORT WORKS.
ADAM WEBER.
**CLAY GAS RETORTS
AND RETORT SETTINGS
FIRE BRICKS, TILES, ETC.,**
Office and Works, 15th Street and Avenue C., N. Y.

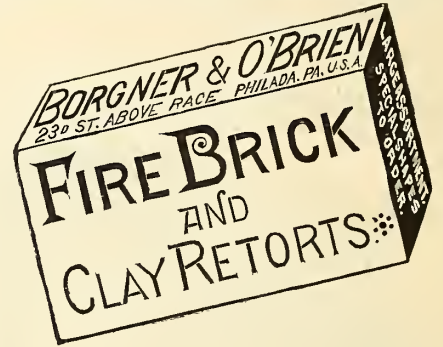

JAMES GARDNER, JR.
Works,
LOCKPORT STATION, PA.

—ESTABLISHED 1864.—
WILLIAM GARDNER & SON,
Successor to GARDNER BROTHERS.

WILLIAM GARDNER.
Office, COAL EXCHANGE,
PITTSBURGH, PA., P. O. Box 373.

Fire Clay Goods for Gas Works.

C. H. SPRAGUE, No. 70 KILBY STREET, BOSTON, MASS., Agent for the New England States.

OFFICE, 418 to 422 East 23d St., New York.

ESTABLISHED 1856.

WORKS, PERTH AMBOY, NEW JERSEY.

HENRY MAURER,
Excelsior Fire Brick & Clay Retort Works
CLAY GAS RETORTS, BENCH SETTINGS, FIRE BRICK, TILES, ETC.

STANDARD GAS RETORT AND FIRE BRICK COMPANY,
J. ANDERSON, PRES. & MANG'R. OF IRONTON, OHIO. C. PETERS, SECRETARY.
Clay Gas Retorts, Fire Brick, and Fire Clay Goods of Every Description.
Plans of Livesey-Somerville, McIlhenny, and other Furnaces, and Competent Workmen Supplied.

CHICAGO
Retort & Fire Brick Works,
OFFICE AND FACTORY,
Clark, Forty-Fifth, and La Salle Streets,
CHICAGO, ILL.
GEORGE C. HICKS, PRES. PAUL P. AUSTIN, SEC. & TREAS.
STANDARD
**Clay Retorts and Settings.
BLOCKS & TILES**
of every Shape and Size to Order.
Standard Fire Bricks.

NEWBIGGING'S
Gas Manager's Handbook.
Price, \$4.80.
EVERY GAS MAN SHOULD HAVE ONE.
Orders may be sent to this Office.

OAKHILL
GAS RETORT & FIRE BRICK
COMPANY.
PARKER, RUSSELL & CO.
City Office, 711 Pine Street,
ST. LOUIS, MO.

Our immense establishment is now employed almost entirely in
the manufacture of
MATERIALS FOR GAS COMPANIES.
We have studied and perfected three important points. Our re-
torts are made to stand changes of temperature, the strongest
heats of the furnace, and the abrasion of feeding and emptying.
Our customers are in almost every State of the Union, to all of
whom we refer.

THOS. SMITH, Prest. AUGUST LAMBLA, Vice-Prest. & Sup
BALTIMORE
RETORT & FIRE BRICK CO.
MANUFACTORY AT
LOCUST POINT, BALTIMORE, MD.
Connection with the City by Telephone.
**Clay Retorts, Blocks & Tiles,
FIRE BRICK, FIRE CLAY,
AND FIRE CEMENT.**

Red and Buff Ornamental Tiles and Chim-
ney Tops. Drain and Sewer Pipe (from
2 to 30 inches). Baker Oven Tiles
12 x 12 x 2 and 10 x 10 x 2.
WALDO BROS., 88 WATER ST., BOSTON, MASS
Sole Agents for New England States

THE AMERICAN METER CO.,



Large Flat Flame Burners.
15 cts. each, \$1.50 per doz.
A test with these burners, with 18-can. gas, gives the following results:

No.	Pressure.	Consump. per Hr.	Candle Power
20	1.00 in.	7.75	33.00
30	1.00 in.	9.90	42.50
40	0.85 in.	10.20	44.54
60

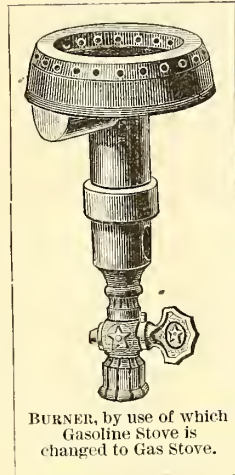

MANUFACTORIES,

508 to 514 West Twenty-second St., N. Y.

Arch and Twenty-second St., Phila.

Nos. 244 & 246 North Wells Street, Chicago, Ill.

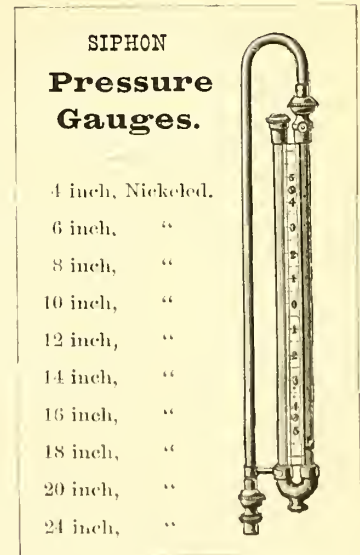
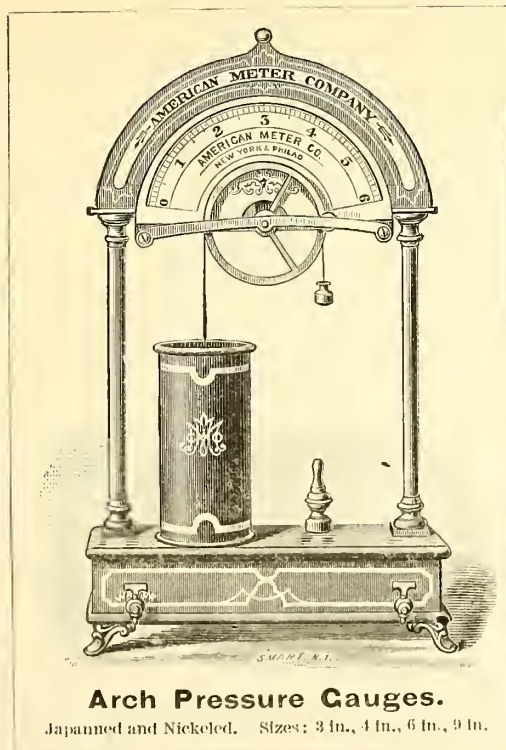
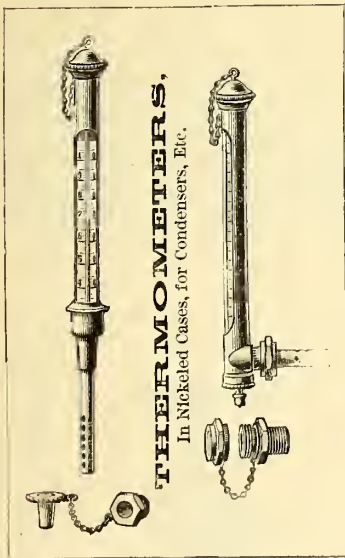

AGENCIES,

No. 177 Elm Street, Cincinnati, Ohio.

Nos. 122 & 124 Sutter Street, San Francisco Cal.

No. 810 North Second Street, St. Louis, Mo.

A. H. M'NEAL,

BURLINGTON, N. J.

Flange-Pipes

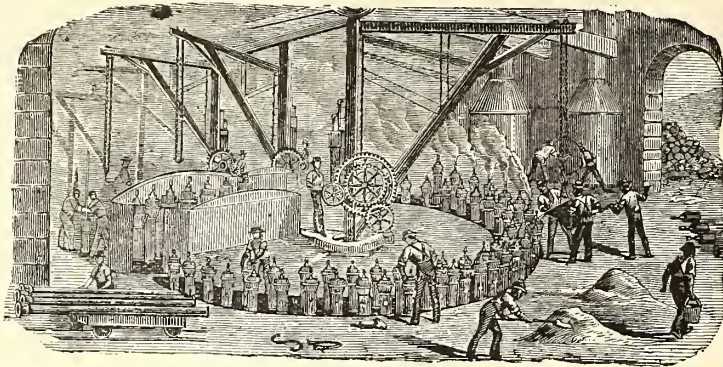

General Foundry Work.

CAST IRON PIPES FOR WATER AND GAS

JAMES S. MOORE, Pres.
BENJAMIN CHEW, Treas.

JAS. P. MICHELLON, Sec.
WM. SEXTON, Supt.

GLOUCESTER IRON WORKS, GLOUCESTER CITY, N. J.

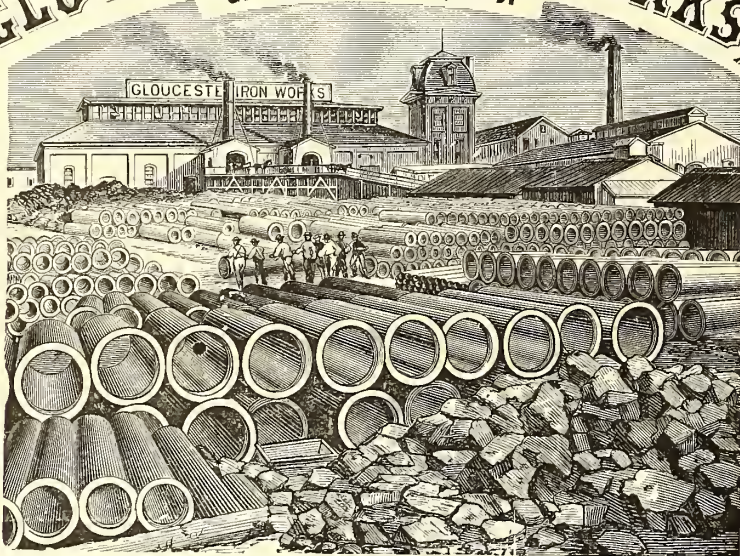

Cast Iron Gas & Water Pipes, Stop Valves, Fire Hydrants, Gasholders, &c.
Office No. 6 North Seventh Street, Philadelphia.

ESTABLISHED 1856.

WARREN FOUNDRY AND MACHINE CO.,

WORKS AT PHILLIPSBURGH, N. J.
NEW YORK OFFICE, 162 BROADWAY.

Cast Iron Water and Gas Pipe

FROM TWO TO FORTY-EIGHT INCHES DIAMETER.
ALSO ALL SIZES OF

FLANGE PIPE for Sugar House and Mine Work.
Branches, Bends, Retorts, Etc., Etc.

436-1

MATTHEW ADDY, President.

W. L. DAVIS, Selling Agent.

GEO. P. WILSHIRE, Sec. & Treas.

Cincinnati and Newport Iron and Pipe Company,

NEWPORT, KY.

Lamp Posts
AND
BENCH CASTINGS

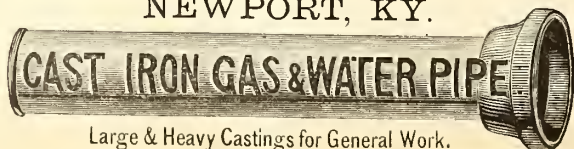

Branch
AND
SPECIAL CASTINGS
FOR GAS & WATER CO'S.

A Specialty.

Large & Heavy Castings for General Work.

Manufacture Pipe from 2 to 48 inches. All work guaranteed first quality.

Mellert Foundry and Machine Co.

Limited. Established 1848.
MANUFACTURERS OF



Specials—Flange Pipe, Valves and Hydrants,
Lamp Posts, Retorts, etc.
Machinery and castings for Furnaces, Rolling Mills, Grist and
Saw Mills, Mining Pumps, Hoists, etc.

GENERAL OFFICE, - - - READING, PA.

CAST IRON

Gas and Water Pipes,

From 2 to 48 Inches in Diameter.

FOX & DRUMMOND,

160 Broadway, N. Y. City.

THE OHIO PIPE COMPANY,

MANUFACTURERS OF

Cast Iron Gas & Water Pipe,

BRANCH AND SPECIAL CASTINGS.

Gas-House Bench Castings, Hydraulics, Lamp Posts, Flange Pipe
and Specials, Architectural Castings, Building Columns,
Joists, Collar Grates, Sash Weights, etc.

GENERAL FOUNDERS AND MACHINISTS.

Columbus, Ohio.

LUDLOW VALVE MFG. CO.

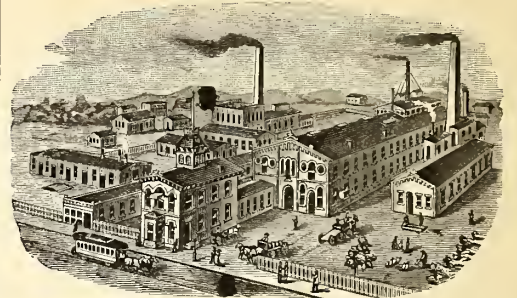

OFFICE AND WORKS,

938 to 954 River Street and 67 to 83 Vail Av.
TROY, N. Y.

Hydraulic Main Dip Regulators, also
Check Valves, Foot Valves, Yard-
wash and Fire Hydrants.
Send for Circulars.

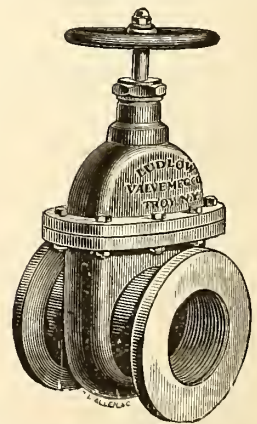

Valves.—Double and Single Gate, 1/2 in. to
48 in., outside and inside Screws. Indica-
tor, etc., for Gas, Water, Steam, and Oil.
Send for Circulars.

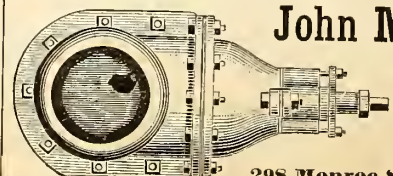

John McLean

Manufacturer of
GAS
VALVES.

298 Monroe Street, N. Y.

Siemens's Regenerative Gas Burners, For Lighting and Ventilating.

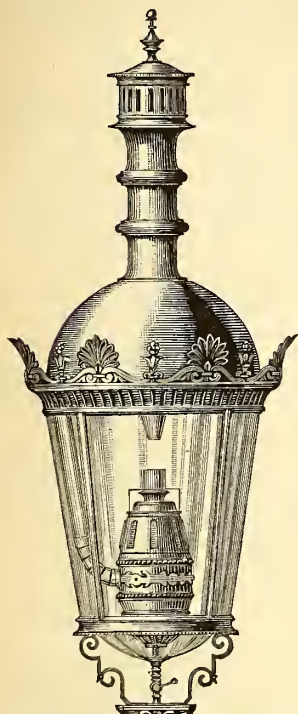

THE CHEAPEST, PUREST, AND MOST BRILLIANT OF ALL GAS LIGHTS.

Superior to the Electric Light in Economy, Beauty, & Steadiness.

SPECIALLY ADAPTED FOR LIGHTING HALLS, FACTORIES, OPEN SPACES, ETC.

Numerous Tests made by various Gas Companies in the United States show an Efficiency of Ten Candle Power per Cubic Foot of Gas.

General Agents:

- SIEMENS LIGHTING CO., 347 West Main St., Louisville, Ky.
- MEYER, MARSHALL & CO., 528 California St., San Francisco.
- DENNEHY, WOLF & O'BRIEN, 85 & 87 Dearborn St. Chicago, Ill.
- WILCOX & McGEARY, - No. 11 Bissel Block, Pittsburgh, Pa.
- T. T. RAMSDALL & CO., - 20 Swan Street, Buffalo, N. Y.
- SIEMENS GAS ILLUMINATING CO.,
Room 6, No. 157 Broadway, New York City.
- W. D. COLT, - - - 1420 F Street, Washington, D. C.
- JOHN KIEFER, - - - 344 Lawrence, Street, Denver, Col.

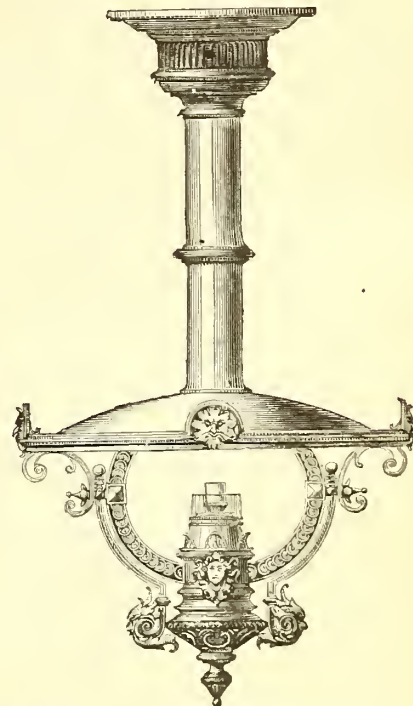

THE SIEMENS REGENERATIVE GAS LAMP COMPANY,

SOLE MAKERS FOR THE UNITED STATES,

N. E. Cor. 21st. St. and Washington Av., Philadelphia. Pa.

THE "STANDARD" WASHER-SCRUBBER, KIRKHAM, HULETT & CHANDLER'S PATENT.

Total Capacity per 24 Hours of "Standard" Washers Ordered During the Following Years.

1877.....	4,000,000	cubic feet.
1878.....	4,750,000	"
1879.....	24,545,000	"
1880.....	42,967,500	"
1881.....	36,462,500	"
1882.....	39,300,000	"
1883.....	57,735,000	"
1884.....	26,177,500	"
Total.....	235,937,500	cubic feet.

Total Number and Capacity per 24 Hours of "Standard" Washers Erected and in Course of Erection in the Several Countries

	Number.	Cubic Feet per Day.
Great Britain..	151	157,070,000
Western Hemisphere.....	38	39,337,500
Australia.....	18	12,150,000
New Zealand.....	2	650,000
France.....	6	4,550,000
Belgium.....	8	5,420,000
Germany.....	16	8,200,000
Holland.....	4	4,160,000
Denmark.....	1	150,000
Russia.....	2	3,500,000
Spain.....	1	350,000
India.....	1	400,000
Total.....	248	235,937,500

THE CONTINUED POPULARITY

Of these Machines

Will be recognized from the following extracts from letters from representatives of some of the companies having them in use:

PROVIDENCE GAS COMPANY, }
PROVIDENCE, R. I., Nov. 24, 1884. }
GEO. SHEPARD PAGE, Esq., New York:

Dear Sir—We are now using less than a gallon of water per thousand in the "Standard," and the gas at the outlet will not color turmeric paper.

Yours etc.,

A. B. SLATER, Treasurer.

PORTLAND GAS COMPANY, }
PORTLAND, ORE., Nov. 29, 1884. }
GEO. SHEPARD PAGE, New York:

Dear Sir—Our Scrubber appears to run to our entire satisfaction, and we are pleased to say that it takes out all the ammonia from the gas. This is very satisfactory to us, as we were ruining our meters at a fearful rate heretofore. The amount of water used is very inconsiderable as compared with our old process. The machine runs very smooth and still.

Very respectfully,

H. C. LEONARD, Secretary.

"Standard" Washers Ordered Recently.

	Cu. Ft. per Day
Anneberg Gas Co.....	200,000
Bombay Gas Co.....	400,000
Brussels Co.....	1,250,000
CHICAGO, two, 1,000,000 each.....	2,000,000
Chemnitz Gas Co.....	1,000,000
CITIZENS GAS CO., BUFFALO.....	750,000
Coke Works in Zabre, Ober-Schlesien.....	1,500,000
Cokerei der Friedenshutte, Upper Silesia.....	1,000,000
Dunfries Corporation.....	250,000
Dunedin Gas Co., New Zealand.....	400,000
GEORGETOWN, D. C.....	250,000
King's Lynn Gas Co.....	300,000
Lelden, Holland.....	600,000
Lincoln Gas Co.....	400,000
Liverpool Gas Co.....	2,000,000
".....	3,000,000
LOUISVILLE GAS CO.....	1,500,000
Nunca Gas Co.....	100,000
PITTSBURGH GAS CO.....	1,500,000
PAWTUCKET, R. I.....	500,000
PORTLAND GAS CO., OREGON.....	502,500
SAN FRANCISCO GAS CO.....	4,000,000
Sheepbridge.....	40,000
ST. LOUIS GAS CO.....	2,000,000
Sydney Gas Co.....	2,500,000
WASHINGTON, D. C. GAS CO.....	2,000,000
Whitechurch Gas Co.....	175,000
Total.....	29,077,500

GEO. SHEPARD PAGE, No. 69 WALL STREET, NEW YORK,

SOLE AGENT FOR THE WESTERN HEMISPHERE.

R. D. WOOD & CO.,

400 Chestnut Street, Phila., Pa.

Cast Iron Gas & Water Pipe, Water Machinery & Gas Apparatus

Cast Iron Pipe, Fire Hydrants, Eddy Valves, Lamp Posts, Large Loam Castings, Flanged Pipe, Sugar House Work, Iron Roofs and Floors, Wrought & Cast Iron Tanks, Turbine Water Wheels and Pumps.

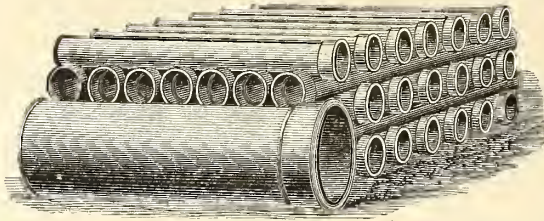

Casholders, Lime Trays, Center Valves, Purifiers, Bench Work, Exhausters, Condensers, Governors, Scrubbers, Gas Valves, Station Meters, Cast Iron Pipe Fittings.

Manufacturers of Heavy Castings and Machinery of Every Description.

ENGINEERS & CONTRACTORS FOR THE ERECTION OF GAS WORKS, & ALL MACHINERY CONNECTED THEREWITH

Estimates and specifications furnished for erection of new works or the extension or alteration of old ones.

Foundries and Works. - - Millville, Florence, and Camden, N. J.

SMITH & SAYRE MFG. COMPANY,

G. G. PORTER, Prest.

245 Broadway, N. Y.

CHAS. W. ISBELL, Sec'y.

Machinery & Apparatus for Gas Works

Drawings, Plans, and Estimates Furnished for the Improvement, Extension, or Alteration of Gas Works, or for the Construction of New Works.

Mackenzie's Patent Rotary and Steam Jet Gas Exhausters, Governors, Compensators, Condensers, Washers, Scrubbers. Isbell's Patent Automatic Street Pressure Governor, Gas and Water Valves, Hydraulic Main Dip Regulator, Bench Castings, etc. Purifying Boxes and "Standard" Scrubbers. Isbell's Patent Self-Sealing Retort Doors.

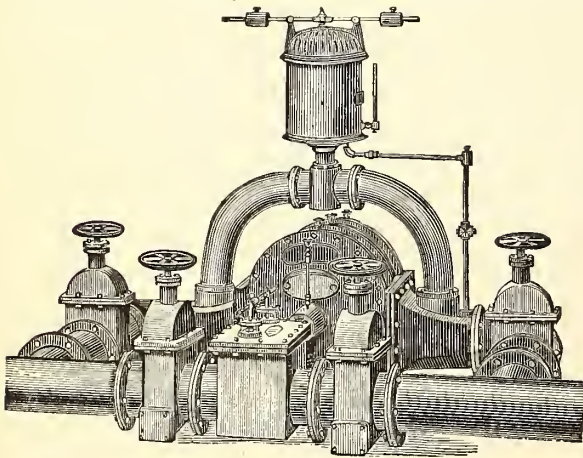

W. E. Tanner, Pres., W. R. Trigg, V.-Pres., A. Delaney, Supt.

Tanner & Delaney Engine Co.

RICHMOND, VA.

Gas Apparatus,

INCLUDING

Condensers of various styles, Scrubbers, Holders, Purifiers, Castings for Retort Houses, Etc.

ALSO STEAM ENGINES AND BOILERS.

Plans, Specifications and Estimates Furnished.

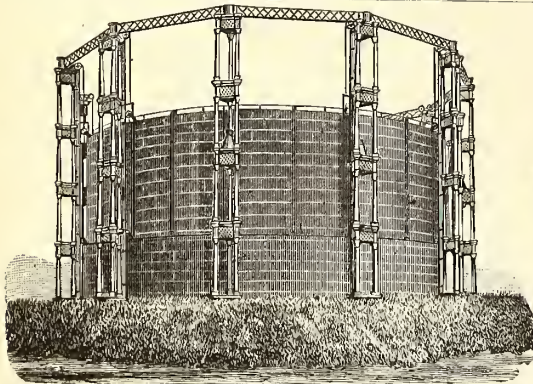

SOUTHWARK FOUNDRY AND MACHINE COMPANY,

Successors to MERRICK & SONS. Established in 1836.

No. 430 Washington Avenue, Philadelphia, Pa.

MANUFACTURERS OF

Single and Telescopic Gasholders,

BENCH CASTINGS,

Washers, Scrubbers, Condensers, Purifiers,

And all apparatus necessary for the construction of improved new gas works and in the extension of established works. Also manufacturers of

Gas Engines, and of all descriptions of Steam and Hydraulic Machinery, and of Boiler and Tank Work.

Plans, specifications, and estimates furnished promptly on application.

MORRIS, TASKER & CO.,

Limited,

Builders of Gas Works,

PHILADELPHIA, PA.

To Gas Companies.

We make to order CAP BURNERS to burn any amount under a stated pressure. Send for samples.

Also, SERVICE CLEANERS, DRIP PUMPS, and STREET MAIN PROVING APPARATUS.

C. A. GEFRORER,

248 N. 8th Street, Phila., Pa.

WM. HENRY WHITE,

Consulting & Constructing

Gas Engineer & Contractor.

ESTIMATES, PLANS, AND SPECIFICATIONS FURNISHED FOR NEW WORKS OR EXTENSIONS OF EXISTING WORKS.

32 Pine St., New York City.

Correspondence solicited.

KERR MURRAY MFG. CO.,

MANUFACTURERS OF

Single Lift and Telescopic GASHOLDERS.

Built, 1884:

Altoona, Pa.....	Capacity, 160,000 cubic feet.
Pittsburgh, Pa.....	" 250,000 "
" ".....	" 230,000 "
Bellaire, Ohio.....	" 50,000 "
Youngstown, Ohio.....	" 60,000 "
Canton, ".....	" 60,000 "
Akron, ".....	" 80,000 "
Xenia, ".....	" 10,000 "
Adrian, Mich.....	" 65,000 "
Ypsilanti, Mich.....	" 25,000 "
Muskegon, ".....	" 70,000 "
South Bend, Ind.....	" 70,000 "
Anderson, ".....	" 20,000 "
Plainfield, ".....	" 10,000 "
Springfield, Illinois.....	" 100,000 "
Evanston, ".....	" 50,000 "
Freeport, ".....	" 35,000 "
Elgin, ".....	" 60,000 "
Sheboygan Wis.....	" 20,000 "
Key West Fla.....	" 10,000 "

Plans and estimates furnished for the erection of new and the rebuilding of old works. Address

Kerr Murray Mfg. Co.,
FORT WAYNE, IND.

JAMES R. FLOYD,
(SUCCESSOR TO HERRING & FLOYD)

Oregon Iron Works,
531 to 543 West 20th St., N. Y.
Practical Builders of Gas Works,
MANUFACTURERS OF
ALL KINDS OF CASTINGS
AND
APPARATUS FOR GAS-WORKS.

BENCH CASTINGS
from benches of one to six Retorts each.
WASHERS: MULTITUBULAR AND AIR CONDENSERS; CONDENSERS; SCRUBBERS
wet and dry), and
EXHAUSTERS
for relieving Retorts from pressure.
BENDS and BRANCHES
of all sizes and description.

FLOYD'S PATENT MALLEABLE RETORT LID.
PATENT SELF-SEALING RETORT LIDS.
FARMER'S PATENT BYE-PASS DIP-PIPE.
SABBATON'S PATENT FURNACE DOOR AND FRAME.
BUTLER'S COKE SCREENING SHOVELS.

GAS GOVERNORS,
and everything connected with well regulated Gas Works at low price, and in complete order.

SELLER'S CEMENT
for stopping leaks in Retorts.
N. B.—STOP VALVES from three to thirty inches—
at very low prices.
Plans, Specifications, and Estimates furnished.

CONTINENTAL WORKS.

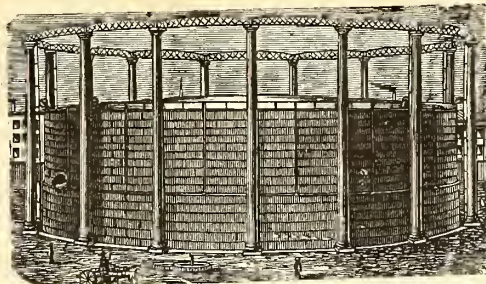

GASHOLDERS OF ANY MAGNITUDE.

T. F. ROWLAND, Proprietor.
GREENPOINT, BROOKLYN, N. Y.
ENGINEER AND MANUFACTURER OF
GAS-HOLDERS.
CONDENSERS, SCRUBBERS, VALVES,
PURIFIERS, RETORTS, and HY-
DRAULIC MAINS,
and all other articles connected with the Manufacture and Distribution of Gas. Plans and Specifications prepared and Proposals given for the necessary Plant for Lighting Cities, Towns, Mansions, and Manufactories.

H. RANSHAW, Prest. & Mangr. Wm. STACEY, Vice-Pres. T. H. BIRCH, Asst. Mangr. R. J. TARVIN, Sec. & Treas.

STACEY MFG. CO.,

MANUFACTURERS OF

Single and Telescopic Gasholders,

IRON ROOFS, BRIDGES, LAMP POSTS,

Water and Oil Tanks, Coal Elevator Cars,
COKE CRUSHERS, BENCH CASTINGS,

And all kinds of Wrought and Cast Iron Work used in the erection of Coal and Oil Gas Works.
Rolling Mill Machinery and Heavy Castings a Specialty.

Foundry: 33, 35, 37 & 39 Mill Street. **Wrought Iron Works:** 16, 18, 20, 22, 24 & 26 Ramsey Street.

Cincinnati, Ohio.

BARTLETT, HAYWARD & CO.,

Office, 24 Light.

BALTIMORE, MD.

Works, Pratt &

PURIFIERS.

Roofs.

Bench Castings.

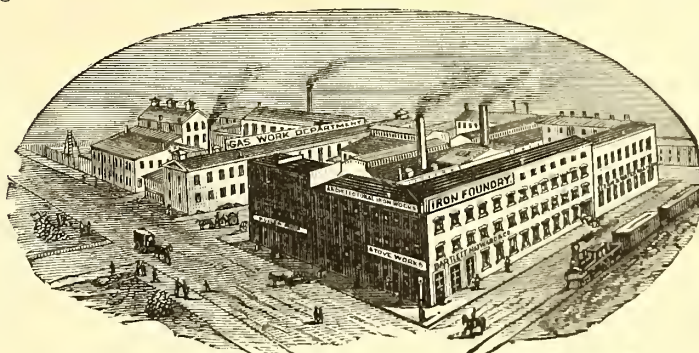

SCRUBBERS.

BOILERS.

CONDENSERS.

GASHOLDERS.

CONSTRUCTING ENGINEERS AND BUILDERS OF GAS WORKS.

1842. **DEILY & FOWLER,** 1885.

Laurel Iron Works.

Address, No. 39 Laurel Street, Philadelphia, Pa.

MANUFACTURERS OF

GASHOLDERS,

Single or Telescopic, with Cast or Wrought Iron Guide Frames.

Holder Built Since 1880:

- | | | | | |
|--------------------------|-----------------------|----------------------------|---------------------------|-------------------------|
| Mt. Joy, Pa. | West Point, N. Y. | Galveston, Texas (2d.) | Kalamazoo, Mich. (1st.) | Newport, R. I. |
| Rockaway B'ch, N.Y. (2) | Fitchburg, Mass. | Marlboro, Mass. | Glen Island, N. Y. | Portland, Oregon. |
| Zanesville, O. (2d.) | New London, Conn. | Denver, Col. | Warren, Ohio. | Allegheny, Pa. (2d.) |
| Lancaster, O. | Derby, Conn. | Chicago, Ill. (West Side). | Bath, N. Y. | Atlanta, Ga. (2d.) |
| Blackwell's Island N. Y. | Bridgport, Conn. | Pittsburgh, Pa. (S. Side). | Lynn, Mass. | N.Y. City (Central Ga.) |
| Waltham, Mass. (1st.) | Allegheny, Pa. (1st.) | Pawtucket, R. I. | New Bedford, Mass. | Lynchburg, Va. (2d.) |
| Dorchester, Mass. | St. Hyacinth, Can. | Brookline, Mass. | Waterbury, Conn. | Staunton, R. I. |
| Wheeling, West Va. | Norwalk, O. | Sherbrooke, Can. | Deseronto, Can. | Rosdout, N. Y. |
| Lansing, Mich. | Brattleboro, Vt. | Burlington, N. J. (2d.) | Hooole Falls, N. Y. (2d.) | Atlantic City, N. J. |
| Flint, Mich. | Waltham, Mass (2d.) | Bay City, Mich. | Bethlehem, Pa. | Augusta, Ga. |
| Galveston, Texas (1st.) | West Chester, Pa. | Erie, Pa. | Atlanta, Ga. (1st.) | Waltham, Mass. (2) |
| Milton, Pa. | Baltimore, Md. | Jackson, Mich. | Savannah, Ga. | |
| Scranton, Pa. | Hollidaysburg, Pa. | | Montgomery, Ala | |

GAS COALS.

GAS COALS.

GAS COALS.

JAMES D. PERKINS.

PERKINS & CO.,

F. SEAVERNS.

General Sales Agents for

The Youghiogheny River Coal Company's

OCEAN MINE YOUGHIOGHENY GAS COAL.

The Coal from the Ocean Mine (recently operated by Messrs. W. L. Scott & Co., of Erie, Pa.,) is now used by all the leading Gas Companies in the United States from Maine to Texas, and is recognized as *the only reliable Youghiogheny Gas Coal.* (See Map on p. 87 of this Journal, Feb. 16, 1885.)

P. O. Box 3695,
New York.

PERKINS & CO., 228 and 229 N. Y. Produce Exchange BEAVER STREET ENTRANCE.

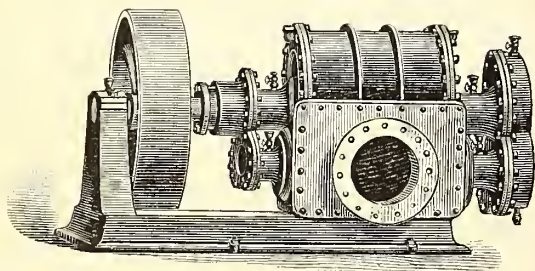

Gas Exhauster Driven by Belt.

The Wilbraham Gas Exhauster,

"BAKER SYSTEM,"

WITH ENGINE ATTACHED, ON SAME BED PLATE OR WITHOUT.

Best, Cheapest and Most Durable Exhauster known.

WILBRAHAM BROS.,

No. 2320 Frankford Avenue, Philadelphia, Pa.

CHURCH'S REVERSIBLE SCREEN FOR GAS PURIFIERS

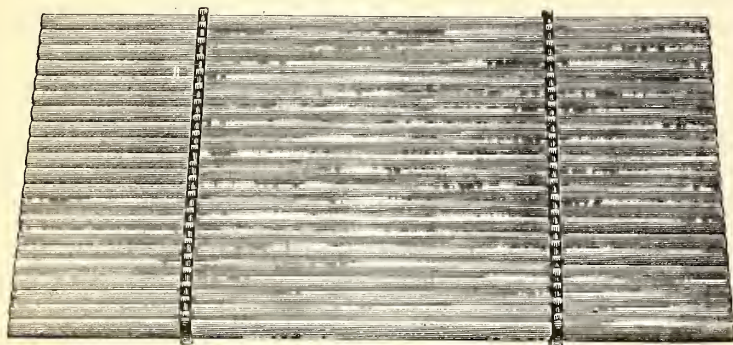

PATENTED JULY 9, 1878.

References in all parts of the country. Send for circular and list of companies who now have the Screen in use.

Very Durable
Easily Repaired.

Oval Slats, with
Malleable Iron
Cross Bars.

Apply to

JOHN CABOT,

LAWRENCE, MASS.

It will "Pay the Piper,"



If he aims to pipe well for STEAM, WATER, GAS, ACIDS, OILS, AMMONIA, &c., to examine this UNION, which requires no packing, but is always ready for instant use. When you next order Fittings of any Dealer, ask for a sample American Union to come with them, and it will tell you the whole story, or we will, if you write us for particulars.

PANCOAST & MAULE,
PHILADELPHIA, PA.

GAS CO. OFFICERS,

READ AND REFLECT.

Pipe Coverings.

Fireproof, Non-Conducting Coverings for

STEAM PIPES, BOILERS,
And all Hot Surfaces.

Made in sections three feet long. Easy to apply; light and cheap.

Asbestos Materials, Fibre, Braided Packing, and Cement. These goods are used at Continental Works, Br'klyn.

CHALMERS-SPENCE COMPANY, 419 & 421 EIGHTH ST., N. Y.



A new and important Pipe Fitting for Steam, Water, or Gas. Combining a variable angle or elbow and a union. Saves pipe, saves time, decreases friction and radiation, gives a union joint at every angle, and can be set at any angle at which it is desired to run the pipe.

HODGE'S SWIVEL FLANGE,

A common sense article, designed to save time and money.

MANUFACTURERS AND WHOLESALE AGENTS,

ROLLSTONE MACHINE CO.,

142 Water St., Fitchburg, Mass.

WM. FARMER, ENGINEER,
32 Park Place, Room 36, New York.

THE CHEMIST'S ASSISTANT; OR, KINDERGARTEN SYSTEM OF CHEMISTRY.

A system by which the elements and their valences are represented by illustrations and solid bodies.

BOX AND PAMPHLET COMPLETE, \$2.50.

JOS. R. THOMAS, C.E.,

May be Consulted on all Matters Relating to Gas Works and Gas Manufacture.

ADDRESS THIS OFFICE.

Iron Sponge,
GAS EXHAUSTERS,

AUTOMATIC GAS GOVERNORS,

CONNELLY & CO., Limited,
No. 407 BROADWAY, NEW YORK CITY.

GAS COALS.

Newburgh Orrel Coal Co.,

MINERS AND SHIPPERS OF

**Newburgh Orrel, Tyrconnell
and Palatine Gas Coals.**

ALSO SHIPPERS OF FOUNDRY COKE.

Mines Situated at

Newburgh, Flemington & Fairmont, W. Va.

HOME OFFICE,

25 S. Gay St., Baltimore.

**CHARLES MACKALL,
MANAGER.**

CHAS. W. HAYS, Agent in New York,

Room 92, WASHINGTON BUILDING, No. 1 Broadway.

Shipping wharves at Locust Point. References furnished when required. Special attention given to chartering vessels.

THE DESPARD COAL COMPANY

OFFER THEIR SUPERIOR

DESPARD COAL

To Gas Light Companies and Manufacturers of Fire Clay Goods
Throughout the Country.

ROUS EL & HICKS, } AGENTS. { BANGS & HORTON,
71 Broadway, N. Y. } 16 Kilby St., Boston.

Mines in Harrison Co., West Va. Wharves, Locust Point, Balt.
Company's Office, 15 German St., Baltimore, Md.

Among the consumers of Despard Coal we name: Manhattan
Gas Light Co., N. Y.; Metropolitan Gas Light Co., N. Y.; Jersey
City, (N. J.) Gas Light Co.; Washington (D. C.) Gas Light Co.;
Portland (Maine) Gas Light Co. Reference to them is requested.

WELSH "ABERNANT"

Silica Dinas Fire Brick & Cement.

Unrivalled for Endurance Under Intense
Heat. Percentage of Silica, 95.64.

Also SCOTCH "BLOCHAIRN" FIRE BRICK.

A. T. CHUR,

SOLE AGENT FOR THE UNITED STATES,

Mills Building, Room 14, Fifth Story, New York.

PRESERVE

The Journal

BY THE USE OF

THE STRAP FILE.

Advantages of the Strap File.

- 1st. It is simple, strong, and easily used.
- 2d. Preserves papers without punching holes.
- 3d. Will always lie flat open.
- 4th. Allows any paper on file to be taken off without disturbing the others.

Price, \$1.25. Sent either by express or mail, at directed. By mail the postage will be 20 cents, which will be added to the price of the Binder.

A. M. CALLENDER & CO., 42 PINE ST., N. Y.

GAS COALS.

GAS COALS,

THE

PENN GAS COAL CO.

OFFER THEIR

Coal, Carefully Screened & Prepared for Gas Purposes.

Their Property is located in the Youghiogheny Coal Basin, near Irwin and Penn Stations on the Pennsylvania Railroad, and on the Youghiogheny River.

Principal Office:

209 SOUTH THIRD STREET, PHILA., PA.

Points of Shipment:

Pennsylvania Railroad Piers; Greenwich Wharves, Delaware River; Pier No. 1 (Lower Side), South Amboy, N. J.

Chesapeake & Ohio Railway Coal Agency,

FOR THE SALE OF THE

**Superior Kanawha Gas Coals, Cannelton Cannel,
Also, SPLINT AND STEAM COALS**

From the Kanawha and New River Regions, on the line of the Chesapeake & Ohio R'way.

C. B. ORCUTT, Sales Agent. | OFFICE, 150 BROADWAY, N. Y.

FRANCIS H. JACKSON, PRESIDENT.

EDMUND H. McCULLOUGH, SEC. & TREAS.

THE WESTMORELAND COAL CO.

Chartered 1854.

Mines situated on the Pennsylvania and the Baltimore
and Ohio Railroads, in Westmoreland County, Penn.

POINTS OF SHIPMENT:

PHILADELPHIA, BALTIMORE, SOUTH AMBOY, N. J.
WATKINS (SENECA LAKE), N. Y.

Since the commencement of operations by this Company its well-known Coal has been largely used by the Gas Companies of New England and the Middle States, and its character is established as having no superior in gas-giving qualities, and in freedom from sulphur and other impurities.

Principal Office, 224 South 3d St., Phila., Pa.

The Management of Small Gas Works.

By C. J. R. HUMPHREYS. Price, \$1.

A. M. CALLENDER & CO., 42 Pine St., N. Y.

CATHELL'S

Gas Consumer's Manual.

Enables every gas consumer to ascertain at a glance, without any previous knowledge of the gas meter, the quantity and money value of the gas consumed. Also the best method of obtaining from gas the largest amount of its light. It will be to the advantage of Gas Companies to supply their consumers with one of these Guides, as a means of preventing complaint arising from their want of knowledge in regard to the registration of meters.

A. M. CALLENDER & CO., 42 Pine St., N. Y.

King's Treatise on Coal Gas.

The most complete work on Coal Gas ever published.

Three Vols. Bound, \$30.

A. M. CALLENDER & CO., 42 Pine St., N. Y.

**AMERICAN
GAS LIGHT JOURNAL.**

\$3.00 per Annum.

A. M. CALLENDER & CO

42 Pine Street, N. Y. City.



INTERNATIONAL--1876--EXHIBITION.

The U. S. Centennial Commission.

HAVE DECREED AN AWARD TO

HARRIS, GRIFFIN & CO.,

Twelfth and Brown Streets, Philadelphia, Pa., No. 49 Dey Street, N. Y. City, and No. 75 North Clinton Street, Chicago, Ill.,

FOR THE FOLLOWING REASONS:

The Exhibit consists of a Series of METERS from the Largest Size Station Meters for the use of the MANUFACTURE OF GAS, to those for the use of the ORDINARY CONSUMER. The Instruments are WELL MADE, RELIABLE as to INDICATION, and embody a number of sundry improvements which, with the general character of the Exhibit, entitle the whole to commendation.

Attest—J. L. CAMPBELL,
Secretary, pro-tem.Signed—A. T. GOSHORN,
Director GeneralJ. R. HAWLEY,
President

CHARLES E. DICKEY.

JAMES B. SMALLWOOD.

CHARLES H. DICKEY.

Maryland Meter and Manufacturing Co.,**DICKEY, TANSLEY & CO.,**

Established 1866.

Nos. 22 and 24 Saratoga Street, Baltimore, Md.

No. 46 La Salle St., Chicago, Ill.

MANUFACTURERS OF

DRY GAS METERS, STATION METERS, GLAZED METERS, TEST METERS, METER PROVERS, PRESSURE AND VACUUM REGISTERS, GOVERNORS, INDICATORS, SERVICE AND METER COCKS, AND METER CONNECTIONS.

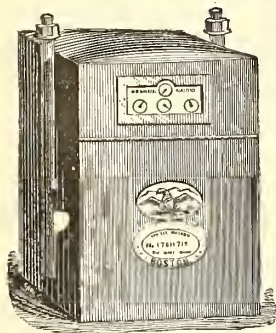

Dry Gas Meter.

With 39 years' experience and the best facilities for manufacturing, is enabled to furnish reliable work and answer orders promptly.

NATHANIEL TUFTS,

No. 153 Franklin Street, Boston, Mass.,

MANUFACTURER OF

DRY GAS METERS.

Station Meters of any Capacity.

Test and Experimental Meters, Pressure Registers, Pressure Gauges, Pressure and Vacuum Gauges.

METER PROVERS, PHOTOMETERS, STREET LANTERNS, ETC., ETC.

Patent Cluster Lanterns for Street Illumination.

SCIENTIFIC BOOKS.

We are prepared to furnish to Gas Managers, and others interested in the topics treated of, the following books, at prices named:

KING'S TREATISE ON THE MANUFACTURE OF COAL GAS. Three vols.; \$10 per vol.	GAS CONSUMER'S MANUAL, by E. S. CATHELS, C.E. 10 cts.	A PRACTICAL TREATISE ON GAS AND VENTILATION with Special Relation to Illuminating, Heating, and Cooking by Gas, by E. E. PERKINS. \$1.25.
GAS MANUFACTURE, by WILLIAM RICHARDS. 4to., with numerous Engravings and Plates, in Cloth binding. \$12.	PRACTICAL TREATISE ON HEAT, by THOMAS BOX. Second edition. \$5.	PURIFICATION OF COAL GAS, by R. P. SPICE. 8vo. \$3.
THE GAS ANALYST'S MANUAL, by F. W. HARTLEY. \$2.50.	GAS WORKS—THEIR ARRANGEMENT, CONSTRUCTION, PLANT, AND MACHINERY. \$8.	HOW TO MANAGE GAS, by F. WILKINS. Paper. 20 cents.
ANALYSIS, TECHNICAL VALUATION, PURIFICATION, and USE OF COAL GAS, by REV. W. R. BOWDITCH, M.A.; with Engravings; 8vo., Cloth. \$4.50.	COAL; ITS HISTORY AND USE, by PROF. THORPE. \$3.50.	THE GAS MANAGER IN THE LABORATORY, by a Practical Student. 8vo., Cloth. \$1.50.
GAS MEASUREMENT AND GAS METER TESTING by F. W. HARTLEY. \$1.60	THE GAS WORKS OF LONDON, by COLBURN. 60 cents.	THE DOMESTIC USES OF COAL GAS, AS APPLIED TO LIGHTING, by W. SUGG. \$1.40.
GAS CONSUMER'S HANDBOOK, by WILLIAM RICHARDS, C.E.; 18mo., Sewed. 20 cents.	THE GAS FITTER'S GUIDE, Showing the Principles and Practice of Lighting with Coal Gas, by JOHN ELDRIDGE. 40 cents.	DI STILLATION OF COAL TAR AND AMMONIACAL LIQUOR, by GEO. LUNGE. \$8.50.
	GAS WORKS, AND MANUFACTURING COAL GAS, HUGHES. \$2.20.	A TREATISE ON THE COMPARATIVE COMMERCIAL VALUES OF GAS COALS AND CANNELS, by D. A. GRAHAM 8vo., Cloth. \$3.
	THE MANAGEMENT OF SMALL GAS WORKS, by C. J. R. HUMPHREYS. \$1.	

The above will be forwarded by express, upon receipt of price. We take especial pains in securing and forwarding any other Works that may be desired, upon receipt of order. All remittances should be made by check, draft, or post office money order.

A. M. CALLENDER & CO., No. 42 Pine Street, New York.

T. C. HOPPER, Pres. G. J. McGOURKEY, Vice-Pres. (New York). WM. N. MILSTED, Gen. Supt. & Treas. (New York). WM. H. DOWN Sec.

AMERICAN METER COMPANY,

WET AND DRY GAS METERS. STATION METERS. EXHAUSTER GOVERNORS. DRY CENTRE VALVES. GOVERNORS FOR GAS WORKS.

PRESSURE REGISTERS. PRESSURE & VACUUM REGISTERS. PRESSURE & VACUUM GAUGES. CRESSON GAS REGULATORS. MARSLAND WATER METERS.

METER PROVERS. PORTABLE TEST METERS. EXPERIMENTAL METERS. AMMONIA TEST METERS. BAR AND JET PHOTOMETERS.

Manufactories:
 512 W. 22d St., N. Y.
 Arch & 22d Sts., Phila.

GAS STOVES,
 SUGG'S "STANDARD" ARGAND BURNERS,
 SUGG'S ILLUMINATING POWER METER,
 Wet Meters, with Lizar's "Invariable Measuring" Drum.

Agencies:
 177 Elm Street, Cincinnati.
 244 & 246 N. Wells Street, Chicago.
 810 North Second Street, St. Louis.
 122 & 124 Sutter St., San Francisco.

HELME & McILHENNY,

(Successors to Harris & Brother. Established 1848.)

GAS METER MANUFACTURERS,

CONTINUE AS HERETOFORE AT THE OLD ESTABLISHMENT,

Nos. 1115 and 1117 Cherry Street, Philadelphia, Pa.,

To Manufacture Wet and Dry Gas Meters, Station Meters, Experimental Meters, Meter Proviers, Center Seals, Pressure Registers,

GOVERNORS, INDICATORS, PHOTOMETERS, & ALL OTHER KINDS OF APPARATUS FOR USE IN GAS WORKS.

From our long practical experience of the business, and from our personal supervision of all work, we can guarantee all orders to be executed promptly, and in every respect satisfactorily.

WM. WALLACE GOODWIN, Prest. and Treas.

WM. H. MERRICK, V.-Prest.

S. L. JONES, Sec.

S. V. MERRICK, Supt.

THE GOODWIN GAS STOVE AND METER COMPANY,

Successors to W. W. GOODWIN & CO.

1012, 1014 and 1016 Filbert St., Phila., Pa. 142 Chambers St., New York.
 76 Dearborn St., Chicago, Ill.

WALDO BROS., Agents, 88 Water St., Boston.

MANUFACTURERS OF THE "SUN DIAL" GAS STOVES, FOR COOKING AND HEATING PURPOSES.

Dry and Wet GAS METERS, Station Meters (Square, Cylindrical or in Staves) Glazed Meters, King's and Sugg's Experimental Meters, Lamp Post Meters, Etc., Etc., Meter Proviers (sizes 2, 5 and 10 feet), Pressure Guages of all kinds, Pressure Registers, Pressure and Vacuum Registers, Pressure Indicators (sizes 4 inch, 6 inch and 9 inch), King's Pressure and Vacuum Gauges, Dry and Wet Centre Seals, Dry and Wet Governrs, Exhauster Governors, Photometers of all descriptions. Letheby's Sulphur and Ammonia Test Apparatus complete—also Testing and Chemical Apparatus of all kinds, and of the most perfect description, for all purposes relating to Gas.

GOODWIN'S IMPROVED LOWE'S JET PHOTOMETER.

Agents for Bray's Patent Gas Burners and Lanterns.

Special attention to repairs of Meters, and all apparatus connected with the business.
 All work guaranteed first class in every particular, and orders filled promptly.

G. B. EDWARDS, Mang'r, New York.
 E. H. B. TWINING, Mang'r, Chicago.
 A. B. STANNARD, Agent.

D. McDONALD & CO., GAS METER MANUFACTURERS.

(Established 1854.)

51 Lancaster St., Albany, N. Y. 34 & 36 West Monroe St., Chicago, Ill.

STATION METERS, EXPERIMENTAL METERS, METER PROVERS, PRESSURE & VACUUM REGISTERS, PRESSURE GAUGES, ETC.

Also STAR GAS STOVES, RANGES, and HEATING STOVES.

We use only the very best materials, and employ the most skilled labor, and by our long experience (29 years) and personal supervision of every detail, we feel justified in assuring the public that our goods will give perfect satisfaction. Every Meter emanating from our establishment will bear the State Inspector's BADGE, and will be fully warranted by us. Our Annual and Calendar will be sent to Gas Companies upon application.

KING'S TREATISE ON COAL GAS.

The most complete work on Coal Gas ever published. Three vols., bound, \$30.

A. M. CALLENDER & CO., No. 42 Pine Street, New York.

THE "OTTO" GAS ENGINE.

Guaranteed to Consume 25 to 75
Per Cent. LESS GAS than ANY OTHER GAS ENGINE
PER BRAKE HORSE POWER.

TWIN ENGINES Impulse every revolution.
THE STEADIEST RUNNING GAS ENGINE YET MADE.

ENCINES AND PUMPS COMBINED,

For Hydraulic Elevators, Town Water Supply, or Railway Service.

Special Engines for Electric Light Work.

OVER 15,000
IN USE.

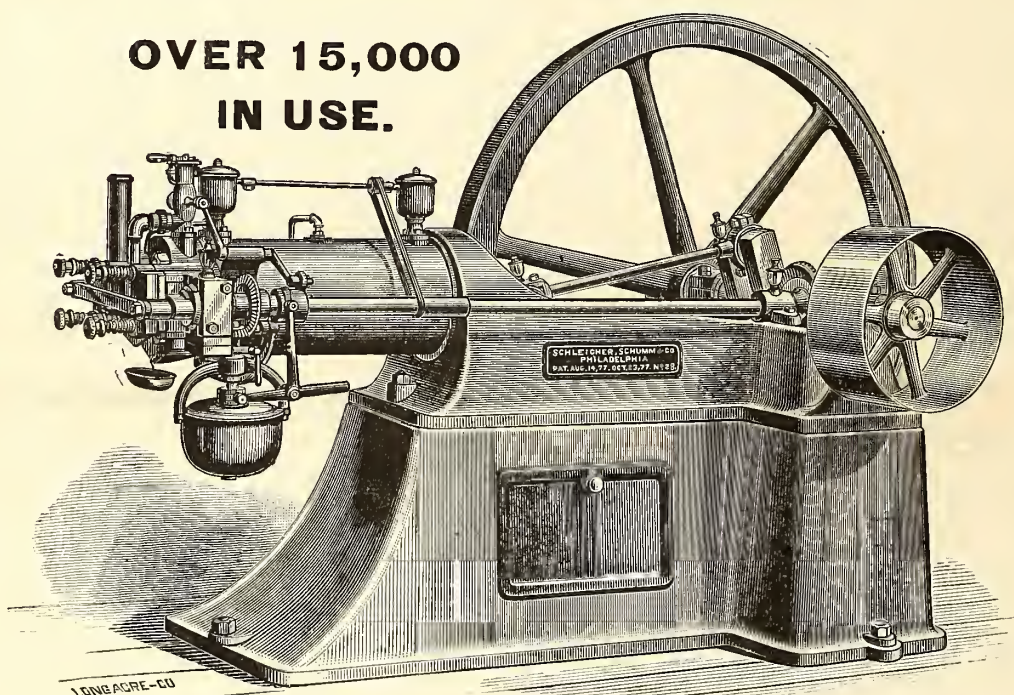

The Otto Gas Engine is now consuming, at a moderate computation, 2000 millions cubic feet of gas per year, nearly all of which is furnished during day time only.

**THE ONLY HIGHEST AWARD, ONLY GOLD MEDAL
AT ELECTRICAL EXHIBITION, PARIS, 1881.**

MADE IN SIZES FROM 1 TO 25 HP. INDICATED.

FOR PARTICULARS, PRICES, ETC., APPLY TO

SCHLEICHER, SCHUMM & CO.,

Works:

N. E. Cor. 33d & Walnut Sts., Phila., Pa.

Branch Office:

214 Randolph Street, Chicago, Ill.

THE AMERICAN GAS LIGHT JOURNAL

PUBLISHING OFFICE No. 42 PINE STREET

DEVOTED TO THE INTERESTS OF ILLUMINATION, VENTILATION, WATER SUPPLY AND DISTRIBUTION, & GENERAL SCIENCE.

VOLUME XLIII.—No. 5.
Whole No. 629.

NEW YORK, WEDNESDAY, SEPTEMBER 2, 1885.

\$3 PER ANNUM
IN ADVANCE.

A. M. CALLENDER & CO., Proprietors. C. E. SANDERSON, Manager.
JOS. R. THOMAS, C.E., Editor.

ENTERED AT THE POST OFFICE AT NEW YORK, N. Y.
AS SECOND CLASS MATTER.

Published on the 2d and 16th of each month, at No. 42 Pine Street, N. Y.

Terms of Subscription, Including Postage.—For the United States and Canada, \$3 per annum. European countries, \$3.50 (15 shillings—18 francs). All payments to be made in advance. Single copies, 15 cents.

Remittances should be made either by post-office order, registered letter, or bank draft on New York, payable to the order of A. M. Callender & Co.

Collections are invariably made directly from this office, for subscriptions, advertisements, etc. We have agents to solicit the same, but they are not authorized to receipt for money.

Correspondence.—Wishing to make this JOURNAL a gazette of intelligent discussion to those of our readers who may wish to gain or give information on the subjects to which its columns are devoted, correspondence is solicited for publication from all who make the study of those subjects a pleasure or a profession.

The American News Company, Nos. 39 and 41 Chambers street, New York, are agents for this JOURNAL. Newsdealers will send orders to them.

Books.—We will forward by express, at publisher's lowest rates, any book—scientific or otherwise—to any address in the United States or Canada. No books will be sent C. O. D.

CONTENTS.

An Asterisk (*) denotes an illustrated article.

OFFICIAL NOTICE—

Iowa Gas Association..... 113

EDITORIALS—

The "Novelties" Exhibition.....	113
A Good Specimen of the Lowe Incandescent Burner.....	114
The Chicago Gas Deal.....	114
The Market for Gas Securities	114
Eighth Annual Meeting of the Western Gas Association—Official Report—Concluded from page 92.....	115
Second Day, Afternoon Session—Natural Gas: Its Relation to the Gas Interest Generally, by J. M. Critchlow—Discussion—Question-Box—"Are stop-cocks and boxes, placed in service pipes, on the sidewalks necessary in towns where the daily gas output reaches 30,000 cubic feet?"—Dialogue in Answer—This and That from Europe, by Ernst Schinrock—Votes of Thanks—Adjournment of Business Sessions.	
The Klonne Regenerative Furnaces at the Greenock Gas Works....	118
Natural Gas in Plate Glass Manufacture.....	120
Coal Slag as a Building Material.....	120
Special English Correspondence.....	121
Boring for Natural Gas at Cleveland, Ohio.....	122
Technical Journalism.....	122

ITEMS OF INTEREST FROM VARIOUS LOCALITIES..... 123

An Item from Marshalltown, Iowa—The Gas Machine Man—A New Gas Company—The Fosterla (Ohio) Natural Gas Search—The Light of the Future a Thing of the Past—Street Main Mileages of Brooklyn (N. Y.) Gas Light Companies—Striking Lamplighters—The Cows were at Fault at New Orleans, La.—Ramsdell's Esthetic Taste—Personal—The "Interstate" Gas Company—Seeking Control—Cheaper Gas for Washington, Ohio—Victims to Kerosene—Suicide by Gas—Almost Completed—Natural Gas Discovered in Canada—Striving for Cheaper Gas at Green Bay, Wis.—This One not a Suicide—Killed by the Electric Current.	
Patents in Belgium and Austro-Hungary.....	126

[OFFICIAL NOTICE.]

Iowa Gas Association.

BURLINGTON, IOWA, Aug. 8, 1885.

To the Fraternity of the State of Iowa:

You are hereby earnestly invited to meet together on the third Wednesday (16th) of September, next, to complete the organization of the Iowa Gas Association, to confer together upon matters of interest connected with the gas business in this State, and to promote a more intimate acquaintance and fraternal relationship than has heretofore existed among us.

The meeting will be organized at 10 o'clock A.M., at the Barret House, where provision has been made for the accommodation of all.

Please be good enough to indicate by letter, addressed to the undersigned at an early date, of the acceptance of this invitation.

R. SPENCER, President.

THE "NOVELTIES" EXHIBITION.

The manufacturers of gas apparatus in the United States have no doubt given due heed and consideration to the "Novelties" Exhibition to be held in Philadelphia, Pa., under the auspices of that sterling body of men who compose what is known as the Franklin Institute; and we might further express the belief that the attention of every gas engineer in the country has also been attracted thereto. At any rate, it is no fault of the JOURNAL should a different state of affairs exist, for timely mention of its importance has appeared in our columns. Our gas engineers have complained, and with reason, that the American public has no just conception of how much it is indebted to the craft of the gas maker for a large and increasing percentage of its home comfort. But on the other hand, and granting that the gas purveyor has greatly contributed to such a desirable result, let us ask what has been done by the fraternity towards teaching the public that it has been so benefited? We are afraid we must assert that the effort has been slight. It is no argument to say, "Where could we derive any benefits from such attempts? Instead of looking at us through friendly eyes, they regard us as their plunderers." And they will so continue to view you unless an attempt is made to remove the clouds from their optics. Try it at any rate; and if your failure continues, you will at least have the satisfaction of knowing that it was not through lack of your own energy that the failure resulted. It may occur to our readers that this curt lecture seems rather out of place in an article referring to an exhibition; but a little reflection will show that such is not the case. Indeed it is quite pertinent to the subject, since if the gas engineers do not stir up the manufacturers of gas apparatus, the latter, or at least a number of them, may be inclined to let the Exhibition go by default. The "Novelties," as conceived by the managers of the Franklin Institute, is intended, in large part, as a means of educating the public. That it will be successful in this respect is measurably assured through a review of the success which attended the electrical exhibition of a year ago. Indeed the outcome of that display, in its effect as an educator of the public, was the real incentive that caused the Institute managers to renew their attempts through the medium of varying classes of exhibitions.

By all means let the gas men "punch up" their local manufacturers, and let the "punching up" process be repeated in case any manufacturer is obtuse enough not to see at first glance the great opportunity for advertising

his wares that will be presented by the proposed display. Many a gas engineer has perfected something or another that has been of great benefit to himself in his daily routine of work; and which, while necessarily possessing merit, in order that he could secure benefit from its use, has neither been patented, nor duplicated in the shop of any manufacturer. It is safe to claim also that such undescribed devices along with merit carry novelty. To these engineers we would say—bring out your devices and exhibit them at the "Novelties."

The doors of the Exhibition buildings will open on Tuesday, Sept. 15th, and will close on the evening of Oct. 31st; and if any intending participator has delayed his application to the "Committee on Exhibitions," let him be up and doing, for it is not too late. An entire outline of the course necessary to be pursued was given in our issue for June 16th, on pp. 316 and 317; and notice of same will also be found in our advertising columns of issues for July 2d and August 3d. It is our intention to give a detailed description of the exhibits at the "Novelties," and we hope that not a single one of our advertisers will be missing from the ranks of the exhibitors.

A GOOD SPECIMEN OF THE LOWE INCANDESCENT BURNER.

Those of our readers who are disposed to give attention to the appearance and working of the Lowe incandescent burner, and who cannot afford to spare the time involved in the making of a journey to Lynn, Massachusetts, may possibly find that the following details will relieve them from the necessity of going there at all. A close adherence to the instructions given cannot fail to result in the production of a close imitation of the Professor's "invention."

Take a piece of platinum wire (say No. 20), and carefully bend it into the shape of a horseshoe that will be about one and one-quarter inches across, and one and one-quarter inches in height. Then take another section of platinum wire (say No. 30) nine inches in length, and wind it closely around a rod having a diameter of one-eighth of an inch. Run the first loop through the helical coil, and secure the ends of loop and coil, by wire, at the top of a common burner near its tip, stretching the coil so that it will extend the entire length of the loop in even spaces. Place the loop parallel with the slot of the tip, and employ a two-foot tip. This plan will develop an almost exact reproduction of a Lowe incandescent burner.

Fill your test holder with a mixture of gas and air, allowing, say, one-half of each as the proportion, and intermix thoroughly; weight to four inches pressure; make the connection, and light the burner. The coil will speedily become incandescent, and perform lighting duty. The effect thus produced is exactly similar to that shown at Norristown, Pa., and later on at Lynn, Mass.

A mixture of gas and air identical with that in the supposed test holder mentioned above can be placed in the holders of medium sized works at a cost of 20 cents per thousand. In view of this, and with a knowledge of how to construct an excellent imitation of the burner, the superintendents of small plants would seem to be in a position where they can arrive at correct conclusions regarding the real value of the Pennsylvania Professor's latest "boon" to the gas industry of America. When the deductions are drawn it will be time enough to consult with the Professor in regard to the payment of royalties or the purchase of patent rights, etc.

THE CHICAGO GAS DEAL.

In the last issue of the JOURNAL it was stated that the Chicago City Council had granted a certain set of speculators, supposed to be working in the interests of the capitalists who control the fortunes of the Equitable Gas Light Company in New York City, a charter for the construction and operation of an opposition gas works in the Lake City. We also ventured the opinion, taking a fair survey of the state of gas matters in the aforesaid city, that it would be hard to figure out where the sagacity of the promoters made itself apparent. Later news shows that the newcomers propose to operate in the territory hitherto occupied by Mr. Billings, and known as the West Side. It appears that a prior ordinance had been passed by the Council, and the Mayor had allowed the same to become a law through lapse of time, instead of pursuing the usual course of affixing his signature thereto. Here follow the latest developments; and, giving as our authority the columns of the *Chicago Tribune*, date of Aug. 14, we herewith reproduce that newspaper's account of the same, which, we are informed, is substantially correct:

"All at once it turned out that the new ordinance was waste paper, as it was not drawn up in legal form, the enacting clause having been omitted. This technical but fatal defect had been made known to Mr. A. M. Billings, of the West Side Company, who complacently let the Aldermen have the trouble of passing the ordinance without lifting a finger to oppose it. He took good care, however, to have the fact that the ordinance was no ordin-

ance at all become well known in New York; and Mr. McGurren and his friends were about to conclude that they had worked in vain when it occurred to one of the leaders that it would be an easy thing to secure the passage of a perfect ordinance. The New York men were told it could be done, and were even furnished with a list of the Aldermen who would vote for it; and a contract was then and there entered into that they would pay \$85,000 for a 'controlling interest in the franchise within 24 hours after it had acquired legal force, provided the franchise was not "tinkered." The big four and the other combination went to work, and all went merry as a wedding-bell. An order was introduced to rescind the first franchise, and at the same time there was introduced a new one—this time in favor of the Equitable Gas Light Company of Chicago, under which name Everhart, Lomax, and Clare had taken steps to be incorporated. Two weeks ago last Monday the new ordinance was reported back to the Council, and was ordered, deferred, and published. This brought Mr. Billings to his feet. In the short speeches made on the ordinance in the Council it was plainly indicated that the new company meant to 'work' the West Side principally. Besides, it is more than likely that some of the Aldermen who do 'business' on their own account, and become members of either section of the 'ring' only for a 'job,' found it convenient to talk about the matter with Mr. Billings. The latter was anxious to prevent the passage of the ordinance, and a scheme was really concocted to have it die. Thursday evening, after the ordinance was introduced the Council met in adjourned session. In some mysterious way the gas ordinance was on the top instead of at the bottom of the pile of unfinished business, and the Clerk began to read it. But an Alderman objected to its being considered, as it had been deferred to the next regular meeting. No fuss was made at the time, and the managers went to work with a will to keep their men together. The next Monday the ordinance passed during the closing minutes of the session. Then Mr. Billings began to work, but found it was too late. He investigated matters in New York as well as here, and ascertained that the Aldermen were committed to the New York men, and that the latter had the power to make things very uncomfortable for certain parties if they were deceived; nor did he think he could outbid the new company; and as a last resort he gave to the Mayor all the points which the latter used in his message vetoing the ordinance. The managers in the Council were informed in good season of the Mayor's intention to veto the ordinance, and three Aldermen went to remonstrate with him. He told them he thought he ought not to approve of the ordinance, although he believed it would be passed in any event. The managers sent the word all along the line, and last Monday evening they had all the votes needed on hand. One member had intended to take a drive with a lady friend; but he was taken in charge by two colleagues, who spoiled his drive and kept him in his seat until the ordinance was passed over the Mayor's veto. Another was sick and hardly able to sit up, but he had to be present to maintain his 'rights.' The ordinance did pass, and before 24 hours had gone by the franchise had been transferred to the control of New York capitalists, and \$85,000 of the latter's money was paid out to the lucky fellows whom the Aldermen had presented with a fortune. It would be against all precedent if they were to prove forgetful of the 'kindness' shown them, especially as they would never have dreamed of becoming directors in a gas company but for the 'generous impulses' of certain Aldermen."

All of which furnishes interesting reading, despite the fact that it reveals a goodly share of "crookedness." The "New York men" may count on a lively reception at the hands of Mr. Billings when the actual struggle begins; and "as it is with the Consumers Company so may it be with the Equitable." We understand it is the intention of the "New York men" to capitalize the results of their purchase on the basis of three million dollars of stock, and two million dollars of six per cent. bonds, and that a certain Mr. W. Brenton Welling, with headquarters at No. 18 Wall street, this city, is engaged in an attempt to permit intending investors to effect an entrance on the "ground floor."

The Market for Gas Securities.

Dullness continues to be the prominent feature in the market for city gas shares, although Consolidated stock rather unaccountably developed surprising weakness on the light trading for the fortnight. At time of writing (noon, Aug. 31), the bid price is 92, holders demanding 93. As before stated this decline is unexplainable, as the corporation, on its average output during interim of last dividend is earning at the rate of eight per cent. or more on its capital. We know it to be a fact that those high in authority in the management of the company advise investment in Consolidated shares. Equitable, of New York, is at same prices as those previously quoted; Mutual is steady to strong. Brooklyn shares preserve their tone, but transfers are few and far between. We note that Baltimore Consolidated has declared, and will pay on Sept. 15th, a dividend of 1½ per cent. This has had the effect of adding 5 points to the value of the shares.

For regular list of quotations, see page 126.

[OFFICIAL REPORT—Concluded from page 92.]

Eighth Annual Meeting of the Western Gas Association.

HELD AT THE TREMONT HOUSE, CHICAGO, ILLS., MAY 13, 14, and 15, 1885.

SECOND DAY—AFTERNOON SESSION.

On motion of Mr. Printz, the thanks of the Association were extended to Mr. McMillin for his paper on "Natural Gas," after which the Chairman suggested that (as Mr. J. M. Critchlow, of Beaver Falls, Pa., had presented a paper on the subject treated of by Mr. McMillin) the second communication be read before the discussion be proceeded with. This was agreed to. Mr. Critchlow's paper had the heading of—

NATURAL GAS: ITS RELATION TO THE GAS INTEREST GENERALLY,

and is as follows:

Gentlemen:—A person situated as I am, with the roaring and hissing of the burning natural gas constantly ringing in his ears, as it blows through a six-inch safety valve, at a pressure of 60 pounds per square inch, even after having traveled over a distance of some eleven miles, up hill and down dale, crossing both the Ohio and Beaver rivers, and along its line having supplied the exclusive fuel for several thousand fires, burning not alone in dwellings, but also in glass works, brick kilns, potteries, steel and wire mills, etc., etc., would naturally be more or less inspired by his subject. Natural gas, as found in New York, Pennsylvania, and West Virginia, varies somewhat in specific gravity, chemical composition and illuminating power.

The incorrect idea is prevalent that the specific gravity of natural gas is much greater than that of coal gas, or even of air. Haswell gives carburated hydrogen at 0.559, and coal gas from 0.438 to 0.752; whereas tests made by Professors Wurtz, Sadtler, Fouqué, and others, on samples of gases from eight of the largest and the best wells within the territory referred to, give the specific gravity from 0.45, at a well in Warren County, Pa., to 0.693 at West Bloomfield, N. Y. The famous Murraysville wells, which supply a large part of Pittsburgh, Pa., are given between the extremes at 0.56. In fact there are only one or two records given that show instances of greater gravity. The one I have been able to find refers to a well in Venango County, Pa., where the figure is put at 1.51.

In comparing analyses of 12 "roarers," marsh gas, (CH₄) predominates in all, varying from 60.27 to 96.50 per cent. Carbonic acid is almost invariably present, but generally in small quantities, or from 0.34 to 3.64 per cent. This latter assertion I may qualify somewhat by instancing two notable exceptions. One of these is in West Virginia, where 15.86 per cent. is developed; the other, or second, is afforded by a New York State well, where over 10 per cent. of carbonic acid is found in the gas. Carbonic oxide is barely traceable. Oxygen, hydrogen, and nitrogen, are not always present; but either each or all occasionally appear. The proportion of oxygen varies from 0.23 to 2.20 per cent.; hydrogen from 4.79 to 22.50 per cent.; and nitrogen from 4.31 to 7.32 per cent. No trace of sulphur is on record in the territory referred to.

The illuminating power of natural gas, when consumed through an ordinary open tip, is about one-half that afforded by coal gas. This assertion is variable, however, as to location—the illuminating value improving as the well line from West Virginia to northern New York is followed. Newspapers have, from time to time, teemed with discussion as to whether or not natural gas possesses an odor. As a rule, it undoubtedly does. The smell may easily be mistaken for that coming from the vapors of naphtha.

Carefully-conducted experiments have shown the calorific value of natural gas to be greater, foot for foot, under the same pressure, than hydrogen, carbonic oxide, or water gas; and also less than that of coal gas.

In its relations to the gas interest generally, I take it that it is, or will be, advantageous in several directions. It is doing us much good by educating the public up to the fact that the fuel of the future, and the solution of the smoke nuisance, is gas—natural or manufactured. For instance, Pennsylvania alone now contains almost 200 chartered natural gas companies, representing a combined capital of \$2,500,000. The consumers of the product of these companies pay from 2 cents to 20 cents per thousand cubic feet; but are, with rare exceptions, so well pleased that they would pay double, and, in many cases, three or four times as much rather than go back to the use of coal. The influence of this feeling is carried in all directions; and will result in our established gas plants devising means and ways to supply gaseous fuel at profitable prices. Coal gas plants have no need to be discouraged even now in this respect. It takes 293 feet of hydrogen, or 313 feet of carbonic oxide, to accomplish that which 94 feet of natural gas, or about 70 feet of coal gas will perform. By this showing, 1,000 feet of coal gas, at about \$1.07 per 1,000, is as cheap to the fuel consumer as the same amount of water fuel gas at 25 cents. In reference to the utility of natural gas for illuminating purposes, I am able to say that it is at the present time a success as converted and enriched at the Beaver Falls, Pa., gas works. We

had been making 22-candle "Lowe" gas for three years. We have been using natural gas entirely (with the added naphtha enricher) since February 2, 1885, with the greatest satisfaction to ourselves and consumers.

The only change made necessary away from the works was the altering of the 6-foot water gas tips to threes and fours—in fact the same tips that gave satisfaction with coal gas do so now under our present mode of manufacture.

The most interesting feature of this subject to our company is the economy and healthfulness of the new plan. We pay 10 cents per thousand for the crude natural gas, and then effect a saving of 20 cents per 1,000 over the cost of gas as manufactured under the so-called water process.

Heretofore we could not tap a main with the pressure on without laying up one or two men from headache; now, one man can take his time and tap a 1½-inch hole under three inches pressure, if need be, with no inconvenience whatever.

Discussion.

Prof. S. H. Douglas—I have had much to do with natural gas all my life. Reference is made in Mr. McMillin's paper to my native town. I was there when the gas well alluded to was first opened up; and when I left that town it was still lighted by the gas obtained from a well sunk in the bituminous shale. I think I have some views which perhaps may be of value to gas men as to the durability of these Ohio wells. I have but little confidence in their stability. I think the gas there is generated in small fields, and that the reservoirs extend only over small districts. I incline to the view that it is only a question of a few months, or years at most, when every one of the wells will fail. On the other hand, with reference to the Fredonia wells, I will say that they have been in duty, I should think, in the neighborhood of fifty years. I can barely recollect the time when they were first discovered. Gas has flowed from them in limited quantities—at times the flow almost disappeared. Various wells were sunk which would flow for a short time and then die out. As an illustration of the unevenness of the flow I may state that a friend of mine once made a contract with the Government for lighting the lighthouses at Dunkirk and at Cortlandt. He proposed to light them with natural gas. The gas was laid on to the lighthouse structures, but in a few months the supply failed completely, and the leaden conduits were removed. I remember very well it was a common thing for the boys at the time to uncover the pipe (it was near the surface) with the object of securing lead for making bullets. The experiment in lighting with natural gas was a perfect failure. Then, again, at a Fredonia hotel, the owner of which while sinking a well struck the gas, and thought he could turn it to account in the lighting of his building. A holder was erected, and the gas was conveyed to the hotel; in a few days the supply failed. Taking it all in all (notwithstanding Mr. McMillin seems to have somewhat different information), up to the present time natural gas wells have been short lived. They are not to be relied upon for any length of time. I am familiar with the operations of the gas plant that supplies Fredonia. This plant was partially supplied with gas from the wells. It was designed, when the works were constructed, that they should derive the entire revenue from this source; but the owners soon found that these wells would not give off enough gas to supply the needs of the town. The plant was pieced out by the construction of a coal gas works to act in connection with the natural gas. This should give proof that the flow of natural gas is unreliable. I think the Fredonia experience, where experiments in connection with this subject have been made for over fifty years, will apply to all the natural gas districts of the country. Then, again, as to the manner in which the gas is generated—whether it is of animal or vegetable origin. I may claim that this question is far from being settled. My own impression is that the vegetable theorists have the better of the argument. Its origin and that of coal oils may be traced to the same source.

Mr. McMillin—I do not think the coal oils are purely vegetable oils.

Prof. Douglas—They are somewhat mixed, perhaps.

Mr. L. K. Seofield—What are the ordinary features of gas wells?

Mr. McMillin—It depends upon what strata they start from. They have to get down to a certain geological horizon; and that may be reached at a depth of 4,000 feet, or it may be encountered at 300 feet. It depends upon how much material rises above the geological horizon where the gas is generated.

Mr. Seofield—Considerable interest in the development of or search for gas wells has recently been manifested in the State of Kansas. At our city of Fort Scott, some 12 or 15 year ago a gas well was struck, and it is flowing now. The output is limited in quantity. When the gas vein was first tapped it was encountered by miners sinking for coal—at least so the story goes—who had reached a depth of 270 feet. It is said that the initial flow was very large, and its strength continued for a year or two. The managers of the gas company, who had at about that time constructed their works, obtained control of the well and plugged it up, with the object of doing away with possible competition. The well is filled with water, but there is a flow of gas through it that is conducted out through a pipe, and the supply is sufficient to operate four or five burners consuming six feet per hour.

It is more than 300 feet in depth. Judging from this well, many have thought that a large gas reservoir existed beneath the soil of our locality; and finally this belief grew so strong that last fall some hardy spirits organized a company for the purpose of developing the home natural gas industry. They went down 625 feet, but did not strike gas. They did uncover a well of mineral water, and are not yet discouraged, since they propose to "sink" again in their efforts to demolish the "gas monopoly."

Prof. Douglas—My impression is that the stock in neither company will ever be very valuable. Natural gas, as we know in many cases, is of vegetable origin. I have in mind a case near Detroit, Mich., where a Frenchman dug a well through a deposit of peaty or vegetable matter. He got down about two feet with the well-hole, when he struck a gas vein. The gas came pouring out in large quantities, and he jumped out of that hole as quick as was possible. In some way or another the gas became ignited and exploded, and then burned fiercely in the well bottom. He became greatly frightened, and, in his alarm, filled up the well in great haste. The Rev. Dr. Duffy, who had a great taste for natural science, heard of this circumstance, and visited the place for the purpose of finding out all about the occurrence—the strength of the flow, likelihood of durability, etc. He saw the Frenchman and tried to prevail upon him to have the well reopened; but that individual said, "No; because he knew the well led to the infernal regions." Nothing would induce him either to explore it himself or to consent to its being explored. That was the last of that well. Another well was opened in the district some three or four years ago. At first a great flow of gas was obtained, and a company was organized for the purpose of conveying the output to the city of Detroit, where it was proposed to use the natural gas in the lighting of that city. The supply speedily gave out, and so ended the project. I think, to a certain extent, that will be the case with every one of the Pennsylvania wells, and natural gas wells generally. They will flow for a time and then cease. They are not durable. As to natural gas affecting gas stocks—or gas consumption—that is out of the question entirely. No such result can happen.

Mr. McMillin—It is in regard to the question of the origin of gases that I differ with Prof. Douglas. I would heartily enjoy a discussion on that subject with him; yet, while that is the main point of difference between us, I also make bold to say, should we conceive the idea that we are not likely to meet with any competition from natural gas, we would be deceiving ourselves. In the Pittsburgh region, during each 24 hours, the natural gas wells supply over ten times the quantity of gas that is sent out from the works of the companies sending representatives to this meeting of the Western Association. Owners of huge factories in the Pittsburgh district have expended large sums of money in fitting or adapting their plants to the use of natural gas; and, being business men, and clever ones too, I think I am justified in making the claim they would not make these great outlays unless they were measurably certain that the new fuel sources were permanent. The company I have named in my paper has been using natural gas for ten years.

Prof. Douglas—Still, all the statistics tend to show that the gas supply is not permanent.

Mr. McMillin—I do not concede that, speaking for the primal supply. When the flow from one well-hole fails a new supply is secured by sinking a new hole. Let me call attention to another fact—many of the wells that had ceased flowing, or whose flow had become feeble, upon being cleaned out, were revived or renewed. How do we know but that such may or should be the history of all of them? They may have been clogged up by paraffine accumulations. At Pittsburgh some 50 or 60 millions cubic feet of natural gas is sold every 24 hours; and I should judge that a much larger quantity than that consumed is wasted every day. In the section or territory where the wells are driven the country, for miles around, is illuminated by huge torch-like fires of flame that are simply the result of the ignition of the escaping gases from unemployed wells.

Prof. Douglas—What is the history of the Erie, Pa., gas wells?

Mr. McMillin—I do not know; I did not go there; but I do know that the facts given in my paper represent the latest information that can be gathered on the subject. The Commission referred to by me was appointed by a Pittsburgh Court, and it has now been in session during a great many months. They had all sorts of "experts"—pipe layers, chemists, engineers, and mechanics—representing almost every class or profession, before them. Only a portion of the testimony gathered has been made public; but in due time a full report and history of the examination will be published. It should furnish most interesting reading. The advance which has been made, since the day or time when Prof. Douglas and his playmates were "hooking" lead pipes for the purpose of moulding them into bullets, is as great in the natural gas field as it has been in our own coal gas industry.

A Member—I paid a visit to Vandalia, Ohio, the other day, and during a conversation there with a friend we discussed the natural gas question—my friend was a resident of Vandalia. I was much surprised when he said to me that he would not have the natural gas in his house.

Mr. McMillin—I would not use the Vandalia gas either, and because that gas contains such a large proportion of sulphuretted hydrogen. They make no attempt at purifying the Vandalia gas, neither do they measure the amount consumed. They supply the gas at so much per month, and a consumer may burn all he pleases. The gas there issues, I think, at a pressure of 200 pounds. I did not see the gauge on, but my impression is that the pressure was very great. Wells have been flowing at East Liverpool, Ohio, for 20 or 25 years. There are many places where wells have been flowing constantly. There have, no doubt, been thousands and tens of thousands of failures, but the failures are attributable to the fact that the wells have not been properly located; and here comes in the importance of Prof. White's discovery. If they are not properly located they will not last long; and it is true that their life may not be great even if they are rightly placed. Short or long lived the fact remains that the money paid out for natural gas in Pittsburgh (even at the low prices at which they are selling it) amounts to a good many thousands of dollars each 24 hours.

A Member—At the town of Lima, Ohio, a bore-hole has been sunk about 1,300 feet. At 900 feet depth oil was encountered. I should like to see them get natural gas there.

Mr. McMillin—Where they get plenty of oil is not a good place to get natural gas. They are boring in the wrong place.

A Member—The Lima folks seem very much discouraged about it. They fear they will not secure much gas after striking such a plentiful oil streak. At Vandalia they did not get much oil; but they did get a good supply of gas.

Mr. McMillin—I am not well informed as to the geological formation in the neighborhood of Lima; but my impression is that you would have to go a great deal deeper to reach the horizon there than at the Vandalia and Bowling Green ridge. I think at Lima you are just in the Huron shales, and that going down through those shales you might encounter light veins of oil and gas all the way down. There is not sufficient covering over the Huron shale to make a good store-house for the gas; and that is also one reason why the wells at Fredonia, N. Y., and at Lima, Ohio, are not fit illustrations when estimating the life of a natural gas well. They have only about 300 feet on them, whereas the good wells at Pittsburgh have over 2,000 feet of covering. At Vandalia you would have to pierce the thickness of the Huron shale, and 1,500 feet in addition, thus showing that, as between Vandalia and Lima, the drills would have to sink 1,500 feet deeper at the former than at the latter place in the effort to reach the same geological horizon.

Prof. Douglas—Have you made inquiry as to the gas wells near Rochester, N. Y.?

Mr. McMillin—No, I did not. At Bradford, Pa., I think they bring some of their natural gas supply over a distance of 20 miles. In that town with its small population, they sell three million feet of natural gas every twenty-four hours.

Mr. Baxter—Has the first well that was opened in that vicinity given out?

Mr. McMillin—No; it has failed a little, but is still a good well.

Mr. Baxter—It has been in operation now about 14 years. I was with the Alleghany, Pa., Company at the time they first analyzed that gas by means of special test. I was with Mr. Young and Prof. George Hall when they made the experiments, and these (as nearly as I can remember) gave evidence that the illuminating value was about $7\frac{1}{2}$ candles.

Mr. McMillin—The illuminating power of natural gas is quite surprising to me. The gas men have been in the habit of attributing all the light they get to three, four, or five per cent. of illuminants they have in their gas. At Vandalia the illuminants figure but $1\frac{1}{2}$ per cent., and yet their gas is as good as any coal gas. The gas from the wells about Pittsburgh contains but a trace of illuminants; still, it gives seven or eight candle power with the ordinary burner, and 13 or 14 with the Argand.

Mr. Smith—What is it that gives the light?

Mr. McMillin—I think it is the heating of particles of carbon in combination with hydrogen. The hydrogen burns, we know; but if only the hydrogen burns, we have always supposed that the carbon would give us some light; yet these gases that have no illuminants will develop thirteen or fourteen candles in an Argand burner. Bradford gas develops an illuminating value of about 24 candles in the Argand; but that gas comes from the great oil regions, or where the gas all comes off of the oil, and carries rich benzine vapors with it.

Mr. Eugene Printz—About eighty miles from Columbus, Ohio, there is a natural gas well that has been flowing strongly for some 25 years.

Mr. McMillin—That well has been flowing since 1814.

Mr. Printz—My memory will not go quite that far back. (Laughter.) My first remembrance of the well was when they were using the gas in the making of steam for the purpose of operating an engine to pump the water from salt wells in the neighborhood. They afterwards dispensed with the boiler, turned the gas right into the engine, and drove it at a pressure of 60 pounds to the square inch. It was conveyed to the point of use through a $2\frac{1}{2}$ -inch

pipe. Some gentlemen from Meadville, Pa., have purchased the farm on which the well is located, and are now preparing to supply two neighboring villages with fuel gas.

The President—I wish to say a word or two on this natural gas question. Some twelve years ago five or six of these wells were struck in the central part of the State of Illinois, and the way in which their discovery was made was this: For a great many years the water in the wells on the farms in that part of the country would disappear during a drought, and the farmers conceived the idea of sinking them deeper, in the hope of finding a more stable source of supply. During the sinking they found that at a depth of 100 feet gas was encountered. It was a very light marsh gas, and quite a number of the residents fitted up their houses for its employment as a lighting agent. It burned very nicely when allowed free vent, but gave no light of any consequence when passed through a burner tip. After four or five seasons of wet weather the water rose in the ground again and filled up all the streaks where this gas seemed to lie hidden, and the flow gave out. It reappears, though, during extremely dry seasons. It had no perceptible smell, and did not contain a trace of sulphur.

The discussion upon natural gas was here brought to a close, and the Chairman stated that the regularly contributed papers had been read and disposed of. He further announced that a member had submitted the following question:

“Are stopcocks and boxes, placed in service pipes, on the sidewalks necessary in towns where the daily gas output reaches 30,000 cubic feet?”

He hoped the members would supply the asked-for information. In reply to the intimation the following dialogue took place:

Mr. W. Clark—A year or two ago I started making gas in a new plant in a Southern city. The town had been piped and services had been put in before I assumed charge. They put in no sidewalk cocks; and the omission was a decided nuisance. When we turned on the gas we found that half the “plugs” in town had been removed; and for a time we had no control over the supply. We first tried air pressure on the mains to find out if they were leaky, but soon discovered that the trouble arose from the uncapping of house services. We sent out our workmen and had the caps replaced. In the case of a burning building we certainly want cocks and boxes. I cannot, indeed, imagine how a gas company could get along satisfactorily without them.

Mr. V. L. Elbert—At Jackson, Mich., during the last year we came to the conclusion that all services over an inch in diameter should be fitted with sidewalk boxes. The plan is desirable, provided the stopcock is fitted in a good box, well covered.

Mr. Howard—For my part, I believe that stopcocks on sidewalks are perfect nuisances. They are not reliable; they gather frost, and generally stop up the services more or less—especially in very cold climates. You may take a stopcock and set it carefully in position; but allow it to remain in place for three or four years, and I defy you to turn it. I have taken out plenty of them in our town; but in order to get them out I have had to wrench off the top of the plug before I could turn it.

A Member—Do you use iron?

Mr. Howard—No; we use brass. If you take into consideration the amount of gas you would lose in consequence of a single fire, through not being quick enough at the scene of conflagration to shut off the gas, and then consider the inconvenience from frost and the cost incurred, you will probably find that you can stand two or three fires, with their consequent loss of gas, rather than bear the expense of sidewalk stopcocks.

A Member—Where do you turn the gas off?

Mr. Howard—At the meter.

Mr. Z. T. F. Runner—At Freeport, Ills., we have laid our services, at least in the last few years, without stopcocks. Under the former practice we were troubled more or less with leakage at the cocks, and found that after being laid a few years we could not turn them. In case of fire, I could get a monkey wrench in any hardware shop and turn off the gas in one-half the time that it would take to get a key and turn it off at the stopcock on the sidewalk.

The President—For the last seven years I have never put services in without putting in stopcocks, and have never had any difficulty in shutting them off in case of fire. We put in iron boxes along with them. Some time ago, or when we used a light stopcock, we found difficulty in turning them; but since we began putting in heavy ones we have had no trouble. I would not put a service in for anybody without placing a stopcock and box. We have no trouble from freezing. Our thermometer registered 20° below zero last winter, yet we did not have any trouble from frost in the boxes.

A Member—For twenty-five years we have done without them, and do not propose to make the experiment now. It will not pay.

Mr. L. K. Scofield—At Fort Scott, Kansas, the consumers pay for stopcocks when put in. They are, it seems to me at least, of no particular benefit; and they are expensive arrangements when properly constructed.

The President—My opinion is that this question hinges solely upon the output of the works. I think they are desirable in all large cities, and should be employed in all cases where the send-out reaches 100,000 cubic feet per day. That has been my experience as the result of observation gained in the handling of thirteen different works. I have put them in even where the production was inside of 25,000 feet per day. In a city like St. Louis we could not get along without them. It is sometimes the only way in which we can secure the settlement of our accounts. The trouble with them in a great many of the smaller towns arises from the fact that oftentimes the sidewalks are made of planks; and in the change of grades the boxes get filled up with dirt and stones, so as to render it impossible to open them.

The President next announced that the Secretary had received a letter addressed to the Association from Mr. Ernst Schinrock, under date of Brussels, Belgium, April 29, 1885. It was headed

THIS AND THAT FROM EUROPE,

and the President suggested that now would be an appropriate time for its presentation. No objection was offered, and Secretary Littleton read as follows:

Mr. President, and Gentlemen of the Western Gas Association:—As I am interested in the welfare of some Western gas works, I have made it a business during my present visit to the Old World to institute some investigation into the management of European gas works, in the attempt to discover if, by introducing some of their improved methods in the carbonization of coal, and adopting their ways of selling gas, I could benefit you in the West by a recital of the experience so gained. This I may do should I succeed in proving to you that it would be profitable for you to become European imitators without asking you to experiment on your own companies' individual accounts.

The use of regenerative furnaces makes rapid progress here; and perhaps I may say the best ones—viz., the most economical in their construction and most efficient and durable in their action—are considered to be the specimens employed by Mr. Hunt at the Birmingham (England) gas works, where they charge every six hours, use through retorts 20 feet in length, and employ only from 14 to 15 per cent. of the coke for fuel purposes. These through retorts have already been introduced in Cincinnati, Ohio, by General Hickenlooper, upon the recommendation of a gentleman well qualified to know.

Belgium, the country of economy, claims also to have a very good furnace, as used in Gand and other towns. The furnace is cheap and compact, and the firebox is so constructed that only a certain amount of coke can be burned during 24 hours. Gas works that employ this system will use different quantities of coke, according to the number of charges made in one day. This furnace can be recommended to those who are considering the matter of the reconstruction of old benches, since its installation may be cheaply accomplished.

Germany has quite a number of systems of furnaces. They were the first to make them work well in practice, but they were very dear, and are still expensive. The construction has been simplified through the studies of English and Belgian gas engineers.

German gas engineers like to introduce their own designs; and this little weakness may explain the fact that there are still many old benches at most of the German gas plants. Prof. Schilling's, August Klönne's, and the Stettin specimens of furnace make but little headway among their own countrymen. The superiority of regenerative furnaces is best illustrated by the following fact: The city of Cologne built a new works in 1876. There were then constructed 40 ovens on the old and 40 furnaces on the generator style. The superiority of the latter was so marked that they replaced 60 old ovens, and therefore the 40 old ones were scarcely used at all. Since that time Mr. Hegener, one of the ablest gas engineers in the world, has improved his furnace so far that he has left over for sale (deducting the coke used for heating the retorts) 580 to 600 kilos. from each 1,000 kilos. of coal carbonized. The net cost of gas in holder at Cologne is only six cents per 1,000 cubic feet; and Mr. Hegener may be excused for saying that neither electricity, water gas, nor any other artificial illuminant can be produced at such a low figure.

As the furnace question is important to every gas manager, I may be excused for having given so much space to it in this letter. All that I will add upon the subject is to say that any gas plant, be it large or small, will find it decidedly profitable to adopt a good and approved system of regenerative firing.

In order to reduce the cost of gas, purifying is done in Germany, France, and Belgium almost entirely by the oxide of iron. As this material becomes valuable to others after becoming useless to the gas company (there is a large demand for it from manufacturers of Prussian blue), in many Continental works gas purification really brings a profit. The cost of gas is also reduced by sales of coke to consumers, who pay good prices for it. This is

only possible when the coke has been reduced to nut-coal size; the demand is then very large. As the fire is smokeless, and gives but little ash, and can be ignited by special gas burners, gas managers in America should employ crushing machinery, in order that they may receive the same benefit derived by their Continental cousins from this bye-product.

Proper care is here taken to extract all the ammonia. If this is not done repairs to gas meters become expensive, as ammonia is destructive to the membrane. The price for ammoniacal products has fallen off; but the managers of the Cologne works are now constructing plant for the manufacture of chemical products. Small works can successfully dispose of their ammoniacal liquor to gardeners and farmers. Its value in husbandry operations is well known. The disposal of tar is a difficult matter to small works; but I hope the time is not far off when, in the Western Metropolis called Chicago, factories will be established which will absorb all the tar produced at the works of the members of the Western Gas Association. Millions of dollars are now paid to European chemists by Americans for the valuable products extracted from coal tar.

A great expense to gas companies is chargeable to the construction of new gasholders. Like in the case of furnaces, an improvement has recently been introduced by a German—Prof. Intze, of Aix la Chapelle—which does away with brick basins, reduces the cost of the holder largely, allows the space under the holder to be used, makes it possible that holders can be constructed in bad ground, and also that small holders may be enlarged fourfold. The old basin can be used for storage and foundation. I expected to receive photographs of this most interesting subject, but can only send you enclosed cut, which explains itself. In Germany these holders have been adopted; and as their success has been so very great in that cautious country, it may be expected that the new plan will be introduced in England, France, and America very soon. You might ask if the size of holders of this class is limited; and I may answer, No; they are transportable up to 8,000 feet, and can be constructed (telescopic, with four lifts) to contain 8,000,000 feet.

I have now attempted to show you the plan of producing cheaply large quantities of gas, and will also briefly tell you how to dispose of the product. The celebrated pen maker, Perry, told me years ago that large returns and small profits fill the pockets. This will hold good of everything where a demand can be increased by properly pushing the sale of the article in question. The sale of gas in the United States is not pushed at all. If the managers would follow General Hickenlooper's *modus operandi*, they would soon have a large day consumption. Once America astonished the world by pushing the introduction of sewing machines into every household. Give the same energy to the sale and hiring of gas heaters and cooking apparatus, and you, managers of American gas works, will not only know the words of "Home, Sweet Home," but you will actually have been benefactors through making a home sweet, without being obliged to be satisfied with the bad cooking of an imported servant or native of the Dark Continent.

The only reason that prevents many of the young ladies of the present age from attending to kitchen duties, like their mothers and grandmothers did before them, lies in the trouble of handling coal, and its consequent dirt; but, if, by the use of gas, all home comforts can be secured cheaply, bachelors will cease to exist, clerks and others with limited incomes can establish a household, and commence living, as our forefathers did, on modest means. If this be done through the help of enterprising gas managers, "Paradise lost" will be found anew in the west of America.

There are many different ways that may be followed in increasing the use of gas cooking, heating, and lighting apparatus; but the best one will be local exhibitions. Show practical cooking done by expert ladies; in one word, all you need is the assistance of the weaker sex. Gas engines will introduce themselves; but light, fire, and house-warming by gas can only be accomplished by persistent labor. A gentleman in a speech at the town hall, on the occasion of the opening of the Carlisle, England, exhibition of gas apparatus, said they had had their stone age, their bronze age, their iron age; but now they came into the gas age. I for one will bless that day when I can see upon a visit to your Illinois towns only gas in the household.

VOTES OF THANKS.

Mr. McMillin—I move that the thanks of the Association be tendered to the retiring President, Mr. T. G. Lansden, for the very able and impartial manner in which he has presided over the Association during the past year.

Mr. Spencer—I take great pleasure in seconding that motion.

The motion was put by the Secretary and unanimously adopted by rising vote.

The Secretary—Mr. President, please consider yourself duly and heartily thanked.

The President—Gentlemen, I appreciate this kindness. It was with fear and trembling that I entered upon the duties of this office a year ago. I do assuredly appreciate the honor you have conferred upon me; and I thank you for your kind forbearance with me throughout the whole of the sessions.

Mr. Clarke—I move that the thanks of the Association be tendered to Secretary A. W. Littleton for his services.

Mr. McMillin—I take a great deal of pleasure in seconding that motion. While we have one of the best Presidents that ever presided over the Association, still I think that a great deal of the success of the meeting is due to the Secretary; and while we hope to thank him a hundred times yet to come, we should not neglect our duty on this occasion.

The President—Gentlemen, you hear the motion returning thanks to our worthy Secretary. I know that I can, for myself, truly say that if it had not been for the valuable suggestions and constant assistance rendered me by our Secretary, this meeting would not have been the success that I believe it was.

The motion was carried, and the Chairman formally notified the Secretary of the action taken. In responding Secretary Littleton said—Gentlemen, I thank you most heartily.

The following report was then read:

"The Committee appointed by the Association to offer thanks to the gentlemen and firms doing business in Chicago, who have all so generously interested themselves in our welfare and comfort during our visit to this great city, do hereby recommend that a warm and hearty vote of thanks be tendered them for their unexampled hospitality; and we, as an Association, desire to assure them that we thoroughly appreciate their kindness, and will reciprocate to the utmost of our ability.

"JAMES SOMERVILLE,
J. B. HOWARD,
Z. T. F. RUNNER, } Committee."

The resolutions were adopted; and the Chairman declared that the regular business sessions of the Eighth Annual Meeting of the Western Gas Association had terminated.

May it never falter! But of that there is no danger.

The Klönne Regenerative Furnaces at the Greenock Gas Works.

[At the recent meeting of the North British Association of Gas Managers Mr. S. Stewart, of Greenock, read the following paper on the above-named subject. A letter from Mr. W. Foulis is also appended. The matter is reprinted from the *London Journal of Gas Lighting*.]

Our first construction of the Klönne regenerative furnaces at Greenock consisted of four ovens of eight retorts each (in all, 32 retorts), each 9 feet long and 24 by 15 inches in diameter inside, the mouthpieces being contracted to 15 inches diameter. We have since constructed eight additional ovens of eight retorts each, or 64 retorts of the same size as the above, making in all 96 retorts; but of these only the first four ovens have been working, and that for about five months, when they were let out to allow of the construction of the additional ovens being proceeded with.

The producers and generators—that is, the whole furnace—stand above the level of the retort house floor. The height of the furnace to the top of the producer is about 8 feet from floor, and the combustion chamber is about 2 feet above this, or 10 feet in all. The combustion chamber stands in between the two lower retorts, the middle retorts resting upon it. The whole of the furnaces, including the producers and the regenerators, are inside the ovens, and project about 14 inches from the front of each oven, to give greater length to the producer and regenerator, and to permit of the former being more readily charged from the two middle retorts, which are drawn directly into it. With ordinary good fuel, these are found more than sufficient to keep the producer charged during the 24 hours, after it has been filled. The producer is about 3 feet wide, and has an average height of 6 feet above the furnace base, with an average length of 7 feet; and it is filled about three parts full of fuel when fully charged.

The air passing into combustion chamber travels in a zigzag manner, so as to bring it frequently in contact with the waste heat going to the chimney. The air travels in this way 12 feet; but there is exposed to the waste heat a total surface of about 100 square feet in each regenerator, of which there are two to each furnace—one on either side of the producer. The waste heat travels directly from the bottom of the lower retorts, through the middle of the regenerator, until it meets at the bottom of the furnace a horizontal flue going to the chimney; the downward travel being equal to a perpendicular distance of 8 feet on either side of the producer. The air supply to the furnace or producer, and to combustion chamber, is regulated by ventilators; and the exit of the waste heat is controlled by dampers as it joins the horizontal flue to the chimney.

In consequence of the furnaces being entirely above the retort house floor, it was necessary to construct a stage for drawing and charging the retorts. This stage is about 7 feet high from the floor to its upper surface. The coke intended for sale is drawn into barrows on the retort house floor, a space being left between the stage and the ovens to admit of the coke falling into the barrows. The coals are lifted on to the stage by a hydraulic hoist. The stages are so arranged as not to interfere with the ordinary traffic through the retort house.

The cost of the producer and regenerator, including all iron and fire brick material and labor, from the floor of the retort house to the underside of the lower side and middle retorts, was £100 per oven, or £12 10s. per retort, everything being new; and the total cost of the four ovens for the 32 retorts—including foundation, all brick and iron material, and labor in the ovens, retorts, retort mountings, hydraulic main, bench binders, charging stages, but exclusive of hoist and 15-inch main from the bench to the condenser—was £1,560, or less than £49 per mouthpiece. When, however, the extension is completed, as there will be a less proportion of heavy walls, the cost will not amount to £40 per mouthpiece.

The ovens were lighted for drying on the 15th of October last, and a gradually increasing fire was kept under the retorts until the 15th of November, when, the ovens being apparently dry (although it was afterwards found that the bench gave off steam for at least a month), the heats were increased. Two days after we commenced charging with four-hour charges, and the next day with three-hour charges (the ordinary charges of two cwt. each). This continued for a few days, when the charges were increased to 2½ cwt., at which they were afterwards kept; being equal to 1 ton per mouthpiece per 24 hours. The retorts were regularly heated from end to end, and all very much alike. The middle retorts were, however, somewhat hotter than the others, and consequently a little more coal was put in. The clinkering only required to be done once in 24 hours; but this depends entirely upon the percentage of ash in the coke. If there was a great deal of ash the furnaces would not go for 24 hours; and if very little, we have had them in use for 48 hours without clinkering. So that by using care in selecting the fuel a good deal of labor may be saved. The amount of fuel required was found, on an average, to be 2½ cwt. of coke per ton of canal carbonized; while the ordinary setting generally required about 6 cwt. per ton. The workmen not being fully employed, I had the same cost for labor as in the ordinary furnaces; but when the system is fully at work, I expect to have a considerable saving under this head. As the system is not working alone (the greater proportion of gas made being from retorts fired in the ordinary way), I am unable to say at present what was the increased yield per ton of coal by the regenerative system.

I would now make a few remarks on the working of the system, as this may be of interest to those who contemplate adopting regenerative furnaces. The advantages of these furnaces are usually spoken of as embracing the following points: Saving of fuel; less accumulation of dust throughout the setting of retorts; less clinkering; lower percentage of ash and waste of coke; and saving of labor. As a consequence we have a larger quantity of coal carbonized in each retort per 24 hours, higher heats, and an increased yield per ton of coal carbonized, greater durability of the retorts and settings, and a saving of floor space in the retort house, owing to the larger number of retorts in each oven. In proceeding to refer to these points, I will take them very much in the order in which I have placed them.

First, the saving of fuel. This is generally taken at from 50 to 60 per cent. of that usually required. But a little consideration will show that this is not all due to the regenerative system in itself; for it must be borne in mind that in Scotland it is usual to put only four or five retorts in an oven, while there is no reason why seven or eight could not be set (if gas engineers would only face the expense in building larger ovens), and that these could be heated by nearly the same quantity of fuel as is used for the smaller number, if the large amount of waste heat which now passes up the chimney were properly utilized, and thus the percentage of fuel or weight of coke per ton of coal carbonized would average less in the ordinary system, especially if a stronger coke were used, as is often done with regenerative furnaces. Of course, I do not mean to say that there would be the same percentage of the fuel saved if a larger number of retorts were set in an oven in the ordinary system as with the regenerative system.

Secondly, less accumulation of dust throughout the setting. This is undoubtedly due to the lower draught required, and there being no stirring up of the fuel by poking, as in the ordinary furnaces, as well as to the heating by gas in almost immediate contact with the retorts. At the same time I find there is an accumulation of dust when coke from ordinary canal coal is used; but by no means to the same extent as from ordinary furnaces.

Thirdly, durability. It is of advantage to use only one kind of fuel in the producer. When coke from various kinds of canal is used, there is probably a different production of gas—that is, a larger quantity of gas is produced at one time than at another, as the different kinds of fuel are reached; and as the ventilators admitting the secondary air remain at the same adjustment, it follows that a larger or smaller volume of heat is produced. This will give rise to an oscillating action in the heat, and thus possibly cause an oscillation in the expansion of the brickwork. It follows that the durability of the retorts is thereby affected, and different results in durability may be produced in this way. Irregular charging will produce the same results. Thus, if the charge is put in so that there is a thicker bed of canal at one part than at another, the part where the heavy charge lies will be cooled beyond the average, while that part where the charge is light will be excessively

heated. Some kinds of firebrick material will stand this unequal cooling and heating more than others; and even the material from any one manufacturer may vary in this point, and so different results as regards their durability may arise. Those who work four-hour charges must naturally expect a different result from those who work three-hour charges, as every charge cools the retorts. The expansion and contraction must be more frequent with short charges than with long ones; and there is besides the deterioration of the retorts, due to the more frequent rubbing action of the coals being put into the retort, and of the rake in drawing out the residual coke. When speaking of durability, under any system of heating the retorts, consideration must, therefore, be given to the length of time the charges are allowed to run.

The durability of retorts is also due to other causes than the heating and the material used. It is due to the method of setting, to the working on the part of the stokers, and to the work the stokers have to do in the quantity of coals put into the retorts. When, on the old system, only one fire is used to heat the retorts, it is possible to set them so that they will endure as long as the material of which they are made will last; but where two furnaces are employed the retorts are resting upon a base that is destroyed before the retorts are fairly worn out. When speaking of durability, and the results at one works compared with another, regard must be had to the previous methods of setting employed in each works respectively, as well as the duration of the charge. When we consider the higher heats that are usually employed, and the greater weight of canal carbonized per charge, with often the more frequent charging, I am afraid that any greater durability in the actual working of the retorts will not be realized. Of course, during the time the retorts last they will carbonize a larger quantity of coal. For instance, I find that in the old method of setting and working employed at Greenock, the durability of a retort is equal to the carbonizing of from 300 to 350 tons of canal; and if this is lengthened to 450 or 500 tons of canal per retort it will be as much as can be reasonably expected. The producers and regenerative parts will, no doubt, last for years; but the retorts will require more frequent renewal.

What the money saving in labor may be per ton of canal carbonized my experience does not yet permit me to say; but I shall be disappointed if it is not equal to 25 per cent. of the stoker's wages. The experience of others justifies me in expecting this, and also (from the regularity in the heating of the retorts) that there will be an increased yield of gas per ton of canal is undoubted.

Clinkering is an important item in the ordinary system of working furnaces, and one which it was expected would be entirely done away with by the regenerative system; but I find this largely depends upon the class of fuel used. Fuel containing much iron in its composition will bridge over and form a clinker very difficult to remove; and my experience is that, although the labor of clinkering is very materially reduced, it is not entirely done away with. By care, however, in selecting the fuel, it may be so reduced as to involve only a small amount of labor in its removal.

I may close these remarks by saying that, generally speaking, it will be found that the regenerative system of heating retorts reduces the heavy toil on the workmen, effects a saving in the cost of labor, enables a greater quantity of gas to be produced by each retort, allows of material economy in the use of fuel, and is altogether a more scientific system of working. But against this has to be placed the first cost, and the greater skill required on the part of both managers and men in the working of the furnaces.

Mr. W. Foulis, of the Glasgow Corporation Gas Works (who was unable to attend the meeting), sent the following communication, which was read by the Secretary:

"Since the last meeting of the Association there has been considerable discussion, in the columns of the *Journal of Gas Lighting* and elsewhere, as to the value of regeneration in gaseous firing. The discussion was inaugurated by what was called a discovery that air could not be heated in flues at atmospheric pressure—an idea which could only have originated from an imperfect knowledge of the most elementary principles of thermo-dynamics. Increased knowledge of the subject enabled the author of this idea to see his error, which he acknowledged in a very straightforward and honorable manner. Then it was said that, although you could heat air, yet it did no good; and that any benefit that was derived from the regenerators was due to the bottom of the setting being kept hot by this means. This idea is, to my mind, about as untenable as the other. In a well-constructed retort bench, with a sufficient mass of brickwork in the foundations, the bottom of the setting is better protected than any of the sides. The front walls and top radiate much more heat than can possibly be lost through the mass of brickwork underneath. Then, again, in very many settings, with ordinary firing, the waste gas flues are carried underneath the bottom retorts; so that any loss by conduction downwards can have but little effect on the efficiency of the furnace. I would also like the author or authors of this idea to consider that in regenerator furnaces for other purposes than retort heating, the regener-

ator is seldom, if ever, placed underneath the furnace to be heated. Yet the benefit of regenerators so placed is undoubted. At the last meeting of the Gas Institute another theory was advanced—viz., that the heating of air was positively prejudicial unless the gas was likewise heated. While I cannot agree with the theories advanced by the author of the paper which contained this idea, there can be no doubt about the fact (which was very early discovered by the late Sir W. Siemens) that to obtain the greatest efficiency in a regenerative furnace it is necessary to heat the gas as well as the air—that is to say, if you have hot air you must, in order to get the best results, have hot gas; and it is likewise true that if you have hot gas you must have hot air. In a retort setting heated by gas from a producer placed either inside or outside close to the setting, and fed with hot coke, the gases from the producer enter the setting at a very high temperature; and in order to get the most perfect combustion and the greatest efficiency, it is necessary to heat the air to the same temperature. In a great deal of the discussion that has taken place on this subject the fact that hot gases have to be dealt with seems to have been entirely overlooked. All those who have had any great experience in the working of regenerative furnaces, and who have found the advantages of a hot air supply as compared with a cold air supply, will, I fancy, pay little attention to the theories advanced by men who have not had that experience, and who try to prove that the advantage does not exist. Still, these theories cannot altogether be ignored. But there would be no difficulty in showing theoretically wherein the advantage of regeneration consists. In the foregoing remarks I have looked at the question rather from a practical point of view; and I shall be very much pleased if they in any way help in the discussion at the meeting."

Natural Gas in Plate Glass Manufacture.

An exchange says the expression, "French plate glass" leads one to think that foreign nations make all of this kind of glass. That is far from being the fact. There are in the United States four works for making plate glass. One is located at New Albany, Ind., one at Jefferson, Ind., one at Crystal City, Mo., and the one described in this paper, at Creighton, Pa. Plate glass is made by casting and afterwards polishing. The pots in which the materials are melted and the glass made are of great capacity, and require heavy and convenient machinery for pouring. The casting is done on a heavy metal slab, larger than the largest sheet of glass produced, and this slab rests on a ear which runs on tracks leading from the melting furnaces to the annealing rooms. A large iron roller, running on strips of iron at each side of this table, presses the molten glass into a sheet as the workmen pour it in front of the moving roller. The thickness of these strips of iron on which the roller rolls determines the thickness of the plate of glass. While the glass is yet hot it is thrust into an annealing oven, where the temperature is gradually lowered for several days until it is cold. The surface of the glass is now very rough and uneven, and though it is translucent, it is not transparent. In this form it is used for skylights, and for places where strength and light are required without transparency. After the plate comes from the oven, it is firmly fixed upon a large rotating table or platform which revolves quite rapidly. Over its surface two disks rotate and revolve in such a manner that they cover the entire surface of the glass at each rotation of the platform. The attending workmen throw common river sand upon the surface of the glass, which is kept constantly wet by small streams of water. This process grinds off the rough exterior, after which it is ground with emery, on machines of similar construction. Beginning with coarse emery, they gradually change the grade until the finest powder is used to finish the grinding. After the grinding is complete, the surface is polished by rouge on machines constructed on the very best principles for making perfect surfaces.

From the time the glass leaves the annealing ovens until it is perfectly polished, the workmen examine it, from time to time, for any flaws, bubbles, or defects, as grains of annulled sand. Only those large plates which are free from defects of any kind are polished entire. When a flaw is discovered in a large plate of glass, the plate is cut into smaller ones of marketable dimensions. This branch of the trade requires trained and skillful workmen who have good judgment. After the glass has been properly polished and cut into required sizes, it is boxed ready for shipment. The manufacturers insure large plates of glass, for which the buyer has to pay. This makes the purchase without risk to the purchaser.

The works of the "Pittsburgh Plate Glass Company" are located at Creighton, about twenty miles above Pittsburgh, on the west bank of the Allegheny River. There are about eight or nine acres covered with buildings, along a side-track of the West Pennsylvania Railroad, which are used for the various purposes of manufacture, store-houses, furnaces, casting houses, stables, offices, etc. One of the buildings, 650 feet long by 160 feet wide, is the casting house. It contains sixty ovens for annealing glass, and two furnaces for melting. Each annealing furnace is over forty feet long by

nearly twenty in width. Each melting furnace contains fourteen pots. The apparatus for casting consists of two iron tables, seven inches thick and 19 feet long by 14 feet wide; two iron rollers, thirty inches in diameter and fifteen feet long. These tables are on carriages which move on a track which reaches every furnace, and is nearly one mile in aggregate length. There are also cranes, tongs, ladles, and pulleys, which are most conveniently arranged for rapid work. The first building in which the plates of glass meet machinery driven by steam is the grinding house. This building is over 200 feet long by 80 feet wide. There are eight rotary grinding machines in this building. Each machine requires forty-horse power, and all are driven by two double vertical engines. There is a second grinding department which contains two machines of the latest French pattern. These machines require one hundred and twenty horse power, and do most excellent work rapidly.

The glass is smoothed in a building about 100 feet by 200 feet. In this house there are 20 smoothing machines, which require the power of two engines of 40-horse power each to drive them. Next in order is the polishing house. This is the same in size as the smoothing house. There are sixteen polishing machines, each 11 by 20 feet, driven by two engines of over 800-horse power.

The company make their own melting pots, and in this building a steam engine of 30-horse power grinds and mixes clay. There is a department where plate glass mirrors are made, and this requires the help of a large engine to drive machinery for beveling the edges of plates of glass. This department has proved a perfect success, and many beautiful mirrors are made here, ranging in price from \$1 to \$500.

There is also a large foundry and machine shop, where all the machinery used in the plant is made or repaired; and a shop for making boxes, where an engine runs saws and planers. The company employs 345 men, 45 boys, and 15 women and girls. They have lately built a steam dredge for collecting sand from the bottom of the river for grinding glass. Three million bushels of sand are required each year for grinding purposes alone. The white sand from which the glass is made is shipped from McVeytown, Pa. The amount of glass cast each month is 95,000 square feet. About three per cent. of this is used for skylights; the rest is polished, making an output of 70,000 feet of polished glass per month, after allowance is made for cutting and breakage.

The novel feature about these vast works—where engines aggregating nearly 1,500-horse power are fed by steam, and sixty annealing ovens and two melting furnaces require fuel—is the entire absence of coal, and the use of natural gas in its stead.

The company owns two gas wells, which are about 1,150 feet deep, and they are now running their entire works with a little over one-half the production of one well. The pressure at the well is 240 pounds per square inch. This pressure is reduced at the well to 120 pounds, and, as the line works wide open, the pressure in the regulator at the works is lowered to 80 pounds. The pressure is still further reduced before it enters the furnaces. The pipe which conveys the gas to the works is 4 inches in diameter. The surplus gas is used in the town for heating and lighting; and as they are able to consume but a small quantity of this, compared with the supply, a tube, high in the air, sends out a large flame which lights up the surrounding country. For domestic purposes this fuel has no equal, and it has no superior for manufacturing. The steel works in Pittsburgh use natural gas entirely, melting steel easily with the intense heat produced.

Glass made by this fuel is decidedly superior to that made by the use of coal. No coloring material can get into the melting pots, and the flame of the burning gas is free from impurities which would injure the quality of the glass. Several inches of this glass, when seen through from edge to edge, show no appreciable color. This is the most apparent advantage gained, but there are others of no less importance.

The control which the workmen have over the heat in the melting furnaces, and especially in the annealing ovens, enables them to make glass of great durability and strength.

At present the company is in a flourishing condition, and have all they can do to supply the demand for goods. They make glass cheaper than any other plant in this country, and can compete with either the French or the English, inasmuch as their fuel costs them practically nothing; the gas used taking the place of three thousand bushels of coal per day.

Coal Slag as a Building Material.

The London *Builder* claims that the first steps in the direction of using coal slag for building purposes were due to the initiative of certain Lyons builders who wished to find a cheap, durable, and healthy material for the construction of suburban houses upon sites acquired for comparatively short leases, the contingency of occasional partial inundations being also kept in view. The coal slag was mixed with some slacked lime, and was treated as a concrete. The mass hardened rapidly, and even after a few days the walls

were firm enough to support the joist framings. After the lapse of a month the building was dry. At the time named coal slag was so plentiful that it could almost be had for the asking, and the cubic foot of wall (including transport, scaffolding, and labor) cost about 1½d. After 30 years' experience this mode of construction has become so general in Lyons that the necessary transport of coal slag from a certain distance has raised the cost to about 3d. per cubic foot.

According to the *Wochenschrift*, of the Austrian Architects' and Engineers' Association, the original proportion for mixing was four parts of slag to one part of lime. At first fat lime was used, and later on hydraulic lime; but, in order to obtain greater strength, it is recommended to increase the proportion of lime, and use white lime. The ramming is best effected in layers 6 inches thick. The walls are usually made 1 foot 7½ inches thick, but they can be thinner if the burden they have to support is light. Solid party walls can be made 6 inches to 8 inches in thickness by ramming the mixture between boards, or by forming out of it bricks, which can be built into a wall after drying. For a long time this style of building was confined to works of an unimportant character; but within the last two years it has been used by various architects (particularly M. A. Louvier, of Lyons) for public buildings, and for private houses of large size.

The strength and fire-resisting properties of the composition in question have been successfully demonstrated by M. Louvier in the course of experiments made by him on a relatively large scale. It is further recorded that a nitro-benzine factory near Lyons was burned down, the violence of the conflagration even melting part of the machinery. The walls (made of this slag mixture) were unconsumed—their surface having a glazed appearance—and sustained without repair the ceiling and roof of the restored building. Similar results are said to have been demonstrated by the burning of the Célestius Theater at Lyons.

SPECIAL ENGLISH CORRESPONDENCE.

COMMUNICATED BY NORTON H. HUMPHRYS.

SALISBURY, August 10, 1885.

The Beckton Gas and Chemical Works of the Gas Light and Coke Company.—The North British Association of Gas Managers.—Report on Regenerator Furnaces.—Prize Essays.—Gas Profits at Manchester and Salford.—Nuisance from Gas Works at Belfast.

I have on previous occasions referred to the Society of Chemical Industry, and have now to notice one of the features in connection with the usual annual meeting, which was held in London, in a building adjoining the Invention Exhibition, a few weeks since. This was a visit to the large gas works out on the Essex marshes, on the north side of the river Thames, where the greater portion of the gas which is used in the city of London is manufactured; a special feature of which is that it includes a chemical works where the tar and liquor are worked up into salable commodities. In passing I may take the opportunity of calling the attention of any of your readers who may be interested either in a pecuniary sense, or *con amore*, in the "science of stinks," to the excellent journal issued monthly by this society, which furnishes a valuable record of current applied chemistry; and although the gas engineer does not need to be posted up in the details connected with the manufacture of soda, varnish, matches, or soap, he will find that a casual glance in the direction of the broad subject of chemical manufacture will prove useful as furnishing many a practical wrinkle capable of application to many of the processes which it is his business to superintend. Remembering the limits of space, and the numerous items of interest to the fraternity, that have a claim upon the columns of the AMERICAN GAS LIGHT JOURNAL, I cannot do better than refer to the excellent description of the Beckton Gas Works which appears in "King's Treatise," and pass on at once to give a few details about the chemical works. Taking that portion applied to the treatment of tar, the most striking feature is a row of 30 to 40 large stills, with extensive pitch bays on the one side, and the condensers and apparatus for further subsidiary processes on the other. Amongst these is an intricate network of railways, by means of which the various products can be loaded direct into large iron tanks, or collected in barrels and at once transferred into ordinary railway trucks. And every spare inch of ground appears to be utilized for the accommodation of barrels or other receptacles. There is a railway system extending throughout the whole works, it should be remarked, arranged for the transit of coal, coke, purifying material, etc. This is quite distinct from the adjacent railway companies, one of which has a special station just at the main entrance to the works. The principal commodities produced at these tar works are benzol, naphthaline, or albobarbon, carbolic acid, creosote, lubricating oil, and anthracene. At the liquor works the ammoniacal liquor is used for the production of sulphate of ammonia; and they include the necessary plant for the manufacture of the sulphuric acid. Here the "spent oxide" from the purifying houses is utilized as a source of sulphur, and after being so treated

is restored to its original state—thus two birds are killed with one stone. The "spent oxide" is rendered as good as new, and at the same time the sulphur which it has absorbed from the gas is converted into a valuable product. The spent oxide, however, is not sufficient to provide the whole of the sulphur required, and so other materials have to be purchased. The ammoniacal liquor is distilled in the usual manner, and the vapor passed into open saturators. The foul gases from the saturators are cooled, so as to deposit the steam and water vapors they hold in suspension, and then passed into the sulphur ovens, where the sulphuretted hydrogen is burnt and utilized for the production of sulphuric acid. When we add that there are lime kilns on the premises where the spent lime can be reburnt, it will be observed that the whole of the residuals—tar, liquor, used oxide, and used lime, are turned to practical account in the works.

The North British Association of Gas Managers held their annual Meeting, at Dundee, on the 23d and 24th prox., and it was one of the best gas managers' meetings that have ever been held. A glance at the programme reveals the fact that this statement conveys no invidious comparison. Besides the usual Presidential address and papers, in the course of which the regulation of supply pressure, and control of consumers' gas supply; the limit to which washing and scrubbing may be profitably carried on in the purification of coal gas; a new idea in the way of condensation; clearing gasholders from atmospheric air when first putting them into use; and the rise and progress of coal liming—subjects which of themselves constitute a good programme—there was the special feature of a report on the adaptability of regenerator furnaces for heating retorts in moderate sized gas works, comprising statements from some half-dozen gas engineers who have had several months' practical experience, on a working scale, with this system of firing; and the Allan-Lever prize essays, particulars of which were given in my last letter.

The report on regenerative furnaces must be regarded as a valuable contribution to the literature of this subject. It comprises practical information as to the working of some 250 settings of retorts, mostly on the Siemens system, though the Klönne system is also represented. The verdict admissible from the evidence of several different gas engineers is unanimously in favor of the new system, exhibiting a marked agreement on the important items of saving of fuel, greater durability, and duty per retort (which is the same thing as economy in retort house space), and reduction in wages. Everyone about to make a practical test of this system should read this report, for it appears that in every case some difficulties were experienced at the commencement, although they have all been successfully surmounted. "We are about to extend this system to the whole of our retorts," is the general expression; and, on the whole, the report is so favorable that another year or two will witness a marked extension of the regenerative system in Scotland.

In last month's letter I ventured to favorably anticipate the result of the Allan-Lever prize competition, and this was more than realized. Twelve papers were sent in, and the first and second prizes were carried off by Mr. J. Somerville, of the South Metropolitan Gas Works, and Mr. J. C. W. Folkard, of the Chiswick Gas Works, respectively. So it is remarkable that both the prizes went to London engineers. A Scotch gentleman, Mr. J. Whimster, Jr., of Amagh, coming in third, was awarded a special prize of £10.

The subject of smoke abatement is only indirectly related to the gas industry, in so far as the use of gas heating and cooking stoves may be regarded as a means to that end; and, with the exception of the strange suggestion that local authorities should own the gas works and sell gas at less than cost price, making up the balance out of the rates, the essays do not include any novel suggestions relating to gas companies. Some corporations have now owned gas works for considerable periods, and practical experience shows that as a general rule they regard the works as a source of profit, to be used as a means for reducing the rates. Some few are sufficiently straightforward to put the saddle on the right horse, and sell gas at cost price, leaving the public expenditure to be met in the proper manner. But all are already sufficiently saddled with responsibilities in the way of water supply, or drainage schemes, or other public improvements, without incurring the additional onus of devoting considerable sums from the public funds to the purpose of smoke abatement. If the public cannot be brought to avoid the smoke nuisance of their own free will, I do not think they will ever be forced to do so by act of Parliament. Although the essays are excellent productions in their way, as dealing with the general subject, I must confess to some little disappointment on reading them, having expected that papers submitted to a meeting of gas engineers would give more attention to the position of gas companies in respect to this subject, and show how they might utilize the present demand for cheap gaseous fuel to the mutual advantage of the public and themselves.

The disadvantages consequent upon gas undertakings being owned by town authorities have not lately been rendered prominent. Gas affairs have been so prosperous—there has been an increasing demand, and residuals have

realized good prices—that without charging higher prices than would be the case with a trading company the undertakings have yielded considerable profits. So things have gone swimmingly. The users of gas have been satisfied, while at the same time large sums have been devoted to public improvements. At Manchester the rule for some years past has been that the Gas Committee should hand over the respectable sum of £52,000 to the Improvement Committee; which, in other words, is taking that sum out of the gas consumers' pockets and putting it into the ratepayers'. This year, however, although the demand for gas has increased the same as usual, the Committee have encountered adverse circumstances in the reduced prices obtainable for tar and ammonia, and so find themselves unable to provide the above-named sum. The Gas Committee have decided to apply to the Town Council for relief from this charge, and this will bring up the whole question of gas consumer versus ratepayer. The neighboring borough of Salford also appears to be in a similar position—several thousands pounds sterling per year have also been contributed by the gas consumers to the general funds; and there also a resolution is under consideration as to the advisability of selling gas at cost price. It is very evident that those who take the profit must also take the risk. If the town authorities have made a practice of selling gas at cost price, then they can reasonably claim the right of increasing the price if circumstances occur to increase their expenses or diminish their revenue. But when—as in the case of Manchester and Salford—they have been making large profits, things bear a different complexion; and it is not fair to seek to saddle the consumer with the losses due to bad times. But there are a certain number, in every town where the gas works is owned by the public authorities, who appear to believe in plundering the gas consumer to the greatest possible extent. "If times are good," they say, "make profits out of the gas undertaking; if they are bad, raise the price and still make profits." In times which have now happily passed by gas consumers found representatives to protest against the alleged exorbitant profits made by certain companies. Before long we may expect to see the consumers in certain towns rising to protest in a similar manner against the public authorities, unless the policy of the past is altered. I shall look with much interest for the attitude taken by the gas consumers in the above-named towns in connection with these considerations.

The Belfast Corporation have got into trouble for allowing foul smells—to wit, sulphuretted hydrogen—to emanate from their gas works, to the annoyance of the noses, and to the damage of the paint of certain neighboring residents; having been mulcted, by Mr. Justice O'Brien, at the Antrim County Assizes, in the sum of £10 damage to each of the unfortunates. There is a foul river and some chemical works in the neighborhood which may or may not have contributed to the nuisance. But the very natural anxiety which all bodies of directors feel to avoid any possible cause of offense was used against them by the learned judge. The Gas Committee had received deputations, and promised to do what they could; and, in one instance, had a cover put upon a certain tank. But it is possible that all this was done as a means of extreme precaution, and that promises were made by the Gas Committee with a view of satisfying the deputations without first inquiring as to the truth of the allegations as far as the gas works is concerned. After the decision of Mr. Justice O'Brien, gas committees or boards of directors must avoid being too courteous or sympathizing to complaints of nuisance. They must be careful not to commit themselves, and it will be better to tell the complainants bluntly "not to come here with such nonsense," than to be too attentive and considerate, which course might possibly imply a knowledge of guilt.

Boring for Natural Gas at Cleveland, Ohio.

Advices from Cleveland, Ohio, state that the Cleveland Rolling Mill Company of that city has been drilling for gas on its property in the Eighteenth ward since Oct. 10th, 1884. At the depth of 715 feet a small vein of gas was found, but it was soon exhausted. After passing through the shale the drill entered a vein of limestone 260 feet in thickness. Below this, hard gray sandstone was encountered. While the drill was pounding in the sandstone at a depth of 1,700 feet, the well suddenly filled with water, which, being pumped out, was found to be strongly impregnated with salt. The drilling was continued until a depth of 1,985 feet had been reached, when pure rock salt was found. This vein was 169 feet in thickness, and it required 36 hours to drill through it. The drillers were not in search of salt, but gas, and they continued with the work. The big salt vein was encountered about a month ago. Two weeks later, after drilling through a considerable amount of rock, another but smaller vein was encountered. The drill was still driven downward until it had reached a depth of 2,680 feet, and the drillers were treated to another surprise. This time they found petroleum. Evidences of oil were found in the shape of a peculiar odor about the borings. The drill was passing through very hard rock, and it therefore proceeded very slowly. Every time the sand pump was put down into the well it was filled with oil and water, and several barrels of petroleum were taken

out in that manner. The oil is said to be of very fine quality. What has already been found seems to have trickled through the rock from a pocket near the well. No gas has been found since the drill passed below 1,000 feet. It is now producing about one barrel of oil daily. The hole has reached a depth of 2,700 feet. There are slight indications of gas, but it has not yet been discovered in paying quantities.

Technical Journalism.

Ralph W. Pope contributed the following to the August number of the *Electrician*:

Technical journalism is the natural outgrowth of industrial progress, and contributes largely to that development of science and invention which has been characteristic of the nineteenth century. While the more important discoveries are eagerly sought out and made public by the enterprise of the daily press, the quiet workers, who by their skill and ingenuity patiently labor to bring their experiments into practical form, may have toiled for years in comparative obscurity.

Such men must necessarily keep thoroughly abreast of the times, at least so far as concerns their particular line of investigation; and to them the technical journal is indispensable. It must indeed be a stupid periodical which in the course of the year does not bring them information of far greater value than the price of subscription. Such knowledge is therefore a necessity rather than a luxury. While we may derive a certain amount of satisfaction from perusing our favorite daily, it is the technical journal which brings to its supporters the bread and meat of every-day life. Its field is constantly broadening, while bright minds are continually on the lookout for opportunities previously neglected.

The frequent inaccuracy in the minor details of ordinary newspaper work was recognized as long ago as Lord Byron's time, else he would not have replied to the query, "What is fame?" "To be killed in battle and have one's name spelled wrong in the despatches."

Even in the limited experience of the writer, he once figured in the *New York Sun*, with great particularity of street, number, and business position, as the husband of his brother's wife; an error which was perpetrated with such exact accuracy of other details that its origin still remains a profound mystery. Such mistakes are the more readily excused because of the haste with which material must be collected and prepared.

There is, however, another class, which are more properly blunders arising from the ignorance of writers upon the subject they attempt to elucidate. The reporter who described an accident at Jersey City, in which a train plunged through the station and the locomotive went off the wharf, gave as the cause the failure of the "backing" brake. Had he been more familiar with railway mechanism he would have known that while a brake may be used to stop a train, the engine must be reversed to back it. What he doubtless overheard was that the "vacuum" brake failed, as was really the case. It was another scribe, doubtless more familiar with atmospheric exhaustion, whose practical training secured him a position on the *Herald*. This genius examined an East river steamboat after an explosion, and discovered a vacuum in her cylinder six feet long, which had been broken into seven pieces! Scientific accuracy can scarcely be hoped for in such cases; but when we read in a description of a boiler explosion that "the path taken by the boiler was immediately followed by ourselves," we naturally infer that the reporter was blown up as well.

It may be too much to expect that these details can be carefully watched, as it is well known that but a small minority of newspaper readers will detect such errors, unless they are personally familiar with the subject or incident. It is when our metropolitan dailies venture outside of their province that they should exercise more care in the preparation of their matter, or at least refrain from dictating the exact course to be pursued by others. It is a common saying in press circles that every man thinks he can run a newspaper. It is also apparent that every editor knows how to run other people's business as well as his own. In the palmy days of Napoleon III. the modest leader of the New York press at that time would occasionally intimate that if Louis Napoleon would take the advice of the *Herald* many of the difficulties which beset him might be avoided. Whether his eventual downfall could be ascribed to his obstinacy in this respect is a question for the historian, who is more familiar than I am with the mysteries of French statesmanship.

It is frequently the case that under the guise of scientific phraseology a newspaper may cause at least annoyance, and perhaps injury, by gross exaggeration or a misstatement of facts. A recent case which was particularly atrocious was that of the *Evening Telegram*, in which an attempt was made to show that from an artistic and engineering point of view the Bartholdi Statue of Liberty is a failure. Imagine the assurance of a critic of this character in pointing out to an educated engineer, such as we may presume General Stone to be, that the truss-work was not properly planned. Perhaps it was not; but why should it be left to a *Telegram* reporter to point

out technical defects in a work of this character? He then undertakes to prove that in the joining of the iron framework to the copper plates, of which the statue is formed, electrical action must subsequently ensue, which will ultimately destroy the metal at such points. With equal foresight many other dire evils could be predicted, which *might* occur if proper precautions were not taken to prevent them. Fortunately the animus of this remarkable display of newspaper science was thoroughly understood by the public, and the proper allowance made for these extraordinary criticisms. Similar cases arise, however, in which the motive of the attack is more obscure, when the pernicious influence may consequently be more effectual.

The crusade of the press against the overhead wires is an example of the manner in which the people may be incensed against a minor evil, while more imminent dangers beset them on every hand that remain comparatively unheeded. For years the law has recognized the necessity of regulating the construction of buildings, the testing of steam boilers, the inspection of steamboats, and the licensing of engineers and pilots.

We have had a cycle of falling buildings in this city and vicinity within a few months; a reckless builder has been sentenced to prison, and quiet now reigns, the subject being considered stale. No anxiety is manifested in the daily press regarding the thousands of steam boilers "underground," many of them in charge of engineers (?) who are also expected to serve as porters or men of all work in their respective establishments. Among technical papers the *American Machinist* has frequently alluded to the various mechanical death-traps which pervade the community, a recent instance being its reference to the numerous excursion boats which daily ply our harbor in every direction. Many of these steamers are crowded to their utmost carrying capacity, in open violation of the laws which are supposed to protect the people from the avaricious and unscrupulous owners who risk human life that dollars may be gained. The masses, however, are neither scientific nor mechanical, or if they were they might not be influenced by the opinion of a technical journal; consequently its reasoning, however weighty, is of no avail, because it is misplaced. While those who read its columns may be interested for the time being, there appears to be no manner in which the evils pointed out may be eradicated. The necessary laws exist already, but they are apparently not enforced, excepting perhaps for a brief period under the stimulus of some appalling disaster. In a few days any further reference to it is overwhelmed by the later intelligence of perhaps a more serious calamity.

One of the gravest drawbacks to the influence of a journal is the question as to the honesty of its opinions; in fact, its reputation. It is here that the technical journal finds its path continually beset with thorns. The interests of its readers demand that they shall be enlightened on the merits of new inventions, processes, and materials. They do not care to learn from John Smith that in his opinion the Smith dynamo will supply more Smith lamps per horse power than the dynamo of Jones. Neither do they hanker after Jones's remarks on the Smith machinery. If, however, they have confidence in their favorite electrical journal, they might be glad to obtain, if they could, an official editorial decision.

It is right here that the sphere of the technical journal must be bounded. It should offer a fair arena for the statement and elucidation of facts and theories by those who profess to understand them, under their own names—which, if well known, carry with them the necessary weight; if not, the reader must judge from the article itself whether the author probably understands his subject.

It is often the case that the technical journal, acting solely in the interest of its readers, and without reference to its advertising columns, publishes descriptive matter which is supposed to be beneficial to the inventor, manufacturer, or vender of the article in question. It is too frequently understood that financial inducements are offered to secure what is erroneously considered an endorsement of the article, when, in fact, no opinion of its merits is advanced.

Having in view the fact that the mission of the technical journal is to instruct, inform, and please its readers, the editor should certainly reserve the right to give a favorable opinion if he so desires, but not without careful investigation. His reputation is to a certain extent his capital, and should therefore be guarded with equal consideration. No allotment of stock or admission on the ground floor of a new enterprise should be allowed to bias his judgment; neither should he by his supposed influence lead others to embark in questionable enterprises.

We have in mind various schemes which have been boomed by daily papers. Possibly in some cases such advocacy has been paid for; but if not, the desired result was attained by taking advantage of the technical ignorance of the staff, and thousands of readers were misinformed if not duped.

A recent instance is that of the Hathaway printing instrument, for the introduction of which capitalists are now being invited to invest. It was announced through the medium of various newspapers that the introduction of this machine was to create a revolution in telegraphy, superseding not only the ordinary Morse instruments, but the telephone as well. The fact is that

this machine is a very inferior printer, by no means equal to those in actual use 25 years ago. The only patentable features about it are of no practical value whatever.

At the very outset of the electric lighting business in this country a panic in gas stocks was precipitated by the wildest predictions regarding the future of the new light, which was to be produced at so low a cost as to ruin existing gas companies. There was no foundation for such assertions, but many people were led to sacrifice excellent securities without any better reason than that the newspapers prophesied the final overthrow of gas monopolies. This was seven years ago; and the smile of the present holder of gas stocks is broader than that of most electric light owners. Investors in Keely motor stock were not allured into their present holdings by the representations of technical journals. There has never been an exhibition of the Keely apparatus that really warranted an extended newspaper notice. The whole affair has been brought into notoriety by writers who were not sufficiently versed in science or mechanics to detect its fraudulent nature.

It certainly appears as if would-be investors in questionable enterprises of this character should familiarize themselves with the "state of the art," either by continued perusal of journals devoted to such subjects, or else by the employment of trained experts whose opinions are entitled to weight. A purchaser of real estate would be considered lacking in judgment unless he engaged competent counsel to search the title. A similarly prudent course should be adopted by those who propose to secure an interest in inventions which are not in their line of business.

ITEMS OF INTEREST FROM VARIOUS LOCALITIES.

AN ITEM FROM MARSHALLTOWN, IOWA.—Mr. C. D. Shreve has leased the Marshalltown Gas Works, and assumed charge of the plant some three months ago, or on date of June 1st. The present gas prices in that city are very fair, all things considered. The highest charge is \$2.70 per thousand, the lowest being \$2.50; but Mr. Shreve has determined that these rates will suffer a "cut" in the near future. Mr. Shreve has our thanks for his appreciation of our efforts to make the JOURNAL of real value to the American gas manufacturer.

THE GAS MACHINE MAN.—Mr. L. C. Huber is General Manager of the Eureka Light Company, of Louisville, Ky., and therefore is very anxious that users of artificial light should be of the opinion that he has under his control the very best, if not the only, means of securing the proper illumination of their stores, factories, streets, and dwellings. The gentleman from Kentucky is quite energetic in his attempts to introduce the Eureka machine, and, of course, is profuse in his claims regarding the marvelous economy and efficiency of the aforesaid apparatus. No one could reasonably find fault with Mr. Huber on that account, since every salesman is apt to think rather highly of his own wares, and seldom neglects an opportunity to make others acquainted with his "state of mind" on the subject. Mr. Huber some time ago determined that the medium-sized towns of the West offered excellent situations wherein to dispose of his wares, and, amongst others, he selected Franklin, Ind., as an eligible location. Franklin possesses a particularly wideawake gas company, the officials of which were not disposed to allow Mr. Huber to conquer their territory without having a passage-at-arms, or at least making some show of resistance. The gas machine man selected the depot of the J., M. and I. Railroad Company as his first point of attack, and after much cajoling and supplication obtained leave from the railway officials to put in a "Eureka." When the apparatus had been in use for a certain space of time, or over a period sufficiently lengthy to demonstrate the worthlessness of the light generated (not to mention anything about its unreliability and the constant menace involved in its presence), the railway managers ordered that the great Eureka light generator and distributor be removed from the depot premises. This order caused Huber's indignation to get the better of his judgment, and impelled him to compile the following circular, in which he sought to explain "To the People of Franklin" (this last is the headline to the circular, and is printed from poster type of heroic size), why it was that the railroad folks had "cast him out." The "greatest circular effort" of Mr. Huber's life is herewith faithfully reproduced—*i. e.*, so far as its composition is concerned:

"To the People of Franklin:—Some six weeks ago I came to your city and put in operation, in the J., M. & I. depot, one of our gas machines, with a view to selling it to the railroad company, and at the same time exhibit the light to the citizens. So far there has been no objection raised by any one of the citizens as to the quality, quantity, and price of our light, except those directly interested in the gas company of your city. They cannot make a case against us in any one particular to condemn our light, and, failing in this instance, they have showed their great and magnanimous spirit by, as a last resort to get rid (I will not say of a rival company, for they are not considered so by us nor anyone else) of us, they notify the J., M. & I. Rail-

road that if our machine is not taken out of the depot, they (the great gas company) will not ship another carload of coal over the road.

"The above order is certainly one from a great man (?) or set of men with great minds (?). Of this matter, however, I will leave you to be the judges. I came to your city to offer you a good, cheap, and safe light, and I know I have substantiated my word. I came to transact my business in a fair and legitimate way. I said nothing against the coal gas company, and only asked to be let alone. There were remarks made about the explosiveness of my gas calculated to injure me; but on account of the ignorance of those who made the charges I passed them by unheeded.

"But since the gas company has gone to so much trouble to get rid of me, I propose now to challenge them to several tests as to the explosiveness of the two gases under like and unlike circumstances, the quality and quantity of light, and the price of light. You will be given due notice of the nature and date of my challenge, and I want everybody to see it. I came among you to offer you all just what you wanted, and until your citizens tell me to take my machine out of your city I will not do it, for the depot is not the only house in town. I have been notified to take the machine out of the depot. Not that it was not doing all that I claimed for it, but because of the threat of the gas company to withdraw their patronage from the J., M. & I., in the way of shipping coal over their road if they did not remove it.

"With a gas company composed of men little enough for such work as this, I do not wonder that you have had reason to complain of the gas they furnished as to quality, let alone the price.

"I do not propose to be 'bull-dozed,' and it remains for you to say whether your citizens will continue to be 'bull-dozed' in the future, as you have in the past, by the gas company.

L. C. HUBER,

"Gen'l Man. Eureka Light Co., Louisville, Ky."

A perusal of the above document is calculated to incline one to the belief that Mr. Huber will never be called to fill the position of Editor-in-Chief to the Louisville *Courier Journal*, and another impression conveyed by it is that Mr. Huber will make but a poor success in the business of selling Eureka machines. Indeed we call attention to Mr. Huber and his circular simply to put other gas companies in that section of the United States on their guard as to what they may expect at his hands when he pays them a visit. The truth of the matter is that the railroad people at Franklin dispensed with Mr. Huber and his machine simply because the light supplied under its working was valueless, and the apparatus was a continual menace to the safety of the premises in which it was located.

A NEW GAS COMPANY.—Girardville (Pa.) is to be lighted by gas. A company has been organized, and we understand that the work of construction is now in progress.

THE FOSTORIA (OHIO) NATURAL GAS SEARCH.—Some three weeks ago the drillers in charge of the Fostoria gas well boring reported that when they had reached a depth of almost 1,800 feet a strong vein of salt water was encountered, and sinking operations were suspended. The well will be "shot," and if an increased flow of gas is not secured, the enterprise will probably be abandoned.

THE LIGHT OF THE FUTURE A THING OF THE PAST.—At least such an illustration is afforded by the recent action of the Massillon (Ohio) City Council. Probably incited to such action by long-continued complaint on the part of the taxpayers—the complaints being based on inadequate lighting service and extravagant cost—the Massillon councilmen, after protracted debate, at a session held Thursday, August 6th, voted to reject all bids for lighting the city streets with electricity. They also ordered that the electric conductors be removed within ten days from the passage of the order, and further determined that the gas company shall hereafter supply the public with light on streets and in the public buildings. We venture to say that many another Western city and town will follow the example set by Massillon.

STREET MAIN MILEAGES OF BROOKLYN (N. Y.) GAS LIGHT COMPANIES.—The seven gas companies doing business in the City of Churches have a total main mileage of 434.93. This mileage is apportioned or owned as follows:

Name of Company.	No. miles of main.
Brooklyn.....	71.72
Metropolitan.....	47.29
Citizens.....	38.18
Fulton Municipal.....	61.60
Nassau.....	69.18
Peoples.....	43.48
Williamsburgh.....	103.48
Total.....	434.93

STRIKING LAMPLIGHTERS.—During a part of the month of August many of the streets of Paterson, N. J., were left in darkness in consequence of the

strike of 16 lamplighters whose duty was to attend to the naphtha street lamps with which the larger portion of the night illumination of that city is supposed to be accomplished. The New York and New Jersey Globe Gas Light Company's managers have the contract for maintaining the Paterson naphtha lamps, and it would seem as though the "job" cannot be a very profitable one when it is remembered that they assumed the work at the rate of \$11.50 per lamp per year. It is asserted they are losing money at that rate of compensation, and we are free to confess that the gas men in this neighborhood will not feel badly over the fact. The lighting company employed 16 lamplighters to attend to 966 oil and naphtha lamps, and the men were paid for this service at the rate of \$45 each per month. The time consumed in the performance of their labor could safely be put at 14 hours out of each 24—Sundays and holidays proved no exception—and when it was proposed that they make a choice between submitting to a reduction in wages of five dollars per month, or that two of their number be discharged, to the end that the routes of the latter might be divided up between the remaining fourteen, it was but natural that complaints ensued. The men refused to consider either proposition, and a crisis ensued, on date of Wednesday, August 12th, when the company handed a discharge notice to one of the workmen. The entire force went on strike, and two-thirds of the city's streets were left in darkness—although the latter portion of this statement does not convey any striking intimation of great hardship, since it is a debatable question in the minds of many Patersonians as to whether they were not better off with the naphtha lamps unlighted than when the same ill-smelling vessels were supposed to be in action. It is a wonder the people of that busy city have been content with the street lighting service rendered by the New York and New Jersey Globe Gas Light Company, and we will venture the assertion that their further stay in Paterson is likely to be "limited." The central, or business portion of Paterson, however, is lighted by gas, and is well lighted, too. We have not been advised as to the final outcome of the strike, but suppose that some sort of a truce has been patched up.

THE COWS WERE AT FAULT AT NEW ORLEANS, LA.—A New Orleans correspondent on the staff of one of the New York city dailies, writing under date of Aug. 8th, shows that a certain portion of the Crescent City is laboring under trouble similar to that experienced in Paterson, at least in so far as the extinguishment of oil street lamps is concerned. There the similarity ceases, for instead of strikers being at the bottom of the New Orleans eclipse, we learn that the cows were at fault. The correspondent thus explains the matter: "The part of this city corresponding to Brooklyn, and which is known as Algiers, on account of the piratical nature of its early inhabitants, and all of the rear wards of the city, are without gas street lights. The oil lamps with which the territory has hitherto been lighted have been a delusion. Many posts were knocked down by the cows, and the lamps of those standing were seldom lit."

RAMSDELL'S ESTHETIC TASTE.—Visitors to the office of the Vincennes (Ind.) Gas Light Company on Second street in that city, especially if they are from other localities, will be rather astonished at the fact that Brother Ramsdell has blossomed out into a furnishing decorator of the most esthetic sort. This addition to his reputation has been fairly gained, and as the result of his labor he now has the neatest business office in bustling Vincennes. The room has been divided into two handsome apartments by means of a partition fitted with wide folding doors—the rear division being allotted to the purposes of the directors, while the front section will accommodate Mr. Ramsdell and his assistants. The woodwork is all cherry, and the furniture and decorations are of the handsomest description. Brother R. commissions us to extend an invitation to the fraternity to pay him a visit at his new quarters.

PERSONAL.—Mr. P. J. Wood has been reappointed Superintendent of the Wilmington (Ohio) Gas Works. Mr. Wood was in the employ of the Stacey Manufacturing Company, of Cincinnati, for sixteen years, and resigned his position with them in order to assume charge at Wilmington once before. At the request of the Stacey Company, when that firm secured the contract for the erection of the East End station of the Cincinnati Gas Light and Coke Company, Mr. Wood returned to his old post, and remained there until the station was completed. Now, as before intimated, he again resumes charge of affairs at Wilmington.

THE "INTERSTATE GAS COMPANY."—Such is the rather high-sounding appellation selected by a band of schemers (with headquarters at St. Louis, Mo.) wherewith to designate themselves. As near as we can make the matter out the "Interstate" managers propose to build gas works wherever such operation presents a likely field for profit, or wherever stock can be sold. They are to build on construction bond basis, retaining the bonds in their own keeping. The scheme is rather stale, but we understand they do not claim any novelty for it. They do claim novelty for the style of con-

struction, as this is adapted to accommodate what they call the Chamberlain process, although their Chamberlain process resembles that "discovered" by "Col." Chamberlain in no respect whatever. Yet freedom from such resemblance must certainly be in its favor—certainly, the new system cannot be expected to show poorer results than those recorded against the "Col's." pet project. A year or two (with a strong likelihood of the first-named period proving long enough) and it may be said of the "Interstate" that it died intestate. Reason—nothing to dispose of.

SEEKING CONTROL.—A special to the New York *Daily Tribune*, dated Pittsburgh, Pa., Aug. 18th, says: "Dr. Hostetter having bought the Pennsylvania Fuel Gas Company, it is now reported that he is trying to purchase a majority of the stock in the Philadelphia Company, with the purpose of consolidating the two. The stock of the latter company was bought up rapidly to-day at from 49 to 51. It is said that Dr. Hostetter has been quietly absorbing the stock for some time back." The companies alluded to are purveyors of natural gas; and, as is well known, Dr. Hostetter is very largely interested in the Pittsburgh companies engaged in the manufacture and sale of coal gas.

CHEAPER GAS FOR WASHINGTON, OHIO.—Mr. J. M. McLean, Secretary of the Washington Gas Light Company, writes us that a new schedule of gas rates goes into effect there on date of September 1st. The figures are as follows;

A monthly consumption of less than 500 cubic feet. . . . \$2.50 per M.
 " " " over 500 " " . . . 2.20 "

All consumers who use 2,000 feet of gas and over per month will be entitled to a reduction of ten per cent., provided the bills for same be paid within the month succeeding the one in which the gas was used. As an inducement for consumers to use gas in heating and cooking apparatus the company agrees to supply gas for such uses in addition to that employed for illumination on the same premises, at a uniform charge of \$2 per thousand, the only condition being that at least 1,000 cubic feet be consumed for all purposes in the 30 days. This is a novel plan, and a good one, we think. The circular sent out by the Secretary calls attention to the economy, safety, comfort and cleanliness of gas stoves for cooking operations, and notes that a complete stock of the same may be inspected at the company's office. It also conveys the information that gas stoves will be placed on trial in the houses of consumers, and should the experimenters not be pleased with them, the apparatus will be at once removed. The company sells the stoves at cost, and makes the connection to same without charge to the consumer. Mr. McLean's company has undoubtedly done the liberal thing to its patrons, and the new rates (\$2 and \$2.20) are fair in every sense. Washington Court House (for so the name of town should be written) contains but 4,500 inhabitants, and we might name a dozen towns (each possessing a far greater population than the place spoken of above) within two hours' journey from New York city where higher gas rates prevail—and leave Brooklyn entirely out of the calculation. The comparison is certainly one not greatly redounding to the credit of the wisdom of the gas men in this vicinity. Judging from Secretary McLean's final lines, he does not propose to stop at the last announcement, since he closes the circular by saying: "By way of a stimulant to those who are now burning gas, and as inducement to those who do not, we will say that any permanently marked increase in our sendout will be promptly met by a corresponding reduction in price." He means it.

VICTIMS TO KEROSENE.—In the past month has been witnessed a great sacrifice of human life due to the careless handling of kerosene. It is an absolute fact that, from a hasty reading of our exchanges, we learn of the taking place of no less than 40 deaths traceable to the kerosene horror. The plain truth thus brought out is that the laws regarding the sale of kerosene below a certain specified standard are absolutely disregarded.

CONSOLIDATION OF ELECTRIC LIGHTING COMPANIES.—During the last month the long-agitated scheme looking to the consolidation of the electric lighting interests of Boston, Mass., was consummated. The amalgamated corporation has a capital of 700,000 shares, of which the Brush interest was assigned 250,000 shares, the Weston and Merchants branches being allotted 225,000 shares each.

SUICIDES BY GAS.—During the fortnight the press despatches record the taking place of two suicides who selected gas inhalation as the easiest way of "shuffling off this mortal coil." The first case is that of Fanny Wagner, a young woman who served as a domestic in the family of a Baltimore (Md.) household. Her death occurred on date of August 16. She had closed the windows and door to her apartment as securely as possible, removed the tips from the gas burners, turned on the flow, undressed herself and went to bed. Death had taken place before discovery of her condition was made.

The second case was that of William Carleton, an actor and playwright,

who occupied a hall room on the third floor of premises No. 316 East 14th street, this city. Carleton at one time was quite prominent in the ranks of the theatrical profession; but a long course of dissipation (he was in the 58th year of his age) had alienated him from his friends. Investigation clearly proved that his death, as the consequence of an inhalation of illuminating gas, was premeditated.

ALMOST COMPLETE.—The extensive systems of enlargements commenced at the Newark (N. J.) Gas Company's works, by President and Engineer Vanderpool, some time ago, are approaching completion. Mr. Vanderpool has certainly had a busy time of it this summer; but, mentally and physically, he will be a gainer during the coming winter, even though he did forfeit his summer vacation. The new plant of the Newark Company will be complete in every essential and particular.

NATURAL GAS DISCOVERED IN CANADA.—A despatch from Montreal states that on the afternoon of August 10 a gang of laborers were engaged in sinking a well in the township of Point-aux-Trembles. When they had reached a depth of 36 feet work for the day was suspended. In the evening the keeper of an adjacent tollgate, in company with a party of friends, visited the well-hole, and while making an inspection of the progress that had been made on the work one of the party ignited a match for the purpose of lighting a cigar. The visitors were rather surprised when a slight explosion occurred, and were astonished when the explosion was followed by a roaring and hissing sheet of flame that spouted over the well mouth to a height of 20 feet or more. Shovels were procured, and 16 feet of clay had to be thrown into the hole before the flames were extinguished. Even with that covering of earth the gas flow was not entirely prevented.

STRIVING FOR CHEAPER GAS AT GREEN BAY, WIS.—Mr. Jas. G. Miller, of the Green Bay Gas Light and Fuel Company, has determined upon giving the experiment of cheap gas a fair trial in that township near the great pine forests. In order to induce an extended use of gas he informs us that all consumption registered from and after date of September first which equals or exceeds the quantity of 1,000 cubic feet per month will be charged for at the rate of \$3.50 per thousand, subject to a discount of \$1 per thousand provided the bills for same be paid on any one of the first five business days of the month. In the old rate the discount was but 50 cents per thousand. The gas makers of the West are thoroughly conversant with the fact that the new schedule at Green Bay is a low one; and Mr. Miller deserves credit for this move. For years back he has had much to contend against.

THIS ONE NOT A SUICIDE.—The following from the New York *Daily Times*, date of Sunday, August 24, explains itself: "Wilkes-Barre, Pa., Aug. 23.—J. C. Waldron, of East Smithfield, Bradford County, Pa., registered at the Summit Hotel, in this city, at midnight last night. He was shown immediately to his room on the third floor by the clerk. This morning, about 7:30 o'clock, one of the inmates of the hotel went up to his room to call him for breakfast. A rap on the door brought no response, and considering that he had retired at such a late hour no further attempt was made to arouse him. One and a half hours later a youth named Feterburg, who was playing in the upper halls, came down and said he smelled gas. The proprietors suspicions were aroused, and he went up to the apartment, but found the door was locked. He called an officer, who forced the door open and found Waldron lying dead upon the floor. The room was filled with gas, and the burner key was turned on. The victim had been in bed, but there were indications that he had had occasion to get up during the night, and had been suffocated before getting back. Money to the amount of \$1,675.71 was found, which, together with his books and papers, was deposited at the Mayor's office. Waldron was 40 years of age, and was well known in this city and the surrounding county as a prominent dealer in cattle, which he shipped by rail or drove from Bradford."

Water gas is sold in Wilkes-Barre.

KILLED BY THE ELECTRIC CURRENT.—The New York *Daily Sun*, date of August 26, contained the following: "New Orleans, La., Aug. 25.—Late yesterday evening a party of youths, from 18 to 21 years of age, gathered around the works of the Louisiana Electric Light Company on Feliciana street and toyed with the wire. They had been in the habit of unwinding the wire from a broom, tying a stone or other weight to one end of it, throwing it over the electric wire, and making the unweighted end fast to a gate knob. When the current was turned on the experimenters would seize hold of the broom wire in order to experience an electrical shock. Last evening R. E. Ahrens, becoming bolder than his companions, touched his tongue to the wire. The shock prostrated him, and his brother exclaimed, 'My God, he is killed.' At these words the sufferer arose to his feet and said, 'No; I am not yet dead.' The words had hardly been uttered when he fell to the ground, a corpse."



A. M. CALLENDER & CO.,
PROPRIETORS.

Editor—JOS. R. THOMAS, C.E
Manager—C. E. SANDERSON.

PUBLISHED ON THE 2ND AND 16TH OF EACH MONTH
At No. 42 Pine Street, New York.

This is a recognized official organ of—
LIGHT, HEAT, STEAM, WATER-SUPPLY,
VENTILATION, SANITARY IMPROVEMENT,
AND GENERAL SCIENCE.

TERMS

SUBSCRIPTION—Three Dollars per annum, in advance.

AGENTS

NEW YORK—AMERICAN NEWS Co. 39 and 41 Chambers St.
BOSTON—S. M. PETTENGILL & Co., 6 State Street.
PHILADELPHIA—PRATT & Co., Corner 9th and Arch Streets,
England—C. W. HASTINGS, 22 Buckingham St., London, W. C
Germany—B. WESTERMANN & Co., of New York

WEDNESDAY, SEPTEMBER 2, 1885.

Patents in Belgium and Austro-Hungary.

The Society of Arts *Journal* notes that from the time the law of 1854 came into force to the end of 1883, no less than 29,213 patents of invention, 26,247 of importation, and 8,674 of perfectionment or improvement, making 64,134 altogether, were granted in Belgium. During the same period 45,525 patents, not including those of improvement, were abandoned or annulled, the following figures corresponding to the years, beginning with the second—20,457, 11,599, 5,755, 2,695, 1,571, 988, 665, 412, 292, 256, 157, 118, 90, 109, 85, 27, 12, 14, 23, that is to say, more than 45 per cent. of the patents were abandoned after the first year. In Austro-Hungary, from 1852 to 1884, there were granted 34,569 patents.

Gas Stocks.

Quotations by Geo. W. Close, Broker and Dealer in Gas Stocks,
16 WALL ST., NEW YORK CITY.

SEPTEMBER 2.

All communications will receive particular attention.
The following quotations are based on the par value of \$100 per share.

	Capital.	Par.	Bid	Asked
Consolidated.....	\$35,430,000	100	92	93
Central.....	440,000	50	60	70
“ Scrip.....	220,000	—	47	57
Equitable.....	2,000,000	100	136	140
“ Bonds.....	1,000,000	—	107	110
Harlem, Bonds.....	170,000	—	—	—
Metropolitan, Bonds....	658,000	—	110	113
Mutual.....	3,500,000	100	135	137x
“ Bonds.....	1,500,000	1000	104	107
Municipal, Bonds.....	750,000	—	—	—
Northern.....	125,000	50	50	—
“ Scrip.....	108,000	—	—	—
Gas Co's of Brooklyn.				
Brooklyn.....	2,000,000	25	130	132
Citizens.....	1,200,000	20	84	86
“ S. F. Bonds....	320,000	1000	106	110

Fulton Municipal.....	3,000,000	100	158	160x
“ Bonds....	300,000	—	104	108
Peoples.....	1,000,000	10	86	88
“ Bonds.....	290,000	—	105	110
“ “.....	250,000	—	90	95
Metropolitan.....	1,000,000	100	94	96
Nassau.....	1,000,000	25	125	127x
“ Cfts.....	700,000	1000	98	99
Williamsburgh.....	1,000,000	50	155	160
“ Bonds....	1,000,000	—	111	114
Richmond Co., S. I....	300,000	50	64	75
“ Bonds.....	40,000	—	—	—
Out of Town Gas Companies.				
Buffalo Mutual, N. Y...	750,000	100	80	85
“ Bonds...	200,000	1000	95	100
Citizens, Newark.....	918,000	50	103	115
“ Bonds.	124,000	—	105	110
Chicago Gas Co., Ills...	5,000,000	25	130	140
Peoples G. L. & C. Co., Chicago, Ills.....			8	12
Cincinnati G. & C. Co..			180	182
Consolidated, Balt.....	6,000,000	100	47	48
“ Bonds....	3,600,000	—	107	107½
Central, S. F., Cal.....			—	58
Capital, Sacramento, Cal.			56	—
Hartford, Conn.....	750,000	25	123	129
Jersey City.....	750,000	20	145	—
Laclede, St. Louis, Mo.	1,600,000	100	100	105
Louisville, Ky.....	1,500,000	50	95	100
Montreal, Canada.....	2,000,000	100	181	182½
New Haven, Conn.....			25	166
Oakland, Cal.....			29	30
Peoples, Jersey City...			—	45
“ Bonds..			—	—
Paterson, N. J.....			25	90
Rochester, N. Y.....			50	75
Washington, D. C.....	2,000,000	20	212½	80
Wilmington, Del.....			50	199
Yonkers.....			50	41
St. Louis, Missouri.....	600,000	50	—	625x
San Francisco Gas Co.				
San Francisco, Cal....			56¾	57½
Havana (Cuba) Gas Co.	3,000,000	100	8	—
“ Bonds.....	550,000	—	—	—

Advertisers Index.

	Page
GAS ENGINEERS.	
Jos. R. Thomas, New York City.....	129
Wm. Henry White, New York City.....	127
GAS WORKS APPARATUS AND CONSTRUCTION.	
James R. Floyd, New York City.....	135
T. F. Rowland, Greenpoint, L. I.....	135
Deily & Fowler, Phila., Pa.....	135
Kerr Murray Mfg. Co., Fort Wayne, Ind.....	135
Stacey Mfg. Co., Cincinnati, Ohio.....	135
Bartlett, Hayward & Co., Baltimore, Md.....	135
Morris, Tasker & Co., Limited, Phila., Pa.....	134
Davis & Farnum Mfg. Co., Waltham, Mass.....	136
Tanner & Delaney Engine Co., Richmond, Va.....	134
R. D. Wood & Co., Phila., Pa.....	134
Southwark Foundry and Machine Co., Philadelphia, Pa.....	134
GAS AND WATER PIPES.	
A. H. McNeal, Burlington, N. J.....	132
Gloucester Iron Works, Phila., Pa.....	132
Warren Foundry and Machine Co., Phillipsburgh, N. J.....	132
Mellert Foundry and Machine Co., Reading, Pa.....	132
Cincinnati and Newport Iron and Pipe Co., Newport, Ky.....	132
Fox & Drummond, New York City.....	132
Ohio Pipe Co., Columbus, Ohio.....	132
PIPE JOINTS.	
Pancoast & Maule, Philadelphia, Pa.....	127
Rollstone Machine Company, Fitchburg, Mass.....	127
SCRUBBERS AND CONDENSERS.	
G. Shepard Page, New York City.....	133
REGENERATOR FURNACES.	
Charles F. Dieterich, Baltimore, Md.....	52
GAS ENGINES.	
Schleicher, Schumm & Co., Phila., Pa.....	112
Clerk Gas Engine Company, Phila., Pa.....	128
RETORTS AND FIRE BRICK.	
J. H. Gautier & Co., Jersey City, N. J.....	130
B. Kreisler & Sons, New York City.....	130
Adam Weber, New York City.....	130
Laclede Fire Brick Works, St. Louis, Mo.....	130
Brooklyn Retort and Fire Brick Works, Brooklyn, N. Y.....	130
Borgner & O'Brien, Phila., Pa.....	130
William Gardner & Son, Pittsburgh, Pa.....	130
Henry Maurer, New York City.....	130
Chicago Retort and Fire Brick Works, Chicago, Ills.....	130
Baltimore Retort and Fire Brick Co., Baltimore, Md.....	130
Standard Gas Retort and Fire Brick Co., Ironton, Ohio.....	130
Oakhill Gas Retort and Fire Brick Co., St. Louis, Mo.....	130
A. T. Chur, New York City.....	137
CEMENTS.	
C. L. Gerould, Manchester, N. H.....	127
Brooks, Shoobridge & Co., New York City.....	127
E. Thiele, New York City.....	127
GAS STOVES.	
American Meter Co., New York and Philadelphia.....	131
The Goodwin Gas Stove and Meter Co., Philadelphia, Pa.....	140
GAS METERS.	
Harris, Griffin & Co., Phila., Pa.....	128
American Meter Co., New York and Philadelphia.....	129
The Goodwin Gas Stove and Meter Co., Phila. Pa.....	129
Helme & Mellhenny, Phila., Pa.....	129
Maryland Meter and Mfg. Co., Baltimore, Md.....	128
D. McDonald & Co. Albany, N. Y.....	129
Nathaniel Tufts, Boston, Mass.....	128
EXHAUSTERS.	
P. H. & F. M. Roots, Connersville, Ind.....	129
Smith & Sayre Manufacturing Co., New York City.....	134
Wilbraham Bros., Philadelphia, Pa.....	136
GAS COALS.	
Penn Gas Coal Co., Phila., Pa.....	137
Perkins & Co., New York City.....	136
Newburgh Orrel Coal Co., Baltimore Md.....	137
Despard Coal Co., Baltimore, Md.....	137
Chesapeake and Ohio R.R. Coal Agency, N. Y. City.....	137
Westmoreland Coal Company, Phila., Pa.....	137
GAS ENRICHERS.	
W. H. Doan, Cleveland, Ohio.....	127
VALVES.	
Ludlow Valve Manufacturing Co., Troy, N. Y.....	132
John McLean, New York City.....	132
GAS LAMPS.	
Siemens Regenerative Gas Lamp Co., Philadelphia, Pa.....	133
G. Shepard Page, New York City.....	137
GAS KILNS AND OVENS.	
Thompson Gas Kiln and Oven Co., New York City.....	129
PURIFIER SCREENS.	
John Cabot, Lawrence, Mass.....	108
STREET LAMPS.	
J. G. Miner, Morrisania, New York City.....	101
Bartlett Street Lamp Mfg Co., New York City.....	129
BURNERS.	
G. Gefroerer, Phila., Pa.....	134
PURIFYING MATERIAL.	
Connelly & Co., New York City.....	129
STEAM BLOWER FOR BURNING BREESE.	
H. E. Parson, New York City.....	127
PIPE COVERINGS.	
Chalmers-Spence Company, N. Y. City.....	127
GAS FIXTURES.	
Mitchell, Vance & Co., New York City.....	127
STEAM PUMPS.	
A. S. Cameron Steam Pump Works, N. Y. City.....	129
HYDRAULIC ELEVATOR.	
Lane & Bodley Company, Cincinnati, Ohio.....	129
SHAFTING, PULLEYS, ETC.	
A. & F. Brown, New York City.....	129
HYDRAULIC MAIN.	
A. E. Boardman, Macon, Ga.....	129
BOOKS.	
The Chemist's Assistant.....	127
King's Treatise.....	139
Scientific Books.....	138
Management of Small Gas Works.....	137
Newbigging's Gas Manager's Handbook.....	130

**WANTED,
A Second-Hand 6 or 8 Inch
Steam-Jet Exhauster,
COMPLETE.**

MIDDLETOWN GAS LIGHT CO.,
628-2t Middletown, Orange County N. Y.

SUPERINTENDENT WANTED

For a small gas works in a Western Territory. Mild, healthful climate. Gas made from soft coal. Applicant must be well recommended in all respects, and be competent and willing to set meters, repair leaks, keep fixtures in order, etc. Address 628-2t "A. B. C.," care this Journal.

**FOR SALE.
Second-Hand Gas Apparatus.**

One Condenser, 4½ ft. diameter by 13 ft. in length over all, containing 150 two and one-half inch tubes, 8 ft. long with 12-in. connections and bye-pass.
Two Smith & Sayre (12-inch) Steam-Jet Exhausters, with 3 Self-acting Bye-Passes.
Four Purifying Boxes, 10 ft. by 14 ft. by 3 ft., with 12-inch connections and center seal.
All in good order, and will be sold cheap. Address
PETER P. MILLER, Manager Citizens Gas Co.,
Buffalo, N. Y.

**FOR SALE,
Second-Hand Gas Apparatus.**

The Louisville (Ky.) Gas Light Company wishes to dispose of the following:
15 Sixteen-Inch Chapman Valves.
6 Twelve-Inch Chapman Valves.
2 Twelve-Inch Center Seals & Connections.
2 Smith & Sayre Gas Steam Governors.
All in good order, and will be sold at low figures. Address inquires to
A. H. BARRET,
Engineer's Office, Louisville (Ky.) Gas Company.

**DYCKERHOFF
PORTLAND CEMENT**

Is superior to any other Portland Cement made. Its extraordinary strength permits a greater addition of sand, while its acknowledged uniformity insures the most reliable and strongest work. It is therefore the most economical to use. Circulars, with testimonials and tests, sent on application.

E. THIELE,
SOLE AGENT, U. S.,
78 William Street, - - New York.

**BROOKS, SHOBRIDGE & CO.
Best English Portland Cement**

WORKS: GRAYS, ESSEX, ENGLAND.
New York Office, No. 7 Bowling Green.

PATENTS.

FRANKLIN H. HOUGH,
Solicitor of American & Foreign Patents,
925 F. ST., WASHINGTON, D. C.
(NEAR U. S. PATENT OFFICE.)

Personal attention given to the preparation and prosecution of applications for Letters Patent. All business before the U. S. Patent Office attended to for moderate fees. **No Agency in the United States possesses superior facilities for obtaining Patents,** or for ascertaining the patentability of inventions. Copies of patents furnished for 25 cents each. Correspondence solicited.

**WM. FARMER, ENGINEER,
32 Park Place, Room 36, New York.**

THE CHEMIST'S ASSISTANT; OR, KINDERGARTEN SYSTEM OF CHEMISTRY.

A system by which the elements and their valences are represented by illustrations and solid bodies.
BOX AND PAMPHLET COMPLETE. \$2.50.

It will "Pay the Piper,"
If he aims to pipe well for STEAM, WATER, GAS, ACIDS, OILS, AMMONIA, &c., to examine this UNION, which requires no packing, but is always ready for instant use. When you next order Fittings of any Dealer, ask for a sample American Union to come with them, and it will tell you the whole story, or we will, if you write us for particulars.
PANCOAST & MAULE,
PHILADELPHIA, PA.



GAS CO. OFFICERS, READ AND REFLECT.

HODGE'S UNIVERSAL ANGLE UNION, Pat'd

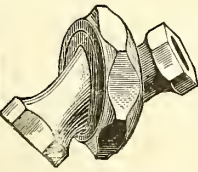

A new and important Pipe Fitting for Steam, Water, or Gas. Combining a variable angle or elbow and a union. Saves pipe, saves time, decreases friction and radiation, gives a union joint at every angle, and can be set at any angle at which it is desired to run the pipe.

HODGE'S SWIVEL FLANGE,

A common sense article, designed to save time and money.
MANUFACTURERS AND WHOLESALE AGENTS,

ROLLSTONE MACHINE CO.,
142 Water St., Fitchburg, Mass.

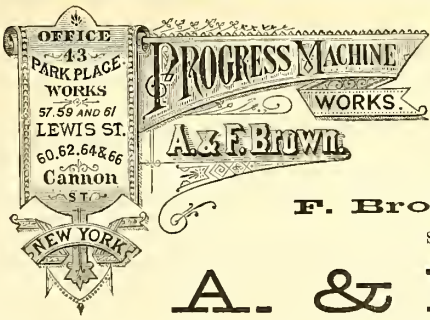

PROGRESS MACHINE WORKS.
A. & F. BROWN,
F. Brown's Patent Friction Clutch.
Send for Illustrated Catalogue and Discount Sheet to
A. & F. BROWN,
No. 43 Park Place, New York City.

Pipe Coverings.

Fireproof, Non-Conducting Coverings for
STEAM PIPES, BOILERS,
And all Hot Surfaces.

Made in sections three feet long. Easy to apply; light and cheap.
Asbestos Materials, Fibre, Braided Packing, and Cement. These goods are used at Continental Works, Br'klyn.
CHALMERS-SPENCE COMPANY, 419 & 421 EIGHTH ST., N. Y.

GEROULD'S IMPROVED RETORT CEMENT.

Used by most of the Gas Companies of the United States with perfect satisfaction. Manufactured by
C. L. GEROULD,
Manchester, IN. H.
N. B.—As Manchester is a shipping point, all freight can be shipped as cheaply as from Boston or New York.

MITCHELL, VANCE & CO.,

MANUFACTURERS OF
Chandeliers

and every description of
GAS FIXTURES.

Also manufacturers of Fine Gilt Bronzes and Marble Clocks, warranted best time-keepers. Mantel Ornaments, etc.
Salesrooms, 836 Broadway, N. Y.
Special Designs furnished for Gas Fixtures for Churches, Public Halls, Lodges, etc.

W. H. DOAN,

REFINER OF
NAPHTHA and GASOLINES

ALSO MANUFACTURER OF
A Special Grade of Naphtha for Gas Companies
FOR ENRICHING COAL GAS.

Correspondence solicited.
No. 43 Euclid Avenue, Cleveland, Ohio.

**Shafting, Pulleys,
HANGERS.**

F. Brown's Patent Friction Clutch.
Send for Illustrated Catalogue and Discount Sheet to
A. & F. BROWN,
No. 43 Park Place, New York City.

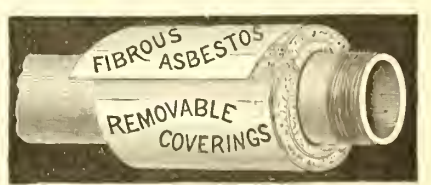

Parson's Steam Blower,

FOR IMPROVING BAD DRAUGHT IN BOILERS, AND FOR BURNING BREEZE OR OTHER WASTE MATERIAL.

PARSON'S TAR BURNER,

FOR UTILIZING COAL TAR AS FUEL.

PARSON'S AIR JET TUBE CLEANER,

FOR CLEANING BOILER TUBES.

These devices are all first-class. They will be sent to any responsible party for trial. No sale unless satisfactory. Manufactured by the WATERTOWN STEAM BLOWER COMPANY.

H. E. PARSON, Supt., 42 PINE ST., N. Y.

THE CLERK GAS ENGINE.

Highest Award [American Institute, New York, 1883. Silver Medal American Institute, N. Y., 1884.

Gold Medal Awarded Crystal Palace Electrical Exhibition, London, 1882.

Highest Award for Motive Power British Section International Exhibition of Electricity, Paris, 1881.

Reliable.
No Boiler.
Steady.
No Coal.
Simple.
No Ashes.
Compact.

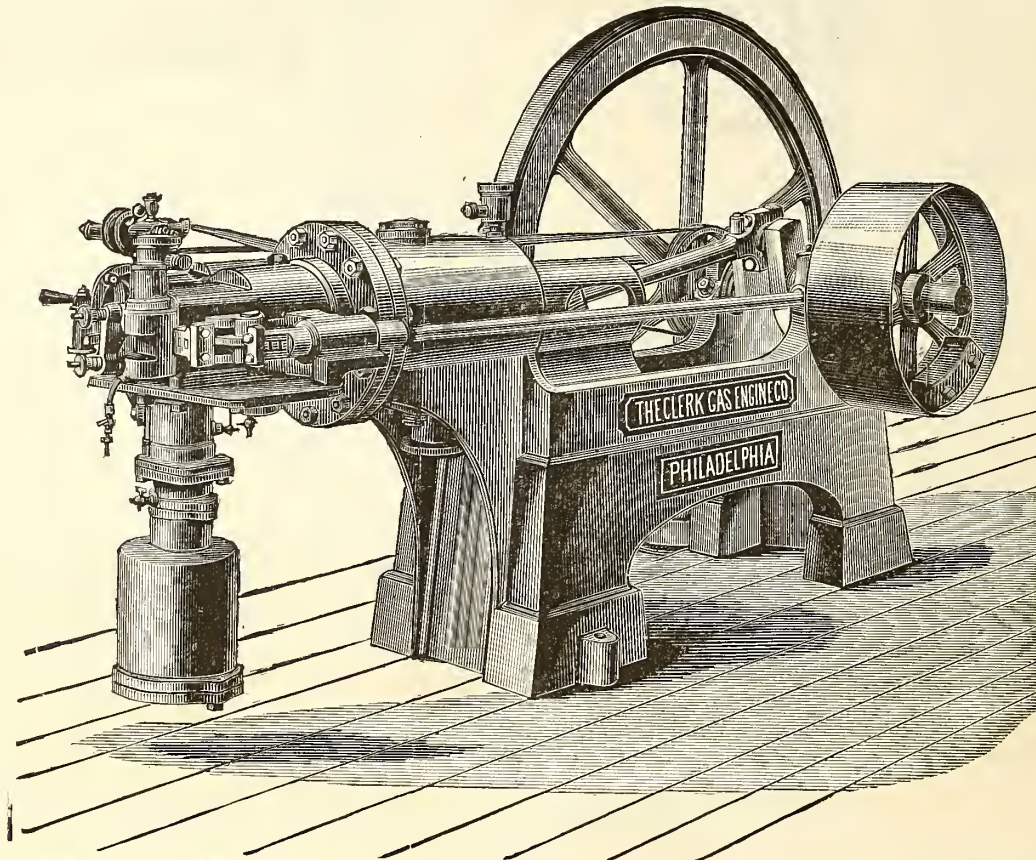

Economical.
No Engineer.
No Explosion
No Gearing
Wheels.
No Danger.
No Parts
requiring
frequent
renewal.

REQUIRING ONLY A MATCH TO START IT--GIVING ITS FULL POWER IMMEDIATELY.

We would inform the public that during the last few months we have improved THE CLERK GAS ENGINE to such an extent that we can now offer an engine vastly superior to our former pattern. These improvements have enabled us to sell our engine at a GREATLY REDUCED FIGURE, partly on account of the decreased weight (our engine weighing about half that of others giving the same Brake H. P). The consumption of gas has been decreased to a considerable extent, and the Brake H. P. has been increased some 25 to 30 per cent. All parts of the old design that were considered defective have been remodeled and new designs added. We now have an engine second to none as regards power, consumption, and ease of working. With our new engine all trouble in starting has been removed, the noise reduced to a minimum, and the regularity of motion is now all that can be desired. We guarantee all we claim for it, and the material and workmanship being of the best, enables us to guarantee the engine for twelve months.

SOLE MAKERS,

THE CLERK GAS ENGINE CO.,

WM. W. GOODWIN, President. E. STEIN, Secretary. S. LEWIS JONES, Asst. Secretary. L. P. GARRET, Supt.

Main Office, 1012-1018 Filbert Street, Philadelphia, Pa.

BRANCH OFFICES,

142 Chambers St., N. Y.

4 West Fourteenth St., N. Y.

76 Dearborn St., Chicago

General Agents,

THE GOODWIN GAS STOVE & METER CO.,

Of Philadelphia, New York, and Chicago.

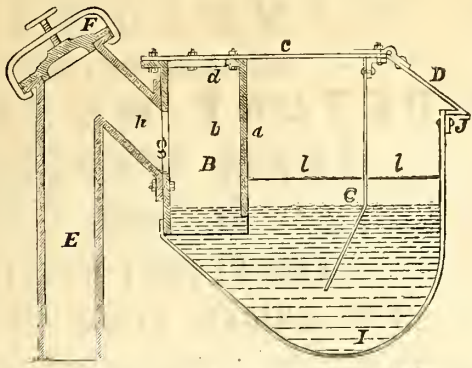

Boardman Hydraulic Main,

Patented October 7, 1884.

For description, see AM. GAS LIGHT JOURNAL of Feb. 2, 1884.
For terms, apply to

A. E. BOARDMAN, Macon, Ga.

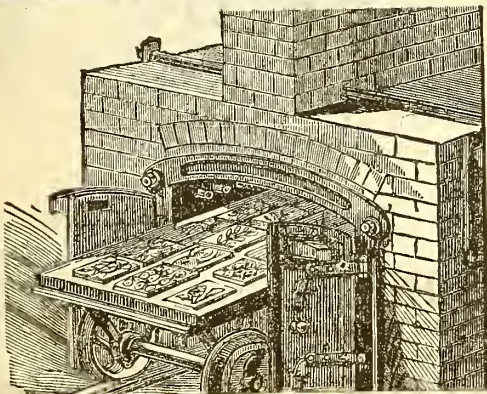

Glass-Staining Gas Kiln.

BAKERS' & CONFECTIONERS' OVENS (PAT.)

Thompson Gas Kiln & Oven Co.

59 Carmine St., N. Y.

Send for Circular by mail.

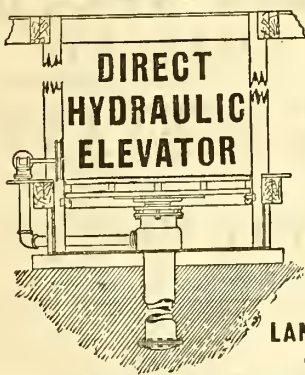

DIRECT HYDRAULIC ELEVATOR

With Iron or Wood Platform.

Largely used by Leading Gas Co.s for Coal and Coke Lifts.

Adapted for use with city service, or special pumping and accumulator system. For prices address the

LANE & BODLEY CO., Cincinnati, O.

Iron Sponge, GAS EXHAUSTERS,

AUTOMATIC GAS GOVERNORS,

CONNELLY & CO., Limited,

No. 402 BROADWAY, NEW YORK CITY.

JOS. R. THOMAS, C.E.,

May be Consulted on all Matters Relating to Gas Works and Gas Manufacture.

ADDRESS THIS OFFICE.

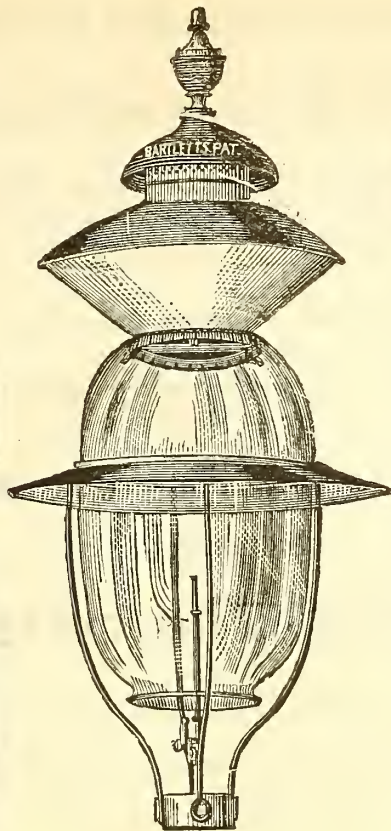

C. BARCALOW, PREST.

J. V. BARCALOW, SEC. & TREAS.

BARTLETT Street Lamp Mfg. Co.

MANUFACTURERS OF

Bartlett's Patent

GLOBE LAMPS.

FOR

Streets, Parks, Railroad Stations, Public Buildings, Etc.

LAMP POSTS A SPECIALTY.

Office and Salesroom,

No. 35 Howard Street, N. Y. City.

Gas Companies and others intending to erect lamps and posts will do well to communicate with us.

F. M. ROOTS.

S. C. ROOTS

D. T. ROOTS.

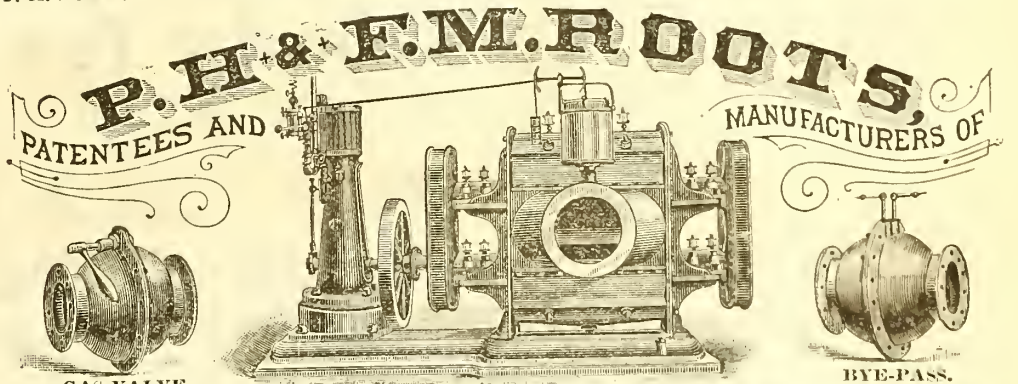

P. H. & F. M. ROOTS, PATENTEES AND MANUFACTURERS OF

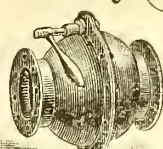

GAS VALVE.

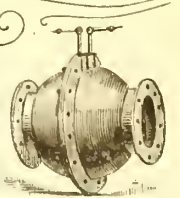

BYE-PASS.

IMPROVED GAS EXHAUSTER,

WITH ENGINE ON SAME BED PLATE, OR WITHOUT.

BYE-PASSES, GAS VALVES, GOVERNORS, ELBOWS, PIPE-FITTINGS, Etc., FURNISHED TO ORDER,

P. H. & F. M. ROOTS, Patentees & Manufacturers, CONNERSVILLE, IND.

S. S. TOWNSEND, General Agent, 22 Cortland St. and 9 Dey St., N. Y.

JAS. BEGGS & CO., Selling Agents, 9 Dey St., N. Y.

COOKE & CO., Selling Agents, 22 Cortland St., N. Y.

❖ SEND FOR ILLUSTRATED CATALOGUE AND PRICE LIST. ❖

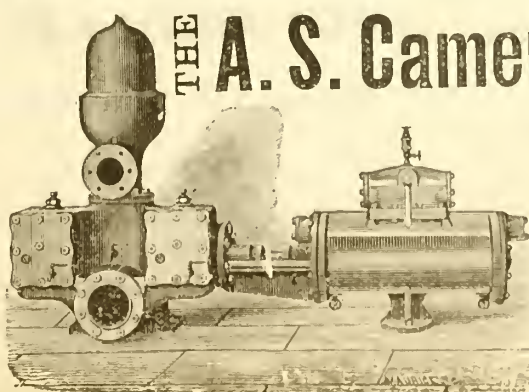

THE A. S. Cameron Steam Pump,

THE STANDARD OF EXCELLENCE.

Upward of 30,000 in Use.

BEST GAS WORKS PUMP

Ever Introduced.

Adapted to Every Possible Duty.

A. S. Cameron Steam Pump Works,

Foot East 23d St., N. Y.

J. H. GAUTIER & CO.
 CORNER OF
 GREENE AND ESSEX STREETS,
 JERSEY CITY, N. J.
 MANUFACTURERS OF
**Clay Gas Retorts,
 Gas House Tiles,
 Fire Bricks, Etc. Etc.**
 Ground Clay, Fire Brick and
 Fire Sand in Barrels,
 J. H. GAUTIER. T. B. GAUTIER.
 C. E. GREGORY. C. E. GAUTIER.

LACLEDE FIRE BRICK MFG. CO.,
 MANUFACTURERS OF
Fire Brick, Gas Retorts,
 AND
ST. LOUIS STANDARD SEWER PIPE.
 Blast Furnace and Cupola Linings, every description of Fire
 Clay Material, Fire Clay Flue Linings, Chimney Tops
 Dry Milled and Crude Fire Clays, etc.
 OFFICE AND DEPOT
 901, 903, and 905 Pine Street,
 ST. LOUIS, MO.

MANHATTAN.
 FIRE BRICK & ENAMELLED CLAY
RETORT WORKS.
ADAM WEBER.
**CLAY GAS RETORTS
 AND RETORT SETTINGS
 FIRE BRICKS, TILES, ETC.,**
 Office and Works, 15th Street and Avenue C., N. Y.

BROOKLYN
Clay Retort & Fire Brick Works,
 (EDWARD D. WHITE & CO.)
 Manufacturers of Clay Retorts, Fire Brick,
 Gas House and other Tile.
 VAN DYKE, ELIZABETH, RICHARDS & PARTITION STS.
 Office, 88 Van Dyke St., Brooklyn, N. Y.

ESTABLISHED IN 1845.
B. KREISCHER & SONS,
 OFFICE FOOT OF HOUSTON ST., E.R., N. Y.
Gas Retorts,
TILES, FIRE BRICK.
 AND EVERYTHING IN THE FIRE CLAY LINE.



JAMES GARDNER, JR.
 Works,
 LOCKPORT STATION, PA.

—ESTABLISHED 1864.—
WILLIAM GARDNER & SON,
 Successor to GARDNER BROTHERS.

WILLIAM GARDNER.
 Office, COAL EXCHANGE,
 PITTSBURGH, PA., P. O. Box 373.

Fire Clay Goods for Gas Works.

C. H. SPRAGUE, No. 70 KILBY STREET, BOSTON, MASS., Agent for the New England States.

OFFICE, 418 to 422 East 23d St., New York.

ESTABLISHED 1856.

WORKS, PERTH AMBOY, NEW JERSEY.

HENRY MAURER,
Excelsior Fire Brick & Clay Retort Works
 CLAY GAS RETORTS, BENCH SETTINGS, FIRE BRICK, TILES, ETC.

STANDARD GAS RETORT AND FIRE BRICK COMPANY,
 J. ANDERSON, PRES. & MAN'G'R. OF IRONTON, OHIO. C. PETERS, SECRETARY.
Clay Gas Retorts, Fire Brick, and Fire Clay Goods of Every Description.
 Plans of Livesey-Somerville, McIlhenny, and other Furnaces, and Competent Workmen Supplied.

CHICAGO
Retort & Fire Brick Works,
 OFFICE AND FACTORY,
 Clark, Forty-Fifth, and La Salle Streets,
 CHICAGO, ILL.
 GEORGE C. HICKS, PRES. PAUL P. AUSTIN, SEC. & TREAS.
STANDARD
Clay Retorts and Settings.
BLOCKS & TILES
 of every Shape and Size to Order.
Standard Fire Bricks.

NEWBIGGING'S
Gas Manager's Handbook.
 Price, \$4.80.
 EVERY GAS MAN SHOULD HAVE ONE.
 Orders may be sent to this Office.

OAKHILL
GAS RETORT & FIRE BRICK
COMPANY.
PARKER, RUSSELL & CO.
 City Office, 711 Pine Street,
ST. LOUIS, MO.

Our immense establishment is now employed almost entirely in
 the manufacture of
MATERIALS FOR GAS COMPANIES.
 We have studied and perfected three important points. Our re-
 torts are made to stand changes of temperature, the strongest
 heats of the furnace, and the abrasion of feeding and emptying.
 Our customers are in almost every State of the Union, to all of
 whom we refer.

THOS. SMITH, Prest. AUGUST LAMBLA, Vice-Prest. & Sup
BALTIMORE
RETORT & FIRE BRICK CO.
 MANUFACTORY AT
 LOCUST POINT, BALTIMORE, MD.
 Connection with the City by Telephone.
Clay Retorts, Blocks & Tiles,
FIRE BRICK, FIRE CLAY,
AND FIRE CEMENT.

Red and Buff Ornamental Tiles and Chim-
 ney Tops. Drain and Sewer Pipe (from
 2 to 30 inches). Baker Oven Tiles
 12x12x2 and 10x10x2.
WALDO BROS., 88 WATER ST., BOSTON, MASS
 Sole Agents for New England States

THE AMERICAN METER CO.,



Large Flat Flame Burners.
15 cts. each, \$1.50 per doz.
A test with these burners, with 18-can. gas, gives the following results:

No.	Pressure.	Consump. per H'r	Candle Power
20	1.00 in.	7.75	33.00
30	1.00 in.	9.90	42.50
40	0.85 in.	10.20	41.54
60

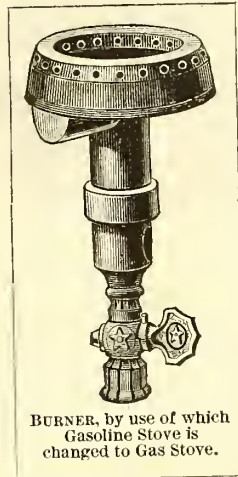

MANUFACTORIES,

508 to 514 West Twenty-second St., N. Y.

Arch and Twenty-second St., Phila.

Nos. 244 & 246 North Wells Street, Chicago, Ill.

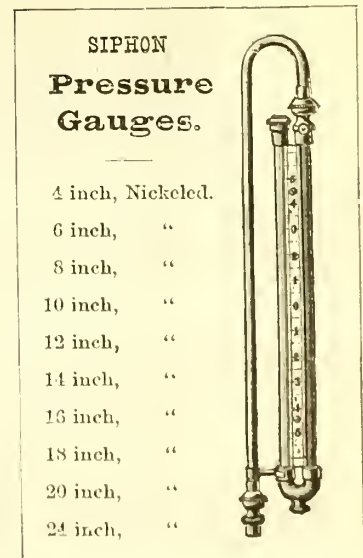
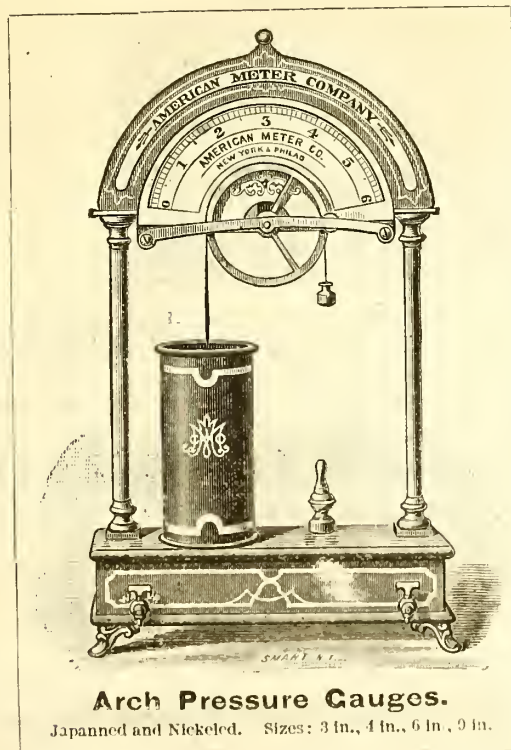
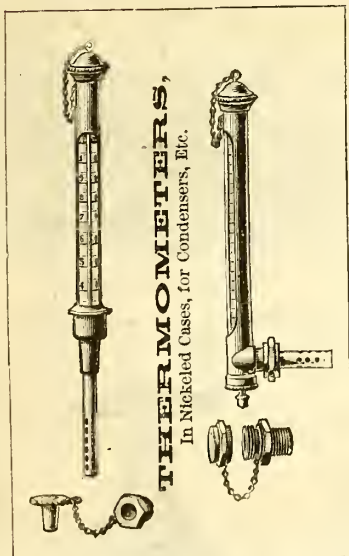

AGENCIES,

No. 177 Elm Street, Cincinnati, Ohio.

Nos. 122 & 124 Sutter Street, San Francisco Cal.

No. 810 North Second Street, St. Louis, Mo.

A. H. M'NEAL,

BURLINGTON, N. J.

Flange-Pipes

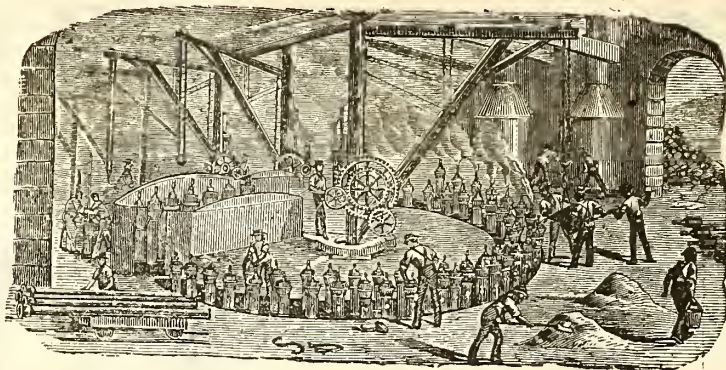

General Foundry Work.

CAST IRON PIPES FOR WATER AND GAS.

JAMES S. MOORE, Pres.
BENJAMIN CHEW, Treas.

JAS. P. MICHELLON, Sec.
WM. SEXTON, Supt.

GLOUCESTER IRON WORKS, GLOUCESTER CITY, N. J.

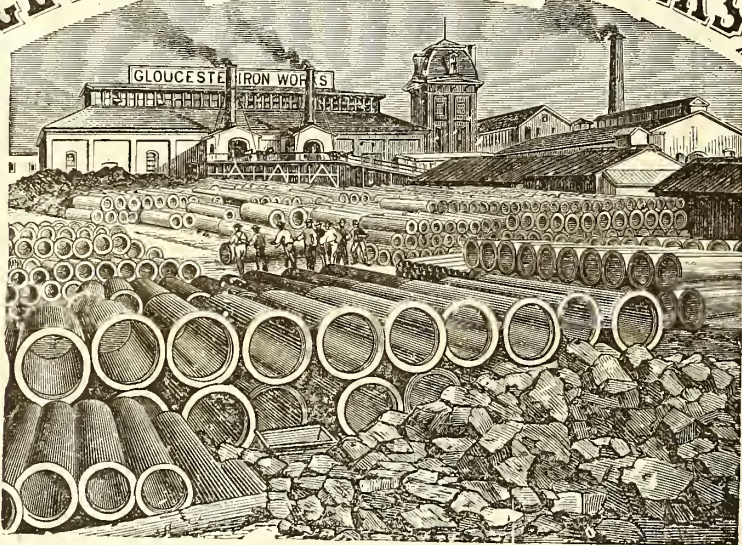

Cast Iron Gas & Water Pipes, Stop Valves, Fire Hydrants, Gasholders, &c.
Office No. 6 North Seventh Street, Philadelphia.

ESTABLISHED 1856.

WARREN FOUNDRY AND MACHINE CO.,

WORKS AT PHILLIPSBURGH, N. J.
NEW YORK OFFICE, 162 BROADWAY.

Cast Iron Water and Gas Pipe

FROM TWO TO FORTY-EIGHT INCHES DIAMETER.
ALSO ALL SIZES OF

FLANGE PIPE for Sugar House and Mine Work.
Branches, Bends, Retorts, Etc., Etc.

436-1

MATHEW ADDY, President.

W. L. DAVIS, Selling Agent.

GEO. P. WILSHIRE, Sec. & Treas.

Cincinnati and Newport Iron and Pipe Company,

NEWPORT, KY.

Lamp Posts
AND
BENCH CASTINGS

A Specialty.

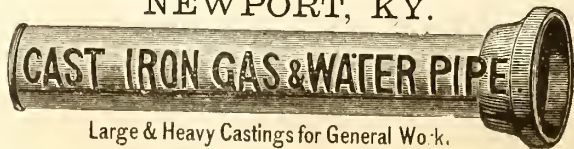

Large & Heavy Castings for General Work.

Manufacture Pipe from 2 to 48 inches, All work guaranteed first quality.

Branch
AND
SPECIAL CASTINGS
FOR GAS & WATER CO'S.

Mellert Foundry and Machine Co.

Limited. Established 1848.

MANUFACTURERS OF



Specials—Flange Pipe, Valves and Hydrants,
Lamp Posts, Retorts, etc.
Machinery and castings for Furnaces, Rolling Mills, Grist and
Saw Mills, Mining Pumps, Hoists, etc.

GENERAL OFFICE, - - - READING, PA.

CAST IRON

Gas and Water Pipes,

From 2 to 48 Inches in Diameter.

FOX & DRUMMOND,

160 Broadway, N. Y. City.

THE OHIO PIPE COMPANY,

MANUFACTURERS OF

Cast Iron Gas & Water Pipe,

BRANCH AND SPECIAL CASTINGS.

Gas-House Bench Castings, Hydraulics, Lamp Posts, Flange Pipe
and Specials, Architectural Castings, Building Columns,
Joists, C'lar Grates, Sash Weights, etc.

GENERAL FOUNDERS AND MACHINISTS.

Columbus, Ohio.

LUDLOW VALVE MFG. CO.

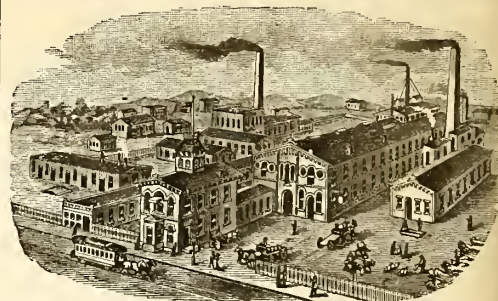

OFFICE AND WORKS,

938 to 954 River Street and 67 to 83 Vail Av.
TROY, N. Y.

Hydraulic Main Dip Regulators, also
Check Valves, Foot Valves, Yard-
wash and Fire Hydrants.
Send for Circulars.

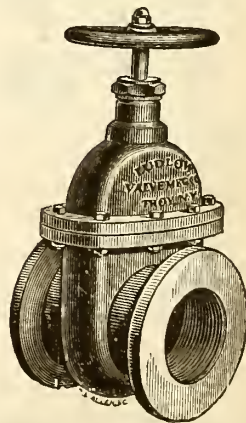

Valves.—Double and Single Gate, 1/2 in. to
48 in., outside and inside Screws. Indica-
tor, etc., for Gas, Water, Steam, and Oil.
Send for Circulars.

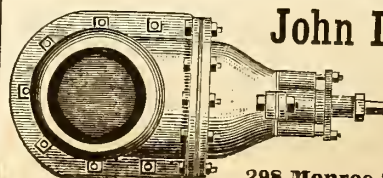

John McLean

Manufacturer of

**GAS
VALVES.**

298 Monroe Street, N. Y.

Siemens's Regenerative Gas Burners, For Lighting and Ventilating.

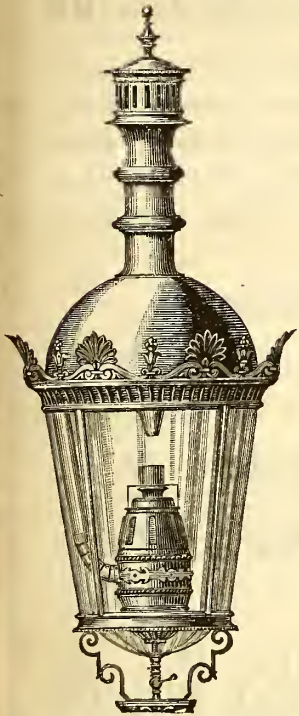

THE CHEAPEST, PUREST, AND MOST BRILLIANT OF ALL GAS LIGHTS.

Superior to the Electric Light in Economy, Beauty, & Steadiness.

SPECIALLY ADAPTED FOR LIGHTING HALLS, FACTORIES, OPEN SPACES, ETC.

Numerous Tests made by various Gas Companies in the United States show an Efficiency of Ten Candle Power per Cubic Foot of Gas.

General Agents:

- SIEMENS LIGHTING CO., 347 West Main St., Louisville, Ky.
- MEYER, MARSHALL & CO., 528 California St., San Francisco.
- DENNEHY, WOLF & O'BRIEN, 85 & 87 Dearborn St. Chicago, Ill.
- WILCOX & McCEARY, - No. 11 Bissel Block, Pittsburgh, Pa.
- T. T. RAMSDALL & CO., - 20 Swan Street, Buffalo, N. Y.
- SIEMENS GAS ILLUMINATING CO.,
Room 6, No. 157 Broadway, New York City.
- W. D. COLT, - - - - 1420 F Street, Washington, D. C.
- JOHN KIEFER, - - - 344 Lawrence, Street, Denver, Col.

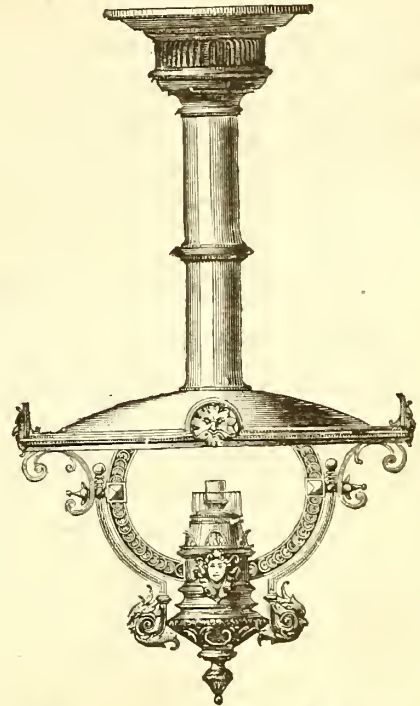

THE SIEMENS REGENERATIVE GAS LAMP COMPANY,
SOLE MAKERS FOR THE UNITED STATES,
N. E. Cor. 21st. St. and Washington Av., Philadelphia, Pa.

THE "STANDARD" WASHER-SCRUBBER, KIRKHAM, HULETT & CHANDLER'S PATENT.

Total Capacity per 24 Hours of "Standard" Washers Ordered During the Following Years.

1877.....	4,000,000 cubic feet.
1878.....	4,750,000 "
1879.....	24,545,000 "
1880.....	42,907,500 "
1881.....	35,462,500 "
1882.....	39,300,000 "
1883.....	57,735,000 "
1884.....	26,177,500 "
Total.....	235,937,500 cubic feet.

Total Number and Capacity per 24 Hours of "Standard" Washers Erected and in Course of Erection in the Several Countries

	Number.	Cubic Feet per Day.
Great Britain..	151	157,070,000
Western Hemisphere.....	38	39,337,500
Australia.....	18	12,150,000
New Zealand	2	650,000
France	6	4,550,000
Belgium.....	8	5,420,000
Germany.....	16	8,200,000
Holland.....	4	4,160,000
Denmark.....	1	150,000
Russia.....	2	3,500,000
Spain.....	1	350,000
India.....	1	400,000
Total.....	248	235,937,500

THE CONTINUED POPULARITY

Of these Machines

Will be recognized from the following extracts from letters from representatives of some of the companies having them in use:

PROVIDENCE GAS COMPANY. }
PROVIDENCE, R. I., Nov. 24, 1884. }
GEO. SHEPARD PAGE, Esq., New York:

Dear Sir—We are now using less than a gallon of water per thousand in the "Standard," and the gas at the outlet will not color turmeric paper.

Yours, etc.,

A. B. SLATER, Treasurer.

PORTLAND GAS COMPANY. }
PORTLAND, ORE., Nov. 29, 1884. }
GEO. SHEPHERD PAGE, New York:

Dear Sir—Our Scrubber appears to run to our entire satisfaction, and we are pleased to say that it takes out all the ammonia from the gas. This is *very* satisfactory to us, as we were ruining our meters at a fearful rate heretofore. The amount of water used is very inconsiderable as compared with our old process. The machine runs very smooth and still.

Very respectfully,

H. C. LEONARD, Secretary.

"Standard" Washers Ordered Recently.

	Cu. Ft. per Day
Anneberg Gas Co.....	200,000
Bombay Gas Co.....	400,000
Brussels Co.....	1,250,000
CHICAGO, two, 1,000,000 each.....	2,000,000
Chemnitz Gas Co.....	1,000,000
CITIZENS GAS CO., BUFFALO.....	750,000
Coke Works in Zabre, Ober-Schlesien.....	1,500,000
Cokerel der Friedenshutte, Upper Silesia.....	1,000,000
Dumfries Corporation.....	250,000
Dunedin Gas Co., New Zealand.....	400,000
GEORGETOWN, D. C.....	250,000
King's Lynn Gas Co.....	300,000
Leiden, Holland.....	600,000
Lincoln Gas Co.....	400,000
Liverpool Gas Co.....	2,000,500
".....	3,000,000
LOUISVILLE GAS CO.....	1,500,000
Nunee Gas Co.....	100,000
PITTSBURGH GAS CO.....	1,500,000
PAWTUCKET, R. I.....	500,000
PORTLAND GAS CO., OREGON.....	502,500
SAN FRANCISCO GAS CO.....	4,000,000
Sheepbridge.....	40,000
ST. LOUIS GAS CO.....	2,000,000
Sydney Gas Co.....	2,500,000
WASHINGTON, D. C. GAS CO.....	2,000,000
Whitechurch Gas Co.....	175,000
Total.....	19,677,500

GEO. SHEPARD PAGE, No. 69 WALL STREET, NEW YORK,

SOLE AGENT FOR THE WESTERN HEMISPHERE.

R. D. WOOD & CO.,

400 Chestnut Street, Phila., Pa.

Cast Iron Gas & Water Pipe, Water Machinery & Gas Apparatus

Cast Iron Pipe, Fire Hydrants, Eddy Valves, Lamp Posts, Large Loam Castings, Flanged Pipe, Sugar House Work, Iron Roofs and Floors, Wrought & Cast Iron Tanks, Turbine Water Wheels and Pumps.

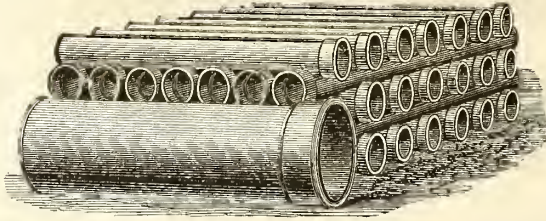

Casholders, Lime Trays, Center Valves, Purifiers, Bench Work, Exhausters, Condensers, Governors, Scrubbers, Gas Valves, Station Meters, Cast Iron Pipe Fittings.

Manufacturers of Heavy Castings and Machinery of Every Description.

ENGINEERS & CONTRACTORS FOR THE ERECTION OF GAS WORKS, & ALL MACHINERY CONNECTED THEREWITH

Estimates and specifications furnished for erection of new works or the extension or alteration of old ones.

Foundries and Works, - - Millville, Florence, and Camden, N. J.

SMITH & SAYRE MFG. COMPANY,

G. G. PORTER, Prest.

245 Broadway, N. Y.

CHAS. W. ISBELL, Sec'y.

Machinery & Apparatus for Gas Works

Drawings, Plans, and Estimates Furnished for the Improvement, Extension, or Alteration of Gas Works, or for the Construction of New Works.

Mackenzie's Patent Rotary and Steam Jet Gas Exhausters, Governors, Compensators, Condensers, Washers, Scrubbers. Isbell's Patent Automatic Street Pressure Governor, Gas and Water Valves, Hydraulic Main Dip Regulator, Bench Castings, etc. Purifying Boxes and "Standard" Scrubbers. Isbell's Patent Self-Sealing Retort Doors.

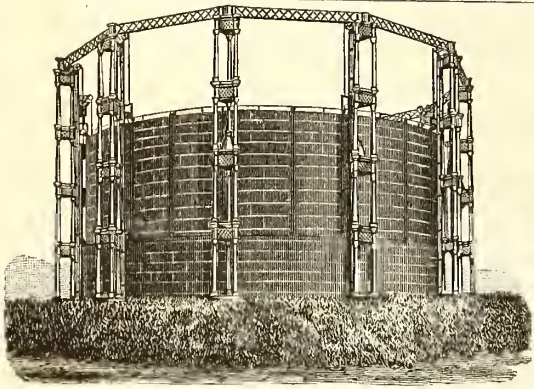
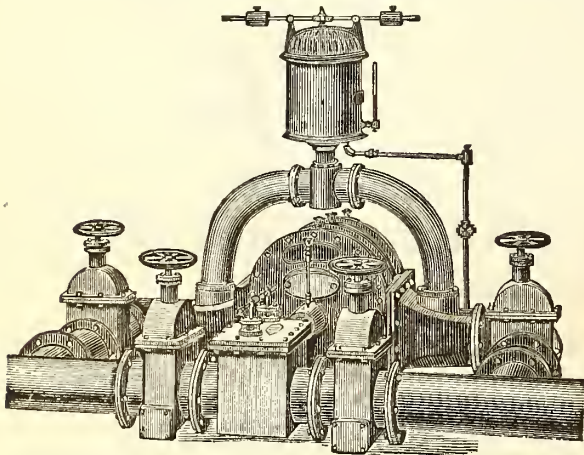

W. E. Tanner, Pres., W. R. Trigg, V.-Pres., A. Delaney, Supt.

Tanner & Delaney Engine Co.
RICHMOND, VA.

Gas Apparatus,

INCLUDING
Condensers of various styles, Scrubbers, Holders, Purifiers, Castings for Retort Houses, Etc.

ALSO STEAM ENGINES AND BOILERS.
Plans, Specifications and Estimates Furnished.

MORRIS, TASKER & CO.,

Limited,

Builders of Gas Works,
PHILADELPHIA, PA.

To Gas Companies.

We make to order **CAP BURNERS** to burn any amount under a stated pressure. Send for samples.
Also, **SERVICE CLEANERS, DRIP PUMPS,** and **STREET MAIN PROVING APPARATUS.**

C. A. GEFROER,
248 N. 5th Street, Phila., Pa.

SOUTHWARK FOUNDRY AND MACHINE COMPANY,

Successors to **MERRICK & SONS.** Established in 1836.

No. 430 Washington Avenue, Philadelphia, Pa.

MANUFACTURERS OF

Single and Telescopic Gasholders,

BENCH CASTINGS,

Washers, Scrubbers, Condensers, Purifiers,

And all apparatus necessary for the construction of improved new gas works and in the extension of established works. Also manufacturers of

Gas Engines, and of all descriptions of Steam and Hydraulic Machinery, and of Boiler and Tank Work.
Plans, specifications, and estimates furnished promptly on application.

W.M. HENRY WHITE,

Consulting & Constructing
Gas Engineer & Contractor.

ESTIMATES, PLANS, AND SPECIFICATIONS FURNISHED
FOR NEW WORKS OR EXTENSIONS OF
EXISTING WORKS.

32 Pine St., New York City.

Correspondence solicited.

KERR MURRAY MFG. CO.,

MANUFACTURERS OF

Single Lift and Telescopic GASHOLDERS.

Built, 1884:

Altoona, Pa.	Capacity, 160,000 cubic feet.
Pittsburgh, Pa.	" 250,000 "
" "	" 230,000 "
Bellaire, Ohio.	" 50,000 "
Youngstown, Ohio.	" 60,000 "
Canton, "	" 60,000 "
Akron, "	" 80,000 "
Xenia, "	" 10,000 "
Adrian, Mich.	" 65,000 "
Ypsilanti, Mich.	" 25,000 "
Muskegon, "	" 70,000 "
South Bend, Ind.	" 70,000 "
Anderson, "	" 20,000 "
Plainfield, "	" 10,000 "
Springfield, Illinois.	" 100,000 "
Evanston, "	" 50,000 "
Freeport, "	" 35,000 "
Elgin, "	" 60,000 "
Sheboygan Wis.	" 20,000 "
Key West Fla.	" 10,000 "

Plans and estimates furnished for the erection of new and the rebuilding of old works. Address

Kerr Murray Mfg. Co.,
FORT WAYNE, IND.

JAMES R. FLOYD,
(SUCCESSOR TO HERRING & FLOYD)

Oregon Iron Works,
531 to 543 West 20th St., N. Y.
Practical Builders of Gas Works,
MANUFACTURERS OF
ALL KINDS OF CASTINGS
AND
APPARATUS FOR GAS-WORKS.

BENCH CASTINGS
from benches of one to six Retorts each.
WASHERS: MULTITUBULAR AND AIR CONDENSERS; CONDENSERS; SCRUBBERS
wet and dry), and
EXHAUSTERS
for relieving Retorts from pressure.
BENDS and BRANCHES
of all sizes and description.
FLOYD'S PATENT MALLEABLE RETORT LID.
PATENT SELF-SEALING RETORT LIDS.
FARMER'S PATENT BYE-PASS DIP-PIPE.
SABBATON'S PATENT FURNACE DOOR AND FRAME.
BUTLER'S COKE SCREENING SHOVELS.

GAS GOVERNORS,
and everything connected with well regulated Gas Works at low price, and in complete order.

SELLER'S CEMENT
for stopping leaks in Retorts.
N. B.—STOP VALVES from three to thirty inches—at very low prices.
Plans, Specifications, and Estimates furnished.

CONTINENTAL WORKS.

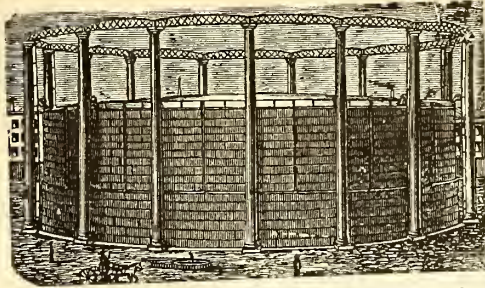

GASHOLDERS OF ANY MAGNITUDE.

T. F. ROWLAND, Proprietor,
GREENPOINT, BROOKLYN, N. Y.
ENGINEER AND MANUFACTURER OF
GAS-HOLDERS.
CONDENSERS, SCRUBBERS, VALVES,
PURIFIERS, RETORTS, and HY-
DRAULIC MAINS,

and all other articles connected with the Manufacture and Distribution of Gas. Plans and Specifications prepared and Proposals given for the necessary Plant for Lighting Cities, Towns, Mansions, and Manufactories.

H. RANSHAW, Prest. & Mangr. WM. STACEY, Vice-Pres. T. H. BIRCH, Asst. Mangr. R. J. TARVIN, Sec. & Treas.

STACEY MFG. CO.,

MANUFACTURERS OF

Single and Telescopic Gasholders,

IRON ROOFS, BRIDGES, LAMP POSTS,

Water and Oil Tanks, Coal Elevator Cars,
COKE CRUSHERS, BENCH CASTINGS,

And all kinds of Wrought and Cast Iron Work used in the erection of Coal and Oil Gas Works.
Rolling Mill Machinery and Heavy Castings a Specialty.

Foundry: 33, 35, 37 & 39 Mill Street. **Wrought Iron Works:** 16, 18, 20, 22, 24 & 26 Ramsey Street.

Cincinnati, Ohio.

BARTLETT, HAYWARD & CO.,

Office, 24 Light. **BALTIMORE, MD.** Works, Pratt &

PURIFIERS.
Roofs.
Bench Castings.

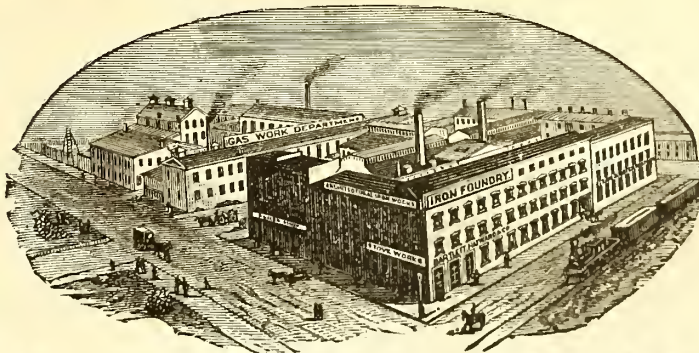

CONDENSERS.
BOILERS.
SCRUBBERS.

GASHOLDERS.

CONSTRUCTING ENGINEERS AND BUILDERS OF GAS WORKS.

1842. **DEILY & FOWLER, 1885.**

Laurel Iron Works.

Address, No. 39 Laurel Street, Philadelphia, Pa.

MANUFACTURERS OF

GASHOLDERS,

Single or Telescopic, with Cast or Wrought Iron Guide Frames.

Holder Built Since 1880:

Mount Joy, Pa.	West Point, N. Y.	Galveston, Texas (2d.)	Kalamazoo, Mich. (3d.)	Newport, R. I.
Rockaway B'ch, N.Y. (2)	Fitchburgh, Mass.	Marlboro, Mass.	Glen Island, N. Y.	Portland, Oregon.
Zanesville, O. (2d.)	New London, Conn.	Denver, Col.	Warren, Ohio.	Allegheny, Pa. (2d.)
Lancaster, O.	Derby, Conn.	Chicago, Ill. (West Side).	Bath, N. Y.	Atlanta, Ga. (2d.)
Blackwell's Island N. Y.	Bridgeport, Conn.	Pittsburgh, Pa. (S. Side).	Lynn, Mass.	N. Y. City (Central (ia.)
Waltham, Mass., (1st.)	Allegheny, Pa. (1st.)	Pawtucket, R. I.	Now Bedford, Mass.	Lynchburg, Va. (2d.)
Dorchester, Mass.	St. Hyacinth, Ctn.	Brookline, Mass.	Waterbury, Conn.	Saylesville, H. I.
Wheeling, West Va.	Norwalk, O.	Sherbrooke, Can.	Deseronto, Can.	Rondout, N. Y.
Lansing, Mich.	Brattleboro, V	Burlington, N. J. (2d.)	Hoosic Falls, N. Y. (2d.)	Atlantic City, N. J.
Flint, Mich.	Waltham, Mass. (2d.)	Bridgeton, N. J.	Bethlehem, Pa.	Augusta, Ga.
Galveston, Texas (1st.)	West Chester, Pa.	Bay City, Mich.	Atlanta, Ga. (1st.)	Waltham, Mass. (2)
Milton, Pa.	Baltimore, Md.	Erie, Pa.	Savannah, Ga.	
Scranton, Pa.	Hollidaysburg, Pa.	Jackson, Mich.	Montgomery, Ala	

GAS COALS.

GAS COALS.

GAS COALS.

JAMES D. PERKINS.

PERKINS & CO.,

F. SEAVERNS.

General Sales Agents for

**The Youghioghenny River Coal Company's
OCEAN MINE YOUGHIOGHENY GAS COAL.**

The Coal from the Ocean Mine (recently operated by Messrs. W. L. Scott & Co., of Erie, Pa.,) is now used by all the leading Gas Companies in the United States from Maine to Texas, and is recognized as *the only reliable Youghioghenny Gas Coal.* (See Map on p. 87 of this Journal, Feb. 16, 1885.)

P. O. Box 3695,
New York.

PERKINS & CO., 228 and 229 N. Y. Produce Exchange

**BEAVER STREET
ENTRANCE.**

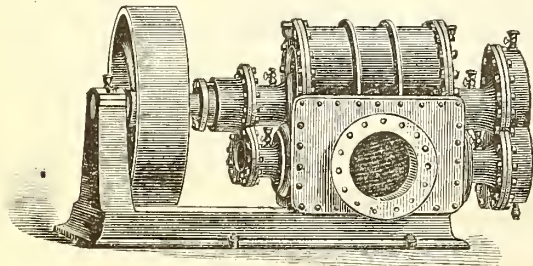

Gas Exhauster Driven by Belt.

The Wilbraham Gas Exhauster,

"BAKER SYSTEM,"

WITH ENGINE ATTACHED, ON SAME BED PLATE OR WITHOUT.

Best, Cheapest and Most Durable Exhauster known.

WILBRAHAM BROS.,

No. 2320 Frankford Avenue, Philadelphia, Pa.

F. J. DAVIS & J. R. FARNUM,

TRUSTEES AND AGENTS FOR THE

SINUOUS FRICTION CONDENSER.

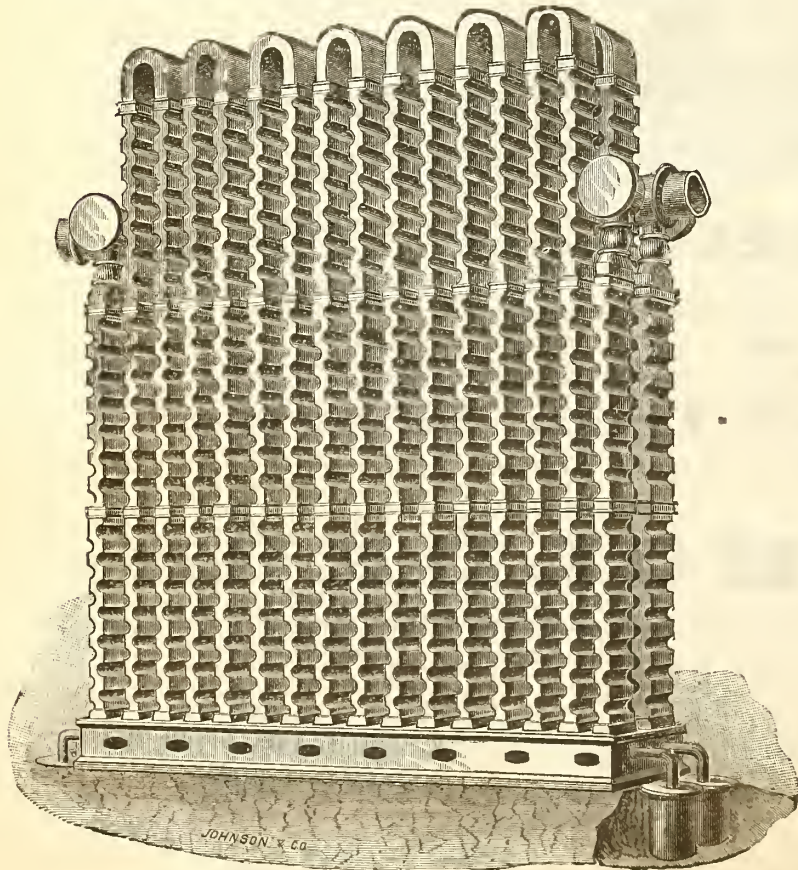

We desire to draw the attention of the gas community to the merits of the **SINUOUS FRICTION CONDENSER.** Companies intending to introduce new condensers into their works will do well to confer with us and examine plans and estimates before contracting for any other pattern. The **FRICTION CONDENSER** is now in use at the gas works located in the following places:

- | | | | |
|--------------------------------|------------------|-------------------------------|---------------------|
| Portland, Me. | Brookline, Mass. | Pawtucket, R. I. | Frederickton, N. B. |
| Newport, R. I. | Chelsea, Mass. | Jamaica Plain, Mass. | St. John, N. B. |
| Gloucester, Mass. | Woburn, Mass. | Attleboro, Mass. | Paterson, N. J. |
| Newton & Water-
town, Mass. | Peoria, Ill. | Calais, Me. | Dover, N. H. |
| | Clinton, Mass. | Fall River, Mass. | Waltham, Mass. |
| | | Nassau Works, Brooklyn, N. Y. | |

DAVIS & FARNUM MFG. CO.

MANUFACTURERS OF

Gas and Water Pipes,

AND

GAS AND WATER MACHINERY

OF THE MOST APPROVED PATTERN.

Also, Gasholders and Iron Roofing.

Orders from Gas and Water Companies promptly attended to.

WALTHAM, MASS.

Boston Office, Room 55, Mason Building, 70 Kilby Street.

GAS COALS.

GAS COALS.

GAS COALS.

Newburgh Orrel Coal Co.,

MINERS AND SHIPPERS OF

**Newburgh Orrel, Tyrconnell
and Palatine Gas Coals.**

ALSO SHIPPERS OF FOUNDRY COKE.

Mines Situated at

Newburgh, Flemington & Fairmont, W.Va.

HOME OFFICE,

25 S. Gay St., Baltimore.

**CHARLES MACKALL,
MANAGER.**

CHAS. W. HAYS, Agent in New York,

Room 92, WASHINGTON BUILDING, No. 1 Broadway.

Shipping wharves at Locust Point. References furnished when required. Special attention given to chartering vessels.

THE DESPARD COAL COMPANY

OFFER THEIR SUPERIOR

DESPARD COAL

To Gas Light Companies and Manufacturers of Fire Clay Goods
Throughout the Country.

ROUSSEL & HICKS, } AGENTS. { BANGS & HORTON,
71 Broadway, N. Y. } 16 Kilby St., Boston.

Mines in Harrison Co., West Va. Wharves, Locust Point, Balt.

Company's Office, 15 German St., Baltimore, Md.

Among the consumers of Despard Coal we name: Manhattan
Gas Light Co., N. Y.; Metropolitan Gas Light Co., N. Y.; Jersey
City, (N. J.) Gas Light Co.; Washington (D. C.) Gas Light Co.;
Portland (Maine) Gas Light Co. Reference to them is requested.

WELSH "ABERNANT"

Silica Dinas Fire Brick & Cement.

Unrivalled for Endurance Under Intense
Heat. Percentage of Silica, 95.64.

Also SCOTCH "BLOCHAIRN" FIRE BRICK.

A. T. CHUR,

SOLE AGENT FOR THE UNITED STATES,

Mills Building, Room 14, Fifth Story, New York.

PRESERVE

The Journal

BY THE USE OF

THE STRAP FILE.

Advantages of the Strap File.

- 1st. It is simple, strong, and easily used.
- 2d. Preserves papers without punching holes.
- 3d. Will always lie flat open.
- 4th. Allows any paper on file to be taken off without disturbing the others.

Price, \$1.25. Sent either by express or mail, at directed. By mail the postage will be 20 cents, which will be added to the price of the Binder.

A. M. CALLENDER & CO., 42 PINE ST., N. Y.

**THE
PENN GAS COAL CO.**

OFFER THEIR

Coal, Carefully Screened & Prepared for Gas Purposes.

Their Property is located in the Youghiogheny Coal Basin, near Irwin and Penn Stations on the
Pennsylvania Railroad, and on the Youghiogheny River.

Principal Office:

209 SOUTH THIRD STREET, PHILA., PA.

Points of Shipment:

Pennsylvania Railroad Piers; Greenwich Wharves, Delaware
River; Pier No. 1 (Lower Side), South Amboy, N. J.

Chesapeake & Ohio Railway Coal Agency,

FOR THE SALE OF THE

Superior Kanawha Gas Coals, Cannelton Cannel,

Also, **SPLINT AND STEAM COALS,**

From the Kanawha and New River Regions, on the line of the Chesapeake & Ohio R'way.

C. B. ORCUTT, Sales Agent. | OFFICE, 150 BROADWAY, N. Y.

FRANCIS H. JACKSON, PRESIDENT.

EDMUND H. MCCULLOUGH, SEC. & TREAS.

THE WESTMORELAND COAL CO.

Chartered 1854.

Mines situated on the Pennsylvania and the Baltimore
and Ohio Railroads, in Westmoreland County, Penn.

POINTS OF SHIPMENT:

PHILADELPHIA, BALTIMORE, SOUTH AMBOY, N. J.
WATKINS (SENECA LAKE), N. Y.

Since the commencement of operations by this Company its well-known
Coal has been largely used by the Gas Companies of New England and the
Middle States, and its character is established as having no superior in gas-
giving qualities, and in freedom from sulphur and other impurities.

Principal Office, 224 South 3d St., Phila., Pa.

The Bower Gas Lamp.

The Perfected Duplex-Regenerative Gas Burner, under
the combined Patents of Anthony S. Bower,
Geo. S. Grimston, and Thos. Thorp.

The First Gold Medal awarded at the Crystal Palace Exhibition in
London, and two Gold Medals at the Stockport (Eng.) Exhibition of Gas
Appliances. Both in 1883.

GEO. SHEPARD PAGE, JOHN BOWER,
69 Wall Street, N. Y. City.

The Management of Small Gas Works.

By C. J. R. HUMPHREYS. Price, \$1.

A. M. CALLENDER & CO., 42 Pine St., N. Y.



INTERNATIONAL--1876--EXHIBITION.

The U. S. Centennial Commission

HAVE DECREED AN AWARD TO

HARRIS, GRIFFIN & CO.,

Twelfth and Brown Streets, Philadelphia, Pa., No. 49 Dey Street, N. Y. City, and No. 75 North Clinton Street, Chicago, Ill.,

FOR THE FOLLOWING REASONS :

The Exhibit consists of a Series of METERS from the Largest Size Station Meters for the use of the MANUFACTURE OF GAS, to those for the use of the ORDINARY CONSUMER. The Instruments are WELL MADE, RELIABLE as to INDICATION, and embody a number of sundry improvements which, with the general character of the Exhibit, entitle the whole to commendation.

Attest—J. L. CAMPBELL,
Secretary, pro-tem.

Signed—A. T. GOSHORN,
Director General

J. R. HAWLEY,
President

CHARLES E. DICKEY.

JAMES B. SMALLWOOD.

CHARLES H. DICKEY.

Maryland Meter and Manufacturing Co.,
DICKEY, TANSLEY & CO.,

Established 1866.

Nos. 22 and 24 Saratoga Street, Baltimore, Md.
No. 46 La Salle St., Chicago, Ill.

MANUFACTURERS OF

DRY GAS METERS, STATION METERS, GLAZED METERS, TEST METERS, METER PROVERS, PRESSURE AND VACUUM REGISTERS, GOVERNORS, INDICATORS, SERVICE AND METER COCKS, AND METER CONNECTIONS.

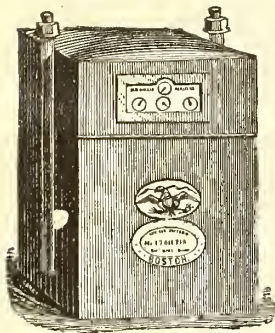

Dry Gas Meter.

With 39 years' experience and the best facilities for manufacturing, is enabled to furnish reliable work and answer orders promptly.

NATHANIEL TUFTS,

No. 153 Franklin Street, Boston, Mass.,

MANUFACTURER OF

DRY GAS METERS.

Station Meters of any Capacity.

Test and Experimental Meters, Pressure Registers, Pressure Gauges,
Pressure and Vacuum Gauges.

METER PROVERS, PHOTOMETERS, STREET LANTERNS, ETC., ETC.

Patent Cluster Lanterns for Street Illumination.

SCIENTIFIC BOOKS.

We are prepared to furnish to Gas Managers, and others interested in the topics treated of, the following books, at prices named:

KING'S TREATISE ON THE MANUFACTURE OF COAL GAS. Three vols.; \$10 per vol.	GAS CONSUMER'S MANUAL, by E. S. CATHELS, C.E. 10 cts.	A PRACTICAL TREATISE ON GAS AND VENTILATION with Special Relation to Illuminating, Heating, and Cooking by Gas, by E. E. PERKINS. \$1.25.
GAS MANUFACTURE, by WILLIAM RICHARDS. 4to., with numerous Engravings and Plates, in Cloth binding. \$12.	PRACTICAL TREATISE ON HEAT, by THOMAS BOX. Second edition. \$5.	PURIFICATION OF COAL GAS, by R. P. SPICE. 8vo. \$3.
THE GAS ANALYST'S MANUAL, by F. W. HARTLEY. \$2.50.	GAS WORKS—THEIR ARRANGEMENT, CONSTRUCTION, PLANT, AND MACHINERY. \$8.	HOW TO MANAGE GAS, by F. WILKINS. Paper. 20 cents.
ANALYSIS, TECHNICAL VALUATION, PURIFICATION, and USE OF COAL GAS, by REV. W. R. BOWDITCH, M.A.; with Engravings; 8vo., Cloth. \$4.50.	COAL; ITS HISTORY AND USE, by PROF. THORPE. \$3.50.	THE GAS MANAGER IN THE LABORATORY, by a Practical Student. 8vo., Cloth. \$1.50.
GAS MEASUREMENT AND GAS METER TESTING by F. W. HARTLEY. \$1.60	THE GAS WORKS OF LONDON, by COLBURN. 60 cents.	THE DOMESTIC USES OF COAL GAS, AS APPLIED TO LIGHTING, by W. SUGG. \$1.40.
GAS CONSUMER'S HANDBOOK, by WILLIAM RICHARDS, C.E.; 18mo., Sewed. 20 cents.	THE GAS FITTER'S GUIDE, Showing the Principles and Practice of Lighting with Coal Gas, by JOHN ELDREDGE. 40 cents.	DISTILLATION OF COAL TAR AND AMMONIACAL LIQUOR, by GEO. LUNGE. \$8.50.
	GAS WORKS, AND MANUFACTURING COAL GAS, HUGHES. \$2.20.	A TREATISE ON THE COMPARATIVE COMMERCIAL VALUES OF GAS COALS AND CANNELS, by D. A. GRAHAM 8vo., Cloth. \$3.
	THE MANAGEMENT OF SMALL GAS WORKS, by C. J. R. HUMPHREYS. \$1.	

The above will be forwarded by express, upon receipt of price. We take especial pains in securing and forwarding any other Works that may be desired, upon receipt of order. All remittances should be made by check, draft, or post office money order.

A. M. CALLENDER & CO., No. 42 Pine Street, New York.

T. C. HOPPER, Pres. G. J. MCGOURKEY, Vice-Pres. (New York). WM. N. MILSTED, Gen. Supt. & Treas. (New York). WM. H. DOWN Sec.

AMERICAN METER COMPANY,

WET AND DRY GAS METERS.
STATION METERS.
EXHAUSTER GOVERNORS.
DRY CENTRE VALVES.
GOVERNORS FOR GAS WORKS.

PRESSURE REGISTERS.
PRESSURE & VACUUM REGISTERS.
PRESSURE & VACUUM GAUGES.
CRESSON GAS REGULATORS.
MARSLAND WATER METERS.

METER PROVERS.
PORTABLE TEST METERS.
EXPERIMENTAL METERS.
AMMONIA TEST METERS.
BAR AND JET PHOTOMETERS.

Manufactories:
512 W. 22d St., N. Y.
Arch & 22d Sts., Phila.

GAS STOVES,
SUGG'S "STANDARD" ARGAND BURNERS,
SUGG'S ILLUMINATING POWER METER,
Wet Meters, with Lizar's "Invariable Measuring" Drum.

Agencies:
177 Elm Street, Cincinnati.
214 & 216 N. Wells Street, Chicago.
810 North Second Street, St. Louis.
122 & 124 Sutter St., San Francisco.

HELME & McILHENNY,

(Successors to Harris & Brother. Established 1848.)

GAS METER MANUFACTURERS,

CONTINUE AS HERETOFORE AT THE OLD ESTABLISHMENT,

Nos. 1115 and 1117 Cherry Street, Philadelphia, Pa.,

To Manufacture Wet and Dry Gas Meters, Station Meters, Experimental Meters, Meter Provers, Center Seals, Pressure Registers,
GOVERNORS, INDICATORS, PHOTOMETERS, & ALL OTHER KINDS OF APPARATUS FOR USE IN GAS WORKS.

From our long practical experience of the business, and from our personal supervision of all work, we can guarantee all orders to be executed promptly, and in every respect satisfactorily.

WM. WALLACE GOODWIN, Prest. and Treas.

WM. H. MERRICK, V.-Prest.

S. L. JONES, Sec.

S. V. MERRICK, Supt.

THE GOODWIN GAS STOVE AND METER COMPANY,

Successors to W. W. GOODWIN & CO.

1012, 1014 and 1016 Filbert St., Phila., Pa. 142 Chambers St., New York.
76 Dearborn St., Chicago, Ill.

WALDO BROS., Agents, 88 Water St., Boston.

MANUFACTURERS OF THE "SUN DIAL" GAS STOVES, FOR COOKING AND HEATING PURPOSES.

Dry and Wet GAS METERS, Station Meters (Square, Cylindrical or in Staves) Glazed Meters, King's and Sugg's Experimental Meters, Lamp Post Meters, Etc., Etc., Meter Provers (sizes 2, 5 and 10 feet), Pressure Gauges of all kinds, Pressure Registers, Pressure and Vacuum Registers, Pressure Indicators (sizes 4 inch, 6 inch and 9 inch), King's Pressure and Vacuum Gauges, Dry and Wet Centre Seals, Dry and Wet Governors, Exhauster Governors, Photometers of all descriptions. Lethby's Sulphur and Ammonia Test Apparatus complete—also Testing and Chemical Apparatus of all kinds, and of the most perfect description, for all purposes relating to Gas.

GOODWIN'S IMPROVED LOWE'S JET PHOTOMETER.

Agents for Bray's Patent Gas Burners and Lanterns.

Special attention to repairs of Meters, and all apparatus connected with the business.
All work guaranteed first class in every particular, and orders filled promptly.

G. B. EDWARDS, Mang'r, New York.
E. H. B. TWINING, Mang'r, Chicago.
A. B. STANNARD, Agent.

D. McDONALD & CO.,

GAS METER MANUFACTURERS.

(Established 1854.)

51 Lancaster St., Albany, N. Y. 34 & 36 West Monroe St., Chicago, Ill.

STATION METERS, EXPERIMENTAL METERS, METER PROVERS, PRESSURE & VACUUM REGISTERS, PRESSURE GAUGES, ETC.

ALSO STAR GAS STOVES, RANGES, and HEATING STOVES.

We use only the very best materials, and employ the most skilled labor, and by our long experience (29 years) and personal supervision of every detail, we feel justified in assuring the public that our goods will give perfect satisfaction. Every Meter emanating from our establishment will bear the State Inspector's BADGE, and will be fully warranted by us. Our Annual and Calendar will be sent to Gas Companies upon application.

KING'S TREATISE ON COAL GAS.

The most complete work on Coal Gas ever published. Three vols., bound, \$30.

A. M. CALLENDER & CO., No. 42 Pine Street, New York.

THE GOODWIN GAS STOVE AND METER CO.,

1012-18 Filbert St., Phila., 142 Chambers St., N. Y., 76 Dearborn St., Chicago.

Agents, WALDO BROTHERS, 88 Water Street, Boston.

WM. W. GOODWIN, PRES. & TREAS.
W. H. MERRICK, VICE-PRES.
S. LEWIS JONES, SEC.
SAMUEL V. MERRICK, SUPT.

SOLE MANUFACTURERS OF THE

G. B. EDWARDS, Mang'r, N. Y.
E. H. B. TWINING, Mang'r, Chicago.
A. B. STANNARD, Agent.

"SUN DIAL" GAS STOVES

The Most Economical, Efficient, and Durable Gas Stove Made.

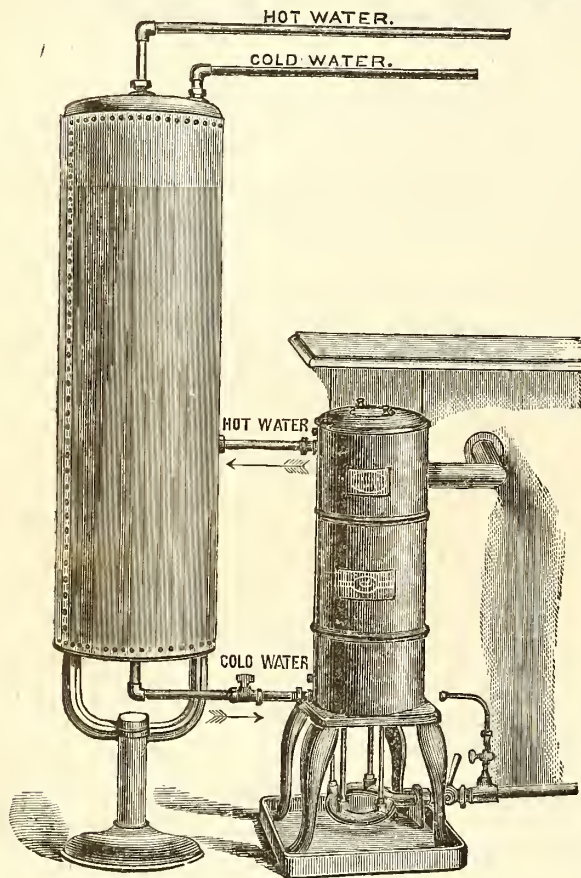

I.—Safety Hot Water Generator and Boiler.

Safety Hot Water Generator and Boiler.

Cut I. represents our Safety Gas Hot Water Generator and Boiler, arranged for home use. This most easy, quick, and economical way of preparing a warm bath, or for heating water for any domestic purpose, entirely supersedes any necessity for the use of ranges or stoves—a great comfort, particularly in hot weather. The boiler being self-filling, as the hot water is drawn off, can never become empty, thus preventing the possibility of any accident.

We beg to call attention to the cast iron pan which is now attached to the legs of the Generator (see illustration). This is to catch the drippings from the Coil, which many persons suppose come from a leak, when in fact they are produced by condensation. This condensation is caused by the hot flame coming in contact with the coil filled with cold water.

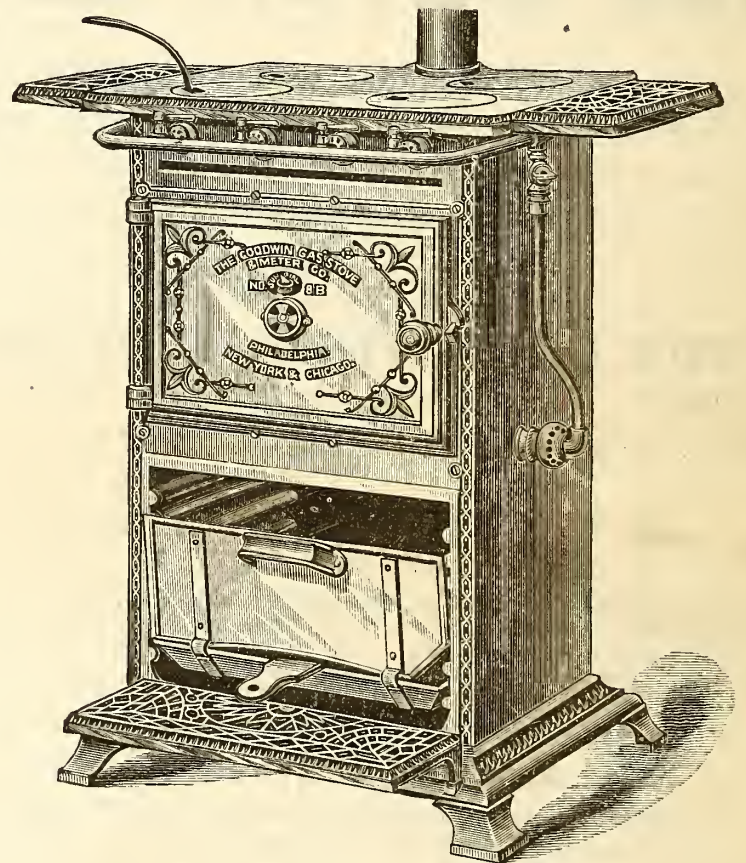

II.—Gas Cooking Stove No. 8 B.

New Style Gas Cooking Stove.

Cut II. represents our New Style Cooking Stove. As will be seen, it has an ornamented cast iron base and front, and extension shelves. The oven burner, which is atmospheric (unless otherwise ordered), is of an entirely new and improved pattern (patent applied for). The ovens are of greater capacity than those of the old style. The top, in conjunction with the outlet pipe, is designed to carry off all products of combustion; hence the outlet pipe must be connected with a flue, or the stove will not work properly.

This Stove has 4 boiling burners in top of hot plate. All fittings are nickel plated. We are making this style of Cooking Stove in the following sizes—viz., No. 7 B, No. 8 B, No. 9 B, and No. 10 B.

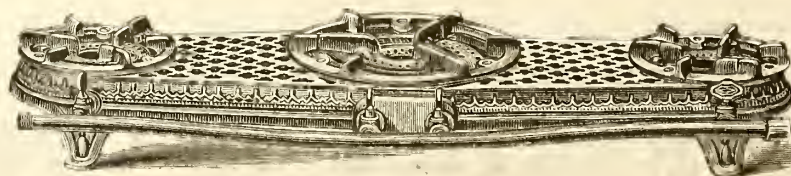

III.—Improved Hot Plate, No. 108.

New Style Hot Plates.

Cut III. represents our New Style of Hot Plates, of which we are making No. 106 (two small boiling burners), No. 107 (two medium sized boiling burners), and No. 109 (two medium and one large boiling burner). See new Catalogue and Price List for further particulars.

THE AMERICAN

GAS LIGHT JOURNAL

REDMAN, KENNY, N. Y.

PUBLISHING OFFICE No. 42 PINE STREET

DEVOTED TO THE INTERESTS OF ILLUMINATION, VENTILATION, WATER SUPPLY AND DISTRIBUTION, & GENERAL SCIENCE.

VOLUME XLIII.—No. 6.
Whole No. 630.

NEW YORK, WEDNESDAY, SEPTEMBER 16, 1885.

{ \$3 PER ANNUM
IN ADVANCE.

A. M. CALLENDER & CO., Proprietors. C. E. SANDERSON, Manager.
JOS. H. THOMAS, C.E., Editor.

ENTERED AT THE POST OFFICE AT NEW YORK, N. Y.,
AS SECOND CLASS MATTER.

Published on the 2d and 16th of each month, at No. 42 Pine Street, N. Y.

Terms of Subscription, including Postage.—For the United States and Canada, \$3 per annum. European countries, \$3.50 (15 shillings—18 francs). All payments to be made in advance. Single copies, 15 cents.

Remittances should be made either by post-office order, registered letter, or bank draft on New York, payable to the order of A. M. Callender & Co.

Advertisements are invariably made directly from this office, for subscriptions, advertisements, etc. We have agents to solicit the same, but they are not authorized to receipt for money.

Correspondence.—Wishing to make this JOURNAL a gazette of intelligent discussion to those of our readers who may wish to gain or give information on the subjects to which its columns are devoted, correspondence is solicited for publication from all who make the study of those subjects a pleasure or a profession.

The American News Company, Nos. 39 and 41 Chambers street, New York, are agents for this JOURNAL. Newsdealers will send orders to them.

Books.—We will forward by express, at publisher's lowest rates, any book—scientific or otherwise—to any address in the United States or Canada. No books will be sent C. O. D.

CONTENTS.

An Asterisk (*) denotes an illustrated article.

OFFICIAL CIRCULAR—	
American Gas Light Association.....	141
EDITORIALS—	
The Semi-Annual Meeting of the New England Association.....	142
They "Punched" Out the Regulators.....	142
Resigned His Position.....	142
Obituary Note—Hon. Francis Thompson.....	142
Annual Election Vincennes (Ind.) Gas Light Company.....	142
The Market for Gas Securities.....	142
* Gaseous Fuel.....	143
Examining the United States Patent Office Records, by Frederic Egner.....	147
A Review of the Report on the Efficiency and Duration of Incandescent Lamps, by H. C. Adams.....	148
On Heating Regenerative Gas Furnaces by Radiation from Flame....	148
Paper Made from Seaweed.....	150
Mr. A. F. Upton Discusses the Relation of Steam Power to Electric Lighting.....	150
Something about the Stevens Battery.....	151
ITEMS OF INTEREST FROM VARIOUS LOCALITIES.....	151
Annual Meeting of the Providence (R. I.) Gas Light Company—Reported Trouble between English Meter Makers and their Employes—One of the Reformers again "Bobs up Serenely"—Large Talk Concerning Electric Lighting in New England—Cheaper Gas for Tiffin, Ohio—No Water Gas in that Locality—A Great Natural Gas Territory—Looking for a Contract—Boston's Bad Drinking Water—Personal—Amusing Himself—A Practical Example as to Which Sort is the More Dangerous—Replacing or Displacing the Electric Lamps—Trying to Cheapen the Rates—The Plumbers May Strike—Natural Gas Explosion—Spontaneous Ignition.	
CORRESPONDENCE—	
Sidewalk Stopcocks.....	153
Recent Patents.....	153

[OFFICIAL CIRCULAR.]

American Gas Light Association.

AMERICAN GAS LIGHT ASSOCIATION, }
Sept. 10th, 1885. }

The Thirteenth Annual Meeting of the American Gas Light Association will be held at Cincinnati, Ohio, Wednesday, Thursday, and Friday, October 21st, 22d, and 23d. The headquarters of the Association will be at the Gibson House, and the meetings will be held at College Hall.

The members will find the hotel and hall arrangements very desirable; the hall is close by the hotel, and is a most excellent room for public meetings. The hotel has recently been remodeled, and will be found very convenient.

I am happy to be able to state that present indications would portend that our Thirteenth Annual Convention will be an enjoyable one. Certainly, those who attended our Fifth Annual Meeting, at Cincinnati in 1877, will be very ready to grant that the selection of that city for our coming convention was a happy augury of its success.

Though the literary portion of our programme is not yet completed, nevertheless the number of papers promised, and the partial pledges we have of others, afford good ground for hoping that the time which will be allotted to the consideration of matters of technical interest will be well utilized. We are promised papers on the following subjects:

"Improved Furnaces;" "The Result of a Month's Working with Limed Coal;" "Automatic Street Main Governors;" "Natural Gas;" "A New Photometer;" "The Present State of the Gas Business;" "Difficulties Encountered in the Construction of a Gasholder Tank."

In addition to the above we have four other papers partially promised, and I hope at an early day to add their titles to the above list.

If the members would keep these subjects before them, and collect from time to time such facts and figures in relation thereto as may be in their possession, and be prepared to lay them before the convention during the discussions of these themes, it would add greatly to the interest and value of our proceedings.

Besides the matters which will be brought before the Association by the gentlemen who will read the papers, there are many interesting subjects which could be discussed. At recent meetings of other Associations the question box has been rendered a very important feature of the convention. Yet it is doubtful if this branch of the meeting has been as edifying as it might have been; for many questions are asked which can only be properly answered by the production of some facts or figures, and as the party making the answer has no previous notice of the question it follows that the answer must be made from memory, instead of from the record; and, therefore, the conundrum is but partially answered. Now this could be rectified if we could know in advance the questions to be propounded. If, for instance, a member who wishes a subject discussed, or seeks light on some disputed point, would send in his question at once to the Secretary, he could incorporate it in his next circular, then as the members would have an opportunity to look up definite data on the subject the chances are the party putting the question, as well as the other listeners, would be edified. I would urge this matter on the earnest consideration of the members, and I sincerely hope there will be no hesitancy on the part of all in sending in their questions at as early a day as possible to the Secretary. There need be no holding back in this matter, as the names of the propounders of the queries will not appear

in any way. It will suffice if a member writes out his question and forwards it to me, I will then send to each member a list of the questions to be discussed.

It is hoped each member will make a decided effort to be present at the meeting, that we may have a large and pleasant gathering.

Parties wishing to join the Association can obtain blanks by applying to the Secretary,

C. J. R. HUMPHREYS,
Box 6, Lawrence, Mass.

THE SEMI-ANNUAL MEETING OF THE NEW ENGLAND ASSOCIATION.

The Semi-Annual Meeting of the New England Association of Gas Engineers was held at Point of Pines, near Boston, Mass., on August 25th and 26th, 1885, and an exceedingly pleasant time was had by all who were present. On the first day (Tuesday, the 25th) a formal business meeting was held in the morning, at which an interesting discussion was had upon various matters connected with the gas industry. During the afternoon the members, and their invited guests, devoted themselves to "having a good time;" and in this effort, in spite of the rainy, disagreeable weather, they succeeded admirably.

The next day, fortunately, came off bright and clear, and the members, accompanied by their guests, among whom were many ladies, took a steamer and sailed along the north shore of Massachusetts Bay, returning to the Point of Pines for a banquet at half past two o'clock. The party broke up at 5 P.M., and as the members and their friends took the trains which carried them to their respective homes, all agreed that the "Semi-Annual" of 1885 had been a most enjoyable gathering.

THEY "PUNCHED" OUT THE REGULATORS.

As an average "specimen card" of how fairly the ruling authorities of our cities and towns are disposed toward the managers of local gas undertakings, in the "treatment and adjustment" of certain matters that necessitate mutual relations between both sets of parties, we are enabled to present the following particulars of a transaction that recently happened in the thriving, bustling place known to history, and designated on the maps, as Morristown, N. J.

Of course Morristown's streets must be illuminated at night; and in order that such desirable end be attained a mixed system is resorted to—that is, a certain number of gas lamps are maintained, and the balance of the lighting is eked out by the employment of another certain number of oil lamps, which, noting the latter part of the arrangement, is not always as satisfactory to the residents of the town as it might be. But since it is our intention here to deal exclusively with the doings of the local Solons in regard to the gaseous mode of illumination, we will take leave of the "oily" part of the subject with the parting remark that, all things considered, it might be well for the Morristown dwellers did they give such encouragement to the proprietors of the gas company that the latter would be enabled to extend its mains to such lengths as would ensure the entire lighting of the city's streets by gas.

When the last annual contract was entered into between the Town Council and the gas company it was stipulated therein that the latter would be required to furnish nothing else but gas to the lamp burners, the city agreeing to light, extinguish, clean, and maintain. The rate of consumption was fixed at four feet per hour, and the Gleason "Young America" pattern of burner, regulated to emit the stipulated flow, was installed in the lanterns. The authorities awarded the contract for lighting, etc., to a local firm of gasfitters, and these astute gentlemen employed the necessary help to carry on the work with the following results. The Morristown "helper" must be rather averse to unnecessary work, since shortly after the new burners had been placed in action the Morristown gas folks found that their send-out was increasing in rather too rapid a manner when comparison with their monthly accounts and cash receipts was resorted to for the purpose of seeking a reasonable solution of their seemingly great advance in prosperity. Superintendent Hunt was appealed to, and he informed the management that, for a night or two previous, he had been rather suspicious as to the street lighting consumption; and that he proposed "instituting an investigation." The investigation shortly developed a surprising state of affairs. The helpers, in order to save themselves a little extra trouble in cleaning, etc., had removed the "Young Americas" and "punched" out their (not the helpers' but the burners') regulators. The Councilmen were informed of what had been done by their contractors' employees; but instead of punishing the delinquents some of them were actually inclined to restrain the gas company from replacing the "punched" burners with sound ones, on the score that "the lamps gave a much better light than was the case before the 'punching' occurred." They did not, however, propose to give the gas company any larger sum of money for the increased illumination, and insisted

that under the terms of the contract they (the Council) had "full charge of everything except the gas." This seems rather incredible, but the facts are as stated; and it actually took several interviews between representatives of the company and Council before the matter was straightened out. Indeed, it would have absorbed a greater length of time had not the Mayor condescended to acknowledge that "the gas folks were in the right of it." The Morristown lanterns are now equipped with "empire bulbs," and the gas company has been assigned "exclusive control" of the jets—the city still continuing to "light, extinguish, clean, and maintain." Take it all in all, we think the Morristown gas company had better keep an eye on them yet.

RESIGNED HIS POSITION.

We have received notification that Mr. Wm. W. Silkworth, for many years Secretary of the Long Branch (N. J.) Gas Light Company, handed in his resignation to the management of that corporation some short while since, and that his official connection with the company ceased on date of Tuesday, September 8th. His successor in office is Mr. John Torry, who is also connected with the Long Branch water supply company.

While not at present conversant with the circumstances that led to this action on the part of Mr. Silkworth, we are thoroughly convinced that the Long Branch Gas Light Company has lost, by his action in resigning, the services of a capable, efficient, trustworthy and energetic business man. This is said without any inclination to put forward the least slight upon the capacity of his successor; but rather to show an appreciation of the merits of a man whom we have known intimately, both in business and friendly relations, during the past eighteen years. When Mr. Silkworth was named as Secretary to replace Mr. W. E. Fort, some seven or eight years ago, the affairs of the Long Branch company were in a somewhat mixed condition; but the new appointee's tact and zeal speedily convinced the directors that they had found the right man and put him in the right place. Mr. Silkworth's action will undoubtedly be regretted, if not by the management of the company, at least by the residents of New Jersey's famous and beautiful watering place.

OBITUARY NOTE—HON. FRANCIS THOMPSON.

We regret to announce the sudden death of the Hon. Francis Thompson, a resident of Charlestown, Mass., whose demise occurred on the evening of Sunday, Aug. 30th. Mr. Thompson was always a prominent figure in the business and social circles of Charlestown—deceased was born in that city about sixty years ago—and was held in high esteem by the citizens of his birthplace. He was chosen a director in the Charlestown Gas Company, on January 16th, 1871, and on Sept. 12th, 1883, was made President of that corporation. He served his city faithfully and well in various positions of public trust; and, in 1870, was honored by an election to the State Senate, when the city of Charlestown was constituted a separate senatorial district. He was a man of probity and honor. The funeral ceremonies took place on afternoon of September 2d.

Annual Election Vincennes (Ind.) Gas Light Company.

The Citizens Gas Light Company's stockholders held their annual meeting on Tuesday, Sept. 8th. The election resulted in the choice of the same gentlemen who controlled the company's affairs during the past twelve-month. Annexed is the list: President, Mr. John H. Rabb; Secy., Treas., and Supt., Mr. Geo. G. Ramsdell; Directors, Messrs. Jno. H. Rabb, Geo. G. Reily, W. H. DeWolf, J. L. Bayard, Edward Watson, S. N. Chambers, and Geo. G. Ramsdell.

Friend Ramsdell cannot have much leisure time upon his hands, even despite the fact, as chronicled in our last issue, that he has become quite an adept in the arts and practices of the "esthetic decorator."

The Market for Gas Securities.

The city gas share market has been taken out of the realms of summer dullness; but it must be noted the "quiet" period that prevailed in '85 was remarkable for its lasting power. Consolidated gas, during the last fortnight, sold down as low as 91½, but the reaction from bottom figures was speedy. At time of writing (3 P.M., Sept. 14) 93½ was bid, and offerings were made at 93½. On same date one or two transactions were recorded at 94. We continue the advice to investors that Consolidated is a purchase. There is every indication that there will be a brisk and fluctuating market in the near future, and those not seeking to make a speculative turn need not spend their time in "watching the tape," for the shares are worth par and over. Equitable stock options or "rights" are selling at 20 per cent. Mutual is slightly weaker. Brooklyn shares are strong. We note that the Peoples Company, of that city, pay a quarterly dividend of 1½ per cent. on Sept. 15th. Baltimore Consolidated is lower. Nothing else of note.

Gaseous Fuel.

By H. TOWNSEND, Assoc. M. Inst. C.E., of Dewsbury.

[A paper read at the Twenty-second Annual General meeting of the Gas Institute, with discussion on same, and reprinted from *Journal of Gas Lighting*.]

When I was asked a few weeks ago, by our esteemed President, to contribute a paper to this meeting on the subject of "Gaseous Fuel," the time was so short that my first impulse was to courteously decline the request. But when I came to remember that I had also received an indirect invitation of a similar nature from the *Journal of Gas Lighting*, in the first number for the current year, I thought it would be exceedingly ungracious on my part not to respond to this double invitation; and so decided that it was my duty to endeavor, however imperfectly, to meet the wishes of our President, and to prepare a paper, relying upon the generosity and forbearance which I felt sure would be extended to its manifest imperfections by the members of the Institute.

It will doubtless be still fresh in your recollection that, in a series of letters, dated from the town of Bradford (with which I was then connected), which appeared in the *Journal of Gas Lighting* about this time last year, I suggested, as a means of affording the public a supply of cheap gaseous fuel, the conversion into water gas, at the works of our large manufacturing towns, of the coke made in the production at those works of ordinary coal gas. This coke is in some instances very difficult to dispose of, and has consequently to be sent into competition with, and depreciates the value of, the coke produced at the local gas works. This gas, I endeavored to prove, could be supplied to the consumer through a separate system of mains, if an adequate market were created for it, at 6d. per 1,000 cubic feet, and would at this price be about equal in calorific value to coal gas at 1s. per 1,000 cubic feet. I also entered pretty fully into the financial aspect of the question, and tried to show that if a market could be found for all the gas which could be so produced, its manufacture would be a very profitable investment for the gas undertakings themselves; and in a letter published in the *Journal*, on May 13, 1884, I stated that I had seen in successful practical operation, on a large scale, the manufacture of water gas from coke, and that I was perfectly satisfied that there was no difficulty either in its manufacture or distribution. I should have been very pleased to have given the meeting a description of the apparatus here referred to, but am not at liberty to do so, as some of the patents are still incomplete; but I may say that the plant which I had the privilege of seeing in action was at a large iron works in Germany. It consisted of the generating apparatus, and a small rectangular box, something like a purifier, to arrest the ash (this being the only impurity there was to remove), and a small telescopic gasholder, capable of containing about 10,000 cubic feet of gas; together with the necessary connections, etc. There was no condenser, the gases getting sufficiently cooled by passing through the pipes to the gasholder. The gasholder was carefully graduated from top to bottom, to enable the production and consumption of gas to be easily ascertained. A "Standard" washer had also been put up to extract the ammonia; but experience proved that no ammonia was formed which paid the cost of extraction, and therefore when I saw the washer it was out of action. In an extremely valuable paper read before the "Institution of Civil Engineers," last year, Dr. Foster showed that it was possible to produce a very considerable amount of ammonia from the nitrogen contained in ordinary coke. Whether it will be commercially possible to recover this ammonia as a bye-product in the manufacture of water gas is a problem which I must leave in the hands of Dr. Foster and other gentlemen who are working in this direction.

The material used consisted of the cinders which had dropped from puddling furnaces on the works. These were washed and screened, and as many of the clinkers as possible picked out. I was told that this fuel generally contained about 20 per cent. of water; and I should say, from my own observation, at least 5 per cent. of clinker. So that it is evident that if good gas could be made from such fuel as this, our own coke would be an admirable material for the purpose. An ordinary laboring man, clad in that esthetic Continental garb, the time-honored blue blouse, was the only attendant; and he seemed to have no difficulty in working the apparatus. It was plain, therefore, that the manufacture of water gas from coke does not require very much skill. From observations which I took on the spot I found that the plant was making gas at the rate of 227 cubic meters, or 8,017 cubic feet per hour; while it was being used in the works at the rate of 3½ cubic meters, or 123 feet per minute. Consequently the production and consumption were pretty evenly balanced. As affording an indication of the scientific manner in which work is carried on in Germany, I may state that at this iron works two chemists were regularly employed; and one of them tested, in my presence, in a laboratory adjoining the gas-making plant, the gas which was being made, and informed me it contained 3 per cent. of carbonic acid.

With the very inferior material in use, I was informed that the average production was 35,000 cubic feet of gas per ton; but with ordinary gas works coke, no doubt was entertained that 50,000 feet per ton (which is the recognized production) would be obtained. Plant to make 20,000 cubic feet of gas per hour, constructed as I saw it, could be erected for about £2,000, exclusive of the holder, and it would occupy a space about 40 feet long by 20 feet wide. In reply to an inquiry I was told that this particular apparatus had been in daily operation for 18 months, and had not so far cost anything for repairs; but that it was intended to renew some of the firebrick lining in a short time. The item of wear and tear was, therefore, not a very large one. This water gas plant could very well have been placed in the vault of a stage retort-house, if it were built a little larger than at present; so perhaps the gas works of the future—if water gas finds favor for industrial purposes—may contain retort houses capable of making simultaneously coal gas for lighting and water gas for heating purposes. I will not here go into the financial aspect of the question further than to state that the result of my observation was to confirm the figures as to the probable cost of water gas made from coke, if supplied by existing gas undertakings, which I placed before the readers of the *Journal of Gas Lighting* last year.

As an illustration of the advantages of gas for industrial purposes, I was informed that, in the special application for which this gas was being used, six times more work was being done in a day by a certain number of men as could possibly be performed by the same number of men using raw coal on the old system; and, in addition to this enormous saving, the work was much better done. Altogether, this firm was so well satisfied with water gas that additional plant, to make double the quantity, was in course of construction when I was there. They also told me that, as the result of experiments, they found that they could obtain much higher and sharper heats with water gas than they could with ordinary coal gas, as the latter required more oxygen for its complete combustion, and a greater proportion of air had, therefore, to be used, and a larger amount of the inert nitrogen to be heated up. Being rather sceptical on this point (as it seemed at variance with orthodox opinions), I have calculated the theoretical initial temperatures produced by the combustion of water gas and coal gas respectively, with the following result: Taking water gas first, and supposing the composition to be 50 per cent. of hydrogen, and 50 per cent. of carbonic oxide, we have in 100 cubic feet 0.2789 lb. of hydrogen, and 3.9048 lbs. of carbonic oxide, which on combustion would yield 34,900 units of heat; and, supposing no excess of air was admitted, would require 4.4624 lbs. of oxygen. The products would be 6.136 lbs. of carbonic acid, 14.949 lbs. of nitrogen, and 2.57 lbs. of steam; and therefore the initial temperature would be—

$$34,900 - (2.57 \times 966.6) \\ (6.136 \times 0.2164) + (2.57 \times 0.475) + (14.949 \times 0.244)$$

or, approximately, 5400° Fahr. Whilst for coal gas, with a composition of (say) 50 per cent. of hydrogen, 40 per cent. of marsh gas, 5 per cent. of ethylene, and 5 per cent. of carbonic oxide, we should have 0.2835 lb. of hydrogen, 1.6872 lbs. of marsh gas, and 0.36,915 lb. each of ethylene and carbonic oxide, which on combustion would yield 69,490 units of heat; and, supposing no excess of air admitted, would require 10.9331 lbs. of oxygen. The products would be 7.086 lbs. of steam, 6.747 lbs. of carbonic acid, and 36.626 lbs. of nitrogen from the 100 cubic feet, and a resultant temperature of—

$$69,490 - (7.086 \times 966.6) \\ (7.086 \times 0.475) + (6.747 \times 0.2164) + (36.626 \times 0.244)$$

or nearly 4600° Fahr.

Thus, although we have just twice the amount of heat from the 100 cubic feet of coal gas that we get from the same amount of water gas, yet it is spread over a much larger quantity of waste gases; and hence the lower initial temperature. Or, to put it in other words, we should get *twice the volume of heat* with 100 cubic feet of coal gas that could be obtained with 100 cubic feet of water gas; but, owing to the greater proportion of air needed for the complete combustion of coal gas as compared with water gas, the latter would give the higher initial temperature.

As many of us are rather frightened at water gas, owing to the reputed poisonous properties of one of its chief constituents—carbonic oxide—I made very careful inquiries on this point, and was informed that, although such large quantities of it were used at these works, no trouble had ever been experienced with it on this score. I was told that the men had often inhaled considerable quantities of it, and it generally made their heads ache when they did so; but when they got into the open air they were soon all right again.

Since writing the foregoing I have had my attention drawn to an article in the *Journal of Gas Lighting*, for the 5th of May, entitled, "The Poisonous Qualities of Water Gas," founded on an investigation into the subject by two American chemists, who have been conducting a series of experiments with water gas. They succeeded in proving that an atmosphere containing certain proportions of carbonic oxide is not conducive to longevity, in the case of certain inoffensive cats, dogs and rabbits which had the honor of

being selected to contribute this information to the world. On turning, however, to the *Journal*, for May 13th, 1884 (p. 819), I find another article, on another report by other American chemists, who summed up their opinion in these words: "Water gas is not more detrimental to health than other illuminating gases." So much for the experiments of American chemists. Experts have the unfortunate tendency of proving just what they are called in to prove; and, as a rule, any desired opinion upon any desired subject may be obtained by those interested.

The simple fact that water gas, carburetted with petroleum, has been in use in the United States for years for lighting purposes, and that it is now the chief lighting agent in no less than 50 towns in that country, proves that it is "not so black as it is painted." The only fatal accidents which have occurred with water gas in the United States have happened in sleeping apartments. I myself should certainly be strongly opposed to the adoption of water gas in this country for illuminating purposes, as people will insist on leaving gas escaping in their bedrooms all night; and then, again, the majority of the gas fittings in private houses are in a very bad state of repair. But for industrial purposes I certainly fail to see any danger in it; as when people are at work they are generally pretty wide-awake to every contingency. Besides, as the fittings would be new and substantial, escapes of gas would be very exceptional. The inhalation of water gas causes a severe headache; and no one, I think, would be likely to inhale sufficient to do him any real harm, especially as the effect passes off as soon as the pure air is breathed again. Such is the conclusion come to by the State of Massachusetts, which employed the chemists whose report, alluded to above, has created such a flutter in the pages of the *Journal*, the decision being that coal gas only shall be used for lighting, but that water gas may be supplied for fuel purposes.

Shortly after my return from Germany, pressure was brought to bear on the Gas Committee of the Bradford Corporation by outsiders interested in the maintenance of steam as a source of motive power, and a certain sum was offered for carrying on experiments to demonstrate the feasibility of making and distributing cheap fuel gas, at existing gas works, for the purpose of firing boilers. This Utopian idea, as I stated in a letter which appeared in the *Journal* for Jan. 29th, 1884, was commercially an absolute impossibility. However, as it was thought that useful data might perhaps be obtained, although not precisely those desired by the promoters, the Gas Committee resolved to carry out an experiment in this direction; and a plant to make water gas would have been too expensive for experimental purposes, it was decided to try ordinary coal gas deprived of its benzol. Temporary plant was accordingly erected, consisting of an old exhauster, a Livesey washer, and three or four tanks. The material used for extracting the benzol was heavy oil obtained from the tar distiller; and the *modus operandi* was as follows: The gas was pumped out of one of the gasholders on the works, and forced through the oil in the washer, by means of the exhauster, and then passed into a small gasholder where it was stored. To make the washer more effective it was placed inside one of the tanks, and surrounded with a freezing mixture of ice and salt; and the oil was allowed to run constantly through the washer. In this way about 70,000 cubic feet of gas were treated, when, by an arrangement of the connections, it was pumped through the washer again; the partially benzolized oil being this time used in the washer. This was continued until the illuminating power of the gas had been reduced to 11.5 candles, and the composition had been altered to—

	Per cent.
Hydrogen.....	51.0
Marsh gas.....	38.0
Ethylene, etc.....	3.0
Carbonic oxide.....	5.0
Nitrogen.....	2.0
Carbonic acid.....	0.5
Oxygen.....	0.5

The gas then possessed a calorific value of 22,000 units per pound, or 637 units per cubic foot. The quantity of benzol extracted was equal to 2.8 gallons per 10,000 cubic feet of gas treated; and this was quite as much as could be expected with such crude apparatus.

After getting the debenzolized gas into the holder, I left Bradford for Dewsbury, and am indebted to my successor (Mr. C. Wood, the present Manager of the Thornton Road Gas Works) for the following additional information: On Aug. 7th, 1884, the experiment for which this preparation had been made was carried out. The gas was conducted by means of a six-inch pipe to the premises (which were closely adjoining) of the firm desiring the information; passing, on its way, through a 600-light meter. It was applied to a new Galloway boiler, 30 feet long by 8 feet in diameter, furnished with an economizer, and supplying steam to one horizontal 25-horse power engine, and one beam 18-horse power engine. The boiler was a first-class one; but the engines were, in efficiency, very much behind those now constructed. The two together—boiler and engines—may, however, be con-

sidered as a fair average of the standard obtaining in practical working. Both coke and gas were used together during the experiment, the coke being fed in the usual manner, and the gas passing into two iron boxes cast to fit in between the furnace doors and the tops of the tubes, and then escaping into the furnace just above the coke, through a series of $\frac{3}{4}$ -inch pipes screwed into the iron boxes. This was certainly not the best way in which the gas could have been applied; but it was an arrangement designed by the promoters, and would doubtless have been considerably improved upon had the first experiment held out any hopes of ultimate success. The experiment lasted $5\frac{1}{2}$ hours; the mean indicated horse power of the engines being 136.2. The gas consumed amounted to 67,711 cubic feet, and the coke to 1,008 lbs.; being 11,776 cubic feet of gas and 175.3 lbs. of coke per hour, or—

$$\left. \begin{array}{l} \text{Gas } \frac{67711}{5.75} \times \frac{1}{136.2} = 86.4 \text{ feet} \\ \text{Coke } \frac{1008}{5.75} \times \frac{1}{136.2} = 1.2 \text{ lbs.} \end{array} \right\} \text{ per indicated horse power per hour.}$$

The expenditure of fuel was—

$$\text{Gas} = 86.4 \times 637 = 55,037 \text{ calorific units.}$$

$$\text{Coke} = 1.26 \times 12000 = 15,120 \text{ " "}$$

$$\text{Total} \dots \dots \dots 70,157 \text{ calorific units.}$$

The energy of fuel realized in the engine was—

$$\frac{33000 \times 60 \times 100}{70157 \times 772} = 3.6 \text{ per cent.}$$

On the previous day (Aug. 6), under exactly similar conditions, the boiler being then fired with coal, 6,402 lbs. were used in 7.5 hours; the indicated horse power being 142.8, or 5.98 lbs. per indicated horse power per hour, and the energy utilized 3.3 per cent. The relative values of coal and gas for firing boilers, according to this experiment, were therefore as follows:

Coal, 5.98 lbs., at 7s. per ton.....	= 0.2242d.
Gas, 86.40 cubic feet, at 2.2d. per 1,000 cu. feet =	0.1905
Coke, 1.26 lbs., at 5s. per ton.....	= 0.0337
	————— 0.2242d.

Or coal gas would have to be sold at about $2\frac{1}{4}$ d. per 1,000 cubic feet to be able to compare, in point of economy, with coal for the purpose of firing boilers. This was, of course, an absolute impossibility with either coal gas or gas of any other description whatever; and this one demonstration, therefore, proved sufficient to satisfy, if not to gratify, the promoters.

Although it is evident that it is utterly impossible to abolish the smoke caused by boiler firing by any scheme for distributing gas from central stations, yet it is possible to fire boilers in such a way as not to cause a particle of smoke, and at the same time obtain considerable economy over the ordinary method of firing with coal. This can be accomplished by using coke instead of coal as fuel. Coke is now used to a small extent for boilers; but as, when used in an ordinary furnace, the evaporative duty is too small (owing to its slow combustion), its use is very restricted. Ordinary mill boilers require the consumption of from 4 to 5 cwt. of coke per hour to generate sufficient steam for the work that is generally required of them. This is not possible with the ordinary furnace, but it is very easy of accomplishment if gas-producers are used for the purpose. In a letter published in the *Journal of Gas Lighting* for Jan. 29, 1884, I gave an account of some experiments which a friend of mine had made with a producer of his invention, with the object of showing its advantages for firing boilers. The experiments were tried at a large mill in Bradford, the producer firing one set of seven boilers, each 28 feet long by 7 feet diameter. Tried first with coal, my friend was able to keep up an ample supply of steam, and to show a saving of about 15 per cent. This was very favorable, as these boilers were fitted up with all the modern improvements of economizers, mechanical feeders, etc. Without economizers, and fired in the ordinary way, he has been able to record as high a saving as 33 per cent. Using coal, however, had one drawback. There was still a certain amount of smoke produced. I accordingly suggested using coke. This completely cured the smoke; and, to our surprise, we were able to evaporate more water and generate more steam than with coal. This was very encouraging; and we thought we had succeeded in overcoming all difficulties. We were able to gasify as much as 7 to 8 cwt. of coke per hour, and had no trouble in evaporating 400 gallons of water per hour (as tested by one of Kennedy's meters) into steam at 65 lbs. pressure; this being the duty required of the boiler. Our jubilation was, however, of short duration. The molten clinker from the coke had a terrible effect on the lining of the producer—9 inches of solid fire-brick being burnt through in a week. This quickly brought our experiment to a close; but it did not discourage my friend. With the patience and perseverance worthy of a true inventor, he set to work again; and, in the producer shown in the drawing, has succeeded in producing a machine which will, without detriment, gasify 10 cwt. of coke per hour, and enable anyone who chooses to do so, no matter how large his boiler may be, or how great the work required of it, to carry on his operations without being a

nuisance to his neighbors, and to fire his boiler without creating a particle of smoke.

The form of producer here referred to is that patented by Mr. E. Brooke, of Haigh Foundry, near Wigan, and late of Bradford; and it embodies his experience of the subject since the introduction of the Brooke and Wilson gas producer in 1876. In the producer with which the experiments were made in Bradford, the dross not only destroyed the fire-brick lining, but its

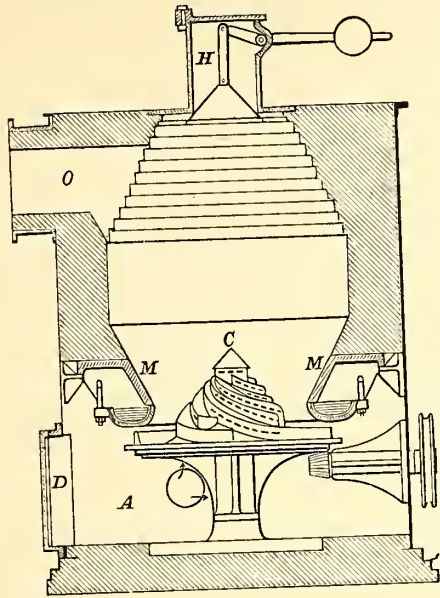

removal was a terribly distressing operation. This producer removes its own clinker; and when it is remembered that, in the gasification of 5 cwt. of coke per hour for 12 hours about $7\frac{1}{2}$ cwt. of clinker would be formed, the importance of this point will be readily understood. A reference to the diagram will readily explain the manner in which this self-cleansing operation is performed. At the bottom of the fuel chamber there is a circular table, the central part of which consists of a conical grate C, having spiral steps which end in four curved arms or vanes, reaching to the outer edge of the table. This conical grate (which is perforated for the admission of air) and table revolve three or four times a day; and by this movement the dross and ashes are steadily pushed outward until they drop over the edge and fall into the ashpit below. The revolving grate is driven from some convenient source of power, for regularity and to avoid neglect (although easily turned by hand); and the effect of this is always to keep the fire in good condition, and to completely overcome what has hitherto been the condemning feature in large gas-producers. The lower portion M of the side walls, just above the grate, is formed of iron cooled by water. This serves two useful purposes—it prevents any dross adhering at this point, and ensures greater durability to this part of the structure. The revolving grate is supported on rollers carried on pillars, and is driven from the outside by a worm and wheel, the whole structure being cascd with wrought iron. The ashes are raked out of the ashpit A once a day, through a doorway D provided for the purpose in the wrought iron casing, but which is kept closed when the producer is at work. The air is blown into the ashpit by a steam-jet, and finds its way up into the fire partly through the perforations in the conical grate and partly around the edge of the table. It will be seen from this that the ashes and clinker, before dropping into the ashpit, are cooled by the entering air and steam, and the heat carried back into the fire. The coke is fed in at the top by the bell and hopper arrangement H, and the whole chamber kept well filled; the gas being led off at the upper part by the branch O at the side, and carried forward to the boiler by underground or overhead flues, and ignited and consumed in the boiler furnaces. The ordinary firing arrangement is retained undisturbed, for provision in case of any derangement of the gas supply. This producer is constructed to convert about 10 cwt. of coke per hour, or equal to the supply of two ordinary mill boilers; and, with the exception of tumbling the coke in at the top, no labor is required in its attendance, as in all other respects it is self-acting.

If the public would only adopt some such apparatus as this for firing boilers, they would soon improve the sanitary condition of the large manufacturing towns, and would also relieve us of some of our surplus coke.

Most of our great thinkers, however, seem to be of opinion—and I cordially agree with them—that gas engines will replace steam largely as the source of motive power in our manufacturing towns. There seems, indeed, to be no reason why gas engines should not be able to perform any work which can be done by stationary steam engines. The only drawback to their more general adoption at present is the vital one of expense. Beyond a certain power, with ordinary coal gas, it cannot be claimed that they are economical. With water gas, however, at 6d. per 1,000 cubic feet, they compare

favorably, in point of economy, with the largest and best constructed steam engines. In a letter which was published in the *Journal of Gas Lighting* for May 18, 1884, I endeavored to show how the wealthy gas corporations might assist in the development of the gas engine; and perhaps the growing depreciation in the values of our residuals may in time convince us that a "pushing" policy is as necessary for gas supply as for any other industry.

I daresay that the most general objection to any scheme for supplying gas specially for fuel purposes is the necessity which it would involve for duplicate mains. But when it is considered that in a manufacturing town, consuming (we will say) 1,000 million cubic feet of gas for lighting purposes, the engine power employed would amount to about 50,000 horse power, and that if gas engines were to supplant steam engines about one million cubic feet of gas per hour would be required, it is very evident that the existing mains would be totally inadequate; and we might just as well lay separate mains as take up and replace the old ones. Then, again, this question of mains is not so formidable as it appears at first sight. The mills in a manufacturing town are grouped together in special districts, and are generally pretty close to the gas works, as the same reasons that fix a site for gas works—proximity to railways, canals, and other modes of transit—generally fix the site for a mill; so that there would be no necessity to lay duplicate mains except in a very small proportion of the streets. The enormous quantities of gas which would be required also opens up another question—viz., whether it would not be wiser, in view of the probabilities of the future, to have several medium sized gas works within moderate distances of each other, so that they could be easily connected together by means of trunk mains of reasonable dimensions, than to have one or two immense stations at considerable distances perhaps from the area of consumption. These remarks apply simply to large manufacturing towns. In my opinion the requirements of these towns will become increasingly divergent from those of residential and commercial towns, and will require different policies on the part of those directing the undertakings.

I know that it will be urged by some amongst us that, if the public require gaseous fuel, they had better make it themselves. No doubt this will be increasingly done in large works where gas is required in sufficient quantities; but there are numbers of persons engaged in various trades who would be glad of a supply of cheap fuel gas, whose requirements are not large enough to make it pay to supply themselves. These, and the users of power, are our prospective customers. It must not, however, be supposed that I would advise any gas undertaking to rashly enter upon this new line of business. As I stated in the first letter which I wrote on this subject, what I would advise gas companies and corporations to do would be to increase, in the first place, by every means in their power, the consumption of coal gas for purposes other than lighting. Then, when an adequate market has been created, it will be for us to decide how best to supply it; and if the discussion of the problem at this stage should assist us in arriving at a sound decision in the matter, sufficient justification will have been found for the production of this paper. Some towns, I am aware, are already doing their best to thus widen the basis of their business; and all honor to them. Some are letting out gas stoves on hire; some have, I believe, even gone so far as to let out gas engines on the three years' hire system; while others are selling coal gas for fuel purposes at a cheaper rate than usual. One of our greatest authorities, Mr. George Livesey, has, I know, declared against the policy of differential rates. I do not wish for one moment to dispute the soundness of Mr. Livesey's views on the question, for no one has a greater respect than I have for this gentleman's judgment; but London is essentially a commercial and residential city, and it does not follow that what is "saucy" for the London "goose" is also "saucy" for the provincial "gander."

I am glad to acknowledge the abnormal amount of enterprise which has been exhibited by the owners of gas undertakings during the past twelve months. Gas exhibitions have been held all over the country; and the knowledge thus disseminated of the advantages of gaseous fuel as applied to domestic purposes must have had an extremely beneficial influence on the development of this important question. As one of these exhibitions was held last year at Dewsbury, it may not be uninteresting to describe the result. The exhibition was opened on July 29, and lasted a week. During the previous twelve months the consumption of gas had shown a uniform decrease, amounting on the year to about $1\frac{1}{2}$ per cent. This decrease was maintained right up to the week in which the exhibition was held. We then gradually began to "turn the corner," and soon experienced the gratifying symptom of a rapid increase in consumption; this, too, being at a time when the weather was exceptionally hot and clear, and when the influence of trade, whether good or bad, was absolutely *nil*. This increase continued, and I am thankful to say still continues; having so far averaged just 10 per cent. Now, we are only able to account for 1 per cent. of this increase as being due, directly or indirectly, to the exhibition; so that we have an increase of nearly 9 per cent. for which it is not easy to find a reason. Trade is certainly not better than it was a year ago; and other things, such as pressure, are the same now as they were then. I am therefore led

to infer that the great bulk of the consumers are induced to increase their consumption (perhaps without knowing it themselves) simply through having their attention forcibly drawn to the subject. If this be so, it is another tribute to the value of advertising.

I have no doubt I shall be met by the argument that many undertakings have had just as large, and some it may be a larger increase, and yet have not held any exhibition. Perhaps so. But still the coincidence remains in our case; and if others try the effect of an exhibition, who have not already done so, there may be a similar gratifying coincidence in theirs. The present unprecedented depression in the value of residuals intensifies the importance of increasing the consumption of gas by every means which presents itself. This is the only way in which we can be compensated for the loss on what has hitherto been one of our most remunerative branches. Such, I am happy to say, has been the case at Dewsbury—the increase of consumption has more than covered the loss on residuals; and we accordingly have the gratifying result of an increase of profit, in spite of this serious derangement in one of our chief sources of revenue.

It therefore seems to me that the policy of the directors of gas undertakings is perfectly clear—it may be summed up in the one word “enterprise.” Let us push every appliance by which the sale of gas can be increased, and work up by every means in our power fresh markets for the use of gas. Thus stimulating and encouraging the efforts of inventors, we shall show to the world that our minds are not altogether devoted to paying big dividends, but that we are alive to the necessities of the day, and—being quite prepared to meet the requirements of the public, whatever they may be—are worthy stewards of the noble industry which is confided to our charge.

Discussion.

The President said there were present two very distinguished American members of the Gas Institute—Mr. M. S. Greenough and Mr. Fette, both of Boston. These gentlemen had a practical knowledge of the manufacture of fuel and water gas; and he was sure the members would be delighted, not only to welcome them amongst them, but to hear any remarks they might desire to make.

Mr. Greenough (Boston), after thanking the President for the courtesy of his invitation, said he should not have been satisfied to leave the hall without protesting most politely, but distinctly, against the suggestion that the American chemists who had made the recent report on the subject of water gas had been actuated by any motives other than those worthy of men of science. He would briefly recall the circumstances under which the report was made. Competing gas companies in America chiefly sought to compete with existing companies by the introduction of water gas—fuel gas (to which Mr. Townsend alluded), mixed afterward with the vapor of petroleum or naphtha. Massachusetts was hitherto the only State which set its face against the introduction of this gas, in spite of the affirmation of chemists and gentlemen interested in its introduction that water gas was no more dangerous than coal gas, and no more detrimental to the public health. The people of Massachusetts who had examined the matter had presented various statistics of deaths arising—of course from carelessness, but at the same time deaths occurring in considerable numbers in cities where the gas was used; and these facts could not be disproved. However, as the paper just read was not on the subject of illuminating water gas, he would not pursue this matter further. Last year a determined effort was made in Massachusetts to repeal the law which now interfered with its sale, and the result was that the State Senate appointed two professors of the Institute of Technology (an Institute second to none anywhere)—the Professor of Chemistry and the Professor of Biology—to make some definite experiments on the subject, and see what the effects of this gas were as compared with those of coal gas. These gentlemen could hardly experiment on human beings, and were obliged to make use of the animals to which Mr. Townsend alluded; although, during the course of the experiments, one of the Professors had a very strong indication himself of the effects of water gas if inhaled, for in a minute and a half he was knocked over, and was afterward quite ill. After making a series of experiments on animals, these gentlemen reported that the illuminating water gas should not, in their judgment, be allowed to be used in Massachusetts; and, so far, their report had been sustained by the committee to which it was referred by the Legislature. They were the first scientific gentlemen who had made a carefully prepared report on the matter; and this report could not be gainsaid. There might be differences of opinion as to the value of the gas. It was brighter, and in many cases cheaper than coal gas; and, in various localities, there might be circumstances which would make it desirable to use it. But as to the additional danger, there could be no question. One of the Professors testified that he went into the examination believing that the question was all nonsense—that the gas was no more dangerous than coal gas, and that the whole thing was a bugbear; but his opinion had been entirely changed in the course of the investigation. With regard to the question of fuel gas, he would simply say that there were several places in America where it had been tried; but he had yet to learn of any-

where where it had been a success. The statement made with regard to the intensity of heat produced by fuel gas as compared with coal gas, was quite new to him. It was possible that, in certain circumstances, it might be of material value; but he knew of a very careful series of experiments having been carried out with regard to the comparative value of illuminating gas, made by various companies, and in various ways, and of different qualities, with fuel gas pure and simple. They all showed conclusively at that time that, although the illuminating gas cost very much more, it was worth the additional money in heat-giving power; and that it was cheaper to use, for heating purposes, gas at a higher price, than to buy fuel gas which could be sold at a lower sum. Fuel gas had been sold in some cities for 50 cents, or 2s. per 1,000 cubic feet. In one case the company went into bankruptcy; in the second they applied for leave to make illuminating gas, because it did not pay; and in the third they were still struggling on, and he expected soon to hear that they were changing their fuel gas for illuminating gas. One point it might be worth while to mention, in case the thing should be tried. The pipes through which the fuel gas was supplied were much smaller, and it was supplied at a higher pressure, which would largely decrease the cost of distribution. If fuel gas had a smell of some kind put into it, so that its leakage could be perceived, there was no reason why it should not be supplied. It was used only in the daytime in buildings where, as a rule, it would generally be connected with the chimney; and the risk of danger would thus be much less than when employed to illuminate houses. With regard to this point, he had known of hotels in New York where a man was employed all through the night to go round to every room in the house, open a slit in the door, and ascertain whether the gas was escaping into the room. If the gas was escaping he broke the door open and dragged out the inmates; and in some cases life had been restored in this way. It was useless to deny the fact that in a large and crowded city, where people would go to bed “a wee fou,” and perhaps blow out the gas, there would be a number of people who would lose their lives if the ordinary elements of illuminating gas consisted of from 30 to 40 per cent. of carbonic oxide. With regard to fuel gas, the question was entirely different.

Mr. Denny Lane (Cork) asked the author of the paper whether all the nitrogen of the air was mixed with the gas in his producer.

Mr. Townsend replied that it was; it was simply ordinary producer gas.

Mr. Lane said this was essentially different from water gas. The tests that had been made by Messrs. Crossley showed that producer gas had about one-fifth the heating power of ordinary coal gas; and it would therefore require either much larger mains or much greater pressure. He would take this opportunity of replying to a remark on his own paper, which he had omitted to notice—viz., that he did not make any mention of compression in the gases. Now, the principal benefit which could be obtained from compression in a gas engine was that it would enable one to inflame or explode a mixture containing less gas than would be necessary at atmospheric pressure. With a mixture of producer gas at the ordinary temperature, it was necessary, when a gas engine was used, to compress the gas in the first instance to about 45 pounds, instead of to 30 pounds, which was the usual pressure employed with coal gas.

Mr. J. Head (London) said he hoped the members of the Gas Institute would not consider that apparatus of the form shown on the diagram was necessary for producing a smokeless flame in a boiler. There might be a certain amount of convenience in the moving parts at the foot of the producer which was proposed for making gas from coke; but, from his experience, he should say that such an iron structure placed in the midst of a fire would be very unstable. Further, he would say that, although coke could be used advantageously for firing boilers without producing smoke, recourse need not necessarily be had to this fuel for the purpose. Mr. Siemens accomplished the same object by means of perfect combustion, utilizing the heat in two stages—first the radiant heat from the flame, and then the heat from the products of combustion by bringing them into contact with extended surfaces. The tube in which the gas was burnt must be free from obstructions; and a confining ring being put at each end, and perhaps another in the center, whereby the flame was prevented from coming in contact with the boiler plates, combustion free from smoke was obtained either with gas from coal or from coke. At the same time a higher temperature of flame was secured; for when flame touched any part of the boiler surface (the other side of this surface being in contact with water), a great depression of temperature and loss of effect occurred. In the case of a boiler fired with gas made from coal, contact of flame with the plates would produce smoke, representing loss of effect; and although, if the gas used were made from coke, no smoke would be visible, the same loss of effect would occur, as a portion of the combustible gas would escape unconsumed.

Mr. Corbet Woodall said he was not surprised that when, at the conclusion of his paper, the author desired to point the ways by which the business of gas companies was to be increased, he departed from the subject-matter of his paper, and came on to lines more in accordance with the ordinary practice of gas making. In the closing sentence he referred to the advantage of

exhibitions of gas apparatus, and of considering better means of supplying gas for motive power, and the various other ways in which gas as ordinarily made could be used. These were the directions in which good was to be done, rather than the dual service described (but hardly advocated) in the paper. Interesting as it was from a scientific point of view, as addressed to a body of gas managers, intended, as he presumed, to lead them to consider the possibility of introducing a double system of manufacture, and a duplicate system of distribution, it had little practical value. Except that they might use the coke made on the gas works, which could just as well be sold to somebody else for the same purpose, there was no connection whatever between the two processes; and the fact that Mr. Townsend considered that it would probably be advisable in many towns, instead of distributing from one center, to have a number of works from which gas could be sent out over smaller areas, showed his own appreciation of the difficulties that were inherent to the separate system. He would not go into the calculation whereby the author had sought to show that the calorific value of ordinary producer gas was about half that of ordinary gas. In this he differed entirely from the experience and opinions hitherto expressed by those who made this gas, and who admitted that the difference was as three to one, and not as two to one. This being so, it would be necessary to distribute the gas at a pressure very much higher than ordinary, or to have the mains of three times the capacity of those used in distributing common gas for the same purpose. Now, taking the value of gas plant as divided in half at the outlet of the gasholder, though the distributing plant would be rather more than the manufacturing plant, the dividend charge on the former would amount to 6d. per 1,000 cubic feet; and if this had to be multiplied by 3, they would have something like 1s. 6. per 1,000 feet as necessary in order to pay the shareholders dividends such as they now expected from their investment in gas works. What they might very well try to do—and he was surprised that more had not been done in this direction—was to see whether or not ordinary gas, at the price at which it was now supplied in large towns, could not be used for heating boilers. It would be more convenient, and much more effective, than that described in the paper; and such business would come fairly within the scope of a gas company. He maintained that the idea of creating duplicate plant was altogether outside their business, could not be profitable, and would certainly be a cause of public nuisance and danger.

Mr. Townsend, in reply, said he could assure Mr. Greenough that nothing was farther from his thoughts than to cast any reflection on American chemists. Unfortunately, English chemists had not investigated the question; otherwise the onus would have been thrown on their shoulders. Nothing was more pleasant, in his experience at these meetings, than the brotherhood existing between them and their American "cousins;" and he should be extremely sorry if any word he had said were to prejudice in the slightest degree this harmonious feeling. The gist of Mr. Greenough's remarks was to prove that water gas was not a suitable agent for illuminating purposes. There he was quite at one with him. But he (Mr. Townsend) still thought that for industrial purposes there was not the slightest danger with it. The instances he gave in which it had not been successful were, he took it, in commercial or residential towns; and he quite admitted that there was at present no chance of success for fuel gas except in industrial centers. This also met, to a considerable extent, the argument of Mr. Corbet Woodall. He (Mr. Townsend) had particularly endeavored to point out the difference between the requirements of the two classes of towns, residential and manufacturing. He hardly grasped the point of Mr. Lane's remark. The producer was not intended to make gas for distribution, but simply to gasify coke for firing boilers *in situ*. With regard to Mr. Head's remarks, no one had a higher appreciation of the Siemens producer than he (Mr. Townsend) had; but he did not think Mr. Head would claim for it that it was a suitable agent for gasifying coke for firing ordinary mill boilers. Mr. Head said it had been done; but he (Mr. Townsend) had been speaking simply of matters of fact.

The President said that they were greatly obliged to Mr. Townsend for giving his views on this question, and for the pains he had taken in preparing the paper. He believed the reading of it had been good for them all, whether they entirely agreed with the views he enunciated or not, because it would perhaps enable them to come to a decision on this question in the near future.

Examining the United States Patent Office Records.

By FREDERIC EGNER.
"Class 48.—Gas."

The above is the official appellation given to one of the great divisions of the United States Patent Office; and this class is of especial interest to the gas maker who is desirous of informing himself—and thereby keeping himself informed—with regard to what is being attempted by inventors in the matter of advance in the field of his profession. This great class is divided into 21 sub-classes; and in order that the reader may have some idea as to what has

been done in the way of patenting so-called improvements in the manufacture and distribution of gas, the number of patents issued in each sub-division, from the year 1798 to 1885, is here given:

Number of Sub-Class.	Subject.	Number of Patents Issued.
I.—	Anti-combustion	7
II.—	Carburetors	618
III.—	Carburetors and jet mixers.....	73
IV.—	Center seals and bye-pass valves ...	9
V.—	Coal gas	34
VI.—	Coal and oil	18
VII.—	Coal, oil, and water.. ..	52
VIII.—	Coal and water	22
IX.—	Dip-pipes	55
X.—	Exhausters.....	12
XI.—	Gasholders	30
XII.—	Hydrogen	64
XIII.—	Oil.....	67
XIV.—	Oil and water	195
XV.—	Purifiers	153
XVI.—	Retort lids.....	49
XVII.—	Retorts and settings.....	258
XVIII.—	Retort chargers.....	49
XIX.—	Water (alone).....	80
XX.—	Wood	47
XXI.—	Gas distributors	2

—or total number of patents issued (or total of those granted that relate to the science of gas making) during the period of time mentioned equal to 1,893. Since the 1st of January, 1885, over 100 patents have been granted either for improvements on old or securing protection for entirely new processes and devices, embracing leak detectors, purifiers, systems of laying gas mains, etc.

The most interesting of the sub-classes at the present time is No. XIV., as it contains an enumeration of all the inventions covering the descriptions or sorts known as water gas apparatus. A careful study of the inventions in that class leads on to surprising results. It seems almost as if every possible point that could be claimed had been covered by the various inventors; yet not a month passes but some really novel feature is brought to light. Indeed, the march of improvement in gas making can nowhere else be seen to better advantage than by looking over the numerous inventions shown in "Class 48." Most of the earlier devices would now only cause a laugh if put on exhibition and brought before the critical inspection of the educated gas man of the present day; and yet the few meritorious inventions shown have clearly paved the way, step by step, to the nearly perfect apparatus we behold in the comparatively few thoroughly well equipped gas plants of our time.

It would be well for those who are consumed with the inspiration or idea that they have discovered a new and useful feature in gas making, and who intend to apply for a patent on such inspiration, to first carefully look over the field and see what has been done therein. It would mean many dollars to the "inspired," without mentioning anything at all about the saving in bitter disappointments, if this prudent course were followed.

To say the least, numbers of the devices under which gas is to be made are curious and often ridiculous. For instance, the drawings and specifications of Patent No. 291,463 outline a method under which the action of a dynamo-electric machine, driven by a gas engine, decomposes water into its primary elements. The oxygen is disposed of by uniting with the carbon electrodes employed, and the hydrogen is set free, carbureted, and stored as usual. A similar device was patented some 20 years before; but, instead of the dynamo feature, electric batteries were employed to effect the decomposition.

The gradual approach to perfection made by the various inventors and improvers of gas apparatus can also be clearly traced in looking over the files of "Class 48." The early efforts of the water gas patentees look very crude when placed alongside of their efforts of later date, or as we now see them.

Not a bad idea in the matter of making coal gas is shown in Patent No. 118,579. The only drawback to it is that its practical demonstration would require the expenditure of a large sum of money. For all that, it really appears feasible and promising; and it might be said that it is one which seemingly contains all the elements of success. Gas is to be made from coal dust and superheated steam—the material to be fed into a tall vertical retort. In the writer's opinion, no one who will carefully look into the matter can help feeling favorably impressed with it. The purifying feature of the same patent is not so good. The process would only do for the larger class of works, or when not less than 100,000 cubic feet per day is made.

Another inventor proposes to decompose water by means of heat and zinc. The oxygen would, with the zinc, form the oxide of that material, or the basis of a valuable paint; and the hydrogen would unite with hydrocarbon

vapors (which were to be present), and thus form a rich illuminating gas. That patent expired six or seven years ago; and, being now public property, anyone who may wish can try it. The name of the inventor was Elmer, but the number of the patent I do not now recollect.

It is, however, not the dead, but the live patents that interest us the most just at present; and as the writer has given them some attention, he may at some future period give the results of that investigation to the (gas) public through the columns of the JOURNAL. In view of the fact that—and not so very long ago either—a combination of all the water gas patentees had been threatened, it may not be lost time to see what really is or is not public property, so far as patent rights have anything to do with the question; and in the opinion of the writer an inspection of "Class 48—Gas," will be found well worth the time spent in making the examination.

A Review of the Report on the Efficiency and Duration of Incandescent Lamps.

By H. C. ADAMS.

The special committee appointed by the Franklin Institute last fall to determine the efficiency and duration of incandescent lamps has at last completed and presented its report. The work of the committee was, of course, simply an outgrowth of the Electrical Exhibition held at Philadelphia under the auspices of the Institute one year ago, and the time that has elapsed seems to warrant an expectation that the work has been thoroughly done. The anticipation is fully justified by an examination of the report, which is the most complete that has yet appeared upon the subject; and for care and scientific accuracy we do not believe the methods pursued could well be excelled. In view of all that, and of the increasing prominence of the incandescent lamp in the field of illumination, we feel that a short review of the report will be read with interest.

It was the aim of the committee to determine, first, the efficiency of each lamp; second, its life; and, finally, the relation between the efficiency and duration. The efficiency of the lamps was determined in a series of what were called preliminary tests. The candle power was determined in a series of most elaborate photometrical measurements. The instrument used was a standard Letheby-Bunsen photometer with a 60-inch bar and a Methven standard 2-candle slit. The electrical conditions were carefully measured and adjusted; so that each lamp should be tested at its normal potential. Then each lamp was measured in 65 different positions. First the lamp was placed with its carbon's plane vertical—that is, in its normal position as seen in general use. Then a measurement was made at every 30° of its equator, the lamp being revolved to the proper points, and, for clearness of explanation, being considered as a sphere. The mean of those measurements was held to give the "mean horizontal intensity." The lamp was then rotated vertically, and measurements again made at every 30°; and these were repeated at every 45° along its equator. These vertical measurements combined with the horizontal ones, and their mean ascertained, were held to represent the "mean spherical intensity." The light given off at the different points on the globe of the lamp is graphically shown in the report by a series of curves. From these it is seen that, with a circular filament, the light distributed horizontally is nearly constant in all directions; but with a rectangular filament the greatest amount of light is given off in the direction toward which the longest side of the rectangle is turned—or, briefly, the horizontal distribution is dependent on the cross-section of the carbon. It is seen, also, that the light given off from the top of the lamp is very meager; that, of course, being dependent on the position of the carbon there, and varying, in the different makes of lamps, from 3 to 13 candles.

The following is a summary of the preliminary tests. [We should state here that the only lamps entered for examination were the Edison, Stanley, Woodhouse and Rawson, White, and Weston; the Brush-Swan and Bernstein lamp makers declining to enter the lists.]

	Number of Lamps.	Volts.	Candle Power.	
			Mean Spherical.	Mean Horizontal.
Edison	31	97.57	15.47	19.24
Stanley	14	96.56	13.59	16.30
Stanley	11	43.98	13.42	16.44
Woodhouse and R.	11	55.53	15.64	18.68
White	10	49.99	12.44	15.05
Weston	24	111.42	16.43	18.07
Weston	10	70.40	15.18	16.85

The lamps were selected at random from lots forwarded by the manufacturers. The Edison lamps were the most uniform; but the highest average efficiency was obtained from the 44-volt Stanley lamps.

The same careful precision and patient labor that marked the preliminary tests also characterized the determination of the duration of the lamps. A room was set apart for the purpose, the door of which was locked and sealed upon the completion of each day's operations. An assistant examiner and a

watchman were in constant attendance day and night. A separate record was kept of each lamp's performance, as shown by the daily photometrical and electrical examinations.

The length of the duration test was fixed at 1,000 hours. Of the 20 lamps entered by the Edison Company 19 survived; the life of the other lamp was 295 hours. Of the ten Stanley lamps entered one survived; the average life of the others was 360 hours. Of the 20 lamps of the Weston make, 110½-volts, only 6 survived; the life of the others averaged 206 hours. It is due to Mr. Weston to say that he protested that the lamps sent for test from his laboratory were, through some mistake, not a representative lot, and the examining committee seem to acknowledge the fact.

The following is a summary of the results of the duration test in some of the lamps that survived:

Name.	Initial Candle Power.		After 1,000 Hours.	
	Spherical.	Horizontal.	Spherical.	Horizontal.
Edison—Lamp No. 1.....	15.3	18.8	9.3	11.4
“ “ No. 5.....	15.7	19.5	10.5	13.0
“ “ No. 10.....	14.0	17.7	9.8	12.4
“ “ No. 20.....	15.2	18.9	9.0	11.2
Stanley—Lamp No. 30.....	12.7	15.4	6.2	7.5
“ “ No. 8.....	10.8	13.2	5.4	6.6
Weston—Lamp No. 3.....	13.4	14.8	7.1	7.8
“ “ No. 7.....	17.3	19.0	2.9	3.2

The above figures will give a sufficiently clear idea of the condition of the lamps after the tests. All of them were more or less discolored. The candle power of each lamp suffered continual depreciation as the test progressed. We observe a reaction and a gain of intensity in the lamps at different periods of the test; but the depreciation was sure, and apparently very nearly proportional to the time that the lamp was in action.

On Heating Regenerative Gas Furnaces by Radiation from Flame.

At the Annual Meeting of the Society of Chemical Industry (England) Mr. Frederick Siemens, C.E., of London, read the following paper:

In tracing the action within a flame from the moment the gases unite until the heat has been fully abstracted from the products of combustion, the flame will be found to pass through various successive periods materially differing from one another. Of these there are two, which require quite different development and treatment. The first is the period of active combustion—the essentially chemical process by which the heat is produced. The second period is after combustion has been completed, when the products of combustion alone have to be dealt with, which still contain a great portion of the heat produced during combustion. The conditions of the flame during these two periods are so entirely different that it is quite reasonable that they should be separately and differently treated, and should not be considered as one, as has hitherto invariably been the case. Whilst chemical action is proceeding the flame ought to be allowed clear space within which to burn. It should not be interfered with by surfaces of any kind, and it should be allowed freely to emit its radiant heat; whereas the products of combustion, having very little power of radiation, and not injuring surfaces upon which they impinge, should be brought into contact with the surfaces to be heated for the purpose of abstracting their remaining heat.

As is well known, combustion is interrupted when flame meets solid surfaces; whilst the solid surfaces themselves also suffer—not so much from the heat as from the mechanical action of the flame. To explain these circumstances various theories have been proposed, as well as to account for the fact that flame has great power of radiation in its first stage and little in its second. It is agreed in all these theories that the gases in combustion forming the flame are intensely excited, and that the molecules of gas are rotating around one another, or are otherwise in violent agitation. According to the electrical theory (which is the one accepted by the author), a flame consists of small but innumerable lightning flashes; and it is at once evident that a solid body brought into such a flame obstructs its action, arresting the motion of the particles of gas which strike on it, as well as by its attraction and adhesion. The molecules of the gas not being able to move, combustion cannot continue—at least in those parts nearest to the opposing surfaces. As a result, smoke is produced, enveloping the obstructing surfaces; and radiation cannot act because of its inability to penetrate the cloud of smoke in which the flame is enveloped. Then, as regards the action of the flame on any surface, it is quite natural to expect that, if flame is composed of innumerable flashes of lightning, no surface or body exposed to it can long withstand its action. The flame in its first stage being composed of innumerable lightning explosions, and carrying free carbon, accounts also for its radiant power. In the second stage of the flame, as no chemical action is going on, and there is no free carbon to emit heat by its incandescence (the carbon being converted into invisible carbonic acid), it is quite natural that there should be little radiant action.

A flame radiates much better than a solid body, and in a different manner. A solid body radiates only from its outer surface, while a flame radiates from every point within it, and on its surface in every direction, or from every point of its entire volume in every direction. Thus the flat-flame burner produces nearly as much radiant heat and light from its edges as from its face; whilst the Argand burner serves as an illustration of a hollow flame—the light radiating outwards, not only from the outer surface, but from the inner surface through the flame itself; and heat and light obey the same law in this respect. If the area of a flame is doubled, it radiates four times as much as originally; whilst a solid body, if doubled in area, radiates only twice as much as before. A volume of flame applied for heating by radiation cannot be made too large from an economical point of view, because the radiation from a body of flame increases, not according to its outer surface, but in proportion to its volume. The reason of this is that each particle of carbon raised to incandescence within the flame acts as a center of radiation, and emits its light and heat in every direction, whilst a solid body simply radiates from its surface. Thus, in the flat-flame burner, as already mentioned, the edge radiates out nearly as much light as the face, and would radiate out quite as much, only that (owing to its narrowness) some of the incandescent carbon particles come in the way of the light radiating from those behind them.

From a careful consideration of the various circumstances thus set forth, connected with the production and action of flame, the author has designed a furnace, now well known as the radiation furnace, a short description of which in some of its applications will be given later on.

In order to employ radiation in the most profitable manner, a gas rich in hydrocarbons should be employed, for the production of which special forms of gas producers may be adopted with advantage. Of these there are two so far employed. One of these was described by the late Sir William Siemens in his paper, "On the Use of Coal Gas as a Fuel," read before this Society on June 29th, 1881. This producer may be shortly described as consisting of a cylindrical chamber truncated towards the bottom, which is filled with coal through a large hopper at the top. This chamber is formed of an iron casing, covered on the interior with a lining of refractory material, and in this lining passages are arranged all round for the exit of the gases. A large opening at the bottom admits of the withdrawal of ashes and clinkers that may be formed in the combustion of the fuel; and a blast (which, by preference, should be heated) is directed right into the very heart of the mass of fuel. The result is a very high temperature in the center of the mass; one of the essential conditions for the total conversion of coal into combustible gas being a maximum degree of heat at one portion of the process—and no heat is lost at that point, which loss would interfere with the due conversion of carbonic acid into carbonic oxide. At the same time, water, which is admitted by a continual streamlet into a pan near the bottom, is evaporated by the radiant heat of the fire, which is thus utilized; and currents of steam are directed or drawn into the apparatus, passing through the zone of highest temperature towards the center of the mass. They there become converted, by contact with the incandescent fuel, into carbonic oxide and hydrogen (free from nitrogen), which add greatly to the calorific effect of the gas produced.

The modified form of the Siemens old-type producer, which is also employed for the purpose of enriching the gases by transforming the heavy hydrocarbons which would otherwise form tar on condensation, is described in a paper read by the author's principal assistant (Mr. J. Head), before the Iron and Steel Institute, in May last. The gas producer is divided into two compartments, one of which receives the hydrocarbons (the volatile constituents of the coal), and the other the carbonic oxide formed by the decomposition of its solid carbonaceous matter. The proposed separation may be conveniently carried out by means of a curtain wall placed over the fuel, and by providing a separate outlet for the hydrocarbon constituents from the chamber thus formed.

That gases may be enriched by converting the hydrocarbons into permanent gases was determined by the late Sir William Siemens in the following manner: A certain quantity of gas was collected in a graduated receiver from one of the Siemens old-type gas producers. This gas was taken immediately above the fire through one of the stoking-holes, and was found, on cooling to atmospheric temperature, to be reduced in bulk from 120 cc. to about 85 cc.; the apparatus being at the same time much coated with tar. The receiver having been cleansed with spirits of wine and washed with water, another sample of gas from the same producer was taken, with this difference—that, on its way to the receiver, it was passed through a combustion tube, which was heated by a spirit lamp. The same volume being collected as before, the weight of gas taken would be somewhat less than on the previous occasion; and had the gas, on cooling to atmospheric temperature, been reduced to the same bulk as previously without a deposit of tar, the result would have been considered satisfactory. But a better result even was obtained. For the loss in bulk was only about 20 cc.; the receiver being comparatively free from tar. It is much to be regretted that time would not

allow of analyses of the gas obtained under these conditions to be made; but gas made from Staffordshire coal, in the Siemens' old-type gas producer, has been found to contain less than 35 per cent. of combustible elements when working at its best; whereas, gas made from the same coal in one of the Siemens' new-type gas producers, when the desired conditions for conversion of tar into permanent gases are present, has been found to contain 48 per cent. of combustible elements.

In some works it may be found convenient after the treatment of the hydrocarbon gases for tar and ammonia, to utilize some of them for illuminating purposes. Owing to the inferior description of fuel usually employed in gas producers, as compared with that used at gas works, the illuminating power of the hydrocarbon gases may not be found equal to the standard of the gas supplied by gas works. But larger or additional burners can be used; and by this means manufacturers may almost entirely save their gas bills. Taking each burner as consuming 7 cubic feet of gas per hour, even 100 such burners, lighted for 12 hours each day, would not consume all the hydrocarbons liberated from a ton of coal. Moreover, the quality of the illuminating gas could be improved by adding a little cannel coal to the fuel charged in the gas producers, or in some of them, during the time that the gas is required to be used for illuminating purposes; and this will afford an alternative method to the employment of larger burners, or a greater number of smaller ones. The gases not required for illuminating purposes should be returned to the main gas line supplying the furnaces. Indeed it is not desirable to use gases consisting mainly of carbonic oxide and nitrogen in regenerative gas furnaces, where the new method of heating by radiation is adopted, for which, as has been explained, gases rich in hydrocarbons are better.

In designing the regenerative gas furnace, in which radiant heat is to work to the best advantage, it is necessary that the gas and air ports shall open at some distance below the roof of the melting chamber, and at some distance also from the side walls; so that the inflowing gas and air may have unobstructed space after ignition for entering into combustion, and for the free development of the flame. For the same and other reasons the flame is kept as much as possible out of contact with the materials on the surface bed; and when these are crucibles, ingots, blooms, or packets of iron, they should be so placed that the radiant heat may play freely upon and about them.

This new system of applying heat within the modified regenerative gas furnace has now been employed for a sufficiently long period to establish the economy of the method, as well in regard to the fuel used as to the material of which the furnace is constructed, and that treated on its hearth. One of the latest and most interesting applications has been to the open-hearth steel-melting furnace. Various steel works throughout the country, and several glass works, are now modifying their furnaces so as to obtain the benefits offered by this new method of heating. Another important application of this method of heating is to forge, mill, and puddling furnaces; as, owing to the absence of contact between the flame and the materials with which the furnace is charged, a great reduction in the loss of metal which has hitherto occurred through oxidation will be effected.

In steel re-heating furnaces, contact of the flame with the ingots produces red-shortness in the metal, exhibiting itself in fissures, particularly at the corners of the ingots or blooms, when these are subjected to treatment either under the hammers or in the rolls. The removal of the injured portions involves a stoppage of the operations, resulting in a waste not only of material but of time also, and occasionally rendering the blooms entirely useless for the purposes intended. In the radiation furnace this cause of loss no longer exists; while there is also a saving due to non-oxidation of the metal. In iron re-heating furnaces the saving in waste of metal will be much more considerable than in furnaces for the re-heating of steel, owing to the higher temperature at which they are worked; and the metal will weld much more easily, as it is heated out of contact with flame. These furnaces should be made as long and wide as convenient, in order to obtain as much room for the development of the flame as possible, and for placing the ingots, blooms, or packets, sufficiently far apart to allow the radiant heat to reach them on all sides.

In heating furnaces constructed and worked, as hitherto, by contact of flame with the metal to be heated, the furnaces must necessarily be made as small as possible; for the flame under such conditions parts with its useful heat in a run of a few feet, after which the sooner it leaves the furnace the better. But when heating by radiation is adopted, the conditions will be quite changed; for the flame, not being brought into contact with surrounding objects (including the metal to be heated), will be kept at a uniform temperature throughout its course, radiating all the time the maximum heat required for the charge in the furnace. And when combustion has ceased, the hot gases will be deprived of their remaining heat through contact in the regenerators. It will, perhaps, be difficult for those accustomed to heat metal by contact with flame, to realize the possibility of effecting the same object better, more quickly, and more efficiently by means of radiation; but, to overcome the difficulty, it is only necessary to associate heating by

radiation exclusively with the regenerative gas furnace, in which both gas and air are raised to a high temperature before combustion, as without such initial heating a flame of high temperature, and one therefore capable of radiating intense heat, could not be obtained.

The new method of heating by radiation from flame offers the solution to an objection which has sometimes been made against the regenerative gas furnace on the ground of its great cost, which has certainly limited its application for heating furnaces in this country. But when a few, or perhaps one furnace only, will be built for a mill, the capital expenditure on furnaces even with separate boiler settings, should compare favorably with the cost of the old grate furnaces and boilers. Moreover, they will offer the advantages of saving in fuel, in wear and tear, and in metal. Manufacturers who think that the suggestion which has been made is in advance of the times, and who might doubt the possibility of obtaining a flame of such a considerable length as would be required for a furnace to heat 100 or 200 tons of metal per day, will be pleased to learn that the problem has been already solved by the author in connection with the manufacture of glass. There exist many furnaces of the dimensions now foreshadowed for heating iron and steel, some of which have a run of flame upwards of 40 feet long; and one of them, measuring 42 feet by 16 feet 6 inches, inside dimensions, and holding 130 tons of glass, is capable of producing 24 tons of glass per day, or at the rate of a ton of glass per hour, the consumption of fuel being about 18 cwt. per ton.

Another most important application of this new system, for the greater extension and improvement of which trials are now being made, is to the heating of boilers by means of gas; but, in order to obtain the greatest benefit from this method of firing, it is necessary that there should be use for the gas made in the producers by night as well as by day. If flame is allowed to touch the sides of a boiler, there is of necessity smoke produced on its outside surfaces, and the radiant heat of the flame not being able to penetrate such an atmosphere of smoke, the water in the boiler cannot get the advantage of it. It will readily be perceived how great a quenching effect the metal of the boiler has upon a flame, when it is remembered that the temperature of steam—which is, of course, that of the boiler—is only 311° F., even at 60 pounds pressure, whilst that of the gaseous flame in contact with it is about 2,000° F. In this application the principle has been followed of allowing the active flame to have free space for its development, and for the radiation of its heat within the length of the tube, and not allowing it to touch the sides until after complete combustion has been effected, when the products of combustion may be brought into direct contact with solid bodies. A boiler fired in this manner lasts longer, as the plates are worn away more readily through direct contact with the flame than from any other cause. As the remaining heat of the products of combustion come into direct contact with the sides or flues of the boiler and its regenerators, it is completely utilized, and the maximum of heating effect is thus insured. In various applications that have been made, a saving in fuel has been effected which varies from 25 to 30 per cent. These results, however, apply to ordinary horizontal-flued boilers, to which only this method of heating has been so far applied; but a vertical boiler is being constructed by the author, specially designed for the application of the new method of heating, from which it is expected that even better results will be obtained.

Another application of the new method of heating, which has been kindly suggested by Prof. Armstrong, F.R.S., is to the manufacture of coke in the ordinary beehive oven. A furnace for this purpose would be very similar in construction to the glass-melting furnace of horseshoe form; the flame radiating heat of a very intense character upon the coal to be carbonized, and the gases being drawn away below the bed of the furnace by means of an exhaust, in the usual manner. In order to prevent the flame being drawn down by the action of the exhaust, small coal (mixed, perhaps, with tar) should be charged on the top of the mass of coal to be carbonized, so that on heat being applied it would bind the upper surface, forming a skin impermeable to the passage of gases. The gases withdrawn from the bottom of the furnace may be led away for the removal of bye-products, and then re-delivered to produce the heat required for carbonization, and also utilized for other purposes.

There must be several applications of this new method of heating to the chemical industries which should offer important advantages. In some cases gas has been used with the sole object of avoiding the introduction of ashes or dust into the furnace; but where contact of the flame is not necessary, as regards the chemical operations performed, the new method of heating by radiation—first within the heating chamber, and contact afterwards with extended surfaces—will be a step in advance of the mere application of gaseous fuel.

PAPER MADE FROM SEAWEED.—It is reported that a Japanese inventor has discovered a process of making paper from seaweed. It is thick in texture, and owing to its transparency can be substituted for glass in windows, and when colored makes an excellent imitation of stained glass.

Mr. A. F. Upton Discusses the Relation of Steam Power to Electric Lighting.

During the progress of the semi-annual meeting of the National Electric Light Association, held in New York city last August, Mr. A. F. Upton, President of the Jarvis Furnace Company, of Boston, Mass., delivered the following remarks on the above-named subject:

The principal thing to my mind in regard to electric lighting is the power, and then comes the cost of power. I have always claimed, from my own experience, that the matter of power in regard to electric lighting was figured, in one sense, on a wrong basis. My idea, in order to get at the bottom of electric lighting, is that the cost of power should be most carefully looked to. The only thing to be considered is the actual price per lamp per hour—not evaporation or pounds of coal per hour. It is the actual cost of running an incandescent lamp per hour. The first question that would come in in regard to that would be fuel. In selling lights you are selling power. That is always to be kept before the mind. In carrying out that line of argument I propose to state my own experience. Believing that electric lighting had come to stay, we devoted all our energies toward getting up the most economical plants we possibly could. We decided to use direct-acting engines—that is, direct belting, not using long-stroke engines. That was our experience in watching several stations at the start, and in the stations that we subsequently equipped we adopted the Armington and Sims engine. In regard to boilers, we have finally settled on using a plain steel tubular boiler. The size we are generally putting in now is 6 x 16 and 140 3-inch tubes, giving us 120-horse power. At the Edison station in Brockton, Mass., with a boiler of that size and that engine, 150-horse power, with 80 pounds of pressure, we have run between 1,500 and 1,900 10 to 16-candle power lamps of the Edison system. We used cheap fuel. In a test taken with a sectional boiler, it showed an economy of 22 per cent. as regards using soft bituminous coal.

The principal point we have made in regard to fuel was utilizing all kinds of cheap fuel, such as screenings, soft coal, slack, cinders from locomotives, sawdust, cotton seed, waste, rice shucks. Anything that has anything combustible in it, whether wet or dry, we have used to good advantage. We have taken great pains to obtain our figures. In some cases I have got them; in others, not. There seems to be a reluctance among people to tell the figures. But the lowest I have is from the Thomson-Houston system, in Houston, Me. They are running at a fuel cost of two mills per lamp per hour. I found that the average cost on a station that we have fitted up has been (using screenings and soft coal, and using arc lamps) about 4 mills per lamp per hour. Incandescent figures I have not got. A test has recently been made where we partially fitted up stations on the Edison system. I have talked with a great many of the electric-light people, and I have tried to enforce my ideas that it is not evaporation, but the actual cost of the day or night's run that is wanted. If one man gets 50 cents, and another \$3, why, the man who gets the 50 cents gets the best results. In fitting up stations I spoke of using direct belting engines. We found, in making several tests, that the power used in driving shafting has run from 10 to 15 per cent. There are gentlemen in this convention who have a plant where it took 22½ per cent. of the power to run the shaft. There is a station in the city of New York where they have been shut two weeks from the breaking of the shafts. That can never happen where direct-belted engines are used.

Another point in running direct-belted engines. As a rule, not more than 100 arc lights are put on a circuit. Now, if those are run from one dynamo or one engine, if one engine breaks down, your whole system is disarranged. In fitting up stations I simply give what we use ourselves. We use Sheffield grates; we use the "National" heater, made in New Haven. Wherever we can we use the steam damper keeping the pressure even, and keeping the draft right. I would advise all to use, where tubular boilers are used, the steam cupola. I found that where slack coal or bituminous coal is used it helps much in keeping the tubes clean. Of course, that depends very much on the engineer and fireman. I found a great deal of difference in that. In every station we have put in scales for weighing the coal. All well-regulated mills with which I have any acquaintance scale all their coal. I do not wish to enter into the question of electric lighting. That is not in my line at all. But we have done work for a considerable number of companies.

I would like to speak of one system that is working now in the city of Lawrence. We have three engines in that station. We have just sold two 10 x 12 Armington and Sims engines, 90-horse power each, to run a new system that is just in there, called the "Municipal" system. They run on that system four circuits of ten miles each. I am now talking of the incandescent system. These are 32-candle power lamps. They contract for 500 of those lamps for \$650 per month. Now, it may puzzle you, but it puzzles the gas company still more, how they are going to do it. There is one other thing that has occurred to me several times that I think the electric light companies should take into consideration, and that is the letting of power. At this same station a large number of motors are used which run all day. They

run from ½-horse power to 5-horse power. Those motors are all employed, as I understand from the parties, at a good profit, and it has always seemed to me that everyone should use their power. You have it there, and why not use it? In the Thomson-Houston station the construction of the plant is so peculiar that I think I am justified in bringing it up before the convention. It was changed so that over the station a shoeshop has been fitted up. The shoeshop is run by the engines in the daytime, and they receive as a rental for that power \$2,000 a year. This is supplied by a 35-horse power engine. It does not require quite 35-horse power, because, while one engine runs the machine in the shoeshop, the other runs all the electric lights in the city. If all stations were built in that way there is not one in the country but what would hold out a very handsome profit on the surplus power they might have in the daytime.

Another point in regard to the station. There is an Edison Company started first, and afterwards a Thomson-Houston arc system, and this is the result that is given: After the incandescent started the sale of gas increased largely, and after the arc came in it increased again 10 or 15 per cent. Now, the question is asked, how did the introduction of so many arc and incandescent lamps increase the sale of gas? I can account for it in no other way than that, when one store is lighted brilliantly by electricity, the next one has to use more gas. But my experience in New England has been that every gas company has increased its sale of gas as the arc lights have been introduced. I have spoken of a station partially erected, and only partially equipped, where we set the boilers while the engines were being finished. That station was the first incandescent station that I ever examined. Instead of being underground it is all overhead, and the station, as they informed me, has been paying a profit from the start.

All gentlemen who start arc lighting do their own wiring. Contracts were made for the year, and payable monthly, so much per lamp every month, and the companies do the wiring. That, in my opinion, was the cause of the success of the station. A gentleman said to me the other day that it was not paying, and I said to him, "if any gentleman will go there and examine it carefully and look over the room, and if he says it is not paying a profit I will pay his expenses." The fuel costs 89 cents a ton.

We have had some experience in regard to electric lighting and water power in New England. But, as a rule, water power has been entirely abandoned. The trouble has been that it is not reliable. In Manchester the water has been very low several times in the last few years. In Lewiston and Holyoke it has given out altogether, and the stations there are entirely equipped with steam power. I understand there is a very successful station in Rochester running on water power.

Something About the Stevens Battery.

"If any of the millionaires who are owners of the new Queen Anne cottages at Babylon, Bayshore, or some of the other summer resorts on Long Island," remarks the *New York Times*, "were to be told their handsome woodwork finishings are merely remnants of the old Stevens battery, the statement would probably be received with many doubts. Yet such is the fact. When Mr. Stevens presented the famous vessel to the State of New Jersey, the United States government decided that a man-of-war could not be accepted as the individual property of any State. Mr. Stevens then offered it to the national government; but it was refused as being inadequate to perform the duties required of a war ship. Several suits followed this decision between the estate of Mr. Stevens and the State of New Jersey, which claimed that, although it could not hold the vessel, it was entitled to its value in money. The final decision was in favor of the State, and the Stevens battery, as it stood on the ways, was sold to Mr. William E. Laimbeer, of New York, for \$55,000. He was given six months in which to remove his purchase; but for half of that time he turned it over to the Stevens Institute for the use of its scholars. In consequence, Professor R. H. Thurston was able to give his pupils three months of the most interesting practical study that has ever been available in this part of the country.

"When all the movable articles had been carted away the two pointed ends of the boat were chopped off and the immense hull, over 400 feet long, was parted by its own weight. The labor of collecting the remnants was then comparatively easy. Immense quantities of giant powder were used, however, to reduce the bulk of the iron to a mass small enough to be carted away. There remains intact to-day but one article that was used on board the Stevens iron-clad steam battery. It is a bronze bell, 4 feet in circumference. This instrument of household torture rang the working hours at the old shipyard since 1842. A cast mark near the top bears the date 1841, and it is probably the oldest bronze bell in America to-day. It still performs its duty at the country place of retiring Dock Commissioner Laimbeer, father of the purchaser of the boat, at Tenafly, N. J.

"The heirs of Mr. Stevens say that he spent \$2,000,000 upon his pet project, in addition to \$500,000 granted for the purpose by the government. In his will was a codicil ordering the expenditure of \$1,200,000 additional,

which was made under the supervision of Gen. George B. McClellan. When put up at auction this mass of iron, that had never been afloat, brought \$55,000. It cost Mr. Laimbeer, in addition, \$31,000 to break her up; but by selling it only as raw material he made a very handsome profit.

"The dismantling of the hull occupied the balance of the time allotted the purchaser. On no day during this period were there less than 40 men at work, and at times the number ran up to 100. The woodwork was all found to be of the finest Georgia pine in a high state of preservation. That used in the sides of the hull was in layers of a thickness of 5 feet 6 inches. These layers were dovetailed together and secured by bolts 4 feet long. In and around these joinings creosote was packed in large quantities, and although this wood had been in place for more than 20 years, it was found to be in better condition than when freshly cut. All the skill of the workmen and the strength of the tools could not force the layers of wood apart, and the work was finally done by burning. It was found to be exceedingly dry and susceptible of high polish, and, as has been stated, a large quantity of it has been used in the new cottages built and building on the south shore of Long Island.

"From the hold were taken two engines of 6,000-horse power, each made expressly for use in a twin-screw vessel, and therefore worthless. They were broken up and sold to the Delamater Iron Works, from whence they came. In addition to the two propelling engines there were sixteen driving engines, which were preserved intact and taken to coal mines in Pennsylvania, where they are still used as superior to any new inventions. Over 2,000 tons of iron plate were taken from the battery and sold to the Catsauqua Iron Works, in Pennsylvania, and 33 per cent. of it was rerolled in this country. The balance was sent abroad. The bolts used in the construction of the vessel were made in Scotland for that purpose, and possessed unusual tensile qualities."

ITEMS OF INTEREST FROM VARIOUS LOCALITIES.

ANNUAL MEETING OF THE PROVIDENCE (R. I.) GAS LIGHT COMPANY.—The thirty-eighth annual meeting of the Providence Gas Light Company was held at the offices of that corporation on date of Monday, September 7th. An excellent attendance on the part of the stockholders is reported. President Barstow occupied the chair; and the report of Secretary Slater, covering the operations of the Company for the twelvemonth, was listened to with great interest. The financial showing made was eminently satisfactory, and this sound old corporation enters upon its next year of life and activity under the most pleasing and promising auspices. We hope to give Mr. Slater's document in a future issue of the *JOURNAL*. At the election for a board of directors the following-named gentlemen were selected: Messrs. William Goddard, Amos C. Barstow, Alpheus B. Slater, Royal C. Taft, Edward Pearce, Jesse Metcalf, Amos N. Beckwith, George W. R. Matteson, and Lucien Sharpe. At the directors' meeting, held immediately after adjournment of stockholders' assembly, the board was organized by the election of the Hon. A. C. Barstow as President; Col. William Goddard, Vice-President; and "Old Reliable," Mr. A. B. Slater, as Secretary and Superintendent. Evidently the people interested in the doings of the Providence Gas Company are pretty well satisfied with the way in which things were managed last year, since the above-named officials were chosen as their own successors.

REPORTED TROUBLE BETWEEN ENGLISH METER MAKERS AND THEIR EMPLOYEES.—It was rumored some time since that there was great likelihood of trouble between the English meter making firms and their employees in respect to the question of a reduction in wages; and in fact it was reported that all the large concerns at Oldham had taken steps to put a new and reduced scale in operation there. This, it seems, was not really the case, although it is more than likely that the subject had been discussed by employers. A late issue of the *Oldham Chronicle* contained the following in reference to the matter: "A paragraph which appeared the other day, in regard to the wages question among the meter makers employed in Oldham, to some extent conveyed the impression that a movement for a reduction had been instituted at the various works in the town. Such, though, is not the case, notice of reduction having been given at one establishment only, and this to an extent that has induced employees to leave, as their work was finished. With this exception the wages of the gas meter makers are not likely to be interfered with, for the present at all events."

ONE OF THE REFORMERS AGAIN "BOBS UP SERENELY."—We notice that a rather loosely named "band of benefactors," hereafter to be known as the "Gas Consumers' Benefit Company of the United States," filed its certificate of incorporation in the office of the New York County Clerk on date of September 7th. It is to be capitalized in the sum of \$500,000, and the incorporators and trustees are to be found in the persons of Messrs. Eugene Howard, Charles Hull Bottsford, George F. Gagens, and Walter M. Jackson. Bottsford is the jumping-jack who, as the supposed mouthpiece of "Reform-

er Sherwood," made such a ridiculous display of himself during the sessions at the Morton House in this city last spring, when the Senate Committee were "sitting on" the matter of the metropolitan gas supply. Judging from the title of the newly fledged corporation, Botsford seems to believe that the entire territory of the United States is just about large enough to afford proper scope for his talents in the matter of benefiting gas consumers; to ordinary folks it would seem that a much more restricted field might possibly contain him. If any one of our readers would like confirmation of this latter idea we refer them, by permission, to the Honorable Mr. McCann, member of the late State Assembly, from one of the Kings County districts.

LARGE TALK CONCERNING ELECTRIC LIGHTING IN NEW ENGLAND.—E. H. Johnson, President of the Edison Electric Lighting Company of New York city; E. H. Goff, President, and W. J. Jenks, manager of the incandescent department of the Electric Manufacturing Company of New York city; C. I. Silas Burney, of the Tremont House, Boston; and Charles B. Whiting, banker, of Worcester, Mass., are the directors of two new companies, organization papers of which were signed and executed in this city on a recent date. The new concerns are to be known as the American-Edison Illuminating Company, of Worcester, Mass., with a capital of \$100,000; and one of similar name for Lowell, Mass., with a capital of \$50,000. It is said that a contract has been made by the American Company, of this city, to light the city of Portland, Me., under which a large number of the Edison Municipal incandescent lamps are to be employed, and is the initial work under the American-Edison compact made early in the summer. Central lighting stations are to be erected in Worcester and Lowell; and it is asserted that the American Company is preparing and maturing plans for securing street lighting contracts in every New England city. The managers of the corporation are circulating the old-time fables about the great advances made in "their own" arc and incandescent lights, as a result of the alliance secured between the American and Edison Companies, etc. They have gone so far as to claim that, assisted by the "great improvements that have recently been made," they can now successfully compete with gas "at any price at which that commodity can be sold at a profit," and give "at least three times the amount of light, at the same price charged for the gas illuminant." Of course, all these nice-sounding promises are calculated to attract the attention of investors who do not know much about the matter of artificial lighting; and that is the very reason why the electrical promoters are so lavish with their "candle power and cheapness" theories. Once the money is absorbed in the capital stock of the enterprises, the deluded investors find out, through bitter experience, that dividends thereon are "a long time a comin'."

CHEAPER GAS FOR TIFFIN, OHIO.—Mr. Jos. Bate, Superintendent of the Tiffin Gas Light Company, writes us that from and after October 1st the price of gas for lighting purposes will be fixed at two dollars per thousand cubic feet. Special rates are made at Tiffin for gas used for fuel and power purposes. This is a reduction of 25 cents per thousand from the former rate. Brother Bate means business.

NO WATER GAS IN THAT LOCALITY.—The following letter explains itself: "BEAVER FALLS, PA., Sept. 8th, 1885.—To the Editor AMERICAN GAS LIGHT JOURNAL:—The Lowe 'organ,' published at Philadelphia, in its issue for August last, while noting the new discount list of the Beaver Falls Gas Company, says we use the Lowe process. We wish it distinctly understood that we have not made a foot of water gas since the 12th day of last February, and never will while the works are under the present management. Without going into details, our three years' experience with water gas, made in apparatus constructed and erected by Prof. Lowe himself, proved it to cost as much as coal gas, and to be very much less satisfactory to our consumers. We have been furnishing exclusively, since the date in last winter mentioned above, an illuminant which contains 86 per cent. of natural gas. At first we were rather timid about disclosing this fact; but the encouragement received from our largest and most fastidious consumers, in praise of the 'best gas they had ever had,' made us more bold, and we now care not who knows the proportion of natural gas contained in the illuminating agent supplied from our works. We believe we are the first to employ such a percentage of natural gas, and secure the requisite amount of brilliancy, as well as 'stiffness' and power to resist sudden draughts or gusts of wind. This latter quality our product possesses in a degree equal to that of coal gas.

"Yours, etc., J. M. CRITCHLOW, Supt. Beaver Falls Gas Co."

A GREAT NATURAL GAS TERRITORY.—Beaver County, Pa., is fast rivaling the famous Murrysville district as the abiding place of the "roarers." A new natural gas company, with a capital of \$300,000, and known to corporate fame as the Economy Gas Company, own or rather has leased a plot of about 7,000 acres of territory contiguous to the wells operated by the Bridgewater Gas Company. On a recent date the drills of the new concern penetrated the reservoir or basin, and the managers already rejoice in the possession of

the largest well yet struck in that territory. They will pipe, with 8-inch wrought iron mains, 11 miles to Rochester, New Brighton, and Beaver Falls. They have even now secured fuel contracts extending over three years that will net them an annual return of \$70,000. The officers of the Economy Company are as follows: H. Hice, President; H. C. Fry, Treasurer; A. F. Allen Brown, Secretary.

LOOKING FOR A CONTRACT.—It is said that a proposition was recently made, by a representative of the Evanston (Ills.) Electric Light Company, to the trustees of that city, looking to the lighting of the streets by means of electricity. For the sum of \$3,000 (at least so our information goes) the company proposes to place 30 arc lights, and maintain the same, at points where the trustees may direct. In return they want an ordinance giving them the exclusive right to operate and maintain the business of electric lighting, together with the necessary license for erecting poles, etc. Could we call upon Mr. T. A. Cosgrove to forward us particulars regarding what conclusion was arrived at in the matter? We would esteem it a favor.

BOSTON'S BAD DRINKING WATER.—We learn that the investigation or examination of the water supplied to Boston, Mass., from the Sudbury River and Cochituate has been concluded by the Norfolk and Suffolk Medical Society, and the report shows a serious pollution or contamination of the supply by sewage. It says that the water of Cochituate, which is the chief source of supply to the city, is more dangerous to health than the Mystic water, and the evil grows worse every day. An analysis of the Cochituate fluid shows that, in comparison with water supplied to fourteen other named cities, Boston's drinking water contains the largest proportion of free ammonia and albumenoid ammonia, the products of sewage contamination. The bad features of the case are rendered more striking when it is remembered that 15 years ago the water supplied for potable purposes in Boston was hardly, if at all, surpassed by that afforded or furnished in any other city in the Union.

PERSONAL.—We are informed that Mr. R. P. Spice, the London gas engineer, whose name is known and respected the world over amongst his *confreres*, is at present on a visit to this country. The distinguished gentleman arrived "in the States" about the 1st of September, and the prime object of his appearance here was to pay a visit to "his next of kin," Prof. Robert Spice, of the Polytechnic Institute, Brooklyn, N. Y. We hope that the estimable gentleman will enjoy a right royal time; but it is measurably certain that he will find himself at least partially at home, since it is not his first visit to these shores.

AMUSING HIMSELF.—Mr. A. L. Allen, of Poughkeepsie, N. Y., still keeps amusing himself by furnishing the Poughkeepsie *Daily Eagle* with wonderfully elaborate accounts concerning the relative dangers of water and coal gas—or rather between the Allen-Harris style of product and coal gas. Of course, the "Allen" gas takes the premium in every respect—as to freedom from danger, cheapness, brilliancy, and so on. One paragraph in Mr. Allen's latest communication we will here put on record. It is thusly: "The Citizens Gas Company, of Poughkeepsie, working for ten years under this process, has fully demonstrated the truth of the above statement * * * by purifying an average of 113,000 cubic feet per bushel of ordinary slacked lime. No other process in the world has ever approached such results. The highest average obtained by the largest and best coal companies has fallen short of 5,000 cubic feet." Oh! Mr. Allen! Evidently, from the foregoing, the Cooper Coal Liming Process would have but little chance of obtaining a foothold at the Poughkeepsie Citizens' works.

A PRACTICAL EXAMPLE AS TO WHICH SORT IS THE MORE DANGEROUS.—Now, while Mr. Allen is engaged on the work of amusing others (if not himself) with his comparisons as to the relative dangers of water and coal gas, speaking in regard to their effect on the human system, we are unfortunately required to give frequent examples of a practical nature in regard thereto. The latest instance of the kind is in the following account which is taken from the columns of a Rochester, N. Y., daily paper, date of August 30th, 1885. "Among those who registered at the Congress Hall hotel on Friday evening, was Geo. W. Bell, a commercial traveler from the town of Phelps, in this State. Bell retired just before midnight, occupying one of the rooms on the third floor. Yesterday forenoon (Aug. 29th) a chambermaid informed Frederick Rafe, the clerk, that there was something wrong in Mr. Bell's room. The door was forced open, and Bell was found lying on the bed unconscious. The gas burner was partly open, and the room was filled with gas. Dr. Davison was summoned, and later on, Dr. Hovey, but all efforts to restore Bell to consciousness were in vain, and the unfortunate man expired shortly before one o'clock that afternoon. Coroner Sharpe was called, but after learning the facts in the case, deemed an inquest unnecessary. A sister of the deceased arrived in the evening, in response to a telegram informing her of the sad occurrence, and took charge of the remains." The death of Mr.

Bell makes the fourth case of fatal gas suffocation in Rochester since the introduction of water gas there. On the contrary, the old Rochester coal gas light company has been in operation since 1849, and that corporation cannot be charged with contributing a single name to the ever-growing list of cases credited to "suffocated by gas."

REPLACING OR DISPLACING THE ELECTRIC LAMPS.—The Siemens Regenerative Gas Lamp Company, of Philadelphia, Pa., keeps on the "even tenor of its way" in the matter of "rooting out" the arc lights that hitherto held lighting sway in many of the squares of the City of Brotherly Love. The latest case of "rooting out" is that done at Franklin Square, where 17 electric lights have been dispensed with, and in their stead were placed the Siemens high-power burners. The average citizen is delighted with the effects in lighting developed by the substitution, and it pleases us to add that the authorities have authorized the Siemens Company managers to place their lanterns on three additional squares. Keep it up, Brother Stein. But that advice is hardly necessary, for "keep it up" you certainly will.

WHAT IS THE CITY COUNCIL AFTER?—Certain members of the Columbus (Ohio) City Council are engaged in making a most absurd rumpus over the way in which the "gas consumers are being swindled by the Columbus Gas Company." Some of the more assinine members of that "highly honorable" conclave have had the unblushing effrontery to assert that, while the company had been reducing the price of gas, the bills to consumers for same had not materially diminished. They claimed that tests which had been made proved that the pressure maintained had been so greatly increased that fully 40 per cent. of gas "had been forced through the jets and not consumed;" one erudite councilman explaining that "this counted all the same in the reading of meters and keeping up the bills." By the way, would it not be well to call "our own Bottsford's" attention to this Columbus councilman, since it would appear likely that he (the councilman) might make a valuable addition to that "Consumers' Benefit" organization alluded to in another column. It is not to be supposed that Emerson McMillin is the sort of man to stand idly twiddling his thumbs while listening to the charges of extortion and fraud made against his company by the blowhards of the Columbus Council. On the contrary, "Mac" was up and doing; and the answer made by him, through the public prints of his city, in regard to the charges formulated, is complete and convincing. We regret that our copy of same reached us too late for publication in this issue, but in our next we will reproduce it in detail. By that time we will also have received the official results of the pressure tests which were to have been made this week, and which undoubtedly have shown up in its true light either the ignorance or willful mendacity of the "city fathers." It might be barely possible that the Columbus Councilmen are striving to stir up a sentiment unfavorable to the gas company, in order that, under cover of the same, they may pattern after the model set them by their prototypes in Chicago, Ills. In plain English, that they may set afloat a blackmailing opposition scheme. But, on the other hand, it would not appear so likely, either, that such unfavorable sentiment toward the gas company could be excited to any considerable extent, since Mr. McMillin's treatment of his patrons has been of such a nature as to secure to him and his company their hearty goodwill and co-operation. His course in the past will be of great service to him now.

TRYING TO CHEAPEN THE RATES.—Mr. J. L. Stamford, Manager of the Olympia (Washington Territory) Gas Light Company, writes us that on August 15th last the following notice was issued to the citizens of that town: "We now have 40 consumers on our books, and, with a view of increasing its sendout, the Olympia Gas Company offers the following proposition: Upon all gas bills paid by the fifth day of each month, when the number of consumers have been increased to 50, a discount of 50 cents per thousand cubic feet will be allowed, or a rate of \$3.50 per thousand be thereby established. When the list has been increased to 100 consumers, a further discount of 50 cents per thousand will become operative. As the number of our patrons increases over the 100 limit other reductions will be made." A rather novel plan seems that instituted by Mr. Stamford, and it looks to us as though Mr. S. has managed to secure the services of 40 active canvassers. Taken as a whole, it is far from being a poor line of policy, and we make little doubt but that the "hundred notch" will speedily be reached. Gas was turned on at Olympia for the first time on the evening of March 27th, 1885; and while it is the capital seat of the Territory, it contains a population of but about 1,400 inhabitants. Now, it goes without saying that the people who invested money in the Olympia gas plant must have had great faith in the future of their town, and, if it were for no other reason, we hope their enterprise may prove successful on account of the "pluck" thus shown.

THE PLUMBERS MAY STRIKE.—It is rumored that the journeymen plumbers of New York city are about to come in conflict with their employers, the question of wages being at the bottom of the movement. Their demand is that the daily rate of pay be advanced from \$3 to \$3.50; but the "bosses" cannot be prevailed upon to accept the proposed new scale. A "lock-out," it may be predicted, is tolerably certain to occur.

NATURAL GAS EXPLOSION.—A severe explosion occurred at Pittsburgh, Pa., on the morning of August 31, in the oven room of S. S. Marvin & Co.'s steam bakery. Five persons were severely injured thereby. The firm had recently introduced natural gas as the agent for heating the ovens, and the explosion resulted through the carelessness of one of the company's employees.

SPONTANEOUS IGNITION.—Some peculiar instances of spontaneous "ignition" of various substances, with attended loss of property, would appear, says an exchange, to have been due to simple ignorance of the relations of animal, vegetable, and mineral oils to combustion. Prof. Atfield points out that the two former are much safer than the latter, since they do not ignite at low temperatures nor give off vapor which, when mixed with a certain portion of air, explodes in contact with flame; on the other hand, in their liability to spontaneous ignition, when freely exposed to the air under certain conditions, they possess a dangerous property from which the mineral oils are free. Then, too, the animal and vegetable oils differ considerably among themselves in the rate at which they cause the generation of heat on being exposed to air, upon the surface of fabrics, shavings, or other materials; though all are more or less liable to this result when spread out in thin films, or in any other state of minute division. What are known as drying oils are particularly susceptible to such atmospheric influences, the drying itself consisting in the conversion of the oil into a kind of rosin by the action of the air.

Correspondence

[The JOURNAL is not responsible for the opinions expressed by correspondents.]

Sidewalk Stopcocks.

OFFICE OF TIFFIN GAS COMPANY, }
TIFFIN, OHIO, Sept. 4, 1885. }

To the Editor AMERICAN GAS LIGHT JOURNAL:

I am much interested in the question, discussed at the late Western Association meeting, regarding stopcocks at sidewalks to consumers' services.

Some 15 or 16 years ago, when my brother, T. A. Bate, was in charge of the New Albany (Ind.) gas works, I was employed by the same company, and I well remember that he assigned me the duty of "going all over town to dig up and repair the stops at curbstones." In no instance did I find (except in the case of those recently placed) a stopcock that would turn without expenditure of much force upon it, and not a few of them "lost their heads" in the operation.

I have been manager of the Tiffin works for 13 years, and have never put in a stopcock at curb. When the larger services (from one to two inch) are run, I place a main stop at area or street wall. Have "gone through some fires," and always shut off the gas. Have a bag, loaded with the necessary tools, at both my house and the office. Always "run to fires;" and my assistant does the same. Of course, it is understood that we are speaking of small places.

In large cities I presume a straightway valve would answer for large services, and be easily turned; but still these must naturally require some attention. Stopcock boxes gather dirt, and are great retainers of frosty accumulation. We have a few old services equipped with stops; but on all new ones they are omitted. If, for any reason, a consumer has his supply cut off, we remove the inlet connection at once and cap the service—indeed we would be most happy to discover *anyone* outside of the gas company who would make such removal. There are laws operative in the State of Ohio that recognize even the rights of gas companies.

Yours,
JOS. BATE, Sec'y. and Supt.

Recent Patents.

[The following list of patents, relating to improvements in gas apparatus, etc., issued by the United States Patent Office on the dates specified, is specially reported for the JOURNAL by FRANKLIN J. HOUGH, Solicitor of American and Foreign Patents, 925 F street, N. W., Washington, D. C.]

ISSUE OF SEPT. 1, 1885.

- 325,448.—Gas and air, apparatus for mixing. J. R. Serimshaw, Brooklyn, N. Y.
- 325,590.—Gas and oil pipes, automatic stop valve for. W. S. Cosgrove and F. F. Jennings, Jersey City, N. J.
- 325,378.—Gas engine. C. W. Baldwin, Yonkers, N. Y.
- 325,509.—Gas pressure regulator. E. Derval, Paris, France.
- 325,510.—Ditto. R. B. Dick, Philadelphia, Pa.
- 325,459.—Gases and fluids, device for regulating flow of. G. Taylor, Jersey City, N. J.

ISSUE OF SEPT. 8, 1885.

- 325,766.—Gas, apparatus for generating illuminating. L. M. Potter and R. Bocklen, Jersey City, N. J.
- 325,747.—Gas burner. I. Kendrick, Phila, Pa.
- 325,928.—Gas burner, automatic safety. Haines & Strong, Flushing, L. I.
- 325,786.—Gas lighter. J. A. Cabot, New York City.
- 325,589.—Gas service valve. H. A. Stearns, Lincoln, R. I.



A. M. CALLENDER & CO.,
PROPRIETORS.

Editor—JOS. R. THOMAS, C.E
Manager—C. E. SANDERSON.

PUBLISHED ON THE 2ND AND 16TH OF EACH MONTH
At No. 42 Pine Street, New York.

WEDNESDAY, SEPTEMBER 16, 1885.

Wanted, Second-Hand, ONE SECTION OF HYDRAULIC MAIN,

Either Cast or Wrought, for bench of threes. Distance between centers of dips, 1 ft. 11 in. Address, giving lowest cash price, P. O. Box No. 5104, BOSTON, MASS.

WANTED,

A Second-Hand 6-Inch Cone Gas Governor, in Perfect Condition.

Any company replacing its governor by a larger one, and willing to sell cheap, may find a customer by addressing—giving lowest cash price— P. O. Box No. 5104, BOSTON, MASS

SITUATION WANTED, As Superintendent,

By a gas engineer who is at the present time superintendent of a gas works. Desiring, for good and sufficient reasons, to make a change, he now offers his services to any first-class company that may require a reliable and responsible man. Best of references. Address "J. S.," care this Journal.

Position Wanted,

AS SUPERINTENDENT OF A GAS WORKS

Where the services of an honest, temperate, industrious man would be appreciated. Has had nine years practical experience in the manufacture and distribution of gas, and in the office work of first-class gas works. For particulars and references address "X. Y. Z.," care this Journal.

FOR SALE, Second-Hand Gas Apparatus.

The Louisville (Ky.) Gas Light Company wishes to dispose of the following:

- 15 Sixteen-Inch Chapman Valves.
- 6 Twelve-Inch Chapman Valves.
- 2 Twelve-Inch Center Seals & Connections.
- 2 Smith & Sayre Gas Steam Governors.

All in good order, and will be sold at low figures. Address inquiries to
A. H. BARRET,
Engineer's Office, Louisville (Ky.) Gas Company.

BROOKS, SHOOBRIDGE & CO. Best English Portland Cement

WORKS: GRAYS, ESSEX, ENGLAND.

New York Office, No. 7 Bowling Green.

HOWARD FLEMING, 23 Liberty Street, New York.

IMPORTER OF THE BEST

Portland & Roman Cements

"DINAS" SILICA FIRE BRICKS AND BLOCKS
For Coke Ovens and Gas Works.
Correspondence invited. Lowest prices.

FOR SALE. Second-Hand Gas Apparatus.

One Condenser, 4½ ft. diameter by 13 ft. in length over all, containing 150 two and one-half inch tubes, 8 ft. long with 12-in. connections and bye-pass.

Two Smith & Sayre (12-inch) Steam-Jet Exhausters, with 3 Self-acting Bye-Passes.

Four Purifying Boxes, 10 ft. by 14 ft. by 3 ft., with 12-inch connections and center seal.

All in good order, and will be sold cheap. Address
PETER P. MILLER, Manager Citizens Gas Co.,
Buffalo, N. Y.

DYCKERHOFF PORTLAND CEMENT

Is superior to any other Portland Cement made. Its extraordinary strength permits a greater addition of sand, while its acknowledged uniformity insures the most reliable and strongest work. It is therefore the most economical to use. Circulars, with testimonials and tests, sent on application.

H. THIELE,

SOLE AGENT, U. S.,

78 William Street, - - New York.

PATENTS.

FRANKLIN H. HOUGH,

Solicitor of American & Foreign Patents,

925 F. ST., WASHINGTON, D. C.

(NEAR U. S. PATENT OFFICE.)

Personal attention given to the preparation and prosecution of applications for Letters Patent. All business before the U. S. Patent Office attended to for moderate fees. **No Agency in the United States possesses superior facilities for obtaining Patents,** or for ascertaining the patentability of inventions. Copies of patents furnished for 25 cents each. Correspondence solicited.

GIBBS PORTLAND CEMENT

Is guaranteed to be the finest English brand, and unsurpassed by any grade imported for making concrete and setting masonry.

Extract of paper, with tests, read before the Am. Soc. of Civil Engineers, sent on application.

HOWARD FLEMING,
Sole Agent for U. S.,
23 Liberty St., New York.

GEROULD'S IMPROVED RETORT CEMENT.

Used by most of the Gas Companies of the United States with perfect satisfaction. Manufactured by

C. L. GEROULD,
Manchester, N. H.

N. B.—As Manchester is a shipping point, all freight can be shipped as cheaply as from Boston or New York.

Iron Sponge,

CAS EXHAUSTERS,

AUTOMATIC GAS GOVERNORS,

CONNELLY & CO., Limited,
No. 407 BROADWAY, NEW YORK CITY.

JOS. R. THOMAS, C.E.,

May be Consulted on all Matters Relating to Gas Works and Gas Manufacture.

ADDRESS THIS OFFICE.

BROCK'S PATENT DROP FORGED CHAIN PIPE WRENCH

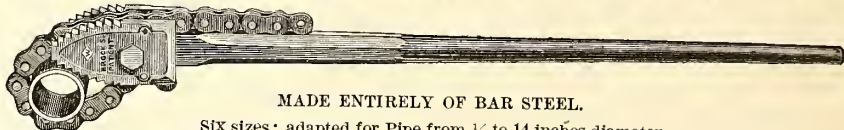

MADE ENTIRELY OF BAR STEEL.

SIX sizes; adapted for Pipe from ½ to 14 inches diameter.

Each number will fit a range of sizes equal to six or more pairs of common tongs, while it will outwear an equal number of any kind.

All parts are interchangeable, and can be readily renewed.

Jaws are hardened to a saw temper, and can be sharpened with a file.

Does not crush pipe; has a quick grip; never slips; chain will not unhitch while in use, but can be instantly released.

J. H. WILLIAMS & CO.,

Manfs. of Every Description of Iron and Steel Drop Forgings.
No. 14 BOWNE STREET (Near Hamilton Ferry), BROOKLYN, N. Y.

CHURCH'S REVERSIBLE SCREEN FOR GAS PURIFIERS

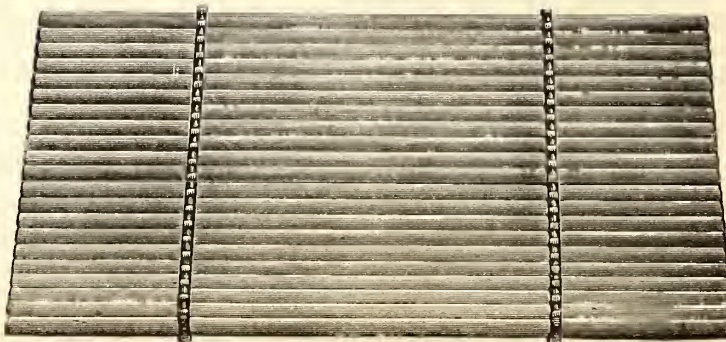

PATENTED JULY 9, 1878.

References in all parts of the country. Send for circular and list of companies who now have the Screen in use.

**Very Durable
Easily Repaired.**

**Oval Slats, with
Malleable Iron
Cross Bars.**

Apply to

**JOHN CABOT,
LAWRENCE, MASS.**

NATIONAL GAS LIGHT AND FUEL COMPANY, Chicago.

Builders, Lessees, and Purchasers of

GAS WORKS,

UNDER THE

Springer Cupola
Gas Generating System.

Sole Owners of the
**SPRINGER PATENT
CUPOLA PROCESS**
For the United States.

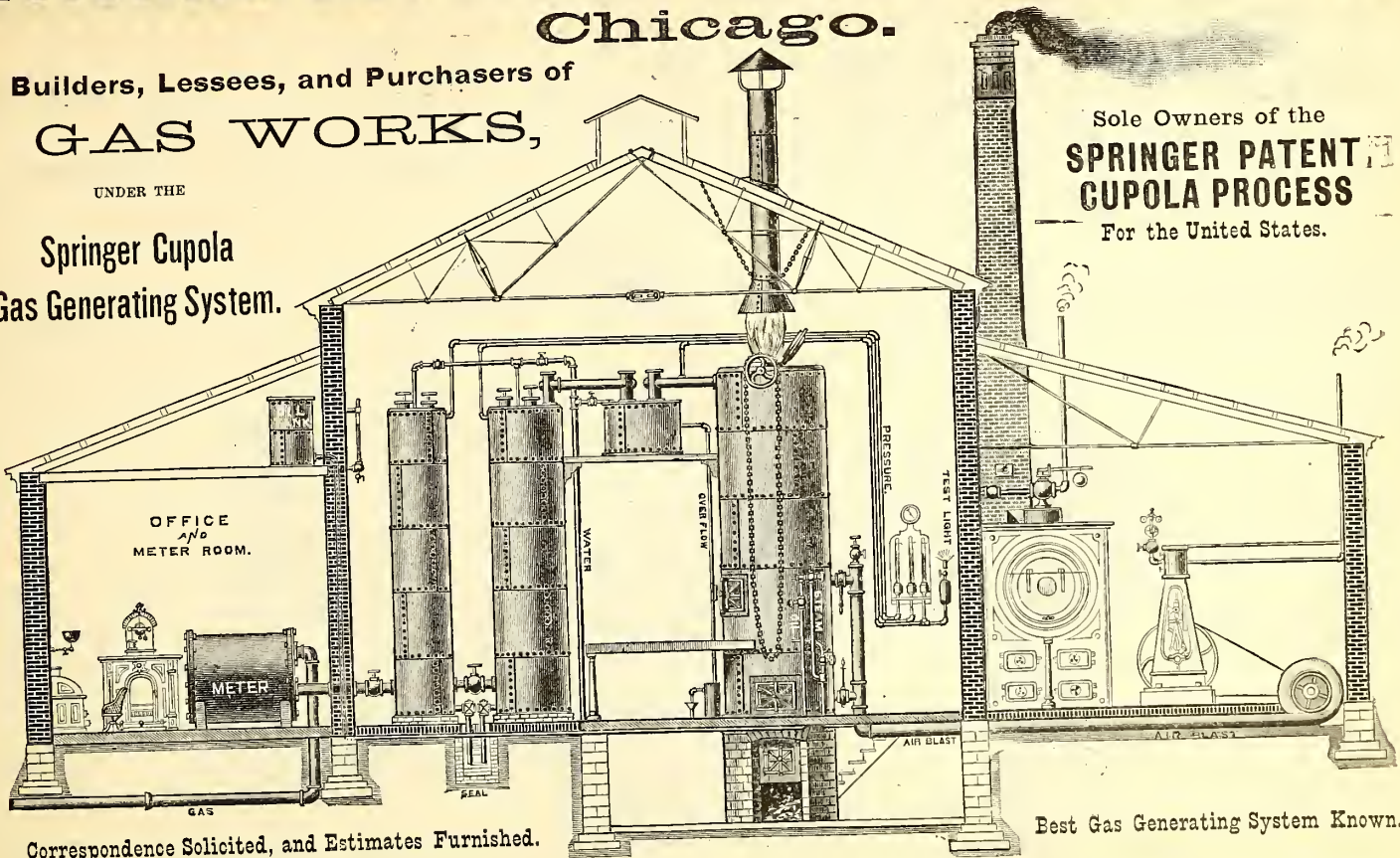

Correspondence Solicited, and Estimates Furnished.

Best Gas Generating System Known.

Orders from Cities, Towns, and Public Institutions Promptly Executed. Address
NATIONAL GAS LIGHT AND FUEL CO., No. 162 Washington Street, Chicago, Ill.

WM. FARMER, ENGINEER,
32 Park Place, Room 36, New York.

THE CHEMIST'S ASSISTANT; OR, KINDERGARTEN SYSTEM OF CHEMISTRY.

A system by which the elements and their valences are represented by illustrations and solid bodies.
BOX AND PAMPHLET COMPLETE, \$2.50.

MITCHELL, VANCE & CO.,

MANUFACTURERS OF

Chandeliers

and every description of

GAS FIXTURES.

Also manufacturers of Fine Gilt Bronzes and Marble Clocks, warranted best time-keepers. Mantel Ornaments, etc.

Salesrooms, 836 Broadway, N. Y.

Special Designs furnished for Gas Fixtures for Churches, Public Halls, Lodges, etc.

W. H. DOAN,

REFINER OF

NAPHTHA and GASOLINES

ALSO MANUFACTURER OF

A Special Grade of Naphtha for Gas Companies

FOR ENRICHING COAL GAS.

Correspondence solicited.

No. 43 Euclid Avenue, Cleveland, Ohio.

It will "Pay the Piper,"

If he aims to pipe well for STEAM, WATER, GAS, ACIDS, OILS, AMMONIA, &c., to examine this UNION, which requires no packing, but is always ready for instant use. When you next order Fittings of any Dealer, ask for a sample American Union to come with them, and it will tell you the whole story, or we will, if you write us for particulars.

PANCOAST & MAULE,
PHILADELPHIA, PA.

GAS CO. OFFICERS,

READ AND REFLECT.



HODGE'S UNIVERSAL ANGLE UNION, Pat'd



A new and important Pipe Fitting for Steam, Water, or Gas. Combining a variable angle or elbow and a union. Saves pipe, saves time, decreases friction and radiation, gives a union joint at every angle, and can be set at any angle at which it is desired to run the pipe.

HODGE'S SWIVEL FLANGE,

A common sense article, designed to save time and money.

MANUFACTURERS AND WHOLESALE AGENTS,

ROLLSTONE MACHINE CO.,
142 Water St., Fitchburg, Mass.

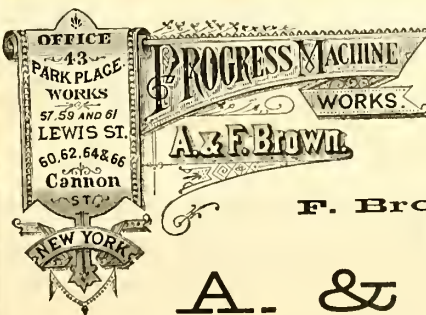

Shafting, Pulleys, HANGERS.

F. Brown's Patent Friction Clutch.

Send for Illustrated Catalogue and Discount Sheet to

A. & F. BROWN,

No. 43 Park Place, New York City.

Pipe Coverings.

Fireproof, Non-Conducting Coverings for
STEAM PIPES, BOILERS,
And all Hot Surfaces.

Made in sections three feet long. Easy to apply; light and cheap.
Asbestos Materials, Fibre, Braided Packing, and Cement. These goods are used at Continental Works, Br'klyn.

CHALMERS-SPENCE COMPANY, 419 & 421 EIGHTH ST., N. Y.

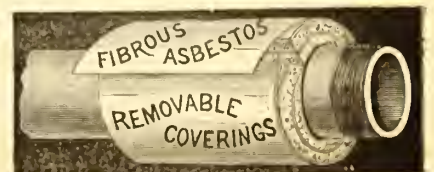

THE CLERK GAS ENGINE.

Highest Award American Institute, New York, 1883. Silver Medal American Institute, N. Y., 1884.
Gold Medal Awarded Crystal Palace Electrical Exhibition, London, 1882.
Highest Award for Motive Power British Section International Exhibition of Electricity, Paris, 1881.

Reliable.
No Boiler.
Steady.
No Coal.
Simple.
No Ashes.
Compact.

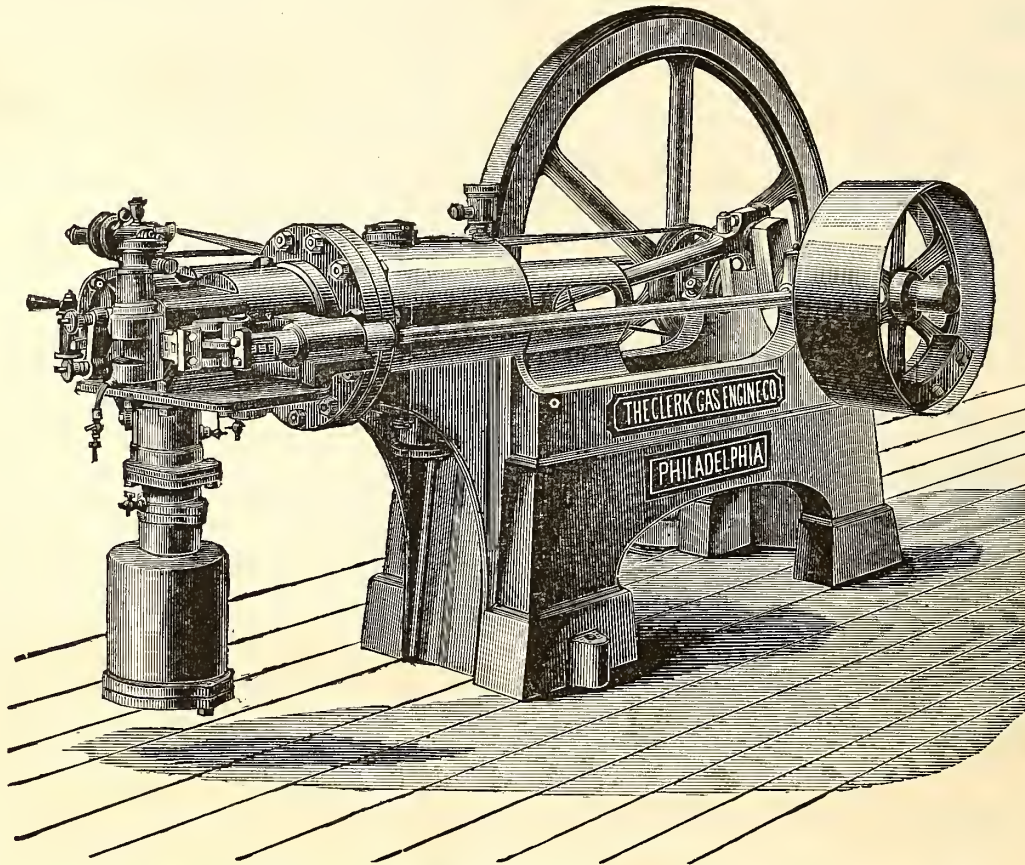

Economical.
No Engineer.
No Explosion
No Gearing
Wheels.
No Danger.
No Parts
requiring
frequent
renewal.

REQUIRING ONLY A MATCH TO START IT--GIVING ITS FULL POWER IMMEDIATELY.

We would inform the public that during the last few months we have improved THE CLERK GAS ENGINE to such an extent that we can now offer an engine vastly superior to our former pattern. These improvements have enabled us to sell our engine at a GREATLY REDUCED FIGURE, partly on account of the decreased weight (our engine weighing about half that of others giving the same Brake H. P). The consumption of gas has been decreased to a considerable extent, and the Brake H. P. has been increased some 25 to 30 per cent. All parts of the old design that were considered defective have been remodeled and new designs added. We now have an engine second to none as regards power, consumption, and ease of working. With our new engine all trouble in starting has been removed, the noise reduced to a minimum, and the regularity of motion is now all that can be desired. We guarantee all we claim for it, and the material and workmanship being of the best, enables us to guarantee the engine for twelve months.

SOLE MAKERS,

THE CLERK GAS ENGINE CO.,

WM. W. GOODWIN, President. E. STEIN, Secretary. S. LEWIS JONES, Asst. Secretary. L. P. GARRET, Supt.

Main Office, 1012-1018 Filbert Street, Philadelphia, Pa.

BRANCH OFFICES,

142 Chambers St., N. Y.

4 West Fourteenth St., N. Y.

76 Dearborn St., Chicago

General Agents,

THE GOODWIN GAS STOVE & METER CO.

Of Philadelphia, New York, and Chicago.

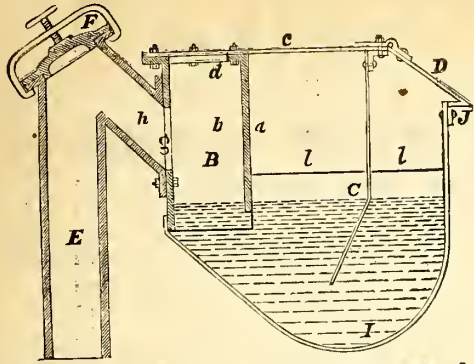

Boardman Hydraulic Main,

Patented October 7, 1884.

For description, see AM. GAS LIGHT JOURNAL of Feb. 2, 1884.
For terms, apply to

A. E. BOARDMAN, Macon, Ga.

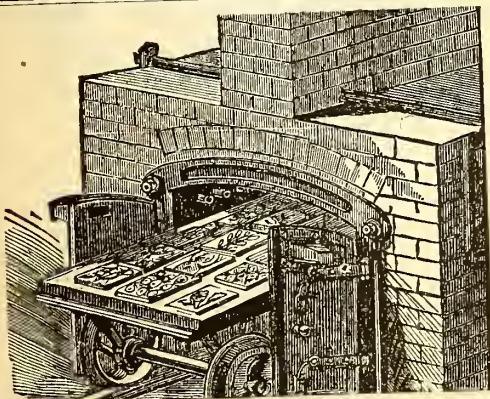

Glass-Staining Gas Kiln.

BAKERS' & CONFECTIONERS' OVENS (PAT.)

Thompson Gas Kiln & Oven Co.

59 Carmine St., N. Y.

Send for Circular by mail.

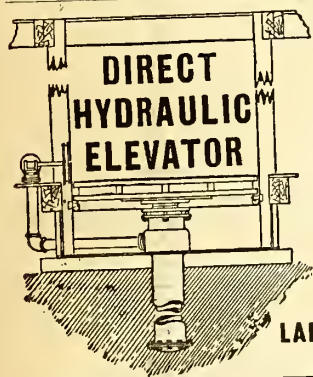

DIRECT HYDRAULIC ELEVATOR

With Iron or Wood Platform.

Largely used by Leading Gas Co.s for Coal and Coke Lifts.

Adapted for use with city service, or special pumping and accumulator system. For prices address the

LANE & BODLEY CO., Cincinnati, O.

THE GLOBE STREET LAMP.



MINER'S PATENT STREET LAMPS.

Are adapted for use of Streets, Parks, Depots, Ferries, & Private Grounds.

WITH POSTS OR BRACKETS.

Jacob G. Miner,

No. 823 Eagle Ave., New York N. Y.

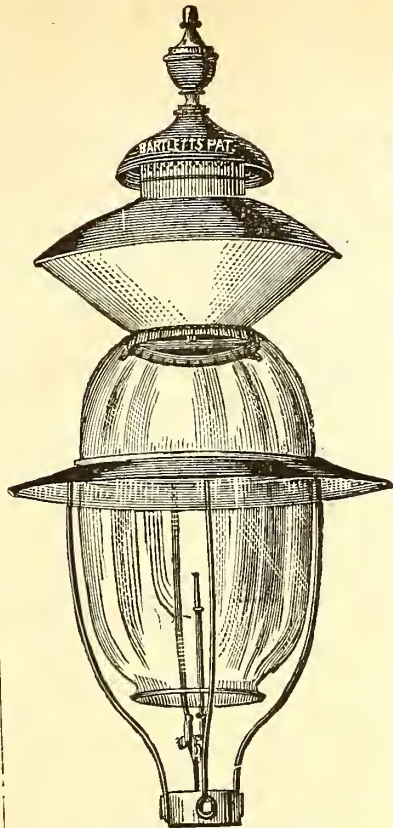

C. BARCALOW, PRES.

J. V. BARCALOW, SEC. & TREAS.

BARTLETT Street Lamp Mfg. Co.

MANUFACTURERS OF

Bartlett's Patent

GLOBE LAMPS.

FOR

Streets, Parks, Railroad Stations, Public Buildings, Etc.

LAMP POSTS A SPECIALTY.

Office and Salesroom,

No. 35 Howard Street, N. Y. City.

Gas Companies and others intending to erect lamps and posts will do well to communicate with us.

F. M. ROOTS.

S. C. ROOTS

D. T. ROOTS.

P. H. & F. M. ROOTS
PATENTEES AND MANUFACTURERS OF

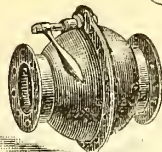

GAS VALVE.

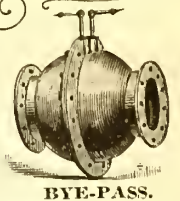
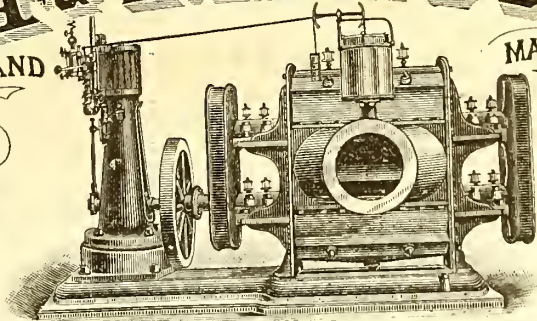

BY-PASS.

IMPROVED GAS EXHAUSTER,

WITH ENGINE ON SAME BED PLATE, OR WITHOUT.

BY-PASSES, GAS VALVES, GOVERNORS, ELBOWS, PIPE-FITTINGS, Etc., FURNISHED TO ORDER,

P. H. & F. M. ROOTS, Patentees & Manufacturers, **CONNERSVILLE, IND.**

S. S. TOWNSEND, General Agent, 22 Cortland St. and 9 Dey St., N. Y.

JAS. BEGGS & CO., Selling Agents, 9 Dey St., N. Y.

COOKE & CO., Selling Agents, 22 Cortland St., N. Y.

SEND FOR ILLUSTRATED CATALOGUE AND PRICE LIST.

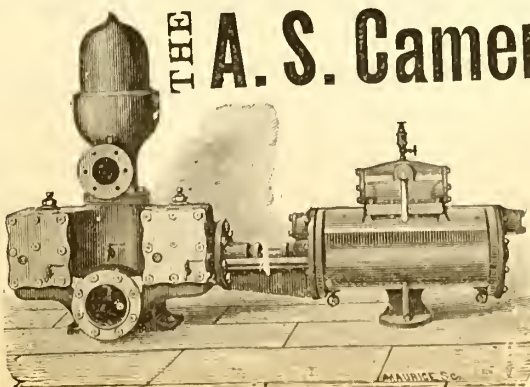

THE A. S. Cameron Steam Pump,

THE STANDARD OF EXCELLENCE.

Upward of 30,000 in Use.

BEST GAS WORKS PUMP

Ever Introduced.

Adapted to Every Possible Duty.

A.S. Cameron Steam Pump Works,

Foot East 23d St., N. Y.

J. H. CAUTIER & CO.,
CORNER OF
GREENE AND ESSEX STREETS,
JERSEY CITY, N. J.

MANUFACTURERS OF
**Clay Gas Retorts,
Gas House Tiles,
Fire Bricks, Etc. Etc.**
Ground Clay, Fire Brick and
Fire Sand in Barrels,

J. H. GAUTIER. T. B. GAUTIER.
C. E. GREGORY. C. E. GAUTIER.

BROOKLYN
Clay Retort & Fire Brick Works,
(EDWARD D. WHITE & CO.)
Manufacturers of Clay Retorts, Fire Brick,
Gas House and other Tile.
VAN DYKE, ELIZABETH, RICHARDS & PARTITION STS.
Office, 88 Van Dyke St., Brooklyn, N. Y.

LACLEDE FIRE BRICK MFG. CO.,

MANUFACTURERS OF
Fire Brick, Gas Retorts,

AND
ST. LOUIS STANDARD SEWER PIPE.
Blast Furnace and Cupola Linings, every description of Fire
Clay Material, Fire Clay Flue Linings, Chimney Tops
Dry Milled and Crude Fire Clays, etc.

OFFICE AND DEPOT
901, 903, and 905 Pine Street,
ST. LOUIS, MO.

ESTABLISHED IN 1845.

B. KREISCHER & SONS,

OFFICE FOOT OF HOUSTON ST., E. R., N. Y.

Gas Retorts,

TILES, FIRE BRICK.

AND EVERYTHING IN THE FIRE CLAY LINE.

MANHATTAN
FIRE BRICK & ENAMELLED CLAY
RETORT WORKS.
ADAM WEBER.

CLAY GAS RETORTS
AND RETORT SETTINGS
FIRE BRICKS, TILES, ETC.,
Office and Works, 15th Street and Avenue C., N. Y.

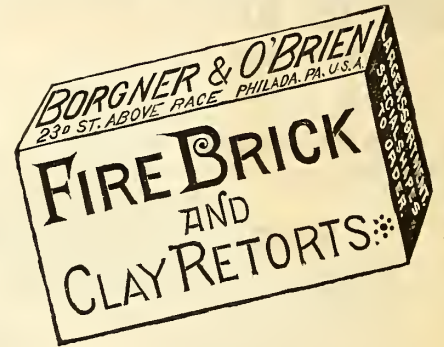

JAMES GARDNER, JR.
Works,
LOCKPORT STATION, PA.

—ESTABLISHED 1864.—
WILLIAM GARDNER & SON,
Successor to GARDNER BROTHERS.

WILLIAM GARDNER.
Office, COAL EXCHANGE,
PITTSBURGH, PA., P. O. Box 373.

Fire Clay Goods for Gas Works.

C. H. SPRAGUE, No. 70 KILBY STREET, BOSTON, MASS., Agent for the New England States.

OFFICE, 418 to 422 East 23d St., New York.

ESTABLISHED 1856.

WORKS, PERTH AMBOY, NEW JERSEY.

HENRY MAURER,
Excelsior Fire Brick & Clay Retort Works
CLAY GAS RETORTS, BENCH SETTINGS, FIRE BRICK, TILES, ETC.

STANDARD GAS RETORT AND FIRE BRICK COMPANY,
J. ANDERSON, PRES. & MANG'R. OF IRONTON, OHIO. C. PETERS, SECRETARY.
Clay Gas Retorts, Fire Brick, and Fire Clay Goods of Every Description.
Plans of Livesey-Somerville, McIlhenny, and other Furnaces, and Competent Workmen Supplied.

CHICAGO
Retort & Fire Brick Works,
OFFICE AND FACTORY,
Clark, Forty-Fifth, and La Salle Streets,
CHICAGO, ILL.
GEORGE C. HICKS, PRES. PAUL P. AUSTIN, SEC. & TREAS.
STANDARD
Clay Retorts and Settings.
BLOCKS & TILES
of every Shape and Size to Order.
Standard Fire Bricks.

NEWBIGGING'S
Gas Manager's Handbook.
Price, \$4.80.
EVERY GAS MAN SHOULD HAVE ONE.
Orders may be sent to this Office.

OAKHILL
GAS RETORT & FIRE BRICK
COMPANY.
PARKER, RUSSELL & CO.
City Office, 711 Pine Street,
ST. LOUIS, MO.

Our immense establishment is now employed almost entirely in
the manufacture of
MATERIALS FOR GAS COMPANIES.
We have studied and perfected three important points. Our re-
torts are made to stand changes of temperature, the strongest
heats of the furnace, and the abrasion of feeding and emptying.
Our customers are in almost every State of the Union, to all of
whom we refer.

THOS. SMITH, Prest. AUGUST LAMBLA, Vice-Prest. & Sup
BALTIMORE
RETORT & FIRE BRICK CO.
MANUFACTORY AT
LOCUST POINT, BALTIMORE, MD.
Connection with the City by Telephone.
Clay Retorts, Blocks & Tiles,
FIRE BRICK, FIRE CLAY,
AND FIRE CEMENT.

Ited and Buff Ornamental Tiles and Chim-
ney Tops. Drain and Sewer Pipe (from
2 to 30 inches). Baker Oven Tiles
12 x 12 x 2 and 10 x 10 x 2.
WALDO BROS., 88 WATER ST., BOSTON, MASS
Sole Agents for New England States

THE AMERICAN METER CO.,

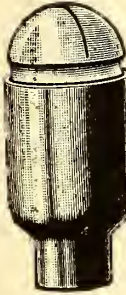

Large Flat Flame Burners.
15 cts. each, \$1.50 per doz.
A test with these burners, with 18-can. gas, gives the following results:

No.	Pressure.	Consump. per H'r	Candle Power
20	1.00 in.	7.75	33.00
30	1.00 in.	9.90	42.50
40	0.85 in.	10.20	44.54
60

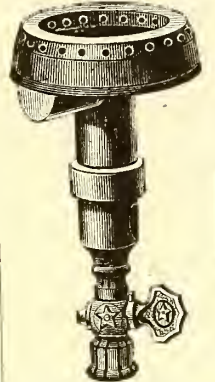

BURNER, by use of which Gasoline Stove is changed to Gas Stove.



Gasoline Stove.

MANUFACTORIES,

508 to 514 West Twenty-second St., N. Y.

Arch and Twenty-second St., Phila.

Nos. 244 & 246 North Wells Street, Chicago, Ill.

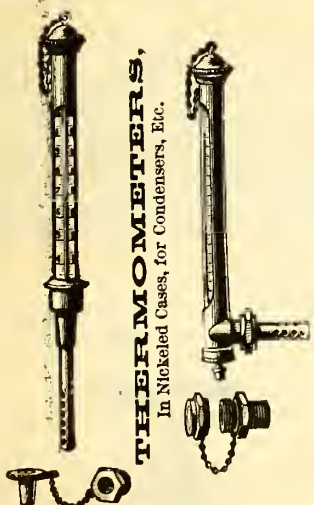

THERMOMETERS,
In Nicked Cases, for Condensers, Etc.

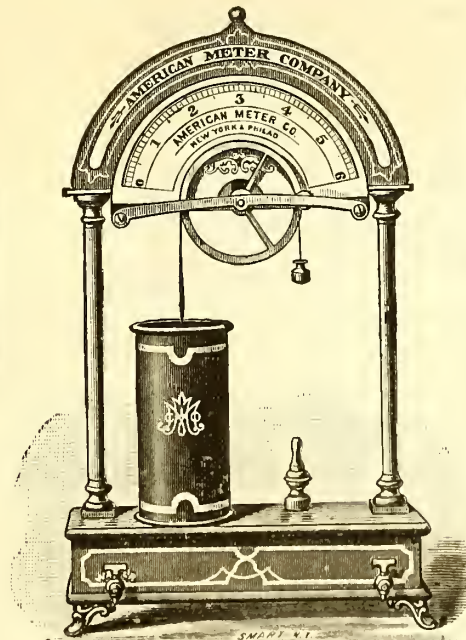

Arch Pressure Gauges.
Japanned and Nicked. Sizes: 3 in., 4 in., 6 in., 9 in.



SIPHON Pressure Gauges.

- 4 inch, Nicked.
- 6 inch, "
- 8 inch, "
- 10 inch, "
- 12 inch, "
- 14 inch, "
- 16 inch, "
- 18 inch, "
- 20 inch, "
- 24 inch, "

AGENCIES,

No. 177 Elm Street, Cincinnati, Ohio.

Nos. 122 & 124 Sutter Street, San Francisco Cal.

No. 810 North Second Street, St. Louis, Mo

A. H. M'NEAL,

BURLINGTON, N. J.

Flange-Pipes

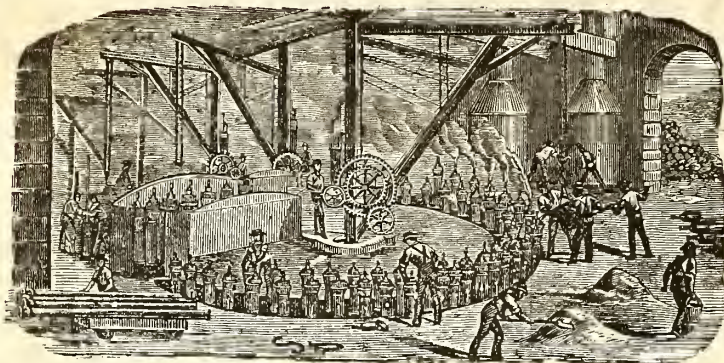

General Foundry Work.

CAST IRON PIPES

FOR WATER AND GAS.

JAMES S. MOORE, Pres.
BENJAMIN CHEW, Treas.

JAS. P. MICHELLON, Sec.
WM. SEXTON, Supt.

GLOUCESTER IRON WORKS, GLOUCESTER CITY, N. J.

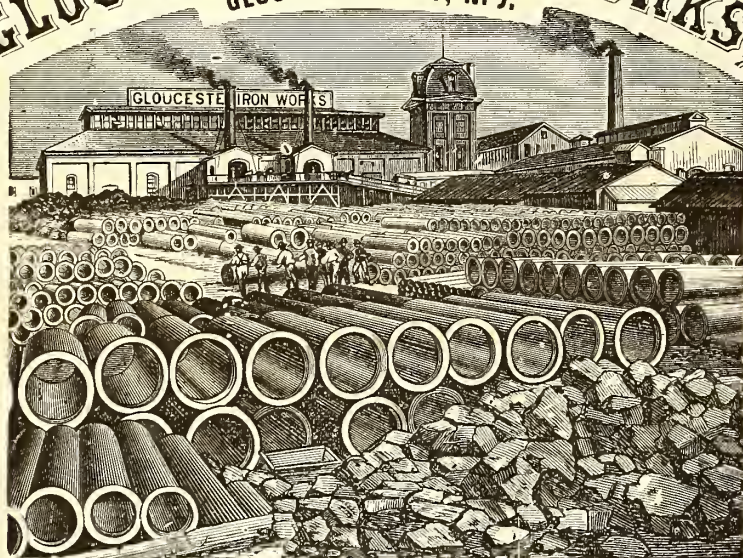

Cast Iron Gas & Water Pipes, Stop Valves, Fire Hydrants, Gasholders. &c.

Office No. 6 North Seventh Street, Philadelphia.

ESTABLISHED 1856.

WARREN FOUNDRY AND MACHINE CO.,

WORKS AT PHILLIPSBURGH, N. J.
NEW YORK OFFICE, 162 BROADWAY.

Cast Iron Water and Gas Pipe

FROM TWO TO FORTY-EIGHT INCHES DIAMETER.

ALSO ALL SIZES OF

FLANGE PIPE for Sugar House and Mine Work.

Branches, Bends, Retorts, Etc., Etc.

436-1

MATTHEW ADDY, President.

W. L. DAVIS, Selling Agent.

GEO. P. WILSHIRE, Sec. & Treas.

Cincinnati and Newport Iron and Pipe Company,

NEWPORT, KY.

Lamp Posts

AND

BENCH CASTINGS

A Specialty.

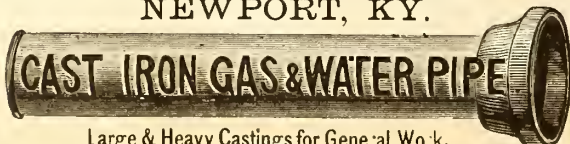

Large & Heavy Castings for General Work.

Manufacture Pipe from 2 to 48 inches. All work guaranteed first quality.

Branch

AND

SPECIAL CASTINGS

FOR GAS & WATER CO'S.

Mellert Foundry and Machine Co.

Limited. Established 1848.

MANUFACTURERS OF



Specials—Flange Pipe, Valves and Hydrants, Lamp Posts, Retorts, etc.

Machinery and castings for Furnaces, Rolling Mills, Grist and Saw Mills, Mining Pumps, Hoists, etc.

GENERAL OFFICE, - - - READING, PA.

CAST IRON

Gas and Water Pipes,

From 2 to 48 Inches in Diameter.

FOX & DRUMMOND,

160 Broadway, N. Y. City.

THE OHIO PIPE COMPANY,

MANUFACTURERS OF

Cast Iron Gas & Water Pipe,

BRANCH AND SPECIAL CASTINGS.

Gas-House Bench Castings, Hydraulics, Lamp Posts, Flange Pipe and Specials, Architectural Castings, Building Columns, Joists, C-llar Grates, Sash Weights, etc.

GENERAL FOUNDERS AND MACHINISTS.

Columbus, Ohio.

LUDLOW VALVE MFG. CO.

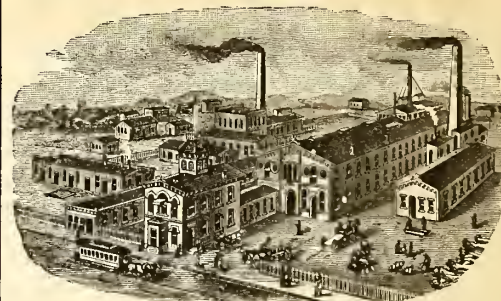

OFFICE AND WORKS,

93S to 954 River Street and 67 to 83 Vail Av.

TROY, N. Y.

Hydraulic Main Dip Regulators, also Check Valves, Foot Valves, Yard-wash and Fire Hydrants. Send for Circulars.

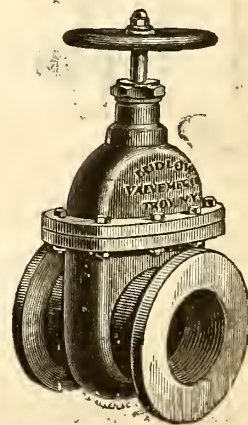

Valves.—Double and Single Gate, 1/2 in. to 48 in., outside and inside Screws. Indicator, etc., for Gas, Water, Steam, and Oil. and for Circulars.

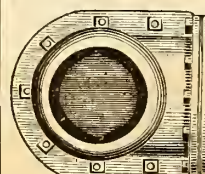

John McLean

Manufacturer of

GAS VALVES.

29S Monroc Street, N. Y.

Siemens's Regenerative Gas Burners, For Lighting and Ventilating.

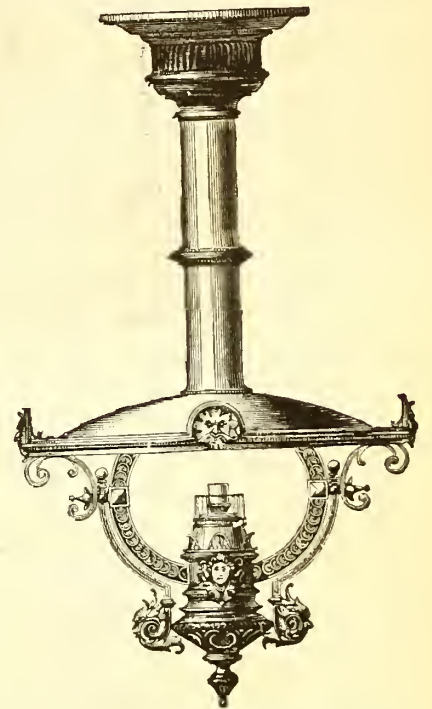
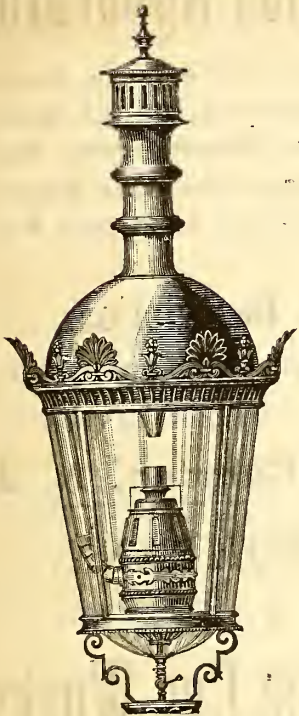

THE CHEAPEST, PUREST, AND MOST BRILLIANT OF ALL GAS LIGHTS.

Superior to the Electric Light in Economy, Beauty, & Steadiness.

SPECIALLY ADAPTED FOR LIGHTING HALLS, FACTORIES, OPEN SPACES, ETC.

Numerous Tests made by various Gas Companies in the United States show an Efficiency of Ten Candle Power per Cubic Foot of Gas.

General Agents:

- SIEMENS LIGHTING CO., 347 West Main St., Louisville, Ky.
- MEYER, MARSHALL & CO., 528 California St., San Francisco.
- DENNEHY, WOLF & O'BRIEN, 85 & 87 Dearborn St. Chicago, Ill.
- WILCOX & McGEARY, - No. 11 Bissel Block, Pittsburgh, Pa.
- T. T. RAMSDALL & CO., - 20 Swan Street, Buffalo, N. Y.
- SIEMENS GAS ILLUMINATING CO.,
Room 6, No. 157 Broadway, New York City.
- W. D. COLT, - - - - 1420 F Street, Washington, D. C.
- JOHN KIEFER, - - - 344 Lawrence, Street, Denver, Col.

THE SIEMENS REGENERATIVE GAS LAMP COMPANY,

SOLE MAKERS FOR THE UNITED STATES,

N. E. Cor. 21st. St. and Washington Av., Philadelphia, Pa.

THE "STANDARD" WASHER-SCRUBBER,

KIRKHAM, HULETT & CHANDLER'S PATENT.

Total Capacity per 24 Hours of "Standard" Washers Ordered During the Following Years.

Year	Capacity (Cubic Feet)
1877	4,000,000
1878	4,750,000
1879	24,545,000
1880	42,967,500
1881	36,462,500
1882	39,300,000
1883	57,735,000
1884	26,177,500
Total	235,937,500

Total Number and Capacity per 24 Hours of "Standard" Washers Erected and in Course of Erection in the Several Countries

Country	Number	Cubic Feet per Day
Great Britain	151	157,070,000
Western Hemisphere	38	39,337,500
Australia	18	12,150,000
New Zealand	2	650,000
France	6	4,550,000
Belgium	8	5,420,000
Germany	16	8,200,000
Holland	4	4,160,000
Denmark	1	150,000
Russia	2	3,500,000
Spain	1	350,000
India	1	400,000
Total	248	235,937,500

THE CONTINUED POPULARITY Of these Machines

Will be recognized from the following extracts from letters from representatives of some of the companies having them in use:

PROVIDENCE GAS COMPANY, }
PROVIDENCE, R. I., Nov. 24, 1884. }
GEO. SHEPARD PAGE, Esq., New York:

Dear Sir—We are now using less than a gallon of water per thousand in the "Standard," and the gas at the outlet will not color turmeric paper.
Yours etc.,

A. B. SLATER, Treasurer.

PORTLAND GAS COMPANY, }
PORTLAND, ORE., Nov. 29, 1884. }
GEO. SHEPARD PAGE, New York:

Dear Sir—Our Scrubber appears to run to our entire satisfaction, and we are pleased to say that it takes out all the ammonia from the gas. This is very satisfactory to us, as we were ruining our meters at a fearful rate heretofore. The amount of water used is very inconsiderable as compared with our old process. The machine runs very smooth and still.

Very respectfully,
H. C. LEONARD, Secretary.

"Standard" Washers Ordered Recently.

Company	Capacity (Cu. Ft. per Day)
Anneberg Gas Co.	200,000
Bombay Gas Co.	400,000
Brussels Co.	1,250,000
CHICAGO, two, 1,000,000 each	2,000,000
Cheunitz Gas Co.	1,000,000
CITIZENS GAS CO., BUFFALO	750,000
Coke Works in Zabre, Ober-Schlesien	1,500,000
Cokeret der Friedenshutte, Upper Silesia	100,000
Dunfries Corporation	250,000
Dunedin Gas Co., New Zealand	400,000
GEORGETOWN, D. C.	250,000
King's Lynn Gas Co.	200,000
Leiden, Holland	600,000
Lincoln Gas Co.	400,000
Liverpool Gas Co.	2,000,000
" "	3,000,000
LOUISVILLE GAS CO.	1,500,000
Numea Gas Co.	100,000
PITTSBURGH GAS CO.	1,500,000
PAWTUCKET, R. I.	500,000
PORTLAND GAS CO., Oregon	562,000
SAN FRANCISCO GAS CO.	4,000,000
Sheepbridge	40,000
ST. LOUIS GAS CO.	2,000,000
Sydney Gas Co.	2,500,000
WASHINGTON, D. C. GAS CO.	2,000,000
Whitechurch Gas Co.	175,000
Total	29,677,500

GEO. SHEPARD PAGE, No. 69 WALL STREET, NEW YORK,

SOLE AGENT FOR THE WESTERN HEMISPHERE.

R. D. WOOD & CO.,

400 Chestnut Street, Phila., Pa.

Cast Iron Gas & Water Pipe, Water Machinery & Gas Apparatus

Cast Iron Pipe, Fire Hydrants, Eddy Valves, Lamp Posts, Large Loam Castings, Flanged Pipe, Sugar House Work, Iron Roofs and Floors, Wrought & Cast Iron Tanks, Turbine Water Wheels and Pumps.

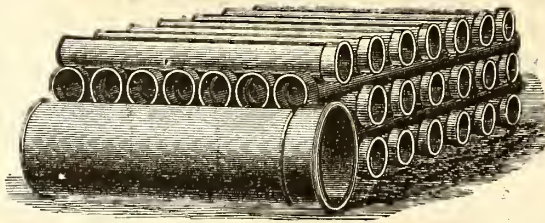

Gasholders, Lime Trays, Center Valves, Purifiers, Bench Work, Exhausters, Condensers, Governors, Scrubbers, Gas Valves, Station Meters, Cast Iron Pipe Fittings.

Manufacturers of Heavy Castings and Machinery of Every Description.

ENGINEERS & CONTRACTORS FOR THE ERECTION OF GAS WORKS, & ALL MACHINERY CONNECTED THEREWITH

Estimates and specifications furnished for erection of new works or the extension or alteration of old ones.

Foundries and Works. - - Millville, Florence, and Camden, N. J.

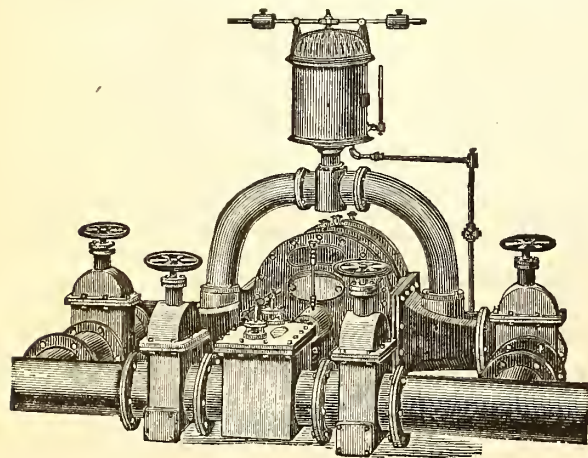

SMITH & SAYRE MFG. COMPANY,

G. G. PORTER, Prest.

245 Broadway, N. Y.

CHAS. W. ISBELL, Sec'y.

Machinery & Apparatus for Gas Works

Drawings, Plans, and Estimates Furnished for the Improvement, Extension, or Alteration of Gas Works, or for the Construction of New Works.

Mackenzie's Patent Rotary and Steam Jet Gas Exhausters, Governors, Compensators, Condensers, Washers, Scrubbers. Isbell's Patent Automatic Street Pressure Governor, Gas and Water Valves, Hydraulic Main Dip Regulator, Bench Castings, etc. Purifying Boxes and "Standard" Scrubbers. Isbell's Patent Self-Sealing Retort Doors.

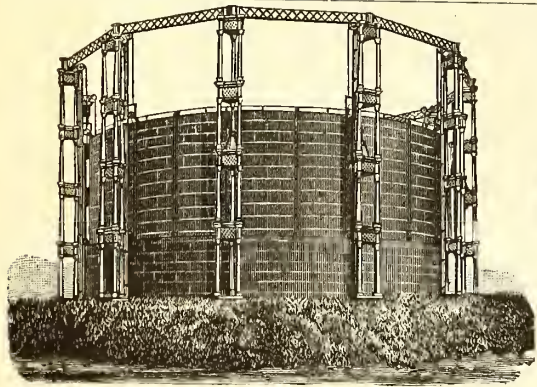

W. E. Tanner, Pres., W. R. Trigg, V.-Pres., A. Delaney, Supt.

Tanner & Delaney Engine Co.

RICHMOND, VA.

Gas Apparatus,

INCLUDING

Condensers of various styles, Scrubbers, Holders, Purifiers, Castings for Retort Houses, Etc.

ALSO STEAM ENGINES AND BOILERS.

Plans, Specifications and Estimates Furnished.

MORRIS, TASKER & CO.,

Limited,

Builders of Gas Works,

PHILADELPHIA, PA.

To Gas Companies.

We make to order CAP BURNERS to burn any amount under a stated pressure. Send for samples.

Also, SERVICE CLEANERS, DRIP PUMPS, and STREET MAIN PROVING APPARATUS.

C. A. GEFROER,

248 N. 8th Street, Phila., Pa.

SOUTHWARK FOUNDRY AND MACHINE COMPANY,

Successors to MERRICK & SONS. Established in 1836.

No. 430 Washington Avenue, Philadelphia, Pa.

MANUFACTURERS OF

Single and Telescopic Gasholders,

BENCH CASTINGS,

Washers, Scrubbers, Condensers, Purifiers,

And all apparatus necessary for the construction of improved new gas works and in the extension of established works. Also manufacturers of

Gas Engines, and of all descriptions of Steam and Hydraulic Machinery, and of Boiler and Tank Work.

Plans, specifications, and estimates furnished promptly on application.

WM. HENRY WHITE,

Consulting & Constructing

Gas Engineer & Contractor.

ESTIMATES, PLANS, AND SPECIFICATIONS FURNISHED FOR NEW WORKS OR EXTENSIONS OF

EXISTING WORKS.

32 Pine St., New York City.

Correspondence solicited.

KERR MURRAY MFG. CO.,

MANUFACTURERS OF

Single Lift and Telescopic GASHOLDERS.

Built, 1884:

Altoona, Pa.	Capacity, 160,000 cubic feet.
Pittsburgh, Pa.	" 250,000 "
" "	" 220,000 "
Bellaire, Ohio.	" 50,000 "
Youngstown, Ohio.	" 60,000 "
Canton, "	" 60,000 "
Akron, "	" 80,000 "
Xenia, "	" 10,000 "
Adrian, Mich.	" 65,000 "
Ypsilanti, Mich.	" 25,000 "
Muskegon, "	" 70,000 "
South Bend, Ind.	" 70,000 "
Anderson, "	" 20,000 "
Plainfield, "	" 10,000 "
Springfield, Illinois.	" 100,000 "
Evanston, "	" 50,000 "
Freeport, "	" 35,000 "
Elgin, "	" 60,000 "
Sheboygan Wis.	" 20,000 "
Key West Fla.	" 10,000 "

Plans and estimates furnished for the erection of new and the rebuilding of old works. Address

Kerr Murray Mfg. Co.,
FORT WAYNE, IND.

JAMES R. FLOYD,
(SUCCESSOR TO HERRING & FLOYD)

Oregon Iron Works,
531 to 543 West 20th St., N. Y.
Practical Builders of Gas Works,
MANUFACTURERS OF
ALL KINDS OF CASTINGS
AND
APPARATUS FOR GAS-WORKS.

BENCH CASTINGS
from benches of one to six Retorts each.
WASHERS: MULTITUBULAR AND AIR CONDENSERS; CONDENSERS; SCRUBBERS
wet and dry, and
EXHAUSTERS
for relieving Retorts from pressure.
BENDS and BRANCHES
of all sizes and description.
FLOYD'S PATENT MALLEABLE RETORT LID.
PATENT SELF-SEALING RETORT LIDS.
FARMER'S PATENT BYE-PASS DIP-PIPE.
SABBATON'S PATENT FURNACE DOOR AND FRAME.
BUTLER'S COKE SCREENING SHOVELS.

GAS GOVERNORS,
and everything connected with well regulated Gas Works at low price, and in complete order.
SELLER'S CEMENT
for stopping leaks in Retorts.
N. B.—STOP VALVES from three to thirty inches—
at very low prices.
Plans, Specifications, and Estimates furnished.

CONTINENTAL WORKS.

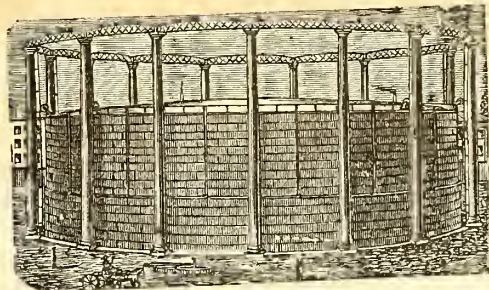

GASHOLDERS OF ANY MAGNITUDE.

T. F. ROWLAND, Proprietor,
GREENPOINT, BROOKLYN, N. Y.
ENGINEER AND MANUFACTURER OF
GAS-HOLDERS.
CONDENSERS, SCRUBBERS, VALVES,
PURIFIERS, RETORTS, and HY-
DRAULIC MAINS,

and all other articles connected with the Manufacture and Distribution of Gas. Plans and Specifications prepared and Proposals given for the necessary Plant for Lighting Cities, Towns, Mansions, and Manufactories.

H. RANSHAW, Prest. & Mangr. WM. STACEY, Vice-Pres. T. H. BIRCH, Asst. Mangr. R. J. TARVIN, Sec. & Treas.

STACEY MFG. CO.,

MANUFACTURERS OF

Single and Telescopic Gasholders,

IRON ROOFS, BRIDGES, LAMP POSTS,

Water and Oil Tanks, Coal Elevator Cars,
COKE CRUSHERS, BENCH CASTINGS,

And all kinds of Wrought and Cast Iron Work used in the erection of Coal and Oil Gas Works. Rolling Mill Machinery and Heavy Castings a Specialty.

Foundry: 33, 35, 37 & 39 Mill Street. **Wrought Iron Works:** 16, 18, 20, 22, 24 & 26 Ramsey Street.

Cincinnati, Ohio.

BARTLETT, HAYWARD & CO.,

Office, 24 Light. BALTIMORE, MD. Works, Pratt &

PURIFIERS.
Roofs.
Bench Castings.

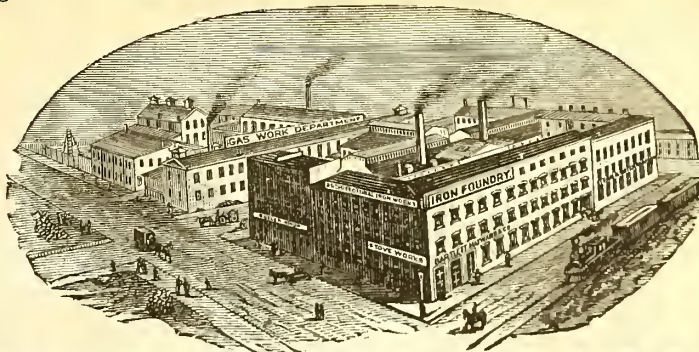

CONDENSERS.
BOLLERS.
SCRUBBERS.

GASHOLDERS.

CONSTRUCTING ENGINEERS AND BUILDERS OF GAS WORKS.

1842. **DEILY & FOWLER,** 1885.

Laurel Iron Works.

Address, No. 39 Laurel Street, Philadelphia, Pa.

MANUFACTURERS OF

GASHOLDERS,

Single or Telescopic, with Cast or Wrought Iron Guide Frames.

Holder Built Since 1880:

Mount Joy, Pa.	West Point, N. Y.	Galveston, Texas (2d.)	Kalamazoo, Mich. (3d.)	Newport, R. I.
Rockaway Beach, N. Y. (2)	Fitchburg, Mass.	Marlboro, Mass.	Glen Island, N. Y.	Portland, Oregon.
Zanesville, O. (2d.)	New London, Conn.	Denver, Col.	Warren, Ohio.	Allegheny, Pa. (2d.)
Lancaster, O.	Derby, Conn.	Chicago, Ill. (West Side).	Bath, N. Y.	Atlanta, Ga. (2d.)
Blackwell's Island N. Y.	Bridgeport, Conn.	Pittsburgh, Pa. (S. Side).	Lynn, Mass.	N. Y. City (Central Ga.)
Waltham, Mass., (1st.)	Allegheny, Pa. (1st.)	Plymouth, R. I.	New Bedford, Mass.	Lynchburg, Va. (2d.)
Dorchester, Mass.	St. Hyacinth, Can.	Pittsburgh, Pa. (S. Side).	Waterbury, Conn.	Saylesville, R. I.
Wheeling, West Va.	Norwalk, O.	Brookline, Mass.	Deseronto, Can.	Randout, N. Y.
Lansing, Mich.	Brattleboro, V.	Sherbrooke, Can.	Hooles Falls, N. Y. (2d.)	Atlantic City, N. J.
Flint, Mich.	Waltham, Mass. (2d.)	Burlington, N. J. (2d.)	Bethlehem, Pa.	Augusta, Ga.
Galveston, Texas (1st.)	West Chester, Pa.	Bay City, Mich.	Atlanta, Ga. (1st.)	Waltham, Mass. (2)
Milton, Pa.	Baltimore, Md.	Eric, Pa.	Savannah, Ga.	
Scranton, Pa.	Hollidaysburg, Pa.	Jackson, Mich.	Montgomery, Ala.	

GAS COALS.

GAS COALS.

GAS COALS.

JAMES D. PERKINS.

PERKINS & CO.,

F. SEAVERNS.

General Sales Agents for

The Youghioghenny River Coal Company's OCEAN MINE YOUGHIOGHENY GAS COAL.

The Coal from the Ocean Mine (recently operated by Messrs. W. L. Scott & Co., of Erie, Pa.,) is now used by all the leading Gas Companies in the United States from Maine to Texas, and is recognized as *the only reliable Youghioghenny Gas Coal.* (See Map on p. 87 of this Journal, Feb. 16, 1885.)

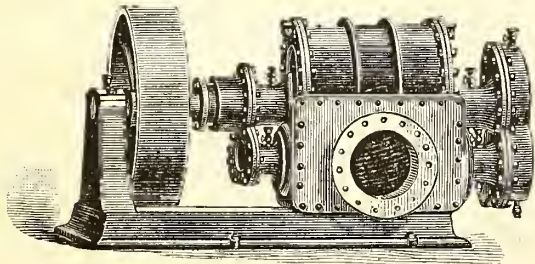
P. O. Box 3695,
New York.**PERKINS & CO., 228 and 229 N. Y. Produce Exchange****BEAVER STREET
ENTRANCE.**

Gas Exhauster Driven by Belt.

The Wilbraham Gas Exhauster, "BAKER SYSTEM,"

WITH ENGINE ATTACHED, ON SAME BED PLATE OR WITHOUT.
Best, Cheapest and Most Durable Exhauster known.

WILBRAHAM BROS.,

No. 2320 Frankford Avenue, Philadelphia, Pa.

Chas. F. Dieterich's Regenerator Furnace.

CAN BE ADAPTED TO ANY BENCH WITHOUT DISTURBING THE ORDINARY SETTINGS.

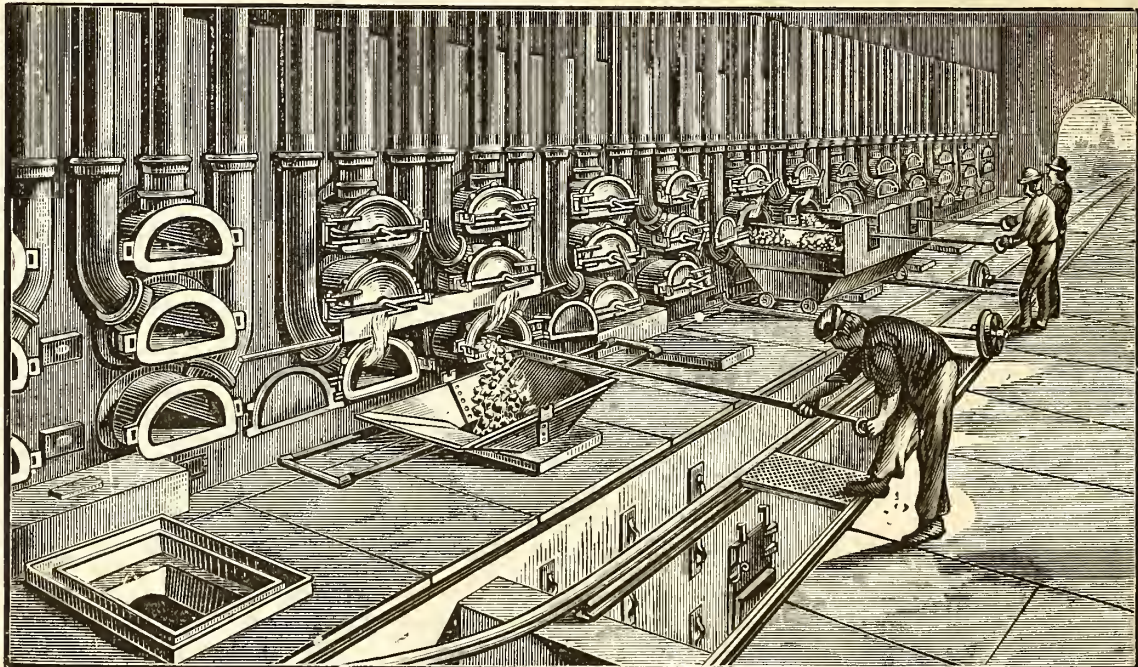

These Furnaces have been in operation at the works of the People's Gas Company, Baltimore, since June, 1878. A bench of sixes, with retorts 20 in. by 12 in. by 8 ft. 6 in. will burn off 1,350 pounds of coal in 3 hours. Twenty-five per cent. of the coke is sufficient to thoroughly burn off the charges.

We refer by permission to the following Companies who are using these Furnaces:

A. B. SLATER, Providence Gas Co. S. G. STINESS, Pawtucket Gas Co. JAS. H. ARMINGTON, Brooklyn Gas Lt. Co.

State, city, and factory rights granted on reasonable terms. For full particulars apply to

CHAS. F. DIETERICH, Engineer P. O. Box 512, BALTIMORE, MD.

GAS COALS.

GAS COALS.

GAS COALS.

Newburgh Orrel Coal Co.,

MINERS AND SHIPPERS OF

**Newburgh Orrel, Tyrconnell
and Palatine Gas Coals.**

ALSO SHIPPERS OF FOUNDRY COKE.

Mines Situated at

Newburgh, Flemington & Fairmont, W. Va.

HOME OFFICE,

25 S. Gay St., Baltimore.

CHARLES MACKALL,
MANAGER.

CHAS. W. HAYS, Agent in New York,

Room 92, WASHINGTON BUILDING, No. 1 Broadway.

Shipping wharves at Locust Point. References furnished when required. Special attention given to chartering vessels.

THE DESPARD COAL COMPANY

OFFER THEIR SUPERIOR

DESPARD COAL

To Gas Light Companies and Manufacturers of Fire Clay Goods
Throughout the Country.

ROUSSEL & HICKS, } AGENTS. { BANGS & HORTON,
71 Broadway, N. Y. } 16 Kilby St., Boston.

Mines in Harrison Co., West Va. Wharves, Locust Point, Balt.

Company's Office, 15 German St., Baltimore, Md.

Among the consumers of Despard Coal we name: Manhattan
Gas Light Co., N. Y.; Metropolitan Gas Light Co., N. Y.; Jersey
City, (N. J.) Gas Light Co.; Washington (D. C.) Gas Light Co.;
Portland (Maine) Gas Light Co. Reference to them is requested.

WELSH "ABERNANT"

Silica Dinas Fire Brick & Cement.

Unrivalled for Endurance Under Intense
Heat. Percentage of Silica, 95.64.

Also SCOTCH "BLOCHAIRN" FIRE BRICK.

A. T. CHUR,

SOLE AGENT FOR THE UNITED STATES,

Mills Building, Room 14, Fifth Story, New York.

PRESERVE

The Journal

BY THE USE OF

THE STRAP FILE.

Advantages of the Strap File.

- 1st. It is simple, strong, and easily used.
- 2d. Preserves papers without punching holes.
- 3d. Will always lie flat open.
- 4th. Allows any paper on file to be taken off without disturbing the others.

Price, \$1.25. Sent either by express or mail, at directed. By mail the postage will be 20 cents, which will be added to the price of the Binder.

A. M. CALLENDER & CO., 42 PINE ST., N. Y.

**THE
PENN GAS COAL CO.**

OFFER THEIR

Coal, Carefully Screened & Prepared for Gas Purposes.

Their Property is located in the Youghiogheny Coal Basin, near Irwin and Penn Stations on the Pennsylvania Railroad, and on the Youghiogheny River.

Principal Office:

209 SOUTH THIRD STREET, PHILA., PA.

Points of Shipment:

Pennsylvania Railroad Piers; Greenwich Wharves, Delaware River; Pier No. 1 (Lower Side), South Amboy, N. J.

Chesapeake & Ohio Railway Coal Agency,

FOR THE SALE OF THE

**Superior Kanawha Gas Coals, Cannelton Cannel,
Also, SPLINT AND STEAM COALS.**

From the Kanawha and New River Regions, on the line of the Chesapeake & Ohio R'way.

C. B. ORCUTT, Sales Agent. | OFFICE, 150 BROADWAY, N. Y.

FRANCIS H. JACKSON, PRESIDENT.

EDMUND H. MCCULLOUGH, SEC. & TREAS.

THE WESTMORELAND COAL CO.

Chartered 1854.

Mines situated on the Pennsylvania and the Baltimore
and Ohio Railroads, in Westmoreland County, Penn.

POINTS OF SHIPMENT:

PHILADELPHIA, BALTIMORE, SOUTH AMBOY, N. J.
WATKINS (SENECA LAKE), N. Y.

Since the commencement of operations by this Company its well-known Coal has been largely used by the Gas Companies of New England and the Middle States, and its character is established as having no superior in gas-giving qualities, and in freedom from sulphur and other impurities.

Principal Office, 224 South 3d St., Phila., Pa.

The Management of Small Gas Works.

By C. J. R. HUMPHREYS. Price, \$1.

A. M. CALLENDER & CO., 42 Pine St., N. Y.

CATHELL'S

Gas Consumer's Manual.

Enables every gas consumer to ascertain at a glance, without any previous knowledge of the gas meter, the quantity and money value of the gas consumed. Also the best method of obtaining from gas the largest amount of its light. It will be to the advantage of Gas Companies to supply their consumers with one of these Guides, as a means of preventing complaint arising from their want of knowledge in regard to the registration of meters.

A. M. CALLENDER & CO., 42 Pine St., N. Y.

King's Treatise on Coal Gas.

The most complete work on Coal Gas ever published.

Three Vols. Bound, \$30.

A. M. CALLENDER & CO., 42 Pine St., N. Y.

**AMERICAN
GAS LIGHT JOURNAL.**

\$3.00 per Annum.

A. M. CALLENDER & CO

42 Pine Street, N. Y. City.



INTERNATIONAL--1876--EXHIBITION.

The U. S. Centennial Commission

HAVE DECREED AN AWARD TO

HARRIS, GRIFFIN & CO.,



Twelfth and Brown Streets, Philadelphia, Pa., No. 49 Dey Street, N. Y. City, and No. 75 North Clinton Street, Chicago, Ill.,

FOR THE FOLLOWING REASONS:

The Exhibit consists of a Series of METERS from the Largest Size Station Meters for the use of the MANUFACTURE OF GAS, to those for the use of the ORDINARY CONSUMER. The Instruments are WELL MADE, RELIABLE as to INDICATION, and embody a number of sundry improvements which, with the general character of the Exhibit, entitle the whole to commendation.

Attest—J. L. CAMPBELL,
Secretary, pro-tem.

Signed—A. T. GOSHORN,
Director General

J. R. HAWLEY,
President

CHARLES E. DICKEY.

JAMES B. SMALLWOOD.

CHARLES H. DICKEY.

Maryland Meter and Manufacturing Co.,
DICKEY, TANSLEY & CO.,

Established 1866.

Nos. 22 and 24 Saratoga Street, Baltimore, Md.
No. 46 La Salle St., Chicago, Ill.

MANUFACTURERS OF

DRY GAS METERS, STATION METERS, GLAZED METERS, TEST METERS, METER PROVERS, PRESSURE AND VACUUM REGISTERS, GOVERNORS, INDICATORS, SERVICE AND METER COCKS, AND METER CONNECTIONS.

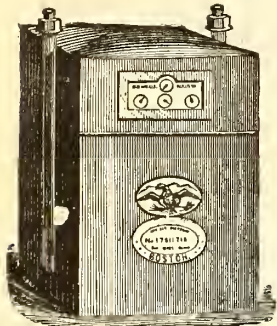

Dry Gas Meter.

With 39 years' experience and the best facilities for manufacturing, is enabled to furnish reliable work and answer orders promptly.

NATHANIEL TUFTS,

No. 153 Franklin Street, Boston, Mass.,

MANUFACTURER OF

DRY GAS METERS.

Station Meters of any Capacity.

Test and Experimental Meters, Pressure Registers, Pressure Gauges, Pressure and Vacuum Gauges.

METER PROVERS, PHOTOMETERS, STREET LANTERNS, ETC., ETC.

Patent Cluster Lanterns for Street Illumination.

SCIENTIFIC BOOKS.

We are prepared to furnish to Gas Managers, and others interested in the topics treated of, the following books, at prices named:

KING'S TREATISE ON THE MANUFACTURE OF COAL GAS. Three vols.; \$10 per vol.	GAS CONSUMER'S MANUAL, by E. S. CATHELS, C.E. 10 cts.	A PRACTICAL TREATISE ON GAS AND VENTILATION with Special Relation to Illuminating, Heating, and Cooking by Gas, by E. E. PERKINS. \$1.25.
GAS MANUFACTURE, by WILLIAM RICHARDS. 4to., with numerous Engravings and Plates, in Cloth binding. \$12.	PRACTICAL TREATISE ON HEAT, by THOMAS BOX. Second edition. \$5.	PURIFICATION OF COAL GAS, by R. P. SPICE. 8vo. \$3.
THE GAS ANALYST'S MANUAL, by F. W. HARTLEY. \$2.50.	GAS WORKS—THEIR ARRANGEMENT, CONSTRUCTION, PLANT, AND MACHINERY. \$8.	HOW TO MANAGE GAS, by F. WILKINS. Paper. 20 cents.
ANALYSIS, TECHNICAL VALUATION, PURIFICATION, and USE OF COAL GAS, by REV. W. R. BOWDITCH, M.A.; with Engravings; 8vo., Cloth. \$4 50.	COAL; ITS HISTORY AND USE, by PROF. THORPE. \$3.50.	THE GAS MANAGER IN THE LABORATORY, by a Practical Student. 8vo., Cloth. \$1.50.
GAS MEASUREMENT AND GAS METER TESTING by F. W. HARTLEY. \$1.60	THE GAS WORKS OF LONDON, by COLBURN. 60 cents.	THE DOMESTIC USES OF COAL GAS, AS APPLIED TO LIGHTING, by W. SUGG. \$1.40.
GAS CONSUMER'S HANDBOOK, by WILLIAM RICHARDS, C.E.; 18mo., Sewed. 20 cents.	THE GAS FITTER'S GUIDE, Showing the Principles and Practice of Lighting with Coal Gas, by JOHN ELDRIDGE. 40 cents.	DISTILLATION OF COAL TAR AND AMMONIACAL LIQUOR, by GEO. LUNGE. \$8.50.
	GAS WORKS, AND MANUFACTURING COAL GAS, HUGHES. \$2.20.	A TREATISE ON THE COMPARATIVE COMMERCIAL VALUES OF GAS COALS AND CANNELS, by D. A. GRAHAM 8vo., Cloth. \$3.
	THE MANAGEMENT OF SMALL GAS WORKS, by C. J. R. HUMPHREYS. \$1.	

The above will be forwarded by express, upon receipt of price. We take especial pains in securing and forwarding any other Works that may be desired, upon receipt of order. All remittances should be made by check, draft, or post office money order.

A. M. CALLENDER & CO., No. 42 Pine Street, New York.

T. C. HOPPER, Pres. G. J. McGOURKEY, Vice-Pres. (New York). WM. N. MILSTED, Gen. Supt. & Treas. (New York). WM. H. DOWN Sec.

AMERICAN METER COMPANY,

WET AND DRY GAS METERS.
STATION METERS.
EXHAUSTER GOVERNORS.
DRY CENTRE VALVES.
GOVERNORS FOR GAS WORKS.

PRESSURE REGISTERS.
PRESSURE & VACUUM REGISTERS.
PRESSURE & VACUUM GAUGES.
CRESSON GAS REGULATORS.
MARSLAND WATER METERS.

METER PROVERS.
PORTABLE TEST METERS.
EXPERIMENTAL METERS.
AMMONIA TEST METERS.
BAR AND JET PHOTOMETERS.

Manufactories:
512 W. 22d St., N. Y.
Arch & 22d Sts., Phila.

GAS STOVES,
SUGG'S "STANDARD" ARGAND BURNERS,
SUGG'S ILLUMINATING POWER METER,
Wet Meters, with Lizar's "Invariable Measuring" Drum.

Agencies:
177 Elm Street, Cincinnati.
244 & 246 N. Wells Street, Chicago.
810 North Second Street, St. Louis.
122 & 124 Sutter St., San Francisco.

HELME & McILHENNY,

(Successors to Harris & Brother. Established 1848)

GAS METER MANUFACTURERS,

CONTINUE AS HERETOFORE AT THE OLD ESTABLISHMENT,

Nos. 1115 and 1117 Cherry Street, Philadelphia, Pa.,

To Manufacture Wet and Dry Gas Meters, Station Meters, Experimental Meters, Meter Provers, Center Seals, Pressure Registers,

GOVERNORS, INDICATORS, PHOTOMETERS, & ALL OTHER KINDS OF APPARATUS FOR USE IN GAS WORKS.

From our long practical experience of the business, and from our personal supervision of all work, we can guarantee all orders to be executed promptly, and in every respect satisfactorily.

WM. WALLACE GOODWIN, Prest. and Treas.

WM. H. MERRICK, V.-Prest.

S. L. JONES, Sec.

S. V. MERRICK, Supt.

THE GOODWIN GAS STOVE AND METER COMPANY,

Successors to W. W. GOODWIN & CO.

1012, 1014 and 1016 Filbert St., Phila., Pa. 142 Chambers St., New York.
76 Dearborn St., Chicago, Ill.

WALDO BROS., Agents, 88 Water St., Boston.

MANUFACTURERS OF THE "SUN DIAL" GAS STOVES, FOR COOKING AND HEATING PURPOSES.

Dry and Wet GAS METERS, Station Meters (Square, Cylindrical or in Staves) Glazed Meters, King's and Sugg's Experimental Meters, Lamp Post Meters, Etc., Etc., Meter Provers (sizes 2, 5 and 10 feet), Pressure Guages of all kinds, Pressure Registers, Pressure and Vacuum Registers, Pressure Indicators (sizes 4 inch, 6 inch and 9 inch), King's Pressure and Vacuum Gauges, Dry and Wet Centre Seals, Dry and Wet Governors, Exhauster Governors, Photometers of all descriptions. Lethby's Sulphur and Ammonia Test Apparatus complete—also Testing and Chemical Apparatus of all kinds, and of the most perfect description, for all purposes relating to Gas.

GOODWIN'S IMPROVED LOWE'S JET PHOTOMETER.

Agents for Bray's Patent Gas Burners and Lanterns.

Special attention to repairs of Meters, and all apparatus connected with the business.
All work guaranteed first class in every particular, and orders filled promptly.

G. B. EDWARDS, Mang'r, New York.
E. H. B. TWINING, Mang'r, Chicago.
A. B. STANNARD, Agent.

D. McDONALD & CO., GAS METER MANUFACTURERS.

(Established 1854.)

51 Lancaster St., Albany, N. Y. 34 & 36 West Monroe St., Chicago, Ill.

STATION METERS, EXPERIMENTAL METERS, METER PROVERS, PRESSURE & VACUUM REGISTERS, PRESSURE GAUGES, ETC.

Also STAR GAS STOVES, RANGES, and HEATING STOVES.

We use only the very best materials, and employ the most skilled labor, and by our long experience (29 years) and personal supervision of every detail, we feel justified in assuring the public that our goods will give perfect satisfaction. Every Meter emanating from our establishment will bear the State Inspector's BADGE, and will be fully warranted by us. Our Annual and Calendar will be sent to Gas Companies upon application.

KING'S TREATISE ON COAL GAS.

The most complete work on Coal Gas ever published. Three vols., bound, \$30.

A. M. CALLENDER & CO., No. 42 Pine Street, New York.

THE "OTTO" GAS ENGINE.

Guaranteed to Consume 25 to 75
Per Cent. LESS GAS than ANY OTHER GAS ENGINE
PER BRAKE HORSE POWER.

TWIN ENGINES Impulse every revolution.
THE STEADIEST RUNNING GAS ENGINE YET MADE.

ENCINES AND PUMPS COMBINED,

For Hydraulic Elevators, Town Water Supply, or Railway Service.

Special Engines for Electric Light Work.

OVER 15,000
IN USE.

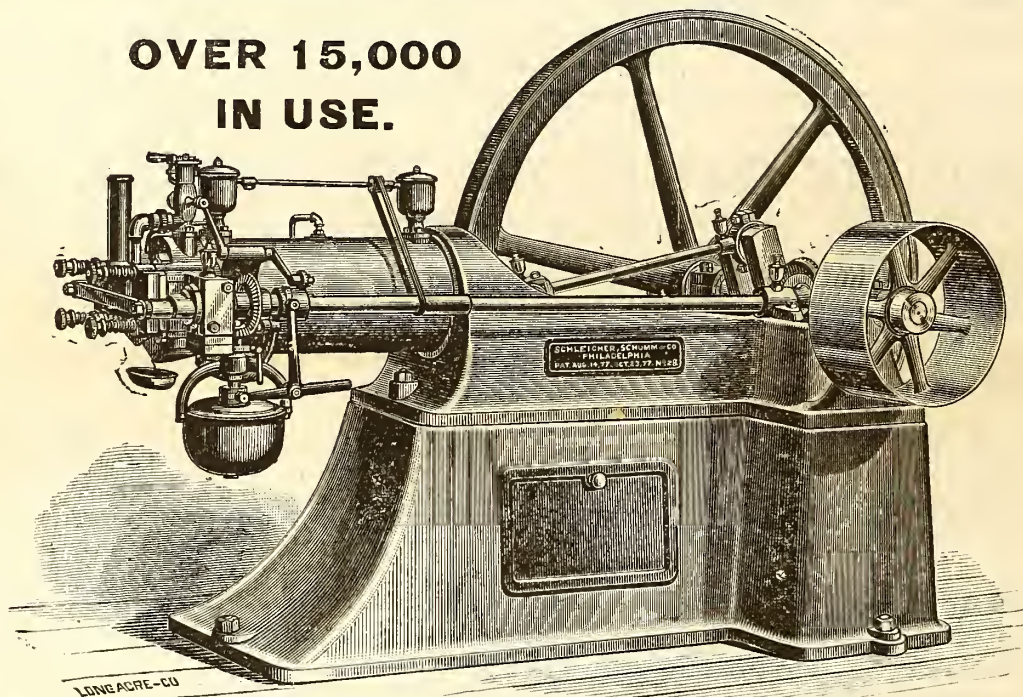

The Otto Gas Engine is now consuming, at a moderate computation, 2000 millions cubic feet of gas per year, nearly all of which is furnished during day time only.

**THE ONLY HIGHEST AWARD, ONLY GOLD MEDAL,
AT ELECTRICAL EXHIBITION, PARIS, 1881.**

MADE IN SIZES FROM 1 TO 25 HP. INDICATED.

FOR PARTICULARS, PRICES, ETC., APPLY TO

SCHLEICHER, SCHUMM & CO.,

Works:

N. E. Cor. 33d & Walnut Sts., Phila., Pa.

Branch Office:

214 Randolph Street, Chicago, Ill.

THE AMERICAN

GAS LIGHT JOURNAL

REDMAN & KENNEDY, N. Y.

PUBLISHING OFFICE No. 42 PINE STREET

DEVOTED TO THE INTERESTS OF ILLUMINATION, VENTILATION, WATER SUPPLY AND DISTRIBUTION, & GENERAL SCIENCE.

VOLUME XLIII.—No. 7.
Whole No. 631.

NEW YORK, FRIDAY, OCTOBER 2, 1885.

{ \$3 PER ANNUM
IN ADVANCE.

A. M. CALLENDER & CO., Proprietors. C. E. SANDERSON, Manager.
JOS. R. THOMAS, C. E., Editor.

ENTERED AT THE POST OFFICE AT NEW YORK, N. Y.
AS SECOND CLASS MATTER.

Published on the 2d and 16th of each month, at No. 42 Pine Street, N. Y.

Terms of Subscription, Including Postage.—For the United States and Canada, \$3 per annum. European countries, \$3.50 (15 shillings—18 francs). All payments to be made in advance. Single copies, 15 cents.

Remittances should be made either by post-office order, registered letter, or bank draft on New York, payable to the order of A. M. Callender & Co.

Collections are invariably made directly from this office, for subscriptions, advertisements, etc. We have agents to solicit the same, but they are not authorized to receipt for money.

Correspondence.—Wishing to make this JOURNAL a gazette of intelligent discussion to those of our readers who may wish to gain or give information on the subjects to which its columns are devoted, correspondence is solicited for publication from all who make the study of those subjects a pleasure or a profession.

The American News Company, Nos. 39 and 41 Chambers street, New York, are agents for this JOURNAL. Newsdealers will send orders to them.

Books.—We will forward by express, at publisher's lowest rates, any book—scientific or otherwise—to any address in the United States or Canada. No books will be sent C. O. D.

CONTENTS.

An Asterisk (*) denotes an illustrated article.

OFFICIAL CIRCULAR—

American Gas Light Association..... 169

EDITORIALS—

“Dr. Robinson, of Columbus, Ohio”..... 170

Annual Meeting of the Iowa Gas Association..... 170

The Cincinnati Meeting..... 170

The Market for Gas Securities 170

*Atkinson's Differential Gas Engine..... 171

*Some Notes on the “Novelties” Exhibition Now Being Held at Philadelphia, Under the Auspices of the Franklin Institute of Pennsylvania, by H. C. Adams..... 172

The Albo-Carbon Light—The Siemens Lamps—The New Lungren Lamp—The Wasserman Lamp.

Mr. Emerson McMillin in Reply to the Charges Made Against the Columbus (Ohio) Gas Company..... 174

Special English Correspondence..... 177

Comparative Evaporation Tests..... 178

ITEMS OF INTEREST FROM VARIOUS LOCALITIES..... 178

Reduction in Selling Rates at Worcester, Mass.—“Carbolineum Avenarius”—The Holder is Completed—And Still Another “Construction Company”—“Notes” from Dallas, Texas—The English Market for Sulphate of Ammonia—A New Gas Company—A Possibility of a Lawsuit—The “Bosses” were Conquered—Gas Matters at Albany, N. Y.—Cheaper Gas for Nebraska City, Neb.—Personal—“Notes” from Chicago, Ill.—They Would not Consider the Petition—Deaths from Gas Inhalation—Passed over the Mayor's Veto—To Take Charge at Minneapolis, Minn.—More Comparative Evidence—The Utica (N. Y.) Street Lighting Contract—A Five-Man Power Gas Engine.

[OFFICIAL CIRCULAR.]

American Gas Light Association.

AMERICAN GAS LIGHT ASSOCIATION, {
Sept. 30th, 1885. }

The Thirteenth Annual Meeting of the American Gas Light Association will be held at Cincinnati, Ohio, Wednesday, Thursday, and Friday, October 21st, 22d, and 23d. The headquarters of the Association will be at the Gibson House, and the meetings will be held at College Hall.

The members will find the hotel and hall arrangements very desirable; the hall is close by the hotel, and is a most excellent room for public meetings. The hotel has recently been remodeled, and will be found very convenient.

I am happy to be able to state that present indications would portend that our Thirteenth Annual Convention will be an enjoyable one. Certainly, those who attended our Fifth Annual Meeting, at Cincinnati in 1877, will be very ready to grant that the selection of that city for our coming convention was a happy augury of its success.

Though the literary portion of our programme is not yet completed, nevertheless the number of papers promised, and the partial pledges we have of others, afford good ground for hoping that the time which will be allotted to the consideration of matters of technical interest will be well utilized. We are promised papers on the following subjects:

“Natural Gas,” by W. H. Denniston.

“Stoking Machines,” by M. S. Greenough.

“Improved Furnaces,” by Austin C. Wood.

“The Result of a Month's Working with Limed Coal,” by James Somerville.

“The Thermophote, or Self-registering Photometer,” by T. O'Connor Sloane.

“The Present State of the Gas Business,” by J. C. Pratt.

“Difficulties Encountered in the Construction of a Gasholder Tank,” by Emerson McMillin.

“Automatic Street Main Governors,” by William Enfield.

In addition to the above we have four other papers partially promised, and I hope at an early day to add their titles to the above list.

If the members would keep these subjects before them, and collect from time to time such facts and figures in relation thereto as may be in their possession, and be prepared to lay them before the convention during the discussions of these themes, it would add greatly to the interest and value of our proceedings.

Besides the matters which will be brought before the Association by the gentlemen who will read the papers, there are many interesting subjects which could be discussed. At recent meetings of other Associations the question box has been rendered a very important feature of the convention. Yet it is doubtful if this branch of the meeting has been as edifying as it might have been; for many questions are asked which can only be properly answered by the production of some facts or figures, and as the party making the answer has no previous notice of the question it follows that the answer must be made from memory, instead of from the record; and, therefore, the conundrum is but partially answered. Now this could be rectified if we could know in advance the questions to be propounded. If, for instance, a member who wishes a subject discussed, or seeks light on some disputed point, would send in his question at once to the Secretary, he could incorporate it

in his next circular, then as the members would have an opportunity to look up definite data on the subject the chances are the party putting the question, as well as the other listeners, would be edified. I would urge this matter on the earnest consideration of the members, and I sincerely hope there will be no hesitancy on the part of all in sending in their questions at as early a day as possible to the Secretary. There need be no holding back in this matter, as the names of the propounders of the queries will not appear in any way. It will suffice if a member writes out his question and forwards it to me, I will then send to each member a list of the questions to be discussed.

Light is wanted on the following questions:

"Is cannel or naphtha the cheaper enricher, taking \$9 a ton as the cost of the former and 5 cents a gallon the price of the latter?"

"Can large gas burners successfully compete with the arc light?"

"How can the trouble from naphthaline be alleviated?"

"What is the proper position for gas exhausters?"

"Can the gas engine be successfully used to drive an exhauster?"

"What is the best means for removing tar from the gas?"

"Does a heavy setting of retorts require more coke to maintain the heat than a light setting?"

It is hoped each member will make a decided effort to be present at the meeting, that we may have a large and pleasant gathering.

Parties wishing to join the Association can obtain blanks by applying to the Secretary,

C. J. R. HUMPHREYS,
Box 6, Lawrence, Mass.

"DR. ROBINSON, OF COLUMBUS, OHIO."

In the news columns of current issue of the JOURNAL we publish an interesting letter, from the pen of Mr. Emerson McMillin, of the Columbus Gas Light Company, formulated in reply to certain ridiculous and extravagant charges made by the members of the local Council Board in regard to the manner in which the gas consumers in that city were being "swindled by the managers of the gas company." Of course, the Council must of necessity be represented by a proper spokesman, and the choice of same appears to have resulted in the selection of one "Dr. Robinson," who, to put it mildly, has been "speaking with a vengeance." But, as is the case with the majority of "mouthing reformers," the "Dr." warming up with his subject, as he proceeded to unfold the matter "in all its harrowing details," so far overstepped the bounds of caution and carefulness that, ere he rightly knew it, he found himself floundering in the mire of a ditch, the excavation and "miring" of which had been but the natural result of his own zealous though misguided labor.

The "Dr." may possibly be a very worthy member of that profession which essays to combat and overthrow the various bodily ills encountered by mankind; and if he be a disciple of Æsculapius we make no doubt that he worthily and creditably carries the "knotty staff round which was entwined a serpent, the symbol of convalescence." Still, while we have no positive evidence that "Robinson, of Columbus," is the possessor of a graduate's diploma, and the proud owner of a "large and growing practice," it is only fair to presume that he may have either or both, since the "Dr." prefix, as well as the "M. D." suffix, rightfully belong (the latter always, and the former usually) only to those who are duly licensed to "prescribe." However, be he "medicine man" or not, the fact remains unaltered that "every cobbler should stick to his last," and in Dr. Robinson's case we would fain remark that the Dr.'s "last" would undoubtedly be but a poor instrument towards a proper "shaping" of the gas supply of his local city—and this also implies that if the "last" could not be adjusted to the Columbus conditions, it would be equally ineffective elsewhere.

About the most remarkable of the absurdities put forth by the "Dr." is his grave assertion that "six-tenths pressure, in all cases, is abundant day or night." Perhaps he meant what he said, and it is only fair to assume that he did; but just there is where he dug down to the maximum depth of his ditch, and added the miry bottom thereto. Supt. McMillin was not slow in seizing the opportunity thus presented, and in his answer to the "Dr.'s arguments" made the following promise in the annexed words, "We will test this on Monday, Sept. 7th, and in doing so will give his claim the best possible show, because Monday is the day of least consumption of the business days in the week. We will, during that day, carry 50 per cent., and at night 100 per cent. more pressure than Dr. Robinson says the consumers ought to have. The pressure will be seven and one-half-tenths in the daytime, and eleven-tenths at night, and will be thus continued as long as consumers will permit." This manifesto from the "sovereign of the gas company" at once placed the redoubtable "Dr." on the anxious seat; indeed it "moved" him to such an extent that he at once visited all the local newspaper sanctums and inveigled the editorial dwellers therein to announce through their columns that "the efforts on date of seventh were to be made

for the sole purpose of bringing him into disrepute; that the mains of the Columbus Gas Company were 'too small,' and, therefore, the trial must necessarily result in failure"—and we will add thereto, "failure to support the Dr.'s theory." Despite this pathetic protest the gas men persisted, the promised pressure scale was instituted, and the following was the result:

We regret to commence our tally by noting that Columbus contains "beer gardens;" and many of the proprietors of same illuminate the "gardens" by the aid of arc lights, the dynamos of the establishments being driven by gas engines. The Teutonic owners were at their wit's end, for the engines would not budge—hence the arcs would not hiss; the storekeepers raved; the hotel men fumed; and the cooks were distracted. All of which was brought about because customers could not see what they were buying; the hotel guests could not read their evening newspapers; and the cooks were obliged to give up cooking the evening meal simply because the gas stoves were "on strike." One particular Columbus man rang up the telephone exchange and asked for the gas company, when the operator replied he "could not give everybody in Columbus the Gas Company at one and the same time," and added, on his own account, "it is so dark here anyway that we can hardly see the keys on the switchboard." So it went on all through the night; but the gas men, in spite of pleading and expostulation, kept up the pressure conditions throughout the entire 24 hours, when the "test was adjourned." The "Dr.," however, has not yet surrendered, and proclaims the avowed intention of compelling the gas company to install larger mains, or else he will seek to establish an opposition corporation. Not to mince matters any, we expect the latter object is what the "Dr." has been solicitous about during the whole controversy; and if such is his aim we would suggest that poor success will be his ultimate reward.

ANNUAL MEETING OF THE IOWA GAS ASSOCIATION.

In accordance with the understanding reached at the meeting for organization of the Iowa Gas Association (held at the Grand Hotel, Cedar Rapids, Iowa, on December 17, 1884), the first annual gathering of the Society took place at the Barret House, Burlington, on date of September 16th. We are rather at a loss to account for the comparatively small attendance that greeted the "call to order" of Chairman Spencer. That such apathy exists in Iowa is not at all creditable to the fraternity of the State, since it should really be a matter of pride with them to see the thing through in thorough good style. President Spencer made every possible attempt to secure success, but was rather heavily handicapped by the fact that Mr. C. M. Williams, of Cedar Rapids, who had been chosen Secretary at the organization meeting, removed to another State, and thus severed his connection with the Association. It is much more pleasing to add that those who were present—probably 50 per cent. of the companies in the State were represented at the late Burlington meeting—were not in the least disheartened; but, on the contrary, pledged themselves to "go on with the good work." And it may be predicted that another twelvemonth will witness a satisfactory endorsement of their efforts. The business transacted was mostly of an informal nature, but nevertheless was pleasing and instructive. Mr. R. Spencer was re-elected President, and Wm. A. Agard, of Des Moines, will occupy the Secretary's desk. In him Mr. Spencer will have an able ally. The next annual meeting will be held at Des Moines, Iowa, on Wednesday, September 15th, 1886.

THE CINCINNATI MEETING.

We do not here deem it necessary to make any extended notice of the coming annual convention of the American Gas Light Association, in view of the continued reminders of same that have been presented to our readers through the medium of the official pen of Secretary Humphreys. Wide-awake as ever, his thorough ventilation of what is desirable on the part of the members to make the Cincinnati gathering successful in every detail and particular places responsibility for the situation entirely in charge of the proper custodians, and the present outlook augurs well for the success of the assemblage of '85. Let there be no relaxation in the effort to outdo all former records.

The Market for Gas Securities.

During the fortnight quotations for Consolidated gas advanced rapidly, and it would seem as though a yet greater advance may with safety be predicted. In last market report closing prices were placed at 93½ to 93½, and at this hour of writing (1 p. m., Sept. 30) we quote the shares as bid for at 97½. This figure represents the actual market, and every indication is presented that the "bulls" control the situation. We quote Equitable at 128 to 133, Brooklyn shares are fairly steady. The Jersey City (N. J.) situation is a trifle mixed, and friends of the Consumers Company assert that 900 meters have been distributed by that corporation. In out-of-town markets dullness is the prevailing feature, although all sorts of San Francisco (Cal.) gas securities show an advance in values.

Atkinson's Differential Gas Engine.

According to *Engineering* (to which authority we are indebted for the details given below) the "Inventions Exhibition" is particularly rich in gas engines, all the standard designs as well as several novel forms being shown. Among these none attracts more attention than Atkinson's differential engine, exhibited by the British Gas Engine and Gas Engineering Company, Limited, of Mansfield Road, Gospel Oak, London. This engine not only displays entire novelty of conception, departing from the received practice both of steam and gas engines, but obtains its results, so it is stated, with great economy in the consumption of gas, and by the simplest possible combination of parts. Compression gas engines have hitherto been constructed in such a manner that they compress a certain amount of gas and air, or gas, air, and residuum from a previous explosion, into a cavity in the end of the cylinder, ignite this charge, and obtain work on the crankshaft from the increased pressure due to the higher temperature during the whole of one stroke or half a revolution, during which time the charge is expanded to the original volume. After this the whole contents of the cylinder are allowed to pass into the exhaust pipe at a pressure of 30 lbs. to 40 lbs. above the atmosphere, and at a very high temperature. The well-known "Otto" engine was placed before the public some seven or eight years ago, and other engines followed it, pos-

ordinary gas engine results from the cooling action of the cold water jacket around the cylinder, and to reduce this Mr. Atkinson designed the engine shown in diagram in figs. 1 to 4, and in plan and elevation in figs. 5 and 6, his object being to allow the gases to expand much more rapidly than usual, and thus to be in contact with the cold cylinder wells for a shorter period. Referring to the engravings, it will be seen that the cylinder is open at each end, and is fitted with two pistons. The pistons are connected with double-ended levers and short connecting rods to one crank-pin. The short connecting rods are an essential feature of the design, as it is through their action that the peculiar differential motion of the pistons is obtained. The pistons travel in the same direction, but at very different relative speeds; when at the outer end of their stroke they remain almost at rest for nearly half a revolution of the crank-pin, but travel rapidly when at the inner ends of their strokes. When the two pistons have completed the strokes to the right (fig. 1) they almost touch each other, and have driven out the products of the previous working stroke through a port in the cylinder wall, so that the hot residuum that frequently causes violent premature ignitions is completely expelled. The crank-pin is at this time on the left, and as it proceeds toward the highest position the left-hand piston moves rapidly away from the other, leaving a space between them into which gas and air are drawn in suitable proportions through a self-acting suction valve. At this point (fig. 2) the right-hand piston travels past and closes the openings to the suction and ex-

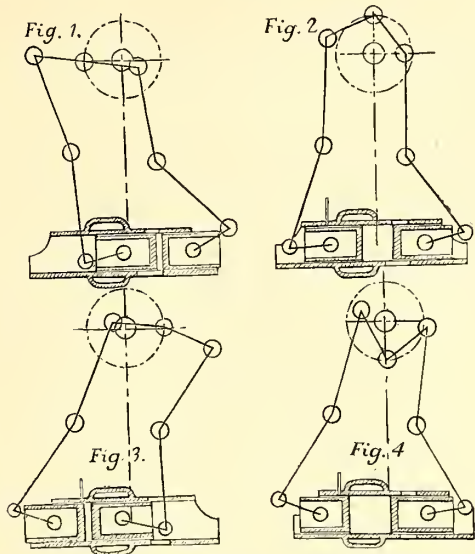

haust valves; and during the next quarter revolution the pistons again approach each other, compressing the charge between them to about 60 lbs. pressure, the crank being now on the right-hand side (fig. 3). At the time of greatest compression the left-hand piston passes the opening to an igniting tube (fig. 3), which causes the ignition, and an immediate rapid working stroke is made by the right-hand piston, and is completed by

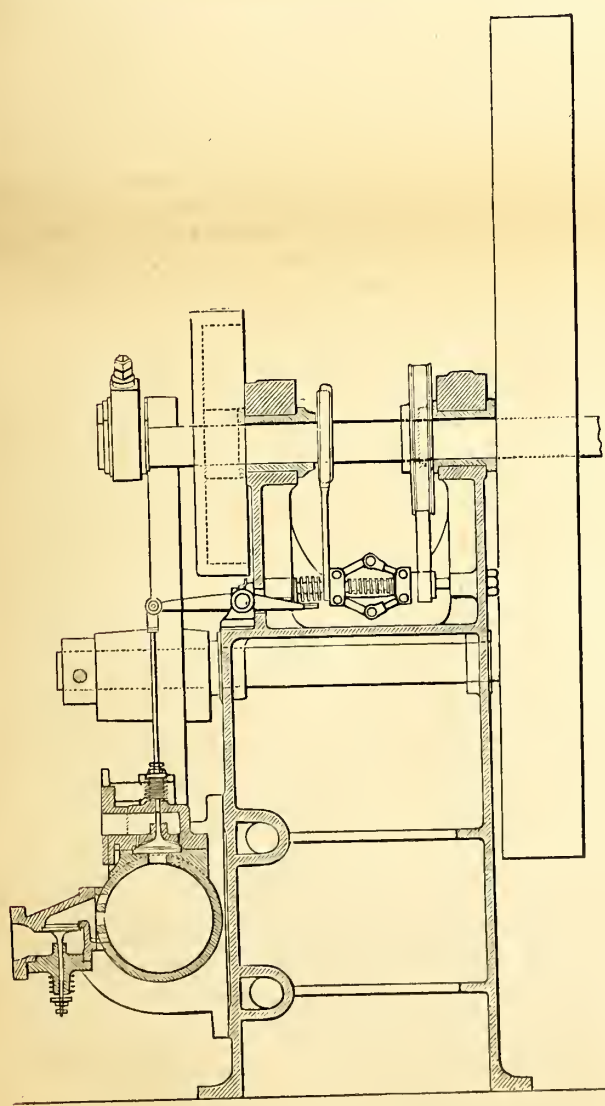
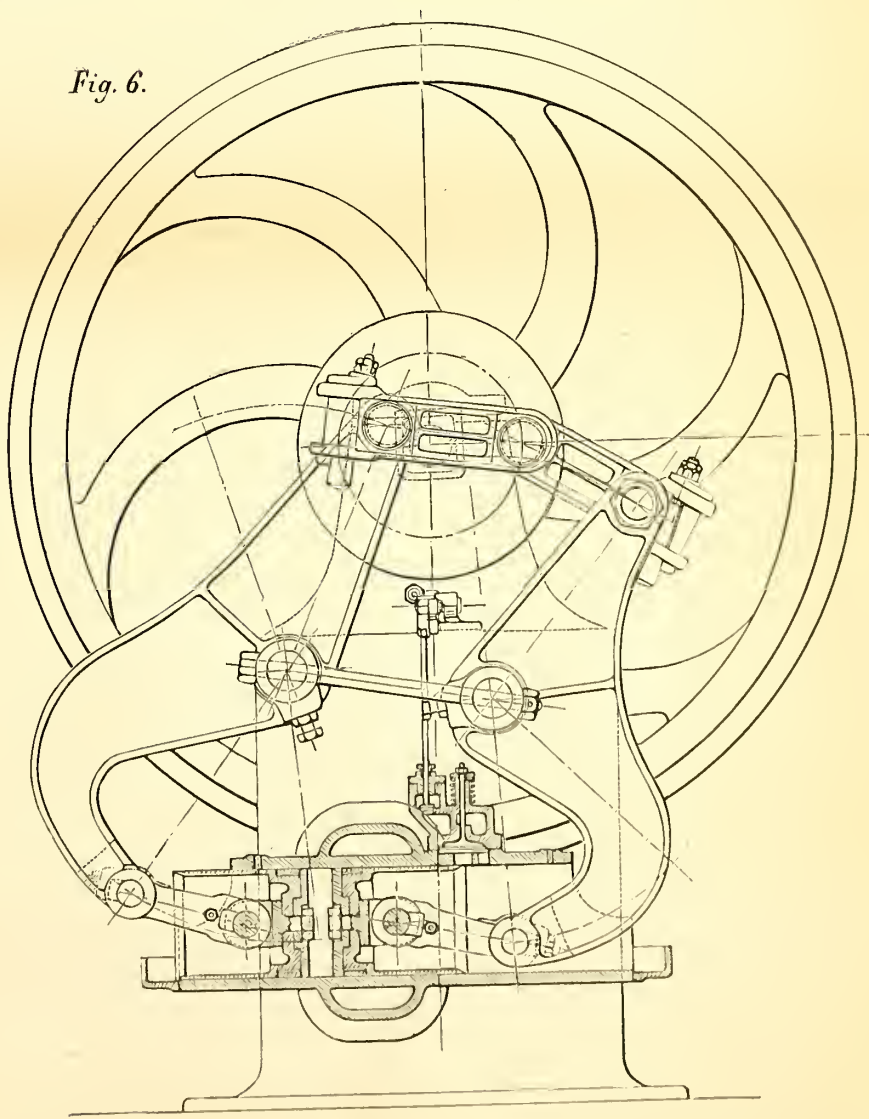

Fig. 6.



sessing the same features in these respects—that is, expanding the charge to the original volume in half a revolution.

Mr. Atkinson argues that substantially the utmost limit of economy in any engine working in this manner was reached in the "Otto" engine some years ago, and that, unless some other system of working were introduced, no further economy could be attained. The great source of loss in the

haust valves; and during the next quarter revolution the pistons again approach each other, compressing the charge between them to about 60 lbs. pressure, the crank being now on the right-hand side (fig. 3). At the time of greatest compression the left-hand piston passes the opening to an igniting tube (fig. 3), which causes the ignition, and an immediate rapid working stroke is made by the right-hand piston, and is completed by

the time the crank-pin arrives at the bottom (fig. 4). The exhaust port is now opened by the continued travel of the piston, and the contents of the cylinder are driven out through the self-acting exhaust valve by the left-hand piston, which is now in the position first mentioned, the cycle being completed in one revolution.

The space between the pistons into which the ignited charge expands is nearly double the space into which the charge is drawn; consequently the expansion is continued to nearly twice the original volume, and instead of the exhaust being emitted at 30 lbs. to 40 lbs. it is expanded down to 10 lbs. or 12 lbs. It will be seen also that the total expansion to twice the original volume takes place in one-fourth of a revolution as compared with other engines which expand to the original volume in half a revolution; consequently the expansion to the original volume is done in one-fourth of the time, assuming the engine to run at the usual speed. The economy to be gained from the extra expansion is obvious, while the saving due to rapid motion of the piston was demonstrated in the early part of 1883 by M. Witz, who made some experiments with a view to determining the effect of increased rapidity of expansion. In one series of experiments he used a mixture of one volume of illuminating gas and 6.33 of air—a very usual proportion in gas engines. This mixture was drawn into an experimental cylinder and exploded, the piston being allowed to travel at the rate of 1.7 meters per second, corresponding to an ordinary piston speed in a medium-sized gas engine; and by means of the diagram he estimated the actual amount of work done. He increased the speed of piston, and found that by allowing the piston to travel 4.3 meters per second, or 2.54 times as fast, the same amount of gas did 2.9 times as much actual work. This enormous increase is chiefly due to the fact that the intense heat of combustion is not allowed to continue so long in contact with the walls of the cylinder, cooled by the water jacket. It is well known that more than one-half of the total heat in the gas, even if thoroughly consumed, is lost by transmission to the water. If the work is done in one-fourth of the time, three-fourths of this serious loss must be saved, the transmission of heat through metallic substances being directly proportionate to the length of time the differences of temperature exist; hence the great increase of power shown by M. Witz's experiments.

It is clear that Atkinson's "differential" engine is a great advance from a theoretical point of view, and from a practical one we understand that the British Gas Engine and Gas Engineering Company, of 11 Queen Victoria street, E.C., who manufacture them, are prepared to guarantee a considerable saving in gas.

From an inspection of the illustrations it will be seen that the engine is extremely simple; there is no slide valve—a fact that anyone practically acquainted with the working of gas engines will appreciate—nor is there any complicated substitute, the working fluid being efficiently controlled by the pistons passing the ports to the two self-acting valves, and the port to the igniting tube; in fact it is more simple than any steam engine. There are no joints under pressure, no delicate passages, no cams or eccentrics; and it has only pistons and bearings for the wearing parts.

Some Notes on the "Novelties" Exhibition Now Being Held at Philadelphia, Under the Auspices of the Franklin Institute of Pennsylvania.

By H. C. ADAMS.

The "Novelties" Exhibition has been so recently and so frequently mentioned to the readers of the JOURNAL that it now scarcely needs an introduction; suffice it, then, to say that the opening took place at the appointed hour—at noon of Tuesday, September 15. In the course of the address delivered upon that occasion it was said, on behalf of the Institute, that visitors must not expect to find the novelties only those things which they had never seen before, for our industrial world moves with such rapidity at present that what is new to-day is old to-morrow; yet it was believed that among the exhibits would be found the latest improvements in nearly every branch of art, sufficiently numerous and instructive to repay extended and careful observation. In that belief we are glad to say the managers are fully justified.

The exhibition is held in the building erected last year for the Electrical Exhibition, and it covers exactly the same ground, including the Depot Annex, as that did. There is apparently no grouping or classification of the exhibits, which are scattered promiscuously about, thereby really adding to one's entertainment by a continued and wondrous variety. For it would seem that truly "every branch of art" is here represented; all sorts, kinds, and descriptions of exhibits are discovered in a tour of the building, and something to interest each class of visitors is insured.

On account of this very general character of the display there will, of course, be found less of immediate interest to the gas men than there was at the Electrical Exhibition last year; nevertheless there are many things that merit more than casual mention.

The illumination of the building attracts particular attention, considered,

as of course it will be, in contrast to the effect produced last year. At that time gas formed a small proportion of the total lights; now we see the conditions happily reversed, and electricity in the background. At least three-fourths of the illumination this year is effected by gas, which is represented so variously as to afford a fine field for comparison. We find the work done by the albo-carbon, the new Lungren, the Siemens, and the Lowe incandescent lights. Besides those there are shown some smaller burners, which are not allotted a particular portion of the building's illumination, but are exhibited in side-booths constructed for the purpose.

The general distribution of the lights is well arranged to afford an opportunity for critical comparison. The electricians are represented by only two systems, both of them arc lamps—the McTighe and the Thomson-Houston. To those is allotted the lighting of the main vault, where fifty nominal 2,000-candle power lamps are hung, the annex and the galleries. The gas lamps are grouped adjacently on the main floor. The two main aisles, diverging nearly at right angles from the main entrance, are lighted for half their length with Lungren lamps suspended in rows on each side. The head of the triangular space so inclosed is hung with the high-power Siemens lamps, which extend on out to the main vault. To the west, immediately alongside of the Siemens and Lungren display, come the albo-carbon lights; these extend to the western end of the building and along the western aisle. The Lowe incandescent lights, flanked by a few burners using the carburetted Lowe gas, we find occupying the eastern aisle and the handsome booth that was last year devoted to displaying the effect of the Brush-Swan glow lamps. Along the inclosed gallery at the southeastern end of the building is strung a row of ordinary gas jets.

So it will be seen we have all the important methods of gas illumination spread before us, from the most pretentious to the most humble. The general effect is brilliant and pleasant. We have never seen more strongly marked the contrast between the dead white glare of the electric arcs and the soft, subdued, yet equally powerful light emitted from the gas lamps. Gas is making a showing that will surprise and please the public, who, after all, are inclined to conservatism; and those who had concluded that the gas light "must go" will here find ample evidence that it will make a permanent stay.

In viewing all this one is struck with the absence of the everyday gas jet and the presence of new high-power lamps—some shown here for the first time to the public. A fertile though long uncultivated field is now being worked by inventors, and the result gives an idea of the real capabilities of gas as an illuminant.

We now propose to give a description of the different systems of illumination shown at the Exhibition, and subsequently to mention such other exhibits as may prove of interest to gas engineers.

THE ALBO-CARBON LIGHT.

The albo-carbon light is simply a new form of the many methods that have been devised since the beginning of gas making to enrich gas and increase its illuminating power. It is, indeed, in principle very nearly the same as the earliest design to that end. It is an English invention, and has been in use in Great Britain and on the Continent for four or five years. Its introduction to this country was not made until the beginning of the current year, yet so rapidly has it come into use that it is already a familiar sight in the shop windows along our streets. The construction of the appliance is very simple, and we do not see how we could better explain it than by taking one of the albo-carbon cluster chandeliers as an example. There is a pendent pipe for the conduction of the gas, such as we find in ordinary fixtures; at a point on this pipe toward the burner end is attached a hollow, circular, mushroom-shaped regenerating chamber a few inches in diameter, extending out radially and flattening so as to present an extensive lower surface, and so connected to the pipe that, to pass on down to the burner, the gas must circulate through the chamber. At its lower extremity the pipe connects with a hollow, pendent, acorn-shaped chamber of about the same diameter as the regenerating chamber. From this lower chamber there is an outlet up along the outside of the central pipe to a point a few inches below the regenerating chamber, and at that point the burner branches diverge. These branches vary in number in the different lamps, and in the larger lamps the length of each alternate branch is graduated so as to give a series of circles of burners at the different distances from the main stem from which the branches radiate horizontally. The inner circle of burners is thus brought directly under the regenerating chamber. A lever-cock is placed at the top of the central supply pipe to turn the gas on or off; and just below the burners is a valve which regulates the delivery of the gas to the burners (which are Bray's, 2-feet), and by which, when the gas becomes too rich and smokes, a portion of it may be, so to speak, short-circuited, and delivered uncarburetted to the burners, thus adjusting the conditions of combustion.

We can now readily understand the operation of the generator: the gas, entering the central pipe, passes down it to the regenerating chamber, and here, supposing the burners to have been some little time in action, it is highly heated by the subjacent flame. The gas thus acquires a high tem-

perature and passes down to the lower chamber, which contains the albo-carbon (Anglice, naphthaline), a solid, white substance which volatilizes at 170°, and which, for convenience of handling, is pressed into small cylinders. The heated gas coming into contact with the albo-carbon vaporizes it, and, taking up a portion, passes up to the burners. Thus we see that it is simply a process for carburetting gas.

In using this process on single burners a special vessel, of a few inches in diameter, containing the albo-carbon, is placed at the delivery point of the fixture. Through that vessel are two passages, one over the albo-carbon, and the other direct to the burner. By turning a key we are able to direct the gas through the carburetter and enrich it, or to send it direct to the burner and use it "straight." The necessary heat to volatilize the albo-carbon is obtained by conduction from a metal plate projecting laterally from the spherical vessel over the flame.

The process is very effective and quite economical. It is estimated that four pounds of albo-carbon will enrich 1,000 feet of gas, and the cost runs from 10 cents to 12 cents per pound. The handling of the carbon is unattended with danger; and if the supply of it gives out, the only effect is a return to the normal candle power of the gas. The cluster lights are made from 3 burners up to 48; the number, of course, being capable of almost indefinite extension. In these clusters it is seen that, to a certain degree, there is a combination of the preheating, or, as it is commonly called, the regenerative system, and carburetting; and it is claimed that by these a light of 8 candles to the foot of ordinary 16-candle power gas is obtained, which is certainly a very good showing.

Albo-Carbon Cluster Light.

However that may be, the albo-carbon lights at the Exhibition are a very handsome display. They are shown in clusters of all sizes, and in the larger ones it will be noticed that at a little distance the flames merge and give the effect of a lustrous band of light. The burning is remarkably steady, and the light emitted is clear, strong and white. In fine, this system seems to supply very well the want of a good, cheap method of increasing the amount of illumination to be derived from a given quantity of gas, with the advantage of being applicable on any scale from one burner up to one hundred.

The albo-carbon light is exhibited by its Eastern agents, Messrs. Kitson & Co., of Philadelphia.

THE SIEMENS LAMPS.

No description of the Exhibition would be complete without a word as to the excellent work done by the Siemens regenerative lamps, which are fully maintaining their reputation, and justifying the commendation they have from time to time received at the hands of the JOURNAL. Occupying, as they do, the very space that Edison and Weston had at the Electrical Exhibition, they are the object of peculiarly trying comparison; but we find as full a flood of light now as when, last year, this spot blazed in the glory of a thousand incandescent lamps.

Nearly all the lamps exhibited by the Siemens Company have 50 feet burners, though some smaller ones are scattered here and there. They are shown in all the various designs, from the plain, work-a-day factory lamp to the highly ornate and burnished fixture designed to hang in some handsome church or public building.

THE NEW LUNGREN LAMP.

The objections to the Siemens lamp have been mainly to the relative position and size of the body, the projecting arm of the return flue, and the burner; yet it is doubtful whether the same high efficiency can be otherwise obtained. To approach that standard as nearly as possible, under another form but embodying the same principle, is the aim of the inventor of the Lungren lamp, Mr. C. M. Lungren, of New York city.

This light was brought out in its original form last fall, and since that time it has been undergoing a gradual process of change and perfection, until now, carefully remodeled, it is prepared to take its place among the high-power gas lamps, which it does, publicly, for the first time at this exhibition. The gas is delivered to this lamp either by a pipe passing down through the center of the vertical, cylindrical chimney surmounting the lamp, or by two branch pipes passing down outside the chimney and meeting at its base. From the delivery pipe the gas passes down to a threaded nipple bored across with outlets at right angles, and with its head blocked the passage of the gas. Upon this nipple screws the base of the burner, which is a hollow cylindrical casting, bored with vertical ducts to carry the gas from the delivery nozzle to the burner proper, which latter consists of two concentric cylindrical shells with an annular gas-way between them passing directly to the tip. This tip is an inverted argand with the orifices in its side. The base of the burner sits about the delivery nozzle, so as to

form a small circular chamber, into which the gas enters, and from which it passes down through the ducts of the base to the annular gas-way of the burner, and thence directly to the tip. Besides being pierced with vertical ducts to carry the gas from the delivery pipe to the burners, the cylindrical burner base is cut across with transverse openings from its outside to its hollow center. Around the base is set a wheel-shaped casting, whose spokes, between which are open spaces, serve as a series of air ducts running from the outside of the lamp to the space just without the burner base.

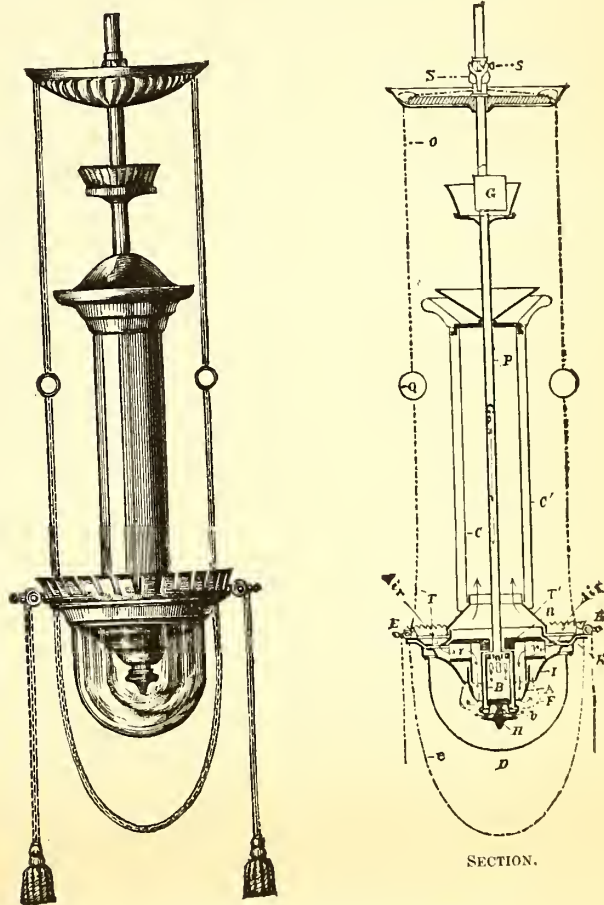

The New Lungren Lamp.

Upon the hub of this wheel-shaped air duct is screwed what is called the flame surface, a cup-shaped cylindrical piece, the outside surface of which is covered with a special white enamel, which encircles the burner to the tip, leaving an annular space between. From the outer edge of the lamp there extends down an enameled piece, shaped like the frustrum of a cone, running close to the flame surface and encircling it a few inches above the tip. The object of that is to confine the flame to the flame surface and to draw it up symmetrically. Between the flame surface and this outer shell is the passage for the products of combustion, which rise and pass through the interstices of the air ducts before mentioned, whence they are delivered to the chimney. Just below the burner tip there is suspended, from supports within the burner's hollow center, a circular button, the function of which is to deflect the air coming down the center of the burner upon the outside of the flame, and to cause it to flow up along the flame surface. Around the bottom of the whole lamp is suspended a clear glass, bell-shaped globe, with a lip setting into a flange, and hung with balance weights so as to permit of its being readily lowered for the purpose of lighting, cleaning, etc.

The operation of the lamp, which is on the regenerative system, is as follows: The gas enters the delivery chamber and flows down through the base and the burner to the tip, where it is consumed, the products of combustion passing from the flame surface, where the flame burns, up through the openings between the air ducts. By that means the air entering through the ducts is very highly heated, and passing on it enters the space about the base of the burner. Here some of it passes down in the annular space between the inner side of the flame surface and the outside of the burner; the rest enters through the transverse opening in the burner's base, and passes down through the cylindrical space in the center of the burner, and descending to the tip, is deflected upon the flame by the button suspended beneath. Another supply of air enters within the globe near its top, serving to cool it and to furnish an additional quantity to the outside of the flame.

The preheated air contributes in itself to the completeness of combustion, and in its passage to the tip it surrounds and heats the gas ducts and the gas contained therein, making a further addition to the efficiency. The effect is to produce the complete combustion so essential for the proper con-

sumption of gas as an illuminant. The light emitted is of about the same color as that seen in the Siemens lamp. The flame lies up along the flame surface, forming the inverted frustrum of a cone of light, and burns with admirable effect. The steadiness of the light, so far as it is dependent on outside influence, is insured through its being entirely enclosed within the globe and so protected from all draughts. But the most important feature lies in the light being emitted from the bottom of the lamp, with no body or fixture intervening between source of light and the space to be lighted—a rare advantage.

The lamp is relatively small and compact in structure, and low in cost. In shape it is a small vertical cylinder, with a semi-spherical head, formed by the globe, at the lower end. The lamps at the Exhibition burn 16 feet; but soon others will be ready burning 8, 12, 25, and 35 feet. The newness of this lamp, and its clear, strong light, attract considerable attention, greeting the visitors immediately on their entrance, and presenting an effect that is indeed novel and almost incredible to the majority of gas consumers who observe it.

The exhibit is made by the Siemens-Luugren Company, of Philadelphia, a consolidation of the Siemens Regenerative Gas Lamp Company, of Philadelphia, and the Lungren Gas Appliance Company, of New York city.

THE WASSERMAN LAMP.

We now come to what is called the "newest regenerative gas light." It probably merits that appellation, for it has just emerged from the embryonic state. It takes no part in the general system of the illumination of the Exhibition, but is exhibited by its inventor, Mr. Adolph Wasserman, of Philadelphia, in a small space to the north of the Lowe exhibit.

In construction the lamp is novel and interesting. It can be placed on any ordinary bracket without change of fixture. From the point where it attaches to the delivery pipe there rises vertically through the center of the lamp a piece of pipe five or six inches in length. That pipe is surrounded by an inverted hollow cone of metal, covered with a porcelain shell, whose base lies a few inches above the top of the pipe, and whose apex—the lowest point in this case—fits into a cylindrical chamber about the bottom. From that chamber four hollow, metallic arms diverge at right angles to each other and extend a few inches horizontally. At about half way along their length are fixed four vertical tubes, one on each arm. These tubes fasten to a circular flange at their top, which supports on its inner edge a cylindrical sheet of metal about an inch high. The flange is about one-quarter of an inch wide, and on its outer edge screws a second cylindrical shell concentric with the one just above mentioned, forming an annular chamber, at the center of which, projecting from the outer shell, is a flange to act as a check on the flow of gas. On the top of this annular chamber sits the burner, a ring of block brass, with a circle of 24 tube like orifices cut solidly out of it. The orifices are about one-sixteenth of an inch in diameter, and about one-sixteenth of an inch apart; they communicate directly with the gas chamber beneath them.

Around the burner and the gas chamber is a sheet brass jacket, resting on the four projecting arms, and at its top slightly drawn in towards the burner tubes. Extending laterally from the outside of the jacket is a circle of sheet metal, closely perforated with holes, to regulate the flow of air. At the edge of this perforated sheet is the chimney, a cylinder of clear glass, with its base resting on the extremities of the four projecting arms, and its top a few inches above the base of the inverted cone.

The operation of the lamp has probably already been discovered from the description of its structure. The gas enters through the central vertical pipe and ascends to its top, where it is delivered in the space within the base of the hollow cone. The cone has, of course, become heated by the action of the flame beneath it, and imparts its heat to the contained gas, which passes on down to the cylindrical chamber at the apex of the cone, where the four arms branch off. Entering these arms the gas flows through them, ascends the four vertical tubes, is delivered into the gas chamber, and then passes directly to the tip. It is a peculiar feature of the construction that these four vertical delivery tubes are of the same diameter as the 24 orifices they are intended to supply. The air, flowing to the burner, enters the open bottom of the lamp, passes between the four horizontal arms, and ascends through the central cylindrical space encircled by the gas chamber; it also passes up outside of the gas chamber, between it and the jacket. A further supply of air is delivered upwards outside the jacket, through the holes in the sheet between it and the chimney. The air that enters the inner part of the lamp strikes the outside of the metal flues that are heated by the hot gas flowing through them from the cone, and thus has its temperature raised before it reaches the point of combustion. As that preheating is accomplished with both air and gas, we have the essentials of what is called the regenerative system of gas lighting.

In appearance these lamps look exactly like large Argand burners with inverted white cones placed in the middle of the chimneys. The flame burns up along the under surface of the cone, making a band of light about two inches high. The only lamps made as yet burn ten feet; in tests made

with them they have given about five candles to the foot of our 16-candle gas. That is not very high efficiency; but the lamp is in a crude state, and may be much perfected in the future. It is another step in a good direction towards small regenerative lamps.

In the question of superiority of methods we incline to these regenerative lamps. The first consideration in consuming gas is to get as much as possible out of the gas *per se*, without resorting to outside enrichers. And any process that obtains from a given quantity of material a larger or better derivative product than was formerly obtained from the same material, is a true advance in industrial art, and this the regenerative system represents.

In the next issue of the JOURNAL we propose to describe the Lowe plant and light, and the remaining exhibits of especial interest.

Mr. Emerson McMillin in Reply to the Charges Made against the Columbus (Ohio) Gas Company.

[In our item columns of last issue mention was made of the fact that certain members of the Columbus City Council were engaged in the now rather common councilmanic practice of attempting to stir up public sentiment in that city against the present management of the Columbus Gas Company. We also then promised to republish Mr. McMillin's "open letter" in answer to the "charges" advanced, and we herewith redeem that promise. The letter appeared originally in the Columbus *Sunday News*, date of September 6th. To make matters clear to our readers, we add that Dr. Robinson and other members of Council asserted that the pressure could not be reduced by turning off the meter cock. They said the supply could be reduced, but the pressure not.]

As briefly as possible I reply to some of the attacks made on the Gas Company in the Council and through the city press. I published a letter in the *Times*, Aug. 8th, in which I tried to show the shallowness of the attacks made, and also suggesting the probable motive. In this letter it was shown that Dr. Robinson had made misrepresentations respecting the cost of lighting the City Hall building, he having asserted that it was costing over \$200 per month. My figures showed that it had cost during the then past twelve months \$116.72 per month; and that instead of its costing between \$2,000 and \$3,000 per annum, it had cost the last twelve months \$1,400.61, and that after the removal of the post office it was costing at the rate of less than \$1,000 per year. The doctor, in his reply, goes back six years, when gas was selling for nearly double the price prevailing the last two years. Had he gone back only five years, when gas was selling 52 per cent. higher than now, he would have convicted himself of misrepresentation as to annual cost as he did respecting cost per month.

In an interview with a reporter of one of the city papers the doctor claims to have established every issue raised against the gas company, and that he has not been controverted on a single point. Just how many "points" the doctor has raised against the gas company, or had raised at that time, I do not know, but only two have been noticed by the press. The first one is respecting cost of gas at City Hall, and in this his own figures, and the time, far back in the past, to which he had to go to get even as good showing as he did, "controverts" him without a word from the gas company. His second point was his great "discovery" of the valuable secret withheld from consumers by the company, that to obtain the most light for the least money gas should be consumed at low pressure. He seems to have abandoned the role of "discoverer," and now admits that the representative of the gas company told the same thing to the public some months before he did. This established principle being much older than either the doctor or the writer, neither of us can lay claim to its discovery.

We are charged with carrying heavy pressure in our pipes to the consumer, where it is to our interest to make the consumption heavy, and of using governor burners on lamp posts where it is to our interest to make the consumption light. I have before said, and I say it again, that it is not to the interest of any gas company that consumers' gas bills should be large. On the contrary, the most money is made by pursuing a policy exactly the opposite, so far as the gas company is able to control the matter. Aside, however, from any such claim on our part, what is to prevent the consumer from employing exactly the same methods employed by the gas company in preventing an undue pressure of gas at the tips of their burners? We have no patents and do not control the sale of gas burners. The gas that is used in the telephone boxes probably does not cost the gas company quite as much as gas costs the consumer, and the company is quite as well able to stand a little carelessness as is the average consumer; yet the company considers the matter of enough importance to put on a burner that will give the most light at the least expense to the company. While the pressure for an ordinary two-story house may be satisfactorily adjusted by turning off the meter cock (and in this way exactly the same results are obtained as would be by reducing pressure at the works), yet it is not so perfect a mode as is the use of a governor burner, or, in case of large business blocks, a separate governor for each floor. While upon this question of turning off or reducing the

pressure at the meter during the time gas burners are lighted, I must notice some things that were reported as having been said at the last Council meeting, in which an amount of ignorance was displayed such as one would expect to hear from a gas expert's attempt to discuss dentistry or law. Dr. Robinson says the meter cock is put there to be used in case of fire. That will doubtless be news to the consumer, as it certainly is to the gas company. Think of a person running through to the back end of a burning building to reach the opening to the cellar, then forward in a dark cellar, full of boxes and barrels, to the front of the building where the meter is usually placed, and then have to retreat by the same route! How many meters would be turned off under such circumstances? No, sir; the meter cock is put in for a twofold purpose. First, the consumer may turn off the supply if he thinks he can detect the smell of escaping gas; and, second, that the pressure may be adjusted to suit his wants. If he is on high ground, or close to the gas works, or on a main where there is a limited consumption, his pressure will be too high, and will need to be reduced by turning off the meter cock, unless he uses governors. It has been asserted that not one hundred of the consumers in this city know that there is any way by which they can turn off the gas at their meters. That is an insult to the intelligence of our consumers.

Dr. Robinson, illustrating the impossibility of regulating the pressure by the meter cock, said that, "to adjust the light in the Council Chamber, and then light the same number of burners in the hall above, some of the lights below will be shut out." True, if the lights below had been adjusted to an extremely low pressure, and in any event the light would be reduced. Why? The gas, being less than half as heavy as air, ascends, the pressure increasing about a tenth for every ten feet of elevation. But that any person with average intelligence should contend that exactly the same thing would not occur had the pressure been reduced at the works, instead of being reduced at the meter cock, is beyond my comprehension. Reason and argument can avail nothing here. Dr. Robinson says the gas company has been telling its consumers for 25 years that they can reduce their pressure by turning off the cock at the meter. Well, should he live long enough, and the company continues to do its duty to its patrons, he will hear the same story 25 years hence. Dr. Halderman said that "so long as the aperture of the feeder at the works is no larger than the sum of all the apertures leading to the meters, the pressure would be exactly the same all over the city." The doctor is an intelligent man, and one who would not purposely mislead, and I do not doubt but what he will correct his statement when he gives the question more consideration. If his statement was true, then as much gas would pass out of the aggregated little apertures at the ends of the long lines of pipe as would pass out of the one large aperture at the works, if disconnected from the long lines of pipe. I will give you one instance to illustrate the fallacy of his assertion. A one-inch pipe, 30 feet in length, under tenths pressure, will discharge in one hour 675 feet of gas; while through 300 feet in length it will discharge but 213 feet of gas, the initial pressure remaining the same in each instance. Why? The greater friction in the longer line of pipe reduces the pressure, and consequently the quantity of gas. This one illustration shows the impossibility of the gas company adjusting the pressure to each consumer's requirements.

It was charged that "Huntington and McMillin had agreed to meet the committee on a certain night, and to reduce the pressure to sixteen-tenths. They failed to meet the committee, and instead of reducing the pressure, increased it." In reply: Neither Huntington nor McMillin ever promised to reduce the pressure to 16-tenths, and Huntington did meet the committee. Whether the charge that we increased the pressure for the purpose of misleading the committee, or for any other purpose, is true, will appear further along. There is manifestly a disposition to mislead the public respecting the quantity of gas that will pass through a burner at different pressures. Dr. Robinson is reported to have shown that a six-foot burner will, with 19-tenths pressure, consume 18 feet per hour. He ought to copy right that "discovery." There can be no doubt about its paternity. A six-foot burner is one that will consume six feet of gas per hour under 10-tenths pressure, and will burn at 19-tenths pressure a little over 8.75 feet, instead of 18 feet. But to be fair, the doctor started off on the basis of 6-tenths, instead of 10-tenths, at which pressure burners are rated. If this burner consumed six feet at six-tenths, it would consume less than 12 feet at 19-tenths. We will not speculate about things of which the public know little, but instead will give the results of actual tests made with the best of apparatus. With five-tenths pressure a burner consumed six feet per hour; at four-tenths, 5.22 feet per hour; at three-tenths, 4.56 feet per hour; being a decrease of 40 per cent. in pressure, and 24 per cent. in gas. Another series of tests, made with a different class of burners, gave the following results: At five-tenths pressure 4.5 feet; at 9.5-tenths, 6.75 feet; and at 19-tenths, 10.2 feet per hour were consumed. There is a general rule that "doubling the pressure increases the flow one-half." This is not mathematically correct, but near enough for practical use. The doctor, however, has discovered that the increase is double that quantity. It is plain that Dr. Robinson

either does not understand the insignificance of the loss in burning gas at 8 or 10-tenths pressure over that of burning at the most economical point, say, at 5 or 6-tenths, or otherwise purposely tries to mislead. The light is increased almost with the increased consumption from five up to ten-tenths. I assert that there are not twenty gas consumers in this city who will burn gas at less than ten-tenths in an open burner if they can get that pressure. To reduce to the most economical point is to sacrifice comfort and to blacken ceilings. It is no compliment to the intelligence of the gas consumers living along the lines of high pressure to assume that they burn their gas at the full pressure of the mains. They do not do it. If when they light their gas it blows, they turn it down until it ceases to blow and shows a good steady light. I venture the prediction that not 50 per cent. of the gas sent out is consumed with a pressure at the burner orifice exceeding ten-tenths, and that not 10 per cent. is consumed at a pressure exceeding 12-tenths. Yet we are told by the wise men of the Council that if the gas company would reduce the pressure to the proper point, one-half less gas would be consumed, and *hundreds of thousands of dollars would annually be saved* to the consumers. As the total sales fall far short of the minimum sum named, it is difficult to see just how this saving is to be figured out. If, as the doctor tells the public, there is 6-tenths difference in the pressure at the various points in the city, how are we to regulate the pressure at the works so that it will not still be necessary for the consumer to regulate his own pressure, either by the meter cock or by the governors? I have already referred to the loss of pressure in gas flowing through pipes caused by friction. How can the company give Hesseuauer's Garden or the North End a good supply of gas without giving the business houses about the corner of High and Long streets too much pressure? And if these business houses must, to get the best results, turn off the pressure at the meter, is it a greater hardship to turn the meter cock one-half off than to turn it one-third off?

So long as the press and members of Council accept the statements of Dr. Robinson as facts, they are certainly justified in becoming a little excited, and that the former should praise the doctor's sagacity and energy, and that the latter should suggest summary measures for eradicating the evil, should be expected. I now assert, and will undertake to prove to the satisfaction of any impartial committee, that every principal statement that has been made by Dr. Robinson, in this controversy, is grossly false. His charges that the gas in the city building was costing over \$200 per month, and between \$2,000 and \$3,000 per annum, were false. It was not, at the time the charges were made, costing the half of the sums named. His charges that the company had reduced the pressure since he opened his batteries, and that the result is a reduction in the bills of 25 or 30 per cent., is false. His charge that doubling the pressure, doubles the quantity of gas consumed, is false. His statement that any increase in the quantity of gas that passes through a burner at over five or six-tenths pressure is wasted and gives no light, is false, as also is his assertion that gas, at above five-tenths pressure, escapes unconsumed and vitiates the atmosphere. Gas is much more perfectly consumed at a pressure of 20-tenths than at 5 or 10-tenths. He does not know the fact that the more rapid and perfect the combustion is, within certain limits, the less is the light obtained. His statement that the gas company admits or says that it cannot give good light at a less pressure than it now gives, is false. His claim that the gas company has *refused* to reduce the pressure is false in this, that neither the City Council, the Gas Committee, nor any consumer, save only Robinson himself, have ever asked the company to reduce the pressure, and he asked to have it reduced only from 22 to 20-tenths. His charge that the gas company's mains are too small, is disproven by his own assertions that the pressure everywhere in the city is double or treble what it ought to be. His statement that McMillin said in the Board of Trade lecture that the burners in the Board of Trade room were then consuming 25 per cent. more gas than was necessary to give good light, and *assigned the small mains* of the company as the reason, is false. His pretending to read to the City Council an extract from a paper by Dr. E. G. Love, Gas Inspector of New York, was in keeping with his other deceptions. The copy of the *Sanitary Engineer*, from which he read, contained nothing of the kind from Dr. Love. The saving of gas at the City Hall, by reason of reduced pressure, has been the doctor's principal card. His saving here is the proof positive of the virtue of reduced pressure. Every day or two for some time it was announced that the pressure has been reduced four or six-tenths; latterly the claim is that the pressure has been increased. This is doubtless thought to be necessary to account for the probable increase in the September bill. Before discussing the pressure feature of this claim, for which the doctor has received so much credit, let us see if we cannot ignore that feature and still account for the small bill. First, in order to prove his assertions, the doctor would doubtless see that no unnecessary burners were lighted during the month. Second, there was, I believe, but one Council meeting held in the chamber, instead of five, as would have been the case had a meeting been held on each Monday night as is the custom. There was no meeting of the Board of Trade Asso-

ciation; but, above all, there was no post office there as in former years. In the *Dispatch*, of Aug. 29th, in figuring out this wonderful saving, there is \$7.94 put in as the sum that would probably have been added had the post office still been in the building. The post office may have paid only \$500 a year, as asserted, for their gas; but this would be over \$40 per month, instead of \$7.94. A much larger per cent., however, of August bills are chargeable to the post office than would be chargeable in January. That office burned gas all night, winter and summer, while other offices in the same building would seldom light their gas in summer, but would be large consumers in winter. Did the post office burn only \$500 worth of gas? Who can tell? It was not measured to them, but was measured with the gas that was used in all other parts of the building. The only indication or fact that we have to judge from is the quantity they consumed in their new quarters. Did they burn there at the rate of \$7.94, or even at the rate of \$40 per month? They burned gas at the rate of about \$1,000 per year. This alone is enough to account for all the difference in the gas bill, without taking into account the efficacy of the four or six-tenths reduction in pressure. Some may still insist that a portion of the saving must be due to the reduced pressure brought about by the doctor's war on the gas company. In answering these I append a few affidavits:

E. McMILLIN, Supt.:-

In answer to your inquiry, I say the pressure on the gas mains in this city has not been changed since late in February, at which time the present automatic governor was attached. This governor, as you know, puts on the pressure only as required by consumers, being limited to a maximum of 23-tenths, and a minimum of 13-tenths. The maximum, as used during the heaviest hours of lighting, is about 22-tenths, and it stands at about 14-tenths during the daytime. On Sunday nights the pressure is about 19-tenths. The governor has not been modified, reduced, increased or changed in any manner since it was first adjusted, and there has not been either an increased or decreased pressure since the appointment of the special committee of the Council to investigate this question, as is reported to be charged in said committee's report.

[Signed.]

WILLIAM ENFIELD,

Sworn to before me, and by him subscribed in my presence, this 4th day of September, A. D., 1885.

[SEAL.]

E. L. ROBINSON,

Notary Public, Franklin County, Ohio.

I have read the above affidavit of Mr. Enfield, and say to my own knowledge it is true so far as it refers to the pressure in the mains during the hours between six in the evening and six in the morning. I am not at the works during day hours.

EDWARD DUNDON.

Sworn to before me, and by him subscribed in my presence, this 4th day of September, A. D., 1885.

[SEAL.]

E. L. ROBINSON,

Notary Public, Franklin County, Ohio.

William Enfield and Edward Dundon are my assistants in the management of the gas works. They have in charge the automatic governor that regulates the pressure of gas in street mains, and no other person or persons are permitted to touch it or make any changes in the pressure. And they will make no changes to increase or decrease the pressure without being instructed to do so. Neither myself nor any other officer of the gas company have given instructions to change the pressure, and I am sure that no change has been made. I further state that Dr. Robinson, member of the Columbus City Council, had been assured by me that no change had been made, and as additional proof, was shown our pressure register sheets, on which are recorded the pressure every minute of the 24 hours of each day, and every day of the year. Dr. Robinson was in possession of these facts at the time he made his report to the City Council, in which report he is reported by the press of this city as asserting the contrary.

E. McMILLIN.

Sworn to before me, and by him subscribed in my presence, this 4th day of September, A. D., 1885.

[SEAL.]

E. L. ROBINSON,

Notary Public, Franklin County, Ohio.

The hardest imaginable things have been said of the gas company here because it has thought it necessary, in order to accommodate patrons, to carry a pressure in its street mains during the day of 13 to 14-tenths, and during the heavy lighting hours of 20 to 22-tenths. One would suppose, to read the discussions in the Council, that ours was the most corrupt gas company in the world. To disabuse the public mind of that idea, I append a list of cities selected indiscriminately from all parts of the country, and give the pressure carried in the mains of those cities:

Name of City.	Day Pressure.	Night Pressure.
Columbus.....	14-tenths.	22-tenths.
St. Louis.....	18 "	25 "
Detroit.....	18 "	30 "
Cincinnati.....	18 "	30 "

Name of City.	Day Pressure.	Night Pressure.
Indianapolis.....	18-tenths.	28-tenths.
Pittsburgh.....	15 "	24 "
Chicago.....	12 "	17 "
Nashville.....	13 "	25 "
Springfield (Ill.).....	18 "	30 "
Cleveland.....	10 "	12 "
Washington (D. C.).....	10 "	10 "
Dayton.....	12 "	26 "
Wheeling (summer).....	16 "	25 "
" (winter).....	20 "	28 "
New York.....	14 "	30 "
Philadelphia.....	18 "	30 "
Newport (R. I.).....	12 "	23 "
Atlanta.....	15 "	40 "
Milwaukee.....	12 "	22 "
Ann Arbor.....	18 "	30 "
Boston.....	18 "	27 "
Covington (Ky.).....	14 "	28 "
Birmingham (Conn.).....	12 "	28 "
Brooklyn.....	8 "	21 "
Lynn (Mass.).....	10 "	25 "
Minneapolis.....	15 "	20 "
Des Moines.....	15 "	25 "
Hartford (Conn.).....	25 "	35 "
Richmond (Va.).....	15 "	20 "
New Orleans.....	20 "	24 "
Syracuse (N. Y.).....	18 "	24 "

A few of these places are required by contract to furnish *not less* than a specified pressure; but none are prevented from giving as much more as they shall find necessary to accommodate the consumers. Detroit is required to furnish 20-tenths; Cleveland is required to furnish 12-tenths in the heart of the city; Washington is required to furnish 10-tenths at the Inspector's office, which is the lowest point in the city, and which probably gives 12 to 15-tenths during lighting hours to their consumers; New York keeps 18 tenths at the street lamp burners; Brooklyn is required to keep 10-tenths at burner. The citizens of those cities, it is safe to say, possess as much intelligence as is contained in the gas committee of Columbus.

The pressures are those carried at the several works, except in the instances of Chicago, Cleveland, Washington, Brooklyn and Boston. These are the pressures in the heart of the cities, except Washington, which, as before stated, is at the Inspector's office. You will observe that in the list Philadelphia, Richmond and Wheeling are given. These cities own their gas works, and can control the pressure as they choose, and certainly would not rob their own citizens. By reason of the elevations in the cities of Richmond and Wheeling, above the gas works, 20-tenths there would give as much pressure to the consumer as 25-tenths would in Columbus. The average pressure of the three cities is 17-tenths in the daytime, and 24-tenths at night, 21 per cent. greater in the daytime, and 9 per cent. greater at night than the pressure in this city. The average of the 29 cities (excluding Columbus), is 15.3 for the daytime, and 25.2 for night pressure, which is nearly 9 per cent. greater in daytime, and 12.7 per cent. greater pressure at night than is carried in Columbus. There is perhaps no city in the world better served with gas than is the city of London, England. The most eminent scientists of the age compose the board of referees. Under the acts of Parliament they may assess fines on the gas companies for letting their pressure run too low, but it remained for the Gas Committee of the city of Columbus to "discover" that this English Board has been laboring under a delusion, and that punishment should be inflicted for putting on *too much* instead of putting on *too little* pressure.

The paper from which the *Sanitary Engineer* published an extract, a portion of which Dr. Robinson read to the Council as the production of Dr. Love, was read before the North British Association of Gas Managers, and if space would permit the whole paper would be given to the public. It would answer the clamor of Robinson, Briggs and company much better than I can. That paper was prepared and read by an eminent English engineer, and he took the ground that gas companies ought to control the pressure of gas by attaching governors near each meter—that the attempt to control the pressure in the mains had in the past proved, and must from the necessity in the case in the future, prove futile; that a maximum pressure must be carried to supply consumers in overtaxed districts, and consumers with small pipes, and then regulate each consumer's pressure, as before stated, at the consumer's meter.

One gentleman in the Council asserted that instead of purifying its gas with lime the gas company purified with sand and sawdust, and by that assertion he furnished a gauge of his knowledge on the subject under discussion, and about which he was trying to enlighten the other and less erudite members. A visit to the works by any intelligent person, who can tell oxide of iron from sand and sawdust, will disprove his assertion.

The Columbus Gas Company is furnishing gas of a quality 10 to 25 per cent. above the contract price. The gas is of unusual purity. It is furnished 25 to 50 per cent. cheaper than gas is furnished to other cities similarly located. The company has offered to light the streets for about half the price that is being charged elsewhere, and yet the company is abused and villified, and the most strenuous efforts are made by a few members of the Council to totally destroy the value of its property.

After trying to show that the company has been doing what its officers believed right, and what our consumers have a right to demand of us, we are willing to let the consumers themselves judge between our acts and what the committee say ought to be done. Dr. Robinson says 5 to 6-tenths pressure is abundant, day or night. We will test this on Monday, September 7th, and in doing so we will give his claim the best possible show, because Monday is the day of least consumption of the business days in the week. We will, during the day, carry 50 per cent., and at night 100 per cent. more pressure than Dr. Robinson says the consumers ought to have. The pressure will be seven and one-half-tenths in the daytime, and 11-tenths at night, and will be thus continued as long as consumers will permit. E. McMILLIN.

SPECIAL ENGLISH CORRESPONDENCE.

COMMUNICATED BY NORTON H. HUMPHRYS.

SALISBURY, Sept. 10, 1885.

The Present Depression and Future Prospects of Sulphate of Ammonia.
—*The Financial Position of Gas Undertakings.*—*Advantage of Enterprise.*—*Price of Gas.*—*The Lancaster Corporation Gas Works.*

The principal event of the past month is the reading of a paper by Mr. Bradbury (of the well-known firm of Messrs. Bradbury & Hirsch, of Liverpool), at a meeting of the Manchester District Association of Gas Engineers, on the subject which forms the first item in the above syllabus. Coming at a time when attention is directed to the question of residuals—not only by the fall in the price of sulphate but also by the more important fall in the price of tar—the utterances of so well known an authority will carry great weight. To show how serious this matter is, it may be mentioned that two or three years since the market value of tar was \$10 or more per ton, while now it is less than \$3—about one-fourth of its former value; and sulphate, which at the former period realized \$100 or \$105 per ton, now stands at less than \$60. Gas companies look to the tar and liquor to return one-third or so of the cost of their coal, so this fall in prices is equivalent to an increase of about 25 per cent. in the cost of the coal, or to an addition of 6 or 8 cents to the working expenses for each 1,000 cubic feet of gas. Engineers who have been sailing close to the wind, by selling gas at the lowest price that admitted of earning the dividends, will be seriously embarrassed; for the shareholders will not be willing to accept a smaller percentage of profit, nor will the consumers be inclined to pay more for their gas.

Mr. Bradbury remarks that, prior to 1882, sulphate was regarded as the standard manure for the beet fields of Europe. Peruvian guano, the only other large source of ammonia, had been deteriorating for years; nitrate of soda, the only other possible opponent to sulphate, had fallen into disrepute. Hence the high range of values prevailing during the years 1875 to 1882. The prices of sulphate, however, caused German chemists to turn their attention to the possibility of utilizing the then much cheaper nitrate; and the outcome of their experiments was the discovery of methods whereby it could be applied in such a manner as to give results equal to sulphate. Meantime, in England, the high prices attainable for sulphate had attracted attention, and all sorts of schemes were proposed for increasing its production. Ammonia was to be recovered from coke ovens, blast furnaces—even colliery owners were to distill small coal for the sake of the product, and attempts were not wanting to utilize the nitrogen of the atmosphere as a source of ammonia. The same mistake was made that happens in prosperous times in other trades—the standard of one or two good years being taken as the basis of future operations. So there was the increased use of nitrate, and the threatened over-production of sulphate, operating simultaneously against the value; and in addition to these speculators came in, and by “bear” speculations made matters much worse for the manufacturers.

So the causes for the present low value of sulphate are summed up as the larger consumption and decline in value of nitrate, increased production, impoverished condition of agriculturists, and “bear” speculations. As regards the future, Mr. Bradbury thinks that although the cheaper production of nitrate will prevent anything like a return to old prices, still sulphate must recover the abnormal reduction in price that has been forced by the speculators. In this respect it will be assisted by the fact that the nitrate producers, in the hope of forcing a rise in price, have agreed to limit the production of nitrate. Sulphate possesses certain advantages as compared with nitrate, and the home consumption is increasing. Mr. Bradbury advises sulphate producers to stimulate consumption by every possible means, by developing home trade, and by encouraging research as to the best means of applying

it. In this latter respect the example of the nitrate producers, who have offered £1,000 as prizes for essays on the use of nitrate as a manure, and subscribed 500 tons to be used for experimental purposes, may be followed.

Obviously the nearest work in the way of promoting a better market for sulphate consists in the development of a local trade. To this subject I have referred in previous letters, and there appears no reason why small gas undertakings should not be able to dispose of the whole of their production in their own immediate neighborhood, thus avoiding the cost of transit and the plundering of speculators. Very opportunely my friend Mr. King, of the *Journal of Gas Lighting*, has recently published a series of leaflets in a cheap form, suitable for distribution among possible users of sulphate, setting forth the proper method of using, its advantages as compared with nitrate and other manures, etc. Gas companies cannot help the competition of nitrate, or over-production; but by cultivating direct contact with the users they may avoid the additional loss which is shown clearly by the above paper to have resulted from the operations of speculators.

The effect of the fall in the price of tar, however, has not yet made itself evident in the revenue records of gas companies, who usually sell by contract covering a year or more in advance. Indeed, this practice is pressing heavily upon tar distillers, and some have been ruined. So that, so far as may be judged from the accounts for the first half of the year, gas undertakings are in a satisfactory condition, and are able to pay good dividends. Against the loss on the tar and liquor may be placed the increased revenue derived from coke, due to the fact that, by introducing generator furnaces, some economy has been effected in the fuel accounts, leaving a larger proportion of coke for sale; and probably in a greater measure to the increased demand for smokeless fuel, and appreciation of the value of gas coke. Many undertakings, by introducing breaking machinery to reduce the coke to the required size, and by better arrangements for delivery to customers, etc., have considerably increased their coke trade within the last few years. The usual increase in the quantity of gas consumed has also been experienced, and slightly lower prices have ruled in the coal market. So that, on the whole, although there is a “fly in the ointment,” the gas industry is in a very satisfactory condition, and will be able to maintain this position, notwithstanding the decreased receipts for tar which will figure in the accounts for the current half year.

It is to be regretted that, with the diminution of the electric lighting craze, gas companies generally are showing a disposition to fall back from that state of enterprise in respect to the better lighting of thoroughfares and the introduction of large burners, into which they were temporarily roused by their brilliant but evanescent would-be competitor. An old proverb sets forth that “possession is nine points of the law;” and if by a wise liberality they advertise the undoubted capabilities of gas for effectively lighting large areas, they will attain a position more secure and tenable than any to which they could hope to reach under the obvious stimulus of competition. There certainly exists a demand for lights of a power scarcely thought of before the present decade; and with a little encouragement to invention in the direction of large burners, before many years pass away there will be a large number of gas lights in use, not of a consumption of 5 cubic feet per hour as at present, but ranging up to 50 cubic feet or more per hour. The introduction of recuperative and other kinds of large burners shows that the tendency will be to replace clusters of ordinary burners, such as sunlights and gasaliers, with one large burner. In this season of comparative calm the managers of gas undertakings will do well to extend their borders in every possible direction—lighting, cooking, heating, and motive power—and thus render their position as secure as possible against that competition which, in this restless age of science, is sure to be brought against them from time to time.

One large gas undertaking, belonging to an incorporated company, has announced an increase in the price of their gas, from the 1st of October next, on account of the fall in price of tar and liquor. The present price is 78 cents per 1,000 cubic feet, and it is to be raised to 86 cents. A discount of 12 cents from this figure is allowed if the account is paid within a stipulated time; so at the increased price the consumers will have an opportunity of obtaining their gas for 74 cents, which is certainly not a very exorbitant amount. While upon the price of gas, I may refer to my remarks last month with respect to the gas supply at Manchester and Salford. Rather warm discussions have taken place, particularly in connection with the former city, and the result is that in both cases the old practice is to be continued. At Manchester it appears that there are 90,000 ratepayers and the gas consumer gas consumers; and this shows that the ratepayer and the gas consumer should not be treated as one and the same person. But it appears that the Manchester Town Authorities have been in the habit of spending the gas profits on public improvements, and that they have several works of that sort on hand; it is supposed that an increase in rates would not be well resorted to; and therefore, as a matter of expediency, that the gas consumers shall contribute in the future as they have done in the past. The Council of the Manchester Ratepayers Association have passed a resolution to the effect

that the practice of indirectly taxing the gas consumer to provide for the expenditures of the Improvement Committee is wrong in principle; and have thus shown that some correct notions as to justice and fairness still remain in that city. I am glad to notice that some experiments are on hand, having in view the more efficient purification of the Manchester gas, which has long been noted as foul in respect to sulphur compounds to a degree that would not be tolerated in the case of a private undertaking; indeed companies have been brought before the authorities and fined for supplying gas not up to the standard of purity, when, as a matter of fact, the condemned article contained less than half the amount of sulphur that is usually present in the gas supplied by the Manchester Corporation. At Salford the price question was treated much the same as at Manchester. The Improvement Committee wanted the money; the price of gas was not excessively high, etc., etc.

The working statement of the Lancaster Corporation Gas Works, for the year ending June 30th, 1885, is a most interesting document, and comprises every information requisite to enable one to judge of the working. An interesting and unusual feature is a statement showing the cost per ton of coal carbonized during each of the 6 years ended June last, which shows the progress that has been made. In the course of the six years the cost of manufacture has been reduced to the extent of 20 per cent., and the distribution charges have been reduced to a like extent. Public lighting remains about the same, and the amount paid as "Rates and Taxes" has slightly increased. A considerable reduction, amounting to more than 50 per cent., is noticeable under the head of "management." The receipts for products, for the reason above considered, have fallen considerably during the past two years. The ultimate result is that, although the gross price of gas, in 1880, was \$1.08, it can now be sold at 80 cents per 1,000 cubic feet, a condition of things which reflects great credit upon the manager, Mr. Armitage. It should be mentioned that, although the nominal price is 80 cents, discounts to the extent of 4 cents is allowed, an additional 4 cents if the consumption is more than 450,000 cubic feet per annum, and a further discount of 12 cents if the gas is used for cooking, heating or motive power. Nearly 73 millions cubic feet of gas have been made during the year, or 10,433 cubic feet for each ton of coal carbonized. Of this quantity 94.2 per cent was sold, 0.67 per cent. used on the works, and 5.12 per cent. is lost by leakage, etc.; 11.15 gallons of tar, and 32 gallons of ammoniacal liquor have been made per ton of coal. Altogether the undertaking furnishes a good example of the results that can be obtained, in a medium-sized works, with good management; and it is noticeable that in several respects they compare favorably with those obtained by the larger undertakings.

Comparative Evaporation Tests.

The Jarvis Engineering Company, of Boston, Mass., under date of Aug. 1st, published the following circular. We give the figures without comment, and would be pleased to hear from Mr. Upton, of the Jarvis Company, concerning other experiments of a similar nature to those herewith reported:

"The following table embraces report of tests in evaporation made on a tubular boiler set with the Jarvis patent furnace, at the Silver Lake Company's mill, at Newtonville, Mass., and represents a day's work in the use of different kinds of fuel.

"The tests were comparative, all having been made alike; the water and coal were weighed in each test; and the fires were started fresh every morning.

"Claims have recently been made that, at the present low cost of Cumberland bituminous coal, it was cheaper to use it than to use a mixture of screenings and soft coal, but these tests prove the contrary. We have figured the screenings at cargo prices. They can be purchased out of coal yards, and delivered at the mill for one dollar per ton less.

Report of Tests.

	No. 1.	No. 2.	No. 3.
Date of test.....	July 21.	July 22.	July 23.
Duration of test.....	11h.12m.	11 h.	11h.10m.
Sort of fuel used.....	Egg.	Cumb.	{ Cumb'Ind. 480 Screen'gs. 1,600
Total weight of water evaporated.....	18,000	17,600	17,357
Equivalent evaporation from and at 212° .	19,548	19,131	18,867
Total weight of fuel consumed.....	2,415	1,954	2,080
Total weight of ashes and refuse.....	479	167	263
Total weight of combustible.....	1,936	1,787	1,817
Fuel consumed per hour pr. sq. ft. grate surface.....	7.84	6.46	6.77
Average temperature feed water.....	152.48	152	151.28
Average pressure of steam.....	45.63	43	44.91

	No. 1.	No. 2.	No. 3.
Water evaporated per pound of fuel under observed conditions.....	7.45	9	8.34
Water evaporated per lb. of combustible..	9.29	9.85	9.55
Equivalent evaporation per lb. of fuel from and at 212°.....	8.10	9.79	9.07
Equivalent evaporation per lb. of combustible from and at 212°.....	10.10	10.70	10.30
Cost of fuel consumed in time run, in dollars and cents.....	5.38	4.45	3.58
Lbs. of water evaporated per \$1 dollar's worth of fuel from and at 212°.....	3,636	4,348	5,270

"Economy of using screening mixture over egg coal, 31 per cent.; economy of using screening mixture over Cumberland coal, 17.5 per cent. Cost of fuel delivered at the mill, including freight, cartage, etc.—egg coal, per 2,240 pounds, \$5; Cumberland coal per 2,000 pounds, \$4.50; pea and dust coal, per 2,240 pounds, \$3.50."

ITEMS OF INTEREST FROM VARIOUS LOCALITIES.

REDUCTION IN SELLING RATES AT WORCESTER, MASS.—At a meeting of the Board of Directors of the Worcester Gas Light Company, held Monday, September 21st, it was determined that the net price for gas should be fixed at \$1.80 per thousand cubic feet, the schedule to go into effect from date of January 1st, 1886. This is a concession of 20 cents per thousand from the present scale, and is also the pleasant practical outcome of the manner in which Superintendent Rollins employed his vacation during the last summer. In our issue for Aug. 17th (p. 97) we furnished a hint as to what that gentleman was busying himself with—in the line of reconstruction, alteration, etc., of the Worcester plant—and we may now complete the account by saying that the new furnaces—two of which are on the McIlhenny plan, four on the Dieterich system, and two on the old method—will be fired up about October 15th. If Brother Rollins did not avail himself of his usual midsummer period of rest and recreation, his comparative freedom from anxiety during the coming busy winter season, owing to the different circumstances under which he will find himself placed, when considering the matter of available working plant, as between '84 and '85, will quite likely repay him for his self-denial. No one will gainsay the fact that \$1.80 a thousand for gas at Worcester is a low figure.

"CARBOLINEUM AVENARIUS."—In spite of its appellation, Messrs. Peters, Bartsch & Co., London, England, the patentees of that oddly-named substance, appear to have developed a material possessing particularly good qualities for the preservation of wood. The Editors of the London *Builder*, after explaining that they had subjected a sample of the material to chemical analysis, the result of which was favorable to the substance, state that "Carbolineum Avenarius is an oily fluid of dark brown color, largely made up of tar oils and a proportion of the antiseptic products of the distillation of tar-yielding substances. It is free from dangerous volatility, its boiling point being a high one, so that it can be used with safety under all ordinary conditions. It is a decided antiseptic, and therefore calculated to be of great service in preserving wood from decay and the attacks of insects. Its power in this direction is considerably enhanced, owing to its oily nature, enabling it to penetrate well into the substance of the wood. In one experiment a piece of well-planed deal, 3/4 inch thick, was taken and treated with one coating of the composition, which, when dry, was found to have penetrated the wood uniformly to the depth of a little more than one-quarter of an inch. This is an important point in favor of the material, as it removes the necessity for any inconvenient and costly appliances for subjecting the wood under pressure to the action of the composition. The covering power of the material is good, and it dries with reasonable rapidity, 24 to 36 hours being the time which elapsed between the application of the stuff and its absorption by the wood in several experiments where the treated work was freely exposed to the air. For all outdoor and buried woodwork, and for all woods exposed to the action of water, salt or fresh, this substance should be decidedly serviceable. The one objection to its employment for the preservation of woodwork used in the internal construction of buildings is to be found in the fact that wood so treated with it burns more readily and fiercely than if merely painted in the ordinary way, or left entirely untouched. This must be borne in mind; but apart from that, and under circumstances where danger from fire is not a primary consideration, there seems scope for extended use of the material."

THE HOLDER IS COMPLETED.—The one and one-quarter million cubic feet capacity gasholder ordered some months ago by the St. Louis Gas Light Company, the contract for the erection of which was secured by the Stacey Manufacturing Company, of Cincinnati, Ohio, has been completed. It is understood that tests on same were most satisfactory.

CHEAPER GAS FOR WALTHAM, MASS.—On date of September 15 Mr. Tarbell, Superintendent of the Waltham Gas Company, gave notice to the people of that city that after first of the present month the selling price of gas would be fixed at \$2 per thousand cubic feet on accounts of all consumers who paid their bills at the office of the Company on or before the 15th day of month in which they were presented. Those failing to settle within the stipulated time are to be assessed at the figure of \$2.50 per thousand. Mr. Tarbell certainly grants a sufficiency of "days of grace;" and it would seem as though the discount were placed at a figure steep enough to secure the settlement of Waltham gas accounts within the allotted time. The Waltham Company offers to supply burners, shades, gas cookers and heaters, etc., at cost price, and places stress upon the fact that gasolium or vapor stoves can be changed to gas cookers at slight expense. Mr. Tarbell concludes his circular to the Walthamites by remarking, "With these concessions and the very low price for gas we confidently hope for a much larger consumption than at present. By this means alone can the present low price be maintained, or future reductions be anticipated."

AND STILL ANOTHER "CONSTRUCTION COMPANY."—Advices from Albany, N. Y., dated September 19, inform us of the filing of articles of incorporation of a concern hereafter to be known—*i. e.*, while it lives—as the "Empire Gas Works Construction Company, of New York." The incorporators and trustees include Messrs. Reinhold Bocklen, Israel Cook, Edward S. Benedict, and Benjamin H. Woodworth, of Brooklyn, and Robert M. Potter, of Jersey City, N. J. Its objects, as set forth, are the construction and alteration of gas works, and "all business pertaining thereto." Capital stock of company is placed at \$500,000, divided into 5,000 shares. We have not the slightest idea as to the ultimate intentions of the "Empire" founders; but, judging from the imposing array of Brooklyn talent represented in the initial directorate, we may be forgiven for indulging in the "guess" that the City of Churches is not unlikely to furnish a future field for the operations of the above-named coterie. We might further opine that the "all business pertaining thereto" portion of the "Empire's" prospectus, or "declaration of intentions," will be likely to receive "particular attention." Many a strange thing has hitherto occurred in Brooklyn gas circles, and the managers of some gas plants in that city are perfectly conversant with the fact that intricate financial ramifications often "pertain thereto," and therein. We suppose the Jersey City capitalist mentioned, in the person of Robert M. Potter, is one of the parties who some years ago were engaged, under the firm name of "R. M. Potter & Co.," in the meter manufacturing business at 14 Morris street, in that city.

"NOTES" FROM DALLAS, TEXAS.—A correspondent writes us in rather a vague manner that a company has been organized in St. Louis, Mo., for the avowed purpose of putting up a new gas plant at Dallas, Texas. He also asserts that the Dallas authorities are about to make a contract with the local Edison Electric Light Company for the lighting of the city's streets under the incandescent system.

THE ENGLISH MARKET FOR SULPHATE OF AMMONIA.—In our "special English correspondence" for this issue of the JOURNAL it will be observed that Mr. Humphrys puts much stress upon the depressed condition of the market for sulphate of ammonia and tar, and rightly surmises that should the present state of affairs continue or progress the English gas maker must soon experience a decided shrinkage in his revenue account—speaking now, of course, with reference to those undertakings that had arranged for the absorption of the bye-products on "long" advance contracts. Mr. Humphrys explains the position quite clearly; and merely by way of reinforcing his comments thereon we append the following extracts from Messrs. Bradbury & Hirsch's "monthly report" on the course of the sulphate of ammonia market during last August: "The month has been a most uneventful one, still the position has puzzled everybody beyond measure. That the 'market' should fall in the face of the nitrate position was certainly not to be expected, and created all the more surprise. Circumstances seem to conspire to keep ammonia reduced to a low level, and unfortunately speculators are not behind in assisting any downward tendency. The demand has been straggling from outward appearances; but a glimpse beneath the surface convincingly showed that it was the way the business was done, rather than the absence of business, which was the conspicuous feature. The shipments are conclusive as to the quantities disposed of, which are quite equal, if not in excess of former years; but makers have not reaped the advantage of the orders, because they had been intercepted by the dealers—that is, the sulphate was sold on speculation, the sellers relying upon being able to bring about a decline to allow them to cover in their transactions at a profit. Thus we are passing through the months of short production even without a sign of the activity which used to prevail at this season of the year."

A NEW GAS COMPANY.—The Mankato Construction Company, which corporation has succeeded to the business privileges, etc., of the firm formerly

operating under the title of O. C. McCurdy & Co., is engaged in the work of erecting and equipping a six-inch coal gas plant in the city of Hastings, Nebraska, and it is now expected that everything will be in readiness to introduce gas illumination there on the evening of October 15th. Hastings is the capital seat of Adams County, Neb., and may be easily reached by rail, being located on the Burlington and Missouri River Railroad, at a point where the latter crosses the St. Joseph and Denver City and Republican Valley Roads. It is a growing and important center, being now about number three in rank among the cities of Nebraska, having a population of perhaps 8,000 souls. Our correspondent writes us that, "judging from the manner in which the citizens act towards the new company, they will give the projectors of the enterprise substantial encouragement." The officers of the Mankato Construction Company are the following named gentlemen: L. Patterson, president; C. R. Miller, vice-president; O. C. McCurdy, secretary; John Van Liew, treasurer.

A POSSIBILITY OF A LAWSUIT.—It is just possible that the courts may be called upon to determine the validity of the franchise (bestowed upon certain speculators by the Chicago (Ills.) City Council, and in turn delivered by them to the promoters of the Equitable Gas Light and Fuel Company) lately granted for the construction and maintenance of an opposition gas works in the Lake City. By all means let the suit be instituted; and in case it should, the testimony brought out may be calculated to furnish spicy reading.

THE "BOSSSES" WERE CONQUERED.—In our "Item" columns of last issue mention was made of a difference that had "cropped out" between the journeymen plumbers and their employers, with the usual question of an increase in wages as the bone of contention. At the time it seemed as though a "strike" must result, for the employers were loud in their assertion that no advance would be granted in the labor rates, and the employees were equally blatant in announcing their determination to strike if their demands were not acceded to. After a week or two spent in bluster and brag the "bosses" succumbed, and the fight was ended.

GAS MATTERS AT ALBANY, N. Y.—We understand that the Common Council of Albany, N. Y., has granted the projectors of the Municipal Company the right to operate a gas works in that city; but have received no details regarding the same from an authoritative source. Could we call upon Mr. Isaac Battin to supply the "missing links?"

CHEAPER GAS FOR NEBRASKA CITY.—Some time ago Mr. Emerson McMillin succeeded in purchasing a controlling interest in the stock of the Nebraska City Gas Light Company, and shortly thereafter installed Mr. J. M. Murphy as Treasurer and Superintendent of that corporation. When the latter gentleman was placed in charge he knew that quite a "job" had been entrusted to him. The plant was not in the best state of repair or forwardness; the people, as usual, had no great amount of affection for the gas purveyors; and no wonder, either, since they had been charged \$4.50 per thousand cubic feet for their gas supply. President McMillin's orders were to "fix the place up," and "cut down the price." We disremember now the exact "cut" first made, but recently have received notification that the first was not intended to be the last, in proof whereof we publish the following circular, published by Treasurer Murphy, on date of Sept. 12th, 1885. Before proceeding further, however, we may remark that even if Nebraska City is located afar in the "Wild West," the printers "out there" would do credit to any place, since the "circular" is a pretty model of neat and clear typography. As to the information conveyed by it, we submit our readers will conclude that the Nebraska Company "means business"—

"To the public:—Under its present management the gas company is entering upon its third year in this city. As you are well aware when we came among you we revived a business that had long been inert, and invested a large capital in anticipation of encouragement which we have never received. This lack of support has been the cause of much conjecture on our part, when it is a fact that we are to-day furnishing the citizens of Nebraska City with gas second to none in illuminating power and purity, and at a marvelously low price—much less than rates charged by any other company in the West, when the size of the city and number of consumers are considered. As we are upon the threshold of the season of early darkness, and consequent use of more artificial light, and in view of the fact that all other means have failed to bring us a liberal consumption of gas and returns commensurate with the outlay of capital, our president has ordered promulgated the following schedule of prices to take effect immediately on all gas consumed in any one calendar month:

"One thousand feet and under that quantity, \$3 per thousand; over 1,000 to and including 2,000, \$2.90; over 2,000, \$2.80; over 3,000, \$2.70; over 4,000, \$2.60; over 5,000, \$2.50; over 6,000, \$2.40; over 7,500, \$2.30; over 10,000, \$2.25; over 20,000, \$2.20; over 50,000, \$2.05; 60,000 feet and over, \$2 per thousand cubic feet.

"We cannot but feel that this concession will be substantially appreciated, and that we will have your hearty co-operation in our endeavor to make gas in Nebraska City a necessity, not a luxury. If we meet with the encouragement due us it will inure to the consumers' benefit, inasmuch as a liberally increased consumption is the precursor of future lower prices." To all of which we would say, "Keep it up, Mr. Treasurer; and let there be no deviation from the proposed policy."

PERSONAL.—Mr. Thomas R. Brown, formerly engineer-in-chief of the Philadelphia, Pa., Gas Trust, is now engaged in "making a trip around the world;" but instead of expecting to compass the journey within the limit of time set by Jules Verne's 80-days tourist, the genial engineer calculated that he would be fourteen months older upon his return to the City of Brotherly Love. Two months out of the fourteen have been blotted out of the calendar since his departure, and when last heard from his address was "Alaska, U. S.," which is rather suggestive of over-condensation. We wish him a pleasant trip.

NOTES FROM CHICAGO, ILLS.—Mr. Forstall is "as busy as a bee" attending to details in connection with the improvements and extensions now in progress of execution at the works of the Chicago Gas Light and Coke Company. Among the items of new plant we note that P. H. & F. M. Roots, of Connersville, Ind., will put in one of their "No. 6" exhausters, and the American Meter Company will erect a 14-ft. station meter. The Peoples Company, of same city, is up and doing, one of their additions to plant being the placing of a 12-ft. station meter. Next in order comes the Hyde Park Gas Company, with a long list of new construction. At the two last-named works, as in the case of the old Chicago Company, the American Meter Company will erect the station meters.

THEY WOULD NOT CONSIDER THE PETITION.—The city fathers of the town of Elgin, Ills., are, to say the least, a most peculiar collection of custodians; but, of course, real matter for wonder would exist only in case did they present an exception to the general run of councilmen. Some time ago Elgin had the electric fever in its most rabid form, and the councilmen acting, as they said, "in answer to general public sentiment," determined that the streets should be illuminated entirely by electricity, in order that other and contiguous boroughs might not cast reproach upon them for their "backwardness in appreciating the advancing spirit of the age." The "spirit of the age" was seized upon to such an extent that right speedily a contract between the local magnates and the home electric lighting company was executed, and by its terms the latter agreed to do the night lighting of the streets, while the former bound themselves to pay, in compensation therefor, out of the public treasury, a sum of money more than double that formerly paid to the Elgin Gas Company for doing the same work—this last is a mistake, since it is really a fact that the gas company, while receiving less than half the amount paid the electrical promoters, rendered, for the smaller sum, a much more satisfactory lighting service. Almost from the beginning of the electric order of illumination complaints were made as to its inadequacy, etc.; but the council paid no attention to them, although it is on record, we believe, the members asserted that "in the course of time the system would please the ratepayers better, as the folks in charge of the electrical display were constantly advancing in the matter of improvement, etc." The "advance in improvement" was such that early in September the business men and taxpayers of Elgin, to the number of 75 or more, presented a formal petition to the Mayor and Council in which it was asserted that the present system of street lighting was unsatisfactory to the people; that the contract with the city was not faithfully carried out; that the system was too expensive, and concluded with the request that either the contract be rigidly enforced or at once terminated. The petition was read at Council meeting of September 15th, and Alderman Welsby, from light committee, promptly replied that the question of "more light" had been under consideration for several weeks, coolly adding thereto, "the committee was already in communication with the electric light company." Next in order came a motion to place the petition on the table, which motion received immediate affirmative action. Before the meeting adjourned Friend Welsby smilingly floated to the surface once more, and explained that if the city would expend "about" \$100 for "a mast and double lamp on the East Side Park, the electric light company would furnish, without cost, light for same during continuance of present contract." Welsby illustrated his proposition by handing in a "sketch of the proposed mast;" and when the same had been duly inspected the Chairman referred the proposition to the "light committee for report." In the meantime the petitioners are smarting under the treatment received at the hands of their servants (?), and while they remain in this mood perhaps some one or more of them may be tempted to institute an investigation that will have for its object a determination of the number of shares held by Welsby and his associates in the capital stock of the Elgin Electric Light Company.

DEATHS FROM GAS INHALATION.—Two well-dressed men, each registering as Mr. Davis, engaged a room at Smyer's Hotel, 35 Bowery, this city, late on evening of Tuesday, September 8th. One was stout, while the other was slender. On Wednesday morning they left the hotel together. On evening of same day the stout Davis returned and engaged room 4. His companion called the following morning, and asked "if Mr. Davis was up yet." A negative answer being returned, the questioner replied, "All right; do not wake him," and then departed. At 4:30 P.M. gas was discovered escaping from room No. 4, and a forced entrance revealed the fact that Davis had been suffocated. On the bosom of his outer shirt had been written in pencil, "Another mysterious case that will baffle the police." Everything pointed to a case of deliberate suicide. His companion has not since been heard from. The second case is that of Joseph C. Fisher, formerly a resident of New Brunswick, N. J., but latterly an inmate of the Pierrepont House, Brooklyn, N. Y. On the morning of Sept. 10th an escape of gas into the corridors of that hotel was traced to the room occupied by Fisher. When the discovery was made, although the room occupied by deceased was filled with gas that had escaped from a turned-on burner, some asserted that Fisher had succumbed to alcoholism, but an autopsy made by Dr. Shepard proved that death had, in the language of the doctor, "resulted from blood poisoning caused by inhaling illuminating gas." The Brooklyn *Eagle* claims that Fisher committed suicide. The last case is one that occurred about a fortnight ago at New Castle, Pa.; but we have received no details regarding the same.

PASSED OVER THE MAYOR'S VETO.—At a meeting of the Utica (N. Y.) Common Council, held Sept. 18th, a communication from the Mayor, vetoing a prior resolution of Council directing that the Mayor and City Clerk enter into a contract with the Utica Gas Light Company for the lighting of 734 gas lamps, was read. After discussion the resolution was passed over the veto by a vote of 9 to 3.

TO TAKE CHARGE AT MINNEAPOLIS, MINN.—Mr. V. L. Elbert, who has been Superintendent of the Jackson (Mich.) works for some years past—and a right good one at that—took charge of the Minneapolis plant about October first. While we can congratulate the Minneapolis folks on securing Mr. V.'s services, we feel we must do so at the expense of the Jackson company's managers. However, no one can blame Elbert much for "mounting upon another rung of the ladder."

MORE COMPARATIVE EVIDENCE.—Note the difference in the nature of the two gases as evidenced by the following. Water gas is supplied to the New England Hotel, while coal gas is the illuminant employed at the Walker House. The evening papers of September 25th chronicle the fact that on the night of 24th, a middle-aged man, clad in the garb of a respectable mechanic, paid for a room at the New England Hotel and registered as John McGee. The smell of gas led the hotel people to his room on the following morning, and the occupant not replying to their summons, the apartment was opened by force. Mr. McGee was found in an unconscious condition, and his death ensued before the physicians arrived. In fact his demise occurred before the ambulance (which had been telephoned for immediately upon discovery of the patient's critical state) appeared on the scene. The newspapers add, "He had blown out the gas before retiring." That is the water gas section of the "deadly parallel;" and next comes the coal gas portion of the comparison, which is reprinted from the columns of the New York *Daily Times*, date of Sept. 19th: "The young lady who was found unconscious on Thursday in one of the rooms of the Walker House, at Port Chester, Westchester County, from the effects of an inhalation of escaping gas, recovered yesterday, and went to her home. Her name is Kate Daley, and her father is gardener for a Mr. Ward, of the firm of Russell, Burdall & Ward, at Glenville, Conn. She said she was not accustomed to gas, and had blown it out instead of turning it off. She had been 17 hours in the room, and during all that time the burner cock attached to a gas burner, passing four cubic feet of gas per hour, had been turned full on." The above instances are surely plain enough, and need no comment.

THE UTICA (N. Y.) STREET LIGHTING CONTRACT.—Elsewhere in our current "item columns" will be found a statement that the Utica Common Council ordered, over the veto of the Mayor of that city, that the authorities enter into a contract with the Utica Gas Light Company for the lighting of the streets for ensuing year. Later information conveys the news that the contract has been signed, and by its terms the Utica company is to receive the sum of \$17,996 as compensation for maintaining 734 gas lamps for the twelvemonth, the company also to receive \$24.70 per annum for each additional lamp over the stipulated total of 734.

A FIVE-MAN POWER GAS ENGINE.—The *Gas Engineer* says that Messrs. Crossley Bros., of Manchester, have just brought out a five-man power gas engine in answer to the great demand for a motor of that capacity. It is quite silent in action, and is fitted with a newly patented pendulum governor. The engine, like every piece of apparatus manufactured by that firm, is of good design and perfect workmanship, and does not take up any unnecessary space when placed in position.

Gas Stocks.

Quotations by Geo. W. Close, Broker and Dealer in Gas Stocks, 16 WALL ST., NEW YORK CITY.

OCTOBER 2.

All communications will receive particular attention. The following quotations are based on the par value of \$100 per share.

	Capital.	Par.	Bid	Asked
Consolidated.....	\$35,430,000	100	97½	98
Central.....	440,000	50	60	70
“ Scrip.....	220,000	—	47	57
Equitable.....	2,000,000	100	128	133
“ Bonds.....	1,000,000	—	107	110
Harlem, Bonds.....	170,000	—	—	—
Metropolitan, Bonds....	658,000	—	110	113
Mutual.....	3,500,000	100	134	135
“ Bonds.....	1,500,000	1000	104	107
• Municipal, Bonds.....	750,000	—	—	—
Northern.....	125,000	50	50	—
“ Scrip.....	108,000	—	—	—
Gas Co's of Brooklyn.				
Brooklyn.....	2,000,000	25	129	131
Citizens.....	1,200,000	20	84	86
“ S. F. Bonds....	320,000	1000	106	110
Fulton Municipal.....	3,000,000	100	159	160
“ Bonds....	300,000	—	104	108
Peoples.....	1,000,000	10	85	86x
“ Bonds.....	290,000	—	105	110
“ “.....	250,000	—	90	95
Metropolitan.....	1,000,000	100	94	96
Nassau.....	1,000,000	25	125	127x
“ Cfts.....	700,000	1000	98	99
Williamsburgh.....	1,000,000	50	155	160
“ Bonds....	1,000,000	—	111	114
Richmond Co., S. L....	300,000	50	64	75
“ Bonds.....	40,000	—	—	—
Out of Town Gas Companies.				
Buffalo Mutual, N. Y...	750,000	100	80	85
“ Bonds...	200,000	1000	95	100
Citizens, Newark.....	918,000	50	103	115
“ “ Bonds...	124,000	—	105	110
Chicago Gas Co., Ills...	5,000,000	25	130	140
Peoples G. L. & C. Co., Chicago, Ills.....			8	12
Cincinnati G. & C. Co..			180	182
Consolidated, Balt.....	6,000,000	100	47	48
“ Bonds....	3,600,000	—	107	107½
Central, S. F., Cal.....			—	58
Capital, Sacramento, Cal.			56	—
Hartford, Conn.....	750,000	25	123	129
Jersey City.....	750,000	20	145	—
Laclede, St. Louis, Mo..	1,600,000	100	100	105
Louisville, Ky.....	1,500,000	50	95	100
Montreal, Canada.....	2,000,000	100	181	182½
New Haven, Conn.....		25	166	170
Oakland, Cal.....			29	30
Peoples, Jersey City..			—	45
“ “ Bonds..			—	—
Paterson, N. J.....		25	90	—

GAS AND WATER PIPES.

A. H. McNeal, Burlington, N. J.....	189
Gloucester Iron Works, Phila., Pa.....	188
Warren Foundry and Machine Co., Phillipsburgh, N. J.....	188
Mellert Foundry and Machine Co., Reading, Pa.....	188
Cincinnati and Newport Iron and Pipe Co., Newport, Ky...	188
Fox & Drummond, New York City.....	188
Ohio Pipe Co., Columbus, Ohio.....	188

PIPE JOINTS.

Pancoast & Maule, Philadelphia, Pa.....	183
Rollstone Machine Company, Fitchburg, Mass.....	183

SCRUBBERS AND CONDENSERS.

G. Shepard Page, New York City.....	189
-------------------------------------	-----

REGENERATOR FURNACES.

Charles F. Dieterich, Baltimore, Md.....	164
--	-----

GAS ENGINES.

Schleicher, Schumm & Co., Phila., Pa.....	168
Clerk Gas Engine Company, Phila., Pa.....	184

GAS REGULATOR.

Helme & McIlhenny, Phila., Pa.....	182
------------------------------------	-----

RETORTS AND FIRE BRICK.

J. H. Gautier & Co., Jersey City, N. J.....	186
B. Kreischer & Sons, New York City.....	186
Adam Weber, New York City.....	186
Laclede Fire Brick Works, St. Louis, Mo.....	186
Brooklyn Retort and Fire Brick Works, Brooklyn, N. Y.	186
Borgner & O'Brien, Phila., Pa.....	186
William Gardner & Son, Pittsburgh, Pa.....	186
Henry Maurer, New York City.....	186
Chicago Retort and Fire Brick Works, Chicago, Ills.....	186
Baltimore Retort and Fire Brick Co., Baltimore, Md.....	186
Standard Gas Retort and Fire Brick Co., Ironton, Ohio.....	186
Oakhill Gas Retort and Fire Brick Co., St. Louis, Mo.....	186
A. T. Chur, New York City.....	193

CEMENTS.

C. L. Gerould, Manchester, N. H.....	182
Brooks, Shobridge & Co., New York City.....	182
E. Thiele, New York City.....	182
Howard Fleming, New York City.....	182

GAS STOVES.

American Meter Co., New York and Philadelphia.....	187
The Goodwin Gas Stove and Meter Co., Philadelphia, Pa.	196

GAS METERS.

Harris, Griffin & Co., Phila., Pa.....	194
American Meter Co., New York and Philadelphia.....	195
The Goodwin Gas Stove and Meter Co., Phila. Pa.....	195
Helme & McIlhenny, Phila., Pa.....	195
Maryland Meter and Mfg. Co., Baltimore, Md.....	194
D. McDonald & Co. Albany, N. Y.....	195
Nathaniel Tufts, Boston, Mass.....	194

EXHAUSTERS.

P. H. & F. M. Roots, Connersville, Ind.....	185
Smith & Sayre Manufacturing Co., New York City.....	190
Wilbraham Bros., Philadelphia, Pa.....	192

GAS COALS.

Penn Gas Coal Co., Phila., Pa.....	193
Perkins & Co., New York City.....	192
Newburgh Orrel Coal Co., Baltimore Md.....	193
Despard Coal Co., Baltimore, Md.....	193
Chesapeake and Ohio R.R. Coal Agency, N. Y. City.....	193
Westmoreland Coal Company, Phila., Pa.....	193

GAS ENRICHERS.

W. H. Doan, Cleveland, Ohio.....	127
----------------------------------	-----

VALVES.

Ludlow Valve Manufacturing Co., Troy, N. Y.....	188
John McLean, New York City.....	188

GAS LAMPS.

Siemens Regenerative Gas Lamp Co., Philadelphia, Pa.....	189
G. Shepard Page, New York City.....	193
Albo-Carbon Light Co., Newark, N. J.....	181

GAS KILNS AND OVENS.

Thompson Gas Kiln and Oven Co., New York City.....	185
--	-----

PURIFIER SCREENS.

John Catot, Lawrence, Mass.....	154
---------------------------------	-----

STREET LAMPS.

J. G. Miner, Morrisania, New York City.....	157
Bartlett Street Lamp Mfg Co., New York City.....	185

BURNERS.

G. Geffroyer, Phila., Pa.....	190
G. Taylor, New York City.....	181

PURIFYING MATERIAL.

Connelly & Co., New York City.....	185
------------------------------------	-----

STEAM BLOWER FOR BURNING BREESE.

H. E. Parson, New York City.....	182
----------------------------------	-----

PIPE COVERINGS.

Chalmers-Spence Company, N. Y. City.....	183
--	-----

GAS FIXTURES.

Mitchell, Vance & Co., New York City.....	185
---	-----

STEAM PUMPS.

A. S. Cameron Steam Pump Works, N. Y. City.....	185
---	-----

SHAFTING, PULLEYS, ETC.

A. & F. Brown, New York City.....	183
-----------------------------------	-----

PIPE WRENCH.

J. H. Williams & Co., Brooklyn, N. Y.....	182
---	-----

HYDRAULIC MAIN.

A. E. Boardman, Macon, Ga.....	185
--------------------------------	-----

SITUATION WANTED

As Superintendent or Engineer of a Gas Works.

Has had full charge of a large works for fifteen years. Best of references. Address

"J. H.," care this Journal.

FOR SALE.

Second-Hand Gas Apparatus.

One Condenser, 4½ ft. diameter by 13 ft. in length over all, containing 150 two and one-half inch tubes, 8 ft. long with 12-in. connections and bye-pass.

Two Smith & Sayre (12-inch) Steam-Jet Exhausters, with 3 Self-acting Bye-Passes.

Four Purifying Boxes, 10 ft. by 14 ft. by 3 ft., with 12-inch connections and center seal.

All in good order, and will be sold cheap. Address

PETER P. MILLER, Manager Citizens Gas Co., Buffalo, N. Y.

Taylor's AUTOMATIC GAS CHECK.

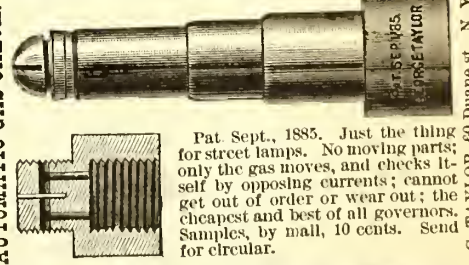

Pat. Sept., 1885. Just the thing for street lamps. No moving parts; only the gas moves, and checks itself by opposing currents; cannot get out of order or wear out; the cheapest and best of all governors. Samples, by mail, 10 cents. Send for circular.

G. TAYLOR, 60 Duane St., N. Y.

Advertisers Index.

	Page
GAS ENGINEERS.	
Jos. R. Thomas, New York City.....	185
Wm. Henry White, New York City.....	190
GAS WORKS APPARATUS AND CONSTRUCTION.	
James R. Floyd, New York City.....	191
T. F. Rowland, Greenpoint, L. I.....	191
Delly & Fowler, Phila., Pa.....	191
Kerr Murray Mfg. Co., Fort Wayne, Ind.....	191
Stacey Mfg. Co., Cincinnati, Ohio.....	191
Bartlett, Hayward & Co., Baltimore, Md.....	191
Morris, Tasker & Co., Limited, Phila., Pa.....	190
Davis & Farnum Mfg. Co., Waltham, Mass.....	192
Tanner & Delaney Engine Co., Richmond, Va.....	190
R. D. Wood & Co., Phila., Pa.....	190
Southwark Foundry and Machine Co., Philadelphia, Pa.....	190
PROCESSES.	
National Gas Light and Fuel Co., Chicago, Ills.....	183
Burdett Loomis, Hartford, Conn.....	182



THE ALBO-CARBON LIGHT!

A new system of Carbureting heated Gas by means of a solid material, whereby its illuminating power is increased more than three-fold.

SUPERIOR TO ALL OTHER SYSTEMS FOR

Economy, Safety, Illuminating Power and General Practicability,

The Albo-Carbon process enables Gas Companies to supply a light equal to the Arc Light, at a much less cost. Several Gas Companies are now using this system. The process is extensively used in Europe, and is being rapidly adopted in this country.

The Albo-Carbon Light Co., - - Newark, N. J.

GENERAL AGENCIES:

1004 Walnut St., Philadelphia, Pa.
94 Fifth Avenue, Chicago, Ill.
522 Pine Street, St. Louis, Mo.

Law Buildings, Lexington Ave, Baltimore.
35 Federal Street, Allegheny, Pa.
120 S. Fourth Street, Minneapolis, Minn.

Helme's Automatic Regulator

As Applied to the

FOULIS GAS GOVERNOR.

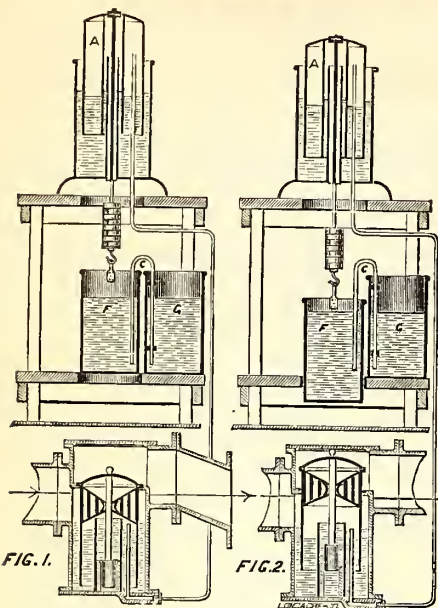

This Regulator and Governor combined are absolutely free from friction, excepting what is due to the moving of the float *A* and valve through the water. There are no journals to carry weight, and the moving parts are so nicely balanced that they do not rub against the surroundings.

The well-understood action of the inverted syphon in a fluid is made available in loading and unloading the float of the Regulator. As the demand for gas increases the float *A* descends, and with it the vessel *F*, drawing into it from the tank *G* a portion of the fluid it contains. This additional weight increases the pressure at the Governor sufficiently to overcome the friction in the pipes due to the increased amount of gas passing. When the shutting off begins a reverse action takes place. The float and vessel *F* begin to rise, and in doing so return to the tank *G* the fluid taken from it while descending.

From this it can be seen that any desired variation in pressure can be arranged for at the Governor, so as to maintain a uniform pressure in center of town. When once adjusted to the minimum day pressure and maximum night pressure it requires no further attention. For prices and further particulars inquire of

HELME & McILHENNY,
Nos. 115 and 117 Cherry Street, - - - Philadelphia, Pa.

BURDETT LOOMIS,
HARTFORD, CONN.

Builder of Gas Works.

LOOMIS'S PATENT WATER GAS APPARATUS, FOR MAKING ILLUMINATING OR HEATING GAS FROM BITUMINOUS SLACK, ANTHRACITE COAL SCREENINGS, COKE, LIGNITE, OR WOOD.

More gas can be made with this apparatus, using **BITUMINOUS SLACK**, than by any other process using same amount of best quality Anthracite Coal, and with less oil. No clinker; no filling up of superheater with ashes, as they are separated from the coal in the process of blasting and easily removed. Plans and estimates furnished.

DYCKERHOFF PORTLAND CEMENT

Is superior to any other Portland Cement made. Its extraordinary strength permits a greater addition of sand, while its acknowledged uniformity insures the most reliable and strongest work. It is therefore the most economical to use. Circulars, with testimonials and tests, sent on application.

E. THIELE,

SOLE AGENT, U. S.,

78 William Street, - - New York.

GIBBS PORTLAND CEMENT

Is guaranteed to be the finest English brand, and unsurpassed by any grade imported for making concrete and setting masonry.

Extract of paper, with tests, read before the Am. Soc. of Civil Engineers, sent on application.

HOWARD FLEMING,

Sole Agent for U. S.,

23 Liberty St., New York.

GEROULD'S IMPROVED RETORT CEMENT.

Used by most of the Gas Companies of the United States with perfect satisfaction. Manufactured by

C. L. GEROULD,
Manchester, N. H.

N. B.—As Manchester is a shipping point, all freight can be shipped as cheaply as from Boston or New York.

BROCK'S PATENT DROP FORGED CHAIN PIPE WRENCH

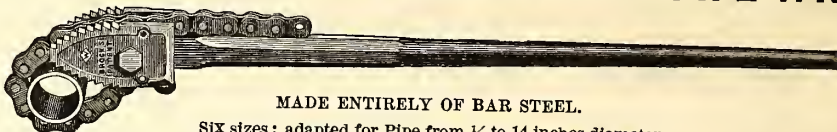

MADE ENTIRELY OF BAR STEEL.

Six sizes; adapted for Pipe from 1/2 to 14 inches diameter.

Each number will fit a range of sizes equal to six or more pairs of common tongs, while it will outwear an equal number of any kind.

All parts are interchangeable, and can be readily renewed.

Jaws are hardened to a saw temper, and can be sharpened with a file.

Does not crush pipe; has a quick grip; never slips; chain will not unhitch while in use, but can be instantly released.

J. H. WILLIAMS & CO.,

Manfs. of Every Description of Iron and Steel Drop Forgings.

No. 14 BOWNE STREET (Near Hamilton Ferry), BROOKLYN, N. Y.

Parson's Steam Blower,

FOR IMPROVING BAD DRAUGHT IN BOILERS, AND FOR BURNING BREEZE OR OTHER WASTE MATERIAL.

PARSON'S TAR BURNER,

FOR UTILIZING COAL TAR AS FUEL.

PARSON'S AIR JET TUBE CLEANER,

FOR CLEANING BOILER TUBES.

These devices are all first-class. They will be sent to any responsible party for trial. No sale unless satisfactory. Manufactured by the WATERTOWN STEAM BLOWER COMPANY.

H. E. PARSON, Supt., 42 PINE ST., N. Y.

HOWARD FLEMING,

23 Liberty Street, New York.

IMPORTER OF THE BEST

Portland & Roman Cements

"DINAS" SILICA FIRE BRICKS AND BLOCKS
For Coke Ovens and Gas Works.

Correspondence invited.

Lowest prices.

BROOKS, SHOOBRIDGE & CO.

Best English Portland Cement

WORKS: GRAYS, ESSEX, ENGLAND.

New York Office, No. 7 Bowling Green.

NATIONAL GAS LIGHT AND FUEL COMPANY,

Sole Owners and Licensees of the Springer Patent Cupola and Process for the U. S.,

Chicago.

Builders, Lessees, and
Purchasers of
GAS WORKS

UNDER THE
**Springer Cupola
Gas Generating System.**

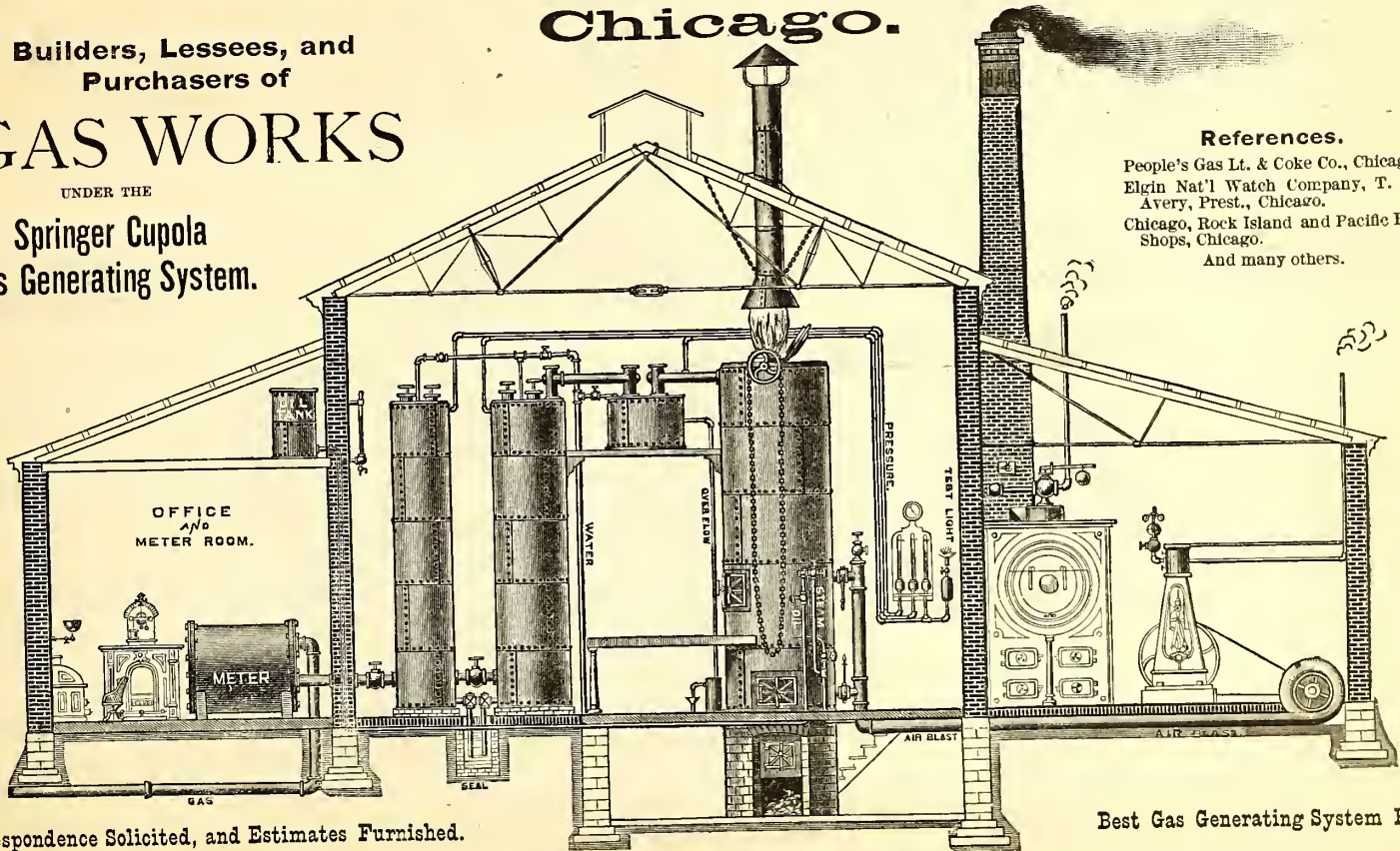

References.

People's Gas Lt. & Coke Co., Chicago.
 Elgin Nat'l Watch Company, T. M.
 Avery, Prest., Chicago.
 Chicago, Rock Island and Pacific Ry.
 Shops, Chicago.
 And many others.

Correspondence Solicited, and Estimates Furnished.

Best Gas Generating System Known.

Orders from Cities, Towns, and Public Institutions Promptly Executed. Address

NATIONAL GAS LIGHT AND FUEL COMPANY, - - - No. 162 Washington Street, Chicago, Ill.

WM. FARMER, ENGINEER,
32 Park Place, Room 36, New York.

THE CHEMIST'S ASSISTANT; OR, KINDERGARTEN SYSTEM OF CHEMISTRY.

A system by which the elements and their valences are represented by illustrations and solid bodies.
BOX AND PAMPHLET COMPLETE, \$2.50.

PATENTS.

FRANKLIN H. HOUGH,
Solicitor of American & Foreign Patents,

925 F. ST., WASHINGTON, D. C.
(NEAR U. S. PATENT OFFICE.)

Personal attention given to the preparation and prosecution of applications for Letters Patent. All business before the U. S. Patent Office attended to for moderate fees. **No Agency in the United States possesses superior facilities for obtaining Patents,** or for ascertaining the patentability of inventions. Copies of patents furnished for 25 cents each. Correspondence solicited.

W. H. DOAN,
REFINER OF

NAPHTHA and GASOLINES

ALSO MANUFACTURER OF

A Special Grade of Naphtha for
Gas Companies

FOR ENRICHING COAL GAS.

Correspondence solicited.

No. 43 Euclid Avenue, Cleveland, Ohio.

GAS CO. OFFICERS, READ AND REFLECT.

It will "Pay the Piper,"
 If he aims to pipe well for
**STEAM, WATER, GAS,
 ACIDS, OILS, AMMO-
 NIA, &c., to examine this
 UNION, which requires
 no packing, but is always
 ready for instant use. When
 you next order Fittings of any Dealer, ask for a
 sample American Union to come with them, and
 it will tell you the whole story, or we will, if you
 write us for particulars.**

**PANCOAST & MAULE,
 PHILADELPHIA, PA.**

HODGE'S UNIVERSAL ANGLE UNION, Pat'd



A new and important Pipe Fitting for Steam, Water, or Gas. Combining a variable angle or elbow and a union. Saves pipe, saves time, decreases friction and radiation, gives a union joint at every angle, and can be set at any angle at which it is desired to run the pipe.

HODGE'S SWIVEL FLANGE,

A common sense article, designed to save time and money.

MANUFACTURERS AND WHOLESALE AGENTS,

ROLLSTONE MACHINE CO.,
142 Water St., Fitchburg, Mass.

OFFICE
43
PARK PLACE
WORKS
ST. 59 AND 61
LEWIS ST
60, 62, 64 & 66
Cannon
ST.

PROGRESS MACHINE WORKS.
A. & F. BROWN

NEW YORK

Shafting, Pulleys, HANGERS.

F. Brown's Patent Friction Clutch.

Send for Illustrated Catalogue and Discount Sheet to

A. & F. BROWN,

No. 43 Park Place, New York City.

Pipe Coverings.

Fireproof, Non-Conducting Coverings for

STEAM PIPES, BOILERS, And all Hot Surfaces.

Made in sections three feet long. Easy to apply; light and cheap.

Asbestos Materials, Fibre, Braided Packing, and Cement. These goods are used at Continental Works, Br'klyn.

CHALMERS-SPENCE COMPANY, 419 & 421 EIGHTH ST., N. Y.

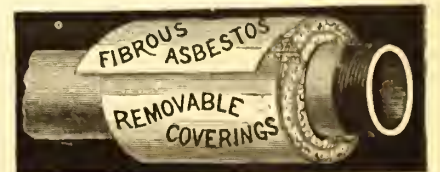

THE CLERK GAS ENGINE.

Highest Award, American Institute, New York, 1883. Silver Medal American Institute, N. Y., 1884.
Gold Medal Awarded Crystal Palace Electrical Exhibition, London, 1882.
Highest Award for Motive Power British Section International Exhibition of Electricity, Paris, 1881.

Reliable.
No Boiler.
Steady.
No Coal.
Simple.
No Ashes.
Compact.

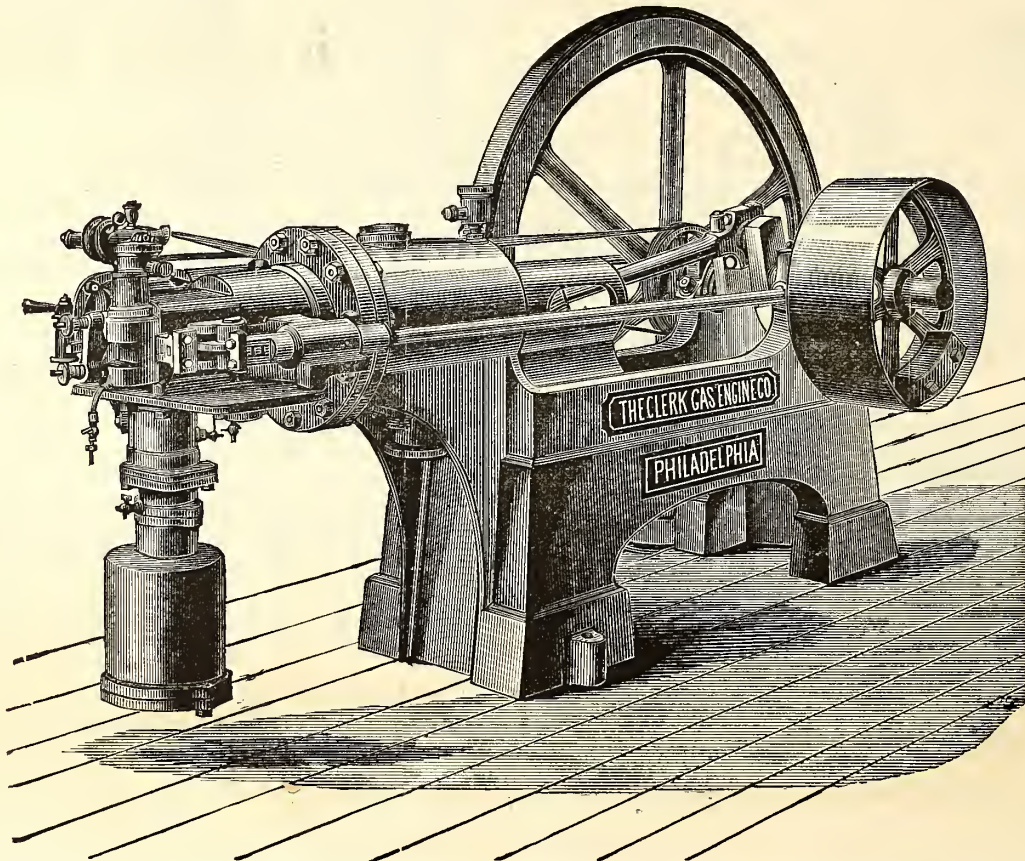

Economical.
No Engineer.
No Explosion
No Gearing
Wheels.
No Danger.
No Parts
requiring
frequent
renewal.

REQUIRING ONLY A MATCH TO START IT--GIVING ITS FULL POWER IMMEDIATELY.

We would inform the public that during the last few months we have improved THE CLERK GAS ENGINE to such an extent that we can now offer an engine vastly superior to our former pattern. These improvements have enabled us to sell our engine at a GREATLY REDUCED FIGURE, partly on account of the decreased weight (our engine weighing about half that of others giving the same Brake H. P). The consumption of gas has been decreased to a considerable extent, and the Brake H. P. has been increased some 25 to 30 per cent. All parts of the old design that were considered defective have been remodeled and new designs added. We now have an engine second to none as regards power, consumption, and ease of working. With our new engine all trouble in starting has been removed, the noise reduced to a minimum, and the regularity of motion is now all that can be desired. We guarantee all we claim for it, and the material and workmanship being of the best, enables us to guarantee the engine for twelve months.

SOLE MAKERS,

THE CLERK GAS ENGINE CO.,

WM. W. GOODWIN, President. E. STEIN, Secretary. S. LEWIS JONES, Asst. Secretary. L. P. GARRET, Supt.

Main Office, 1012-1018 Filbert Street, Philadelphia, Pa.

BRANCH OFFICES,

142 Chambers St., N. Y.

4 West Fourteenth St., N. Y.

76 Dearborn St., Chicago

General Agents,

THE GOODWIN GAS STOVE & METER CO.

Of Philadelphia, New York, and Chicago.

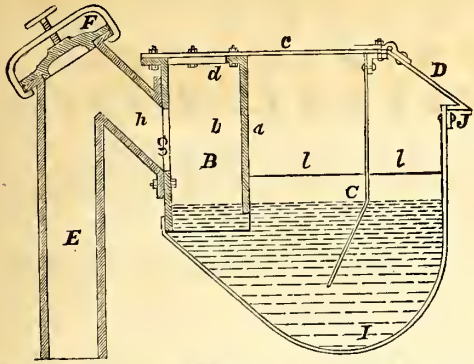

Boardman Hydraulic Main,

Patented October 7, 1884.

For description, see AM. GAS LIGHT JOURNAL of Feb. 2, 1884.
For terms, apply to

A. E. BOARDMAN, Macon, Ga.

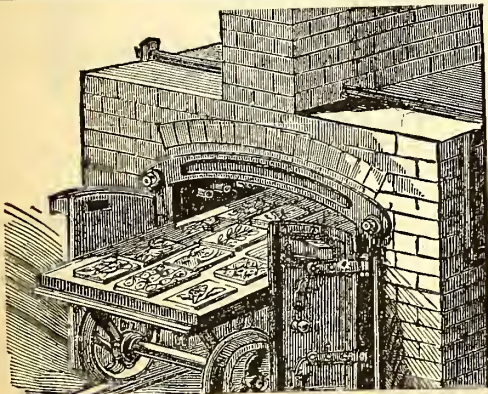

Glass-Staining Gas Kiln.

BAKERS' & CONFECTIONERS' OVENS (PAT.)

Thompson Gas Kiln & Oven Co.

59 Carmine St., N. Y.

Send for Circular by mail.

MITCHELL, VANCE & CO.,

MANUFACTURERS OF

Chandeliers

and every description of

GAS FIXTURES.

Also manufacturers of Fine Gilt Bronzes and Marble Clocks, warranted best time-keepers. Mantel Ornaments, etc.

Salesrooms, 836 Broadway, N. Y.

Special Designs furnished for Gas Fixtures for Churches, Public Halls, Lodges, etc.

Iron Sponge,

GAS EXHAUSTERS,

AUTOMATIC GAS GOVERNORS,

CONNELLY & CO., Limited,

No. 407 BROADWAY, NEW YORK CITY.

JOS. R. THOMAS, C.E.,

May be Consulted on all Matters Relating to Gas Works and Gas Manufacture.

ADDRESS THIS OFFICE,

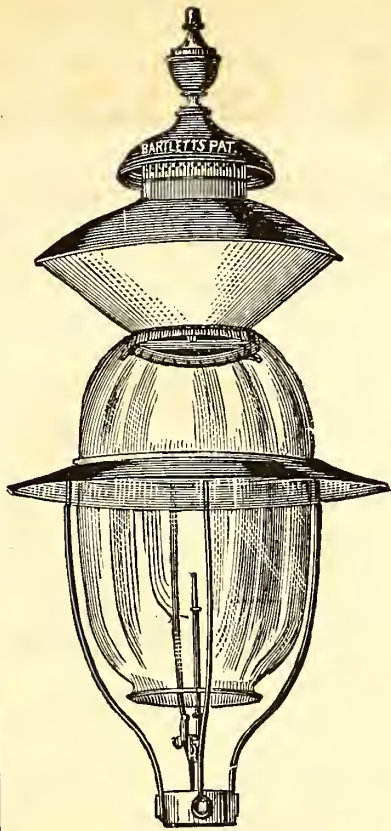

C. BARCALOW, PREST.

J. V. BARCALOW, SEC. & TREAS.

BARTLETT Street Lamp Mfg. Co.

MANUFACTURERS OF

Bartlett's Patent

GLOBE LAMPS.

FOR

Streets, Parks, Railroad Stations, Public Buildings, Etc.

LAMP POSTS A SPECIALTY.

Office and Salesroom,

No. 35 Howard Street, N. Y. City.

Gas Companies and others intending to erect lamps and posts will do well to communicate with us.

F. M. ROOTS.

S. C. ROOTS

D. T. ROOTS.



IMPROVED GAS EXHAUSTER,

WITH ENGINE ON SAME BED PLATE, OR WITHOUT.

BYE-PASSES, GAS VALVES, GOVERNORS, ELBOWS, PIPE-FITTINGS, Etc., FURNISHED TO ORDER,

P. H. & F. M. ROOTS, Patentees & Manufacturers, **CONNERSVILLE, IND.**

S. S. TOWNSEND, General Agent, 22 Cortland St. and 9 Dey St., N. Y.

JAS. BEGGS & CO., Selling Agents, 9 Dey St., N. Y.

COOKE & CO., Selling Agents, 22 Cortland St., N. Y.

✻ SEND FOR ILLUSTRATED CATALOGUE AND PRICE LIST. ✻

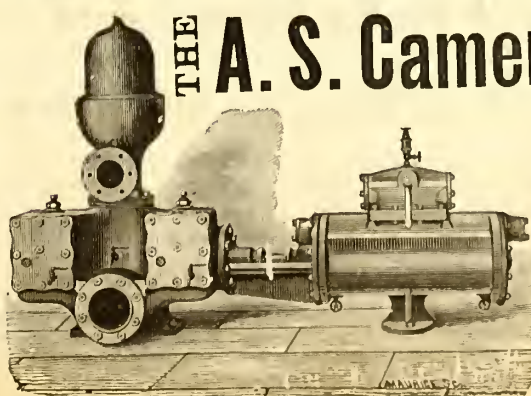

THE A. S. Cameron Steam Pump,

THE STANDARD OF EXCELLENCE.

Upward of 30,000 in Use.

BEST GAS WORKS PUMP
Ever Introduced.

Adapted to Every Possible Duty.

A. S. Cameron Steam Pump Works,

Foot East 23d St., N. Y.

J. H. GAUTIER & CO..
 CORNER OF
 GREENE AND ESSEX STREETS,
JERSEY CITY, N. J.
 MANUFACTURERS OF
Clay Gas Retorts,
Gas House Tiles,
Fire Bricks, Etc. Etc.
 Ground Clay, Fire Brick and
 Fire Sand in Barrels,
 J. H. GAUTIER. T. B. GAUTIER.
 C. E. GREGORY. C. E. GAUTIER.

BROOKLYN
Clay Retort & Fire Brick Works,
 (EDWARD D. WHITE & CO.)
 Manufacturers of Clay Retorts, Fire Brick,
 Gas House and other Tile.
 VAN DYKE, ELIZABETH, RICHARDS & PARTITION STS.
 Office, 88 Van Dyke St., Brooklyn, N. Y.

LACLEDE FIRE BRICK MFG. CO.,
 MANUFACTURERS OF
Fire Brick, Gas Retorts,
 AND
ST. LOUIS STANDARD SEWER PIPE.
 Blast Furnace and Cupola Linings, every description of Fire
 Clay Material, Fire Clay Flue Linings, Chimney Tops
 Dry Milled and Crude Fire Clays, etc.
 OFFICE AND DEPOT
 901, 903, and 905 Pine Street,
 ST. LOUIS, MO.

ESTABLISHED IN 1845.
B. KREISCHER & SONS,
 OFFICE FOOT OF HOUSTON ST., E.R., N.Y.
Gas Retorts,
TILES, FIRE BRICK.
 AND EVERYTHING IN THE FIRE CLAY LINE.

MANHATTAN
FIRE BRICK & ENAMELLED CLAY
RETORT WORKS.
ADAM WEBER.
CLAY GAS RETORTS
AND RETORT SETTINGS
FIRE BRICKS, TILES, ETC.,
 Office and Works, 15th Street and Avenue C., N. Y.

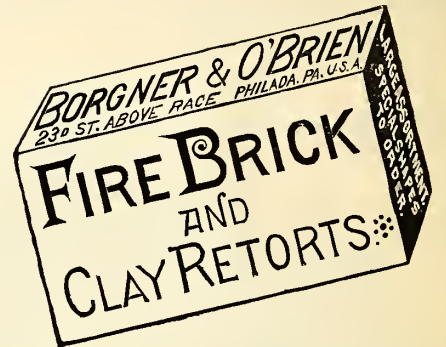

JAMES GARDNER, JR.
 Works,
 LOCKPORT STATION, PA.

—ESTABLISHED 1864.—
WILLIAM GARDNER & SON,
 Successor to GARDNER BROTHERS.

WILLIAM GARDNER.
 Office, COAL EXCHANGE,
 PITTSBURGH, PA., P. O. Box 373.

Fire Clay Goods for Gas Works.

C. H. SPRAGUE, No. 70 KILBY STREET, BOSTON, MASS., Agent for the New England States.

OFFICE, 418 to 422 East 23d St., New York.

ESTABLISHED 1856.

WORKS, PERTH AMBOY, NEW JERSEY.

HENRY MAURER,
Excelsior Fire Brick & Clay Retort Works
 CLAY GAS RETORTS, BENCH SETTINGS, FIRE BRICK, TILES, ETC.

STANDARD GAS RETORT AND FIRE BRICK COMPANY,
 J. ANDERSON, PRES. & MAN'G'R. OF IRONTON, OHIO. C. PETERS, SECRETARY.
Clay Gas Retorts, Fire Brick, and Fire Clay Goods of Every Description.
 Plans of Livesey-Somerville, McIlhenny, and other Furnaces, and Competent Workmen Supplied.

CHICAGO
Retort & Fire Brick Works,
 OFFICE AND FACTORY,
 Clark, Forty-Fifth, and La Salle Streets,
 CHICAGO, ILL.
 GEORGE C. HICKS, PRES. PAUL P. AUSTIN, SEC. & TREAS.
STANDARD
Clay Retorts and Settings.
BLOCKS & TILES
 Of every Shape and Size to Order.
Standard Fire Bricks.

NEWBIGGING'S
Gas Manager's Handbook.
Price, \$4.80.
 EVERY GAS MAN SHOULD HAVE ONE.
 Orders may be sent to this Office.

OAKHILL
GAS RETORT & FIRE BRICK
COMPANY.
PARKER, RUSSELL & CO.
 City Office, 711 Pine Street,
ST. LOUIS, MO.

Our immense establishment is now employed almost entirely in
 the manufacture of
MATERIALS FOR GAS COMPANIES.
 We have studied and perfected three important points. Our re-
 torts are made to stand changes of temperature, the strongest
 heats of the furnace, and the abrasion of feeding and emptying.
 Our customers are in almost every State of the Union, to all of
 whom we refer.

THOS. SMITH, Prest. AUGUST LAMBLA, Vice-Prest. & Sup
BALTIMORE
RETORT & FIRE BRICK CO.
 MANUFACTORY AT
LOCUST POINT, BALTIMORE, MD.
 Connection with the City by Telephone.
Clay Retorts, Blocks & Tiles,
FIRE BRICK, FIRE CLAY,
AND FIRE CEMENT.

Red and Buff Ornamental Tiles and Chim-
 ney Tops. Drain and Sewer Pipe (from
 2 to 30 inches). Baker Oven Tiles
 12 x 12 x 2 and 10 x 10 x 2.
WALDO BROS., 88 WATER ST., BOSTON, MASS
 Sole Agents for New England States

THE AMERICAN METER CO.,



Large Flat Flame Burners.
15 cts. each, \$1.50 per doz.
A test with these burners, with 18-can. gas, gives the following results:

No.	Pressure.	Consump. per H'r	Candle Power
20	1.00 in.	7.75	33.00
30	1.00 in.	9.90	42.50
40	0.85 in.	10.20	44.54
60

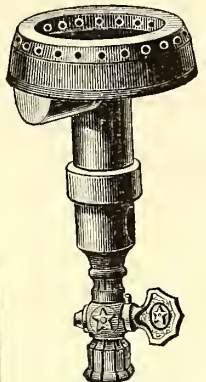

BURNER, by use of which Gasoline Stove is changed to Gas Stove.



Gasoline Stove.

MANUFACTORIES,

508 to 514 West Twenty-second St., N. Y.

Arch and Twenty-second St., Phila.

Nos. 244 & 246 North Wells Street, Chicago, Ill.

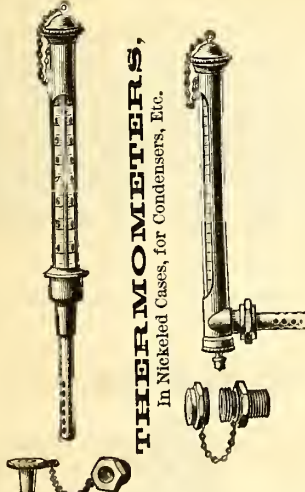

THERMOMETERS,
In Nickered Cases, for Condensers, Etc.

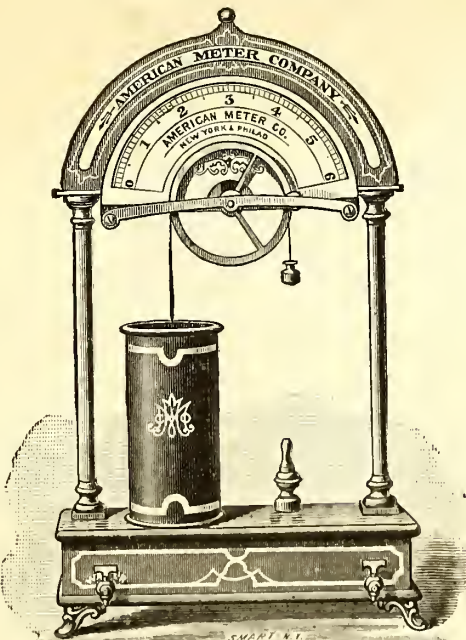

Arch Pressure Gauges.
Japanned and Nickered. Sizes: 3 in., 4 in., 6 in., 9 in.



SIPHON Pressure Gauges.

- 4 inch, Nickered.
- 6 inch, "
- 8 inch, "
- 10 inch, "
- 12 inch, "
- 14 inch, "
- 16 inch, "
- 18 inch, "
- 20 inch, "
- 24 inch, "

AGENCIES,

No. 177 Elm Street, Cincinnati, Ohio.

Nos. 122 & 124 Sutter Street, San Francisco Cal,

No. 810 North Second Street, St. Louis, Mo.

A. H. M'NEAL,

BURLINGTON, N. J.

Flange-Pipes

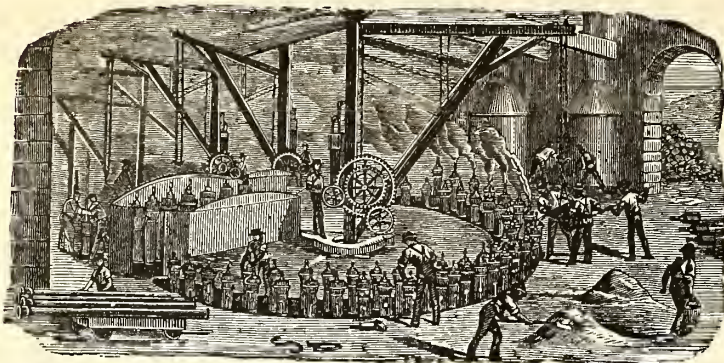

General Foundry Work.

CAST IRON PIPES FOR WATER AND GAS

JAMES S. MOORE, Pres.
BENJAMIN CHEW, Treas.

JAS. P. MICHELLON, Sec.
WM. SEXTON, Supt.

GLoucester IRON WORKS, GLoucester CITY, N. J.

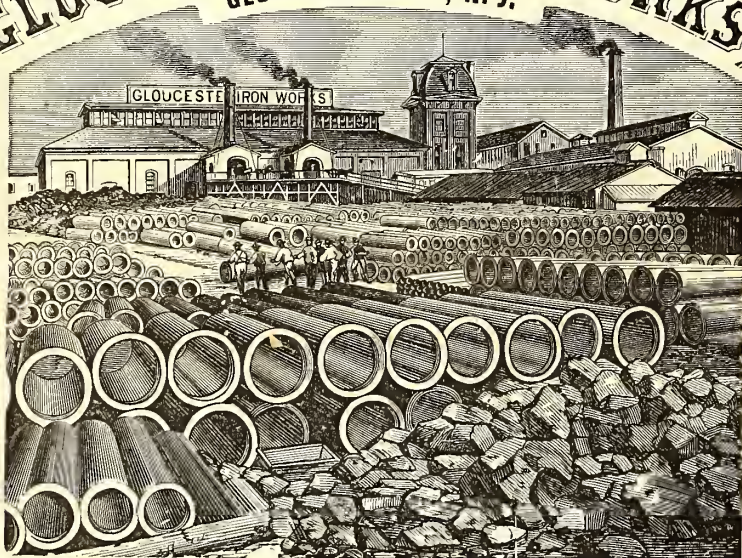

Cast Iron Gas & Water Pipes, Stop Valves, Fire Hydrants, Gasholders, &c.
Office No. 6 North Seventh Street, Philadelphia.

ESTABLISHED 1856.

WARREN FOUNDRY AND MACHINE CO.,

WORKS AT PHILLIPSBURGH, N. J.
NEW YORK OFFICE, 162 BROADWAY.

Cast Iron Water and Gas Pipe

FROM TWO TO FORTY-EIGHT INCHES DIAMETER.
ALSO ALL SIZES OF

FLANGE PIPE for Sugar House and Mine Work.
Branches, Bends, Retorts, Etc., Etc.

436-1

MATTHEW ADDY, President.

W. L. DAVIS, Selling Agent.

GEO. P. WILSHIRE, Sec. & Treas.

Cincinnati and Newport Iron and Pipe Company,

NEWPORT, KY.

Lamp Posts
AND
BENCH CASTINGS

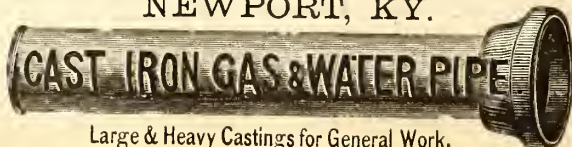

Branch
AND
SPECIAL CASTINGS

A Specialty.

Large & Heavy Castings for General Work.

FOR GAS & WATER CO'S.

Manufacture Pipe from 2 to 48 inches. All work guaranteed first quality.

Mellert Foundry and Machine Co. Limited.



Specials—Flange Pipe, Valves and Hydrants,
Lamp Posts, Retorts, etc.
Machinery and castings for Furnaces, Rolling Mills, Grist and
Saw Mills, Mining Pumps, Hoists, etc.
GENERAL OFFICE, - - - READING, PA.

CAST IRON Gas and Water Pipes,

From 2 to 48 Inches in Diameter.

FOX & DRUMMOND,

160 Broadway, N. Y. City.

THE OHIO PIPE COMPANY,

MANUFACTURERS OF

Cast Iron Gas & Water Pipe, BRANCH AND SPECIAL CASTINGS.

Gas-House Bench Castings, Hydraulics, Lamp Posts, Flange Pipe
and Specials, Architectural Castings, Building Columns,
Joists, Chimney Grates, Sash Weights, etc.

GENERAL FOUNDERS AND MACHINISTS.

Columbus, Ohio.

LUDLOW VALVE MFG. CO.

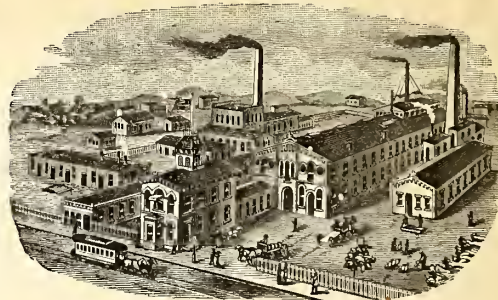

OFFICE AND WORKS,

93S to 954 River Street and 67 to 83 Vail Av.

TROY, N. Y.

Hydraulic Main Dip Regulators, also
Check Valves, Foot Valves, Yard-
wash and Fire Hydrants.
Send for Circulars.

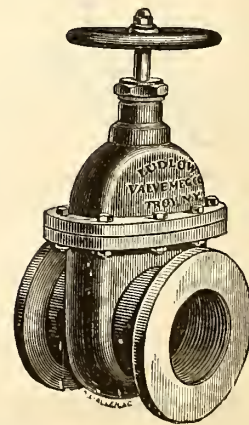

Valves.—Double and Single Gate, 1/2 in. to
48 in., outside and inside Screws. Indica-
tor, etc., for Gas, Water, Steam, and Oil.
and for Circulars.

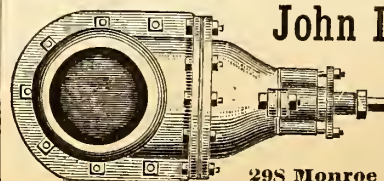

John McLean

Manufacturer of

**GAS
VALVES.**

29S Monroe Street, N. Y.

R. D. WOOD & CO.,

400 Chestnut Street, Phila., Pa.

Cast Iron Gas & Water Pipe, Water Machinery & Gas Apparatus

Cast Iron Pipe, Fire Hydrants, Eddy Valves, Lamp Posts, Large Loam Castings, Flanged Pipe, Sugar House Work, Iron Roofs and Floors, Wrought & Cast Iron Tanks, Turbine Water Wheels and Pumps.

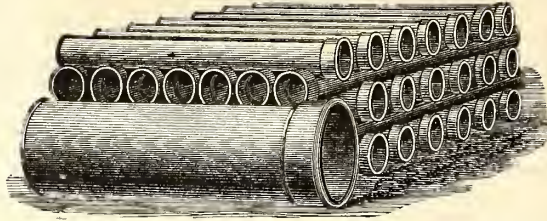

Casholders, Lime Trays, Center Valves, Purifiers, Bench Work, Exhausters, Condensers, Governors, Scrubbers, Gas Valves, Station Meters, Cast Iron Pipe Fittings.

Manufacturers of Heavy Castings and Machinery of Every Description.

ENGINEERS & CONTRACTORS FOR THE ERECTION OF GAS WORKS, & ALL MACHINERY CONNECTED THEREWITH

Estimates and specifications furnished for erection of new works or the extension or alteration of old ones.

Foundries and Works. - - Millville, Florence, and Camden, N. J.

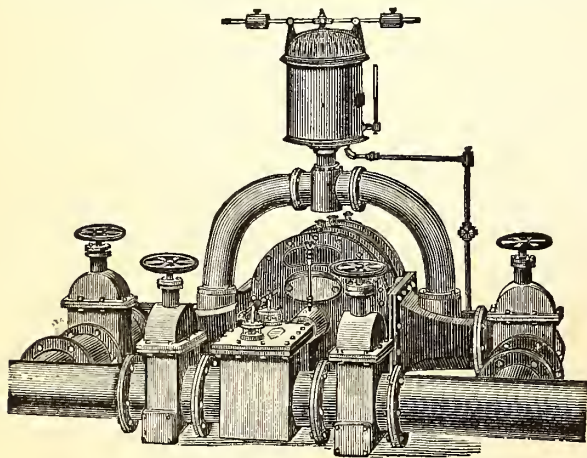

SMITH & SAYRE MFG. COMPANY,

G. G. PORTER, Prest.

245 Broadway, N. Y.

CHAS. W. ISBELL, Sec'y.

Machinery & Apparatus for Gas Works

Drawings, Plans, and Estimates Furnished for the Improvement, Extension, or Alteration of Gas Works, or for the Construction of New Works.

Mackenzie's Patent Rotary and Steam Jet Gas Exhausters, Governors, Compensators, Condensers, Washers, Scrubbers. Isbell's Patent Automatic Street Pressure Governor, Gas and Water Valves, Hydraulic Main Dip Regulator, Bench Castings, etc. Purifying Boxes and "Standard" Scrubbers. Isbell's Patent Self-Sealing Retort Doors.

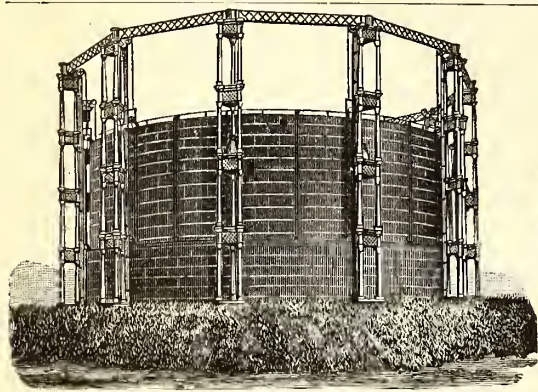

W. E. Tanner, Pres., W. R. Trigg, V.-Pres., A. Delaney, Supt.

Tanner & Delaney Engine Co.

RICHMOND, VA.

Gas Apparatus,

INCLUDING

Condensers of various styles, Scrubbers, Holders, Purifiers, Castings for Retort Houses, Etc.

ALSO STEAM ENGINES AND BOILERS.

Plans, Specifications and Estimates Furnished.

MORRIS, TASKER & CO.,

Limited,

Builders of Gas Works,

PHILADELPHIA, PA.

To Gas Companies.

We make to order **CAP BURNERS** to burn any amount under a stated pressure. Send for samples.

Also, **SERVICE CLEANERS, DRIP PUMPS, and STREET MAIN PROVING APPARATUS.**

C. A. GEFROER,

248 N. 8th Street, Phila., Pa.

SOUTHWARK FOUNDRY AND MACHINE COMPANY,

Successors to MERRICK & SON. Established in 1836.

No. 430 Washington Avenue, Philadelphia, Pa.

MANUFACTURERS OF

Single and Telescopic Gasholders,

BENCH CASTINGS,

Washers, Scrubbers, Condensers, Purifiers,

And all apparatus necessary for the construction of improved new gas works and in the extension of established works. Also manufacturers of

Gas Engines, and of all descriptions of Steam and Hydraulic Machinery, and of Boiler and Tank Work.

Plans, specifications, and estimates furnished promptly on application.

WM. HENRY WHITE,

Consulting & Constructing

Gas Engineer & Contractor.

ESTIMATES, PLANS, AND SPECIFICATIONS FURNISHED FOR NEW WORKS OR EXTENSIONS OF EXISTING WORKS.

32 Pine St., New York City.

Correspondence solicited.

KERR MURRAY MFG. CO.,

MANUFACTURERS OF

Single Lift and Telescopic

GASHOLDERS.

Built, 1884:

Altoona, Pa.....	Capacity, 160,000 cubic feet.
Pittsburgh, Pa.....	250,000 "
" ".....	220,000 "
Bellaire, Ohio.....	50,000 "
Youngstown, Ohio.....	60,000 "
Canton, ".....	60,000 "
Akron, ".....	80,000 "
Xenia, ".....	10,000 "
Adrian, Mich.....	65,000 "
Ypsilanti, Mich.....	25,000 "
Muskegon, ".....	70,000 "
South Bend, Ind.....	70,000 "
Anderson, ".....	20,000 "
Plainfield, ".....	10,000 "
Springfield, Illinois.....	100,000 "
Evanston, ".....	50,000 "
Freeport, ".....	35,000 "
Elgin, ".....	60,000 "
Sheboygan Wis.....	20,000 "
Key West Fla.....	10,000 "

Plans and estimates furnished for the erection of new and the rebuilding of old works. Address

Kerr Murray Mfg. Co.,
FORT WAYNE, IND.

JAMES R. FLOYD,

(SUCCESSOR TO HERRING & FLOYD)

Oregon Iron Works,

531 to 543 West 20th St., N. Y.

Practical Builders of Gas Works,

MANUFACTURERS OF

ALL KINDS OF CASTINGS
AND
APPARATUS FOR GAS-WORKS.

BENCH CASTINGS

from benches of one to six Retorts each.

WASHERS: MULTITUBULAR AND
AIR CONDENSERS; CONDENSERS;
SCRUBBERS

wet and dry, and

EXHAUSTERS
for relieving Retorts from pressure.

BENDS and BRANCHES
of all sizes and description.

FLOYD'S PATENT
MALLEABLE RETORT LID.

PATENT
SELF-SEALING RETORT LIDS.

FARMER'S
PATENT BYE-PASS DIP-PIPE.

SABBATOR'S PATENT
FURNACE DOOR AND FRAME.

BUTLER'S
COKE SCREENING SHOVELS.

GAS GOVERNORS,

and everything connected with well regulated Gas Works at low price, and in complete order.

SELLER'S CEMENT

for stopping leaks in Retorts.

N. B.—STOP VALVES from three to thirty inches—
at very low prices.

Plans, Specifications, and Estimates furnished.

CONTINENTAL WORKS.

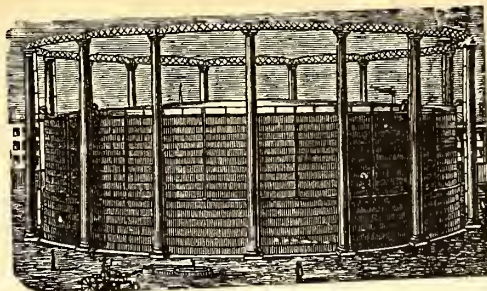

GASHOLDERS OF ANY MAGNITUDE.

T. F. ROWLAND, Proprietor,
GREENPOINT, BROOKLYN, N. Y.
ENGINEER AND MANUFACTURER OF
GAS-HOLDERS.
CONDENSERS, SCRUBBERS, VALVES,
PURIFIERS, RETORTS, and HY-
DRAULIC MAINS,

and all other articles connected with the Manufacture and Distribution of Gas. Plans and Specifications prepared and Proposals given for the necessary Plant for Lighting Cities, Towns, Mansions, and Manufactories.

H. RANSHAW, Prest. & Mangr. WM. STACEY, Vice-Pres. T. H. BIRCH, Asst. Mangr. R. J. TARVIN, Sec. & Treas.

STACEY MFG. CO.,

MANUFACTURERS OF

Single and Telescopic Gasholders,

IRON ROOFS, BRIDGES, LAMP POSTS,

Water and Oil Tanks, Coal Elevator Cars,
COKE CRUSHERS, BENCH CASTINGS,

And all kinds of Wrought and Cast Iron Work used in the erection of Coal and Oil Gas Works.
Rolling Mill Machinery and Heavy Castings a Specialty.

Foundry:
33, 35, 37 & 39 Mill Street.

Wrought Iron Works:
16, 18, 20, 22, 24 & 26 Ramsey Street.

Cincinnati, Ohio.

BARTLETT, HAYWARD & CO.,

Office, 24 Light. **BALTIMORE, MD.** Works, Pratt &

PURIFIERS.
Roofs.
Bench Castings.

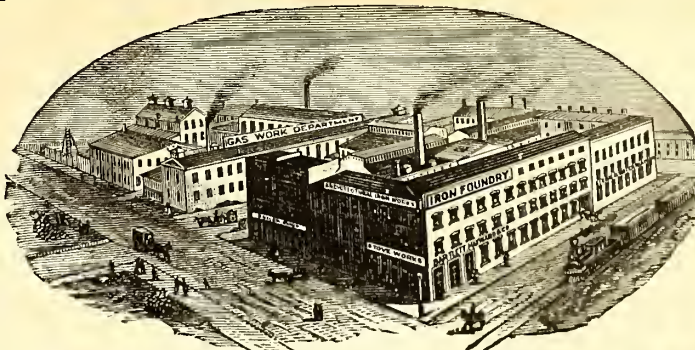

CONDENSERS.
BOILERS.
SCRUBBERS.

GASHOLDERS.

CONSTRUCTING ENGINEERS AND BUILDERS OF GAS WORKS.

1842. **DEILY & FOWLER,** 1885.

Laurel Iron Works.

Address, No. 39 Laurel Street, Philadelphia, Pa.

MANUFACTURERS OF

GASHOLDERS,

Single or Telescopic, with Cast or Wrought Iron Guide Frames.

HOLDERS BUILT SINCE 1880:

- | | | | | |
|--------------------------|-----------------------|----------------------------|---------------------------|-------------------------|
| Mount Joy, Pa. | West Point, N. Y. | Galveston, Texas (2d.) | Kalamazoo, Mich. (3d.) | Newport, R. I. |
| Rockaway B'ch, N.Y. (2) | Fitchburgh, Mass. | Marlboro, Mass. | Glen Island, N. Y. | Portland, Oregon. |
| Zanesville, O. (2d.) | New London, Conn. | Denver, Col. | Warren, Ohio. | Allegheny, Pa. (2d.) |
| Lancaster, O. | Derby, Conn. | Chicago, Ill. (West Side). | Bath, N. Y. | Atlanta, Ga. (2d.) |
| Blackwell's Island N. Y. | Bridgport, Conn. | Pittsburgh, Pa. (S. Side). | Lynn, Mass. | N.Y. City (Central Ga.) |
| Waltham, Mass., (1st.) | Allegheny, Pa. (1st.) | Pawtucket, R. I. | New Bedford, Mass. | Lynchburg, Va. (2d.) |
| Dorchester, Mass. | St. Hyacinth, Can. | Brookline, Mass. | Waterbury, Conn. | Rondout, N. Y. |
| Wheeling, West Va. | Norwalk, O. | Sherbrooke, Can. | Deseronto, Can. | Saylesville, R. I. |
| Lansing, Mich. | Waltham, Mass. (2d.) | Burlington, N. J. (2d.) | Hoosic Falls, N. Y. (2d.) | Atlantic City, N. J. |
| Flint, Mich. | West Chester, Pa. | Bridgeton, N. J. | Bethlehem, Pa. | Augusta, Ga. |
| Galveston, Texas (1st.) | Baltimore, Md. | Bay City, Mich. | Atlanta, Ga. (1st.) | Waltham, Mass. (2) |
| Milton, Pa. | Holidaysburg, Pa. | Erie, Pa. | Savannah, Ga. | |
| Scranton, Pa. | | Jackson, Mich. | Montgomery, Ala | |

GAS COALS.

GAS COALS.

GAS COALS.

JAMES D. PERKINS.

PERKINS & CO.,

F. SEAVERNS.

General Sales Agents for

The Youghioghenny River Coal Company's**OCEAN MINE YOUGHIOGHENY GAS COAL.**

The Coal from the Ocean Mine (recently operated by Messrs. W. L. Scott & Co., of Erie, Pa.,) is now used by all the leading Gas Companies in the United States from Maine to Texas, and is recognized as *the only reliable Youghioghenny Gas Coal.* (See Map on p. 87 of this Journal, Feb. 16, 1885.)

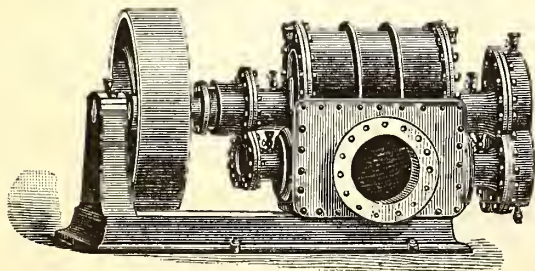
P. O. Box 3695,
New York.**PERKINS & CO., 228 and 229 N. Y. Produce Exchange**BEAVER STREET
ENTRANCE.

Gas Exhauster Driven by Belt.

The Wilbraham Gas Exhauster,
"BAKER SYSTEM,"

WITH ENGINE ATTACHED, ON SAME BED PLATE OR WITHOUT.
Best, Cheapest and Most Durable Exhauster known.

WILBRAHAM BROS.,

No. 2320 Frankford Avenue, Philadelphia, Pa.

F. J. DAVIS & J. R. FARNUM,

TRUSTEES AND AGENTS FOR THE

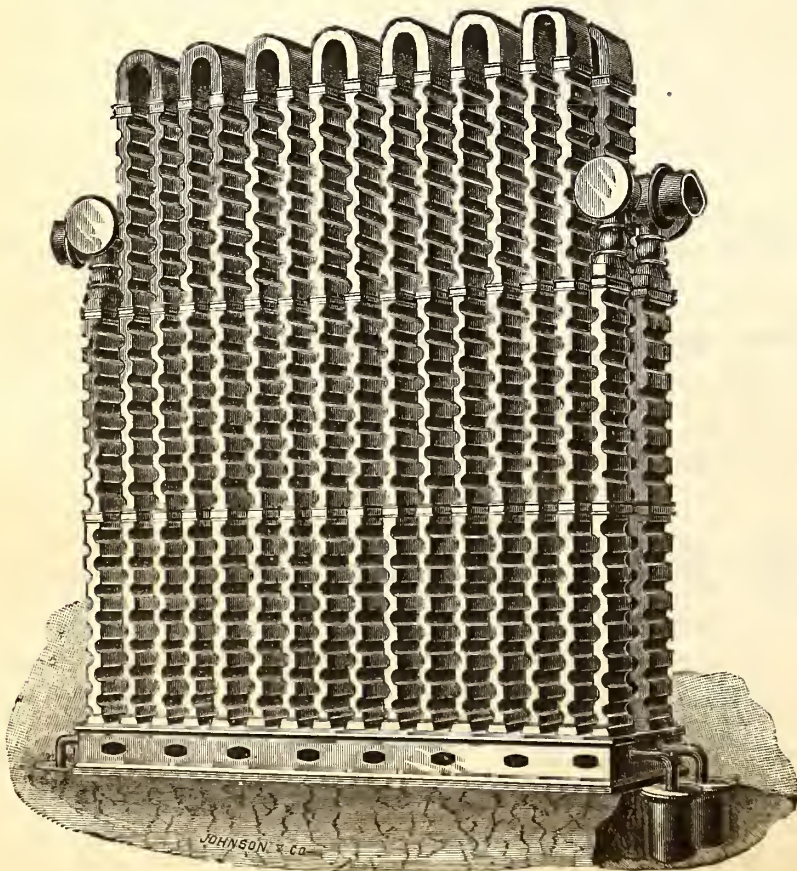
SINUOUS FRICTION CONDENSER.

We desire to draw the attention of the gas community to the merits of the **SINUOUS FRICTION CONDENSER.** Companies intending to introduce new condensers into their works will do well to confer with us and examine plans and estimates before contracting for any other pattern. The **FRICTION CONDENSER** is now in use at the gas works located in the following places:

Portland, Me.	Brookline, Mass.	Pawtucket, R. I.	Frederickton, N. B.
Newport, R. I.	Chelsea, Mass.	Jamaica Plain, Mass.	St. John, N. B.
Gloucester, Mass.	Woburn, Mass.	Attleboro, Mass.	Paterson, N. J.
Newton & Water- town, Mass.	Peoria, Ill.	Calais, Me.	Dover, N. H.
	Clinton, Mass.	Fall River, Mass.	Waltham, Mass.
		Nassau Works, Brooklyn, N. Y.	

DAVIS & FARNUM MFG. CO.

MANUFACTURERS OF

Gas and Water Pipes,

AND

GAS AND WATER MACHINERY

OF THE MOST APPROVED PATTERN.

Also, Gasholders and Iron Roofing.

Orders from Gas and Water Companies promptly attended to.

WALTHAM, MASS.

Boston Office, Room 55, Mason Building, 70 Kilby Street.

GAS COALS.

GAS COALS.

GAS COALS,

Newburgh Orrel Coal Co.,

MINERS AND SHIPPERS OF

**Newburgh Orrel, Tyrconnell
and Palatine Gas Coals.**

ALSO SHIPPERS OF FOUNDRY COKE.

Mines Situated at

Newburgh, Flemington & Fairmont, W. Va.

HOME OFFICE,

25 S. Gay St., Baltimore.

**CHARLES MACKALL,
MANAGER.**

CHAS. W. HAYS, Agent in New York,

Room 92, WASHINGTON BUILDING, No. 1 Broadway.

Shipping wharves at Locust Point. References furnished when required. Special attention given to chartering vessels.

THE DESPARD COAL COMPANY

OFFER THEIR SUPERIOR

DESPARD COAL

To Gas Light Companies and Manufacturers of Fire Clay Goods
Throughout the Country.

ROUSEL & HICKS, } AGENTS. { BANGS & HORTON,
71 Broadway, N. Y. } 16 Kilby St., Boston.

Mines in Harrison Co., West Va. Wharves, Locust Point, Balt.

Company's Office, 15 German St., Baltimore, Md.

Among the consumers of Despard Coal we name: Manhattan
Gas Light Co., N. Y.; Metropolitan Gas Light Co., N. Y.; Jersey
City, (N. J.) Gas Light Co.; Washington (D. C.) Gas Light Co.;
Portland (Maine) Gas Light Co. Reference to them is requested.

WELSH "ABERNANT"

Silica Dinas Fire Brick & Cement.

Unrivalled for Endurance Under Intense
Heat. Percentage of Silica, 95.64.

Also SCOTCH "BLOCHAIRN" FIRE BRICK.

A. T. CHUR,

SOLE AGENT FOR THE UNITED STATES,

Mills Building, Room 14, Fifth Story, New York.

PRESERVE

The Journal

BY THE USE OF

THE STRAP FILE.

Advantages of the Strap File.

- 1st. It is simple, strong, and easily used.
- 2d. Preserves papers without punching holes.
- 3d. Will always lie flat open.
- 4th. Allows any paper on file to be taken off without disturbing the others.

Price, \$1.25. Sent either by express or mail, at directed. By mail the postage will be 20 cents, which will be added to the price of the Binder.

A. M. CALLENDER & CO., 42 PINE ST., N. Y.

**THE
PENN GAS COAL CO.**

OFFER THEIR

Coal, Carefully Screened & Prepared for Gas Purposes.

Their Property is located in the Youghiogheny Coal Basin, near Irwin and Penn Stations on the Pennsylvania Railroad, and on the Youghiogheny River.

Principal Office:

209 SOUTH THIRD STREET, PHILA., PA.

Points of Shipment:

Pennsylvania Railroad Piers; Greenwich Wharves, Delaware River; Pier No. 1 (Lower Side), South Amboy, N. J.

Chesapeake & Ohio Railway Coal Agency,

FOR THE SALE OF THE

**Superior Kanawha Gas Coals, Cannelton Cannel,
Also, SPLINT AND STEAM COALS,**

From the Kanawha and New River Regions, on the line of the Chesapeake & Ohio R'way.

C. B. ORCUTT, Sales Agent. | OFFICE, 150 BROADWAY, N. Y.

FRANCIS H. JACKSON, PRESIDENT.

EDMUND H. MCCULLOUGH, SEC. & TREAS.

THE WESTMORELAND COAL CO.

Chartered 1854.

**Mines situated on the Pennsylvania and the Baltimore
and Ohio Railroads, in Westmoreland County, Penn.**

POINTS OF SHIPMENT:

PHILADELPHIA, BALTIMORE, SOUTH AMBOY, N. J.
WATKINS (SENECA LAKE), N. Y.

Since the commencement of operations by this Company its well-known Coal has been largely used by the Gas Companies of New England and the Middle States, and its character is established as having no superior in gas-giving qualities, and in freedom from sulphur and other impurities.

Principal Office, 224 South 3d St., Phila., Pa.

The Bower Gas Lamp.

**The Perfected Duplex-Regenerative Gas Burner, under
the combined Patents of Anthony S. Bower,
Geo. S. Grimston, and Thos. Thorp.**

The First Gold Medal awarded at the Crystal Palace Exhibition in London, and two Gold Medals at the Stockport (Eng.) Exhibition of Gas Appliances. Both in 1883.

GEO. SHEPARD PAGE, JOHN BOWER,
69 Wall Street, N. Y. City.

The Management of Small Gas Works.

By C. J. R. HUMPHREYS. Price, \$1.

A. M. CALLENDER & CO., 42 Pine St., N. Y.



INTERNATIONAL--1876--EXHIBITION.

The U. S. Centennial Commission

HAVE DECREED AN AWARD TO

HARRIS, GRIFFIN & CO.,



Twelfth and Brown Streets, Philadelphia, Pa., No. 49 Dey Street, N. Y. City, and No. 75 North Clinton Street, Chicago, Ill.,

FOR THE FOLLOWING REASONS :

The Exhibit consists of a Series of METERS from the Largest Size Station Meters for the use of the MANUFACTURE OF GAS, to those for the use of the ORDINARY CONSUMER. The Instruments are WELL MADE, RELIABLE as to INDICATION, and embody a number of sundry improvements which, with the general character of the Exhibit, entitle the whole to commendation.

Attest—J. L. CAMPBELL,
Secretary, pro-tem.

Signed—A. T. GOSKORN,
Director General

J. R. HAWLEY,
President

CHARLES E. DICKEY.

JAMES B. SMALLWOOD.

CHARLES H. DICKEY.

Maryland Meter and Manufacturing Co.,

DICKEY, TANSLEY & CO.,

Established 1866.

Nos. 22 and 24 Saratoga Street, Baltimore, Md.

No. 46 La Salle St., Chicago, Ill.

MANUFACTURERS OF

DRY GAS METERS, STATION METERS, GLAZED METERS, TEST METERS, METER PROVERS, PRESSURE AND VACUUM REGISTERS, GOVERNORS, INDICATORS, SERVICE AND METER COCKS, AND METER CONNECTIONS.

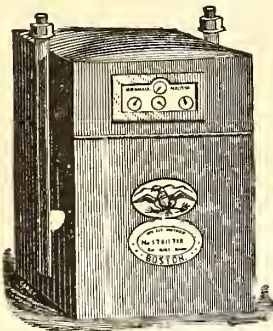

Dry Gas Meter.

With 39 years' experience and the best facilities for manufacturing, is enabled to furnish reliable work and answer orders promptly.

NATHANIEL TUFTS,

No. 153 Franklin Street, Boston, Mass.,

MANUFACTURER OF

DRY GAS METERS.

Station Meters of any Capacity.

Test and Experimental Meters, Pressure Registers, Pressure Gauges, Pressure and Vacuum Gauges.

METER PROVERS, PHOTOMETERS, STREET LANTERNS, ETC., ETC.

Patent Cluster Lanterns for Street Illumination.

SCIENTIFIC BOOKS.

We are prepared to furnish to Gas Managers, and others interested in the topics treated of, the following books, at prices named :

<p>KING'S TREATISE ON THE MANUFACTURE OF COAL GAS. Three vols.; \$10 per vol.</p> <p>GAS MANUFACTURE, by WILLIAM RICHARDS. 4to., with numerous Engravings and Plates, in Cloth binding. \$12.</p> <p>THE GAS ANALYST'S MANUAL, by F. W. HARTLEY. \$2.50.</p> <p>ANALYSIS, TECHNICAL VALUATION, PURIFICATION, and USE OF COAL GAS, by REV. W. R. BOWDITCH, M.A.; with Engravings; 8vo., Cloth. \$4.50.</p> <p>GAS MEASUREMENT AND GAS METER TESTING by F. W. HARTLEY. \$1.60</p> <p>GAS CONSUMER'S HANDBOOK, by WILLIAM RICHARDS, C.E.; 18mo., Sewed. 20 cents.</p>	<p>GAS CONSUMER'S MANUAL, by E. S. CATHELS, C.E. 10 cts.</p> <p>PRACTICAL TREATISE ON HEAT, by THOMAS BOX. Second edition. \$5.</p> <p>GAS WORKS—THEIR ARRANGEMENT, CONSTRUCTION, PLANT, AND MACHINERY. \$8.</p> <p>COAL; ITS HISTORY AND USE, by PROF. THORPE. \$3.50.</p> <p>THE GAS WORKS OF LONDON, by COLBURN. 60 cents.</p> <p>THE GAS FITTER'S GUIDE, Showing the Principles and Practice of Lighting with Coal Gas, by JOHN ELDRIDGE. 40 cents.</p> <p>GAS WORKS, AND MANUFACTURING COAL GAS, HUGHES. \$2.20.</p> <p>THE MANAGEMENT OF SMALL GAS WORKS, by C. J. R. HUMPHREYS. \$1.</p>	<p>A PRACTICAL TREATISE ON GAS AND VENTILATION with Special Relation to Illuminating, Heating, and Cooking by Gas, by E. E. PERKINS. \$1.25.</p> <p>PURIFICATION OF COAL GAS, by R. P. SPICE. 8vo. \$3.</p> <p>HOW TO MANAGE GAS, by F. WILKINS. Paper. 20 cents.</p> <p>THE GAS MANAGER IN THE LABORATORY, by a Practical Student. 8vo., Cloth. \$1.50.</p> <p>THE DOMESTIC USES OF COAL GAS, AS APPLIED TO LIGHTING, by W. SUGG. \$1.40.</p> <p>DISTILLATION OF COAL TAR AND AMMONIACAL LIQUOR, by GEO. LUNGE. \$8.50.</p> <p>A TREATISE ON THE COMPARATIVE COMMERCIAL VALUES OF GAS COALS AND CANNELS, by D. A. GRAHAM 8vo., Cloth. \$3.</p>
--	---	---

The above will be forwarded by express, upon receipt of price. We take especial pains in securing and forwarding any other Works that may be desired, upon receipt of order. All remittances should be made by check, draft, or post office money order.

A. M. CALLENDER & CO., No. 42 Pine Street, New York.

T. C. HOPPER, Pres. G. J. McGOURKEY, Vice-Pres. (New York). WM. N. MILSTED, Gen. Supt. & Treas. (New York). WM. H. DOWN Sec.

AMERICAN METER COMPANY,

WET AND DRY GAS METERS.
STATION METERS.
EXHAUSTER GOVERNORS.
DRY CENTRE VALVES.
GOVERNORS FOR GAS WORKS.

PRESSURE REGISTERS.
PRESSURE & VACUUM REGISTERS.
PRESSURE & VACUUM GAUGES.
CRESSON GAS REGULATORS.
MARSLAND WATER METERS.

METER PROVERS.
PORTABLE TEST METERS.
EXPERIMENTAL METERS.
AMMONIA TEST METERS.
BAR AND JET PHOTOMETERS.

Manufactories:
512 W. 22d St., N. Y.
Arch & 22d Sts., Phila.

GAS STOVES,
SUGG'S "STANDARD" ARGAND BURNERS,
SUGG'S ILLUMINATING POWER METER,
Wet Meters, with Lizar's "Invariable Measuring" Drum.

Agencies:
177 Elm Street, Cincinnati.
244 & 246 N. Wells Street, Chicago.
810 North Second Street, St. Louis.
122 & 124 Sutter St., San Francisco.

HELME & McILHENNY,

(Successors to Harris & Brother. Established 1848.)

GAS METER MANUFACTURERS,

CONTINUE AS HERETOFORE AT THE OLD ESTABLISHMENT,

Nos. 1115 and 1117 Cherry Street, Philadelphia, Pa.,

To Manufacture Wet and Dry Gas Meters, Station Meters, Experimental Meters, Meter Provers, Center Seals, Pressure Registers, GOVERNORS, INDICATORS, PHOTOMETERS, & ALL OTHER KINDS OF APPARATUS FOR USE IN GAS WORKS.

From our long practical experience of the business, and from our personal supervision of all work, we can guarantee all orders to be executed promptly, and in every respect satisfactorily.

WM. WALLACE GOODWIN, Prest. and Treas.

WM. H. MERRICK, V.-Prest.

S. L. JONES, Sec.

S. V. MERRICK, Supt.

THE GOODWIN GAS STOVE AND METER COMPANY,

Successors to W. W. GOODWIN & CO.

1012, 1014 and 1016 Filbert St., Phila., Pa. 142 Chambers St., New York.
76 Dearborn St., Chicago, Ill.

WALDO BROS., Agents, 88 Water St., Boston.

MANUFACTURERS OF THE "SUN DIAL" GAS STOVES, FOR COOKING AND HEATING PURPOSES.

Dry and Wet GAS METERS, Station Meters (Square, Cylindrical or in Staves) Glazed Meters, King's and Sugg's Experimental Meters, Lamp Post Meters, Etc., Etc., Meter Provers (sizes 2, 5 and 10 feet), Pressure Guages of all kinds, Pressure Registers, Pressure and Vacuum Registers, Pressure Indicators (sizes 4 inch, 6 inch and 9 inch), King's Pressure and Vacuum Gauges, Dry and Wet Centre Seals, Dry and Wet Governors, Exhauster Governors, Photometers of all descriptions. Letheby's Sulphur and Ammonia Test Apparatus complete—also Testing and Chemical Apparatus of all kinds, and of the most perfect description, for all purposes relating to Gas.

GOODWIN'S IMPROVED LOWE'S JET PHOTOMETER.

Agents for Bray's Patent Gas Burners and Lanterns.

Special attention to repairs of Meters, and all apparatus connected with the business.
All work guaranteed first class in every particular, and orders filled promptly.

G. B. EDWARDS, Mang'r, New York.
E. H. B. TWINING, Mang'r, Chicago.
A. B. STANNARD, Agent.

D. McDONALD & CO., GAS METER MANUFACTURERS.

(Established 1854.)

51 Lancaster St., Albany, N. Y. 34 & 36 West Monroe St., Chicago, Ill.

STATION METERS, EXPERIMENTAL METERS, METER PROVERS, PRESSURE & VACUUM REGISTERS, PRESSURE GAUGES, ETC.

Also STAR GAS STOVES, RANGES, and HEATING STOVES.

We use only the very best materials, and employ the most skilled labor, and by our long experience (29 years) and personal supervision of every detail, we feel justified in assuring the public that our goods will give perfect satisfaction. Every Meter emanating from our establishment will bear the State Inspector's BADGE, and will be fully warranted by us. Our Annual and Calendar will be sent to Gas Companies upon application.

KING'S TREATISE ON COAL GAS.

The most complete work on Coal Gas ever published. Three vols., bound, \$30.

A. M. CALLENDER & CO., No. 42 Pine Street, New York,

THE GOODWIN GAS STOVE AND METER CO.,

1012-18 Filbert St., Phila., 142 Chambers St., N. Y., 76 Dearborn St., Chicago.

Agents, WALDO BROTHERS, 88 Water Street, Boston.

WM. W. GOODWIN, PRES. & TREAS.
W. H. MERRICK, VICE-PRES.
S. LEWIS JONES, SEC.
SAMUEL V. MERRICK, SUPT.

SOLE MANUFACTURERS OF THE

G. B. EDWARDS, Mang'r, N. Y.
E. H. B. TWINING, Mang'r, Chicago.
A. B. STANNARD, Agent.

"SUN DIAL" GAS STOVES

The Most Economical, Efficient, and Durable Gas Stove Made.

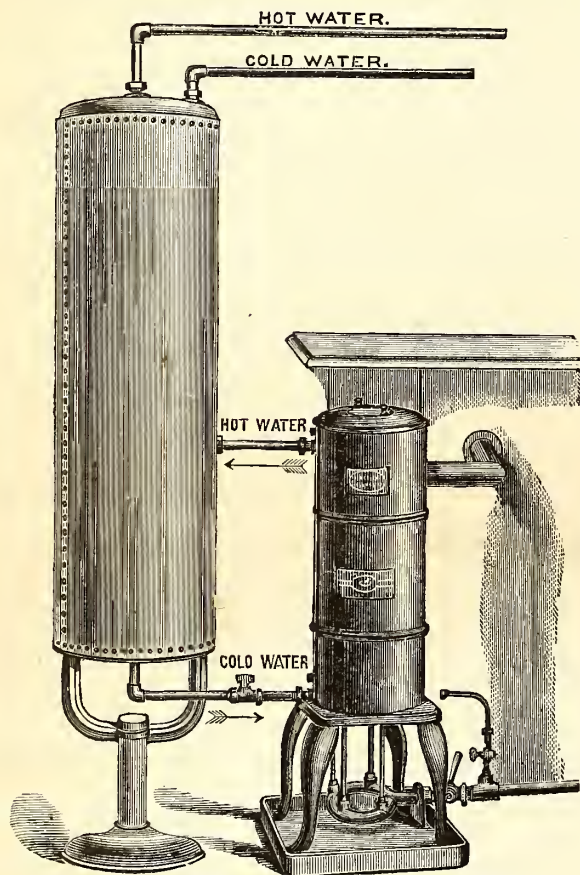

I.—Safety Hot Water Generator and Boiler.

Safety Hot Water Generator and Boiler.

Cut I. represents our Safety Gas Hot Water Generator and Boiler, arranged for home use. This most easy, quick, and economical way of preparing a warm bath, or for heating water for any domestic purpose, entirely supersedes any necessity for the use of ranges or stoves—a great comfort, particularly in hot weather. The boiler being self-filling, as the hot water is drawn off, can never become empty, thus preventing the possibility of any accident.

We beg to call attention to the cast iron pan which is now attached to the legs of the Generator (see illustration). This is to catch the drippings from the Coil, which many persons suppose come from a leak, when in fact they are produced by condensation. This condensation is caused by the hot flame coming in contact with the coil filled with cold water.

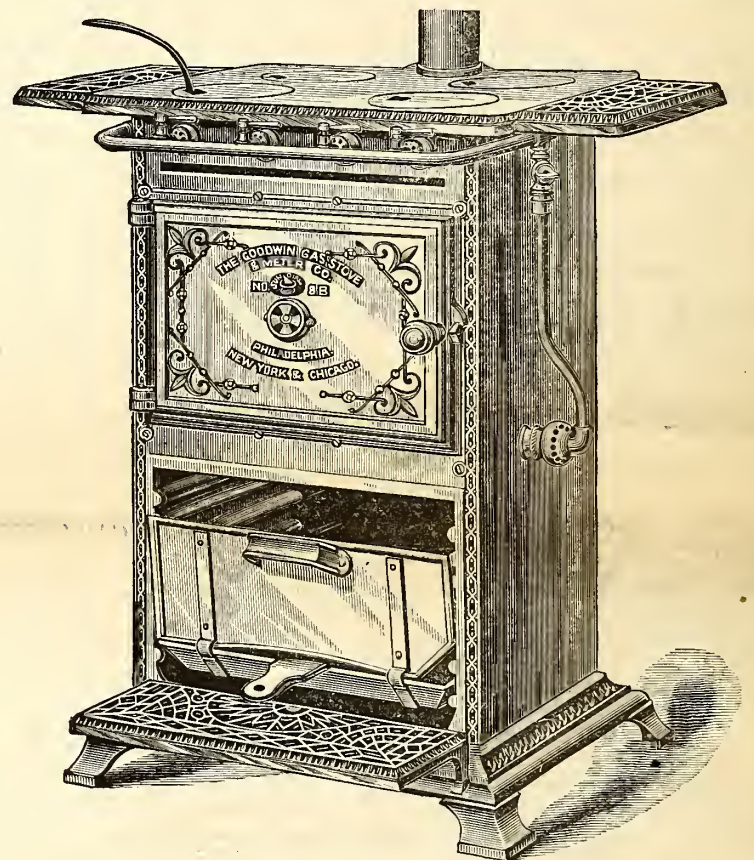

II.—Gas Cooking Stove No. 8 B.

New Style Gas Cooking Stove.

Cut II. represents our New Style Cooking Stove. As will be seen, it has an ornamented cast iron base and front, and extension shelves. The oven burner, which is atmospheric (unless otherwise ordered), is of an entirely new and improved pattern (patent applied for). The ovens are of greater capacity than those of the old style. The top, in conjunction with the outlet pipe, is designed to carry off all products of combustion; hence the outlet pipe must be connected with a flue, or the stove will not work properly.

This Stove has 4 boiling burners in top of hot plate. All fittings are nickel plated. We are making this style of Cooking Stove in the following sizes—viz., No. 7 B, No. 8 B, No. 9 B, and No. 10 B.

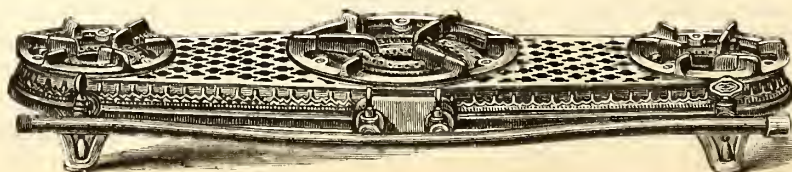

III.—Improved Hot Plate, No. 108.

New Style Hot Plates.

Cut III. represents our New Style of Hot Plates, of which we are making No. 106 (two small boiling burners), No. 107 (two medium sized boiling burners), and No. 108 (two medium and one large boiling burner). See new Catalogue and Price List for further particulars.

THE AMERICAN GAS LIGHT JOURNAL

PUBLISHING OFFICE No. 42 PINE STREET

DEVOTED TO THE INTERESTS OF ILLUMINATION, VENTILATION, WATER SUPPLY AND DISTRIBUTION, & GENERAL SCIENCE.

VOLUME XLIII.—No. 8.
Whole No. 632.

NEW YORK, FRIDAY, OCTOBER 16, 1885.

\$3 PER ANNUM
IN ADVANCE.

A. M. CALLENDER & CO., Proprietors. C. E. SANDERSON, Manager.
JOS. R. THOMAS, C.E., Editor.

ENTERED AT THE POST OFFICE AT NEW YORK, N. Y.,
AS SECOND CLASS MATTER.

Published on the 2d and 16th of each month, at No. 42 Pine Street, N. Y.

Terms of Subscription, Including Postage.—For the United States and Canada, \$3 per annum. European countries, \$3.50 (15 shillings—18 francs). All payments to be made in advance. Single copies, 15 cents.

Remittances should be made either by post-office order, registered letter, or bank draft on New York, payable to the order of A. M. Callender & Co.

Collections are invariably made directly from this office, for subscriptions, advertisements, etc. We have agents to solicit the same, but they are not authorized to receipt for money.

Correspondence.—Wishing to make this JOURNAL a gazette of intelligent discussion to those of our readers who may wish to gain or give information on the subjects to which its columns are devoted, correspondence is solicited for publication from all who make the study of those subjects a pleasure or a profession.

The American News Company, Nos. 39 and 41 Chambers street, New York, are agents for this JOURNAL. Newsdealers will send orders to them.

Books.—We will forward by express, at publisher's lowest rates, any book—scientific or otherwise—to any address in the United States or Canada. No books will be sent C. O. D.

CONTENTS.

An Asterisk (*) denotes an illustrated article.

OFFICIAL CIRCULAR—

American Gas Light Association..... 197

EDITORIALS—

Do Your Duty.....	198
Obituary Note—Dr. E. B. Woodruff.....	198
Report of Transactions, 1885 Meeting of The Gas Institute.....	198
The Market for Gas Securities	198
Some Notes on the "Novelties" Exhibition Now Being Held at Philadelphia, Under the Auspices of the Franklin Institute of Pennsylvania, by H. C. Adams.—Article No. II.....	199
The Lowe Gas Processes—The Lowe Manufacturing Company's General Exhibit—The Kendrick Incandescent Gas Lamp.....	
* The Effects of Heating Air upon Combustion.....	201
The New Works of the Australian Gas Light Company.....	204
The Peruvian Petroleum Field.....	205
An Experiment in Gas Making, and the Results Thereof, by Frederic Egner.....	206

ITEMS OF INTEREST FROM VARIOUS LOCALITIES..... 207

Mr. Fish, of the Utica (N. Y.) Gas Light Company, on the Subject of Electric Lighting—Up to their Eyes in Business—Coke Fuel and the Jarvis Furnace—Resolved to Increase its Capital Stock—New Exhauster to the Order of the Gas Trust—The Perils of Electric Lighting Wires—Acquiring Real Estate—They Made a "Proposition"—A New Gas and Electric Light Company—Personal—What Friend Harbison is Doing—The Furious Work of a Recent Cyclone.

The Test was Made..... 209

[OFFICIAL CIRCULAR.]

American Gas Light Association.

AMERICAN GAS LIGHT ASSOCIATION, }
Oct. 10th, 1885.

As this is the last opportunity I will have of addressing the members before we assemble in Cincinnati, I am anxious to take advantage of the occasion to emphasize the appeal I have already made to each and every gentleman on our roll call that he make every effort to be present at our coming meeting, and that he come in the full determination to do all that lays in his power to make our Thirteenth Annual Convention a grand success. If the verdict which the chronicler of gas matters is to pass upon our Cincinnati gathering were to be entirely dependent upon those gentlemen who have kindly consented to contribute papers to be read at the meeting, we could hardly expect it to proclaim the success of the convention in the unhesitating manner it might adopt, other things being equal, if each member were to feel that the nature of that verdict were dependent in great measure upon himself. While, as I have spoken of this matter in previous circulars, I do not now wish to amplify my remarks in this direction, I do desire to urge the members to avail themselves of the time remaining before the meeting to collect such data and information as they can anent the subjects to be discussed, and present them at the proper time to the Convention.

The subjects to be discussed are indicated by the following list of promised papers:

"Natural Gas," by W. H. Denniston.

"Stoking Machines," by M. S. Greenough.

"Improved Furnaces," by Austin C. Wood.

"The Result of a Month's Working with Limed Coal," by James Somerville.

"The Thermophote, or Self-registering Photometer," by T. O'Connor Sloane.

"The Present State of the Gas Business," by J. C. Pratt.

"Difficulties Encountered in the Construction of a Gasholder Tank," by Emerson McMillin.

"Automatic Street Main Governors," by William Enfield.

Other papers have been promised, and will probably be prepared in time for the meeting.

I have also received, through the courtesy of a foreign correspondent, a condensed translation of a German paper descriptive of some of the European furnaces.

In addition to these subjects we have the following questions to answer:

"Is canal or oil the cheaper enricher, taking \$9 a ton as the cost of the former and 5 cents a gallon the price of the latter?"

"Can largo gas burners successfully compete with the arc light?"

"How can the trouble from naphthaline be alleviated?"

"What is the proper position for gas exhausters?"

"Can the gas engine be successfully used to drive an exhauster?"

"What is the best means for removing tar from the gas?"

"Does a heavy setting of retorts require more coke to maintain the heat than a light setting?"

"What is the best and most expeditious mode of weighing coal, when discharged direct from vessel into store?"

"If, say, 4,000 tons of coal are stored for a year's supply, what is the average loss in weight when weighed again in retort house?"

"What is the relative illuminating power of coal gas, when tested simultaneously with the bar and jet photometer?"

"Why do burners, fed from the dead end of a gas main, stop up?"

"What is the most efficient, and easily cleaned, washer for removing lamp-black from oil gas, and where should it be placed?"

"What methods are in use for stopping leaks in clay retorts, under pressure, say, 5 to 6 inches, other than simply charging with coal after patching?"

From the foregoing it will appear we have a rather ample literary programme for our meeting; it is, therefore, more than ordinarily necessary that the members be prompt in assembling at the appointed times.

The first two days of the meeting will be devoted to business. The details of the third day are not yet completed; but a visit to the new station of the Cincinnati Gas Company will be included in the arrangements. Programmes, which will be distributed during the meeting, will give full particulars of the details of the Convention.

As before announced, the headquarters of the Association will be at the Gibson House; and the meetings will be held at College Hall, opposite the Hotel. The convention will be called to order by the President on Wednesday morning, the 21st inst., at 10 o'clock, and will continue through the two following days.

It has been suggested to me that at our yearly gatherings many members on reaching the headquarters of the Association are desirous of knowing just who have arrived; but there is no means of obtaining information on this score save from the hotel register, which is often incomplete, as some of the members stop at other hotels than that selected by the Committee of Arrangements. To meet this difficulty I will have at the Committee's room a register book, and will be obliged if members, as soon as convenient after their arrival in Cincinnati, will kindly register their names in this book.

Special arrangements have been made for the transportation of members from New York city and Boston. Special rates have been obtained from the New York Central and Hudson River Railroad for delegates going to the convention from New York city. Orders for these special tickets can be obtained from C. E. Sanderson, Esq., 42 Pine street, New York city. One of these orders will enable the holder to obtain from the railroad noted above a ticket from New York to Cincinnati and return at the reduced figure. The return coupons will be good until the 30th inst. The tickets will not be received on the limited train. The train which most of the members from New York will take leaves the Grand Central Depot at 6 o'clock Monday evening, the 19th inst., arriving at Cincinnati at 6:30 the following evening.

Special rates between Boston and Cincinnati have been obtained from the Boston and Albany Railroad. Orders for these special excursion tickets can be obtained from the Secretary; the return coupons of these tickets will likewise be good to the 30th inst. The train which most of the Boston members will take leaves the Boston and Albany Depot at 3 P.M., Monday, October 19th. This train joins at Albany to the train leaving New York for Cincinnati at 6 o'clock the same evening. The two trains combine at Albany and form one train from there to Cincinnati.

Parties wishing to join the Association can obtain the proper blanks by applying to the Secretary.

C. J. R. HUMPHREYS, Secretary,
Box 6, Lawrence, Mass.

DO YOUR DUTY.

It may be taken for granted that close scrutiny has been given to Secretary Humphreys' final note of warning in regard to the Cincinnati meeting, and it is also presumably certain that the members of the American Gas Light Association have resolved to perform their entire duty in connection with the approaching convention. This year the excuse cannot be advanced that the topics for discussion were not announced in time sufficient to afford ample scope for study of their salient features.

Besides the presentation of specially prepared papers on stated subjects, Secretary Humphrey's circular enumerates a list of questions to be proposed and answered during the sessions. To the end that the replies may have real value we would urge the importance of searching through your records in the endeavor to fortify your opinions by the presentation of unimpeachable facts and figures. Do your entire duty, then, and grumble not at the slight labor involved in making the investigation, since, if all come fitly prepared, each member is certain to be amply repaid in the enlightenment gained by him from listening to a recital of the researches of others.

OBITUARY NOTE.—DR. E. B. WOODRUFF.

It is with sincere sorrow that we find ourselves placed under the necessity of announcing to the fraternity the demise of Dr. E. B. Woodruff, President of the Morristown (N. J.) Gas Light Company, who answered the summons of the grim reaper at midnight of Sunday, October 4. The deceased was born in Mendham, Morris County, N. J., on the 22d day of November, 1814, and arriving at that period of his youth when it became necessary to make choice of the avocation or profession that should be followed in maturer years, he decided to fit himself for the duties and obligations attaching to the life of a physician. Accordingly he entered the College of Physicians

and Surgeons, then a celebrated academy of New York city, and in due course of time emerged therefrom eager to accept the responsibilities of his new sphere in life. Our young graduate returned to his native township and speedily established an excellent practice, gaining a reputation in his profession second to none other then enjoyed by his brother practitioners of that day and locality. About the year 1845 Dr. Woodruff removed to Morristown (Mendham is about 7 miles west of Morristown), and in that beautiful and historic place passed the remaining years of a truly happy life. Shortly before becoming a resident of the latter town the Doctor had resigned from the ranks of practicing physicians on account of certain commercial ventures which demanded the full measure of his attention in order that the same might be carried to the point of complete success. At beginning of year 1855 many of the residents of Morristown considered that the appearance of the local field presented sufficient encouragement for the establishment of a gas company, and the subject of this obituary note was prominent in the ranks of the agitators of the project; indeed, we might venture the assertion that years might have elapsed before the scheme was carried out were it not for Dr. Woodruff's persistence in the matter. Be that as it may, the "Morristown Gas Light Company" was chartered on February 19, 1855, with Dr. Woodruff as one of the charter members; and it goes without saying that the new venture had the full benefit of his advice, together with the advantage of his substantial pecuniary assistance. In 1876 deceased was elected to the Presidency of the corporation, which office he occupied uninterruptedly up to the time of his demise. He was also a charter member, and lately had been elected to the Presidency of, the Board of Trustees of the Evergreen Cemetery Association—Morristown's local burying ground. Deceased was a prominent member and regular attendant at the services of the congregation worshipping in the structure known as the South Street Presbyterian Church. A daughter and three sons survive him, one of the latter (Francis E.) enjoying the distinction of being one of the members of the commission of three Americans selected by the Chinese Government and employed by that Power in its Custom House at Canton. The funeral services were celebrated at the former residence of deceased on afternoon of Thursday, October 8, and it needed but a glance at the assembly to reveal what niche was occupied by the lamented dead in the hearts of his associates and fellow-townsmen. Dr. Woodruff had been a resident of Morristown for upward of 40 years; and that surely should afford ample time wherein to find him out. To his memory let it be said he was found out, in that everyone who knew him was his friend. While essentially a domestic man, in so far as he loved the quiet comforts of the home circle, he was in no sense a recluse, as his active participation in local matters shows. No smile was more affable nor greeting more kindly than his; and although he lived to the allotted age of three score and ten his demise will be none the less keenly felt.

Report of Transactions, 1885 Meeting of The Gas Institute.

We cannot forbear making mention of the commendable despatch displayed by Mr. W. H. Bennett, Secretary of the English Gas Institute, in editing and causing to be published in such short order the "Transactions of the Gas Institute for 1885," a copy of which has been received by us. The volume comprises an official record of the doings of the Institute, including therein the report of the council; an obituary note on the late M. Servier, former editor of the *Journal des Usines a Gaz*; President Newbigging's annual address—which was properly characterized by our English correspondent, in his letter of July 10th (see JOURNAL, Aug. 3, p. 66), as a "masterpiece of presidential addresses, both in respect to the soundness of its facts and the elegance of its composition;" the several papers read (with the discussions thereon) accompanied by handsome illustrations, and valuable statistical tables; the volume terminating in a mass of interesting matter relating to the Institute, such as membership lists, rules, etc. Owing to pressure on our columns we have this year been unable to adhere closely to our usual practice of reprinting the papers read at the Institute meetings, and in view of that fact any of our subscribers desirous of obtaining a copy of the "Transactions" may order the same through us, enclosing the sum of \$4.40 in payment therefor.

In noticing the "Transactions" it would hardly be fair to omit mentioning that the get up and typography of the work have received full justice at the hands of the printers, Messrs. King & Sell, Fleet street, London.

The Market for Gas Securities.

Consolidated gas (after advancing to 98½ since time of last writing) has had a set back in value, which decrease is accounted for by some on the ground of sales by insiders. The lowest figure recorded during the fortnight was 95½, though bulk of transfers were made between 96 and 97½. Other city shares show an advance. Mutual Company has declared and paid a regular quarterly dividend of 2½ per cent. Brooklyn shares are fairly steady. We note that Fulton Municipal Company to-day pays a quarterly dividend of 3 per cent. The state of market may be characterized as sluggish.

Some Notes on the "Novelties" Exhibition Now Being Held at Philadelphia, Under the Auspices of the Franklin Institute of Pennsylvania. (ARTICLE No. II.)

By H. C. ADAMS.

THE LOWE GAS PROCESSES.

The production of illuminating gas from coal by destructive distillation had scarcely been demonstrated to be a commercial possibility before experiments were begun with a view of supplanting that process by a cheaper and better one. Although that experimentation has continued uninterruptedly for nearly three-quarters of a century, there has never been brought forth a system that has shown itself, after practical and sufficient test, to be superior to the coal gas process. Some of these patent methods and appliances have produced a richer gas, others a cheaper gas, and there have been many improvements; but when all the requirements essential for the best production, distribution, and consumption of gas, with regard to the interests of both producer and consumer, have been considered, these newer processes have been found wanting. Many of them have enjoyed a short, meteoric career of splendor, but have sooner or later sunk into obscurity and disuse. Such is the teaching of the history of gas making.

Nearly all of these promised successors of coal gas have had oil in one form or another as their principal factor. The richness of a direct oil gas necessitated its mixture with air or other diluting gas, and finally resource has been had to what is called water gas as the most practical diluent. The principal difference, and very nearly the only one, between the most prominent water gas processes of to-day lies in the method of delivering the oil to the gasifying chamber; and hence, when we have described one system we shall, neglecting a few minor details, have described the theory and practice of all.

At the "Novelties" Exhibition the Lowe Manufacturing Company, of Norristown, Pa., display the inventions of Mr. T. S. C. Lowe. Prominent among those is a complete fuel gas plant, which will now have our attention. At the northeastern corner of the Exhibition building, in the end of what is called the boiler house, we find the Lowe apparatus. The essentials of a water gas plant are (1) a generator and (2) a superheater. Originally those two pieces were separated in the Lowe system, but lately they have been combined into a single piece of apparatus, which, as shown at the Exhibition, is a cylindrical sheet-iron stack, 20 ft. high and 4 ft. in diameter, lined with firebrick. About 18 inches above the bottom of this stack is a water grate, with an ashpit below it, into which opens a door to permit of removal of the ashes, etc. Half way up the stack is a charging hole, worked from an elevated platform to which the coal is hoisted. The portion of the stack between the charging door and the grate is called the generator. Just above the charging door there extends across the stack a brick arch perforated with vertical flues, to make communication with the generator. Above the arch firebricks, set with interstices between them, are placed. This portion of the stack, from the arch upward, is called the superheater. At the top of the superheater a valve, opening to the outer air, is set in the cap of the stack.

In order to proceed with gas making a fire is built in the generator, which is filled from the charging door with an 8-foot bed of egg-size Lehigh or other good, hard, anthracite coal. Then the ashpit and charging doors are closed, and, the valve at the top of the stack being open, an air-blast is applied at the bottom of the grate. The bed of coal is thus brought up to a cherry-red incandescence, which process is known as "blowing up." The resultant gases, of which the principal is carbonic oxide, are met as they pass up from the coal by another air-blast, injected just below the superheater arch, and called the superheater blast, and are burned off, making, of course, an intense heat which raises to a bright-red heat the mass of firebrick in the superheater, through which the burning gases ascend. The products of combustion pass out by the valve at the top of the stack. When the coal reaches the proper degree of incandescence, and a proper heat appears in the superheater, the blast is shut off, the valve at the cap of the stack closed, and the process of gas making proper is begun. Steam is now injected through a $\frac{1}{2}$ -inch pipe at the top of the superheater; it passes down through the glowing mass of brick, and is highly superheated; then it descends through the bed of incandescent coal, where it is broken up—the hydrogen being liberated and the oxygen uniting with the carbon to form, first, carbonic acid, and finally carbonic oxide, owing to the absorption of another atom of oxygen by the carbon of the coal. The resultant is a pure water gas, composed of hydrogen and carbonic oxide in about equal proportions. This passes off through an outlet below the grate of the generator, and travels a few feet to another sheet iron cylindrical stack, 4 ft. in diameter and 12 ft. high, which constitutes the washing and scrubbing apparatus. The lower section of this stack is the washer, which is simply a tank of water 3 or 4 ft. deep, into which the gas seals after the manner of delivery into a hydraulic main. At the top of the washer, just below the surface of the water, is a sheet iron diaphragm, around the sides of which the gas makes its way to the scrubbing chamber above, filled with coke through which a fine stream of water percolates in the orthodox manner. Then the gas is passed to the purifier, which is here a box

4 by 6 ft., with a 30-inch seal, filled with iron sponge; this is supplemented by an adjacent tank of milk of lime. The holder stands just without the boiler house; it has a capacity of about 5,500 feet, and seals into an enormous cedar tank containing about 180 tons of water.

The capacity of this plant is estimated at 5,000 feet an hour; at present it is making about 20,000 feet per diem. The heats we have described last about 15 minutes, reckoning from the time the blast is shut off and the steam put on. They claim to get 3,000 to 4,000 feet "to the heat."

So far we have spoken only of pure water gas, or fuel gas, as it is called by the Lowe Co. At the Exhibition a portion of this gas, after leaving the holder, is passed through a system of carburetters, consisting of galvanized iron boxes containing a suitable light oil; the gas in traversing these boxes takes up a portion of the oil, and is then burnt like ordinary gas in various kinds of burners. This carbureting is not a specific exhibit, but is done to show the relation of fuel gas to illuminating gas.

The Lowe carburetted gas, as made ordinarily in the works now using that process, is produced with a slight change from the working we have described for fuel gas. Instead of steam being injected at the top of the superheater, it is let in below the grate of the generator, and in passing up through the coal its elements become dissociated and arise from the top of the bed as hydrogen and carbonic oxide. Just below the superheater arch a piece of ordinary gas pipe is passed into the stack through a stuffing-box, to permit of its withdrawal when the fire is being blown up. Through this pipe oil, preferably naphtha, is allowed to flow to the interior of the stack in quantities varying from a trickling dribble to a full stream, according to the results desired, and depending on the candle power and quantity of the gas to be made. No force other than a slight gravity pressure is used to drive the oil into the stack. As soon as the oil enters it is volatilized, and the vapors are picked up by the water gas rising from the coal. These then pass up into the superheater, where they are converted into a fixed gas; and from the top of the superheater they are delivered to the washer, scrubber, and purifiers. The worth and efficiency of the process are, of course, to be determined by its comparative economy, which is so entirely dependent on circumstances as to make it impossible to give an exact statement. Its chief factors are the cost of oil, coal, and labor. It is claimed theoretically that 1,000 feet of 20-candle gas can be made from 40 pounds of coal and 4 gallons of oil; and that 100,000 feet of gas per man per day can be made in large works! We do not believe that those results are approached even under the most favorable conditions in actual practice. In our limited experience we have met many instances where practice fell sadly behind such figures; and we have never met one instance of their complete fulfillment. The question of the suitability of this gas for domestic consumption has been so thoroughly discussed in the JOURNAL that it needs no mention here.

THE LOWE INCANDESCENT GAS LIGHT.

Nearly all investigators in the field of illumination, whether by gas or by electricity, have sought for a substance that, while admitting of practical manipulation, would suffer incandescence in air without resulting consumption. The greatest activity in this research has been, of course, displayed by the electricians, for its success most intimately concerns their lighting systems of to-day. So far have they been from solving the problem that it has been well-nigh given up, and the direction of the work changed toward obtaining a substance that will go only so far as not to disintegrate under continued incandescence in vacuo. The status of the duration and efficiency of the best incandescent lamps to-day show how far the second attempt has succeeded.

With these few prefatory remarks we can appreciate the worth of a discovery of a practicably indestructible vehicle for incandescence in air, and one that combines with indestructibility the other qualities essential for the emission of a light that may be utilized economically. That, and no less than that, Mr. Lowe claims to have accomplished in his incandescent burner. Careful investigation of such a claim is necessary before it can receive acceptance. The data essential for an opinion is so hedged in with mystery that we can give only the results of superficial observation. The burner is, as has been recently stated in the JOURNAL, simplicity itself. It is but a spiral of wire, in the form of a horseshoe, set over the tip of an ordinary gas burner. The spiral, which forms a half circle, is supported by a backbone wire whose extremities attach to a horizontal base consisting of a strip of sheet brass, with an opening at its center, to give it a seat on the burner tip just below its top. The tip is fed with Lowe fuel gas, which, as has been shown, consists of gases of little or no illuminating power, but of great calorific intensity. The spiral of wire is arranged in the plane of the slot of the burner and of the sheet of gas issuing therefrom. When the burner key is turned and the fuel gas ignited, it strikes the spiral as it ascends, and brings it in a moment to an incandescence that quickly reaches its normal intensity. In the burners at the Exhibition the diameter of the half circle which the spiral describes is about $1\frac{1}{2}$ in., and hence the luminous arc is about 2 in. in length, the width of some being about $\frac{1}{2}$ in. The tip used with these is a nominal 2-ft. one, burning in practice 4 or 5 ft. That

size, it is claimed, gives a light of 15 candles! The length of the spiral depends, of course, on the size of the tip used; for the radius of the half circle which it describes must always be of such length as to bring the wire in the line of most intense combustion in the flame. In viewing the mechanical construction of the burner we are at once struck with the fact that, in order to have proper and full incandescence, the spiral must sit *exactly* in the plane of the slot of the burner and of the flame issuing therefrom. Should the wire not be properly adjusted when placing it on the tip, or should it subsequently be warped out of position by the action of the heat, or other means, the full efficiency is at once lost. It is very rarely that any of the 12-burner incandescent clusters at the Exhibition can be inspected, when in action, without finding 2 to 6 of the spirals partially dead; and the single spirals on the brackets and chandeliers in the rooms are frequently discovered to be only half in action. Apparently they need constant attention so that they may be kept at their normal efficiency. Again, should a slight, but steady, draught, sufficient to divert the flame from a direct vertical path, blow upon the burner, the incandescence falls to a dull glow kept alive by the indirect action of the adjacent flame. We should state, by-the-way, that all the incandescent spirals at the Exhibition are naked—*i. e.*, not enclosed by any description of globe. It was desired to give a cut of the burner in connection with this description; but Mr. Lowe, with proper and pardonable jealousy of so great an invention, does not allow any of the burners to pass out of his possession. Great curiosity and interest center in the composition of the metal composing these spirals. It is commonly supposed to be some alloy of platinum, and that is probably pretty close to the truth. As yet no careful and scientific tests have been made, so far as we know, to determine how far the metal does approach indestructibility. All the evidence gleaned in that direction lies in the statement made by the Lowe Company, that some of the spirals have been in use, off and on, say as we would use an ordinary jet, since last January; that others have had an actual average use of 2½ hours per night for three months; and that none of those showed appreciable deterioration. Of course, nothing definite can be said, yea or nay, on the question until the metal has been submitted to systematic and scientific test. The theoretical 15-candle spiral is to be sold at a price of \$1. With an indestructible burner at \$1, and fuel gas at 50 cents, such a stupendous economy is discovered as almost to betray its origin. The quantity and the tone of the light emitted are all important considerations. And here, having had our expectations wrought up to the point of "a new rival of the electric light," we experience rather a painful mental tumble; and when we alight with a bump upon the ground of hard facts, we begin to wonder what all this talk has been about. It is, of course, almost impossible to say, from observation by the eye alone, what the actual candle power of these spirals may be. One is much impressed by the apparently small quantity of light emitted from a single spiral. It would seem that with the present intensity a much larger radiating surface is needed. When the lights are burning in clusters and re-enforcing each other, that is not so evident; but when a single spiral is seen in one of the rooms the paucity of its light is very striking. The incandescence seems far too low; and if we may perpetrate an execrable pun, we will say that it is so.

In appearance the light affords a small luminous arc, of the dimensions given above, ornamented by small radiating horns of fuel gas, resulting at times in a rather weird effect. In tone the light emitted is of a dull red-dish yellow. That effect is much intensified by contrast, for Mr. Lowe has unfortunately placed his lights alongside of the Siemens and Lungren lamps. The comparison is almost too much for the red-hot poker glow of the incandescent gas light.

Whether a higher intensity of incandescence is compatible with indestructibility we cannot say. The emission of a clearer, whiter light in such incandescent gas lights as the Fahnehjelm, where the magnesia comb is used with splendid effect, is had at the cost of comparatively rapid consumption. We do not see that with his present light Mr. Lowe has made a notable advance over the many other appliances which have been designed to utilize the intense combustion of water gas for lighting purposes. We observe that in his system at the Exhibition each spiral is removed, carefully cleaned, and readjusted or replaced daily; and that the operation of "lighting up" consumes about two hours each afternoon. If no more and no better light can be produced from a given amount of apparatus than is obtained at the Exhibition, the incandescent light will not approach, much less surpass the quality and economy of the effect derived from our ordinary illuminating gas. A poor light is not desirable even if it be ever so cheap; and with every desire here, as always, to "give the devil his due," we are constrained to say that the Lowe incandescent light at the Exhibition is poor. To those who looked for a new and brilliant departure in gas lighting, it is a most intense disappointment.

THE LOWE MANUFACTURING COMPANY'S GENERAL EXHIBIT.

The Lowe Manufacturing Company make a very extensive and noticeable display. In the eastern end of the Exhibition building they occupy the

rooms that were last year enclosed for the Brnsh Electric Company. The first of these is a parlor illuminated by one 12-light chandelier and two single brackets on the incandescent plan; next in line is a dining-room, and last comes an office opening upon the eastern aisle. All of these rooms are handsomely fitted up, and all contain the incandescent light. In the parlor is an open fireplace, where a series of fuel gas jets play upon a back of some refractory, asbestos-like substance, giving a glow of striking resemblance to the adjacent lights. Two devices shown in the office deserve mention—one is a method of conducting the products of combustion from a cluster light burning in a room on one floor, up to a heater or radiator in a room above; the other is the burning of a cluster light on a pedestal surrounded by a globe inclosing the light, the products of combustion from which are carried down by a central flue to the base of the pedestal, which is constructed as a heater; and after circulating through that are taken to some convenient outlet. The fuel gas is also used in the ranges of the restaurant at the Exhibition, and also in some baker's ovens in the main hall. To the north of the series of rooms just mentioned is an exhibit of the Lowe ranges, stoves, etc. These are similar to the ordinary make, save that the gas is delivered direct to the pipes, and no Bunsen burners are used. In fine, the Lowe exhibit shows creditable and praiseworthy enterprise, that might be profitably imitated by other manufacturers of gas apparatus.

THE KENDRICK INCANDESCENT GAS LAMP.

The Kendrick incandescent gas lamp, the invention of Mr. I. Kendrick, of Philadelphia, is exhibited in the booth of the Pennsylvania Globe Gas Light Company. This lamp is of unique construction, and embodies a peculiar principle. The gas from the delivery pipe of an ordinary bracket, upon which the lamp can be readily placed, enters a small cylindrical chamber at the bottom of the lamp. From that three branch pipes diverge at equal distances apart, and ascend vertically to an annular chamber, like the gas chamber described in the Wassermann lamp, upon which the lip—a circle of orifices—is directly set. From the top of the cylindrical chamber into which the gas first enters is a vent into a vertical pipe that ascends through the center of the lamp to a point about an inch below the main tip; near the bottom of this central pipe is a series of orifices to admit air, and at its top is a suitable tip to give the effect of the Bunsen burner. Extending up from this tip is a cylinder of porcelain, which reaches to the height to which the illuminating flame from the outer burner is supposed to play—some 2½ inches. The upper half of the lamp is surrounded by a cylindrical clear glass chimney, from whose upper edge, hanging by a suitable lip, there extends down to the top of the flame a concentric, cylindrical piece of porcelain. This gives a closed annular space above the flame, which is supposed to act as a cushion and regulate, or rather steady, the action. Within this annular space is an outlet direct to the air.

Around the outside of the annular gas chamber, and extending up to the top of the burner orifices, is a draught collar of sheet brass, designed, by means of an inward curve at its top, to deflect upon the flame the air ascending through the outer portion of the body of the lamp. The whole of the lower part of the lamp is encased in a jacket, perforated at the bottom to give outlet to the air.

The operation of the lamp can be readily understood. When the supply cock is opened the gas enters the cylindrical chamber at the bottom of the lamp, and part of it ascends through the three branch pipes to the gas chamber, and thence to the tip of the main or primary burner, where it is ignited and burns with a flame shaped like the ordinary Argand. The rest of the gas ascends the central pipe, mixing with air as it does so, and upon issuing from the Bunsen burner it is ignited by the heat of the flame of the primary burner. We should have stated above that the lower portion of the porcelain cylinder set upon the Bunsen, or secondary cylinder, is cone-shaped, so as to deflect the products of combustion outward upon the main flame. The object of the secondary burner in the center of the lamp is to create a draught of air up through the central passage, and to heat it before it reaches the inner side of the flame, which it is supposed to feed. There is no attempt to pre-heat the gas, save to a slight degree where it enters the gas chamber surrounding the secondary burner.

The flame of the main burner burns up around the central porcelain cylinder, and gives a band of light, in the 10-foot lamp, about 2½ inches high. The light is clear and steady, but it does not seem much whiter than an ordinary gas jet would be with a porcelain backing. However, the burner at the Exhibition is using machine gas, which makes it difficult to gauge. It is claimed that when working with proper efficiency it gives 8 candles to the foot. The lamp has just issued from the workshop, and has not yet been put upon the market. At present three sizes are made—5, 10, and 15 feet; but as soon as the lamp is brought out it is proposed to extend that list considerably. As has been shown, and as its name sets forth, this lamp is not regenerative in principle, but apparently depends upon the incandescence of the central cylinder to intensify the light. We believe that any lamp that uses an extra amount of gas to supply a secondary or auxiliary burner to pre-heat the air supply, and at the same time allows a current of highly

heated products of combustion to pass off unutilized from the chimney, is false in theory; but then, as we learn every day, theory and practice do not always bear each other out. The truth of the case here can, of course, be demonstrated only by experience. The Kendrick lamp, although exhibited by the Pennsylvania Globe Gas Light Company, is the property of the Incandescent Gas Lamp Company, of Philadelphia.

The Effects of Heating Air upon Combustion.

By WILLIAM GADD, C.E., of Manchester.

[A paper read before the 1885 meeting of the British Gas Institute. Reprinted from the *Journal of Gas Lighting*.]

I think I may safely assume that most of the professional gentlemen here present are somewhat familiar with the series of articles which I had the honor to contribute to the *Journal of Gas Lighting* some little time ago, upon the subject of heating air in regenerator furnaces. These articles were the outcome of an investigation into the subject, which was first suggested to me by your learned President, in consequence of the controversy started by Mr. Valon at your last meeting; and I may here state that but for that controversy it is highly improbable that I should have been before you today for the purpose I have in view.

I may say that the investigations I made, for the articles alluded to, caused me to doubt certain conclusions which seemed to have become accepted without demur; and, as a consequence, I have been working at the subject of heated air practically from that time to the present.

In the furnaces and burners of modern times it has been the object to heat the air used for combustion to the highest point possible, by means of the waste gases, as it has been desired to return as much of the waste heat from the products of combustion back to the furnace as is practicable. How much or how little of this is accomplished I do not now intend to consider; but I desire to point out the somewhat obvious fact that, whether we return a given portion of this heat by means of air to the furnace, or whether we prevent to the same extent its escape, in the first instance, by way of the chimney, the real effect is simply to conserve the heat for useful purposes instead of allowing it to radiate into the open air or surrounding objects. It is well to bear in mind this somewhat axiomatic truth in the consideration of what I shall now have the honor of putting before you.

It has, I think, been generally accepted that heated air brought to a furnace or burner causes the temperature of the flame therein to rise, not only on account of the augmentation of temperature of the same by the heat brought forward in the air, but also that this heated air, by raising the temperature of the flame, directly intensifies combustion. This belief is largely exemplified by the numerous regenerative lamps and furnaces which so carefully make provision for the heating of air. I am quite aware that some investigators have, in the case of lamps at least, expressed the suspicion that some of the effect produced is due to the heating of the gas; nevertheless, this seems at best to have been thought to occupy only a secondary place of usefulness.

I may say that for a considerable period, on purely theoretical grounds, I have strongly doubted the value of heated air, at ordinary pressure, as a means of intensifying, or causing more perfect combustion; and the investigation already referred to strengthened these doubts to an enormous extent. An observation made by Mr. H. B. Dixon, in connection with some experiments on a certain regenerator burner, in which he found that a small quantity of cold air let in at the bottom or lower part of the lamp much increased the intensity, produced a strong impression upon my mind, and confirmed the views I had formed. I therefore resolved to devise some simple experiment which would determine the point.

Many methods were tried, all of which showed in some degree the expected result, and strengthened the belief in the discovery which theory pointed out; but I desired to formulate some method which should make the conclusions unmistakable and plain. This, at last, I was able to do, by finding a peculiar phenomenon of flame, which I term "a balanced flame of imperfect combustion." In this I recognized the means for what I conceive to be complete demonstration of that which I had long suspected—namely, that, so far from the heating of air in passages, at constant or ordinary pressure, increasing combustion, it actually retards or renders combustion more imperfect. I will try and show why this is so, and will, by the aid of the diagram, describe the simple experiment which demonstrates it, and afterward repeat the experiment to such as may be able to see it, as this may be difficult, on account of the smallness of the apparatus employed; while all may, with ease, construct their own apparatus, and repeat the experiment at leisure, on any scale they may prefer.

First, I will point out that combustion, termed a chemical operation, is really a mechanical phenomenon of a certain order, wherein—in the case, say, of combustion of carbon—we have two molecules of oxygen combining with one of the fuel. Now, it is clear that if we have, in any volume of carbon, x number of molecules, we require $2x$ number of molecules in the vol-

ume of oxygen, or, in chemical phrase, two volumes of oxygen, to form perfect combinations, or, in other words, perfect combustion. Thus, if our arrangements only allow x number of molecules, or one volume, of oxygen, we have resulting an imperfect combination or combustion in the form of carbon monoxide. Although, in practice, the imperfection of combustion is not necessarily uniform, as one portion may result in carbon-dioxide, another in carbon-monoxide, and a third as escaping carbon.

The application of heat to the gases expands them; expansion meaning, not an increase in the size of the atoms forming the molecules, but an increasing of their distances apart from one another. Hence when air, or any other gas, is expanded, there is a less number of molecules in a given measurement. It therefore follows that with a given size of air passage to an inclosed furnace or flame, at a constant pressure, a more perfect possibility of combustion results from the admission of cool air than when the same is heated, as cool air contains, in each cubic measurement, a far larger number of molecules of oxygen than is the case when in a heated condition at the same pressure; in other words, is denser, as is well understood.

The amount of heat evolved, at a given intensity, from a given quantity of carbon, entirely depends upon how many of the molecules of carbon obtain their requisite two of oxygen; and when every molecule obtains its desires, perfect combustion ensues, all the possible molecules of the compounds have been formed, and that fills the measure of heat capable of being evolved.

The air passages of a regenerator furnace or lamp will give one of three results: Either they will supply an insufficient amount of air at a given pressure and temperature; or they will supply the exact amount; or they will introduce an excess of air over and above that which is required for the production of perfect combination or combustion.

If we take the cases of either an exact amount, or a not quite sufficient amount, or even slightly over the amount required to produce perfect combustion, when supplied at ordinary temperature and constant pressure, any heating of the same, prior to contact with the fuel, has exactly the same result as that of reduction of pressure at constant temperature, and at once renders the combustion less perfect. I am aware it is often assumed that the force of expansion produces increased speed in the passages; but this is not so, as the force of expansion takes effect equally in every direction. Therefore the pressure forward, due to expansion in the passage, is balanced by the pressure backward, due to the same cause; with the result that the volume of air travels forward at constant speed under constant pressure, according to the rate of combustion, although it may be expanded to the highest degree (the conditions being quite different to the heating of a column of air in the open).

The experiment will demonstrate this clearly, and a little thought will show that it must be so, as the expansion of the air by heat results in a less number of atomic particles to the measured volume, while the pressure remains constant to that volume.

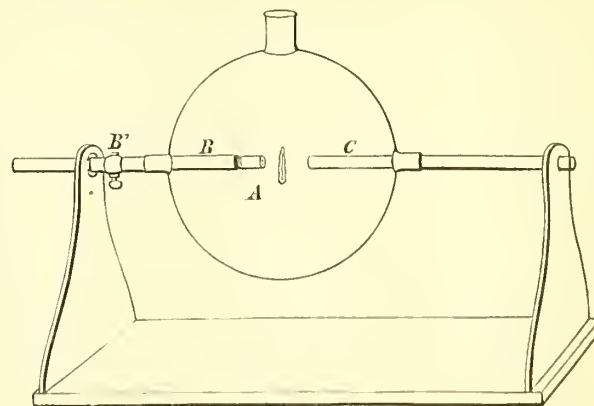

The apparatus necessary for the experiment consists of a three-way vessel receiver A, which is composed of glass for convenience of observation. One way is fitted with a tube B, carrying the gas supply, and another and opposite way is fitted with a tube C, for the air supply. This latter tube is kept always open, and thus constant in the area exposed to the pressure of the atmosphere; while the tube for gas is provided with a tap or other regulator B', to enable the supply of fuel to be adjusted to the supply of air. The third way forms an outlet for the products of combustion and unburnt or incompletely burnt fuel. This outlet is covered by a disc with a small opening therein, just allowing space for the outflowing current; otherwise down draughts of air will take place, vitiating the results. This, indeed, has been the source of error in many experiments, as it is not always sufficiently recognized that down draughts of air may set up in a chimney, which is supposed to be solely occupied in carrying of the products of combustion. Now, when all other sources of oxygen are cut off than that through the tube C, no combustion of the gas will take place until the two meet; and if the pressure of gas be just regulated to balance the pressure of air, we shall see the peculiar and beautiful phenomenon already alluded to, of a flame balanced

midway between the two orifices for fuel and air. A little more or less pressure or supply of gas, turned on or off at the tap, will move this flame either farther away from, or permit it to approach nearer to, the burner. The nearer the flame is produced to the burner, or, in other words, the sooner the gas takes fire, the more perfect is the combustion; while the farther away from the burner the flame is, or the later the gas takes fire, the less perfect is the combustion. It also follows that when the increased or diminished combustion takes place, the fact is plainly observable to the eye, both in the size and brightness, as well as the position of the flame.

Having obtained this balanced flame, as near as may be, half way between the burner and the air tube (and which I may observe will require a little practice to manipulate), we are ready to proceed with experiments thereon.

Firstly, a Bunsen burner is placed at any convenient point underneath the air tube, when, as the same becomes heated up to the point of delivery, and consequently heats the air passing through it, the balanced flame is observed to move toward the air tube, farther and farther away from the gas supply. At the same time it becomes less in size, until it finally, when sufficient heat is obtained, fixes itself on the orifice of the air tube, giving the appearance of air burning in gas, rather than gas burning in air, and is brought down to a very small bead of flame indeed, although the heat obtained or retained in the air at the point of contact is by no means great. When the Bunsen is removed, and time given for the tube to cool, the flame slowly and gradually expands and recedes from the air tube, until it assumes, when the air reaches the former temperature, its original position. It may be here remarked that the experiment incidentally proves that air can be and is heated in its passage through the tube by the act of showing its results on the flame.

By applying the Bunsen to the other tube B, we are enabled to see the result arising from the heating of the gas or fuel. This is again what I had inferred from theory, and is, in fact, the inverting of the former experiment, which gives exactly the reverse conditions to the heating of air. By heating the gas or fuel we reduce, by expansion, the amount of fuel supply, precisely as we before reduced, by like expansion, the supply of air; which heating of the gas is, relatively, equivalent to increasing the supply of air to cool gas. The consequence is that the balanced flame moves in the other direction, and increases both in size and combustion; and if the fuel is much rarefied by heat at great intensity, will set up a vortex motion, which greatly assists the more intimate mixture of air and gas in the operation. It only needs to add, in describing the experiment, that, having obtained the best combustion by heating the gas, the same is lessened again by heating the air in conjunction with such heated gas, exactly as I concluded from the theory herein described.

In that truly valuable book, "King's Treatise on Coal Gas" (the editing of which was so ably performed by your President), we have the received views upon the heating of air, and also of gas, faithfully and accurately set forth and recorded. The chapter written by Mr. R. H. Patterson, in the third volume, is a specimen of conscientious writing, combined with careful thinking, upon the facts and materials at his command. He plainly and frankly puts forward his difficulties, and shows that recorded experimental results are, to him, in many respects, contrary to what might naturally be expected. He comes to the conclusion, from experimental evidence, that the heating of air assists combustion, although from theoretical considerations he expected the reverse. Again, he concludes from like evidence that the heating of gas is of no value, although, on theoretical grounds, this would appear to be a beneficial preparation. His conclusions on the subject may be found on p. 184 of the third volume, and will now be doubly interesting to read.

I think the experiment I have brought to your notice will show the actual and practical results to be really and perfectly in accord with theory; and Mr. Patterson may have the satisfaction of knowing that although he yielded for the time to the supposed evidence of certain experiments, his scientific instincts were, after all, the more reliable guide.

In most forms of combustion we can deal with there are two important considerations of heat—that is to say, there is the heat of evolution, and the heat of transference. The heat of evolution is the direct result of the chemical combination of the particles of carbon, or hydrogen, or their compounds, with the particles of oxygen. The heat of transference is chiefly that which is transferred from these particles to the neutral or passive substances present, either in the fuel or in the supporter of combustion at the time, or in both. In the case of combustion in atmosphere this transferred heat bears an enormous proportion to the total heat evolved. Some idea of this proportion may be obtained by comparisons with heated substances which are familiar. Suppose we take three gallons of water, at boiling point, and add thereto eight gallons of cold water at 32°, mixing the whole together. We shall not find any great heat then in the water, so far as intensity is concerned, although the quantity—neglecting radiation and conduction—will be there all the same. The eleven gallons will reach no higher temperature than 81°, which is a considerable reduction from 212°.

The same process of conversion of intensity into quantity occurs during

combustion in air. If we take the case of burning ethene (C_2H_4), known as olefiant gas, we require for the purpose three volumes of oxygen, or 15 volumes of air. There are thus employed sixteen volumes of these two substances, four volumes only of which are engaged in producing or evolving heat. Hence, there are twelve volumes of nitrogen which have to be raised in intensity by, and thus lower the temperature of the four active volumes; forming an equilibrium of the total mass far below the heat of evolution. This may be expressed by supposing ethene to be perfectly burnt in air, and to attain a temperature thereby of 3,000°. If we grant this supposed figure, the same gas burnt in undiluted oxygen, by measured volume, would attain an energy equal to a temperature of 11,820°.

Now, if this twelve volumes of inert passive gas could be raised in temperature prior to combustion, and from an independent source, there is no doubt that 4,455° would be attained, in place of 3,000°, when burnt in air, provided—and here lies the important consideration—perfect combustion should still be possible under the altered circumstances.

But in the case of both furnaces and burners or lamps, the heat for raising the temperature of the air has to be abstracted from themselves, so that, *per se*, it is the same thing whether the heat is directly transferred at the moment of evolution, or, indirectly to the incoming air, prior to evolution. Nevertheless, if this heat (or any part of it) would by necessity be otherwise wasted, a gain might accrue by such prior heating, if nothing else occurred to nullify the result. I learn, however, from the experiment now before me, that heating the supporter of combustion retards or renders such combustion more imperfect; while heating the fuel assists or increases such combustion to a great extent. Both these results proceed from the same cause—namely, the relative expansion of their volumes. The relationship of volumes differ, of course, with the different fuels used; hence the variation in the degree of perfection with which different substances burn in the atmosphere. If we take, again, the case of olefiant gas, the volumes of fuel and air stand as 1 to 15. Now, if we could expand the 1 of fuel to the size of the 15 of air without altering the latter, I conceive we should attain the highest combustion possible, assuming the best temperature of the 15 to be found, as I do not necessarily suppose this to be the ordinary temperature.

I conclude, therefore, that the heating of air at constant pressure *alone*, for combustion purposes, is a decided loss. To heat both air and fuel, at ordinary pressure, provided the latter is already in the gaseous state, will give an advantage over cold fuel and air, or over heated air alone. For, although relatively the two volumes are not altered, there is greater facility for the two gases to combine, the less dense the fuel is; the advantage gained, however, being due to the expansion of the fuel alone, so far as actual combustion is concerned. Finally, heat applied to the gaseous fuel alone, so as to bring its measured volume as near as possible to that of the required volumes of air, at such temperature as may be found best for the purpose, will, I doubt not, give the greatest economy of all. Such being the clear outcome of both experiment and theory.

The condition of things involved in gaseous firing by secondary combustion is one which favors more than another the heating of air—or, more correctly speaking, is one which is the least unfavorably affected by the process, for the reason that combustion therein being a divided operation, the air for the purpose is admitted at two separate stages, giving time for the expansion of the fuel in the monoxide form. The two volumes of fuel and air, therefore, stand in the secondary furnace as 1 to 5, in consequence of only requiring one molecule of oxygen—a degree of discrepancy which, in its comparative smallness, has doubtless had much to do with the possible economy attained in this way.

To heat the air under pressure, as in the case of the hot blast, becomes highly advantageous, as the two volumes are thereby relatively altered in value to the extent of the pressure on the air; added to which the large mass of air, in present practice at least, allows of much heat being restored to the furnace.

It is no part of my intention in this paper to enter into the question of the amount of heat capable of being conveyed by the air from the waste gases—that has been, to a great extent, dealt with in the articles already alluded to; but to point out that as the conveying of this heat is a work which interferes seriously with the efficiency of the carrier, in performing its legitimate and far more important function of supporting combustion, it will, therefore, be well to seek for a more satisfactory means of retaining the heat within the furnace or flame, or of returning it thereto, as the case may be. Thus, though the present system involving the heating of air has been a step in the path of progress, it will be seen that there are greater possibilities still to be attained, the pursuit of which, I believe, will result in examples of both gas lighting and gas-furnace firing far superior to anything which has, up to the present, been accomplished.

Discussion.

Mr. W. Sugg (London) said he rose to ask a question which might assist the discussion. In the beautiful experiment which was shown on the diagram there did not seem to be any indication of the thermometer having

been placed in the interior of the bulb to indicate the temperature. Mr. Gadd said he warmed the air and gas by means of a Bunsen burner at the end of the pipe; but, unless one knew the temperature in the globe, one could not form any idea of the temperature of the air when it issued from the aperture inside the globe.

Mr. C. Hunt (Birmingham) said the members would all be prepared to accept the accuracy of the experiment Mr. Gadd had been kind enough to show them, and it was not difficult to understand that, under certain conditions, heated air might retard combustion; but the practical question was, how did this affect matters which were of importance to them?—how, for example, did it affect the action which took place in a regenerative furnace, or support the conclusion Mr. Gadd had arrived at? In order to answer this question it would be necessary to ask another—viz., what were the proofs of perfect combustion that would be acceptable to Mr. Gadd? He took it that if they analyzed the waste gas, and found no trace whatever of carbon in a combustible form, but rather a slight excess of oxygen, then there was perfect combustion. These conditions were found by analysis to prevail in a properly regulated regenerative furnace; and therefore he maintained that heated air was no detriment whatever to its action in the manner suggested by the author of the paper.

Mr. J. P. Leather (Burnley) said this was a most remarkable paper. It was remarkable because Mr. Gadd deduced from theoretical considerations an opposite conclusion to that which he should deduce from those theoretical considerations; and he gave an experiment which proved the very opposite to that which he concluded from it. He said that in heated air there were fewer molecules in a definite volume. This was perfectly true; but as long as the pressure remained the same, it was made up for by the speed at which they traveled, according to the ordinary kinetic theory of gases. If the absolute temperature of the air were doubled, the speed of the molecules and the number of times which they impinged on the molecules of the fuel were doubled; and, consequently, the intensity of the combustion was increased. Then he compared the decrease in the density of the gas by reducing the pressure. Now, it was well known that, by the reduction of pressure the luminosity of a flame was decreased; but this did not apply in the present case, because it was compensated for by the increase in the speed of the molecules of the air. Next came the question of the experiment. He took it that heating the air increased the intensity of combustion, as also heating the gas did. When the air was heated the flame approached the air naturally, because this was the place where it could burn quickest. Then Mr. Gadd said there was incomplete combustion, and the flame became small. Of course it did, because the gas drove the flame back, and some of it escaped unburnt. But let him take it the other way about. When he heated the gas and not the air the flame approached the gas, because there the combustion was more intense and quicker—there the combustion of the gas was perfect, and the combustion of the air imperfect. But it was imperfect in both cases, not because of the heat, but because the heat really produced more intense and quicker combustion in each case. These considerations seemed to him to nullify all the conclusions of the paper.

Mr. C. W. Folkard (Chiswick) thought the result of the experiment was capable of easy explanation. When the air was heated there was still the same chimney draught, and therefore the same volume, but less weight of air (because it was more highly expanded) was available for combustion. Under these circumstances, as Mr. Leather had pointed out, the combustion of the gas was necessarily imperfect, because there was not enough air supplied. If Mr. Gadd were to supply the same weight of air under all circumstances—in the one case heating it, and in the other not—the experiment would be perfectly fair. It was analogous to the case of supplying producer gas. If a cubic foot per minute of such gas were supplied to do a certain amount of work, a low temperature would be obtained, and a much lower temperature than with a cubic foot of coal gas; but if a sufficient quantity of producer gas were supplied, any required temperature might be obtained. He would ask Mr. Gadd how he would explain the action of the Siemens regenerator furnace for steel making. The air there was only under the drag of the chimney; but there was not the slightest doubt that a greatly increased temperature was produced by heating the air before combustion. As to the hot blast under pressure being under different circumstances altogether, he could not think it was so; for, although the pressure at which the hot blast was supplied might be 2 pounds or 3 pounds per square inch above the atmospheric pressure, compressed air, when subjected to heat, expanded quite as much as air at ordinary atmospheric pressure.

Mr. J. P. Leather (Burnley) asked permission to add a fact which elucidated this question. Many years ago he saw an experiment of this character performed by Professor Thorpe. When the air admitted to an ordinary Bunsen burner was heated, it produced luminosity in the Bunsen flame, even although the quantity of air was not diminished, but the flame became actually smaller. It was well known that, if the air supply to a Bunsen burner were stopped, the flame became luminous but larger; but in the present case the flame became smaller when supplied with hot air, but

more luminous. It was a different kind of luminosity to the ordinary luminous flame of gas, and was due to the much greater intensity of combustion in the flame.

Mr. W. Foulis (Glasgow) said the paper was perhaps a little too scientific for him to discuss; but there were one or two phenomena to which he would ask Mr. Gadd's attention, and which might have some effect in altering his opinion. It was very well known that, in the Siemens regenerative burner, when the burner was first put on (before it was heated up), the combustion was exceedingly imperfect, and the flame had to be turned down to prevent carbon being deposited. Gradually, as the air was heated up, the combustion became more and more perfect. In all regenerative furnaces that he knew of, where coal gas was used, both the air and the gas were heated. Where the gas was already at a high temperature, as is the case with gas made from coke, there was no necessity for heating it; but in the case of coal gas it was heated. The experiment to which the author seemed to attach so much importance had already been sufficiently commented upon by previous speakers. By heating the air in the tube, the quantity which found its way into the bulb was diminished; but if the size of the tube were increased in proportion to the expansion of the air, the whole of the results would be altered. In making a regenerator furnace or burner for practical purposes the flues were made large enough to take in hot air sufficient to supply the flame. Mr. Gadd concluded that heating the air at constant pressure alone for combustion purposes was a decided loss; but if it were the case, as stated in the paper, that, by heating air, facilities were obtained for the combination necessary for combustion, then if they had a sufficient supply of air, and at a high temperature, they must have more perfect combustion, and a higher flame temperature, than when using cold air. There seemed to be some confusion of ideas with reference to heating air under pressure or under blast. Without entering into this question, he wished to point out that, when the hot-blast furnace was first introduced, the pressure was only about 1 lb. or 1½ lbs. above the atmosphere—a pressure which was not sufficient to account in any way for the benefits which were undoubtedly derived from the heating of the air.

Mr. D. Bruce Pæbles (Edinburgh) suggested that to make this apparatus complete a small gasholder should be employed, both for the air and for the gas, in order to insure constant pressure. If this were done something like reliable data might be obtained. In this case there was a simple opening to admit the atmospheric air, while the gas had a definite pressure applied to it. If the same pressure were applied to both air and gas, measured quantities of each might be taken, and the action of the apparatus would be much more reliable and complete.

Mr. Sugg remarked that the discussion must be very much limited by the fact that there was no indication of the temperature inside the bulb. It was perfectly clear that, under ordinary circumstances, the temperature of the issuing air must be the same as the temperature at the end of the tube inside the bulb. It did not matter what was done to it outside, especially with such small quantities.

Mr. D. T. Livesey (Aldershot) asked if Mr. Gadd adopted any means for ascertaining whether there were complete or incomplete combustion. The luminosity or non-luminosity of flame was, he said, not sufficient.

Mr. W. Carr (Halifax) asked whether Mr. Gadd deduced from this experiment the conclusion that the aggregate of heat obtained was not increased by the heat of the air supplied for combustion. If so, it was contrary to all his previous experience. With reference to the effect of heated air on the luminosity of flames, it became very much a question of the mechanical conditions by which the flame was surrounded. In the case of regenerative burners, they knew the illuminating power increased as the air supplied was increased in temperature; but whether it was owing to the heat or to the conditions being more favorable at the time the heat was obtained (the burners being constructed for this purpose), they did not know. This, however, he did know—from watching the flame of one of these burners over and over again—that when first lighted there was some difficulty in obtaining combustion; but this arose from the fact that the draught had not been established in the burner. When the chimney became hot, and the draught was established, the flame burnt vigorously at first with the cold air getting to it, and its luminosity was somewhat low. As the heated products of combustion passed through the burner, and the air supply became hotter, the length and luminosity of the flame increased as the operation went on, until the burner attained its maximum effect. The question of obtaining heat for the purpose of heating retorts and the distillation of coal was the most important; and his idea had always been that if they took a quantity of fuel matter, in the form of gas or otherwise, at a certain temperature, and the air supplied for the combustion of that fuel at a given temperature, they obtained a certain heat result from the products of combustion. If they doubled the temperatures of both the fuel and the air they would get a very much greater effect, for the simple reason given by Mr. Leather, that ignition and combustion took place with much greater activity and velocity at a high than at a low temperature. They had first to deal with the initial tem-

perature of the gas and of the air; then they had the heat of combustion added to these. Whatever the temperature might be at the beginning, the results were higher if the heats were higher to begin with; and the resultant temperature must necessarily be the heat of combustion *plus* the heat of the gas and fuel to commence with.

Mr. Denny Lane (Cork) thought that a little confusion had arisen from the employment of two words which had frequently caused some confusion before—the words, “heat” and “temperature.” They were two totally different things. “Heat” meant the total quantity of calorific energy developed; and “temperature” meant the degree at which it was developed. There could be scarcely a doubt that if they took any combustible and burnt it efficiently the whole quantity of heat added to any heat they had before would be precisely the same, no matter at what temperature the combustible was burnt. The temperature would, of course, be raised if they began with the combustible hot and the supporter of combustion also hot. The heat produced was that arising from combustion *plus* the temperature previously existing in the combustible and in the agent that supported the combustion. He did not think any change in the temperature at which this was conducted could in any way increase or diminish the actual quantity of heat developed by the combustion. It simply made a difference in the temperature.

Mr. C. Gandon (Sydenham) said he should like to mention the case of a burner which seemed to give results rather contrary to the contention of the author of the paper, being simply a double cylinder Argand burner with the lower end of the outer cylinder closed, so that the air to supply combustion had to pass between the two cylinders, and thereby become heated. He could well remember trying the burner on several occasions. When first lighted, and before the air became hot, with a certain consumption of gas a definite height of flame was obtained. In a minute or two afterwards it was necessary to turn down the gas supply and consume considerably less gas, or it began to smoke; clearly showing that there was not sufficient air supplied to it. The illuminating power also agreed with the height of the flame. If, therefore, with a smaller consumption of gas more light (or the same light) was obtained, it certainly seemed to show that, in practice, there was some advantage gained by heating the air, whatever the theory might be against it.

Mr. Gadd, in reply, said he had listened with great attention, and also with some disappointment, to the criticisms which had been passed on his paper. He thought he had made his position clear; but, unfortunately, most of the gentlemen who had spoken had entirely misinterpreted his position. He could, however, easily understand why this was so. It had possibly been assumed that he had been endeavoring either to resuscitate some other theory or to demonstrate something which had gone before; but he had no such intention. He simply wished to bring forward an experiment showing certain effects of heating air on combustion *per se*. He wished it to be considered apart from anything else. Perhaps he was somewhat to blame for having alluded to former inquiries; but he only did so to show why he had taken up the subject. Mr. Sugg thought it important to know accurately the temperature inside the bulb; but if Mr. Sugg watched the experiment, and the deduction he wished to draw from it, he believed he would alter this view. Of course, for accurate scientific investigation it might be advisable to know this; but it was not necessary for the purpose in view. When a man knew he was cold he did not need to know the exact temperature of his body; and the same when he felt hot. It was very important for scientific inquiry to know these temperatures; but it did not alter the fact whether the man felt hot or cold. He (Mr. Gadd) hoped some investigator within the Institute would pursue the subject further, and take up the question at the point at which he had left it. Mr. Leather made some objections to the theory; but he would find, when he examined the experiment, that what he said would hardly apply. Mr. Leather spoke about the speed of the molecules; but in the paper he (Mr. Gadd) was not speaking about this at all. He referred to the speed of travel of the volume of air, and he did not see that the speed of the molecules affected this portion of the question at all. The speed of the molecules in their orbits was involved in other departments than the one to which he was referring. The speed of the molecules came into operation first in the act of expansion, and, second, at the moment of evolution of heat itself; because the speed was finally determined by the inrush of particles coming together, forming the compound by the process called combustion, just as the speed of a comet was influenced by its inrush to the sun, or as a meteor falling to the earth. Mr. Leather very properly raised the question of the degree of perfection of combustion in the different stages of the experiment. He (Mr. Gadd) had described it as a “balanced flame of imperfect combustion.” When at its best, with the coldest air, he regulated the orifice to such a size that it still gave very incomplete combustion; and when he analyzed the products there was a portion of unburnt gas coming away. It was imperfect and incomplete in the first instance; then it was a question of increasing or decreasing the amount of perfection; and this was just what was done. On analyzing the products the amount of unburnt gas became greater and greater, just as the tube became hotter and

hotter. Mr. Folkard had some difficulty about the quantity of air; but the volume of air was a very different thing to the weight. Air might be measured by volume or by weight. If it was weighed, 1 pound of air expanded by heat would occupy a very large volume as compared with cold air; but, when passing the air through tubes, the tubes did not expand with the air, and as a consequence the volume of the air became gradually lighter as it expanded. Mr. Folkard asked how the question affected the new Siemens regenerative burners. The cold air must go close up to the hood, which really formed a portion of the enclosed passage, although enlarged in size; and the heated air would be expanded throughout the whole length of the passage. It was assumed by many speakers on the previous day that the whole of the air required for combustion came through the heated passage; but this was a point to which he should demur. The air would come from those places where it was obtained most easily; and the air close underneath the jet was the easiest place from which to supply air for combustion. His explanation of this burner would be that a great portion of the air for combustion came from the cool portion, and the heated air above filled an important function which had not yet been clearly seen. It was well known that a white plate held over a lamp caused a deposition of carbon, owing to the sudden reduction of the temperature of the flame. Now, if the top of the flame were plunged into a heated atmosphere, there would be an insulation of the heat and prevention of the rapid cooling at the fringe of the flame. This, he believed, was one great point in the heated air for such burners—that it prevented the cooling of the flame rapidly; and he believed this was the real function played by the heated air in the Siemens burner. In cases where incomplete combustion occurred the carbon escaped, or had a tendency to escape; but the heated air above also provided sufficient oxygen to complete what would be otherwise incomplete combustion.

Mr. Folkard said he referred to the regenerative furnace, not to the stove and lamp.

Mr. Gadd said Mr. Foulis had referred to the smoke arising from the regenerative burner when first lighted; but there was nothing remarkable about this. If a fire were started before the chimney became warm it also would smoke. By heating the passage the delivery of air to the flame was reduced in weight, not in volume. Although the volume was the same, and the constant travel of the volume just the same, the quantity of air was reduced; and he did not know that, even if a gasholder were employed, the pressure would be equally constant. He thought Mr. Foulis had altogether misunderstood his paper. He entirely agreed with what Mr. Lane had said. If they had heat at any temperature, the most minute portion of heat added to this increased the total quantity of heat; and to the extent that heated air was carried forward into the furnace, it increased the total quantity of heat in the furnace at the moment. What he wished to convey was this—that it was possible there might be a better way of conveying heat back to the furnace or retaining it therein. It was with the view of future investigation that he had brought forward this question. Heating air was a step in the path of progress; but he did not think it was the final step. There was something further to find out; and it was in this spirit and with this object that he had read the paper.

The President said they had all listened with interest to Mr. Gadd's paper, and whether his views (which might appear to be heretical) were right or not, it was well to bear in mind that Professor Tyndall himself had said that much was yet to be learnt on this question of heat and of heating air. This remark was necessary, as some of the speakers had perhaps been inclined to express themselves as though the actual facts were settled. Gentlemen might hold quite different opinions to those which Mr. Gadd had expressed; but it was well to have both sides presented to them. In any case, he considered Mr. Gadd's paper a valuable contribution to a subject in which they, as engineers, were very deeply interested. They must not give up this question of regeneration and the heating of air until they had looked at it from different points of view and were quite satisfied about it in their own minds. There was a great deal that was not yet cleared up on the subject; and they were much obliged to Mr. Gadd for his kindness (not being a member) in coming and giving his ideas on the question from a purely scientific standpoint.

The New Works of the Australian Gas Light Company.

A late issue of the *Sydney Morning Herald* contains the following interesting and “newsy” sketch of the new gas works now in process of erection at Mortlake, near Sydney:

The extraordinarily rapid growth of Sydney and the suburbs during the past few years has been felt probably by no public body or institution more than by the Australian Gas Light Company. As street after street and road after road have been added to the metropolitan area, so the gas mains have followed in their wake; until at last even the more distant suburbs have had their wants supplied. Some idea of the extent of the company's operations may be gathered from the fact that their area of supply requires probably

not far short of 225 miles of pipes. The whole of this vast area is supplied with gas manufactured at the chief works at Darling Harbor. Only five years ago the gas requirements of Sydney and the suburbs were so moderate that the operations of the company were comparatively limited. At that time the total storage plant consisted of four gasholders at the head station at Darling Harbor, four at the Haymarket, and two at Woolloomooloo; the combined capacity being 1,100,000 cubic feet. At various times since then some of the smaller holders have been dispensed with, and others have been removed to make way for larger ones; so that now, while there are only seven holders in use—*i. e.*, two at the head station, three at the Haymarket, and two at Woolloomooloo—yet the holding capacity has been just doubled; that is, 2,200,000 cubic feet. There is thus shown an actual increase in the demand for gas of 100 per cent. in five years. The company also possess two other works separate and distinct from their head station—*viz.*, at Five Dock and Balmain respectively—and at each the increase has been exactly in the same proportion. Whereas in 1880 the amount of storage room required at each place was only 40,000 cubic feet, it is now 80,000—an increase which necessitated the erection of two more holders. But during the period mentioned, and more especially the last twelve months, the mains of the company have been laid down in distant suburbs to such an extent that houses nearly seven miles away from the head station are now enjoying the benefits of gas light. These suburbs are, of course, daily becoming more densely populated; and the gas mains are being constantly tapped to supply the new houses. What with this ever-increasing demand for gas, and the growing use of gas stoves, the works at the head station have been taxed to their utmost extent for some time past. Additions and extensions have been continually made to meet the public requirements. The retort house has been lengthened—bench after bench of retorts being added, and extra purifiers have been provided—indeed every appliance that science has furnished has been brought into use. But at last the limit of space at the head station has been reached, and there is now not an inch of room left for further extension. The directors of the company, foreseeing what, sooner or later, must inevitably occur, about two years ago took the wise precaution of purchasing a suitable block of land whereon they might indefinitely extend their operations. Events have proved that they were not a moment too soon in their action, for the new works can only just be finished in time to meet the expected requirements of next winter. The importance of this step, and the magnitude of the works undertaken, may perhaps be imagined when it is stated that no less than £150,000 will be expended in carrying out the scheme. Although this large amount of money will be required for the works now in progress, yet sufficient space will remain to extend them almost indefinitely; everything being designed with a view to meet all possible requirements, far beyond the necessities of the present generation.

The site selected for the new works is at Mortlake, on the southern side of the Parramatta River. It comprises altogether 60 acres, with an excellent water frontage on two sides. Of this area 40 acres will be occupied by the works, and 20 are set aside for a fresh water reserve. As the ground for the former rose from high-water mark to 60 feet at the boundary, a considerable amount of levelling had to be done. The space required for the yard—in which will be placed the retort house, engine, exhauster, and meter houses, purifiers, washers, scrubbers, condensers, etc.—is 5 acres, and to obtain a level for this, at 15 feet above high water mark, about 38,000 yards of material, mostly sandstone, had to be removed. All this, however, was utilized for reclamation purposes, by which a large quantity of land was obtained. The most important building will be the retort house, which is being built of brick, on rock foundations. Its length will be 280 feet; its width 70 feet; and its height to the spring of the roof 46 feet. On either side of the house will be a coal store, of equal length, 40 feet wide and 20 feet high, with a combined storage capacity of 8,000 tons. The roofs will be of iron, covered with slate. The house will contain 24 benches of 9 retorts; the whole being capable of making 2½ million cubic feet of gas daily. The floor will be 10 feet above the ground level; and the retorts will be fed from the charging floor, the intervening space being used for a coke store. The charging and drawing of the retorts will be done entirely by West's machinery, worked by compressed air. Connected with the retort house, at the west corner of the yard, is being constructed a T-shaped jetty, built on piles driven in rock. The jetty will be 160 feet long, and range in width from 168 feet at the head to 25 feet at the commencement. There will be two floors or landing stages. The top, 35 feet above high-water mark, will be used for the landing of coal; the lower floor, 20 feet beneath, will be on a level with the yard, and used for the discharge of residuals. The coal will be taken out of the colliers by a steam crane, at the rate of a ton per minute, tipped into trucks, and conveyed by a small locomotive engine into the stores. This engine will run along rails diverging from the jetty to the two coal stores, over a curved viaduct 20 feet high, built of cast iron columns and wrought iron girders. Adjacent to the retort house are two tanks, 50 feet in diameter, and 20 feet in depth, cut out of the rock, for the reception of tar and ammoniacal liquor, each capable of holding 250,000 gallons. The purifiers (the foundations for

which are also cut out of rock) are each 30 feet square and 6 feet deep. The engine house, which will be built of brick, on rock foundation, will be 51 feet in length, and 54 feet in width. A cast iron tank, resting on wrought iron girders, and supported by cast iron columns, will cover the entire roof area. Two engines will be erected for present purposes; but room will be available for four more. These engines are required for working the exhausters. Adjacent to this house will be a boiler shed, a chimney 80 feet high being erected in connection therewith.

The gasholder tank has been sunk at the extreme boundary of the company's land, and is about 460 yards distant from the retort house. The dimensions of the tank are: Diameter, 186 feet; depth, 37 feet 3 inches. It was excavated partly through rock and partly through ironstone, the sides above the rock level (which varied considerably) being built up of brick 9 inches in thickness, and filled in with concrete from 1 foot 3 inches to 2 feet 6 inches in thickness. All the brickwork has been rendered with cement. The annular space cut out of the rock is six feet in width; the center of the tank being, of course, left and covered with 6 inches of concrete, which was also rendered. The top of the center has been fitted with timber trussing, to support the crown of the holder when it is down. The rim of the tank is covered with a stone coping; and the foundation stones for the standards (24 in number) are 7 feet square, 18 inches thick, and upwards of 6 tons weight each. The foundations for these immense blocks of stone are formed by piers of concrete 7 feet square, extending down to the rock. In each pier are four bolts, 12 feet in length and 2½ inches in diameter, for securing the standard base to the stone. The inlet and outlet mains are 24 inches in diameter. The holder itself will be a telescopic, triple-lift; the respective diameters being as follows: Inner lift, 179 feet; middle lift, 181 feet 6 inches; outer lift, 184 feet. Its weight will be 1,300 tons; and, when filled with gas, it will rise to a height of about 110 feet, when its total capacity will be 2½ millions cubic feet. The standards are of wrought iron, secured in cast iron bases, and will be braced together by tie-rods and lattice girders to form the guide frame. Their height will be 112 feet irrespective of the cast iron finials which will surmount them. The tank is sunk in ground 45 feet above the yard level; and the holder will be filled with gas running through mains 36 inches in diameter from the outlet of the meter to the inlet of the holder. Adjacent to this portion of the works will be the manager's offices and the governor room.

The remaining work under construction at Mortlake is the fresh water reserve above referred to. The dam is composed of an embankment 15 feet above high-water mark, with a puddle wall running through the center of its entire length, and extending from the solid rock to the top. About ten of the 20 acres are being prepared for the reserve, which it is estimated will have a capacity of at least 10 million gallons of water. The site selected is admirably adapted for this purpose, the land being low and surrounded by hills, which provide a catchment area of somewhere about 150 acres, all the surface drainage of which must naturally flow into the reserve.

Another large undertaking in connection with these works is the laying of cast iron mains for the delivery of gas into Sydney. No less than 5½ miles of these mains are required; and when it is stated that the total weight amounts to more than 4,800 tons, some idea may be formed of the work involved. The mains are 36 inches in diameter, and are laid at a depth of 2 feet 6 inches. All but 2,000 yards of the distance has been finished; and the whole would have been shortly completed had it not been for the exigencies of the Government, who required 500 of the pipes for the works in connection with a temporary water supply. Fresh pipes, however, have been cabled for from England, and they will all be laid and ready for use by the time the works are finished. Larger mains are also about to be laid to replace smaller ones where required to meet the continually increasing demand for gas.

It need scarcely be stated that nearly the whole of the material for the immense works now in course of construction was manufactured in England. For considerably more than a twelvemonth vessel after vessel has arrived bringing large consignments for the company; four or five ships, indeed, being wholly chartered for the purpose. No less than 9,000 tons of manufactured iron have been brought in this way, lightered into punts, and landed at the temporary jetty at Mortlake.

The erection of the gasholder (which will be the largest in use on this side of the world, and is the most extensive undertaking of all) will be carried out by the company, and is expected to be finished by the end of next March. The remaining work will be the erection of the iron viaduct, and the building of the retorts, both of which will be done by the company's workmen. If no untoward event occurs the works will be completed in time to meet all the requirements of next winter.

The Peruvian Petroleum Field.

According to a contemporary, the existence of petroleum in the land of the Incas has been known for many years. At numerous places in the Andes Mountains the outcroppings of oil are plainly to be seen. Shallow pits, and for various purposes, have speedily filled up with the black, greasy product, for which the natives could find but limited use. At Mal Paso, on the Pe-

ruvian coast, the mountain range forms part of the shore line of the Pacific Ocean, and from the huge cliff, whose rocky front has been broken off by the ceaseless dash of waters, oil has been seeping for centuries. But no fire worshippers were in this part of the world to ignite the inflammable oil, and watch the weird effect of an ocean of flame. All about this region are to be found monumental remains of the ancient Peruvians, whose civilization is still the marvel of the antiquarian, but nowhere have any evidences been discovered to show that the deposits of crude oil were mined or used by this intelligent and mysterious race.

The petroleum field of Peru, as at present defined, consists of a small area of territory, in the department of Piqua, in the northwestern part of the country, containing three producing oil wells and a refinery. About 19 years ago Mr. Fred Prentice and a number of oil region capitalists invested considerable money in fitting out an expedition for developing the petroleum deposits of Peru. The result of this exploration is shown to-day at the village of Zoretus, on the Pacific coast, twenty miles south of Tumbes, where 15 or 20 wells have been drilled, and a refinery of three stills erected. An Italian gentleman, by the name of Piaggio, who resides at Callao, is now the owner of the wells and the refinery.

During the spring months of the present year Mr. A. A. Perkins, of Bradford, an expert in everything that pertains to the sinking of artesian wells, was engaged by Mr. Piaggio to come to Peru and drill a couple of the wells to a greater depth, with a view to obtaining an increased output of crude. Mr. Perkins sailed from New York to Aspinwall late in April. Crossing the isthmus on the Panama Railroad, a steam vessel took him to the mouth of the Tumbes River, a small harbor on the northern coast of Peru. From the steamer a rowboat is required to conduct the traveler up the Tumbes River to the village of the same name, a small place of about 800 inhabitants. A bridle path over the mountains leads to Corrales. Here the path winds along the bottom of the foothills to La Cruz, where it takes to the beach. A four-mile ride along the shore and Zoretus, the place of his destination, is reached.

Mr. Perkins found that of the 15 or 20 wells that had been drilled since the advent of Mr. Prentice, none had been sunk to a depth of 500 feet, and nearly all of them were pretty thoroughly plugged with broken-down tools and old iron. One producing well, doing about 10 barrels a day, supplied the refinery, which was fired up about once in three weeks, or when sufficient oil had accumulated to make the operation worth while. This well was 300 feet deep, and produced a black oil of 36° gravity. Mr. Perkins' first employment was piecing together a set of tools, from the remains of what had been brought there in previous years. He found drilling operations in charge of an intelligent Canadian, who had been in the country for 15 years, and who was thoroughly acquainted with the language, manners and customs of the natives. The old style of drilling with the centerbit and reamer was strictly adhered to, and Mr. Perkins' intentions of drilling with a club bit were derided and believed to be an impossibility by the Canadian and the workmen he had trained to assist about the wells. A well 430 feet deep was immediately drilled to a depth of 480 feet, and a green oil of 43° gravity discovered. The well is now pumping 20 barrels a day. The black oil is generally found at 130 feet, where it begins to seep out from the rock. About 70 feet of casing is used to keep the well from caving, and not from any desire of shutting out the salt water. The rock seems thoroughly saturated with oil all the way down as far as the drill has yet penetrated.

Mr. Perkins' next undertaking was at another old well, 280 feet deep, which at one time had produced 100 barrels of black oil per day, but which was now entirely exhausted. His greatest difficulty was in piecing together a derrick. There is no timber of any value in the country, and all other rigs had been erected without any main sill. The Sampson post had been set directly in the ground. No sand reel was used, but instead the tools were pulled out and a hollow tube screwed on which was used as a sand pump to remove the sediment.

Mr. Perkins' new rig was 48 feet high, and he used a sub-sill in which the Sampson post was inserted. A sand reel was a feature of the new rig entirely unknown in this country before. He removed the casing from the old hole and reamed it down to the original depth. He used 2½-inch tools for the small hole and club bits. Tools of this size had previously been used solely for drilling the big hole. The last well drilled at Zoretus required seven months. With the improved facilities Mr. Perkins soon put the well down to a depth of 343 feet, and states that with a full oil region outfit and oil region drillers there is no reason to prevent wells from being sunk with as great rapidity in Peru as in Pennsylvania. The well drilled was expected to make a 20-barrel pumper, and completed his engagement in this primitive region.

The oil refined by Mr. Piaggio at Zoretus is put up in cases containing two cans of five gallons each. It readily commands \$4.50 per case at Callao, where a good quality of American refined is sold at 50 cents a gallon. Callao, the principal commercial city of Peru, is 800 miles south of Zoretus. The refinery now has a supply of about 40 barrels of crude a day from the

three producing wells. There are three iron tanks at Zoretus, each of 3,000 barrels capacity. The refinery at the present time is only using one of its hundred barrel stills. Petroleum refuse is used for fuel, and small quantities of wood, which is brought from the mountains packed on the backs of the small but strong and willing burros. Rain seldom falls at Zoretus, and the water supply is obtained from the ocean. Marine boilers are used about the works and in drilling the wells. The condensed steam from the exhaust pipes is used for drinking. The refinery is in charge of a native Peruvian, who is called the "administrator." A tin shop, in which the cans are made, also employs native workmen.

The temperature at Zoretus never rises above 90° F., and rarely falls below 60°. The trade winds strike the place, and their steady breeze is at once refreshing and exhilarating. No more romantic site for an oil well could be imagined or desired. On one side, within 100 yards, the great Pacific dashes its breakers with never ceasing roar against the shore; on the other the snow-capped peaks of the Andes lift their rugged forms.

Mr. Perkins is of the opinion that an abundant supply of petroleum can be obtained at a depth of 1,000 feet. A market could be obtained for it in supplying locomotives and steam vessels with the liquid fuel. Coal is scarce and dear, costing \$16 per ton. The country about Zoretus is barren, but in the vicinity of Tumbes numerous haciendas bear witness to the fertility of the soil. All the land has to be irrigated. Cocoanuts, pineapples, bananas, etc., are raised in abundance.

An Experiment in Gas Making, and the Results Thereof.

By FREDERIC EGNER.

Theories being changeable while facts are unalterable, it is of course within the knowledge of every well informed person of the present generation that many things which once, or in our youthful days, were considered impossible and contrary to all known rules of science or chemistry—in short, then held as visionary—are now accomplished facts. It being quite needless to cite examples of the correctness of that assertion, the writer presupposes, in consideration of the results detailed below, and remembering what is said above, that the reader may kindly overlook, and consequently make due allowance, if the accepted or generally entertained theories of the present day do not coincide with the "hard facts" presented in the succeeding lines.

The President of one of our Western gas companies, who, by the way, is a gentleman possessed of great practical experience in the duties of gas maker, manager, and executive head of gas companies, and who also may be enrolled amongst the ranks of our "entirely successful men of business," remarked at one time that he thought gas might be obtained from coal, in a useful commercial form, without placing it into retorts at all. He did not believe in retorts, although he was obliged to use them simply from lack of a better vehicle or vessel; but notwithstanding their antiquity and undoubted value he yet thought coal might be distilled by the direct application of heat. He had expended large sums of money in attempting to accomplish the desired object; and though not successful in the endeavor, so firm did he remain in his belief that time and experiment would solve the riddle that he persisted, and would reject no plan submitted for his inspection, provided the same had reason as an element in its foundation. He called his pet theory "slacking coal by heat." Some laughed at "the old man," while others, thinking seriously over the project, acted on it; though the original investigator, in the person of the gas president alluded to, knew nothing about the inception of the experiments here to be presented, and as a consequence is not conversant with the results obtained, since this paper will likely furnish him a first intimation that they have been made at all, it is but just to state that his remarks in regard to the subject led to the present attempt to put his theory to practical test. As to whether the results so far obtained are to be classed in the category of successes or failures, of course the critical and painstaking reader can and will decide for himself.

The first trial was conducted by means of an apparatus of which the following furnishes a fair description. A cylindrical shell of boiler iron, 7 ft. 3 in. diameter and 20 ft. high, lined with fireclay blocks 12 in. deep throughout; a grate 2 ft. from bottom; a door in ashpit; a door on line with grate; and a door 10 ft. from the bottom. Four feet above the grate the shell, or generator let us call it, was pierced by ninety-six 1-inch pipes, which admitted air to the inside, but which could be closed at will. Four feet above these tuyeres were the outlet pipes, two in number, of 8 in. diameter each. These pipes ended in a hydraulic seal or wash-box, from which a steam-jet exhauster removed the gases made, and forced them on through a condenser, scrubber, purifier, and meter. There was a ¾-inch steam pipe in the ashpit, and a coal-hopper, with measuring drum and valve, on top of the generator. The foregoing was not the original design of the apparatus in all particulars, but was sufficiently like it to answer for a trial.

The operation was to be thus: A fire being started on the grate, coke was to be fed into the generator to a depth of 8 feet. The air entering under the

grate would be converted into carbonic oxide by the time it reached the line of tuyeres, where, more air being admitted, the heat generated by the combustion of that gas would be sufficient to greatly heat the coke above the tuyeres to a height of at least 30 to 36 inches. This last air, having to pass through so deep a layer of incandescent coke, would also be converted into carbonic oxide before reaching the outlet pipes. Steam was to be admitted under the grate, and this steam would be partly or wholly decomposed in its passage upward. Some of the free hydrogen generated would combine with the nitrogen admitted with the air and form ammonia. Fresh coal was to be dropped onto the heated coke in the generator continuously in small quantities; and as the gas was extracted from it the coke was to be removed from the grate, also in a constant ratio, so as to retain the depth of carbonaceous material in the generator at about the same level at all times. The exhauster was not only to remove the gases made above the fuel, but was, at the same time, to create an indraught of air through the tuyeres. As the application of the heat was direct to the coal, it was thought there would not be a sufficient production of the objectionable gases to injure the general results. The coal was to be fed, and the coke removed, by suitable machinery. When the apparatus was started it was found to operate at first just as had been expected, except in two particulars. It was found that as the coal was coked it formed one large lump which, after a while, prevented the further feeding of coal. This was overcome by introducing stoke holes on top of the generator, and breaking up the coke from time to time. The other difficulty was that not all the tar made was converted into gas; and that objection was also remedied.

The results obtained were not discouraging, so that one improvement after another was made, until now the apparatus seems to be about ready to stand on its merits. The original generator was reduced in size, so as to be 3 ft. in diameter and 11 ft. 4 in. high inside. The reason why this reduction in diameter was made was owing to the fact that the exhauster used was not of sufficient capacity to take away all the gas made, and it was cheaper to reduce the generator than to purchase a new exhauster. It was also found that the illuminants in the coal were not present of themselves in bulk sufficient to carburet the gas made in the generator, and therefore a bench of three oil retorts was added.

The next design caused the gas from the generator and retorts to be drawn together through two fixing retorts placed in the same bench with the oil vessels. Before the fixing retorts were added the results were as follows:—giving, of course, the averages: 11.2 pounds of Youghiogheny coal (not lump, but slack), 3.84 gallons of gas naphtha (62°), and 1.33 pounds of gas coke produced 1,000 cubic feet of gas of from 18 to 19 candle power. Coke was the fuel used in the oil bench. Only gas coal was used in the generator. The steam was supplied by the works, and the fuel to raise that is not included in this statement; but it could not have been more than, if as much as, 1.5 pounds of coke per 1,000 cubic feet. Gas was made at the rate of 6,500 cubic feet per hour. The labor required was one man; and it was evident that he could have attended an apparatus of double the capacity of the experimental one. The steam used was not superheated, but was taken from the boiler of the works located at a distance of close on to 100 feet from the generator. Since the fixing retorts were decided on no gas has been made in the apparatus; but the results with the fixing retorts will certainly not be less than those obtained without them. An ordinary coal gas bench was used in which to make the oil gas. Three of the retorts were used in connection with this apparatus, while the other two (it was a bench of five) continued to make coal gas, which, by a suitable valve arrangement, was conducted into the hydraulic main; and it is in the place of these two coal retorts that the fixing chambers are to be set. The coke herein mentioned heated the coal as well as the oil retorts, but was all charged to the new apparatus.

To distinguish this method of making gas from others it was christened the "Standard Process." In effect, it is really a water gas process, with these differences from existing ones: 1st. The production of gas is constant, not intermittent. 2d. The same plant in all particulars now used for making coal gas can be employed with this process—adding only the generator and suitable valve and pipe arrangements; so that coal gas can be made one day and water gas the next, if so desired. For example, the plant necessary to make 150,000 cubic feet of gas in 24 hours would consist of a generator 3 ft. in diameter and not over 9 ft. (inside) high; one ordinary bench of coal retorts, with hydraulic main, etc.; one exhauster, and the usual scrubber, purifiers, and meter. 3d. Any kind of coal suitable for gas making can be used, and so can any kind of oil—it need not be naphtha.

Although no analysis of the gas produced has yet been made, the fact that it produced the illuminating power stated, with the labor and material given, would seem to encourage further trials. The process here described is still young, and perhaps capable of great improvement. It is quite simple, when you know how; but please remember—whatever be the theories—the results given are not theories, but facts that can be substantiated by the writer.

ITEMS OF INTEREST FROM VARIOUS LOCALITIES.

MR. FISH, OF THE UTICA (N. Y.) GAS LIGHT COMPANY, ON THE SUBJECT OF ELECTRIC LIGHTING.—At the last annual meeting of the New England Association of Gas Engineers the first question* drawn from the question-box bore the title, "What advances have been made in electric lighting during the past year?" and in the discussion that ensued in the attempt to throw light upon the moot-point Mr. H. H. Fish, of the Utica Gas Light Company (who, it was pretty well known, had been concerned in some experiments of a practical nature well adapted to illustrate the debate), gave the details of what had been done by that Company in the direction of arc street lighting. We do not here propose to say anything further in respect to that discussion, since a reference to the specified pages of the JOURNAL will explain exactly what was said at the time in regard thereto; and in fact the present mention of same is merely intended to show that the following letter, recently received by us from Mr. Fish, is especially noteworthy and valuable, as it sums up the careful, conscientious opinions of one who, from practical experience, is competent to sit in judgment on the "relative merits of electricity, gas and naphtha for street lighting purposes." Mr. Fish's communication is herewith appended:

OFFICE OF THE UTICA GAS LIGHT CO.,
UTICA, N. Y., Sept. 28, 1885.

To the Editor AMERICAN GAS LIGHT JOURNAL:—Some few years ago experiments were commenced here in arc electric lighting which culminated in the construction of a tolerably well-equipped plant, constructed by the Central New York Electric Light and Power Company, the same including about 50 street lamps operated and maintained under the plan known as the Thomson-Houston system. This has now afforded about three years' practical experience from which could be deduced a fair judgment regarding the relative merits of electricity, gas and naphtha for street lighting purposes.

When electric arc lamps were first introduced as a medium for street illumination in our city of Utica they were received with every evidence of popular favor, notwithstanding their excess of cost over other methods. It was a new thing, and certainly gave to the streets so lighted a brilliant and even attractive appearance; but when the practical purposes of street lighting are considered—viz., *greater security* for persons and property—a more careful analysis of competing or opposing systems becomes necessary.

It may be fairly conceded that streets lighted by the aid of the arc systems of electricity present to the casual observer a more attractive appearance than those illuminated by other and older methods; but it is equally fair to say that the quality of the light, and its imperfect diffusion, when working under any of the systems yet developed, are far from satisfactory to those who pay the bills and are *personally* interested in the equivalent they have a right to expect and receive for their money.

The excessive cost of electricity makes it necessary to place the street lamps at greater distances apart than is required in the locating of gas or naphtha lanterns, so that any given territory lighted by an arc electric method may, for convenience, be divided into three very unequal parts—and of which much the smallest presents any satisfactory feature. For example, speaking of the first division—for the distance of a square or more from the usual arc lamp there is a painfully dazzling excess of light; in the second division—at the distance of a square or so the light is agreeable, although subject to a more or less irritating oscillation incident to irregular feeding of the carbons; and thirdly—this narrow belt of comparatively agreeable light rapidly lapses into ghastly shadows, with only sufficient illuminating effect to barely "make darkness visible" until approach or arrival is made to the next lamp in the circuit, where the dazzling excess of light (first noticed) is again experienced.

The intrinsic objections to the arc electric lighting method, as at present developed, and as compared with gas, would therefore seem to be: First, its excessive cost; second, the unequal and imperfect diffusion of the light at the very points where it is most needed.

Electricity does well enough in the lighting of large spaces, or in the illumination of such thoroughfares in our cities as are mainly devoted to the transaction of business, or to the purposes or objects of a public promenade—but even then always keeping in view the point that it can only be there successful when its excess of cost over gas is a matter of secondary consideration. Its use or employment under such circumstances, however, is found to increase the demand for more light; and look at it from what point you will, is thus shown to be a useful ally to and aid in the extension and growth of legitimate gas interests.

Very respectfully,
H. H. FISH.

UP TO THEIR EYES IN BUSINESS.—Messrs. Connelly & Co., of Pittsburgh, Pa., report that business with them is in a most flourishing condition, and back up their statement by forwarding to us a list of their shipments during

* See JOURNAL, issue of April 16, 1885, pp. 200-1.

the month of September. From this list we note that they filled 20 orders calling for iron sponge deliveries at points between Massachusetts and California! One lot of 90 tons actually going to Santa Rosa in the last named State. The largest single shipment (5,000 bushels) was sent to the works of Chicago Gas Light and Coke Company, and the smallest lot (50 bushels) was absorbed by the Eufala (Ala.) Gas Company. We note the following purchasers of sponge mixture as taken from the schedule: Consolidated (New York City), 300 bush.; Milwaukee (Wis.), 1,000 bush.; Louisville (Ky.), 4,000 bush.; Citizens (Newark, N. J.), 1,000 bush.; St. Joe (Mo.), 800 bush.; and so on to the end. The 20 orders foot up a grand total of sponge shipments, during the month in question, of 14,900 bushels. The purifying materials branch of their business, however, is not alone in possession of healthy activity, as the delivery of "automatic governors" for September included shipments of no less than 15 of these useful instruments. Of the 15 we note that four were 16-inch; two were 12-inch; four were 8-inch, and five were 6-inch. They also sent out from their factories four 6-inch gas exhausters in same month. That the "good work is liable to go on" may be inferred from the statement that, at time of receiving our information in regard to their doings, before end of first week in current month their orders included two 20-inch automatic governors for Consolidated Company, Baltimore, Md.; one 20-inch instrument for Syracuse (N. Y.) Gas Company; one 8-inch for Tiffin (Ohio) Company; and 6-inch governors for Bellefontaine (Ohio) and Pottstown (Pa.) Companies. The above rather goes to prove that the gas interests of the country are in a prosperous condition, and it moreover furnishes pleasing testimony about the excellence of Messrs. Connelly & Co.'s goods, besides redounding to the credit of the JOURNAL in its capacity as an advertising medium.

COKE FUEL AND THE JARVIS FURNACE.—In our last issue we published a report giving details of certain comparative evaporation tests made at the Silver Lake Company's mill, Newtonville, Mass., by the Jarvis Engineering Company, of Boston. In report of same we invited Mr. Upton to supply us with details of other and similar tests, and that gentleman kindly forwarded us data; but unfortunately the tests were made at a rather remote period, and consequently did not cover the desired points. In his note to us (for which we desire to extend our thanks) Mr. Upton makes the following interesting remarks: "We have had two applications from gas companies that are desirous of putting in plants for running electric lights in connection with their ordinary business. We have decided to ask our customer—the Silver Lake mill, where we made the tests published in your last—to allow us to make a test of a day's run in the use of coke as fuel. Many of our customers use this fuel right along under boilers set with the Jarvis furnace, and claim it is cheaper than any other material they can substitute for it. We wet the coke thoroughly, and where hot air is supplied above the fuel it seems to produce as good a gas flame as it would have done before (as coal) it was carbouized in the retort's." By all means let the tests be made, and the JOURNAL will be ready to publish the results of same. Mr. Upton's query in regard to the existence of a directory of gas companies is answered with the statement that the list compiled by the Goodwin Gas Stove and Meter Company, of Philadelphia, Pa., and bearing date of 1882, is out of print. It is quite likely, though, that a new edition will soon make its appearance.

RESOLVED TO INCREASE ITS CAPITAL STOCK.—Some time ago we had occasion to state that the Union Gas Light Company of East New York, L. I., proposed to increase its capital stock by the sum of \$150,000. On Wednesday, Oct. 7th, the advertised stockholders' meeting for the purpose of accepting or rejecting the scheme was held, and an affirmative result was reached. The decision was practically unanimous, and the corporation will hereafter rejoice in the possession of a capital burden of \$250,000. It is asserted that the money will be spent in extensions to plant, etc.

NEW EXHAUSTER TO THE ORDER OF THE GAS TRUST.—The Philadelphia (Pa.) Gas Trust officials have purchased, from Messrs. Wilbraham Bros., of that city, one of the largest size of exhausters constructed by this firm. The instrument is to be operated at the Germantown station of the Philadelphia gas works.

THE PERILS OF ELECTRIC LIGHTING WIRES.—Not much notice has been taken of the circumstance that electric light wires, passing through a box in the engine room of the steamship Waesland, during a recent trip of that ocean carrier of human life and valuable merchandise, on her journey from Antwerp to New York, caused a slight fire, which was fortunately extinguished before serious consequences resulted. It goes without saying that too great caution and circumspection cannot be exercised in the matter of looking after electric lighting plant on shipboard. Negligence in such matters is reprehensible enough, certainly, when the apparatus is destined to supply the landsman's need; but it becomes criminal when manifested aboard ship.

ACQUIRING REAL ESTATE.—From the records of the New York City Register's Office we learn that the Equitable Company has recently acquired property (from Mr. Rutherford Stuyvesant) located on the north side of 58th street, and extending through to 59th street, at a point about 300 feet west of Tenth avenue. The consideration passing between the parties to the transaction is placed at \$176,000.

THEY MADE A "PROPOSITION."—It is said the Rockford (Ills.) Electric Light Company has recently closed a contract with the Western Edison Electric Company, of Chicago, for 1,200 ten-candle power lamps. The capital stock of the company has been increased by \$30,000, making a total of \$50,000. Of course, they are after a portion or the whole of the public lighting, and have made a proposition to the officials there for the performance of the same. We do not know the particulars thereof, although we may venture the surmise that when it comes to the question of estimating the candle power to be given the city in the street lamps (with the understanding that the Edison incandescent system is the one proposed to be employed) those 10-candle power lamps recently purchased will be rated somewhere in the neighborhood of 16 candles. The local electricians do not appear to be on the same level with retail coal dealers in that the latter buy by the long and sell by the short ton, while the former "purchase by the short light and sell by the long one." However, though their purchases and sales are made on a varying basis, the ultimate result is identical—the final purchaser is always "sold." Perhaps the Rockford gas folks would let us know something about the proposition submitted.

A NEW GAS AND ELECTRIC LIGHT COMPANY.—A company has been organized at Orlando, Florida, for the purpose of constructing and operating a gas and electric lighting works in that town. Its capital stock is fixed at \$50,000, and the incorporators of same are Messrs. W. R. Anno, N. L. Mills, N. Poyntz, T. J. Shine, and J. B. Paramore. Orlando is the capital of Orange county, Florida, and is about 90 miles south of Palatka. We wish the new venture all success, but fear that Orlando's population is hardly up to the mark of sustaining such an enterprise.

PERSONAL.—In our "item" column for Sept. 16th we mentioned that the Evanston (Ills.) Electric Light Company's managers were exceedingly anxious to guide the wayfarer's footsteps over safe lines through being allowed a slice of the public lighting of that city; and we then invited Mr. T. A. Cosgrove "to throw some light on the subject." Brother Cosgrove was seemingly rather dilatory in forwarding a reply, but the reason thereof was made apparent in a right pleasant manner. He intended to make an extended visit East, and so considered it best to carry the news in person, consequently one morning not long since the genial gentleman made his appearance at "top of 4th flight in No. 42," and somehow or another was inclined to find fault with landlord Hoyt's elevator. Our visitor informed us it was quite unlikely the electrical promoters would get a foothold in Evanston until they agreed to bury their wires, and that probably ends the matter. Mr. Cosgrove will pay a visit to the "Novelties" Exhibition, and he will also be in attendance at the session of the Cincinnati gathering. Judging from his rotund and trim appearance we should say that the Evanston electricians have not caused him any decided uneasiness as yet.

WHAT FRIEND HARBISON IS DOING.—Jno. P. Harbison, of Hartford, like unto many of his brother gas men, has had a busy time of it this summer. The principal cause of his summer devotion to business arose from the carrying out of an extensive plan for increased distribution facilities. Long sections of 8 and 10-inch mains have been replaced with pipe 16 inches in diameter, and he now breathes easier, and so will the Hartford gas works next winter. During the progress of the work not a single consumer was deprived of his gas supply.

THE FURIOUS WORK OF A RECENT CYCLONE.—At the late Chicago meeting of the Western Gas Association Mr. G. A. Hyde, sr., read a paper,* on the subject of "Pressure of Gas in Street Mains," and in the discussion which followed the vagaries and eccentricities exhibited by a "real Western cyclone" were freely commented upon. Many of the gentlemen present were rather incredulous about the experiences related, and seemed inclined to view the matter as overstated. Now (and while the newspaper accounts of the September cyclone that almost demolished the town of Washington Court House, in Ohio, are still fresh in the memories of our readers) we are enabled to present some facts, in regard to these terrible visitors, that are perfectly reliable and for which we are indebted to Mr. Joe. M. McLean, Secretary of the Washington Gas Light Company. Mr. McLean's statement is as follows:

* See JOURNAL, Vol. XLIII., issue July 2d, 1885, pp. 3, 4, 5.

OFFICE OF WASHINGTON GAS LT. CO.,
WASHINGTON C. H., Sept. 26, 1885.

To the Editor AMERICAN GAS LIGHT JOURNAL:—
In compliance with your request I will say the cyclone that struck our city on the evening of Sept. 8th dealt our town a heavy blow. It made its appearance at the hour, and from the usual direction, that cyclones take—in early evening and from the southwest—accompanied by heavy rainfall. It seemed to possess a gyrating motion, as many things blown down point in the direction from whence the wind came. Those who particularly noted the onward approach of the cloud describe it as having been intensely black, frequently illuminated by vivid streaks of lightning, running, not in the usual zigzag manner, but vertically from zenith to horizon. The section that caused the damage did not take up over one minute's time in passing a given point. On reaching the town the clouds parted, the currents being separated by a distance of about 300 feet. The one to southeast was the most destructive. Buildings located on corners of streets or alleys suffered greatest. The current, striking a building and demolishing it, would bound over to the next square, and leave the intervening structures almost, if not entirely, unharmed, while the second point of contact would present a spectacle of unroofing. The second contact was not nearly so powerful in its destroying qualities as was the first, or else our gas works would now be wanting. Three hundred feet from our works, right in the direction from whence the visitor was traveling, two dwelling houses were badly damaged; and, strange to say, it swept over the gas works proper, leaving the same undamaged, save the wiping out of a portion of the roof. Fifty lanterns and probably half as many posts were blown—we know not where. Our holder (it was filled to the water's edge) sank in the water—to what depth I cannot say, but so strong was the pressure upon it that, when relieved, it bounded back with sufficient force to wrench every wheel from the guide rails, and exhausted the lights from a considerable portion of the town. Fortunately the holder sustained no great injury. Twenty-seven feet from a two-story brick building runs a 2-inch cast iron main, buried at a depth of 30 inches. About 15 feet of side wall of this building was blown down directly over the main. Next morning the odor of gas was detected emanating from an areaway, say, 17 feet distant from point of fallen wall. We dug down to pipe and found it broken. The iron was in good state of preservation—the jar from falling wall must have ruptured it. A reference to the books of our relief committee shows that 25 houses were entirely destroyed; 100 more sustained damages amounting to from 10 to 75 per cent. of their value; 6 persons were killed, and 500 people required assistance. As an instance of the destruction wrought upon some households that of one of our stokers affords an unfortunate example. With a family of five children he occupied a four-roomed dwelling; the children were being prepared for bed, when the cyclone came and in one short moment they found themselves standing on the ground, where the house had been, in a drenching rain. Everything they possessed was either broken up or blown away, save the cook stove and the clothing on their persons—fortunate only in that they escaped unhurt. As it swept through our cemetery tall granite columns were thrown from their bases with as much apparent ease as it twisted into fragments the fragile limbs of the evergreen trees.

Respectfully, Joe. M. McLEAN.

THE TEST WAS MADE.—In an item given elsewhere the hint was advanced that the Jarvis Furnace Company would likely make a comparative evaporation test, using coal and coke as fuels. The tests have been made, and report of same will appear in our next.

Gas Stocks.

Quotations by Geo. W. Close, Broker and Dealer in Gas Stocks.

16 WALL ST., NEW YORK CITY.

OCTOBER 16.

All communications will receive particular attention.
The following quotations are based on the par value of \$100 per share.

	Capital.	Par.	Bid	Asked
Consolidated.....	\$35,430,000	100	95½	96½
Central.....	440,000	50	60	70
“ Scrip.....	220,000	—	47	57
Equitable.....	2,000,000	100	133	135
“ Bonds.....	1,000,000	—	107	110
Harlem, Bonds.....	170,000	—	—	—
Metropolitan, Bonds....	658,000	—	110	113
Mutual.....	3,500,000	100	132½	132x
“ Bonds.....	1,500,000	1000	104	107
Municipal, Bonds.....	750,000	—	—	—
Northern.....	125,000	50	50	—
“ Scrip.....	108,000	—	—	—
Gas Co's of Brooklyn.				
Brooklyn.....	2,000,000	25	130½	132
Citizens.....	1,200,000	20	84	86
“ S. F. Bonds....	320,000	1000	106	110
Fulton Municipal.....	3,000,000	100	159	160
“ Bonds.....	300,000	—	104	108
Peoples.....	1,000,000	10	84	86
“ Bonds.....	290,000	—	105	110
“ “.....	250,000	—	90	95
Metropolitan.....	1,000,000	100	91	93
Nassau.....	1,000,000	25	126	—
“ Cfts.....	700,000	1000	98	99
Williamsburgh.....	1,000,000	50	162	164
“ Bonds... ..	1,000,000	—	111	114
Richmond Co., S. L.	300,000	50	64	75
“ Bonds.....	40,000	—	—	—
Out of Town Gas Companies.				
Buffalo Mutual, N. Y....	750,000	100	80	85
“ Bonds... ..	200,000	1000	95	100
Citizens, Newark.....	918,000	50	103	115
“ “ Bonds....	124,000	—	105	110
Chicago Gas Co., Ills... ..	5,000,000	25	130	140
Peoples G. L. & C. Co., Chicago, Ills.....			8	12
Cincinnati G. & C. Co..			180	182
Consolidated, Balt.....	6,000,000	100	47	48
“ Bonds... ..	3,600,000	—	107	107½
Central, S. F., Cal.....			—	58
Capital, Sacramento, Cal.			56	—
Hartford, Conn.....	750,000	25	123	129
Jersey City.....	750,000	20	140	150

Advertisers Index.

	Page
GAS ENGINEERS.	
Jos. R. Thomas, New York City.....	220
Wm. Henry White, New York City.....	218
Wm. Farmer, New York City.....	220
GAS WORKS APPARATUS AND CONSTRUCTION.	
James R. Floyd, New York City.....	219
T. F. Rowland, Greenpoint, L. I.....	219
Deily & Fowler, Phila., Pa.....	219
Kerr Murray Mfg. Co., Fort Wayne, Ind.....	219
Stacey Mfg. Co., Cincinnati, Ohio.....	219
Bartlett, Hayward & Co., Baltimore, Md.....	219
Morris, Tasker & Co., Limited, Phila., Pa.....	218
Davis & Farnum Mfg. Co., Waltham, Mass.....	192
Tanner & Delaney Engine Co., Richmond, Va.....	218
R. D. Wood & Co., Phila., Pa.....	218
Southwark Foundry and Machine Co., Philadelphia, Pa.....	218
PROCESSES.	
National Gas Light and Fuel Co., Chicago, Ills.....	211
Burdett Loomis, Hartford, Conn.....	210
GAS AND WATER PIPES.	
A. H. McNeal, Burlington, N. J.....	216
Gloucester Iron Works, Phila., Pa.....	216
Warren Foundry and Machine Co., Phillipsburgh, N. J.....	216
Mellert Foundry and Machine Co., Reading, Pa.....	216
Cincinnati and Newport Iron and Pipe Co., Newport, Ky.....	216
Cincinnati and Newport Iron and Pipe Co., Newport, Ky.....	216
Fox & Drummond, New York City.....	216
Ohio Pipe Co., Columbus, Ohio.....	216

SCRUBBERS AND CONDENSERS.

G. Shepard Page, New York City..... 217

REGENERATOR FURNACES.

Charles F. Dieterich, Baltimore, Md..... 164

GAS ENGINES.

Schleicher, Schumm & Co., Phila., Pa..... 224

Clerk Gas Engine Company, Phila., Pa..... 212

GAS REGULATOR.

Helme & McIlhenny, Phila., Pa..... 210

RETORTS AND FIRE BRICK.

J. H. Gautier & Co., Jersey City, N. J..... 214

B. Kreischer & Sons, New York City..... 214

Adam Weher, New York City..... 214

Laclede Fire Brick Works, St. Louis, Mo..... 214

Brooklyn Retort and Fire Brick Works, Brooklyn, N. Y..... 214

Borgner & O'Brien, Phila., Pa..... 214

William Gardner & Son, Pittsburgh, Pa..... 214

Henry Maurer, New York City..... 214

Chicago Retort and Fire Brick Works, Chicago, Ills..... 214

Baltimore Retort and Fire Brick Co., Baltimore, Md..... 214

Standard Gas Retort and Fire Brick Co., Ironton, Ohio..... 214

Oakhill Gas Retort and Fire Brick Co., St. Louis, Mo..... 214

A. T. Chur, New York City..... 221

CEMENTS.

C. L. Gerould, Manchester, N. H..... 211

Brooks, Shoochridge & Co., New York City..... 211

E. Thiele, New York City..... 211

Howard Fleming, New York City..... 211

GAS STOVES.

American Meter Co., New York and Philadelphia..... 215

The Goodwin Gas Stove and Meter Co., Philadelphia, Pa..... 196

GAS METERS.

Harris, Griffin & Co., Phila., Pa..... 222

American Meter Co., New York and Philadelphia..... 223

The Goodwin Gas Stove and Meter Co., Phila., Pa..... 223

Helme & McIlhenny, Phila., Pa..... 223

Maryland Meter and Mfg. Co., Baltimore, Md..... 222

D. McDonald & Co., Albany, N. Y..... 223

Nathaniel Tufts, Boston, Mass..... 222

EXHAUSTERS.

P. H. & F. M. Roots, Connersville, Ind..... 213

Smith & Sayre Manufacturing Co., New York City..... 218

Wilbraham Bros., Philadelphia, Pa..... 220

GAS COALS.

Penn Gas Coal Co., Phila., Pa..... 221

Perkins & Co., New York City..... 220

Newburgh Orrel Coal Co., Baltimore Md..... 221

Despard Coal Co., Baltimore, Md..... 221

Chesapeake and Ohio R.R. Coal Agency, N. Y. City..... 221

Westmoreland Coal Company, Phila., Pa..... 221

GAS ENRICHERS.

W. H. Doan, Cleveland, Ohio..... 220

VALVES.

Ludlow Valve Manufacturing Co., Troy, N. Y..... 216

John McLean, New York City..... 216

GAS LAMPS.

Siemens Regenerative Gas Lamp Co., Philadelphia, Pa..... 217

G. Shepard Page, New York City..... 193

Albo-Carbon Light Co., Newark, N. J..... 210

GAS KILNS AND OVENS.

Thompson Gas Kiln and Oven Co., New York City..... 213

PURIFIER SCREENS.

John Catot, Lawrence, Mass..... 220

STREET LAMPS.

J. G. Miner, Morrisania, New York City..... 213

Bartlett Street Lamp Mfg Co., New York City..... 213

BURNERS.

G. Geffroter, Phila., Pa..... 218

G. Taylor, New York City..... 210

PURIFYING MATERIAL.

Connelly & Co., New York City..... 220

STEAM BLOWER FOR BURNING BREASE.

H. E. Parson, New York City..... 182

PIPE COVERINGS.

Chalmers-Spence Company, N. Y. City..... 220

GAS FIXTURES.

Mitcheil, Vance & Co., New York City..... 213

STEAM PUMPS.

A. S. Cameron Steam Pump Works, N. Y. City..... 213

SHAFTING, PULLEYS, ETC.

A. & F. Brown, New York City..... 211

PIPE WRENCH.

J. H. Williams & Co., Brooklyn, N. Y..... 210

HYDRAULIC MAIN.

A. E. Boardman, Macon, Ga..... 213

FOR SALE.
Second-Hand Gas Apparatus.

One Condenser, 4½ ft. diameter by 13 ft. in length over all, containing 150 two and one-half inch tubes, 8 ft. long with 12-in. connections and bye-pass.

Two Smith & Sayre (12-inch) Steam-Jet Exhausters, with 3 Self-acting Bye-Passes.

Four Purifying Boxes, 10 ft. by 14 ft. by 3 ft., with 12-inch connections and center seal.

All in good order, and will be sold cheap. Address

PETER P. MILLER, Manager Citizens Gas Co.,
Buffalo, N. Y.

TENDERS

FOR

Lighting the Streets of Toronto.

Tenders, addressed to the undersigned, will be received by registered post up to 12 o'clock noon of

Tuesday, the 1st December, 1885,

for the lighting of the streets of the City of Toronto, Canada, with Electric Light, Gas Light, or other illuminant, for one, three, or five years from the 1st day of July, 1886, or sooner if practicable.

Specifications can be seen and a copy of the same obtained on application at the office of the Chief Engineer of the Fire Department, corner Bay and Temperance streets, or at the office of the City Clerk, City Hall, after the 15th day of October.

A cash deposit, or marked check made payable to the order of the City Treasurer, for the sum of one thousand dollars, must accompany each and every tender, together with the *bona fide* signatures of two responsible persons who will become sureties for the due fulfillment of the contract. The deposit accompanying the tender will be forfeited to the city in the event of the person or persons whose tender is accepted failing to execute the necessary contract or give satisfactory sureties for the due fulfillment of the same. Deposits of unsuccessful tenderers will be returned. The lowest or any tender not necessarily accepted.

JOHN MAUGHAN,
Chairman Committee on Fire and Gas.
City Clerk's Office, Toronto, September 30, 1885.

**TO GAS COMPANIES
CONTEMPLATING ENLARGEMENT**

The Grand Rapids Gas Company will offer for sale in 1886 a **Complete Ten-inch Plant** for making coal gas.
Grand Rapids, Mich., Oct. 6, 1885.

TAYLOR'S
AUTOMATIC GAS CHECK.

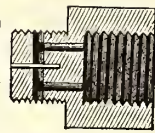
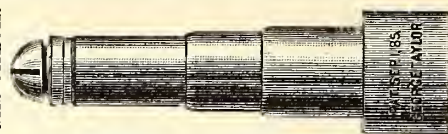

Pat. Sept., 1885. Just the thing for street lamps. No moving parts; only the gas moves, and checks itself by opposing currents; cannot get out of order or wear out; the cheapest and best of all governors. Samples, by mail, 10 cents. Send for circular.

G. TAYLOR, 60 Duane st., N. Y.

PATENTS.

FRANKLIN H. HOUGH,
Solicitor of American & Foreign Patents,

925 F. ST., WASHINGTON, D. C.
(NEAR U. S. PATENT OFFICE.)

Personal attention given to the preparation and prosecution of applications for Letters Patent. All business before the U. S. Patent Office attended to for moderate fees. **No Agency in the United States possesses superior facilities for obtaining Patents**, or for ascertaining the patentability of inventions. Copies of patents furnished for 25 cents each. Correspondence solicited.



THE ALBO-CARBON LIGHT!

A new system of Carbureting heated Gas by means of a solid material, whereby its illuminating power is increased more than three-fold.

SUPERIOR TO ALL OTHER SYSTEMS FOR

Economy, Safety, Illuminating Power and General Practicability,

The Albo-Carbon process enables Gas Companies to supply a light equal to the Arc Light, at a much less cost. Several Gas Companies are now using this system. The process is extensively used in Europe, and is being rapidly adopted in this country.

The Albo-Carbon Light Co., - - Newark, N. J.

GENERAL AGENCIES:

1004 Walnut St., Philadelphia, Pa.
94 Fifth Avenue, Chicago, Ill.
522 Pine Street, St. Louis, Mo.

Law Buildings, Lexington Ave, Baltimore.
35 Federal Street, Allegheny, Pa.
120 S. Fourth Street, Minneapolis, Minn.

Helme's Automatic Regulator

As Applied to the

FOULIS GAS GOVERNOR.

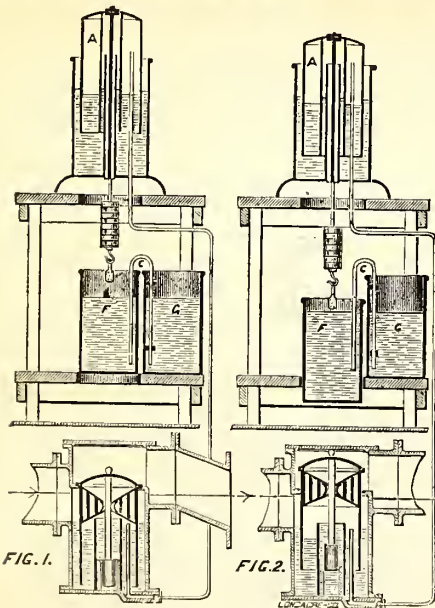

This Regulator and Governor combined are absolutely free from friction, excepting what is due to the moving of the float *A* and valve through the water. There are no journals to carry weight, and the moving parts are so nicely balanced that they do not rub against the surroundings.

The well-understood action of the inverted syphon in a fluid is made available in loading and unloading the float of the Regulator. As the demand for gas increases the float *A* descends, and with it the vessel *F*, drawing into it from the tank *G* a portion of the fluid it contains. This additional weight increases the pressure at the Governor sufficiently to overcome the friction in the pipes due to the increased amount of gas passing. When the shutting off begins a reverse action takes place. The float and vessel *F* begin to rise, and in doing so return to the tank *G* the fluid taken from it while descending.

From this it can be seen that any desired variation in pressure can be arranged for at the Governor, so as to maintain a uniform pressure in center of town. When once adjusted to the minimum day pressure and maximum night pressure it requires no further attention. For prices and further particulars inquire of

HELME & McILHENNY,
Nos. 1115 and 1117 Cherry Street, - - Philadelphia, Pa.

BURDETT LOOMIS,
HARTFORD, CONN.

Builder of Gas Works.

LOOMIS'S PATENT WATER GAS APPARATUS, FOR MAKING ILLUMINATING OR HEATING GAS FROM BITUMINOUS SLACK, ANTHRACITE COAL SCREENINGS, COKE, LIGNITE, OR WOOD.

More gas can be made with this apparatus, using **BITUMINOUS SLACK**, than by any other process using same amount of best quality Anthracite Coal, and with less oil. No clinker; no filling up of superheater with ashes, as they are separated from the coal in the process of blasting and easily removed. Plans and estimates furnished.

NATIONAL GAS LIGHT AND FUEL COMPANY,

Sole Owners and Licensees of the Springer Patent Cupola and Process for the U. S.,

Chicago.

Builders, Lessees, and Purchasers of

GAS WORKS

UNDER THE

Springer Cupola Gas Generating System.

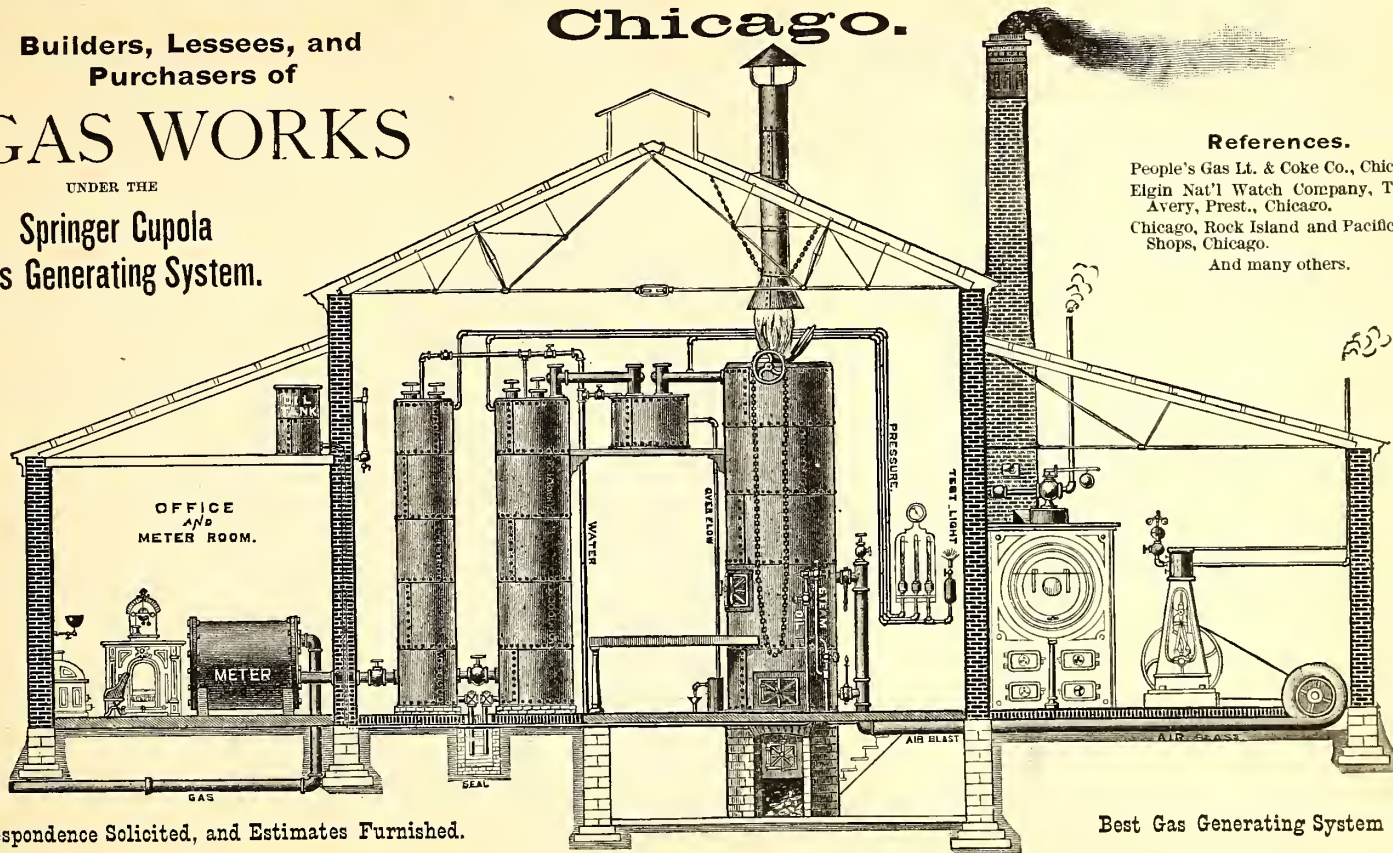

References.

- People's Gas Lt. & Coke Co., Chicago.
- Elgin Nat'l Watch Company, T. M. Avery, Prest., Chicago.
- Chicago, Rock Island and Pacific Ry. Shops, Chicago.
- And many others.

Correspondence Solicited, and Estimates Furnished.

Best Gas Generating System Known.

Orders from Cities, Towns, and Public Institutions Promptly Executed. Address

NATIONAL GAS LIGHT AND FUEL COMPANY, - - - No. 162 Washington Street, Chicago, Ill.

DYCKERHOFF PORTLAND CEMENT

Is superior to any other Portland Cement made. Its extraordinary strength permits a greater addition of sand, while its acknowledged uniformity insures the most reliable and strongest work. It is therefore the most economical to use. Circulars, with testimonials and tests, sent on application.

E. THIELE,

SOLE AGENT, U. S.,

78 William Street, - - New York.

GIBBS PORTLAND CEMENT

Is guaranteed to be the finest English brand, and unsurpassed by any grade imported for making concrete and setting masonry.

Extract of paper, with tests, read before the Am. Soc. of Civil Engineers, sent on application.

HOWARD FLEMING,

Sole Agent for U. S.,

23 Liberty St., New York.

GEROULD'S IMPROVED RETORT CEMENT.

Used by most of the Gas Companies of the United States with perfect satisfaction. Manufactured by

C. L. GEROULD,
Manchester, N. H.

N. B.—As Manchester is a shipping point, all freight can be shipped as cheaply as from Boston or New York.

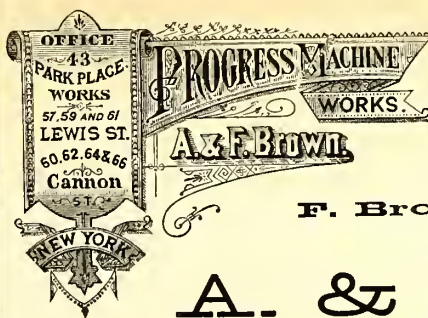

Shafting, Pulleys, HANGERS.

F. Brown's Patent Friction Clutch.

Send for Illustrated Catalogue and Discount Sheet to

A. & F. BROWN,

No. 43 Park Place, New York City.

BROCK'S PATENT DROP FORGED CHAIN PIPE WRENCH

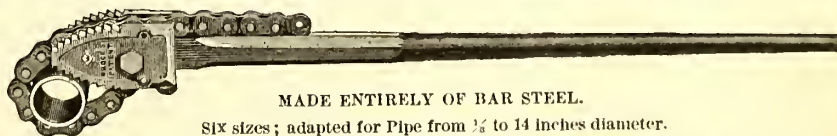

MADE ENTIRELY OF BAR STEEL.

SIX sizes; adapted for Pipe from 1/2 to 14 inches diameter.

Each number will fit a range of sizes equal to six or more pairs of common tongs, while it will outwear an equal number of any kind. All parts are interchangeable, and can be readily renewed.

Jaws are hardened to a saw temper, and can be sharpened with a file. Does not crush pipe; has a quick grip; never slips; chain will not miltch while in use, but can be instantly released.

J. H. WILLIAMS & CO.,

Manfs. of Every Description of Iron and Steel Drop Forgings.

No. 14 BOWNE STREET (Near Hamilton Ferry), BROOKLYN, N. Y.

HOWARD FLEMING,

23 Liberty Street, New York.

IMPORTER OF THE BEST

Portland & Roman Cements

"DINAS" SILICA FIRE BRICKS AND BLOCKS
For Coke Ovens and Gas Works.

Correspondence invited.

Lowest prices.

BROOKS, SHOOBRIDGE & CO.

Best English Portland Cement

WORKS: GRAYS, ESSEX, ENGLAND.

New York Office, No. 7 Bowling Green.

THE CLERK GAS ENGINE.

Highest Award American Institute, New York, 1883. Silver Medal American Institute, N. Y., 1884.
Gold Medal Awarded Crystal Palace Electrical Exhibition, London, 1882.
Highest Award for Motive Power British Section International Exhibition of Electricity, Paris, 1881.

Reliable.
No Boiler.
Steady.
No Coal.
Simple.
No Ashes.
Compact.

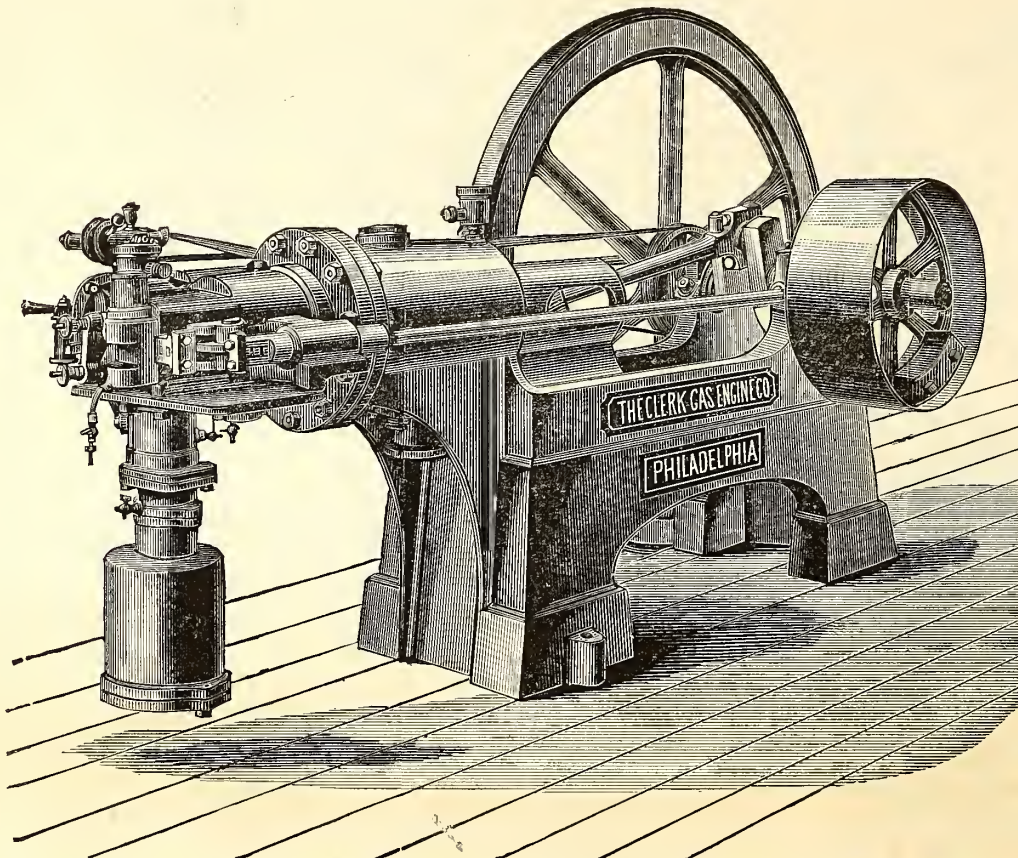

Economical.
No Engineer.
No Explosion
No Gearing
Wheels.
No Danger.
No Parts
requiring
frequent
renewal.

REQUIRING ONLY A MATCH TO START IT--GIVING ITS FULL POWER IMMEDIATELY.

We would inform the public that during the last few months we have improved THE CLERK GAS ENGINE to such an extent that we can now offer an engine vastly superior to our former pattern. These improvements have enabled us to sell our engine at a GREATLY REDUCED FIGURE, partly on account of the decreased weight (our engine weighing about half that of others giving the same Brake H. P). The consumption of gas has been decreased to a considerable extent, and the Brake H. P. has been increased some 25 to 30 per cent. All parts of the old design that were considered defective have been remodeled and new designs added. We now have an engine second to none as regards power, consumption, and ease of working. With our new engine all trouble in starting has been removed, the noise reduced to a minimum, and the regularity of motion is now all that can be desired. We guarantee all we claim for it, and the material and workmanship being of the best, enables us to guarantee the engine for twelve months.

SOLE MAKERS,

THE CLERK GAS ENGINE CO.,

WM. W. GOODWIN, President. E. STEIN, Secretary. S. LEWIS JONES, Asst. Secretary. L. P. GARRET, Supt.

Main Office, 1012-1018 Filbert Street, Philadelphia, Pa.

BRANCH OFFICES,

142 Chambers St., N. Y.

4 West Fourteenth St., N. Y.

76 Dearborn St., Chicago

General Agents,

THE GOODWIN GAS STOVE & METER CO.
Of Philadelphia, New York, and Chicago.

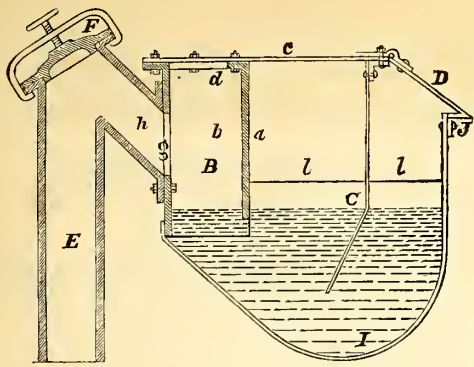

Boardman Hydraulic Main, Patented October 7, 1884.

For description, see AM. GAS LIGHT JOURNAL of Feb. 2, 1884.
For terms, apply to
A. E. BOARDMAN, Macon, Ga.

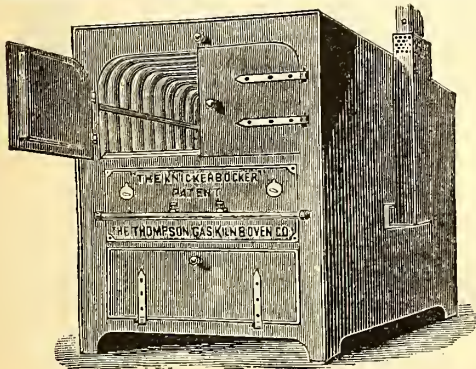

"The Knickerbocker" Portable Gas Oven,
ON EXHIBITION AT AMERICAN INSTITUTE FAIR.
Thompson Gas Kiln & Oven Co.
59 Carmine St., N. Y.
Send for Circular by mail.

MITCHELL VANCE & CO.,

MANUFACTURERS OF

Chandeliers

and every description of

GAS FIXTURES.

Also manufacturers of Fine Gilt Bronzes and Marble Clocks,
warranted best time-keepers. Mantel Ornaments, etc.

Salesrooms, 836 Broadway, N. Y.

Special Designs furnished for Gas Fixtures for Churches, Public
Halls, Lodges, etc.

THE GLOBE
STREET LAMP.



MINER'S PATENT
STREET LAMPS.

Are adapted for use of Streets, Parks,
Depots, Ferries, & Private Grounds.

WITH POSTS OR BRACKETS.

Jacob G. Miner,

No. 823 Eagle Ave., New York N. Y.

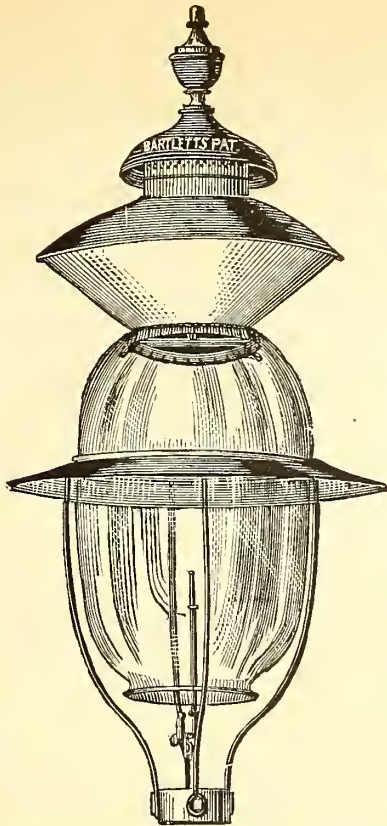

C. BARCALOW, PREST.

J. V. BARCALOW, SEC. & TREAS.

BARTLETT Street Lamp Mfg. Co.

MANUFACTURERS OF

Bartlett's Patent

GLOBE LAMPS.

FOR

Streets, Parks, Railroad Stations, Public
Buildings, Etc.

LAMP POSTS A SPECIALTY.

Office and Salesroom,

No. 35 Howard Street, N. Y. City.

Gas Companies and others intending to erect lamps and posts
will do well to communicate with us.

F. M. ROOTS.

S. C. ROOTS

D. T. ROOTS.

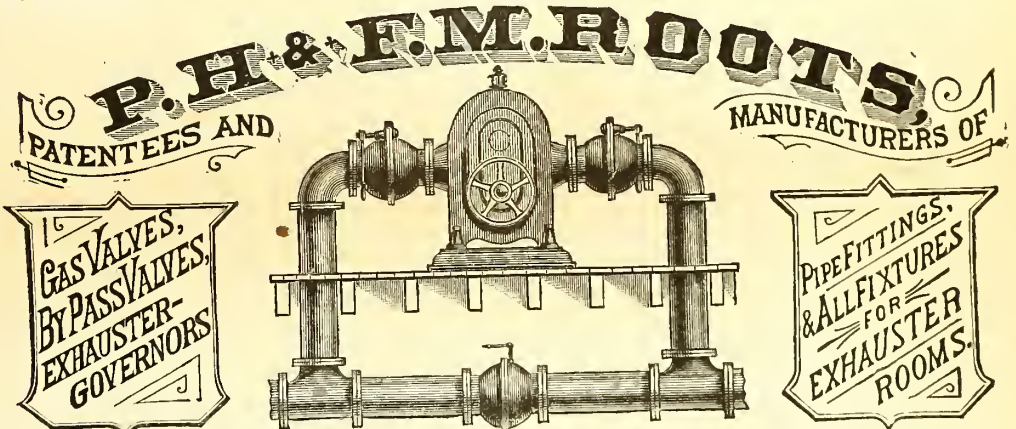

IMPROVED GAS EXHAUSTER,

WITH ENGINE ON SAME BED PLATE, OR WITHOUT.

BYE-PASSES, GAS VALVES, GOVERNORS, ELBOWS, PIPE-FITTINGS, Etc., FURNISHED TO ORDER,

P. H. & F. M. ROOTS, Patentees & Manufacturers, **CONNERSVILLE, IND.**

S. S. TOWNSEND, General Agent, 22 Cortland St. and 9 Dey St., N. Y.

JAS. BEGGS & CO., Selling Agents, 9 Dey St., N. Y.

COOKE & CO., Selling Agents, 22 Cortland St., N. Y.

✻ SEND FOR ILLUSTRATED CATALOGUE AND PRICE LIST. ✻

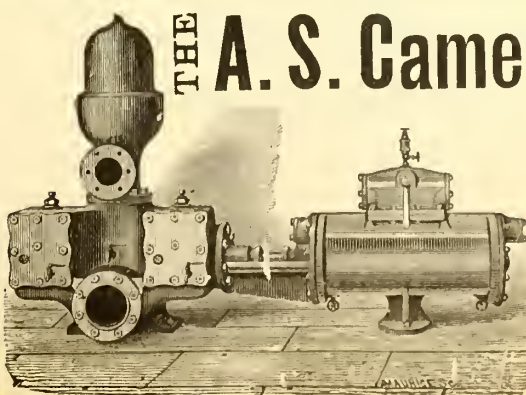

THE A. S. Cameron Steam Pump,

THE STANDARD OF EXCELLENCE.

Upward of 30,000 in Use.

BEST GAS WORKS PUMP

Ever Introduced.

Adapted to Every Possible Duty.

A. S. Cameron Steam Pump Works,

Foot East 23d St., N. Y.

J. H. GAUTIER & CO.
CORNER OF
GREENE AND ESSEX STREETS,
JERSEY CITY, N. J.

MANUFACTURERS OF

**Clay Gas Retorts,
Gas House Tiles,
Fire Bricks, Etc. Etc.**
Ground Clay, Fire Brick and
Fire Sand in Barrels,

J. H. GAUTIER.
C. E. GREGORY.

T. B. GAUTIER.
C. E. GAUTIER.

BROOKLYN
Clay Retort & Fire Brick Works,
(EDWARD D. WHITE & CO.)
Manufacturers of Clay Retorts, Fire Brick,
Gas House and other Tile.
VAN DYKE, ELIZABETH, RICHARD'S & PARTITION STS.
Office, 88 Van Dyke St., Brooklyn, N. Y.

LACLEDE FIRE BRICK MFG. CO.,
MANUFACTURERS OF
Fire Brick, Gas Retorts,

AND

ST. LOUIS STANDARD SEWER PIPE.

Blast Furnace and Cupola Linings, every description of Fire
Clay Material, Fire Clay Flue Linings, Chimney Tops
Dry Milled and Crude Fire Clays, etc.

OFFICE AND DEPOT

901, 903, and 905 Pine Street,
ST. LOUIS, MO.

ESTABLISHED IN 1845.

B. KREISCHER & SONS,

OFFICE FOOT OF HOUSTON ST., E. R., N. Y.

Gas Retorts,

TILES, FIRE BRICK.

AND EVERYTHING IN THE FIRE CLAY LINE.

MANHATTAN
FIRE BRICK & ENAMELLED CLAY
RETORT WORKS.
ADAM WEBER.

**CLAY GAS RETORTS
AND RETORT SETTINGS
FIRE BRICKS, TILES, ETC.,**

Office and Works, 15th Street and Avenue C., N. Y.



JAMES GARDNER, JR.
Works,
LOCKPORT STATION, PA.

—ESTABLISHED 1864.—

WILLIAM GARDNER & SON,
Successor to GARDNER BROTHERS.

WILLIAM GARDNER.
Office, COAL EXCHANGE,
PITTSBURGH, PA., P. O. Box 373.

Fire Clay Goods for Gas Works.

C. H. SPRAGUE, No. 70 KILBY STREET, BOSTON, MASS., Agent for the New England States.

OFFICE, 418 to 422 East 23d St., New York.

ESTABLISHED 1856.

WORKS, PERTH AMBOY, NEW JERSEY.

HENRY MAURER,
Excelsior Fire Brick & Clay Retort Works
CLAY GAS RETORTS, BENCH SETTINGS, FIRE BRICK, TILES, ETC.

STANDARD GAS RETORT AND FIRE BRICK COMPANY,

J. ANDERSON, PRES. & MANG'R.

OF IRONTON, OHIO.

C. PETERS, SECRETARY.

Clay Gas Retorts, Fire Brick, and Fire Clay Goods of Every Description.

Plans of Livesey-Somerville, McIlhenny, and other Furnaces, and Competent Workmen Supplied.

CHICAGO
Retort & Fire Brick Works,
OFFICE AND FACTORY,
Clark, Forty-Fifth, and La Salle Streets,
CHICAGO, ILL.

GEORGE C. HICKS, PRES. PAUL P. AUSTIN, SEC. & TREAS.

STANDARD
Clay Retorts and Settings.
BLOCKS & TILES
of every Shape and Size to Order.
Standard Fire Bricks.

NEWBIGGING'S
Gas Manager's Handbook.
Price, \$4.80.

EVERY GAS MAN SHOULD HAVE ONE.

Orders may be sent to this Office.

OAKHILL
GAS RETORT & FIRE BRICK
COMPANY.

PARKER, RUSSELL & CO.

City Office, 711 Pine Street,

ST. LOUIS, MO.

Our immense establishment is now employed almost entirely in
the manufacture of

MATERIALS FOR GAS COMPANIES.

We have studied and perfected three important points. Our re-
torts are made to stand changes of temperature, the strongest
heats of the furnace, and the abrasion of feeding and emptying.
Our customers are in almost every State of the Union, to all of
whom we refer.

THOS. SMITH, Prest. AUGUST LAMBLA, Vice-Prest. & Sup

BALTIMORE
RETORT & FIRE BRICK CO.

MANUFACTORY AT

LOCUST POINT, BALTIMORE, MD.

Connection with the City by Telephone.

Clay Retorts, Blocks & Tiles,
FIRE BRICK, FIRE CLAY,
AND FIRE CEMENT.

Red and Buff Ornamental Tiles and Chim-
ney Tops. Drain and Sewer Pipe (from
2 to 30 inches). Baker Oven Tiles
12 x 12 x 2 and 10 x 10 x 2.

WALDO BROS., 88 WATER ST., BOSTON, MASS

Sole Agents for New England States

THE AMERICAN METER CO.,

MANUFACTORIES,

508 to 514 West Twenty-second St., N. Y. Arch and Twenty-second St., Phila.
Nos. 244 & 246 North Wells Street, Chicago, Ill.

AGENCIES,

No. 177 Elm Street, Cincinnati, Ohio. Nos. 122 & 124 Sutter Street, San Francisco, Cal.
No. 810 North Second Street, St. Louis, Mo.

NEW

INCANDESCENT

Gas Fires

AND

OPEN

Fire Place

Heaters.

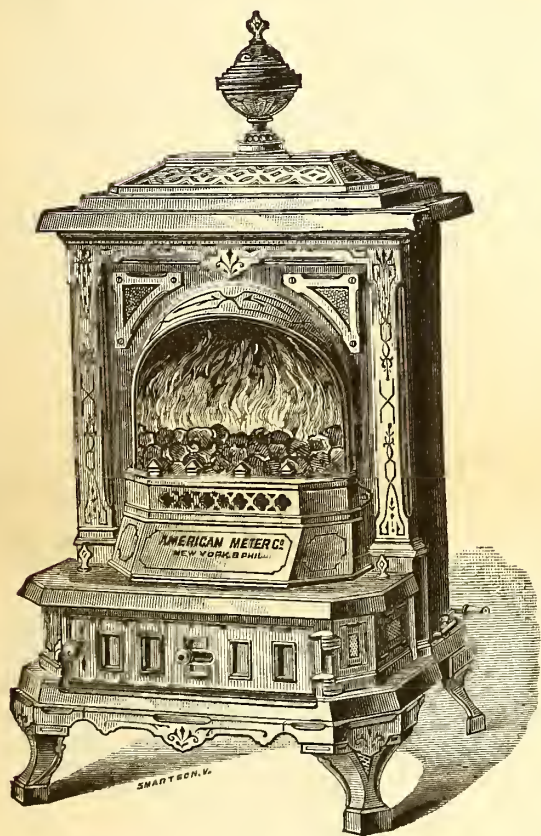

Open Fire Place Heater No. 19.
Fitted with the New Incandescent Gas Fire.



Open Fire Place Heater No. 17C.
Fitted with Illuminating Burners and Copper Reflector.

We call attention to Special Apparatus Heated by Gas for Manufacturing Purposes. Gas Furnaces for Tinmen's use; Furnaces for melting Solder and Type Metal; Apparatus for bending Carriage Panels (in successful operation in Carriage Manufactories); Water Heaters for Kitchen Boilers, Baths, etc., and for attaching to Heating Coils and Pipes for Conservatories.

THE COMPANY MANUFACTURES

GAS STOVES FOR COOKING AND HEATING PURPOSES

In all Sizes, for Domestic, Restaurant, and Hotel Use.

These Stoves may be seen in operation at our Retail Store, No. 223 Sixth Avenue, N. Y. Call and examine.

SEND FOR CATALOGUE OF TWENTY DIFFERENT STYLES OF HEATING STOVES.

A. H. M'NEAL,

BURLINGTON, N. J.

Flange-Pipes

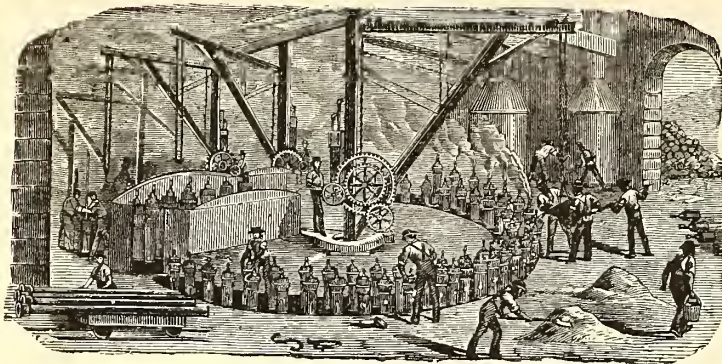

General Foundry Work.

CAST IRON PIPES FOR WATER AND GAS

JAMES S. MOORE, Pres.
BENJAMIN CHEW, Treas.

JAS. P. MICHELLON, Sec.
WM. SEXTON, Supt.

GLOUCESTER IRON WORKS, GLOUCESTER CITY, N. J.

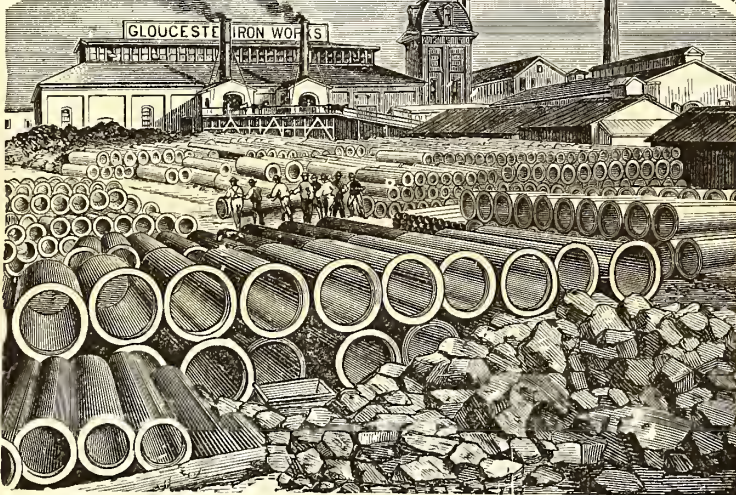

Cast Iron Gas & Water Pipes, Stop Valves, Fire Hydrants, Gasholders, &c.
Office No. 6 North Seventh Street, Philadelphia.

ESTABLISHED 1856.

WARREN FOUNDRY AND MACHINE CO.,

WORKS AT PHILLIPSBURGH, N. J.
NEW YORK OFFICE, 162 BROADWAY.

Cast Iron Water and Gas Pipe

FROM TWO TO FORTY-EIGHT INCHES DIAMETER.
ALSO ALL SIZES OF

FLANGE PIPE for Sugar House and Mine Work.
Branches, Bends, Retorts, Etc., Etc.

MATTHEW ADDY, President.

W. L. DAVIS, Selling Agent.

GEO. P. WILSHIRE, Sec. & Treas.

Cincinnati and Newport Iron and Pipe Company, NEWPORT, KY.

Lamp Posts
AND
BENCH CASTINGS

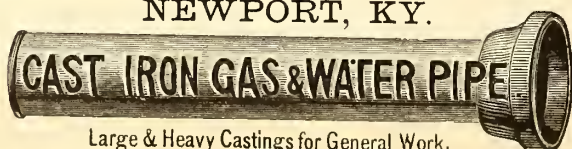

Branch
AND
SPECIAL CASTINGS
FOR GAS & WATER CO'S.

A Specialty.

Large & Heavy Castings for General Work.

Manufacture Pipe from 2 to 48 inches. All work guaranteed first quality.

Mellert Foundry and Machine Co. Limited.



Specials—Flange Pipe, Valves and Hydrants,
Lamp Posts, Retorts, etc.
Machinery and castings for Furnaces, Rolling Mills, Grist and
Saw Mills, Mining Pumps, Hoists, etc.
GENERAL OFFICE, - - - READING, PA.

CAST IRON Gas and Water Pipes,

From 2 to 48 Inches in Diameter.

FOX & DRUMMOND,

160 Broadway, N. Y. City.

THE OHIO PIPE COMPANY,

MANUFACTURERS OF

Cast Iron Gas & Water Pipe, BRANCH AND SPECIAL CASTINGS.

Gas-House Bench Castings, Hydraulics, Lamp Posts, Flange Pipe
and Specials, Architectural Castings, Building Columns,
Joists, Collar Grates, Sash Weights, etc.

GENERAL FOUNDERS AND MACHINISTS.

Columbus, Ohio.

LUDLOW VALVE MFG. CO.

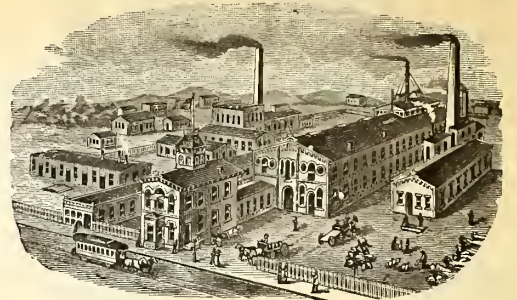

OFFICE AND WORKS,

938 to 954 River Street and 67 to 83 Vail Av.
TROY, N. Y.

Hydraulic Main Dip Regulators, also
Check Valves, Foot Valves, Yard-
wash and Fire Hydrants.
Send for Circulars.

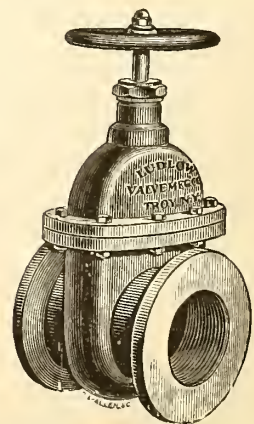

Valves.—Double and Single Gate, 1/2 in. to
48 in., outside and inside Screws. Indica-
tor, etc., for Gas, Water, Steam, and Oil.
and for Circulars.

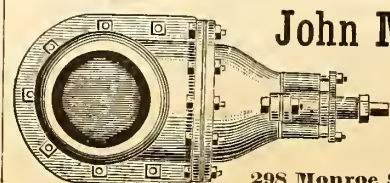

John McLean

Manufacturer of

**GAS
VALVES.**

298 Monroe Street, N. Y.

Siemens's Regenerative Gas Burners, For Lighting and Ventilating.

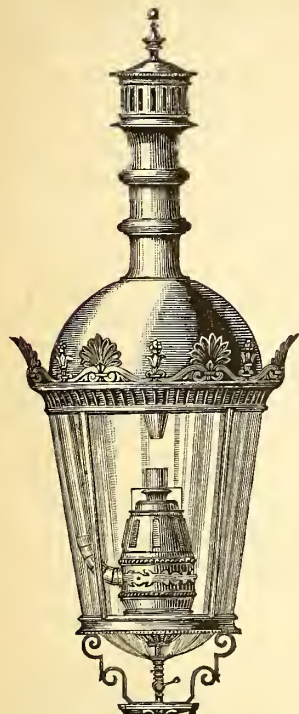

THE CHEAPEST, PUREST, AND MOST BRILLIANT OF ALL GAS LIGHTS.

Superior to the Electric Light in Economy, Beauty, & Steadiness.

SPECIALLY ADAPTED FOR LIGHTING HALLS, FACTORIES, OPEN SPACES, ETC.

Numerous Tests made by various Gas Companies in the United States show an Efficiency of Ten Candle Power per Cubic Foot of Gas.

General Agents:

- SIEMENS LIGHTING CO., 347 West Main St., Louisville, Ky.
- MEYER, MARSHALL & CO., 528 California St., San Francisco.
- DENNEHY, WOLF & O'BRIEN, 85 & 87 Dearborn St. Chicago, Ill.
- WILCOX & McGEARY, - No. 11 Bissel Block, Pittsburgh, Pa.
- T. T. RAMSDALL & CO., - 20 Swan Street, Buffalo, N. Y.
- SIEMENS GAS ILLUMINATING CO.,
Room 6, No. 157 Broadway, New York City.
- W. D. COLT, - - - - 1420 F Street, Washington, D. C.
- JOHN KIEFER, - - - 344 Lawrence, Street, Denver, Col.

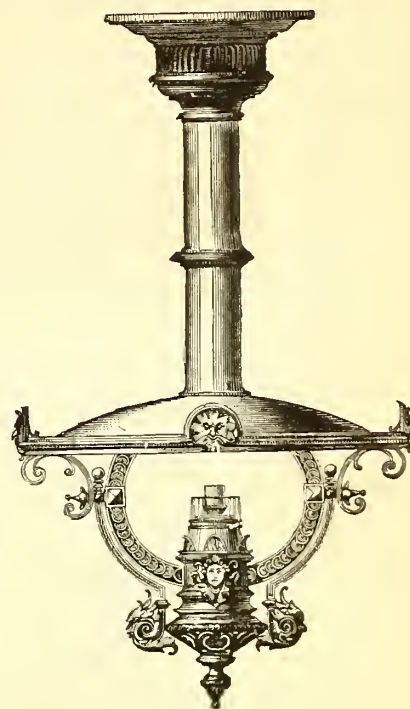

THE SIEMENS REGENERATIVE GAS LAMP COMPANY,
SOLE MAKERS FOR THE UNITED STATES,
N. E. Cor. 21st. St. and Washington Av., Philadelphia. Pa.

THE "STANDARD" WASHER-SCRUBBER, KIRKHAM, HULETT & CHANDLER'S PATENT.

Total Capacity per 24 Hours of "Standard" Washers Ordered During the Following Years.

1877.....	4,000,000 cubic feet.
1878.....	4,750,000 "
1879.....	21,545,000 "
1880.....	42,967,500 "
1881.....	36,462,500 "
1882.....	39,300,000 "
1883.....	57,735,000 "
1884.....	26,177,500 "
Total.....	235,937,500 cubic feet.

Total Number and Capacity per 24 Hours of "Standard" Washers Erected and in Course of Erection in the Several Countries

	Number.	Cubic Feet per Day.
Great Britain..	151	157,070,000
Western Hemisphere.....	38	39,337,500
Australia.....	18	12,150,000
New Zealand	2	650,000
France	6	4,550,000
Belgium.....	8	5,420,000
Germany	16	8,200,000
Holland.....	4	4,160,000
Denmark.....	1	150,000
Russia	2	3,500,000
Spain	1	350,000
India.....	1	400,000
Total.....	248	235,937,500

**THE CONTINUED POPULARITY
Of these Machines**

Will be recognized from the following extracts from letters from representatives of some of the companies having them in use:

PROVIDENCE GAS COMPANY, }
PROVIDENCE, R. I., Nov. 24, 1884. }
GEO. SHEPARD PAGE, Esq., New York:

Dear Sir—We are now using less than a gallon of water per thousand in the "Standard," and the gas at the outlet will not color turmeric paper.

Yours, etc.,
A. B. SLATER, Treasurer.

PORTLAND GAS COMPANY. }
PORTLAND, ORE., Nov. 29, 1884. }
GEO. SHEPARD PAGE, New York:

Dear Sir—Our Scrubber appears to run to our entire satisfaction, and we are pleased to say that it takes out all the ammonia from the gas. This is very satisfactory to us, as we were ruining our meters at a fearful rate heretofore. The amount of water used is very inconsiderable as compared with our old process. The machine runs very smooth and still.

Very respectfully,
H. C. LEONARD, Secretary.

"Standard" Washers Ordered Recently.

	Cu. Ft. per Day
Auneberg Gas Co.....	200,000
Bombay Gas Co.....	400,000
Brussels Co.....	1,250,000
CHICAGO, two, 1,000,000 each.....	2,000,000
Chemnitz Gas Co	1,000,000
CITIZENS GAS CO., BUFFALO.....	750,000
Coke Works in Zabre, Ober-Schlesien.....	1,500,000
Cokerel der Friedenschutte, Upper Silesia.	700,000
Dumfries Corporation.....	250,000
Dunedin Gas Co., New Zealand	400,000
GEORGETOWN, D. C.....	250,000
King's Lynn Gas Co.....	300,000
Leiden, Holland.....	600,000
Lincoln Gas Co.....	400,000
Liverpool Gas Co.....	2,000,000
"	3,000,000
LOUISVILLE GAS CO.....	1,500,000
Numea Gas Co.....	100,000
PITTSBURGH GAS CO.....	1,500,000
PAWTUCKET, R. I.....	500,000
PORTLAND GAS CO., Oregon ..	562,500
SAN FRANCISCO GAS CO.....	4,000,000
Sheepbridge	40,000
ST. LOUIS GAS CO.....	2,000,000
Sydney Gas Co.....	2,500,000
WASHINGTON, D. C. GAS CO.....	2,000,000
Whitechurch Gas Co	175,000
Total.....	29,677,500

GEO. SHEPARD PAGE, No. 69 WALL STREET, NEW YORK,
SOLE AGENT FOR THE WESTERN HEMISPHERE.

R. D. WOOD & CO.,

400 Chestnut Street, Phila., Pa.

Cast Iron Gas & Water Pipe, Water Machinery & Gas Apparatus

Cast Iron Pipe, Fire Hydrants, Eddy Valves, Lamp Posts, Large Loam Castings, Flanged Pipe, Sugar House Work, Iron Roofs and Floors, Wrought & Cast Iron Tanks, Turbine Water Wheels and Pumps.

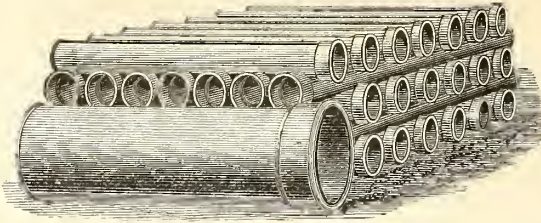

Gasholders, Lime Trays, Center Valves, Purifiers, Bench Work, Exhausters, Condensers, Governors, Scrubbers, Gas Valves, Station Meters, Cast Iron Pipe Fittings.

Manufacturers of Heavy Castings and Machinery of Every Description.

ENGINEERS & CONTRACTORS FOR THE ERECTION OF GAS WORKS, & ALL MACHINERY CONNECTED THEREWITH

Estimates and specifications furnished for erection of new works or the extension or alteration of old ones.

Foundries and Works. - - Millville, Florence, and Camden, N. J.

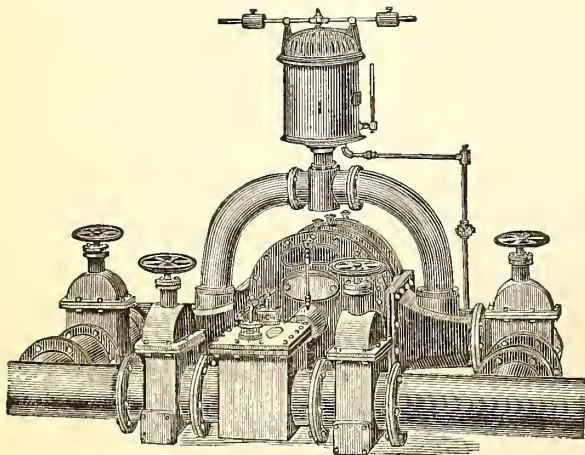

SMITH & SAYRE MFG. COMPANY,

G. G. PORTER, Prest.

245 Broadway, N. Y.

CHAS. W. ISBELL, Sec'y.

Machinery & Apparatus for Gas Works

Drawings, Plans, and Estimates Furnished for the Improvement, Extension, or Alteration of Gas Works, or for the Construction of New Works.

Mackenzie's Patent Rotary and Steam Jet Gas Exhausters, Governors, Compensators, Condensers, Washers, Scrubbers. Isbell's Patent Automatic Street Pressure Governor, Gas and Water Valves, Hydraulic Main Dip Regulator, Bench Castings, etc. Purifying Boxes and "Standard" Scrubbers. Isbell's Patent Self-Sealing Retort Doors.

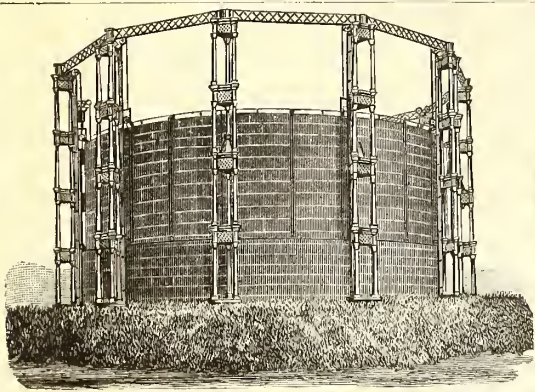

W. E. Tanner, Pres., W. R. Trigg, V.-Pres., A. Delaney, Supt.

Tanner & Delaney Engine Co.

RICHMOND, VA.

Gas Apparatus,

INCLUDING

Condensers of various styles, Scrubbers, Holders, Purifiers, Castings for Retort Houses, Etc.

ALSO STEAM ENGINES AND BOILERS.

Plans, Specifications and Estimates Furnished.

MORRIS, TASKER & CO.,

Limited,

Builders of Gas Works,

PHILADELPHIA, PA.

To Gas Companies.

We make to order **CAP BURNERS** to burn any amount under a stated pressure. Send for samples.

Also, SERVICE CLEANERS, DRIP PUMPS, and STREET MAIN PROVING APPARATUS.

C. A. GEFROER,

248 N. 8th Street, Phila., Pa.

SOUTHWARK FOUNDRY AND MACHINE COMPANY,

Successors to MERRICK & SONS. Established in 1836.

No. 430 Washington Avenue, Philadelphia, Pa.

MANUFACTURERS OF

Single and Telescopic Gasholders,

BENCH CASTINGS,

Washers, Scrubbers, Condensers, Purifiers,

And all apparatus necessary for the construction of improved new gas works and in the extension of established works. Also manufacturers of

Gas Engines, and of all descriptions of Steam and Hydraulic Machinery, and of Boiler and Tank Work.

Plans, specifications, and estimates furnished promptly on application.

WM. HENRY WHITE,

Consulting & Constructing

Gas Engineer & Contractor.

ESTIMATES, PLANS, AND SPECIFICATIONS FURNISHED FOR NEW WORKS OR EXTENSIONS OF EXISTING WORKS.

32 Pine St., New York City.

Correspondence solicited.

KERR MURRAY MFG. CO.,

MANUFACTURERS OF

Single Lift and Telescopic

GASHOLDERS.

Built, 1884:

Altoona, Pa.	Capacity, 160,000 cubic feet.
Pittsburgh, Pa.	" 250,000 "
" "	" 220,000 "
Bellaire, Ohio	" 50,000 "
Youngstown, Ohio	" 60,000 "
Canton, "	" 60,000 "
Akron, "	" 80,000 "
Xenia, "	" 10,000 "
Adrian, Mich.	" 65,000 "
Ypsilanti, Mich.	" 25,000 "
Muskegon, "	" 70,000 "
South Bend, Ind.	" 70,000 "
Anderson, "	" 20,000 "
Plainfield, "	" 10,000 "
Springfield, Illinois	" 100,000 "
Evanston, "	" 50,000 "
Freeport, "	" 35,000 "
Elgin, "	" 60,000 "
Sheboygan Wis.	" 20,000 "
Key West Fla.	" 10,000 "

Plans and estimates furnished for the erection of new and the rebuilding of old works. Address

Kerr Murray Mfg. Co.,
FORT WAYNE, IND.

JAMES R. FLOYD,
(SUCCESSOR TO HERRING & FLOYD)

Oregon Iron Works,
531 to 543 West 20th St., N. Y.

Practical Builders of Gas Works,
MANUFACTURERS OF
ALL KINDS OF CASTINGS
AND
APPARATUS FOR GAS-WORKS.

BENCH CASTINGS

from benches of one to six Retorts each.

WASHERS: MULTITUBULAR AND AIR CONDENSERS; CONDENSERS; SCRUBBERS

wet and dry, and

EXHAUSTERS for relieving Retorts from pressure.

BENDS and BRANCHES of all sizes and description.

FLOYD'S PATENT MALLEABLE RETORT LID.

PATENT SELF-SEALING RETORT LIDS.

FARMER'S PATENT BYE-PASS DIP-PIPE.

SABBATON'S PATENT FURNACE DOOR AND FRAME.

BUTLER'S COKE SCREENING SHOVELS.

GAS GOVERNORS,

and everything connected with well regulated Gas Works at low price, and in complete order.

SELLER'S CEMENT

for stopping leaks in Retorts.

N. B.—STOP VALVES from three to thirty inches— at very low prices.

Plans, Specifications, and Estimates furnished.

CONTINENTAL WORKS.

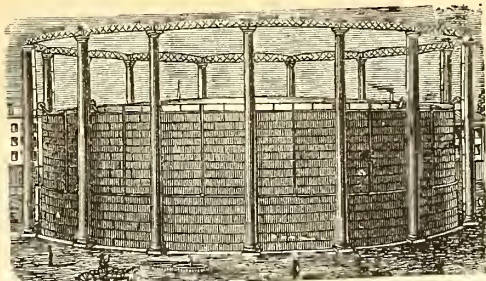

GASHOLDERS OF ANY MAGNITUDE.

T. F. ROWLAND, Proprietor.
GREENPOINT, BROOKLYN, N. Y.

ENGINEER AND MANUFACTURER OF

GAS-HOLDERS.

CONDENSERS, SCRUBBERS, VALVES,

PURIFIERS, RETORTS, and HY-

DR АуLIC MAINS,

and all other articles connected with the Manufacture and Distribution of Gas. Plans and Specifications prepared and Proposals given for the necessary Plant for Lighting Cities, Towns, Mansions, and Manufactories.

H. RANSHAW, Prest. & Mangr. WM. STACEY, Vice-Pres. T. H. BIRCH, Asst. Mangr. R. J. TARVIN, Sec. & Treas.

STACEY MFG. CO.,

MANUFACTURERS OF

Single and Telescopic Gasholders,

IRON ROOFS, BRIDGES, LAMP POSTS,

Water and Oil Tanks, Coal Elevator Cars,
COKE CRUSHERS, BENCH CASTINGS,

And all kinds of Wrought and Cast Iron Work used in the erection of Coal and Oil Gas Works. Rolling Mill Machinery and Heavy Castings a Specialty.

Foundry:
33, 35, 37 & 39 Mill Street.

Wrought Iron Works:
16, 18, 20, 22, 24 & 26 Ramsey Street.

Cincinnati, Ohio.

BARTLETT, HAYWARD & CO.,

Office, 24 Light.

BALTIMORE, MD.

Works, Pratt &

PURIFIERS.

Roofs.
Bench Castings.

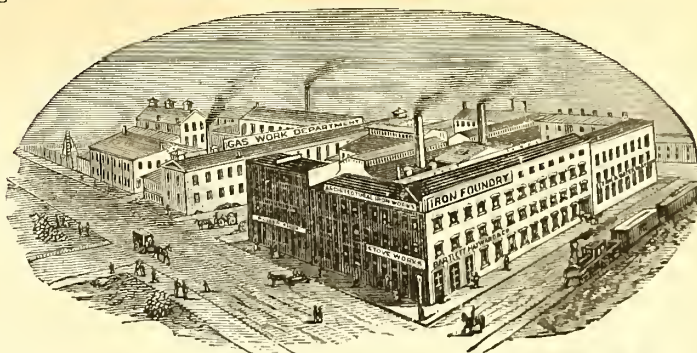

SCRUBBERS.

CONDENSERS.

GASHOLDERS.

CONSTRUCTING ENGINEERS AND BUILDERS OF GAS WORKS.

1842. **DEILY & FOWLER,** 1885.

Laurel Iron Works.

Address, No. 39 Laurel Street, Philadelphia, Pa.

MANUFACTURERS OF

GASHOLDERS,

Single or Telescopic, with Cast or Wrought Iron Guide Frames.

HOLDERS BUILT SINCE 1880:

Mount Joy, Pa.	West Point, N. Y.	Galveston, Texas (2d.)	Kalamazoo, Mich. (3d.)	Newport, R. I.
Rockaway B'ch, N.Y. (2)	Fitchburg, Mass.	Marlboro, Mass.	Glen Island, N. Y.	Portland, Oregon.
Zanesville, O. (2d.)	New London, Conn.	Denver, Col.	Warren, Ohio.	Allegheny, Pa. (2d.)
Lancaster, O.	Derby, Conn.	Chicago, Ill. (West Side)	Bath, N. Y.	Atlanta, Ga. (2d.)
Blackwell's Island N. Y.	Bridgeport, Conn.	Pittsburgh, Pa. (S. Side)	Lynn, Mass.	N.Y. City (Central Ga.)
Waltham, Mass., (1st.)	Allegheeny, Pa. (1st.)	Pawtucket, R. I.	New Bedford, Mass.	Lynchburg, Va. (2d.)
Dorchester, Mass.	St. Hyacinth, Can.	Brookline, Mass.	Waterbury, Conn.	Roudont, N. Y.
Wheeling, West Va.	Norwalk, O.	Sherbrooke, Can.	Deseronto, Can.	Saylesville, R. I.
Lansing, Mich.	Brattleboro, V.	Burlington, N. J. (2d.)	Hosic Falls, N. Y. (2d.)	Atlantic City, N. J.
Flint, Mich.	Waltham, Mas (2d.)	Bridgeton, N. J.	Bethlehem, Pa.	Augusta, Ga.
Galveston, Texas (1st.)	West Chester, Pa.	Bay City, Mich.	Atlanta, Ga. (1st.)	Waltham, Mass. (2)
Milton, Pa.	Baltimore, Md.	Erie, Pa.	Savannah, Ga.	
Seranton, Pa.	Holidaysburg, Pa.	Jackson, Mich.	Montgomery, Ala	

GAS COALS.

GAS COALS.

GAS COALS.

JAMES D. PERKINS.

PERKINS & CO.,

F. SEAVERNS.

General Sales Agents for

The Youghioghenny River Coal Company's

OCEAN MINE YOUGHIOGHENY GAS COAL.

The Coal from the Ocean Mine (recently operated by Messrs. W. L. Scott & Co., of Erie, Pa.,) is now used by all the leading Gas Companies in the United States from Maine to Texas, and is recognized as *the only reliable Youghioghenny Gas Coal.* (See Map on p. 87 of this Journal, Feb. 16, 1885.)

P. O. Box 3695,
New York.

PERKINS & CO., 228 and 229 N. Y. Produce Exchange

**BEAVER STREET
ENTRANCE.**

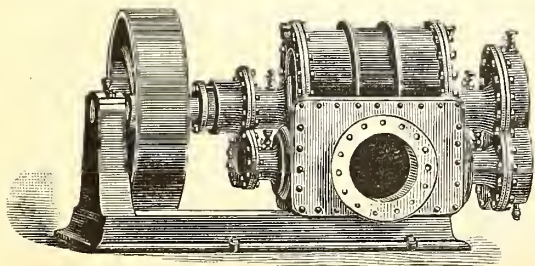

Gas Exhauster Driven by Belt.

The Wilbraham Gas Exhauster,

"BAKER SYSTEM,"

WITH ENGINE ATTACHED, ON SAME BED PLATE OR WITHOUT.

Best, Cheapest and Most Durable Exhauster known.

WILBRAHAM BROS.,

No. 2320 Frankford Avenue, Philadelphia, Pa.

CHURCH'S REVERSIBLE SCREEN FOR GAS PURIFIERS

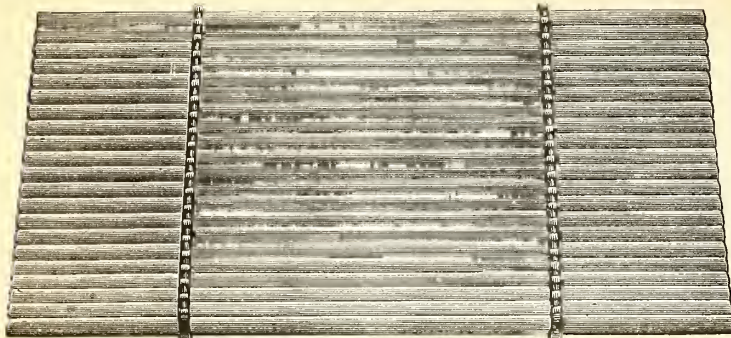

PATENTED JULY 9, 1878.

References in all parts of the country. Send for circular and list of companies who now have the Screen in use.

Pipe Coverings.

Fireproof, Non-Conducting Coverings for

**STEAM PIPES, BOILERS,
And all Hot Surfaces.**

Made in sections three feet long. Easy to apply; light and cheap. Asbestos Materials, Fibre, Braided Packing, and Cement. These goods are used at Continental Works, Br'klyn.

CHALMERS-SPENCE COMPANY, 419 & 421 EIGHTH ST., N. Y.



**WM. FARMER, ENGINEER,
32 Park Place, Room 36, New York.**

THE CHEMIST'S ASSISTANT; OR, KINDERGARTEN SYSTEM OF CHEMISTRY.

A system by which the elements and their valences are represented by illustrations and solid bodies.

BOX AND PAMPHLET COMPLETE, \$2.50.

JOS. R. THOMAS, C.E.,

May be Consulted on all Matters Relating to Gas Works and Gas Manufacture.

ADDRESS THIS OFFICE.

W. H. DOAN,

REFINER OF

NAPHTHA and GASOLINES

ALSO MANUFACTURER OF

A Special Grade of Naphtha for Gas Companies

FOR ENRICHING COAL GAS.

Correspondence solicited.

No. 43 Euclid Avenue, Cleveland, Ohio.

**Iron Sponge,
GAS EXHAUSTERS,**

AUTOMATIC GAS GOVERNORS,

**CONNELLY & CO., Limited,
No. 407 BROADWAY, NEW YORK CITY.**

BOOKS.

DISTILLATION OF COAL TAR AND AMMONIACAL LIQUOR.

By GEORGE LUNGE. Price \$8.50.

A TREATISE ON THE COMPARATIVE COMMERCIAL VALUES OF GAS COALS AND CANNELS.

By DAVID A. GRAHAM. 8vo., Cloth. Price \$3.

Orders for these books may be sent to this office.

A. M. CALLENDER & CO.,

42 PINE ST., N. Y. CITY.

GAS COALS.

GAS COALS.

GAS COALS,

Newburgh Orrel Coal Co.,

MINERS AND SHIPPERS OF

**Newburgh Orrel, Tyrconnell
and Palatine Gas Coals.**

ALSO SHIPPERS OF FOUNDRY COKE.

Mines Situated at

Newburgh, Flemington & Fairmont, W.Va.

HOME OFFICE,

25 S. Gay St., Baltimore.

CHARLES MACKALL,
MANAGER.

CHAS. W. HAYS, Agent in New York,

Room 92, WASHINGTON BUILDING, No. 1 Broadway.

Shipping wharves at Locust Point. References furnished when required. Special attention given to chartering vessels.

THE DESPARD COAL COMPANY

OFFER THEIR SUPERIOR

DESPARD COAL

To Gas Light Companies and Manufacturers of Fire Clay Goods
Throughout the Country.

ROUSEL & HICKS, } AGENTS. { BANGS & HORTON,
71 Broadway, N. Y. } { 16 Kilby St., Boston.

Mines in Harrison Co., West Va. Wharves, Locust Point, Balt.
Company's Office, 15 German St., Baltimore, Md.

Among the consumers of Despard Coal we name: Manhattan
Gas Light Co., N. Y.; Metropolitan Gas Light Co., N. Y.; Jersey
City, (N. J.) Gas Light Co.; Washington (D. C.) Gas Light Co.;
Portland (Maine) Gas Light Co. Reference to them is requested.

WELSH "ABERNANT"

Silica Dinas Fire Brick & Cement.

Unrivalled for Endurance Under Intense
Heat. Percentage of Silica, 95.64.

Also SCOTCH "BLOCHAIRN" FIRE BRICK.

A. T. CHUR,

SOLE AGENT FOR THE UNITED STATES,

Mills Building, Room 14, Fifth Story, New York.

PRESERVE

The Journal

BY THE USE OF

THE STRAP FILE.

Advantages of the Strap File.

- 1st. It is simple, strong, and easily used.
- 2d. Preserves papers without punching holes.
- 3d. Will always lie flat open.
- 4th. Allows any paper on file to be taken off without disturbing the others.

Price, \$1.25. Sent either by express or mail, at directed. By mail the postage will be 20 cents, which will be added to the price of the Binder.

A. M. CALLENDER & CO., 42 PINE ST., N. Y.

**THE
PENN GAS COAL CO.**

OFFER THEIR

Coal, Carefully Screened & Prepared for Gas Purposes.

Their Property is located in the Youghiogheny Coal Basin, near Irwin and Penn Stations on the Pennsylvania Railroad, and on the Youghiogheny River.

Principal Office:

209 SOUTH THIRD STREET, PHILA., PA.

Points of Shipment:

Pennsylvania Railroad Piers; Greenwich Wharves, Delaware River; Pier No. 1 (Lower Side), South Amboy, N. J.

Chesapeake & Ohio Railway Coal Agency,

FOR THE SALE OF THE

**Superior Kanawha Gas Coals, Cannelton Cannel,
Also, SPLINT AND STEAM COALS**

From the Kanawha and New River Regions, on the line of the Chesapeake & Ohio R'way.

C. B. ORCUTT, Sales Agent. | OFFICE, 150 BROADWAY, N. Y.

FRANCIS H. JACKSON, PRESIDENT.

EDMUND H. MCCULLOUGH, SEC. & TREAS.

THE WESTMORELAND COAL CO.

Chartered 1854.

**Mines situated on the Pennsylvania and the Baltimore
and Ohio Railroads, in Westmoreland County, Penn.**

POINTS OF SHIPMENT:

PHILADELPHIA, BALTIMORE, SOUTH AMBOY, N. J.
WATKINS (SENECA LAKE), N. Y.

Since the commencement of operations by this Company its well-known Coal has been largely used by the Gas Companies of New England and the Middle States, and its character is established as having no superior in gas-giving qualities, and in freedom from sulphur and other impurities.

Principal Office, 224 South 3d St., Phila., Pa.

The Management of Small Gas Works.

By C. J. R. HUMPHREYS. Price, \$1.

A. M. CALLENDER & CO., 42 Pine St., N. Y.

CATHELL'S

Gas Consumer's Manual.

Enables every gas consumer to ascertain at a glance, without any previous knowledge of the gas meter, the quantity and money value of the gas consumed. Also the best method of obtaining from gas the largest amount of its light. It will be to the advantage of Gas Companies to supply their consumers with one of these Guides, as a means of preventing complaint arising from their want of knowledge in regard to the registration of meters.

A. M. CALLENDER & CO., 42 Pine St., N. Y.

King's Treatise on Coal Gas.

The most complete work on Coal Gas ever published.

Three Vols. Bound, \$30.

A. M. CALLENDER & CO., 42 Pine St., N. Y.

**AMERICAN
GAS LIGHT JOURNAL.**

\$3.00 per Annum.

A. M. CALLENDER & CO

42 Pine Street, N. Y. City.



INTERNATIONAL--1876--EXHIBITION.

The U. S. Centennial Commission

HAVE DECREED AN AWARD TO

HARRIS, GRIFFIN & CO.,



Twelfth and Brown Streets, Philadelphia, Pa., No. 49 Dey Street, N. Y. City, and No. 75 North Clinton Street, Chicago, Ill.,

FOR THE FOLLOWING REASONS :

The Exhibit consists of a Series of METERS from the Largest Size Station Meters for the use of the MANUFACTURE OF GAS, to those for the use of the ORDINARY CONSUMER. The Instruments are WELL MADE, RELIABLE as to INDICATION, and embody a number of sundry improvements which, with the general character of the Exhibit, entitle the whole to commendation.

Attest—J. L. CAMPBELL,
Secretary, pro-tem.

Signed—A. T. GOSHORN,
Director General

J. R. HAWLEY,
President

CHARLES E. DICKEY.

JAMES B. SMALLWOOD.

CHARLES H. DICKEY.

Maryland Meter and Manufacturing Co.,

DICKEY, TANSLEY & CO.,

Established 1866.

Nos. 22 and 24 Saratoga Street, Baltimore, Md.
No. 46 La Salle St., Chicago, Ill.

MANUFACTURERS OF

DRY GAS METERS, STATION METERS, GLAZED METERS, TEST METERS, METER PROVERS, PRESSURE AND VACUUM REGISTERS, GOVERNORS, INDICATORS, SERVICE AND METER COCKS, AND METER CONNECTIONS.

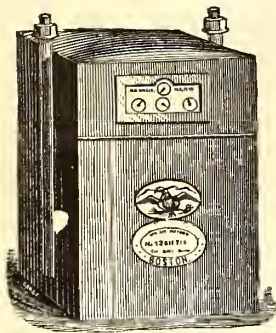

Dry Gas Meter.

With 39 years' experience and the best facilities for manufacturing, is enabled to furnish reliable work and answer orders promptly.

NATHANIEL TUFTS,

No. 153 Franklin Street, Boston, Mass.,

MANUFACTURER OF

DRY GAS METERS.

Station Meters of any Capacity.

Test and Experimental Meters, Pressure Registers, Pressure Gauges, Pressure and Vacuum Gauges.

METER PROVERS, PHOTOMETERS, STREET LANTERNS, ETC., ETC.

Patent Cluster Lanterns for Street Illumination.

SCIENTIFIC BOOKS.

We are prepared to furnish to Gas Managers, and others interested in the topics treated of, the following books, at prices named :

KING'S TREATISE ON THE MANUFACTURE OF COAL GAS. Three vols.; \$10 per vol.	GAS CONSUMER'S MANUAL, by E. S. CATHELS, C.E. 10 cts.	A PRACTICAL TREATISE ON GAS AND VENTILATION with Special Relation to Illuminating, Heating, and Cooking by Gas, by E. E. PERKINS. \$1.25.
GAS MANUFACTURE, by WILLIAM RICHARDS. 4to., with numerous Engravings and Plates, in Cloth binding. \$12.	PRACTICAL TREATISE ON HEAT, by THOMAS BOX. Second edition. \$5.	PURIFICATION OF COAL GAS, by R. P. SPICE. 8vo. \$3.
THE GAS ANALYST'S MANUAL, by F. W. HARTLEY. \$2.50.	GAS WORKS—THEIR ARRANGEMENT, CONSTRUCTION, PLANT, AND MACHINERY. \$8.	HOW TO MANAGE GAS, by F. WILKINS. Paper. 20 cents.
ANALYSIS, TECHNICAL VALUATION, PURIFICATION, and USE OF COAL GAS, by REV. W. R. BOWDITCH, M.A.; with Engravings; 8vo., Cloth. \$4.50.	COAL; ITS HISTORY AND USE, by PROF. THORPE. \$3.50.	THE GAS MANAGER IN THE LABORATORY, by a Practical Student. 8vo., Cloth. \$1.50.
GAS MEASUREMENT AND GAS METER TESTING by F. W. HARTLEY. \$1.60.	THE GAS WORKS OF LONDON, by COLBURN. 60 cents.	THE DOMESTIC USES OF COAL GAS, AS APPLIED TO LIGHTING, by W. SUGG. \$1.40.
GAS CONSUMER'S HANDBOOK, by WILLIAM RICHARDS, C.E.; 16mo., Sewed. 20 cents.	THE GAS FITTER'S GUIDE, Showing the Principles and Practice of Lighting with Coal Gas, by JOHN ELDRIDGE. 40 cents.	DISTILLATION OF COAL TAR AND AMMONIACAL LIQUOR, by GEO. LUNGE. \$8.50.
	GAS WORKS, AND MANUFACTURING COAL GAS, HUGHES. \$2.20.	A TREATISE ON THE COMPARATIVE COMMERCIAL VALUES OF GAS COALS AND CANNELS, by D. A. GRAHAM 8vo., Cloth. \$3.
	THE MANAGEMENT OF SMALL GAS WORKS, by C. J. R. HUMPHREYS. \$1.	

The above will be forwarded by express, upon receipt of price. We take especial pains in securing and forwarding any other Works that may be desired, upon receipt of order. All remittances should be made by check, draft, or post office money order.

A. M. CALLENDER & CO., No. 42 Pine Street, New York.

T. C. HOPPER, Pres. G. J. McGOURKEY, Vice-Pres. (New York). WM. N. MILSTED, Gen. Supt. & Treas. (New York). WM. H. DOWN Sec.

AMERICAN METER COMPANY,

WET AND DRY GAS METERS. STATION METERS. EXHAUSTER GOVERNORS. DRY CENTRE VALVES. GOVERNORS FOR GAS WORKS. PRESSURE REGISTERS. PRESSURE & VACUUM REGISTERS. PRESSURE & VACUUM GAUGES. CRESSON GAS REGULATORS. MARSLAND WATER METERS. METER PROVERS. PORTABLE TEST METERS. EXPERIMENTAL METERS. AMMONIA TEST METERS. BAR AND JET PHOTOMETERS.

Manufactories:
512 W. 22d St., N. Y.
Arch & 22d Sts., Phila.

GAS STOVES,
SUGG'S "STANDARD" ARGAND BURNERS,
SUGG'S ILLUMINATING POWER METER,
Wet Meters, with Lizar's "Invariable Measuring" Drum.

Agencies:
177 Elm Street, Cincinnati.
244 & 246 N. Wells Street, Chicago.
810 North Second Street, St. Louis.
122 & 124 Sutter St., San Francisco.

HELME & McILHENNY,

(Successors to Harris & Brother. Established 1848.)

GAS METER MANUFACTURERS,

CONTINUE AS HERETOFORE AT THE OLD ESTABLISHMENT,

Nos. 1115 and 1117 Cherry Street, Philadelphia, Pa.,

To Manufacture Wet and Dry Gas Meters, Station Meters, Experimental Meters, Meter Provers, Center Seals, Pressure Registers, GOVERNORS, INDICATORS, PHOTOMETERS, & ALL OTHER KINDS OF APPARATUS FOR USE IN GAS WORKS.

From our long practical experience of the business, and from our personal supervision of all work, we can guarantee all orders to be executed promptly, and in every respect satisfactorily.

WM. WALLACE GOODWIN, Prest. and Treas.

WM. H. MERRICK, V.-Prest.

S. L. JONES, Sec.

S. V. MERRICK, Supt.

THE GOODWIN GAS STOVE AND METER COMPANY,

Successors to W. W. GOODWIN & CO.

1012, 1014 and 1016 Filbert St., Phila., Pa. 142 Chambers St., New York.
76 Dearborn St., Chicago, Ill.

WALDO BROS., Agents, 88 Water St., Boston.

MANUFACTURERS OF THE "SUN DIAL" GAS STOVES, FOR COOKING AND HEATING PURPOSES.

Dry and Wet GAS METERS, Station Meters (Square, Cylindrical or in Staves) Glazed Meters, King's and Sugg's Experimental Meters, Lamp Post Meters, Etc., Etc., Meter Provers (sizes 2, 5 and 10 feet), Pressure Gauges of all kinds, Pressure Registers, Pressure and Vacuum Registers, Pressure Indicators (sizes 4 inch, 6 inch and 9 inch), King's Pressure and Vacuum Gauges, Dry and Wet Centre Seals, Dry and Wet Governors, Exhauster Governors, Photometers of all descriptions. Lethby's Sulphur and Ammonia Test Apparatus complete—also Testing and Chemical Apparatus of all kinds, and of the most perfect description, for all purposes relating to Gas.

GOODWIN'S IMPROVED LOWE'S JET PHOTOMETER.

Agents for Bray's Patent Gas Burners and Lanterns.

Special attention to repairs of Meters, and all apparatus connected with the business.
All work guaranteed first class in every particular, and orders filled promptly.

G. B. EDWARDS, Mang'r, New York.
E. H. B. TWINING, Mang'r, Chicago.
A. B. STANNARD, Agent.

D. McDONALD & CO.,

GAS METER MANUFACTURERS.

(Established 1854.)

51 Lancaster St., Albany, N. Y. 34 & 36 West Monroe St., Chicago, Ill.

STATION METERS, EXPERIMENTAL METERS, METER PROVERS, PRESSURE & VACUUM REGISTERS, PRESSURE GAUGES, ETC.

Also STAR GAS STOVES, RANGES, and HEATING STOVES.

We use only the very best materials, and employ the most skilled labor, and by our long experience (20 years) and personal supervision of every detail, we feel justified in assuring the public that our goods will give perfect satisfaction. Every Meter emanating from our establishment will bear the State Inspector's BADGE, and will be fully warranted by us. Our Annual and Calendar will be sent to Gas Companies upon application.

KING'S TREATISE ON COAL GAS.

The most complete work on Coal Gas ever published. Three vols., bound, \$30.

A. M. CALLENDER & CO., No. 42 Pine Street, New York.

THE "OTTO" GAS ENGINE.

Guaranteed to Consume 25 to 75
Per Cent. LESS GAS than ANY OTHER GAS ENGINE
PER BRAKE HORSE POWER.

TWIN ENGINES Impulse every revolution.
THE STEADIEST RUNNING GAS ENGINE YET MADE.

ENGINES AND PUMPS COMBINED,

For Hydraulic Elevators, Town Water Supply, or Railway Service.

Special Engines for Electric Light Work.

OVER 15,000
IN USE.

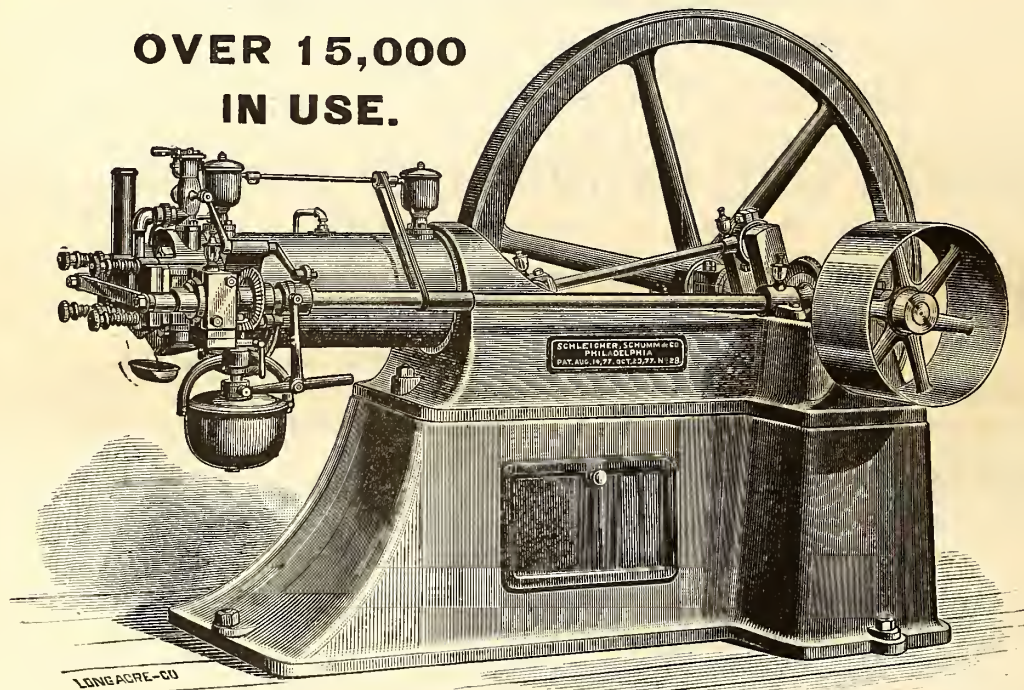

The Otto Gas Engine is now consuming, at a moderate computation, 2000 millions cubic feet of gas per year, nearly all of which is furnished during day time only.

**THE ONLY HIGHEST AWARD, ONLY GOLD MEDAL,
AT ELECTRICAL EXHIBITION, PARIS, 1881.**

MADE IN SIZES FROM 1 TO 25 HP. INDICATED.

FOR PARTICULARS, PRICES, ETC., APPLY TO

SCHLEICHER, SCHUMM & CO.,

Works:

N. E. Cor. 33d & Walnut Sts., Phila., Pa.

Branch Office:

214 Randolph Street, Chicago, Ill.

THE AMERICAN GAS LIGHT JOURNAL

PUBLISHING OFFICE No. 42 PINE STREET

DEVOTED TO THE INTERESTS OF ILLUMINATION, VENTILATION, WATER SUPPLY AND DISTRIBUTION, & GENERAL SCIENCE.

VOLUME XLIII.—No. 9.
Whole No. 633.

NEW YORK, MONDAY, NOVEMBER 2, 1885.

\$3 PER ANNUM
IN ADVANCE.

A. M. CALLENDER & CO., Proprietors. C. E. SANDERSON, Manager.
JOS. R. THOMAS, C. E., Editor.

ENTERED AT THE POST OFFICE AT NEW YORK, N. Y.,
AS SECOND CLASS MATTER.

Published on the 2d and 16th of each month, at No. 42 Pine Street, N. Y.

Terms of Subscription, Including Postage.—For the United States and Canada, \$3 per annum. European countries, \$3.50 (15 shillings—18 francs). All payments to be made in advance. Single copies, 15 cents.

Remittances should be made either by post-office order, registered letter, or bank draft on New York, payable to the order of A. M. Callender & Co.

Collections are invariably made directly from this office, for subscriptions, advertisements, etc. We have agents to solicit the same, but they are not authorized to receipt for money.

Correspondence.—Wishing to make this JOURNAL a gazette of intelligent discussion to those of our readers who may wish to gain or give information on the subjects to which its columns are devoted, correspondence is solicited for publication from all who make the study of those subjects a pleasure or a profession.

The American News Company, Nos. 39 and 41 Chambers street, New York, are agents for this JOURNAL. Newsdealers will send orders to them.

Books.—We will forward by express, at publisher's lowest rates, any book—scientific or otherwise—to any address in the United States or Canada. No books will be sent C. O. D.

CONTENTS.

An Asterisk (*) denotes an illustrated article.

EDITORIALS—

The Meeting in Cincinnati..... 225

Thirteenth Annual Meeting of the American Gas Light Association

—Official Report..... 227

First Day, Morning Session—Applications for Membership—Election of New Members—Welcoming a Distinguished English Gas Engineer—Committee on Invitation—Inaugural Address—Committee on President's Address, with Report Thereon.

Some Notes on the "Novelties" Exhibition Now Being Held at Philadelphia, Under the Auspices of the Franklin Institute of Pennsylvania, by H. C. Adams.—Article No. III..... 230

* The Willbraham Gas Exhauster—Miscellaneous Exhibits.

Coal vs. Coke in the Jarvis Furnace..... 231

Report of the Pittsburgh Commission on Natural Gas..... 231

Special English Correspondence..... 232

The Past and Present State of Gas Lighting in Scotland..... 233

ITEMS OF INTEREST FROM VARIOUS LOCALITIES..... 234

Gasoline Explosion—Reducing Price of Gas at Columbus, Ind.—New Gas Company—"Caning" a Gas Man—Obituary Note—Tar-Fired Boilers—His Accounts Proved Him a Defaulter—Gas Matters at Macon, Ga.—New Gas Company—Why the Grand Rapids (Mich.) Gas Company Placed that "Ad" in the JOURNAL—Even the Newspaper Men Think So—Reasserting Their Opinion—Suffocated by Gas—A Victim in New York City—The Franklin Institute Programme of Lectures for 1885-6—Gas Matters at North Adams, Mass.—Declined, without Thanks—Busy Mr. Anderson—They Have Made an Appearance.

The Market for Gas Securities..... 235

THE MEETING IN CINCINNATI.

After months of preparation—and busy ones they were—the doings at the sessions of the Thirteenth Annual Meeting of the American Gas Light Association are now ready for enrollment on the records, there to stand as evidence of the excellent work accomplished in Cincinnati, Ohio, by the gas men on the 21st, 22d, and 23d days of last October; and, before proceeding further with our synopsis of what was said and done, we would like to introduce the subject with the simple statement that the Cincinnati gathering was, in every sense and particular, unqualifiedly successful. That every member in attendance, from chief executive officer down, had determined to act as though the assemblage had convened for business pure and simple was evident; and, with the participants in such mood, it is therefore anything other than strange that the proceedings which marked the entrance of the Association into its "teens" should have a sound and sterling value.

Those of the Eastern contingent from the New York district who began the trip to Cincinnati, on evening of October 19, with the Grand Central Depot as the starting point, bowled along merrily over the rails that parallel the beautiful Hudson, and when Albany was reached the "real Eastern delegation," consisting of the brethren who "radiated" from that portion of the "Hub" around which clusters the Boston and Albany Railroad depot, were met. With the forces thus conjoined, and with the password "On to Cincinnati" sounded, the party sped on its way to the "Paris of America." The objective point was reached in pretty fair time—the delays on the "track" accounted for "two hours behind schedule time"—and arrival at the Gibson House revealed the presence of many of the Western and Southern members, prominent among whom stood that lively Columbus man, Emerson McMillin, of the Committee of Arrangements. Between "Mac," General Hickenlooper, and the managers of the Gibson House Company, the visitors were comfortably housed and generally cared for. The remainder of the evening was occupied in making forecasts, exchanging confidences, comparing notes, and so on, until the time when suspicious "noddings" were observed. Naturally enough, this was the signal for seeking repose, and the delegates speedily found their respective sleeping quarters.

Wednesday morning opened bright and clear, and the Gibson halls and corridors resounded with hearty greetings. The presence of so many augured well for the success of the convention, and after breakfast the general order "forward to College Hall" seemed, from the general exodus from the Gibson, to apply to at least every other guest quartered in that elegant hotel. President Vanderpool, gavel in hand, took his place on the platform; energetic Secretary Humphreys, with books and documents piled before him, was ready for the fray; and promptly at the hour of ten the Chairman called the convention to order. Now was the time to prognosticate over the success of the sessions. Looking down from the platform it was seen that row after row of chairs were occupied by delegates, representing the gas interests of almost every State in the Union. It was nonsensical, then, to suppose that these men were there (many of them having traveled hundreds of miles—indeed, up into the thousand and odd) for other than business and business only. A pleasant sight it was, and one that, while appreciated by all, was brought home with greatest force to the many "old-timers" present. Could such a thing have been achieved a few years ago, or when gas men seemed afraid of one another—or, to go further, when they absolutely distrusted one another? Time and again we have said in these columns that,

had the American and other Gas Light Associations accomplished not the least technical advance in the methods of gas manufacture and distribution, through the radical change their influence had brought about in establishing a feeling of good-fellowship and identity of business relationship between the members of the fraternity, they had served sufficiently well the purposes of their formation. Every succeeding year but better proves the truth of such assertions. But, to come back to Cincinnati.

Following the call to order and the election of new members—who, by the way, made their applications in great force (25 were elected at this meeting as against 16 at the Washington meeting of '84)—came the delivery of the President's inaugural address. Chairman Vanderpool needs no introduction in these columns to the gas fraternity of this or any other country. But before making any allusion to his Cincinnati message it is only right that he should here receive credit for the effort and sacrifice made by him to be in attendance at the sessions of the Association. His time has been so thoroughly occupied in the erection of new plant and extension of street mains, etc., that a voyage to foreign lands contemplated by him had to be abandoned. We are in position to know how ardently he desired to make the journey this fall, and the only reason that prevented the accomplishment of his object was the desire to fulfill and carry out to the end the duty he owed his fellow-members which he accepted and imposed upon himself when he acquiesced in his election to the Presidency of the Association.

Able, impartial and scholarly, his address touches upon all the salient features involved in the gas business of America at the present time. He pays great attention to the question of increased use of gas for purposes other than lighting, and draws a nice moral from what is now being done in those districts where the use of natural gas has actually usurped the dominion hitherto enjoyed by "King Coal." No other man in this country has given more thought and attention to the subject of the relations existing between municipalities and gas corporations than the President-Engineer of the Newark (N. J.) Gas Light Company; and we would ask that his expressed opinions thereon be studied with more than ordinary care. There can be no mistake regarding Mr. Vanderpool's opinions on that question; indeed he goes so far as to say, "There seems to be but one complete remedy for these evils, and that is placing our affairs under legal control." And we suppose it is fair to assume Mr. Vanderpool to mean that the companies should be the ones to ask for this legislation. But as the address is given in its entirety on pp. 227-230 of this number, we consign it to the intelligent criticism of our readers, merely closing our remarks on the message by characterizing it as a model of its class, and pregnant with food for thought.

It was pretty well understood that the Association would have the pleasure of welcoming an honored guest in the person of Mr. R. P. Spice, who, besides being an honorably distinguished and active member of the English fraternity, is an ex-President of the British Gas Institute, and familiarly known in the "tight little island" as the "Hermit of Westminster"—the latter title being traceable to those modest ideas of his which led him to "conceal" the authorship of several literary gems that have emanated from his pen, the same being the result of recounting the experiences gained on several voyages to foreign lands. This pleasant anticipation was verified, and not only did the "Englishman" pay the expected visit, but also came prepared to lend additional interest to the proceedings by presenting a paper on a topic with whose intricacies he is intimately versed. The Association honored its guest and self by electing him to an honorary membership—a mark of esteem and confidence that was heartily bestowed, and feelingly accepted. Long may he enjoy the honor so worthily won.

Secretary and Treasurer Humphrey's annual report came next in order, and when the items therein were read, and the totals footed up, it was pleasant to understand that the members of the Association could enjoy the ease sure to result from a knowledge that a comfortable balance to their credit was safely resting in their banker's care. There was, however, one set-back in connection with the Secretary's tables of membership, since these disclosed the removal from the ranks, by death, of Messrs. Ignatz Herzog, Thos. Butterworth, Geo. C. Cornell, Francis Thompson, and Philip Peebles.

Omitting mention of reports of committees, the order of business was now brought down to election of officers for ensuing year, and the election resulted in the choice (according to custom) of First Vice-President, Mr. A. C. Wood, of Syracuse, N. Y., as President; of Messrs. M. S. Greenough, Boston, Mass.; Thos. Turner, Charlestown, S. C.; and A. B. Slater, Providence, R. I., as Vice-Presidents, with priority of position in the order named; Mr. C. J. Russell Humphreys, Lawrence, Mass., was chosen, as matter of course, to succeed himself to the dual position of Secretary and Treasurer. Mr. Humphreys has kept up his record as a painstaking and thorough officer, and much of the success belonging to the operations of the Association is attributable to his well-directed efforts.

From the official circulars that have from time to time appeared in the JOURNAL ample assurance was conveyed of the pleasing fact that there would be no lack of interesting matter for discussion and dissection. Indeed, despite the

close application given to their disposition (business sessions were held as follows: Wed., from 10 A.M. to 12:30 P.M., and from 2 P.M. to 6:30 P.M.; Thursday, from 10 A.M. to 12:30 P.M., and from 2 P.M. to 7 P.M.; Friday, from 9 A.M. to 10:30 P.M.), it was found impossible to do justice to them all. In fact, papers No. 10 and 11 respectively entitled, "Relations of Corporations to Municipalities," by Mr. Jas. Crockett, San Francisco, Cal., and "The Thermophote, or Self-Registering Photometer," by Dr. T. O'Connor Sloane, of New York city, owing to time pressure, were declared "taken as read." The other formal papers presented, and given in the order of reading, were the following: "Difficulties Encountered in the Construction of a Gasholder Tank," by Emerson McMillin; "Natural Gas," by W. H. Denniston; "The Result of a Month's Working with Limed Coal," by Jas. Somerville; "The Use of Limed Coal," by R. P. Spice; "Stoking Machines," by M. S. Greenough; "Can Large Gas Burners Successfully Compete with the Arc Light," by E. Stein; "Improved Furnaces," by A. C. Wood; "Automatic Street Main Governors," by Wm. Enfield; "Naphthaline," by J. H. Walker, sr.; and "Gas vs. Electricity," by W. W. Goodwin.

The papers were, without exception, of a nature well qualified to lead on to interesting discussion, and many a valuable hint was given out during the progress of the dialogue. It is truly regretted papers 10 and 11 could not be reached; but there is no gainsaying the fact that time could not be made for their verbatim reading. They will, of course, be published in due course in the JOURNAL's columns. The question-box discussion, or rather the discussion of the questions that were drawn from the box, was a feature of the proceedings; and, judging from the frequency with which the members consulted their note-books, the delegates had paid due heed to the admonition to "Do their Duty." Taken purely from a technical standpoint the '85 meeting may be regarded as the most important session ever held by the American Gas Light Association. The executive work was admirable; the attention bestowed by the delegates upon the work in hand was perfect, and not a single ripple occurred to disturb the harmony of the gathering. In passing, however, we might say that harmony of opinion, speaking with reference to the results given in the papers read by Messrs. Somerville and Spice, was slightly awry.

When the final adjournment of business sessions (10:30 A.M. of Friday) took place, the members put themselves under the guidance of Gen. Hickenlooper, who, on behalf of his confreres of the Cincinnati Gas Company, had arranged for the entertainment of the Association and its guests. The ladies of the party, and they were legion—the Western men having the "call" as usual in their luck in that respect—were provided with carriages and then started off on a tour of inspection. Many points of interest were visited, and the fair inspectors wound up their sight-seeing at the Zoological Gardens, where an elegant lunch awaited their combined attack. The sterner representatives of the guild boarded the 11:15 train, and were conveyed to the new East End station of the Cincinnati Gas Company. The railway depot is but a short distance from the plant, and as the visitors alighted from the cars they were met by an excellent band of music. By direction of Mr. Mattox, the genial master of ceremonies, the party formed in files of two, with "drums a-beating, colors flying," and descended upon the doomed station. As a description of the new works (voted by a majority of the 180 who examined it thoroughly on this occasion—and we were included in the majority—as "the best equipped and arranged gas plant in America") was contained in Gen. Hickenlooper's address to the Ohio Gas Association (see pp. 149-50, Vol. XLII.), it is needless here to make further mention of the same other than to add that the place is a pleasure to look upon. At 1:30 P.M.—and it might be here noted that Friday, Oct. 23, was the day appointed by the management of the Company for the invitation of the stockholders and their friends to the formal opening and inspection of their property—the delegates and guests sat down before tables arranged in the duplicate purifying house (all the new plant is constructed in duplicate), and partook of an elegant banquet provided for their comfort by Gen. Hickenlooper. Capt. W. H. White, of course, was selected as toastmaster. We have had occasion ere this to comment on Cap.'s ability in that position; but candor compels us to say he fairly outshone himself in Gen. Hickenlooper's purifying house. He convinced those present then that if, as happened during a part of the discussion devoted in convention to electric lighting topics, he was doubtful as to the "horse power" developed under certain methods in the electric lighting plant at St. Paul, Minn., he certainly could be calculated upon anywhere and at any time when in convivial mood to develop an unlimited, pleasing and not "hoarse power" of speech.

The Committee of Arrangements, acting in conjunction with the Cincinnati Gas Light Company, through Gen. Hickenlooper, left nothing undone to secure the comfort of those in attendance at the meeting; and no words of ours can convey an adequate expression of appreciation of the kindness, attention and hospitality bestowed upon the Association by its entertainers. Forward, then, gentlemen; and let the success of '85 be the guidepost to the Philadelphia convention of '86.

[OFFICIAL REPORT.]

Thirteenth Annual Meeting of the American Gas Light Association.

HELD AT COLLEGE HALL, CINCINNATI, OHIO, OCT. 21, 22, 23.

FIRST DAY—MORNING SESSION.—WEDNESDAY, OCT. 21.

The delegates to Thirteenth Annual Meeting of the American Gas Light Association convened in the commodious Assembly room of College Hall, on date of October 21st, at the hour named for opening proceedings of first day's regular session. At 10 A.M., the President, Mr. Engene Vanderpool, of Newark, N. J., called the members to order. On motion of Mr. A. B. Slater, a reading of minutes of last annual session was dispensed with, the same having been published in the columns of this JOURNAL.

APPLICATIONS FOR MEMBERSHIP.

Applications were submitted by the following named gentlemen for admission to the duties and privileges of membership in the Association.

Bredel, Fred'k, New York.	Cowdery, Ed. G., Milwaukee, Wis.
Daly, D. R., Jersey City, N. J.	Dell, Jno., St. Louis, Mo.
Douglas, S. H., Anu Arbor, Mich.	Ensley, Enoch, Memphis, Tenn.
Enfield, Wm., Columbus, Ohio.	Faben, C. R., jr., Toledo, Ohio.
Foster, A. P., Des Moines, Iowa.	Green, Jas., St. Louis, Mo.
Gartley, W. H., Chicago, Ills.	Gordon, J. J., New York.
Gibson, W. H., Lima, Ohio.	Hauk, C. H., Chicago, Ills.
Kreischer, G. F., N. Y. city.	Lansden, T. G., St. Louis, Mo.
Light, Jos., Dayton, Ohio.	Payne, M. J., Kansas City, Mo.
Park, Wm. K., Phila., Pa.	Ridgely, Wm., Springfield, Ills.
Sumner, W., Des Moines, Ia.	Stafford, John W., Meridian, Miss.
Stannard, A. B., Phila., Pa.	Thompson, J. D., St. Louis, Mo.
Young, Peter, Montgomery, Ala.	

The applications were referred to a committee of three for consideration and report, the President naming Messrs. G. A. Hyde, Cleveland, Ohio; G. B. Neal, Charlestown, Mass.; and A. B. Slater, Providence, R. I., as such committee.

ELECTION OF NEW MEMBERS.

The Committee subsequently reported in favor of admitting all the applicants to membership in the Association. On motion, Secretary Humphreys cast the ballot of the Association in favor of the gentlemen proposed. The tellers, Messrs. W. H. White and A. C. Wood, reported back the result of the election, and the President thereupon formally introduced the new members to the Convention.

WELCOMING A DISTINGUISHED ENGLISH GAS ENGINEER.

President Vanderpool, in a few well-chosen words of welcome, introduced to the Association a distinguished English visitor in the person of Mr. R. P. Spice, ex-president of the Gas Institute, and an active member of the fraternity possessing an honored international reputation. The Association further showed their esteem and regard for Mr. Spice by electing him to honorary membership.

COMMITTEE ON INVITATION.

On motion of Capt. W. H. White the President appointed Gen. A. Hicklenlooper, Cincinnati, Ohio; Mr. Thos. Turner, Charleston, S. C., and Mr. C. H. Nettleton, Birmingham, Conn., as a special committee charged with the duty of inviting officers and directors of gas companies (as well as other gentlemen interested in the business of gas manufacture, but who were not members of the Association) to attend the sessions of the organization. Other routine business having been disposed of President Vanderpool then delivered the following

INAUGURAL ADDRESS.

Gentlemen of the American Gas Light Association:—The Thirteenth Annual Meeting of our organization opens to-day in this flourishing city of the West under exceedingly pleasing and favorable auspices. Many of you remember when the American Gas Light Association was formed in the city of New York. The obstacles encountered and overcome, the struggles and successes of our early years—these have long since become part and parcel of the personal experience of most of us. But the Association, concerning the survival of which we at that time had doubts and fears, is to-day the representative gas light association of the North American Continent. Our past record encourages us to renewed efforts in the future.

We now have about three hundred members, representing this Association as far north and east as Canada and Newfoundland, and from California on the west to Cuba on the south. We are engaged in an industry employing a capital of over two hundred and fifty million dollars (\$250,000,000), invested in plant and used in manufacturing and distributing more than thirty billion (30,000,000,000) cubic feet of gas per annum. It has dependent upon it mines, railways, iron works, and other industrial establishments that are represented by many millions more.

The members of our Association have not forgotten the hospitable manner in which they were entertained in this beautiful city in October, 1877—eight years ago. The invitation of the President of the Cincinnati Gas Light and Coke Company, one of the honored Ex-Presidents of this organization, was eagerly accepted not only because we remembered with pleasure our former cordial reception, but also in recognition of the fact that much has been done by the gas company here, under his wise management, in originating and developing methods for manufacturing and distributing the best gas in the most economical manner.

The Cincinnati Gas Light and Coke Company, under its present management, was the pioneer in this country in successfully introducing mechanical appliances whereby the labor account in the retort and coke houses was largely reduced.

We were aware that we should here find, in operation, newly built and complete gas works with every new and improved arrangement and appliance, originated or adopted, which it was thought would improve the quality and cheapen the cost of making gas; and that we would derive much benefit from a critical inspection of one of the most perfect gas plants in existence.

Considering the depressed condition of the general business of the country, and the severe competition of oil lights, the development and progress of the gas lighting industry during the past year has been remarkable. The outlook for the future is most promising if the danger of overburdening the industry by too much capital, forced upon us by unscrupulous speculators, can be averted by wise legislation that will protect both the interest of the consumer and the producer.

The use of gas in nearly all of our towns and cities has largely increased, and the wise commercial policy of securing a fair return upon the capital invested, from a large in preference to a limited gas consumption, is now almost universally recognized and adopted. This would be done to a far greater extent were it not that we have learned from daily experience that our franchises are precarious; and prudence demands the continuance of a management that takes into account the uncertainty of our future profits occasioned by so-called competition.

It has generally been found that an increased consumption speedily follows a decrease in prices. This increase, together with the economy that can and must now more than ever before be exercised in all industrial undertakings, will keep a fair balance on the right side of the account, and should induce us prudently to continue to lessen our prices and enlarge the output of our product.

As an indication of the extent to which prices have been reduced from time to time in this country, and of the strength and vitality of the industry, and the improved methods of manufacture, it is only necessary to state that there are many companies now supplying gas at a fair profit, at more than twenty per cent below the cost, and over fifty per cent less than the selling price, of fifteen years ago. A remarkable and creditable showing indeed, particularly so considering the difficulties under which we have labored in this country.

It is hardly probable that such enormous reductions as these can be made in the near future; but enough has been done in the past to demonstrate that, if our property is protected by wise legislation, we shall sell gas of a high grade, within a comparatively short space of time, at as low prices as it is furnished in any country in the world.

It is plain that the results above stated could not have been obtained except under the best management and the practice of all known economies in manufacture and distribution.

Any well-arranged gas works, fitted with modern plant, is radically different from those of a few years ago. Every possible appliance is now adopted whereby labor can be economized. By means of improved hoists and cars the cost of labor in handling coal has been reduced one-half to two-thirds; and, where the coal is taken directly into the retort house, a still greater saving is made. If the coal is stored and then moved into the retort house it is cheaply hoisted to a convenient level ready for charging the retorts by means of improved hydraulic or steam lifts.

The retort house is now built with the charging floor above the ground line, and larger retorts are set in an improved manner, and, except in small works, in benches containing a greater number of retorts.

The furnaces also are quite different, being built either with large grate area, and a deep bed for fuel, making a simple generator furnace, or else the generator furnace is supplied with a system of recuperation more or less complete. Besides, we now have most ingenious mechanical arrangements for charging the retorts with coal, and drawing and handling the coke.

As compared with a few years ago, we show a gain of from two to three times the yield of gas per retort; from two to three times the product of gas made per man; an economy of one-half to two-thirds in fuel for the carbonization of the coal; an increased yield from the coal carbonized of 10 to 20 per cent; a decreased wear and tear account, and an improved candle power. We use new and very efficient apparatus for removing the tar; ingeniously designed scrubbers for extracting the ammonia; improved methods of mix-

ing and using lime; efficient and more economical ways of purification by oxide of iron; and we are getting a better return for our residuals than formerly, but not as much as we should and will receive.

When we leave the works and come to inspect the system of distribution we find that greater attention than formerly is given to laying the main pipes. Their size has been increased, they are systematically examined, and all the service pipes are inspected and repaired. The latter are now laid with a coating of some substance that prevents oxidation; the consumers' meters are periodically and frequently tested; improved station governors have been introduced; and the gas is distributed more uniformly and under lower pressure. The result is that our consumers get more efficient service, cheaper and better lights, and our unaccounted-for-gas amounts to five per cent., or less, instead of fifteen to twenty, of our product.

One of the most interesting papers read at the last meeting of our Association referred to the vast development that had already taken place in the collection and distribution of natural gas that issues from wells driven to its source. These wells have hitherto been put down mostly in locations in the western part of Pennsylvania, New York, and western Virginia.

The distribution of the natural gas, so far as regards its commercial aspect, is more directly interesting to the members of our Association in the neighborhood of these natural reservoirs. But the subject is of general importance to all of us, in view of the new engineering problems that have arisen, and the means adopted to store, control and distribute this gas that flows from some of the wells with a pressure slightly above that of the atmosphere, and in other cases exceeds 500 pounds to the square inch. Again, all of us are interested in the inventions for burning this gas, and the experience had with it, when used as a fuel in place of coal on the largest scale in some of the cities of Pennsylvania, particularly in Pittsburgh, where from 150 to 200 million cubic feet are daily used under boilers for generating steam and in the manufacture of iron, steel, glass, etc.

Those of us who for some years have been expending time and money in introducing apparatus, and lowering prices, for the purpose of stimulating the use of gas for other purposes than lighting, can take great encouragement from the facts determined by experience on the largest scale. It has been conclusively shown that if the price of the gas is low enough it will supplant coal, not only for the minor uses of cooking, driving gas engines, and ordinary house heating, but also in the generation of steam, and in the heaviest as well as lightest kinds of manufacturing.

While it is doubtful if such a gas as we now produce, with the expenses attendant upon a costly system of distribution, can be profitably sold so that it will successfully compete with solid fuel on the largest scale, still, with our present system, we can go much further than we have yet gone, and we must not be misled by mere theoretical calculations that are based upon data that show only the comparative potential energy of the two fuels, and that eliminates from the calculations considerations having a money value, but which are difficult elements to estimate in solving the financial problem. The great advantages that obtain in the use of gas as fuel are cleanliness and reliability; moreover it is controllable, and produces much comfort.

We were all aware that gaseous fuel was capable of producing the most intense heat, but, on account of the cost of distribution, we did not know until recently that gas could be sold at a profit so as to compete with coal at a dollar a ton, and displace the latter in the manufacture of iron, glass and steel.

It is found that natural gas varies considerably as it comes from the different wells, and even from the same well its composition is not entirely uniform. This affects considerably its comparative value as a fuel.

The specific gravity of these natural gases varies from 0.500 to 0.800; and it is probable that, on the average, each cubic foot of natural gas has a calorific power of 1,000 heat units, or about one-third more than that of ordinary coal gas.

It is estimated that, using the best methods of combustion, 7.92 cubic feet of natural gas are equal to one pound of coal; or that 1,000 cubic feet of the same gas are equal to 126.2 pounds of coal. If coal is selling at one dollar per ton, this would place the selling price of gas at 6.3 cents per 1,000 cubic feet. But it sells readily, we understand, at 10 and 15 cents per 1,000 cubic feet, on account of its convenience and the saving in labor obtained by its use; so that, where coal sells at \$3.50 per ton, 50 cents per thousand should be received for gas. But it must be remembered that the calorific power of 1,000 heat units per cubic foot is very high for a fuel gas; and that the comparative fuel value of gases, having a different composition, must depend largely upon their calorific power.

The increased consumption of gas, during the last seven years, for other purposes than light in our cities and towns where energetic efforts have been made to introduce apparatus for heating and cooking, and to instruct consumers in its adoption and use, has been remarkable, and admits of far greater development in the future.

Where a moderate amount of power, or intermittent power, is required there is no motor so convenient, safe, and economical as the gas engine.

This engine, as compared with the steam engine, is already highly developed in utilizing the energy of the fuel consumed; but there is still a great loss of heat in the water-jacketed cylinder, the energy lost thereby being more than twice that developed in power. From what has been already accomplished, it would seem that this wasteful expenditure of energy may be further greatly decreased.

The experience of the past warrants the belief that some of the minds at work on this interesting problem will succeed in inventing a method of protecting the working parts of the engine, exposed to the high temperature developed within the cylinder, so as to provide a far greater saving of energy than is now obtained by the water jacket. This accomplished, the immediate and immense enlargement of the field that will be occupied by the gas engine can be readily foreseen.

Progress is continually made by our manufacturers and inventors in stoves for heating and cooking, and low-priced apparatus of a most efficient kind is now within our reach. Gas kilns for glass manufacturers and gas ovens for bakers and confectioners are in successful and economical use.

In this connection may be considered the vast importance, as regards the economical working of a gas plant, of increasing the day consumption of gas. The great disproportion that exists between consumption during the winter and summer in the case of some establishments is as much as five to one. To supply this winter consumption we must have a large amount of capital locked up in producing, storage, and distributing plant. It is entirely clear, if this plant could be constantly used to its full capacity, day and night, winter and summer, with a safe margin for reserve, that the charges for interest on the invested capital, and the general and distribution expenses, would be reduced to a very low figure. How far we should go in the direction of differential charges for gas used in the day, and for other purposes than lighting, it is difficult to state. There are those who entirely oppose the system; but experience has proved that their objections are groundless and run counter to the rule that cheap gas stimulates consumption, and that low prices for gas used in the day and for other purposes than illumination will eventually occasion a large reduction in the charges for gas used in lighting. We look with the greatest interest, and hope for a successful issue, to the experiment now being made at Brussels, where it has been resolved to charge for gas during the day but one-half the price of that consumed at night. The quantity consumed in the two periods is to be ascertained by a meter with a double index, said to perform its functions satisfactorily, and with separate registers for the night and day gas, affected by the varying pressure.

While we have reason to congratulate ourselves on the progress made in our industry during the past, we know that the future field for exploration and development has possibilities that are sure to reward the well equipped and industrious searcher.

When the present method of carbonizing coal in horizontal retorts is considered, it becomes evident that the vertical retort, with its probabilities as an economizer of labor, coal, and fuel, is well worthy of continued study and experiment.

While it may not be certain, considering the intense heat now used in carbonizing, that a decided gain in the volume of gas from a certain weight of coal will be attained, still such a result is possible; and the study of the composition of a gas distilled from an ordinary caking coal favors the thought that some treatment of the coal, before or during carbonization, or of the resultant gas, might cause a decrease in the large volume of methane produced, and at the same time increase the volume of hydrogen, and thus add some heavy gaseous hydrocarbon that would largely develop the illuminating power of the mixture.

While we hope and expect to receive better prices for our liquid residuals than are now obtained, we must ever remember that of late years we have competitors in this field who may prevent the realization of these expectations.

When we consider the great improvements that have been made in the gas burner within a few years, and the still greater developments that are possible, it seems that our present business of furnishing light can never be taken from us if we do our duty, either as investigators or by giving liberal assistance to those who are capable and well equipped for research in this direction.

Hitherto but four or five, whose names and achievements are familiar to all of us, have investigated and accomplished important results, and given us the beautiful and economical burners of the present day. We hope that this body of men will be increased in number and their efforts crowned with every success.

A gas company fitted with a modern plant, and managed with skill, delivers to the burners gas that possesses more than twenty-two per cent. of the potential energy of the coal from which it is distilled; and it returns, in its changed condition, nearly ninety per cent. of the weight of the coal it carbonizes, salable as gas, coke, tar, and ammoniacal liquor. But when this energy is converted into light at the burner a large amount of it is dissipated

in producing rays of heat instead of light. To make this more clear, it may be stated that the heat per hour per candle of light emitted by a regenerative burner of the first class is about equal to 85 heat units, whereas, in the case of an arc electric light of the first class, it is not over 3 heat units. Thus the production of heat per unit of light is 28 times greater with gas than with electricity. But we remember with satisfaction that, while we deliver twenty-two per cent. of the potential energy of the coal to the burner, and utilize commercially nearly ninety per cent. of its weight, an electric light company, with the best boilers, engines, dynamos, and conductors, cannot deliver over five or six per cent. of the energy of the same coal to its lamps, and that it has no salable residuals left to reduce the cost of its fuel.

Now, when we consider the above in connection with the statement that the theoretical flame temperature of our gases, under constant pressure, is equal to at least 5,000° F. above their initial temperature, and due allowance has been made for the fact that this temperature is higher than can be practically reached on account of the dissociation of the gases, it becomes evident that there is a great margin left us for converting more of the invisible heat into light rays, and that we have, as yet, advanced but a step toward what is in store for us.

Whether the burner of the future will be an evolution of the present recuperative system; whether it will be dependent for its economy upon raising to incandescence a solid or gaseous substance in the flame; or whether some practical arrangement can be devised so that the gas can be burned under increased atmospheric pressure, none of us can tell, although we know an advance is probable in all of these directions.

The electric light companies continue their efforts to obtain part of the lighting that has hitherto been done by us. Whatever progress they have made is due largely to the fact that by our present laws, and owing to the partiality of our people for the development of new things, no restrictions have hitherto been placed upon the electric lighting companies as to the manner of erecting their distributing systems. They also have the great privilege of selecting their consumers, and they exercise it to the fullest extent. The ordinary consumers whose lights are in use but a limited number of hours per annum, and who collectively burn by far the larger amount of gas we furnish, are neglected and cannot be supplied with electric lights, while the comparatively limited number of consumers whose burners are lighted during many hours per annum, are eagerly sought after.

Particularly is this the case where the incandescence lamps are introduced. The cost of this system of lighting is largely dependent upon the time during which the lamps are lighted. A careful estimate, by an acknowledged expert in all matters pertaining to electric lighting, of the expenses of operating such a system, including all the items of cost, and interest on the investment, shows that there would be but a trifling difference in the cost of illumination whether the lamps were lighted 400 or 1,500 hours each per annum. While it would not be possible to compete with gas on the basis of a 400-hour consumption per burner per annum, yet, with a basis of 1,500 hours and upwards, he claims that it could be done, provided the price of gas was maintained at a constant figure, whatever the duration of consumption.

Wherever introduced into our large cities this selection of consumers whose lights are burned the greatest number of hours per annum has been carried out. Although there are those who do not believe in differential prices for gas, still, to overcome this unequal competition, and to retain a class of consumption as valuable to us as any we have, it may be necessary to grade our prices. There are no insuperable difficulties in making our charges dependent upon the quantity consumed per burner per month. It is quite clear that a large reduction in the charge for gas used in the daytime is advisable, because the gas then used costs comparatively little for the interest on capital invested in gasholders, street mains, services, and meters. The running expenses, excepting those for coal, labor, wear and tear, remain about constant.

Similar conditions exist in the supply of gas to consumers all of whose burners are lighted many hours per annum. There are good reasons; and these are the reasons why the electric light companies select this class of consumers; irrespective of competition on such unequal grounds, for discriminating favorably in our charge to a consumer who is served by a three-light meter, and who uses the same quantity of gas per annum as another who is fitted with one ten times larger.

The subject of photometry has received much attention of late, and there appears to be a desire abroad to do away with the old standard; but the difficulty is to find a substitute that will be as acceptable, when simplicity and trustiness are considered, as the standard candle. Any standard adopted must be one that can be readily comprehended by the public we serve.

There are advocates of the French standard, the pentane standard of Mr. Vernon Harcourt, the Methven standard, and even that of Mr. Viollo, with all of which you are familiar. All of these standards depend for their accuracy, irrespective of reliability, upon the equality of the vision of the observer or observers, and it is well known that this is not constant. The same

eyes may make an observation in the afternoon of the same gas with a perfect standard that will differ from that made in the morning to a greater extent than would be caused by a standard of comparison that was moderately imperfect. If an instrument could be devised that would eliminate the personal element, and indicate mechanically the candle power, it would be a very great advance on what has been hitherto accomplished. We are to have a paper on this subject by one of our members eminently qualified to instruct us, who has invented a self-registering photometer that is based in its action upon the principle that the effects produced by radiant heat and light are identical, and we look forward to its consideration with great interest.

Our industry has passed through many trials. It has been threatened with extermination by rival systems of lighting; it has suffered from the infliction of burdensome and unjust taxation; it has been subjected to most unjust and unreasonable prejudice at the hands of the public. We have been covered with unmerited contumely and abuse. In spite of all your interest has been, and is, successful, and stands to-day, in the financial centers of the world, unrivaled as affording a permanent and remunerative investment. Notwithstanding these apparent signs of prosperity, there is an element at work in our own midst that threatens eventually to destroy, as it has already crippled, our capacity to profitably furnish light without serious danger from other systems of illumination.

Reference is made to the existing and active combinations of unprincipled speculators who, by every known means, are imposing on the public, and endeavoring, for entirely selfish ends, to build and sell, but not to permanently operate, gas works in every city in our country where entrance can be had.

This evil was never so rampant as now; it is our great danger, and threatens, not only to ruinously overburden our industry with unnecessary and wasted capital, but also to make successful competition with other systems of illumination difficult, if not impossible, with profit.

It is cause for sincere regret that so little has yet been done towards the regulation by the State of the profits, duties and privileges of gas companies, and towards the protection of their property, invested in good faith and in such a manner as to be useless for any other purpose.

We regret that more prompt legislative action was not taken in the State of Massachusetts, whose principal city had been supplied for many years by one company that, without legal restriction or control, and unthreatened by raids upon its property, had adopted and carried out the policy of supplying the best gas at as low prices as were consistent with what is recognized, among conservative financiers the world over, as a moderate return upon the capital actually invested. Notwithstanding this condition of affairs, and the absolute demonstration of its great superiority to the municipal authorities, the latter, without regard to the interests of the consumers, and in the absence of laws such as are provided in other civilized countries, granted the right to open their streets to so-called competing companies, and thereby forever fastened a grievous burden upon every gas consumer in their city.

This action of the municipal authorities has shown most clearly the necessity of placing the determination of the serious questions regarding the supply of gas in the hands of intelligent and unbiased men, appointed by the State, who would have the time to thoroughly consider them, and who would be honest and capable to act as arbitrators between the public and corporation.

Our relations to the public are more peculiar, close, and intimate than those of any other corporations.

The principle is now universally recognized and acted upon among ourselves that our consumers are entitled to receive the best service we can render, and that our charge for this should be only sufficient to cover its cost and secure a fair dividend for our stockholders upon the capital actually and prudently invested. But however desirous we may be to carry out these principles, the fact remains that man is a suspicious animal, and prone to think that the selfishness of his fellow-man will lead him, when uncontrolled, to take undue advantage of his opportunities.

It is not creditable to this great country that we alone among civilized nations permit a system that inures solely to the pecuniary advantage of speculators, who place the permanent burden of dear gas upon the public they have so easily cajoled.

No argument is required to prove that competition in the manufacture and supply of gas is impossible. Experience teaches, without an exception, that "where combination is possible competition is impossible, and in every case has resulted in consolidation, division of territory and an agreement not to compete, the pooling of profits, or in the extermination of one of the companies, followed by an increase in the price of gas to consumers to compensate for losses and to pay dividends upon unnecessary and unproductive capital."

There seems to be but one complete remedy for these evils, and that is placing our affairs under legal control, so that the public will know that it has a representative compelling the company to furnish the best service at

reasonable rates, and the company will know that, as a consideration for these services, it will be entitled to receive a fair return on its capital and enjoy a permanent and secure franchise not subject to attack from speculators or adventurers. It is probable that this question will come before us during our present session, and your earnest and undivided attention will no doubt be given it. We have had the matter under advisement for several years, and it is to be hoped that at last something definite will be accomplished.

We miss from our ranks to-day our former friends Thomas Butterworth (your Second Vice-President), George Cornell, and Francis Thompson, who have been active members of the Association. They were well known and long identified with the gas industry, and their loss is deeply felt by us. We shall commit to loving friends who knew them intimately the duty of enrolling in the proceedings of the Association a fitting memorial of their worth.

Gentlemen, I fully appreciate the honor conferred in selecting me to preside over your deliberations. I beg you to accept my sincere thanks and the assurance of my best endeavors to meet the responsibilities of the position. I ask for your kind indulgence and cordial co-operation, and trust that this meeting may be entirely successful and prove a benefit to us and to the public as well.

COMMITTEE ON PRESIDENT'S ADDRESS, WITH REPORT THEREON.

President Vanderpool's delivery was frequently interrupted by applause; and when the reading of his annual message was finished, on motion the address was referred to a committee of three (Messrs. M. S. Greenough, W. H. Denniston, and D. D. Flemming) for consideration and report. The committee reported as the result of its deliberation that 700 copies of address be printed. Agreed to.

[To be continued.]

Some Notes on the "Novelties" Exhibition Now Being Held at Philadelphia, Under the Auspices of the Franklin Institute of Pennsylvania. (ARTICLE No. III.)

By H. C. ADAMS.

THE WILBRAHAM GAS EXHAUSTER.

The utility of the exhauster is now so universally recognized that it has become a very important piece of apparatus in a gas plant. The essentials of its operations are that it should run steadily and economically; and of its structure, that it should be of such simplicity and durability as to require attention only at the longest possible intervals. These conditions seem to be most excellently fulfilled by the machine we are about to describe.

The exhibit of Messrs. Wilbraham Bros., of Philadelphia, consists of a pump, a blower, and an exhauster, all of the "Wilbraham" type, and, with the exception of a few minor changes of detail, all constructed upon the same principle. When we consider the similarity of action of these three classes of machines it is obvious that that may be readily accomplished. The exhauster consists of a cylinder of cast iron, upon the sides of which are suitable flanges for the attachment of the inlet and outlet pipes. Through the axis of the cylinder the rotating shaft is run, and upon this is a central

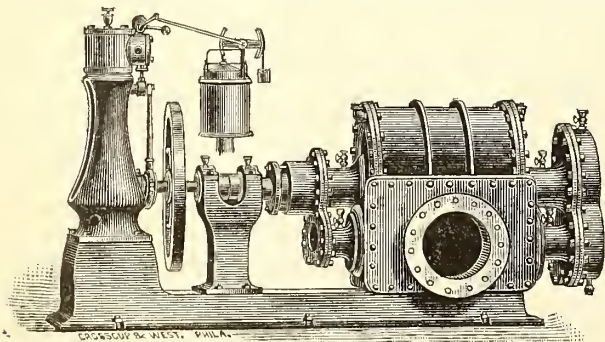

The Wilbraham Gas Exhauster.

drum, concentric with the case, from the periphery of which there radiate, at diametrically opposite points, two vanes or wings, whose function it is to drive the gas. The gas is carried across through the upper side of the cylinder, and it is prevented from flowing back by two crescent-shaped sections of cylinders fixed in the bottom of the case (one on each side of it), and with their axes eccentric to the case. These are rotated by the main shaft, and are arranged by very careful adjustment to "pass" the rotating vanes back through the bottom of the case, and, at the same time, to act as abutments or checks to any return of the gas that has been driven over through the upper section.

To provide that there shall always be enough work to secure a regular motion from the driving engine, a bye-pass is arranged over the cylinder, from one side to the other, controlled by a valve that permits of its being

thrown in or out of action at pleasure. Thus, when there is not sufficient work to run the engine properly, a supplementary supply may be secured by opening the valve and re-pumping a portion of the gas constantly through the bye-pass.

In the exhauster proper it is worthy to note there is only one stuffing-box—that where the main driving shaft enters. Also, just below the entrance and delivery ports are two small cisterns sunk into the bed-plate; and the function of these is to collect the tar that is drained from the machine, and which may be conveniently tapped and drawn whenever necessary.

The engine designed to be placed on the same bed-plate and to drive the exhauster is a small vertical one, adapted especially to that work, and arranged to give a steady motion at extremely low speed. The governor is of the ordinary kind, so adjusted as to be exceedingly sensitive, and to respond quickly to any variations in pressure. The action of the machine is admirable, and the flow of gas is maintained with an absolute absence of pulsation. This may be readily gauged by watching the action of their pump at the Exhibition, which is delivering a stream of water $5\frac{1}{2}$ inches in diameter. So steady is this stream that one might readily imagine it an elongation of the fixed pipe from which it flows. Messrs. Wilbraham Bros. furnish their exhausters on a separate bed-plate and arranged to be driven by belting, or on the same plate with the engine and driven by direct shafting. The latter shape, or with the exhauster, governor, and engine combined—one might almost say into one piece—renders the machine truly self-contained. In fine, the compactness, durability, and ease of action of this exhauster should recommend it most favorably to the consideration of all those who seek after the essentials of economy and efficiency in their apparatus.

Experience justifies the praise given to these machines. Although they have been but four years, practically, upon the market, they have worked their way rapidly into favor. About one year ago an exhauster of the Wilbraham make, of a capacity for displacing 180,000 cubic feet per hour, was placed in the new Twenty-fifth Ward Gas Works of the city of Philadelphia. So satisfactory was the work of that machine that a few months ago another Wilbraham exhauster was ordered to be placed in the Germantown works, where it has since been running in a manner that has elicited warm commendation. As a prophet is not without honor save in his own country, the "home consumption" of these machines is a strong testimonial in their favor.

MISCELLANEOUS EXHIBITS.

The Foster compressed gas system, for lighting railway cars, steamers, buoys, beacons, etc., is exhibited by its inventor, Mr. J. M. Foster, of Philadelphia. Although that is scarcely a novelty in the strict sense of the word, yet the small models of a buoy and beacon charged with the compressed gas, placed in a tank of water, and burning in the orthodox manner, attract constantly a curious crowd. A rack of burners is also lighted up, to show the effect of the oil gas used in the everyday fashion. The gas is a pure, direct oil gas; it burns with a clear white light, and is estimated at 70 candles. It is made in a special kind of works, having a series of what are called "protected" retorts, which are in two sets of threes, in one of which the oil is vaporized and in the other of which it is finally "fixed" as a gas. Another important feature of the system is the compressor, in which the gas undergoes a gradual reduction in volume until it reaches a compression of 750 pounds to the square inch, or about 50 atmospheres. But the most interesting and delicate piece of mechanism is the governor, at whose inlet the gas is delivered from the storage cylinder at a pressure of, say, 700 pounds, and from whose outlet it issues to the burners at a pressure of a fraction of an inch. The valve is worked by a lever actuated by a diaphragm; and so sensitive and rapid is its action that the pressure upon the inlet may be varied instantaneously from 50 to 500 pounds, or through the whole range of pressure, without making any visible effect upon the water gauge of the burner pipe.

The gas machines are well represented. The Pennsylvania Globe Gas Light Company, of Philadelphia, familiarly known as contractors for street lighting with naphtha lamps, exhibit their "Elkins" and "Royal" gas machines; Rand, Harmer & Co., of Philadelphia, exhibit the "Victor" gas machine; and James P. Wood & Co., of Philadelphia, exhibit the "Globe Gas Generator." The three first-named machines—the Elkins, Royal, and Victor—employ "blowers" actuated by small overshot wheels or weights, working like a motive power meter, to drive air through carburetting boxes containing gasoline. In the "Globe Generator" no blower is used. From a supply tank containing the gasoline a pipe is sunk to a depth sufficient to give the required pressure. Through that pipe the gasoline flows, and on reaching the bottom it turns and ascends through a pipe jacketed by another containing steam or hot water. That volatilizes the gasoline, which rises under the pressure of the opposing column. It is then delivered to a small gasometer, and there mixed with air. The vapor and air are sucked in and driven out of the holder by its alternate rise and fall, actuated by the pressure of the vapor on entering and its escape on leaving, and controlled by valves worked by an attachment to the holder itself. In making their stand-

ard gas these machines consume about six gallons of gasoline to the thousand feet of air carburetted. At the Exhibition the gas is shown burning in all the various kinds of burners. It gives the peculiarly characteristic flame and the peculiarly characteristic smell.

An exhibit that appeals to a very wide interest is that of the Goodwin Gas Stove and Meter Company, of Philadelphia. Their display is very handsome and extensive, and contains nearly every conceivable device for converting gas into fuel. Stoves, ranges, heaters, open fires, radiators, hot water generators, iron heaters, etc., are arranged in rather bewildering profusion. The constant attention that these appliances attract, and the continuous exclamations of surprise that are heard, show to what an extent the public is as yet untaught as to the possibilities and economy of gas fuel. The Verity Brothers' "patent gas fires," that so closely imitate the action and even the appearance of burning coals, are the object of special admiration. Indeed, when they are used in imitations of the cylindrical coal stove, with the regulation isinglass, the illusion is almost complete.

The Clerk Gas Engine Company, of Philadelphia, exhibit two gas engines, one of 15-horse power and the other of 10-horse power. These engines drive the lathes, planes, and boring machines exhibited by Messrs. William Sellers & Co., of Philadelphia. As a detailed description of this engine and its working was included in our report upon the Electrical Exhibition last fall it will not be necessary to give it extended mention here. We may add that by the use of a new governor the gas consumption per horse power has been considerably reduced. Formerly only the gas was shut off when the load was thrown off the engine; now it is arranged that the air as well as the gas will be checked, and thus the proper proportions in the explosive mixture are at all times preserved.

In the issue of the JOURNAL of date of October 16, 1884, there appeared a detailed account of the "Stockport" gas engine, which was then being placed on the English market by Messrs. J. E. H. Andrews & Co., of Stockport, England—whence its name. This engine has recently been brought to this country, and is exhibited at the Exhibition by its Philadelphia agent, Mr. B. B. Clem. Its manufacture here is conducted solely by the Dickson Manufacturing Company, of Scranton, Pa. In construction it is very compact and simple. There are two cylinders—a main working one and an auxiliary supply and compressing one. These are arranged on the same axial line, and the mechanism is so adjusted that there is an explosion at every revolution; but its force is proportioned very nicely to the work desired to be performed. We cannot speak too highly of the action of this engine; it runs with almost incredible smoothness, and it almost literally approaches the desired condition of noiselessness. The whole effect is one well calculated to delight the eye of every mechanic. Only a single specimen (one of 4-horse power) is exhibited; the other sizes, of from one to ten horse power, however, are now being constructed. The gas consumption is said to be 20 feet per indicated horse power per hour. Want of space prevents further comment; but we may say briefly that in its structure and in its action there seems little more to be desired.

In the northwest corner of the Exhibition building stands the exhibit of the Southwark Foundry and Machine Company, who, besides doing foundry and machine work, are manufacturers of all kinds of gas apparatus. No gas appliances, however, are shown at the Exhibition. The display consists of two of their high-speed engines, of 40 and 50 horse power respectively; a centrifugal pump; and a set of new friction-clutches. These last are most ingenious pieces of mechanism. The clutch consists of a right and left-hand screw pinion operated by a rack passing through a shifting lever. The moving of this lever carries out two pads from the center to the periphery of an internal casing, and makes the connection of the pulley with the shaft; a movement of the lever in an opposite direction leaves the shaft free again. Thus any number of pulleys can be run or cut off at will while the operating shaft pursues a constant and undisturbed rotation.

We believe we have now mentioned nearly all the exhibits bearing upon the gas industry; and to note the remaining objects of general interest with any attempt at detail would involve an apparently endless task. Many of these other exhibits represent an ingeniousness of mechanism and a perfection of process that provokes unflinching wonder. Especially noticeable are the various classes of motive powers, including steam, electricity, gas, hot air, water, and springs. By those motors all kinds of mechanical appliances are operated—for heavy work, lathes, planes, punches, riveters, drills, and hammers; and modifications of the same principles are seen executing work upon the smallest scale and with marvelous nicety. A single exhibit that does not fail to attract everyone's attention is the angular shaft coupling for the transmission of shaft power in any direction—around corners, or upward or downward at any angle or series of angles.

In the domestic departments there is displayed nearly everything that has been invented with a view of contributing in one way or another towards making life worth living; and we observe a remarkable number of articles designed to facilitate manipulation in the domestic processes. The building is girt about by a suspended electric railway for carrying packages from one

part to another; and in the center of the main vault stands an iceberg, some 10 feet in diameter at its base and about 30 feet high, sustained in a temperature of 70° by the De La Vergne Refrigerating Company's apparatus.

In conclusion we may say that there is to be found all that would be looked for in an exhibition of this character under such auspices as it enjoys. Through the medium of the "Novelties" Exhibition the Franklin Institute is doing excellent educational work of wide reaching influence; and it is to be hoped, for our part, that the lesson taught by the gas display will not be lost upon the gas consuming public.

Coal Versus Coke in the Jarvis Furnace.

The following table embraces report of tests in evaporation made on a steel tubular boiler set with the Jarvis patent furnace, at the Silver Lake Company's mill at Newtonville, Mass., and represents a day's work, using different kinds of fuel. The tests were comparative, all having been made alike; the water, coal, and coke were weighed in each test on scales. The fires were started fresh every morning.

Claims have recently been made that at the present low cost of Cumberland bituminous coal it was cheaper to burn it under boilers than to use coke; but these tests prove the contrary.

Report of Tests.

Date of test.....	July 21. 11 h. 12 m.	July 22. 11 h.	Oct. 7. 12 h.
Kind of fuel used.....	Egg.	Cumberl'd.	Coke.
Total weight of water evaporated.....	18,000	17,600	26,625
Equivalent evaporation from and at 212° ..	19,548	19,131	29,288
Total weight of fuel consumed.....	2,415	1,954	3,584
Total weight of ashes and refuse.....	479	167	3.55
Total weight of combustible.....	1,936	1,787	3,299
Fuel consumed per hour per sq. ft. grate surface.....	7.84	6.46	9.05
Average temperature of feed water.....	152.48	152.00	142.85
Average pressure of steam.....	45.63	43.00	53.12
Water evaporated per pound of fuel under observed conditions.....	7.45	9.00	7.45
Water evaporated per pound combustible.	9.29	9.85	8.26
Equivalent evaporation per pound of fuel from and at 212°.....	8.10	9.79	8.19
Equivalent evaporation per pound of combustible from and at 212°.....	10.10	10.70	9.07
Cost of fuel consumed in time run.....	\$5.38	\$4.45	\$5.37
Pounds of water evaporated per \$1 worth of fuel from and at 212°.....	3,636	4,348	5,454
Horse power developed from and at 212° ..	58.18	57.97	81.00
Economy of using coke, at \$3 per ton of 2,000 pounds, over egg of 2,240 pounds, at \$5.....			33.33 p. ct.
Economy of using coke, at \$3 per ton of 2,000 pounds, over Cumberland of 2,000 pounds, at \$4.50.....			22.79 p. ct.
Cost of fuel per ton delivered at the mill, including freight, cartage, etc.:			
Egg coal, per 2,240 pounds, \$5; Cumberland coal, per 2,000 pounds, \$4.50; coke, per 2,000 pounds, \$3.			

Comparing the above figures with those published on page 178 of current volume of JOURNAL, it will be noted that coke gives even a better economical result than that obtained from firing with screenings.

Report of the Pittsburgh Commission on Natural Gas.

Accidents traceable to supplying natural gas in Pittsburgh caused the bringing of several suits in equity, against two of the natural gas companies, in the Court of Common Pleas of that city. The Court in turn appointed a Commission of five members, and referred the matter to them for investigation into the dangers attending the distribution and use of natural gas, with special instructions to report what can be done by gas companies to render the use of natural gas compatible with safety. The Commission issued subpoenas compelling the attendance and testimony under oath of all persons presumed to have knowledge of any phase of the subject, and listened to what was offered by engineers and chemists, laborers on the works, cranks with one idea, and inventors with none. The conclusions are mainly to the effect that gas at high pressure should not be allowed within the city limits, and for conducting to that result suggestions are made that the several permanent stations in the city be connected by telephone to those at the gas wells, and along the pipe lines. Transverse pipes leading from one gas main to another, and with stop-valves at intervals of 3,000 feet in the main lines, would afford means for maintaining a uniform pressure on the pipe lines. That no pressure greater than 10 pounds to the square inch be allowed on the low pressure mains, and that suitable mercury columns indi-

ating the pressure of the gas be placed in every public building where it can be examined by any one. The pressure used by manufacturers to be reduced by a gas governor, so that the gas should be consumed at a pressure not exceeding two ounces of water. The only recommendation involving any considerable expense is the one requiring that the mains be lowered to below the frost line. The leakage is excessive at the joints of pipes made and installed in manners which have proven perfectly satisfactory for the conduct of other fluids. A number of recommendations for the installing of gas lines possess much value, as being the conclusions based upon the opinions of numerous persons familiar with such work. The use of standard thread on the pipes used for mains removes 37.4 per cent. of the metal, and it is recommended that such weakness be obviated by thickening the ends of the pipe, so that when the thread is cut there will be a greater thickness of the pipe at the bottom of the thread than elsewhere. That the screws on the end of the pipes should be not less than ten threads to the inch and tapering. When the thread is being cut the end of the pipe should be filled with an expanding plug to prevent distortion. The sockets should be made of homogeneous iron or of steel, and of such length that the ends of the pipe will not come in contact with each other. When the pipe is laid in the trench it should be painted with oxide of iron paint, except in cinder beds, where it should be laid in terra-cotta pipes of 6-inch greater diameter than the outside of the iron gas main, and the intervening space filled with asphaltum. The other suggestions refer to methods of testing the pipe lines after construction.

SPECIAL ENGLISH CORRESPONDENCE.

COMMUNICATED BY NORTON H. HUMPHREYS.

SALISBURY, Oct. 10, 1885.

The Standard of Light.—The District Associations.—Mr. B. W. Smith, on Revivification in situ.—Status of Duties of Auditors.—The Sulphate of Ammonia Producers' Association.

Some time ago I remember of seeing in one of our comic papers a series of illustrations showing the decrease that has gradually taken place in the size of the penny roll. Fifty years ago it appeared to be sufficient in cubical contents for a good meal; but now it was represented as having dwindled down to a size not much larger than the coin for which it is exchanged. According to a correspondent of the *Times*, writing under the initials "A. V. H.," a few weeks since, something of this sort is likely to happen to the standard candle used for testing the illuminating power of gas. I do not mean to say that the standard is going to gradually dwindle in size, through the various stages of eights, twelves, chamber candles, rushlights, and tapers, till it disappears altogether, but "A. V. H." refers to the amount of light given by this useful agent, which he considers is not so much as it used to be. His reasons for this suspicion (for he gives us experiments or other proof) are remarkable. The chief purchasers of standard candles, he says, are gas companies, and he proceeds to make the amiable suggestion that they naturally prefer the candles that give the lowest amount of light. In effect, he says that they would be glad to drive through the Acts of Parliament, and take credit for supplying a higher quality of gas than was actually the case. Then it is inferred that the manufacturers are inclined to meet this demand for debased candles, and thus, according to the peculiar style of argument adopted by "A. V. H.," the illuminating power of the gas supplied is under the control of a few manufacturers of a particular kind of candles.

It is scarcely necessary to add that several replies appeared in the *Times* in due course—the makers of candles, on the one hand, asserting with more or less indignation that they made the candles in the manner prescribed by Act of Parliament, and that no attention had been given to the diminution of the light obtained from them in the manner above suggested, nor had any suggestion in that direction ever been made to them; while the gas companies denied, with equal warmth, that the imputation had even the slightest grounds in fact. And in a subsequent letter "A. V. H." sought to explain away this objectionable part of his argument.

It speedily became an open secret that the initials "A. V. H." represented Prof. A. Vernon Harcourt, who, rather singularly, happens to be the inventor of an arrangement known as the pentane standard, which has lately been brought forward as an improvement on the standard candle. The Prof. most deservedly occupies a high position in learned and scientific circles, and therefore his arrangement has been well received in those quarters. Its accuracy is not questioned when used by a competent operator; but, as some manipulative skill is required, the "pentane standard" does not recommend itself to practical men. The letter we have mentioned was accompanied by an editorial in the same paper in which the pentane is highly belauded, and a few kicks are bestowed upon gas companies in a cheap popular style, the argument of "A. V. H." being especially noticed and even exaggerated.

At the meeting of the British Association, at Aberdeen, held a few days

subsequently to the above events, the same thing was repeated. The Committee on the Physical Section presented a report on "Standards of White Light," in which the standard sperm candle was unsparingly condemned. And Prof. A. Vernon Harcourt read a paper on his pentane standard. No fault can be found with the use of legitimate means for the introduction of a new system as a standard of light, but when these are backed up with insinuations which, although perfectly groundless in fact, will be accepted by a large section of the public as perfectly true, gas engineers and all others concerned have a right to resent such unfounded aspersions on their honesty.

There sometimes appears to be a tendency to forget that the gas consuming public have eyes. If the illuminating power of the gas supplied throughout the country is reduced in value, is it reasonable to suppose the gas consumers would be ignorant of the fact, or that they would be deceived by any representations, however specious, to the contrary? Apart from the question of ordinary honesty, it is extremely unlikely that gas engineers will ever get into a fools' paradise, and supply gas which is really of inferior quality, but which by some sort of juggling may be shuffled by the examiners as complying with the Parliamentary regulations. In many districts it is preferred to supply gas three, four, and even six candles higher in quality than that agreed for, simply with a view of satisfying the public. The idea that the proprietors of gas undertakings are perpetually seeking to plunder their customers to the greatest possible extent, disregarding of all ordinary principles of honesty and fair dealing, is very popular in certain quarters, and is often repeated by those who have every opportunity of knowing better. But, nevertheless, it is absolutely without foundation in fact.

The autumn meetings of the district Gas Managers Associations are now taking place. The "Southwest," the "Midland," and the "North of England," have followed each other in close succession. In each case papers were read, and discussions followed, on various topics interesting and useful to gas engineers, and the district associations appear to grow and increase rather than otherwise. Mr. B. W. Smith, of Smethwick, came forward at the Midland meeting with a paper distinctly novel in character, comprising the results of some experiments he had tried at his works on oxide purification with revivification *in situ*. This subject has lately attracted a good deal of attention, and therefore Mr. Smith's contribution is most opportune and acceptable. The first thing to be noticed is that this gentleman makes a profit out of his oxide. The spent material realizes more than the first cost and the labor necessary for changing purifiers. The effect on illuminating power and make per ton has been specially noted. About 165 tons of a particular kind of coal were used, without air; and immediately afterwards an equal quantity was used, air being admitted to the extent of 1.45 per cent. The experiments occupied seven days each, and the effect of using the air was to increase the yield of gas to the extent of 2 per cent., and to reduce the quality from 17.1 to 16.53 candles, or about 3 per cent. Another kind of coal was tried, with and without air, as before, about 95 tons being used in each trial, and the use of air in this case was found to diminish the illuminating value to a similar extent, while the increase in yield was only about 1 per cent. The air was drawn in by the exhauster through a one-inch hole tapped on the inlet to the condenser, a 20-light meter and regulating cock being used for the purpose of delicately adjusting the quantity of air admitted. The purifiers are large in area in proportion to the make, and contain two layers of oxide each 12 inches thick. Mr. Smith explains in detail that only the oxygen of the air is retained in the purifier, the nitrogen passing on with the gas. He also gives the results of a series of experiments made with air, oxygen and nitrogen, respectively, for the purpose of ascertaining their effect on the illuminating value of coal gas when added thereto in small quantity. Observations were made with mixtures containing $\frac{1}{2}$, $\frac{1}{3}$, $\frac{1}{4}$, 1, 1 $\frac{1}{2}$, 1 $\frac{1}{4}$, 2 and 3 per cent. of these substances. Nitrogen shows a regular loss of one-fifth of a candle for each one-quarter per cent. added. With air the loss is slightly less than with pure nitrogen. The first two additions of oxygen were found to have the effect of increasing the illuminating power, but this good effect is rapidly lost, and after one per cent. of oxygen is exceeded the loss follows a regular course of rather more than that caused by adding nitrogen. Mr. Smith's experiments show him that he can save about £30 per annum by using the air, and also partially avoid the nuisance of changing his purifiers; but against this must be set the slight diminution in the illuminating value of the gas.

A conference of "Elective Auditors"—that is, the auditors elected for the purpose of examining and certifying the accounts of local authorities—has been held at Manchester. Certainly, the annual sums passing through the treasuries of some of our principal corporations who own gas works, water works, and other public undertakings, must be very large, and of such importance as to require very efficient men for this office. The principal object of this meeting appeared to be to lament the fact that the auditors of corporation accounts do not possess sufficient authority, and to see what could be done to remedy this state of affairs. It appeared that the citizen auditor of Manchester was mainly responsible for summoning the meeting,

and most of those who replied to the invitation to be present, agreed that the audit of accounts as at present conducted was a perfect farce. This is rather amusing, and naturally raises the question of whether it is worth while to have auditors at all. What would be said, for example, if a meeting of gas engineers agreed that the work of gas engineering, as at present conducted, was a perfect farce? The interpretation to be placed upon the duties of an auditor is a very wide one. Some would say that he is simply called in to certify that the statement of accounts is correct according to the books and vouchers. Others would so far extend the duties that the auditor would virtually become the head accountant; not only, it is urged, should he examine the books, but also the system by which they are kept, and have power to alter it according to his own views, with the object of preventing any opening for fraud; and further that he should have the power of rejecting or uncharging any expenditure which may be wrongfully (in his opinion) incurred, or of rearranging such items as he may deem to be wrongfully placed. In addition to this he may have the right to raise the question of how the money has been expended—whether the coals, bricks, or other material purchased have been obtained in the cheapest market. The former view is the general idea of the purpose in electing an auditor; but the gentlemen who assembled at Manchester appear to consider that all the latter duties, and more, should devolve upon that official. One speaker, by the way, was evidently very spiteful against the managers of gas undertakings, apparently for some personal reason, and made several unwarrantable accusations against them, stating that it was a general custom in that profession to specify for and receive bribes, in one form or another, from the parties who supplied their materials. This gentleman forgot that auditors were also human, and just as likely to be dishonest as gas engineers. So that, looking at the matter from his uncharitable point of view, it would be simply a case of setting a dog to catch a dog, and in addition to squaring the engineer, of also squaring the auditor. The discontented accountants were fortunate in getting a member of Parliament to preside, and they passed a resolution requesting him to bring their views before Parliament. So the auditor of the future, in the event of these gentlemen carrying their point, which is by no means certain, will be an accountant, lawyer, engineer, magistrate, and private detective rolled up into one, and, in a general way, the boss of the whole concern. No respectable professional man would tolerate for one moment the system of objectionable espionage which some of the elective auditors consider to be necessary, and the undertaking or corporation that left the discovery of dishonesty—which after all is an exceptional and not a general thing—to its auditors, would indeed be unfortunate.

I have previously alluded to the fact that artificial means have been brought to bear in the sulphate of ammonia market to keep down or reduce the price of this substance; that speculators, by means that are well understood, have forced the producers to accept prices that are really below the fair market value. This has again attracted attention, and a suggestion has been thrown out, in the columns of the *Journal of Gas Lighting*, that the producers should combine and form an association with the object of protecting their interests. Mr. G. E. Davis, late Government inspector under the alkali act, and well known in gas and chemical circles, has taken the matter up by issuing a circular to every maker of sulphate in the United Kingdom inviting co-operation in forming such an association. Looking at the present state of the market, any argument in favor of the necessity for a "sulphate association" is superfluous, and there is little doubt but that the movement will be well supported by directors and gas committees.

The Past and Present State of Gas Lighting in Scotland.

At a recent meeting of the Edinburgh and Leith Gas Company, Mr. John Reid, of Rosemont Ferry Road, Edinburgh (ex-engineer and manager of the above-named company), gave some interesting particulars regarding the past and present history of the Scotch gas industry. We here append the most striking features of the same. As a native of Perth, Mr. Reid distinctly remembers the erection of the first gas works in that city, in the years 1824-25. Gas had been introduced into Edinburgh, Glasgow, Dundee, and one or two other large towns a few years earlier. The Perth Works were designed and erected by Mr. Adam Anderson, LL.D., Rector of the Perth Academy, and subsequently Professor of Natural Philosophy in the University of St. Andrews. The projectors of the works wisely determined to avail themselves of the most recent improvements in gas manufacturing and distribution, and Dr. Anderson was requested to visit the chief towns in the country to see what improvements might be adopted. As the result the Perth works was erected on the best known principles, and of such extent as was thought adequate for lighting the town for fifty years to come, and they were for some years considered a perfect model of what such works should be.

At the outset the retort house was formed like a half-moon battery with 12 cast iron retorts, and their mouths directed to the center of the semi-circle. The condensers were four cylindrical vessels, about 8 feet high, and

6 feet diameter, stuffed inside with twigs of heather and broom, in which the tar was intercepted by the twigs and found its way to a tar pit. The purifiers were small affairs, about 6 feet long and 4 feet wide. Two gasholders, enclosed in a substantial stone building, were together capable of storing about 10,000 to 12,000 cubic feet of gas, of which 8,000 or 10,000 was the maximum consumption daily during the depth of winter.

As showing the progress of gas consumption in the city of Perth, Mr. Reid states that there were manufactured for the city in the year 1883 upwards of 64,000,000 of cubic feet, and the maximum daily consumption during the winter of that year amounted to 361,000 cubic feet.

His father was appointed manager for the Perth Gas Company in the year 1827-28; and long before his death in 1844 the requirements of the gas consumers had exceeded the capabilities of the establishment, which had to be greatly extended. The original buildings and works have now nearly disappeared, nothing remaining but the motto from Horace over the main gateway:

"Non fumem ex fulgare sed ex fumo dare lucem."

In the days of the first gas managers the price charged for gas generally was 15s. per 1,000 cubic feet. It was 12s. 6d. at Perth in 1827-28. The quality or illuminating power at that early period—owing to the cheap and abundant supplies of the richest cannel coal obtained from the adjoining county of Fife—must have amounted to, and probably exceeded, thirty-candle power. But in these days the now familiar phrases, "photometry," "standard candles," "illuminating power," and such like, were rarely heard of, and if they were not above the general comprehension, they were practically ignored by the average Scottish gas manager of the time.

From the earliest period, and for several years, Perth gas was regarded as remarkable for its high illuminating power and general purity, and Perth was often visited by parties about to construct works for other towns, although the provisions for its manufacture and purification fell far short of what exists at the present day. The duties of the manager in those days differed in many respects from what they now are, and brought him into closer relations with the consumer than is now necessary. The gas meter was in use at that date, but was a very costly article, costing three or four times the present price. A very large proportion, probably two-thirds of the consumers, requiring only one or two lights at most, were supplied by contract for so many hours' gas light, from certain stipulated burners, to be used from sunset to 10 or 11 p.m., and from 6 a.m. till sunrise. For the prevention of fraud a staff of inspectors was kept up, whose duty it was to perambulate the streets night and morning, and whenever a consumer's light was found burning beyond the stipulated time, he was pounced upon and the charge for gas correspondingly raised, and if he refused to pay the supply was cut off. But large householders, shop keepers, hotel keepers, and others were by their own desire supplied with gas meters, which they generally purchased from the company and held as their own property. Some years before 1844 time-burning was given up, and gas meters came universally into use for all private consumers.

The secondary products of coal tar and ammoniacal liquors which of late years have proved the source of large revenue from gas undertakings were for several years a source of constant perplexity as to how they should be disposed of. There was no market for either, and the chemist had not discovered the purposes to which they have since been applied. The occasional drainage from the Perth works carried some of these matters into the river Tay, and the conservators of the river took vigorous steps for stopping the nuisance. A movement was then in progress for deepening the channel and improving the navigation of the Tay to Perth, and for constructing a tidal basin near the harbor for the shipping traffic. This latter branch of the scheme was not gone into, on account, it was said, of the difficulty in disposing of the materials that should accumulate from the dock excavation. A solution of this practical difficulty was reported to be recommended by a member of the Town Council. It was to dig a hole big enough in the South Inch to hold all the materials to be excavated from the proposed dock. For some reason or other the suggestion was not carried out. But something like it was tried by the gas company for the disposal of the accumulating tar and gas liquors. Large pits were sunk within the grounds of the company for their reception, in the hope that the porous strata would absorb them. The expectation was not realized; and it was then resolved that tar should, as far as practicable, be used as an auxiliary to the fuel employed for heating the retorts; and the surplus was burned up in a fiery chamber constructed for the purpose, and the smoky products discharged from the top of a large chimney. In the winter of 1828-9 it was found that coal tar as a fuel produced a very fierce heat, and was very difficult to regulate; and the cast iron retorts exposed to it, although shielded by firebrick protectors, were very quickly injured by the penetrating heat. Various consultations ensued between Mr. Reid's father and Mr. M'Vicar, the firebrick maker of Inverkeithing, as to whether retorts could not be made entirely of fireclay; and the result was a trial of two or three retorts made in short lengths and joined together with fireclay. They were found to be gas-tight, an gradu-

ally fireclay retorts superseded cast iron at the Perth works at that early date, and they are now universally employed by gas manufacturers throughout the world.*

The close of the first quarter of the century was marked by enterprising effort for the better lighting of the chief towns of Scotland. Edinburgh was early in the field, and so was the burgh of Leith; and, rather curiously, we find that both local companies were engaged in manufacturing illuminating gas from oil instead of coal. Whale and fish oils were the raw materials from which the gas was made and supplied to the consumers in both communities. Some years ago, in looking over some papers belonging to the old Leith Gas Company, Mr. Reid fell in with a printed prospectus by that company, dated 16th April, 1823, containing the rules and conditions under which the oil gas should be supplied and used by the consumers, the price being stated at 5s. per 100 cubic feet (or 50s. per 1,000). He found, also, a similar prospectus of the Oil Gas Company, of Edinburgh, along with a list of the directors, of whom Sir Walter Scott was chairman, dated 1824. In this prospectus the price was quoted at 52s. per 1,000 feet. Both of these documents are framed, and may now be seen in the board room of the Edinburgh and Leith Gas Company, St. Andrew Square. The contrast between these prices and the current price in 1885 of 3s. 6d. per 1,000 feet is remarkable. But it should be observed that the illuminating power of coal gas, which may average about 25-candle power, is only about one-half of that from oil, which gas was equal to 48 or 50 standard candles.

The original works of the Edinburgh Oil Gas Company were situated at Tanfield, Cannonmills, the main buildings of which, now occupied as wool stores, are still standing. The two conspicuous circular tower-like buildings which catch the eye on turning round the corner of lower Brandon street were the buildings which contained the two gasholders from which the city was then supplied with gas. Judging from their extended dimensions, and contrasting them with the numerous large gasholders situated in their vicinity, and other still larger ones elsewhere in Edinburgh, the utmost capacity of the two original holders of 1824 would not now be equal to maintaining the supply on a winter evening for longer than five to ten minutes.

ITEMS OF INTEREST FROM VARIOUS LOCALITIES.

GASOLINE EXPLOSION.—The street lamps on the outlying roadways of the city of St. Paul, Minn. (or at least those on avenues to which the gas mains do not extend), are fitted for the consumption of gasoline, and occasionally the gasoline will make itself heard and felt. The latest case recorded there took place on the evening of October 15, and it would certainly seem as though the victims to the accident were guilty of gross negligence. On the date named lamplighter W. H. Clarke, assisted by his son, were making their usual rounds. The wagon that conveyed them contained several cans charged with the lively fluid, and it appears that it was Clarke's practice to fill the lamp reservoirs, his son immediately afterward igniting the vapor at the burner. This time, however, young Clarke ignited the vapor so successfully that the flame communicated to the supply stored in the wagon. When the damage was reckoned up it was found that Clarke and his son had sustained severe injuries; the horse was dead, and the base of supplies (or the wagon) had been reduced to kindling wood and scrap iron.

REDUCING PRICE OF GAS AT COLUMBUS, IND.—Mr. C. M. Keller, Secretary of the Columbus (Ind.) Gas Light and Coke Company, informs us that the managers of the company have decided to reduce gross selling rates to \$2.20 per thousand cubic feet, with a discount of 20 cents per thousand when accounts are settled within the first five business days of the month. Where a single meter shows a registration of but 100 cubic feet in any 30 days the charge for same will be 25 cents; in other words, no bill for a less sum than 25 cents will be rendered. In any event, we expect that Secretary Keller will have but few such bills to present. The Columbus folks probably know that gas at \$2 per thousand is a cheap commodity; and it altogether rests with themselves when a still lower price will become operative there, for Brother Keller plainly tells them that their liberal use of the Columbus Company's product is sure to hasten the desired event. This new rate is an "all-round" figure—no discrimination being made between gas supplied for illuminating, cooking, heating, or power purposes. The scale becomes operative on November 1st.

*It has been suggested to the writer of these reminiscences that it might prevent possible misapprehension did he explain that, in his reference to fireclay retorts at Perth, about 1829, he entirely disclaims having any purpose of putting forward claims for merit for either of the gentlemen named as being the originators of the idea of making gas retorts from fireclay, or as being the first to put them in operation. Nothing is stated or intended, to convey that impression, since Mr. Reid at the time of writing had ample knowledge of the labors of Grafton in the same field many years earlier, entitling the latter, of course, to all honor due for originality in the matter. Reference to the incident at Perth was solely made for the purpose of noting the *early date* when the question, "Fireclay vs. Iron" became subject of consideration under the circumstances existing at the works at that time.

NEW GAS COMPANY.—A correspondent informs us that a gas company has been incorporated to supply the illuminating needs of the town of Frankfort, Ind. A site has been acquired whereon to construct the works, and it is expected that January, 1886, will see the new enterprise in fair working order. Frankfort is the capital seat of Clinton County, Ind., and is located at the junction of the Logansport, Crawfordsville and Southwestern, and Frankfort and Kokomo Railroads.

"CANING" A GAS MAN.—Superintendent R. W. Hardy, of the Staunton (Va.) Gas Light Company, on date of October 6, received a rather mysterious summons to the office of the works. He thought that trouble of some sort or another was brewing, since he noted that the employees were making rapid strides in the same direction; but still he could not account for the sudden cessation of work, as the men had never complained about the way they had been treated, and further, even at this crisis, he failed to read discontent in their faces. Supt. Hardy's fears of a "strike" were groundless, although Capt. Long is reported to have explained subsequently, or when the true inwardness of the affair became apparent to the genial Hardy, that he (Hardy) was "struck speechless." Apart from that, however, when the Superintendent reached the office he found the employees of the company gathered in an appropriate group for the complete transaction of the business in hand. His entrance was the signal for Capt. Long to advance a pace or two, and as that gentleman did so he thrust into the hands of the astonished gas man a long, slender case, like unto that which jewelers employ for concealing valuable walking sticks. At any rate the contents of this particular case proved to be a handsome and valuable gold-topped cane. Capt. Long made the usual presentation speech, and the victim to the "caning," when his equanimity was partially restored, feelingly responded. The top of the "stick," which is of beaten gold, bears the recipient's name, together with the words, "Presented by his friends, Oct. 6, 1885." The Hardy style of caning is of the sort that leaves no scars.

OBITUARY NOTE.—We are sorrowfully compelled to announce that Mr. H. Harthan, Secretary and Superintendent of the Selma (Ala.) Gas Light Company, has met with a severe domestic affliction, his estimable wife having departed this life on the morning of October 7. Her remains were conveyed to Cincinnati, Ohio, where the interment took place in due course. The fraternity will join with us in extending sympathy to Mr. Harthan.

TAR-FIRED BOILERS.—Mr. A. B. Richardson, besides his Presidential connection with the Dover (Del.) Gas Light Company, is also senior member of a well-known firm of fruit preservers and packers, operating under the title of Richardson & Robbins, in the same city. Mr. Richardson is a keen business man, and finding that the tar produced on the gas works did not meet with ready sale, he experimented in the direction of providing a satisfactory outlet for its disposition. The success attained by him is outlined in the following letter:

DOVER GAS LIGHT COMPANY, }
DOVER, DEL., Oct. 19, 1885. }

To the Editor AMERICAN GAS LIGHT JOURNAL:—Finding our gas tar accumulating rapidly, in consequence of the light demand for it in our locality, it occurred to us that we would try the experiment of burning it under the boilers in operation at our canning factory, and the following is the result: We have two 50-horse power return tubular boilers, and one of these was fitted up with a steam-jet for the purpose of delivering the tar into the fire in the shape of spray. *Without* the tar we used 60 bushels of coke per 24 hours; with 25 gallons of tar we used but 24 bushels of coke in same time, and kept or maintained a steady fire and 80 pounds of steam. We shall now fit up the second boiler in similar style. We consider coke worth 8 cents per bushel compared with anthracite coal at \$6 per ton. Keeping these figures in view we achieved a saving of over \$2 per diem—providing, of course, that we could sell the tar. You may think 60 bushels of coke rather a large quantity in the firing of one 50-horse power boiler; but we employ live steam drawn direct into the water, which practice takes up much more steam than that required to actuate a 50-horse power engine.

Respectfully, A. B. RICHARDSON.

HIS ACCOUNTS PROVED HIM A DEFAULTER.—Mr. Wm. H. Corley was for several years prior to December 25th, 1875, Secretary to the Quincy (Ills.) Gas Light Company, and was also one of its most heavily interested stockholders. On the date above recorded Mr. Corley, after an exceptionally successful and honored career, resigned all earthly trust, and shortly thereafter his son, Henry R. Corley, succeeded to the Secretaryship of the Quincy Company. Young Corley enjoyed an excellent reputation, and was held in high esteem by his employers. Their unswerving confidence proved Corley's ruin, since it afforded him (some time ago Corley was named to the position of acting Treasurer) ample chance to make free with the funds of the company. The directors accepted his accounts from year to year without making any examination (at least so the story goes) of same, or at

any rate went no further than to glance at the totals of the balance sheets presented for their inspection. Some months since Corley's rather extravagant mode of living attracted the attention of one of the directors, and this official quietly instituted an examination into the Secretary's accounts. This course led to the discovery that Corley had been misapplying the funds of the company, and his resignation was asked for. When this was secured Mrs. A. M. Corley (the defaulter's mother) agreed to give the company a bond in the sum of \$12,000, the directors in consideration thereof promising not to cause criminal prosecution of the delinquent. It is now claimed that the total amount of Corley's speculations will closely approach the sum of \$20,000, and it has been proven that his pilferings extended through all the years of his official connection with the Quincy Company. Of course, the discovery in no wise affects the stability of the company, but it is matter for regret that the directors should condone their Secretary's rascality. From our view of the case, and arriving at such view from the evidence presented, it would seem as though Corley's offense was unforgivable, and that he deserved the fullest measure of punishment that could be administered. While on this subject we cannot forbear noting what a rare thing it is to hear of speculations or defalcations occurring amongst those who handle the monies of our gas corporations. And this is all the more striking when one remembers the vast monetary transactions involved, together with the seemingly numerous chances that exist for successfully covering up the traces of such speculation.

GAS MATTERS AT MACON, GA.—That lively member of the fraternity, Mr. A. E. Boardman, who, as Treasurer and Superintendent of the Macon Gas Light and Water Company, is virtually the master-spirit in that dual corporation, has been faithfully adhering to the injunction, "In time of peace prepare for war." Amongst the "fortifications" erected we note that he has erected an additional holder, with a capacity of 25,000 cubic feet; a new bench of sixes fitted with McIlhenny's improved furnace—this latter arrangement having also been applied to the old benches—and the entire stacks have been fitted with the Boardman hydraulic main. Mr. Boardman asserts that this main has answered every expectation, and is much elated over its success. About 5,000 feet of gas and water conduits, of varying dimensions, figure in the summer's work; and, in addition to sales of water and gas, Mr. B. reports that he *manufactured* and disposed of some 3,000 tons of ice since last April. The business of the Macon Gas Company shows a decided and satisfactory increase, about the most pleasing feature thereof being the great enlargement charged to day consumption. Gas cooking stoves were in great demand, and the first gas engine ever shipped to Macon has just been put in operation there. Now, this is pleasing news, and we may add that a like encouraging state of affairs is reported from all sections and districts of the South.

NEW GAS COMPANY.—Boardman, however, does not yet seem convinced that his business connections are sufficiently extensive. At least we conclude so from the fact that he has associated himself with Mr. Jeter in the joint enterprise of constructing a gas and water works for the city of Brunswick, Georgia. We understand that contracts for the erection of works, etc., have already been given out. Brunswick is the capital of Glynn county, Ga.; is situated on an inlet of the Atlantic Ocean, known as St. Simon's Sound, and is about 80 miles southwest of Savannah.

WHY THE GRAND RAPIDS (MICH.) GAS COMPANY PLACED THAT "AD." IN THE JOURNAL.—We have received a score or more letters from about all sections of the country inquiring as to why the Grand Rapids Gas Company's managers are advertising a complete ten-inch coal gas plant for sale; and as it is easier for us to answer all our correspondents on this subject at one and the same time, and through the medium of our pages, than did we address a special letter to each querist, we propose herewith to settle the matter. In the first place, unless the aforesaid correspondents sent their missives to us out of sheer curiosity in the premises, it would seem as though the communications should have been addressed to "Grand Rapids," since, in the second place, in order that we might be put in the way of answering the questions correctly, we were obliged to address ourselves to Brother Gilbert, with the following result. The "ad." appears in the JOURNAL simply on account of the fact that Grand Rapids has developed so rapidly in population and wealth as to make the old 10-inch gas plant there quite inadequate to the duty of supplying the needs of the people in their lighting requirements. In order to do themselves full justice the managers of the company decided upon the erection of an entire new coal gas plant located in a different portion of the city from that occupied by the old works. The Kerr-Murray Manufacturing Co., of Fort Wayne, Ind., was authorized to erect the new establishment, and it has carried out the task with promptness and ability. The new plant comprises all the essentials of a first-class 16-inch apparatus; the retort house contains 16 benches of sixes; and, in short, every care has been given to make the new works as perfect as possible. While a 16-inch plant is somewhat in excess of the present

lighting need of Grand Rapids, there can be no doubt that the gas people have acted wisely in their provision for future growth. The liberal policy pursued by that company in regard to selling prices, quality of product supplied, and the important conciliatory and public-spirited plan of extending mains into districts that may for some time be looked upon as affording doubtfully profitable territory, accounts for its rapid growth; and it may be noted the increasing business of the gas company has been achieved despite the operations of an exceptionally enterprising local electric lighting company.

EVEN THE NEWSPAPER MEN THINK SO.—In looking over the issue of the Buffalo (N. Y.) *Courier*, dated Sunday, October 25th, there appears, in a column headed "Lockport News and Gossip," an item to the effect that the "Lockport Gas Company has again taken to carbonizing coal with the consequence that the commodity they now supply gives light—what the naphtha-engendered article did not do." Possibly the Lockport gas folks might be induced to tell us something about this matter. At any rate, we herewith extend an invitation to them in the hope that they will communicate with us on the subject.

REASSERTING THEIR OPINION.—At the first meeting (24th year) of the Society of Arts, held at Boston, Mass., in the rooms of the Massachusetts Institute of Technology, on the evening of Thursday, Oct. 8th, the subject for discussion was, "The Relative Poisonous Properties of (illuminating) Coal and Water Gas." Profs. Sedgwick and Nichols (who, it will be remembered, made a joint investigation of this subject,* acting under authority of the Massachusetts State Board of Health, Lunacy and Charity, in the early part of this year) were to have read a paper before the meeting, detailing their impressions relative to the subject; but owing to the illness of Prof. Nichols, his co-worker, Prof. Sedgwick presented and read the conclusions reached by them as the result of their researches. The following is a condensed report of the Society of Arts' proceedings on the evening named:

"It is freely admitted," said the speaker, "that both coal and water gas are dangerous; but there has heretofore been no agreement as to the relative degree of poisonous characteristics. The only essential poisonous element is carbonic oxide. This is an element which has a specially destructive action on the blood corpuscles. There is, however, some question as to the effect of the smallest quantity of the carbonic oxide. Experiments with gas deprived of carbonic oxide showed that the former is not positively destructive of animal life, though producing a species of stupefaction in animals.

"Water gas for the present investigation was taken at Middletown, Conn., and the coal gas at Newton. Rooms were fitted up in a barn to imitate as nearly as possible the formation of an ordinary sleeping room. Experiments were made first with coal gas, some rabbits and pigeons being placed in the room, and after about four hours no particular symptoms except drowsiness were apparent. A second experiment was made that lasted over 24 hours, and the gas admitted finally reached to about 3 per cent. of entire atmosphere of room; yet the animals showed only a trifling uneasiness. The next experiments were made in Middletown, Conn., with water gas, and the animals were prostrated in an hour. In two hours the animals were all but dead. The celerity with which the animals succumbed was a complete surprise. Other experiments with water gas tended equally to show its deadly nature. The experiments with coal gas showed that it was difficult to get into an ordinary room enough gas to cause poisonous effects, while with water gas the contrary is the case. The different effects of different quantities of carbonic oxide have analogy to the difference of effects between a quarter of a grain and a whole grain of morphia. The quarter grain is harmless, while a whole grain is fatal. The only question which can be raised relative to the different degrees of poisonous qualities in coal and water gas is the practical importance as to danger to life. The lecturer referred to the fact that danger is incurred by the fact that houses have a tendency to suck in gases escaping in the streets. When gas passes through the earth it is still more dangerous, as the relative proportion of carbonic oxide is increased, some of the other ingredients having been absorbed." In the subsequent discussion, Dr. Abbott, an officer of the State Board of Health, was called upon. The Dr. said that "in New York, previous to 1877, the deaths from gas averaged little more than one a year, but since the introduction of water gas the number had increased ten-fold. Suicides by means of this gas have also become frequent. It is true, however, that coal gas had proved fatal under extraordinary circumstances. It is claimed by some that coal gas is open to the objection of containing a greater proportion of marsh gas than is to be found in water gas, but chemists deny that this is an active poison, and miners frequently breathe it without dangerous effects. Various remedies have been proposed for obviating the objections to water gas, such as the removal of the dangerous proportion of carbonic oxide, the utilizing of automatic safety burners, and improvement of ventilation." The meeting was voted a most interesting one by those who were in attendance,

* See JOURNAL, Vol. XLII., Issue of March 16, 1885.

SUFFOCATED BY GAS.—A young woman named Bridget Lee arrived at Bagg's Hotel, Utica, N. Y., on the night of October 14. She explained that she was on her way from St. Johns, N. B., to Albany, N. Y.; that she was poor, and begged the proprietor to give her lodgings for the night. Her request was granted. On the following morning she was discovered in her room, in a critical condition, suffering from the effects of an inhalation of illuminating gas. The burner key was turned full on, and the apartment was filled with gas. Medical aid was summoned, but she never recovered consciousness, and died at 8 o'clock on the morning of October 17. From an examination of her effects it was concluded that the woman had been a professional beggar. No suspicion of intended self-destruction attaches to the case.

A VICTIM IN NEW YORK CITY.—"Mary A. Oats, a servant employed by E. H. Darling, of 521 West 104th street, was found, early yesterday morning, dead in her bed. The gas burner in the room was turned on full. Mr. Darling thinks that her death was due to an accident. She had been in his service for more than a year, and had a good reputation."—*N. Y. Sun*, Oct. 24.

THE FRANKLIN INSTITUTE PROGRAMME OF LECTURES FOR 1885-6.—According to the Franklin Institute Announcement and Programme of Lectures for 1885-6, we note that Prof. A. B. Sadtler, of the University of Pennsylvania, on date of January 11 will lecture on the subject of "Coal Tar Distillation." The Professor is eminently well qualified to handle this interesting theme, and we hope to publish his remarks in regard thereto. Dr. W. H. Wahl, Secretary of the Institute, will prepare a paper on the subject of "Water Gas." It will be delivered on the occasion of the December 28th session.

GAS MATTERS AT NORTH ADAMS, MASS.—Mr. Frank E. Richardson, Treasurer of the North Adams Gas Light Company, writes us to say that the corporation has attained its majority (it was incorporated in 1864), and we might add, a "right lusty and vigorous majority" it has proved to be. The capital stock remains the same (\$50,000) as it was 21 years ago, although thousands of dollars have been spent since that time in new construction, etc. This winter the plant will be put in position to supply a demand of 130,000 cubic feet every 24 hours. The main system has been extended by the addition of about one mile of pipe, and a goodly section of 4-inch conduit has been replaced by pipe of larger diameter. Supt. Woodward will try naphtha for enriching purposes this winter, it being the intention of the company to send out a 20-candle gas. The benches have been all rebuilt within the twelvemonth; and, in short, the company starts in fully equipped for the prospective great increase in business. Treasurer Richardson makes no secret of his belief in the efficacy of low selling prices, and there is every reason why he should hold to that opinion, judging from a simple recital of the history of his company's progress. He has been treasurer of the corporation for about eight years, and in that period its sales have risen from five million cubic feet per annum in 1877 to fourteen million in 1884-5; while, on the other hand, selling prices have been lowered from \$3.15 and \$3.25 to \$2.15 and \$2.25 within the same interval. It is safe to predict that Brother Richardson will soon see his way clear to authorize yet another case of "cutting rates."

DECLINED, WITHOUT THANKS.—The Prudential Committee, of North Adams, Mass., met in session on date of October 5, and among other things considered by them was a proposition submitted by the North Adams Electric Light and Power Company. The managers of the concern offered to locate and maintain 10 electric lights, at certain points on the principal streets of the town, for the sum of \$2,650 per annum. The "delicacy" of the proposition is best appreciated after reading that the 10 lights would displace 15 gas lamps, for which the town authorities now pay the gas company the total annual sum of \$450. The Prudential Committee (an aptly named set of public officers, so far, at least, as their decision in this matter is concerned) refused to consider the proposition, on the ground that "the fire district had a contract with the gas company." Better allow them to keep up the contract, eh?

BUSY MR. ANDERSON.—Mr. J. Anderson, President and Manager of the Standard Gas Retort and Firebrick Company, of Ironton, Ohio, writes that during the month of October he put the finishing touches on a new range of ten benches of sixes, in the new handsome retort house of the Detroit (Mich.) Mutual Gas Company's works. They were erected in accordance with Mr. Wm. Farmer's modification of the English bridge-wall setting. The old Detroit Gas Company folks have "put their house in order," despite the fact that the Brush Electric Lighting Company's promoters "own" the Detroit City Council. Both of the Detroit gas companies, however, appear to be "doing quite well," as the Wolverine City is fast becoming metropolitan in its proportions.

THEY HAVE MADE AN APPEARANCE.—State Senators Gilbert, Robinson, and Murphy, the special committee appointed by resolution of New York State Senate, on date of May 15th, for the avowed purpose of "investigating" the consolidation of the New York city gas companies, have given sign of

their existence. It is presumed they are on a "still hunt" for evidence pertaining to the matter in hand. At any rate, not much publicity has yet attached to their proceedings.

Gas Governors.

In the early history of gas lighting the want of a governor to regulate the pressure was soon felt, and the ready genius of Samuel Clegg—to whom we are indebted for the hydraulic main, wet gas meter, etc.—speedily filled this want. The same form of governor, so far as bell (or holder) is concerned, is now in general use; but various methods have been devised to better govern the flow of gas, as in the cone, parabola, and other forms of valves—to wit, those of Crossley, Braddock, Key, Wright, Elliot, Peebles, Foulis, etc.

The pressure given by any bell or holder depends upon its own weight, with the addition of cone, parabola, or other valves with their connecting rods, etc., in proportion to the superficial area of the crown or top of bell; and if their united weight is found too heavy for the area of same to produce the desired pressure, then a float or a counterpoise is used, so as to bring the pressure to the lightest required—namely, day pressure. To adjust to night pressure, or during hours of heaviest consumption, it has been the custom to add weights to the top of bell during the evening and to remove same during the night, so as to bring about the day pressure as soon as the heaviest consumption is over. By this means, when properly attended to, the loss of gas by leakage has been greatly reduced. But, unfortunately, it can be said that by far too many small gas works use no governors, but depend entirely upon opening and closing the street main valve; and therefore they do not avail themselves of the saving made by a well balanced governor.

The placing of weights on the bell has to a certain extent been superseded by Keeling's method, or by loading the bell (specially constructed) with water, and then at any desired time or times drawing the water off. This method is preferable to weights, as the changes on or off are more gradual, producing no sudden shock to the lights—a too frequent occurrence when weights are used.

In calling further attention to cones and parabolas, it has been found, where the gasholder pressure was heavy, that the gas in its passage exerted quite a perceptible influence on the base of either, causing oscillation of bell and blinking of the lights. To obviate this Braddock, in his governor, caused the gas to pass downward through the opening between the cone and its seat, and also caused inlet pressure to act on an equal area on the under side of the bell, so as to bring about, as nearly as possible, the effect of a balanced valve. Hartley's improvement has the same object in view.

There have been various attempts made to bring about a change of pressure by automatic means; but none of any great promise were presented until the "automatic pressure changer" of W. Cowan was brought forward. This, whilst showing great application, deep thought, and much inventive genius as an attempt at attaining the desired end, would appear to be not only a complicated but also an expensive instrument. This assertion may be qualified by the statement that it has been much simplified by recent improvements.

This line of thought—*i. e.*, governing pressure automatically—has been taken up and further pursued, both in the United States and England, as instanced by the patents of Hyde & Sons, Cleveland, Ohio, and Connelly & Co., Pittsburgh, Pa.; and also those of Messrs. T. Cains and D. Bruce Peebles, both noticed in the *English Journal of Gas Lighting* of July 26 and May 7, 1885, respectively.

This brief description of governors is here given to point out that in all prior cases the method of increasing pressure has been secured by "adding weights" on the bell, and loading by water or mercury (as in the case of Connelly & Co.), diminution of pressure being accomplished by removal of same. In the governor to be described in next issue of *JOURNAL* this principle is abandoned—the bell being so shaped that "its own weight" brings about any desired increase or decrease of pressure.

The importance of station and district governors cannot be overestimated, as, in addition to the annual saving of gas to gas companies in a decreased leakage account, they are equally beneficial to gas consumers in furnishing a uniform pressure, or one equal to the requirements. A good automatic governor that will accurately govern the supply of gas to any city, town or district in accordance with the gas requirements, will not only mark a new era in this direction, but largely increase the number in use.

No gas works however small can afford to run without a governor; and the question for those companies now operating without a governor is not, "Shall a governor be purchased?" but rather, "Which is the best instrument to purchase?"

Quoting from a paper on, "The Regulation of Pressure in Street Mains," read by Mr. R. Mitchell, of Edinburgh, Scotland (see *Journal of Gas Lighting*, Aug. 11th, 1885, page 241), the author said, "I hold that to have one-tenth of an inch more pressure on your street mains, than is actually necessary to meet the requirements of your consumers, is wasteful and wrong."

Full illustrated description of this new instrument will appear in the next issue of *JOURNAL*.—*Adv.*

The Market for Gas Securities.

The market for Consolidated gas has been fairly strong, quotations being well maintained at a moderate advance. Transactions, however, are not on a large scale, the puzzling "boom" in railway securities apparently having absorbed the undivided attention of traders in Wall street specialties. On Wednesday, Oct. 28, at auction, 70 shares Paterson (N. J.) gas were sold at 90½; a second lot of 250 shares Consolidated, N. Y. city, brought 96½ to 97½. To-day the Edison Electric Illuminating Company, N. Y. city, begin the payment of a quarterly dividend of one per cent. Brooklyn shares are strongly held, although there is but little inquiry for same. Laclède, St. Louis, Mo., is a shade weaker.

Gas Stocks.

Quotations by Geo. W. Close, Broker and Dealer in Gas Stocks,

16 WALL ST., NEW YORK CITY.

NOVEMBER 2.

All communications will receive particular attention. The following quotations are based on the par value of \$100 per share.

	Capital.	Par.	Bid	Asked
Consolidated.....	\$35,430,000	100	97	97½
Central.....	440,000	50	60	70
“ Scrip.....	220,000	—	47	57
Equitable.....	2,000,000	100	134	137
“ New Stock....			123	125
“ Bonds.....	1,000,000	—	107	110
Harlem, Bonds.....	170,000	—	—	—
Metropolitan, Bonds....	658,000	—	110	113
Mutual.....	3,500,000	100	132½	133½
“ Bonds.....	1,500,000	1000	104	107
Municipal, Bonds.....	750,000	—	—	—
Northern.....	125,000	50	50	—
“ Scrip.....	108,000	—	—	—
Gas Co's of Brooklyn.				
Brooklyn.....	2,000,000	25	131	132
Citizens.....	1,200,000	20	84	86
“ S. F. Bonds....	320,000	1000	106	110
Fulton Municipal.....	3,000,000	100	157	158x
“ Bonds....	300,000	—	104	108
Peoples.....	1,000,000	10	84	85
“ Bonds.....	290,000	—	105	110
“ “.....	250,000	—	90	95
Metropolitan.....	1,000,000	100	91	93
Nassau.....	1,000,000	25	126	—
“ Cfts.....	700,000	1000	98	99
Williamsburgh.....	1,000,000	50	161	—
“ Bonds....	1,000,000	—	111	114

Advertisers Index.

	Page
GAS ENGINEERS.	
Jos. R. Thomas, New York City.....	230
Wm. Henry White, New York City.....	246
Wm. Farmer, New York City.....	237
GAS WORKS APPARATUS AND CONSTRUCTION.	
James R. Floyd, New York City.....	247
T. F. Rowland, Greenpoint, L. I.....	247
Delly & Fowler, Phila., Pa.....	247
Kerr Murray Mfg. Co., Fort Wayne, Ind.....	247
Stacey Mfg. Co., Cincinnati, Ohio.....	247
Bartlett, Hayward & Co., Baltimore, Md.....	247
Morris, Tasker & Co., Limited, Phila., Pa.....	248
Davis & Farnum Mfg. Co., Waltham, Mass.....	246
Tanner & DeLaney Engine Co., Richmond, Va.....	246
R. D. Wood & Co., Phila., Pa.....	246
Southwark Foundry and Machine Co., Philadelphia, Pa.....	246
PROCESSES.	
National Gas Light and Fuel Co., Chicago, Ills.....	239
Burdett Loomis, Hartford, Conn.....	239
GAS AND WATER PIPES.	
A. H. McNeal, Burlington, N. J.....	244
Gloucester Iron Works, Phila., Pa.....	244
Warren Foundry and Machine Co., Philadelphia, N. J.....	244
Mellert Foundry and Machine Co., Reading, Pa.....	244
Cincinnati and Newport Iron and Pipe Co., Newport, Ky.....	244
Fox & Drummond, New York City.....	244
Ohio Pipe Co., Columbus, Ohio.....	244

SCRUBBERS AND CONDENSERS.

G. Shepard Page, New York City..... 245

REGENERATOR FURNACES.

Charles F. Dieterich, Baltimore, Md..... 164

GAS ENGINES.

Schleicher, Schumm & Co., Phila., Pa..... 224

Clerk Gas Engine Co., Phila., Pa..... 240

GAS REGULATOR.

Helme & McIlhenny, Phila., Pa..... 238

RETORTS AND FIRE BRICK.

J. H. Gautier & Co., Jersey City, N. J..... 242

B. Kreisler & Sons, New York City..... 242

Adam Weber, New York City..... 242

Laclède Fire Brick Works, St. Louis, Mo..... 242

Brooklyn Retort and Fire Brick Works, Brooklyn, N. Y..... 242

Borgner & O'Brien, Phila., Pa..... 242

Wm. Gardner & Son, Pittsburgh, Pa..... 242

Henry Maurer, New York City..... 242

Chicago Retort and Fire Brick Works, Chicago, Ills..... 242

Baltimore Retort and Fire Brick Co., Baltimore..... 242

Standard Gas Retort and Fire Brick Co., Ironton, Ohio..... 242

Oakhill Gas Retort and Fire Brick Co., St. Louis, Mo..... 242

A. T. Chur, New York City..... 239

Evens & Howard, St. Louis, Mo..... 237

CEMENTS.

C. L. Gerould, Manchester, N. H..... 238

Brooks, Shoobridge & Co., New York City..... 238

E. Thiele, New York City..... 238

Howard Fleming, New York City..... 238

GAS STOVES.

American Meter Co., New York and Philadelphia..... 243

The Goodwin Gas Stove and Meter Co., Phila. Pa..... 252

GAS METERS.

Harris, Griffin & Co., Phila., Pa..... 250

American Meter Co., New York and Philadelphia..... 251

The Goodwin Gas Stove and Meter Co., Philadelphia, Pa..... 251

Helme & McIlhenny, Phila., Pa..... 251

Maryland Meter and Mfg. Co., Baltimore, Md..... 250

D. McDonald & Co. Albany, N. Y..... 251

Nathaniel Tufts, Boston, Mass..... 250

EXHAUSTERS.

P. H. & F. M. Roots, Connersville, Ind..... 241

Smith & Sayre Manufacturing Co., New York City..... 246

Wilbraham Bros., Philadelphia, Pa..... 248

GAS COALS.

Penn Gas Coal Co., Phila., Pa..... 249

Perkins & Co., New York City..... 248

Newburgh Orrel Coal Co., Baltimore Md..... 249

Despard Coal Co., Baltimore, Md..... 249

Chesapeake and Ohio R.R. Coal Agency, N. Y. City..... 249

Westmoreland Coal Company, Phila., Pa..... 249

GAS ENRICHERS.

W. H. Doan, Cleveland, Ohio..... 241

VALVES.

Ludlow Valve Manufacturing Co., Troy, N. Y..... 244

John McLean, New York City..... 244

GAS LAMPS.

Siemens Regenerative Gas Lamp Co., Philadelphia, Pa..... 245

G. Shepard Page, New York City..... 249

Albo-Carbon Light Co., Newark, N. J..... 238

GAS KILNS AND OVENS.

Thompson Gas Kiln and Oven Co., New York City..... 241

PURIFIER SCREENS.

John Catot, Lawrence, Mass..... 220

STREET LAMPS.

J. G. Miner, Morrisania, New York City..... 213

Bartlett Street Lamp Mfg Co., New York City..... 241

BURNERS.

G. Gefroer, Phila., Pa..... 246

G. Taylor, New York City..... 239

PURIFYING MATERIAL.

Connelly & Co., New York City..... 241

STEAM BLOWER FOR BURNING BREASE.

H. E. Parson, New York City..... 238

PIPE COVERINGS.

Chalmers-Spence Company, N. Y. City..... 230

GAS FIXTURES.

Mitchell, Vance & Co., New York City..... 241

STEAM PUMPS.

A. S. Cameron Steam Pump Works, N. Y. City..... 241

SHAFTING, PULLEYS, ETC.

A. & F. Brown, New York City..... 239

STEAM ENGINES.

Westinghouse Machine Co., Pittsburgh, Pa..... 219

PIPE WRENCH.

J. H. Williams & Co., Brooklyn, N. Y..... 238

HYDRAULIC MAIN.

A. E. Boardman, Macon, Ga..... 241

WANTED,

SUPERINTENDENT FOR A SMALL GAS WORKS.

One competent to superintend the manufacture of gas, lay mains, and read and repair meters. None but sober men need apply. Address, stating salary expected, GAS LIGHT CO., MERIDIAN, MISS.

Position Wanted,

AS SUPERINTENDENT OF A GAS WORKS

Where the services of an honest, temperate, industrious man would be appreciated. Has had nine years practical experience in the manufacture and distribution of gas, and in the office work of first-class gas works. For particulars and references address "X. Y. Z.," care this Journal.

TO GAS COMPANIES CONTEMPLATING ENLARGEMENT

The Grand Rapids Gas Company will offer for sale in 1886 a Complete Ten-Inch Plant for making coal gas.

Grand Rapids, Mich., Oct. 6, 1885.

FOR SALE.

Second-Hand Gas Apparatus.

One Condenser, 4½ ft. diameter by 13 ft. in length over all, containing 150 two and one-half inch tubes, 8 ft. long with 12-in. connections and bye-pass.

Two Smith & Sayre (12-inch) Steam-Jet Exhausters, with 3 Self-acting Bye-Passes.

Four Purifying Boxes, 10 ft. by 14 ft. by 3 ft., with 12-inch connections and center seal.

All in good order, and will be sold cheap. Address

PETER P. MILLER, Manager Citizens Gas Co., Buffalo, N. Y.

TENDERS

FOR

Lighting the Streets of Toronto.

Tenders, addressed to the undersigned, will be received by registered post up to 12 o'clock noon of

Tuesday, the 1st December, 1885,

for the lighting of the streets of the City of Toronto, Canada, with Electric Light, Gas Light, or other illuminant, for one, three, or five years from the 1st day of July, 1886, or sooner if practicable.

Specifications can be seen and a copy of the same obtained on application at the office of the Chief Engineer of the Fire Department, corner Bay and Temperance streets, or at the office of the City Clerk, City Hall, after the 15th day of October.

A cash deposit, or marked check made payable to the order of the City Treasurer, for the sum of one thousand dollars, must accompany each and every tender, together with the bona fide signatures of two responsible persons who will become sureties for the due fulfillment of the contract. The deposit accompanying the tender will be forfeited to the city in the event of the necessary contract or give satisfactory sureties for the due fulfillment of the same. Deposits of unsuccessful tenders will be returned. The lowest or any tender not necessarily accepted.

JOHN MAUGHAN, Chairman Committee on Fire and Gas. City Clerk's Office, Toronto, September 30, 1885.

WM. FARMER, ENGINEER, 32 Park Place, Room 36, New York.

THE CHEMIST'S ASSISTANT; OR, KINDERGARTEN SYSTEM OF CHEMISTRY.

A system by which the elements and their valences are represented by illustrations and solid bodies. BOX AND PAMPHLET COMPLETE, \$2.50.

EVENS & HOWARD,

916 Market St., St. Louis, Mo. Works, Howard Station, Mo. Pacific R.R.

Fire Brick, Gas Retorts

AND

RETORT SETTINGS.

Sewer Pipe, 3 to 24 in. diameter.

Glass Pot Clay, Ground Fire Clay, in barrels and in bulk. All kinds of Fire Clay Goods.

Helme's Automatic Regulator

As Applied to the

FOULIS GAS GOVERNOR.

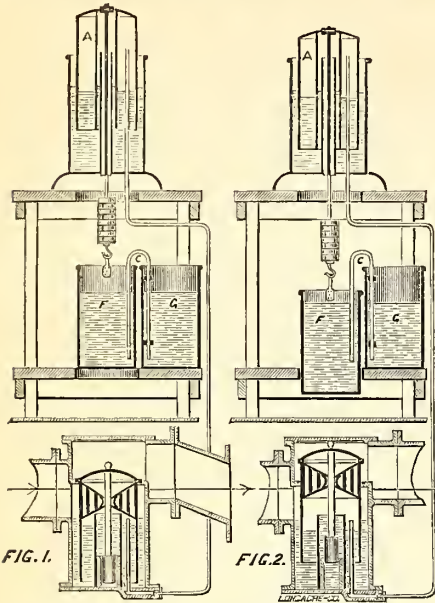

This Regulator and Governor combined are absolutely free from friction, excepting what is due to the moving of the float *A* and valve through the water. There are no journals to carry weight, and the moving parts are so nicely balanced that they do not rub against the surroundings.

The well-understood action of the inverted syphon in a fluid is made available in loading and unloading the float of the Regulator. As the demand for gas increases the float *A* descends, and with it the vessel *F*, drawing into it from the tank *G* a portion of the fluid it contains. This additional weight increases the pressure at the Governor sufficiently to overcome the friction in the pipes due to the increased amount of gas passing. When the shutting off begins a reverse action takes place. The float and vessel *F* begin to rise, and in doing so return to the tank *G* the fluid taken from it while descending.

From this it can be seen that any desired variation in pressure can be arranged for at the Governor, so as to maintain a uniform pressure in center of town. When once adjusted to the minimum day pressure and maximum night pressure it requires no further attention. For prices and further particulars inquire of

HELME & McILHENNY,
Nos. 1115 and 1117 Cherry Street, - - Philadelphia, Pa.

DYCKERHOFF PORTLAND CEMENT

Is superior to any other Portland Cement made. Its extraordinary strength permits a greater addition of sand, while its acknowledged uniformity insures the most reliable and strongest work. It is therefore the most economical to use. Circulars, with testimonials and tests, sent on application.

E. THIELE,

SOLE AGENT, U. S.,

78 William Street, - - New York.

GIBBS PORTLAND CEMENT

Is guaranteed to be the finest English brand, and unsurpassed by any grade imported for making concrete and setting masonry.

Extract of paper, with tests, read before the Am. Soc. of Civil Engineers, sent on application.

HOWARD FLEMING,

Sole Agent for U. S.,

23 Liberty St., New York.

GEROULD'S IMPROVED RETORT CEMENT.

Used by most of the Gas Companies of the United States with perfect satisfaction. Manufactured by

C. L. GEROULD,
Manchester, N. H.

N. B.—As Manchester is a shipping point, all freight can be shipped as cheaply as from Boston or New York.

BROOKS, SHOBRIDGE & CO.

Best English

PORTLAND CEMENT

WORKS: GRAYS, ESSEX, ENGLAND

New York Office, No. 7 Bowling Green.

HOWARD FLEMING,

23 Liberty Street, New York.

IMPORTER OF THE BEST

Portland & Roman Cements

"DINAS" SILICA FIRE BRICKS AND BLOCKS
For Coke Ovens and Gas Works.

Correspondence invited.

Lowest prices.

BROCK'S PATENT DROP FORGED CHAIN PIPE WRENCH

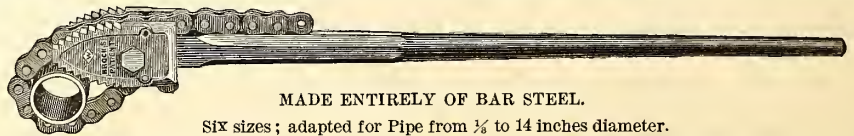

MADE ENTIRELY OF BAR STEEL.

SIX sizes; adapted for Pipe from 1/4 to 14 inches diameter.

Each number will fit a range of sizes equal to six or more pairs of common tongs, while it will outwear an equal number of any kind.

All parts are interchangeable, and can be readily renewed.

Jaws are hardened to a saw temper, and can be sharpened with a file.

Does not crush pipe; has a quick grip; never slips; chain will not unhitch while in use, but can be instantly released.

J. H. WILLIAMS & CO.,

Manfs. of Every Description of Iron and Steel Drop Forgings.

No. 14 BOWNE STREET (Near Hamilton Ferry), BROOKLYN, N. Y.

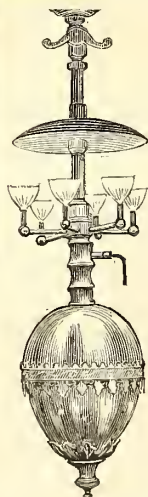

THE ALBO-CARBON LIGHT!

A new system of Carburetted heated Gas by means of a solid material, where-by its illuminating power is increased more than three-fold.

SUPERIOR TO ALL OTHER SYSTEMS FOR

Economy, Safety, Illuminating Power and General Practicability,

The Albo-Carbon process enables Gas Companies to supply a light equal to the Arc Light, at a much less cost. Several Gas Companies are now using this system. The process is extensively used in Europe, and is being rapidly adopted in this country.

The Albo-Carbon Light Co., - - Newark, N. J.

GENERAL AGENCIES:

1004 Walnut St., Philadelphia, Pa.

94 Fifth Avenue, Chicago, Ill.

522 Pine Street, St. Louis, Mo.

Law Buildings, Lexington Ave, Baltimore.

35 Federal Street, Allegheny, Pa.

120 S. Fourth Street, Minneapolis, Minn.

Parson's Steam Blower,

FOR IMPROVING BAD DRAUGHT IN BOILERS, AND FOR BURNING BREEZE OR OTHER WASTE MATERIAL.

PARSON'S TAR BURNER,

FOR UTILIZING COAL TAR AS FUEL.

PARSON'S AIR JET TUBE CLEANER,

FOR CLEANING BOILER TUBES.

These devices are all first-class. They will be sent to any responsible party for trial. No sale unless satisfactory. Manufactured by the WATERTOWN STEAM BLOWER COMPANY.

H. E. PARSON, Supt., 42 PINE ST., N. Y.

NATIONAL GAS LIGHT AND FUEL COMPANY,

Sole Owners and Licensees of the Springer Patent Cupola and Process for the U. S.,

Chicago.

Builders, Lessees, and Purchasers of

GAS WORKS

UNDER THE

Springer Cupola Gas Generating System.

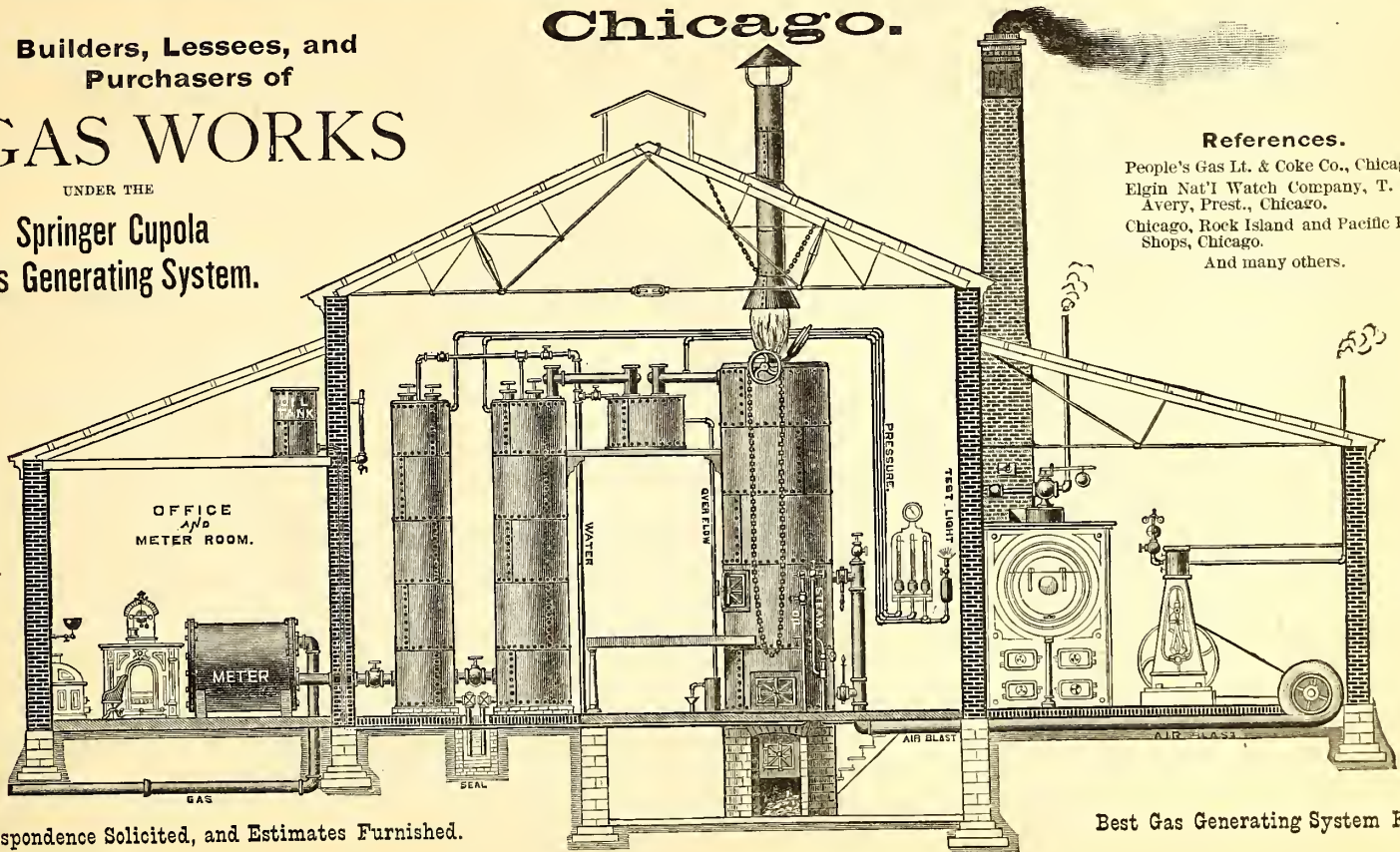

References.

People's Gas Lt. & Coke Co., Chicago.
 Elgin Nat'l Watch Company, T. M. Avery, Prest., Chicago.
 Chicago, Rock Island and Pacific Ry. Shops, Chicago.
 And many others.

Correspondence Solicited, and Estimates Furnished.

Best Gas Generating System Known.

Orders from Cities, Towns, and Public Institutions Promptly Executed. Address

NATIONAL GAS LIGHT AND FUEL COMPANY, - - - No. 162 Washington Street, Chicago, Ill.

BURDETT LOOMIS, HARTFORD, CONN.

Builder of Gas Works.

LOOMIS'S PATENT WATER GAS APPARATUS, FOR MAKING ILLUMINATING OR HEATING GAS FROM BITUMINOUS SLACK, ANTHRACITE COAL SCREENINGS, COKE, LIGNITE, OR WOOD.

More gas can be made with this apparatus, using **BITUMINOUS SLACK**, than by any other process using same amount of best quality Anthracite Coal, and with less oil. No clinker; no filling up of superheater with ashes, as they are separated from the coal in the process of blasting and easily removed. Plans and estimates furnished.

Taylor's AUTOMATIC GAS CHECK.

Pat. Sept., 1885. Just the thing for street lamps. No moving parts; only the gas moves, and checks itself by opposing currents; cannot get out of order or wear out; the cheapest and best of all governors. Samples, by mail, 10 cents. Send for circular.

G. TAYLOR, 60 Duane St., N. Y.

OFFICE 43 PARK PLACE WORKS 57-59 AND 61 LEWIS ST. 60, 62, 64 & 66 CANNON ST. NEW YORK

PROGRESS MACHINE WORKS.

A. & F. BROWN

Shafting, Pulleys, HANGERS.

F. Brown's Patent Friction Clutch.

Send for Illustrated Catalogue and Discount Sheet to

A. & F. BROWN,
No. 43 Park Place, New York City.

WELSH "ABERNANT"
 Silica Dinas Fire Brick & Cement.
 Unrivalled for Endurance Under Intense Heat. Percentage of Silica, 95.64.

Also SCOTCH "BLOCHAIRN" FIRE BRICK.

A. T. CHUR,

SOLE AGENT FOR THE UNITED STATES,
Mills Building, Room 14, Fifth Story, New York.

Pipe Coverings.

Fireproof, Non-Conducting Coverings for **STEAM PIPES, BOILERS,** And all Hot Surfaces.

Made in sections three feet long. Easy to apply; light and cheap. Asbestos Materials, Fibre, Braided Packing, and Cement. These goods are used at Continental Works, Br'klyn.

CHALMERS-SPENCE COMPANY, 419 & 421 EIGHTH ST., N. Y.

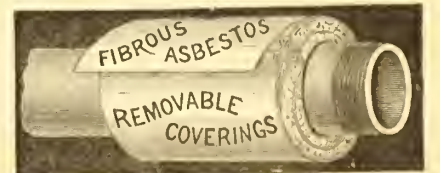

THE CLERK GAS ENGINE.

Highest Award American Institute, New York, 1883. Silver Medal American Institute, N. Y., 1884.
Gold Medal Awarded Crystal Palace Electrical Exhibition, London, 1882.
Highest Award for Motive Power British Section International Exhibition of Electricity, Paris, 1881.

Reliable.
No Boiler.
Steady.
No Coal.
Simple.
No Ashes.
Compact.

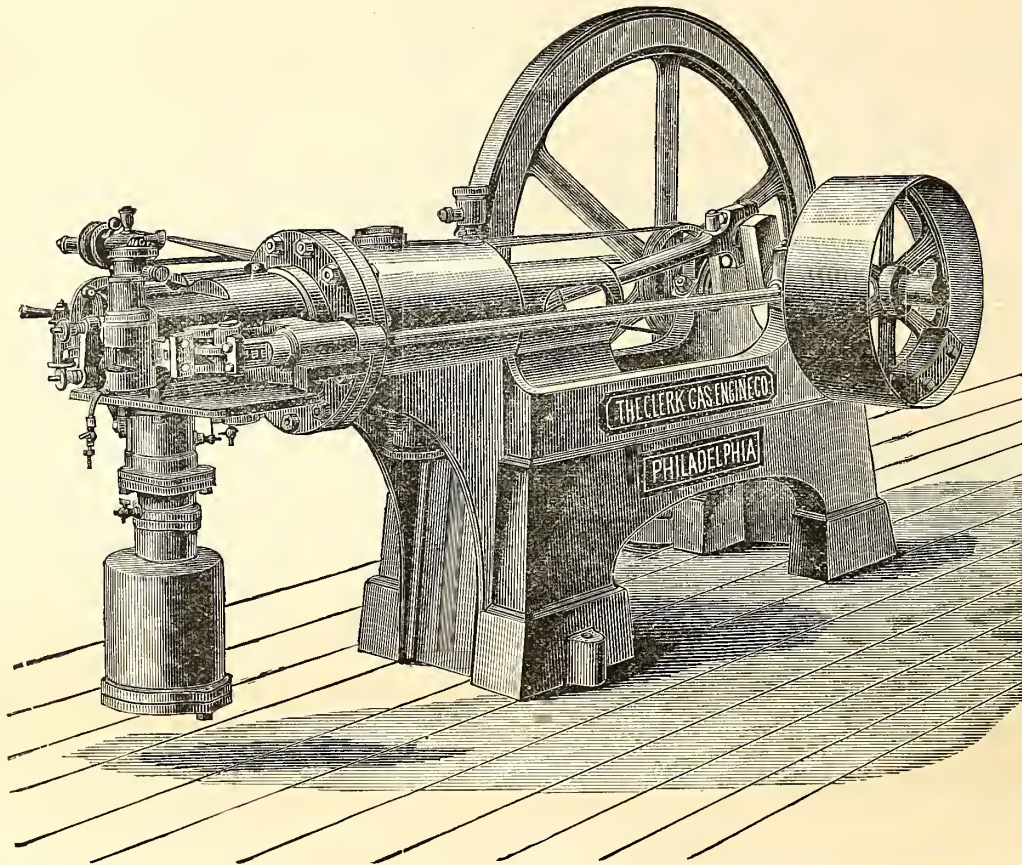

Economical.
No Engineer.
No Explosion
No Gearing
Wheels.
No Danger.
No Parts
requiring
frequent
renewal.

REQUIRING ONLY A MATCH TO START IT--GIVING ITS FULL POWER IMMEDIATELY.

We would inform the public that during the last few months we have improved THE CLERK GAS ENGINE to such an extent that we can now offer an engine vastly superior to our former pattern. These improvements have enabled us to sell our engine at a GREATLY REDUCED FIGURE, partly on account of the decreased weight (our engine weighing about half that of others giving the same Brake H. P). The consumption of gas has been decreased to a considerable extent, and the Brake H. P. has been increased some 25 to 30 per cent. All parts of the old design that were considered defective have been remodeled and new designs added. We now have an engine second to none as regards power, consumption, and ease of working. With our new engine all trouble in starting has been removed, the noise reduced to a minimum, and the regularity of motion is now all that can be desired. We guarantee all we claim for it, and the material and workmanship being of the best, enables us to guarantee the engine for twelve months.

SOLE MAKERS,

THE CLERK GAS ENGINE CO.,

WM. W. GOODWIN, President. E. STEIN, Secretary. S. LEWIS JONES, Asst. Secretary. L. P. GARRET, Supt.

Main Office, 1012-1018 Filbert Street, Philadelphia, Pa.

BRANCH OFFICES,

142 Chambers St., N. Y.

4 West Fourteenth St., N. Y.

76 Dearborn St., Chicago

General Agents,

THE GOODWIN GAS STOVE & METER CO.

Of Philadelphia, New York, and Chicago.

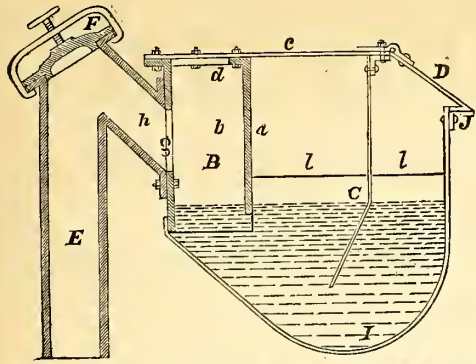

Boardman Hydraulic Main,

Patented October 7, 1884.

For description, see AM. GAS LIGHT JOURNAL of Feb. 2, 1884.
For terms, apply to

A. E. BOARDMAN, Macon, Ga.

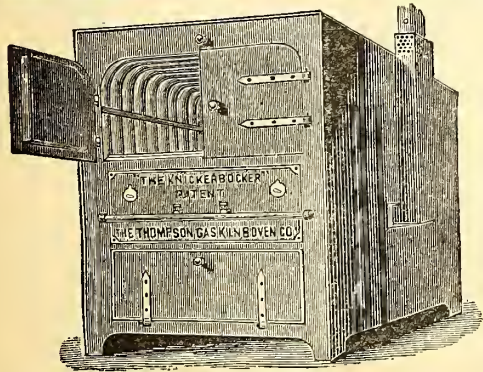

"The Knickerbocker" Portable Gas Oven,
ON EXHIBITION AT AMERICAN INSTITUTE FAIR.

Thompson Gas Kiln & Oven Co.
59 Carmine St., N. Y.

Send for Circular by mail.

MITCHELL, VANCE & CO.,

MANUFACTURERS OF

Chandeliers

and every description of

GAS FIXTURES.

Also manufacturers of Fine Gilt Bronzes and Marble Clocks,
warranted best time-keepers. Mantel Ornaments, etc.

Salesrooms, 836 Broadway, N. Y.

Special Designs furnished for Gas Fixtures for Churches, Public
Halls, Lodges, etc.

W. H. DOAN,

REFINER OF

NAPHTHA and GASOLINES

ALSO MANUFACTURER OF

A Special Grade of Naphtha for
Gas Companies

FOR ENRICHING COAL GAS.

Correspondence solicited.

No. 43 Euclid Avenue, Cleveland, Ohio.

**Iron Sponge,
GAS EXHAUSTERS,**

AUTOMATIC GAS GOVERNORS,

CONNELLY & CO., Limited,
No. 407 BROADWAY, NEW YORK CITY.

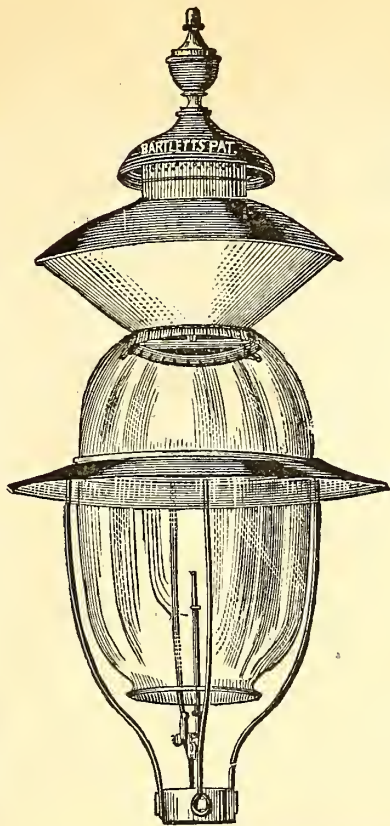

C. BARCALOW, PREST.

J. V. BARCALOW, SEC. & TREAS.

**BARTLETT
Street Lamp Mfg. Co.**

MANUFACTURERS OF

Bartlett's Patent

GLOBE LAMPS.

FOR

Streets, Parks, Railroad Stations, Public
Buildings, Etc.

LAMP POSTS A SPECIALTY.

Office and Salesroom,
No. 35 Howard Street, N. Y. City.

Gas Companies and others intending to erect lamps and posts
will do well to communicate with us.

F. M. ROOTS.

S. C. ROOTS

D. T. ROOTS.

P. H. & F. M. ROOTS,
PATENTEES AND MANUFACTURERS OF

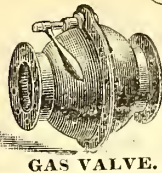

GAS VALVE.

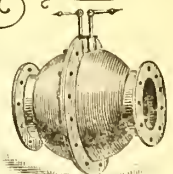
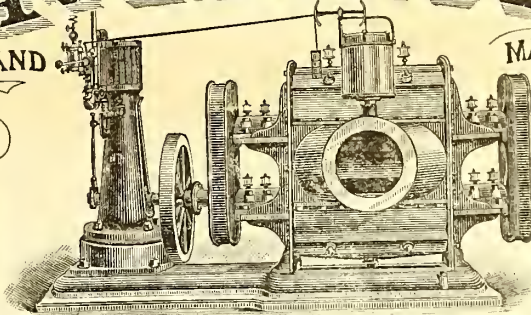

BYE-PASS.

IMPROVED GAS EXHAUSTER,

WITH ENGINE ON SAME BED PLATE, OR WITHOUT.

BYE-PASSES, GAS VALVES, GOVERNORS, ELBOWS, PIPE-FITTINGS, Etc., FURNISHED TO ORDER,

P. H. & F. M. ROOTS, Patentees & Manufacturers, **CONNERSVILLE, IND.**

S. S. TOWNSEND, General Agent, 22 Cortland St. and 9 Dey St., N. Y.

JAS. BEGGS & CO., Selling Agents, 9 Dey St., N. Y.

COOKE & CO., Selling Agents, 22 Cortland St., N. Y.

❖ SEND FOR ILLUSTRATED CATALOGUE AND PRICE LIST. ❖

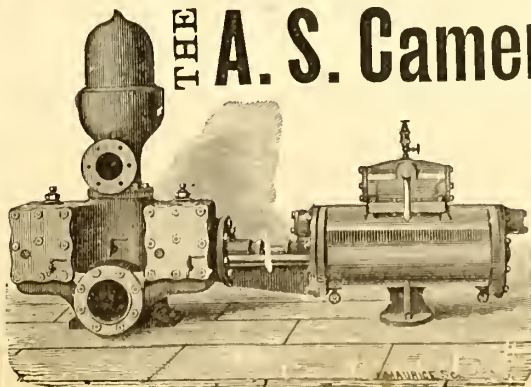

THE A. S. Cameron Steam Pump,

THE STANDARD OF EXCELLENCE.

Upward of 30,000 in Use.

BEST GAS WORKS PUMP
Ever Introduced.

Adapted to Every Possible Duty.

A. S. Cameron Steam Pump Works,
Foot East 23d St., N. Y.

J. H. GAUTIER & CO.,
CORNER OF
GREENE AND ESSEX STREETS,
JERSEY CITY, N. J.

MANUFACTURERS OF
**Clay Gas Retorts,
Gas House Tiles,
Fire Bricks, Etc. Etc.**
Ground Clay, Fire Brick and
Fire Sand in Barrels,

J. H. GAUTIER. T. B. GAUTIER.
C. E. GREGORY. C. E. GAUTIER.

BROOKLYN
Clay Retort & Fire Brick Works,
(EDWARD D. WHITE & CO.)
Manufacturers of Clay Retorts, Fire Brick,
Gas House and other Tile.
VAN DYKE, ELIZABETH, RICHARDS & PARTITION STS.
Office, 88 Van Dyke St., Brooklyn, N. Y.

LACLEDE FIRE BRICK MFG. CO.,
MANUFACTURERS OF
Fire Brick, Gas Retorts,

AND
ST. LOUIS STANDARD SEWER PIPE.
Blast Furnace and Cupola Linings, every description of Fire
Clay Material, Fire Clay Flue Linings, Chimney Tops
Dry Milled and Crude Fire Clays, etc.
OFFICE AND DEPOT
901, 903, and 905 Pine Street,
ST. LOUIS, MO.

ESTABLISHED IN 1845.

B. KREISCHER & SONS,
OFFICE FOOT OF HOUSTON ST., E.R., N. Y.

**Gas Retorts,
TILES, FIRE BRICK.**
AND EVERYTHING IN THE FIRE CLAY LINE.

MANHATTAN
FIRE BRICK & ENAMELLED CLAY
RETORT WORKS.
ADAM WEBER.

**CLAY GAS RETORTS
AND RETORT SETTINGS
FIRE BRICKS, TILES, ETC.,**
Office and Works, 15th Street and Avenue C., N. Y.



JAMES GARDNER, JR.
Works,
LOCKPORT STATION, PA.

—ESTABLISHED 1864.—
WILLIAM GARDNER & SON,
Successor to GARDNER BROTHERS.

WILLIAM GARDNER.
Office, COAL EXCHANGE,
PITTSBURGH, PA., P. O. Box 373.

Fire Clay Goods for Gas Works.

C. H. SPRAGUE, No. 70 KILBY STREET, BOSTON, MASS., Agent for the New England States.

OFFICE, 418 to 422 East 23d St., New York.

ESTABLISHED 1856.

WORKS, PERTH AMBOY, NEW JERSEY.

HENRY MAURER,
Excelsior Fire Brick & Clay Retort Works
CLAY GAS RETORTS, BENCH SETTINGS, FIRE BRICK, TILES, ETC.

STANDARD GAS RETORT AND FIRE BRICK COMPANY,
J. ANDERSON, PRES. & MANG'R. OF IRONTON, OHIO. C. PETERS, SECRETARY.
Clay Gas Retorts, Fire Brick, and Fire Clay Goods of Every Description.
Plans of Livesey-Somerville, McIlhenny, and other Furnaces, and Competent Workmen Supplied.

CHICAGO
Retort & Fire Brick Works,
OFFICE AND FACTORY,
Clark, Forty-Fifth, and La Salle Streets,
CHICAGO, ILL.
GEORGE C. HICKS, PRES. PAUL P. AUSTIN, SEC. & TREAS.
STANDARD
Clay Retorts and Settings.
BLOCKS & TILES
of every Shape and Size to Order.
Standard Fire Bricks.

NEWBIGGING'S
Gas Manager's Handbook.
Price, \$4.80.
EVERY GAS MAN SHOULD HAVE ONE.
Orders may be sent to this Office.

OAKHILL
GAS RETORT & FIRE BRICK
COMPANY.
PARKER, RUSSELL & CO.
City Office, 711 Pine Street,
ST. LOUIS, MO.

Our immense establishment is now employed almost entirely in
the manufacture of
MATERIALS FOR GAS COMPANIES.
We have studied and perfected three important points. Our re-
torts are made to stand changes of temperature, the strongest
heats of the furnace, and the abrasion of feeding and emptying.
Our customers are in almost every State of the Union, to all of
whom we refer.

THOS. SMITH, Prest. AUGUST LAMBLA, Vice-Prest. & Sup
BALTIMORE
RETORT & FIRE BRICK CO.
MANUFACTORY AT
LOCUST POINT, BALTIMORE, MD.
Connection with the City by Telephone.
**Clay Retorts, Blocks & Tiles,
FIRE BRICK, FIRE CLAY,
AND FIRE CEMENT.**

Red and Buff Ornamental Tiles and Chim-
ney Tops. Drain and Sewer Pipe (from
2 to 30 inches). Baker Oven Tiles
12 x 12 x 2 and 10 x 10 x 2.
WALDO BROS., 88 WATER ST., BOSTON, MASS
Sole Agents for New England States

THE AMERICAN METER CO.,

MANUFACTORIES,

508 to 514 West Twenty-second St., N. Y. Arch and Twenty-second St., Phila.
Nos. 244 & 246 North Wells Street, Chicago, Ill.

AGENCIES,

No. 177 Elm Street, Cincinnati, Ohio. Nos. 122 & 124 Sutter Street, San Francisco, Cal.
No. 810 North Second Street, St. Louis, Mo.

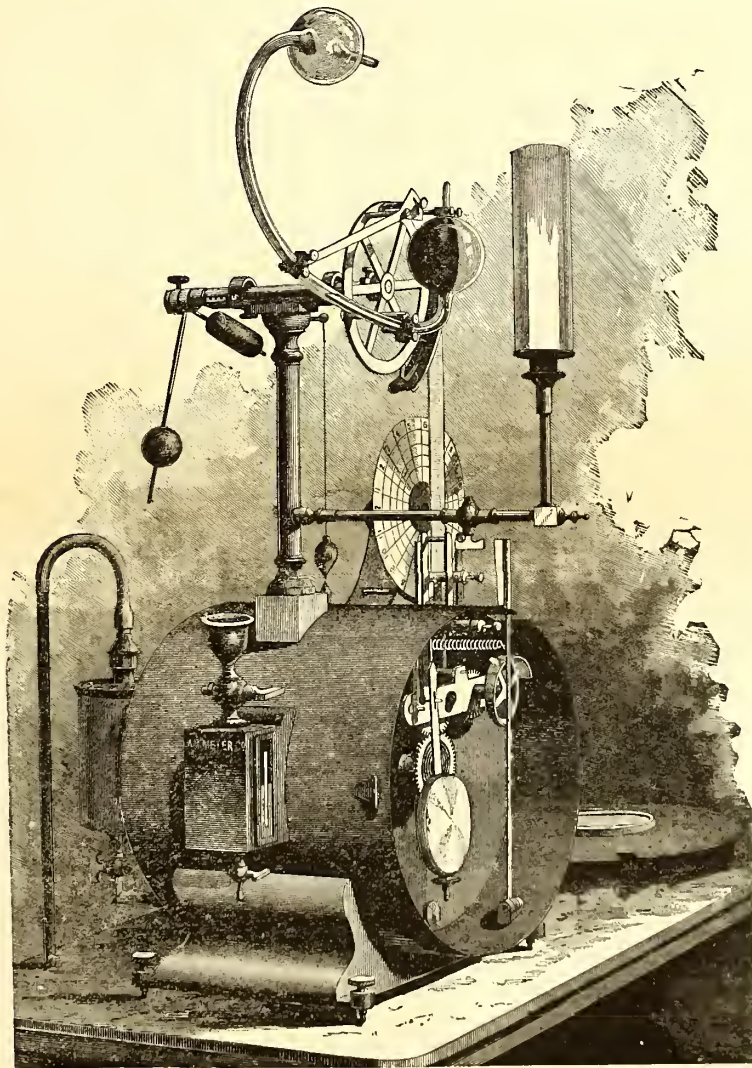

CONSOLIDATED GAS COMPANY, ENGINEER'S OFFICE, }
21st St., Cor. AVE. A., NEW YORK, SEPT. 21, 1885. }

DR. T. O'CONNOR SLOANE:—Your Thermophote has been in use at our Twenty-first Street Station for over three months, and gives good satisfaction. It requires very little attention, and, being free from complications, is not liable to get out of order. The candle power registered by it comes reasonably near to that obtained on our bar photometer, taken daily from the same supply. It is a great advantage to be able to ascertain our candle power every fifteen minutes day and night, instead of depending upon a single observation as we did before.

A. P. HALLOCK, Ph.D. Chemist of the Consolidated Gas Company.

It may be at once conceded that the means by which Dr. Sloane has sought to make practical use of this relationship, as well as the general arrangements of his apparatus, are ingenious in the extreme.—*London Journal of Gas Lighting*, July 21, 1885.

A. H. M'NEAL,

BURLINGTON, N. J.

Flange-Pipes

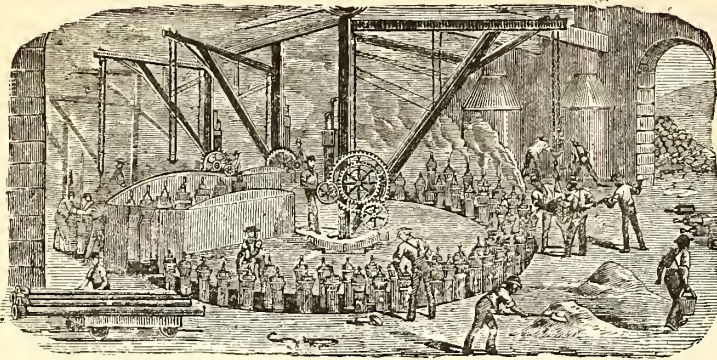

General Foundry Work.

CAST IRON PIPES FOR WATER AND GAS.

JAMES S. MOORE, Pres.
BENJAMIN CHEW, Treas.

JAS. P. MICHELLON, Sec.
WM. SEXTON, Supt.

GLOUCESTER IRON WORKS, GLOUCESTER CITY, N. J.

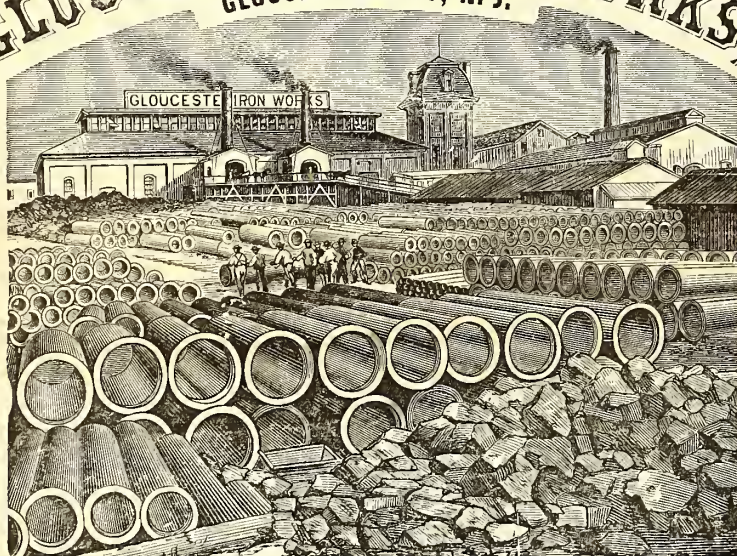

Cast Iron Gas & Water Pipes, Stop Valves, Fire Hydrants, Gasholders, &c.
Office No. 6 North Seventh Street, Philadelphia.

ESTABLISHED 1856.

WARREN FOUNDRY AND MACHINE CO.,

WORKS AT PHILLIPSBURGH, N. J.
NEW YORK OFFICE, 162 BROADWAY.

Cast Iron Water and Gas Pipe

FROM TWO TO FORTY-EIGHT INCHES DIAMETER.
ALSO ALL SIZES OF

FLANGE PIPE for Sugar House and Mine Work.
Branches, Bends, Retorts, Etc., Etc.

436-1

MATTHEW ADDY, President.

W. L. DAVIS, Selling Agent.

GEO. P. WILSHIRE, Sec. & Treas.

Cincinnati and Newport Iron and Pipe Company, NEWPORT, KY.

Lamp Posts
AND
BENCH CASTINGS

A Specialty.



Large & Heavy Castings for General Work.

Manufacture Pipe from 2 to 48 inches. All work guaranteed first quality.

Branch
AND
SPECIAL CASTINGS
FOR GAS & WATER CO'S.

Hydraulic Main Dip Regulators, also
Check Valves, Foot Valves, Yard-
wash and Fire Hydrants.
Send for Circulars.

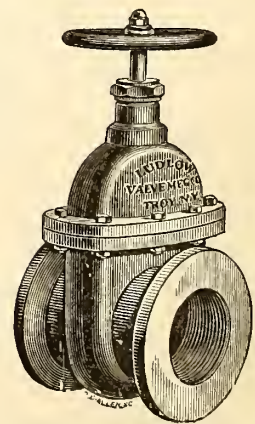

Valves.—Double and Single Gate, 1/2 in. to
48 in., outside and inside Screws. Indica-
tor, etc., for Gas, Water, Steam, and Oil.
and for Circulars.

Mellert Foundry and Machine Co. Limited.



Specials—Flange Pipe, Valves and Hydrants,
Lamp Posts, Retorts, etc.
Machinery and castings for Furnaces, Rolling Mills, Grist and
Saw Mills, Mining Pumps, Hoists, etc.
GENERAL OFFICE, - - - READING, PA.

CAST IRON

Gas and Water Pipes,

From 2 to 48 Inches in Diameter.

FOX & DRUMMOND,

160 Broadway, N. Y. City.

THE OHIO PIPE COMPANY,

MANUFACTURERS OF

Cast Iron Gas & Water Pipe, BRANCH AND SPECIAL CASTINGS.

Gas-House Bench Castings, Hydraulics, Lamp Posts, Flange Pipe
and Specials, Architectural Castings, Building Columns,
Joists, Collar Grates, Sash Weights, etc.

GENERAL FOUNDERS AND MACHINISTS.

Columbus, Ohio.

LUDLOW VALVE MFG. CO.

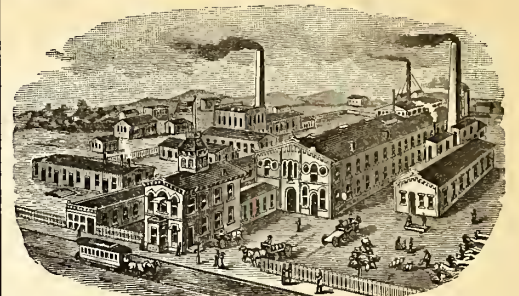

OFFICE AND WORKS,

938 to 954 River Street and 67 to 83 Vail Av.
TROY, N. Y.

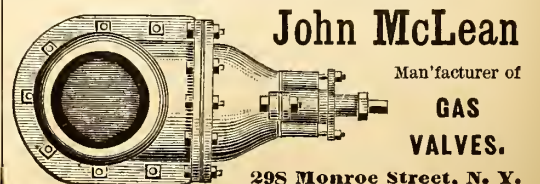

John McLean

Manufacturer of

**GAS
VALVES.**

298 Monroe Street, N. Y.

Siemens's Regenerative Gas Burners, For Lighting and Ventilating.

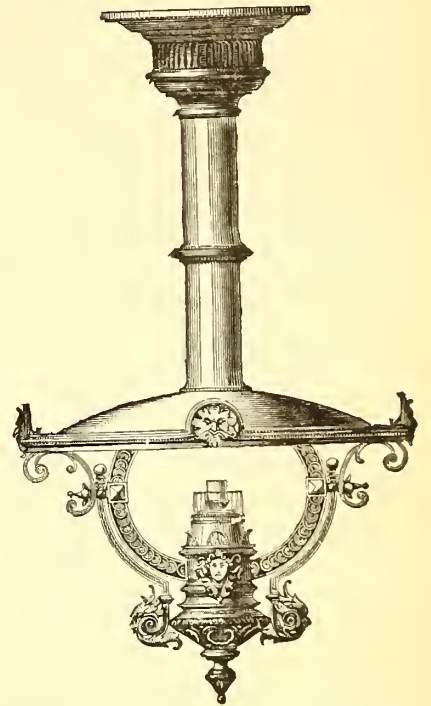
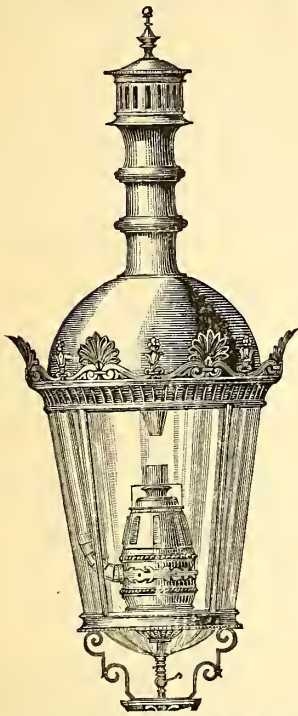

THE CHEAPEST, PUREST, AND MOST BRILLIANT OF ALL GAS LIGHTS.

Superior to the Electric Light in Economy, Beauty, & Steadiness.

SPECIALLY ADAPTED FOR LIGHTING HALLS, FACTORIES, OPEN SPACES, ETC.

Numerous Tests made by various Gas Companies in the United States show an Efficiency of Ten Candle Power per Cubic Foot of Gas.

General Agents:

- SIEMENS LIGHTING CO., 347 West Main St., Louisville, Ky.
- MEYER, MARSHALL & CO., 528 California St., San Francisco.
- DENNEHY, WOLF & O'BRIEN, 85 & 87 Dearborn St. Chicago, Ill.
- WILCOX & McGEARY, - No. 11 Bissel Block, Pittsburgh, Pa.
- T. T. RAMSDALL & CO., - 20 Swan Street, Buffalo, N. Y.
- SIEMENS GAS ILLUMINATING CO.,
Room 6, No. 157 Broadway, New York City.
- W. D. COLT, - - - - 1420 F Street, Washington, D. C.
- JOHN KIEFER, - - - 344 Lawrence, Street, Denver, Col.

THE SIEMENS REGENERATIVE GAS LAMP COMPANY,

SOLE MAKERS FOR THE UNITED STATES,

N. E. Cor. 21st. St. and Washington Av., Philadelphia, Pa.

THE "STANDARD" WASHER-SCRUBBER,

KIRKHAM, HULETT & CHANDLER'S PATENT.

Total Capacity per 24 Hours of "Standard" Washers Ordered During the Following Years.

1877.....	4,000,000 cubic feet.
1878.....	4,750,000 "
1879.....	24,545,000 "
1880.....	42,967,500 "
1881.....	36,462,500 "
1882.....	39,300,000 "
1883.....	57,735,000 "
1884.....	26,177,500 "
Total.....	235,937,500 cubic feet.

Total Number and Capacity per 24 Hours of "Standard" Washers Erected and in Course of Erection in the Several Countries

	Number.	Cubic Feet per Day.
Great Britain..	151	157,070,000
Western Hemisphere.....	38	39,337,500
Australia.....	18	12,150,000
New Zealand.....	2	650,000
France.....	6	4,550,000
Belgium.....	8	5,420,000
Germany.....	16	8,200,000
Holland.....	4	4,160,000
Denmark.....	1	150,000
Russia.....	2	3,500,000
Spain.....	1	350,000
India.....	1	400,000
Total.....	248	235,937,500

**THE CONTINUED POPULARITY
Of these Machines**

Will be recognized from the following extracts from letters from representatives of some of the companies having them in use:

PROVIDENCE GAS COMPANY. }
PROVIDENCE, R. I., Nov. 24, 1884. }
GEO. SHEPARD PAGE, Esq., New York:

Dear Sir—We are now using less than a gallon of water per thousand in the "Standard," and the gas at the outlet will not color turmeric paper.

Yours, etc.,
A. B. SLATER, Treasurer.

PORTLAND GAS COMPANY. }
PORTLAND, ORE., Nov. 29, 1884. }
GEO. SHEPARD PAGE, New York:

Dear Sir—Our Scrubber appears to run to our entire satisfaction, and we are pleased to say that it takes out all the ammonia from the gas. This is very satisfactory to us, as we were ruining our meters at a fearful rate heretofore. The amount of water used is very inconsiderable as compared with our old process. The machine runs very smooth and still.

Very respectfully,
H. C. LEONARD, Secretary.

"Standard" Washers Ordered Recently.

	Cu. Ft. per Day
Anneberg Gas Co.....	200,000
Bombay Gas Co.....	400,000
Brussels Co.....	1,250,000
CHICAGO, two, 1,000,000 each.....	2,000,000
Chemnitz Gas Co.....	1,000,000
CITIZENS GAS CO., BUFFALO.....	750,000
Coke Works in Zabre, Ober-Schlesien.....	1,500,000
Cokerel der Friedenshutte, Upper Silesia.....	500,000
Dumfries Corporation.....	250,000
Dunedin Gas Co., New Zealand.....	400,000
GEORGETOWN, D. C.....	250,000
King's Lynn Gas Co.....	300,000
Leliden, Holland.....	600,000
Lincoln Gas Co.....	400,000
Liverpool Gas Co.....	2,000,000
".....	3,000,000
LOUISVILLE GAS CO.....	1,500,000
Numea Gas Co.....	100,000
PITTSBURGH GAS CO.....	1,500,000
PAWTUCKET, R. I.....	500,000
PORTLAND GAS CO., Oregon.....	562,500
SAN FRANCISCO GAS CO.....	4,000,000
Sheepbridge.....	40,000
ST. LOUIS GAS CO.....	2,000,000
Sydney Gas Co.....	2,500,000
WASHINGTON, D. C. GAS CO.....	2,000,000
Whitechurch Gas Co.....	175,000
Total.....	29,677,500

GEO. SHEPARD PAGE, No. 69 WALL STREET, NEW YORK,
SOLE AGENT FOR THE WESTERN HEMISPHERE.

R. D. WOOD & CO.,

400 Chestnut Street, Phila., Pa.

Cast Iron Gas & Water Pipe, Water Machinery & Gas Apparatus

Cast Iron Pipe, Fire Hydrants, Eddy Valves, Lamp Posts, Large Loam Castings, Flanged Pipe, Sugar House Work, Iron Roofs and Floors, Wrought & Cast Iron Tanks, Turbine Water Wheels and Pumps.

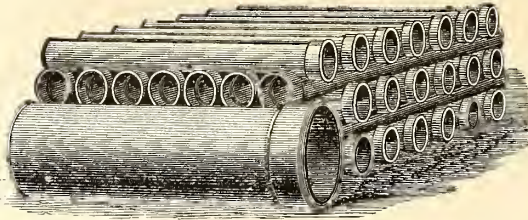

Gasholders, Lime Trays, Center Valves, Purifiers, Bench Work, Exhausters, Condensers, Governors, Scrubbers, Gas Valves, Station Meters, Cast Iron Pipe Fittings.

Manufacturers of Heavy Castings and Machinery of Every Description.

ENGINEERS & CONTRACTORS FOR THE ERECTION OF GAS WORKS, & ALL MACHINERY CONNECTED THEREWITH

Estimates and specifications furnished for erection of new works or the extension or alteration of old ones.

Foundries and Works. - - Millville, Florence, and Camden, N. J.

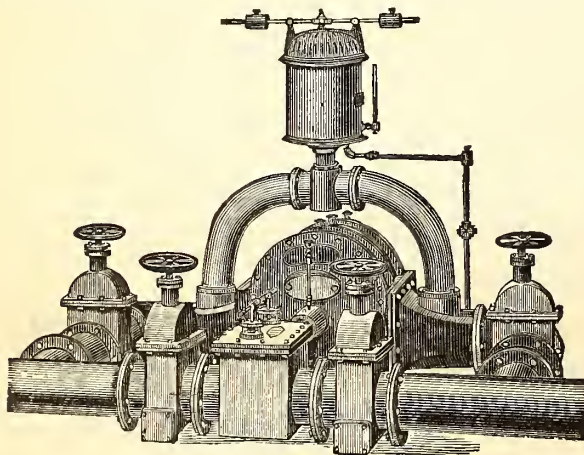

SMITH & SAYRE MFG. COMPANY,

G. G. PORTER, Prest. 245 Broadway, N. Y. CHAS. W. ISBELL, Sec'y.

Machinery & Apparatus for Gas Works

Drawings, Plans, and Estimates Furnished for the Improvement, Extension, or Alteration of Gas Works, or for the Construction of New Works.

Mackenzie's Patent Rotary and Steam Jet Gas Exhausters, Governors, Compensators, Condensers, Washers, Scrubbers. Isbell's Patent Automatic Street Pressure Governor, Gas and Water Valves, Hydraulic Main Dip Regulator, Bench Castings, etc. Purifying Boxes and "Standard" Scrubbers. Isbell's Patent Self-Sealing Retort Doors.

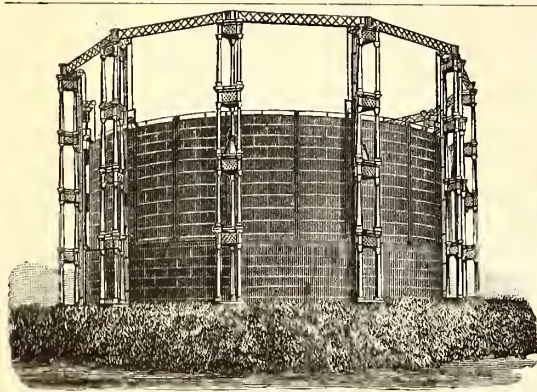

W. E. Tanner, Pres., W. R. Trigg, V.-Pres., A. Delaney, Supt.

Tanner & Delaney Engine Co.

RICHMOND, VA.

Gas Apparatus,

INCLUDING

Condensers of various styles, Scrubbers, Holders, Purifiers, Castings for Retort Houses, Etc.

ALSO STEAM ENGINES AND BOILERS.

Plans, Specifications and Estimates Furnished.

SOUTHWARK FOUNDRY AND MACHINE COMPANY,

Successors to MERRICK & SONS. Established in 1836.

No. 430 Washington Avenue, Philadelphia, Pa.

MANUFACTURERS OF

Single and Telescopic Gasholders,

BENCH CASTINGS,

Washers, Scrubbers, Condensers, Purifiers,

And all apparatus necessary for the construction of improved new gas works and in the extension of established works. Also manufacturers of

Gas Engines, and of all descriptions of Steam and Hydraulic Machinery, and of Boiler and Tank Work.

Plans, specifications, and estimates furnished promptly on application.

MORRIS, TASKER & CO.,

Limited,

Builders of Gas Works,

PHILADELPHIA, PA.

To Gas Companies.

We make to order CAP BURNERS to burn any amount under a stated pressure. Send for samples.

Also, SERVICE CLEANERS, DRIP PUMPS, and STREET MAIN PROVING APPARATUS.

C. A. GEFRORER,

248 N. 8th Street, Phila., Pa.

W.M. HENRY WHITE,

Consulting & Constructing

Gas Engineer & Contractor.

ESTIMATES, PLANS, AND SPECIFICATIONS FURNISHED FOR NEW WORKS OR EXTENSIONS OF

EXISTING WORKS.

32 Pine St., New York City.

Correspondence solicited.

KERR MURRAY MFG. CO.,
 MANUFACTURERS OF
Single Lift and Telescopic
GASHOLDERS.

Built, 1884:

Altoona, Pa.....	Capacity, 160,000 cubic feet.
Pittsburgh, Pa.....	250,000 "
" ".....	220,000 "
Bellaire, Ohio.....	50,000 "
Youngstown, Ohio.....	60,000 "
Canton, ".....	60,000 "
Akron, ".....	80,000 "
Xenia, ".....	10,000 "
Adrian, Mich.....	65,000 "
Ypsilanti, Mich.....	25,000 "
Muskegon, ".....	70,000 "
South Bend, Ind.....	70,000 "
Anderson, ".....	20,000 "
Plainfield, ".....	10,000 "
Springfield, Illinois.....	100,000 "
Evanston, ".....	50,000 "
Freeport, ".....	35,000 "
Elgin, ".....	60,000 "
Sheboygan Wis.....	20,000 "
Key West Fla.....	10,000 "

Plans and estimates furnished for the erection of new and the rebuilding of old works. Address

Kerr Murray Mfg. Co.,
FORT WAYNE, IND.

JAMES R. FLOYD,
 (SUCCESSOR TO HERRING & FLOYD)

Oregon Iron Works,
 531 to 543 West 20th St., N. Y.
Practical Builders of Gas Works,
 MANUFACTURERS OF
ALL KINDS OF CASTINGS
 AND
APPARATUS FOR GAS-WORKS.

BENCH CASTINGS
 from benches of one to six Retorts each.
WASHERS: MULTITUBULAR AND
AIR CONDENSERS; CONDENSERS; SCRUBBERS

wet and dry), and
EXHAUSTERS
 for relieving Retorts from pressure.
BENDS and BRANCHES
 of all sizes and description.

FLOYD'S PATENT
MALLEABLE RETORT LID.

PATENT
SELF-SEALING RETORT LIDS.

FARMER'S
PATENT BYE-PASS DIP-PIPE.

SABBATON'S PATENT
FURNACE DOOR AND FRAME.

BUTLER'S
COKE SCREENING SHOVELS.

GAS GOVERNORS,

and everything connected with well regulated Gas Works at low price, and in complete order.

SELLER'S CEMENT

for stopping leaks in Retorts.

N. B.—STOP VALVES from three to thirty inches—
 at very low prices.

Plans, Specifications, and Estimates furnished.

CONTINENTAL WORKS.

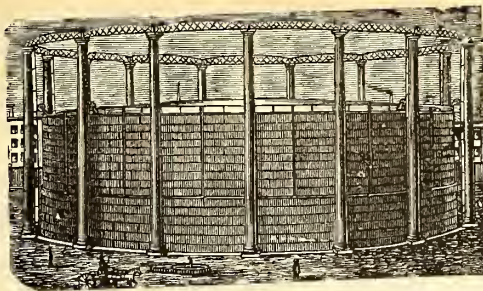

GASHOLDERS OF ANY MAGNITUDE.

T. F. ROWLAND, Proprietor,
GREENPOINT, BROOKLYN, N. Y.
 ENGINEER AND MANUFACTURER OF
GAS-HOLDERS.
CONDENSERS, SCRUBBERS, VALVES,
PURIFIERS, RETORTS, and HY-
DRAUIC MAINS,

and all other articles connected with the Manufacture and Distribution of Gas. Plans and Specifications prepared and Proposals given for the necessary Plant for Lighting Cities, Towns, Mansions, and Manfactories.

H. RANSHAW, Prest. & Mangt. WM. STACEY, Vice-Pres. T. H. BIRCH, Asst. Mangt. R. J. TARVIN, Sec. & Treas.

STACEY MFG. CO.,

MANUFACTURERS OF

Single and Telescopic Gasholders,

IRON ROOFS, BRIDGES, LAMP POSTS,

Water and Oil Tanks, Coal Elevator Cars,

COKE CRUSHERS, BENCH CASTINGS,

And all kinds of Wrought and Cast Iron Work used in the erection of Coal and Oil Gas Works. Rolling Mill Machinery and Heavy Castings a Specialty.

Foundry: 33, 35, 37 & 39 Mill Street. **Wrought Iron Works:** 16, 18, 20, 22, 24 & 26 Ramsey Street.

Cincinnati, Ohio.

BARTLETT, HAYWARD & CO.,

Office, 24 Light.

BALTIMORE, MD.

Works, Pratt &

PURIFIERS.
 Roofs.
 Bench Castings.

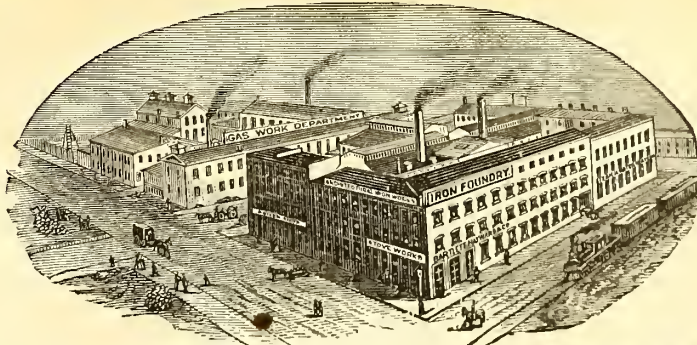

CONDENSERS
 BOILERS.
SCRUBBERS.

GASHOLDERS.

CONSTRUCTING ENGINEERS AND BUILDERS OF GAS WORKS.

1842. **DEILY & FOWLER, 1885.**

Laurel Iron Works.

Address, No. 39 Laurel Street, Philadelphia, Pa.

MANUFACTURERS OF

GASHOLDERS,

Single or Telescopic, with Cast or Wrought Iron Guide Frames.

Holders Built Since 1880:

- | | | | | |
|--------------------------|-----------------------|---------------------------|---------------------------|-------------------------|
| Mount Joy, Pa. | West Point, N. Y. | Galveston, Texas (2d.) | Kalamazoo, Mich. (3d.) | Newport, R. I. |
| Rockaway B'ch, N.Y. (2) | Fitchburgh, Mass. | Marlboro, Mass. | Glen Island, N. Y. | Portland, Oregon. |
| Zanesville, O. (2d.) | New London, Conn. | Denver, Col. | Warren, Ohio. | Allegheny, Pa. (2d.) |
| Lancaster, O. | Derby, Conn. | Chicago, Ill. (West Side) | Bath, N. Y. | Atlanta, Ga. (2d.) |
| Blackwell's Island N. Y. | Bridgeport, Conn. | Pittsburgh, Pa. (S. Side) | Lynn, Mass. | N.Y. City (Central Ga.) |
| Waltham, Mass., (1st.) | Allegheny, Pa. (1st.) | Pawtucket, R. I. | New Bedford, Mass. | Lynchburg, Va. (2d.) |
| Dorchester, Mass. | St. Hyacinth, Can. | Brookline, Mass. | Waterbury, Conn. | Saylesville, R. I. |
| Wheeling, West Va. | Norwalk, O. | Sherbrooke, Can. | Deseronto, Can. | Rondout, N. Y. |
| Lansing, Mich. | Brattleboro, V | Burlington, N. J. (2d.) | Hoosic Falls, N. Y. (2d.) | Atlantic City, N. J. |
| Flint, Mich. | Waltham, Mas (2d.) | Bridgeton, N. J. | Hochelam, Pa. | Augusta, Ga. |
| Galveston, Texas (1st.) | West Chester, Pa. | Bay City, Mich. | Atlanta, Ga. (1st.) | Waltham, Mass. (2) |
| Milton, Pa. | Baltimore, Md. | Erie, Pa. | Savannah, Ga. | |
| Scranton, Pa. | Hollidaysburg, Pa. | Jackson, Mich. | Montgomery, Ala | |

GAS COALS.

GAS COALS.

GAS COALS.

JAMES D. PERKINS.

PERKINS & CO.,

F. SEAVERN.

General Sales Agents for

The Youghioghenny River Coal Company's

OCEAN MINE YOUGHIOGHENY GAS COAL.

The Coal from the Ocean Mine (recently operated by Messrs. W. L. Scott & Co., of Erie, Pa.,) is now used by all the leading Gas Companies in the United States from Maine to Texas, and is recognized as *the only reliable Youghioghenny Gas Coal.* (See Map on p. 87 of this Journal, Feb. 16, 1885.)

P. O. Box 3695,
New York.

PERKINS & CO., 228 and 229 N. Y. Produce Exchange

**BEAVER STREET
ENTRANCE.**

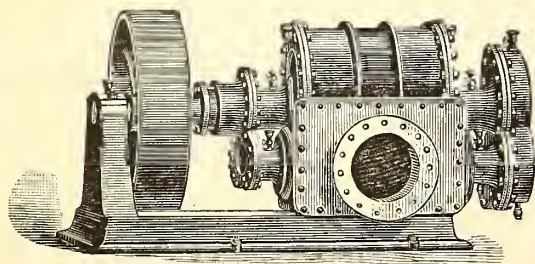

Gas Exhauster Driven by Belt.

The Wilbraham Gas Exhauster,

"BAKER SYSTEM,"

WITH ENGINE ATTACHED, ON SAME BED PLATE OR WITHOUT.

Best, Cheapest and Most Durable Exhauster known.

WILBRAHAM BROS.,

No. 2320 Frankford Avenue, Philadelphia, Pa.

F. J. DAVIS & J. R. FARNUM,

TRUSTEES AND AGENTS FOR THE

SINUOUS FRICTION CONDENSER.

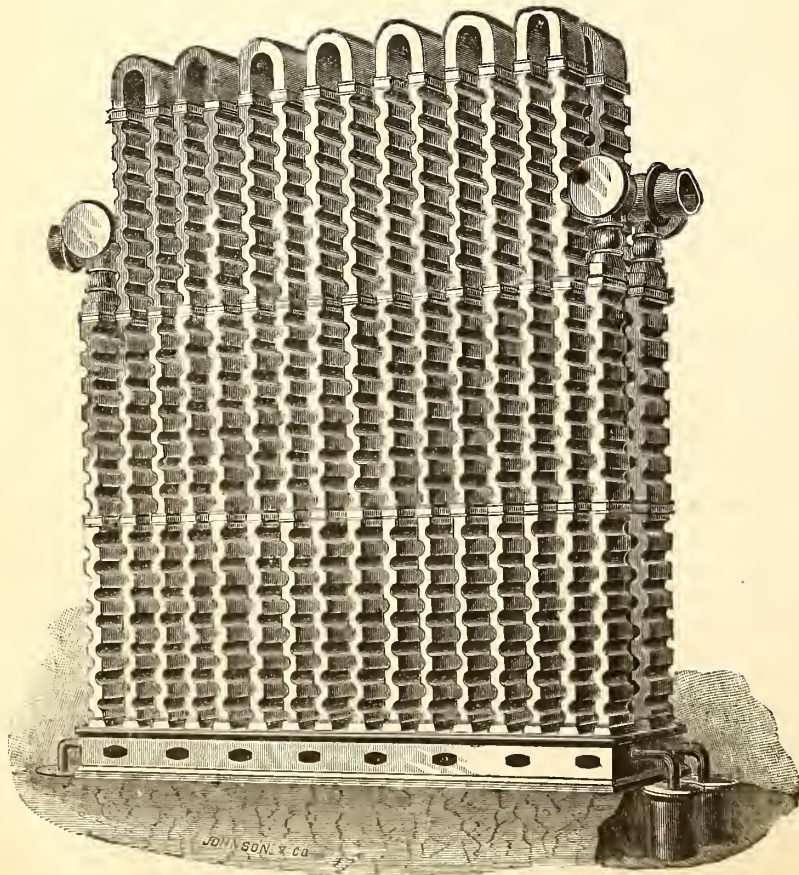

We desire to draw the attention of the gas community to the merits of the SINUOUS FRICTION CONDENSER. Companies intending to introduce new condensers into their works will do well to confer with us and examine plans and estimates before contracting for any other pattern. The FRICTION CONDENSER is now in use at the gas works located in the following places:

- | | | | |
|--------------------------------|------------------|-------------------------------|---------------------|
| Portland, Me. | Brookline, Mass. | Pawtucket, R. I. | Frederickton, N. B. |
| Newport, R. I. | Chelsea, Mass. | Jamaica Plain, Mass. | St. John, N. B. |
| Gloucester, Mass. | Woburn, Mass. | Attleboro, Mass. | Paterson, N. J. |
| Newton & Water-
town, Mass. | Peoria, Ill. | Calais, Me. | Dover, N. H. |
| | Clinton, Mass. | Fall River, Mass. | Waltham, Mass. |
| | | Nassau Works, Brooklyn, N. Y. | |

DAVIS & FARNUM MFG. CO.

MANUFACTURERS OF

Gas and Water Pipes,

AND

GAS AND WATER MACHINERY

OF THE MOST APPROVED PATTERN.

Also, Gasholders and Iron Roofing.

Orders from Gas and Water Companies promptly attended to.

WALTHAM, MASS.

Boston Office, Room 55, Mason Building; 70 Kilby Street.

GAS COALS.

GAS COALS.

GAS COALS,

Newburgh Orrel Coal Co.,

MINERS AND SHIPPERS OF

**Newburgh Orrel, Tyrconnell
and Palatine Gas Coals.**

ALSO SHIPPERS OF FOUNDRY COKE.

Mines Situated at

Newburgh, Flemington & Fairmont, W.Va.

HOME OFFICE,

25 S. Gay St., Baltimore.

**CHARLES MACKALL,
MANAGER.**

CHAS. W. HAYS, Agent in New York,

Room 92, WASHINGTON BUILDING, No. 1 Broadway.

Shipping wharves at Locust Point. References furnished when required. Special attention given to chartering vessels.

THE DESPARD COAL COMPANY

OFFER THEIR SUPERIOR

DESPARD COAL

To Gas Light Companies and Manufacturers of Fire Clay Goods
Throughout the Country.

ROUSSEL & HICKS, } AGENTS. { BANGS & HORTON,
71 Broadway, N. Y. } 16 Kilby St., Boston.

Mines in Harrison Co., West Va. Wharves, Locust Point, Balt.
Company's Office, 15 German St., Baltimore, Md.

Among the consumers of Despard Coal we name: Manhattan
Gas Light Co., N. Y.; Metropolitan Gas Light Co., N. Y.; Jersey
City, (N. J.) Gas Light Co.; Washington (D. C.) Gas Light Co.;
Portland (Maine) Gas Light Co. Reference to them is requested.

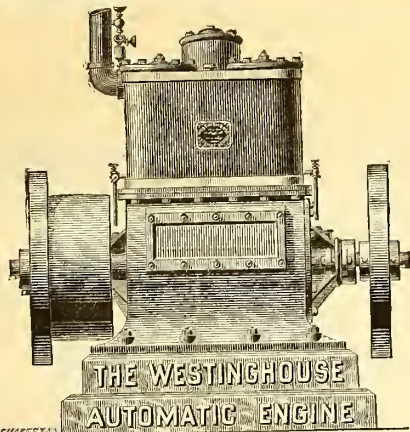

Record.

Eleven months continuous run without a stop.
No repairs found necessary after this run.
3.2 lbs. coal and 27.8 lbs. water (actual) per H.P. per hour
with 80 H.P.
Nearly 1,500 Engines and over 40,000 H.P. running.
1,500 to 2,500 H.P. average monthly sales.
22 per cent. of total sales are repeated orders.
10 to 16 engines (25 to 200 H.P. each) to single cus-
tomers.
Have displaced several hundred engines of
other makes. Send for Illustrated Circular, and state your
Business and Requirements.

**Westinghouse Machine Co.,
PITTSBURCH, PA.**

SALES DEPARTMENT CONDUCTED BY

Westinghouse, Church, Kerr & Co., 17 Cortlandt
Street, New York City.

Fairbanks, Morse & Co., Chicago, Cincinnati, Cleve-
land, Louisville, and St. Paul.

Fairbanks & Co., St. Louis, Indianapolis, and Denver.
Parke & Lacy, San Francisco, and Portland, Or.

Parke, Lacy & Co., Salt Lake City, Utah, and Butte,
Montana.

D. A. Tompkins & Co., Charlotte, N. C.
Keating Implement & Machine Co., Dallas, Texas

Robert Middleton, Mobile, Ala.

H. Dudley Coleman, New Orleans, La.

Inray & Co., Sydney and Melbourne, Australia.

H. Rogers, 43 Rue Laflitte, Paris.

F. E. Averill, Delft, Holland.

Tomas G. Foley & Co., Buenos Ayres, S. A.

**THE
PENN GAS COAL CO.**

OFFER THEIR

Coal, Carefully Screened & Prepared for Gas Purposes.

Their Property is located in the Youghiogheny Coal Basin, near Irwin and Penn Stations on the
Pennsylvania Railroad, and on the Youghiogheny River.

Principal Office:

209 SOUTH THIRD STREET, PHILA., PA.

Points of Shipment:

Pennsylvania Railroad Piers; Greenwich Wharves, Delaware
River; Pier No. 1 (Lower Side), South Amboy, N. J.

Chesapeake & Ohio Railway Coal Agency,

FOR THE SALE OF THE

**Superior Kanawha Gas Coals, Cannelton Cannel,
Also, SPLINT AND STEAM COALS.**

From the Kanawha and New River Regions, on the line of the Chesapeake & Ohio R'way.

C. B. ORCUTT, Sales Agent. | OFFICE, 150 BROADWAY, N Y

FRANCIS H. JACKSON, PRESIDENT.

EDMUND H. MCCULLOUGH, SEC. & TREAS.

THE WESTMORELAND COAL CO.

Chartered 1854.

Mines situated on the Pennsylvania and the Baltimore
and Ohio Railroads, in Westmoreland County, Penn.

POINTS OF SHIPMENT:

PHILADELPHIA, BALTIMORE, SOUTH AMBOY, N. J.
WATKINS (SENECA LAKE), N. Y.

Since the commencement of operations by this Company its well-known
Coal has been largely used by the Gas Companies of New England and the
Middle States, and its character is established as having no superior in gas-
giving qualities, and in freedom from sulphur and other impurities.

Principal Office, 224 South 3d St., Phila., Pa.

The Bower Gas Lamp.

The Perfected Duplex-Regenerative Gas Burner, under
the combined Patents of Anthony S. Bower,
Geo. S. Grimston, and Thos. Thorp.

The First Gold Medal awarded at the Crystal Palace Exhibition in
London, and two Gold Medals at the Stockport (Eng.) Exhibition of Gas
Appliances. Both in 1883.

GEO. SHEPARD PAGE, JOHN BOWER,
69 Wall Street, N. Y. City.

The Management of Small Gas Works.

By C. J. R. HUMPHREYS. Price, \$1.
A. M. CALLENDER & CO., 42 Pine St., N. Y.



INTERNATIONAL--1876--EXHIBITION.

The U. S. Centennial Commission

HAVE DECREED AN AWARD TO

HARRIS, GRIFFIN & CO.,

Twelfth and Brown Streets, Philadelphia, Pa., No. 49 Dey Street, N. Y. City, and No. 75 North Clinton Street, Chicago, Ill.,

FOR THE FOLLOWING REASONS :

The Exhibit consists of a Series of METERS from the Largest Size Station Meters for the use of the MANUFACTURE OF GAS, to those for the use of the ORDINARY CONSUMER. The Instruments are WELL MADE, RELIABLE as to INDICATION, and embody a number of sundry improvements which, with the general character of the Exhibit, entitle the whole to commendation.

Attest—J. L. CAMPBELL,
Secretary, pro-tem.Signed—A. T. GOSHORN,
Director GeneralJ. B. HAWLEY,
President

CHARLES E. DICKEY.

JAMES B. SMALLWOOD.

CHARLES H. DICKEY.

Maryland Meter and Manufacturing Co.,**DICKEY, TANSLEY & CO.,**

Established 1866.

Nos. 22 and 24 Saratoga Street, Baltimore, Md.

No. 46 La Salle St., Chicago, Ill.

MANUFACTURERS OF

DRY GAS METERS, STATION METERS, GLAZED METERS, TEST METERS, METER PROVERS, PRESSURE AND VACUUM REGISTERS, GOVERNORS, INDICATORS, SERVICE AND METER COCKS, AND METER CONNECTIONS.

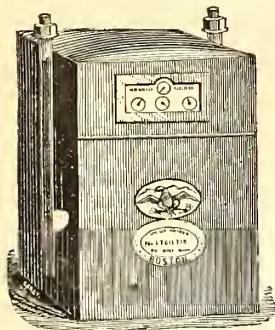

Dry Gas Meter.

With 39 years' experience and the best facilities for manufacturing, is enabled to furnish reliable work and answer orders promptly.

NATHANIEL TUFTS,

No. 153 Franklin Street, Boston, Mass.,

MANUFACTURER OF

DRY GAS METERS.

Station Meters of any Capacity.

Test and Experimental Meters, Pressure Registers, Pressure Gauges, Pressure and Vacuum Gauges.

METER PROVERS, PHOTOMETERS, STREET LANTERNS, ETC., ETC.

Patent Cluster Lanterns for Street Illumination.

SCIENTIFIC BOOKS.

We are prepared to furnish to Gas Managers, and others interested in the topics treated of, the following books, at prices named:

KING'S TREATISE ON THE MANUFACTURE OF COAL GAS. Three vols.; \$10 per vol.

GAS MANUFACTURE, by WILLIAM RICHARDS. 4to., with numerous Engravings and Plates, in Cloth binding. \$12.

THE GAS ANALYST'S MANUAL, by F. W. HARTLEY. \$2.50.

ANALYSIS, TECHNICAL VALUATION, PURIFICATION, and USE OF COAL GAS, by REV. W. R. BOWDITCH, M.A.; with Engravings; 8vo., Cloth. \$4.50.

GAS MEASUREMENT AND GAS METER TESTING by F. W. HARTLEY. \$1.00

GAS CONSUMER'S HANDBOOK, by WILLIAM RICHARDS, C.E.; 18mo., Sewed. 20 cents.

GAS CONSUMER'S MANUAL, by E. S. CATHELS, C.E. 10 cts. PRACTICAL TREATISE ON HEAT, by THOMAS BOX. Second edition. \$5.

GAS WORKS—THEIR ARRANGEMENT, CONSTRUCTION, PLANT, AND MACHINERY. \$8.

COAL; ITS HISTORY AND USE, by PROF. THORPE. \$3.50.

THE GAS WORKS OF LONDON, by COLBURN. 60 cents.

THE GAS FITTER'S GUIDE, Showing the Principles and Practice of Lighting with Coal Gas, by JOHN ELDREDGE. 40 cents.

GAS WORKS, AND MANUFACTURING COAL GAS, HUGHES. \$2.20.

THE MANAGEMENT OF SMALL GAS WORKS, by C. J. R. HUMPHREYS. \$1.

A PRACTICAL TREATISE ON GAS AND VENTILATION with Special Relation to Illuminating, Heating, and Cooking by Gas, by E. E. PERKINS. \$1.25.

PURIFICATION OF COAL GAS, by R. P. SPICE. 8vo. \$3.

HOW TO MANAGE GAS, by F. WILKINS. Paper. 20 cents.

THE GAS MANAGER IN THE LABORATORY, by a Practical Student. 8vo., Cloth. \$1.50.

THE DOMESTIC USES OF COAL GAS, AS APPLIED TO LIGHTING, by W. SUGG. \$1.40.

DISTILLATION OF COAL TAR AND AMMONIACAL LIQUOR, by GEO. LUNGE. \$8.50.

A TREATISE ON THE COMPARATIVE COMMERCIAL VALUES OF GAS COALS AND CANNELS, by D. A. GRAHAM 8vo., Cloth. \$3.

The above will be forwarded by express, upon receipt of price. We take especial pains in securing and forwarding any other Works that may be desired, upon receipt of order. All remittances should be made by check draft, or post office money order.

A. M. CALLENDER & CO., No. 42 Pine Street, New York.

T. C. HOPPER, Pres. G. J. McGOURKEY, Vice-Pres. (New York). WM. N. MILSTED, Gen. Supt. & Treas. (New York). WM. H. DOWN Sec.

AMERICAN METER COMPANY,

WET AND DRY GAS METERS. STATION METERS. EXHAUSTER GOVERNORS. DRY CENTRE VALVES. GOVERNORS FOR GAS WORKS. PRESSURE REGISTERS. PRESSURE & VACUUM REGISTERS. PRESSURE & VACUUM GAUGES. CRESSON GAS REGULATORS. MARSLAND WATER METERS. METER PROVERS. PORTABLE TEST METERS. EXPERIMENTAL METERS. AMMONIA TEST METERS. BAR AND JET PHOTOMETERS.

Manufactories:
512 W. 22d St., N. Y.
Arch & 22d Sts., Phila. } **GAS STOVES,**
SUGG'S "STANDARD" ARGAND BURNERS,
SUGG'S ILLUMINATING POWER METER,
Wet Meters, with Lizar's "Invariable Measuring" Drum. } **Agencies:**
177 Elm Street, Cincinnati.
244 & 246 N. Wells Street, Chicago.
810 North Second Street, St. Louis.
122 & 124 Sutter St., San Francisco.

HELME & McILHENNY,

(Successors to Harris & Brother. Established 1848)

GAS METER MANUFACTURERS,

CONTINUE AS HERETOFORE AT THE OLD ESTABLISHMENT,

Nos. 1115 and 1117 Cherry Street, Philadelphia, Pa.,

To Manufacture Wet and Dry Gas Meters, Station Meters, Experimental Meters, Meter Provers, Center Seals, Pressure Registers,

GOVERNORS, INDICATORS, PHOTOMETERS, & ALL OTHER KINDS OF APPARATUS FOR USE IN GAS WORKS.

From our long practical experience of the business, and from our personal supervision of all work, we can guarantee all orders to be executed promptly, and in every respect satisfactorily.

WM. WALLACE GOODWIN, Prest. and Treas.

WM. H. MERRICK, V.-Prest.

S. L. JONES, Sec.

S. V. MERRICK, Supt.

THE GOODWIN GAS STOVE AND METER COMPANY,

Successors to W. W. GOODWIN & CO.

1012, 1014 and 1016 Filbert St., Phila., Pa. 142 Chambers St., New York.
76 Dearborn St., Chicago, Ill.

WALDO BROS., Agents, 88 Water St., Boston.

MANUFACTURERS OF THE "SUN DIAL" GAS STOVES, FOR COOKING AND HEATING PURPOSES.

Dry and Wet GAS METERS, Station Meters (Square, Cylindrical or in Staves) Glazed Meters, King's and Sugg's Experimental Meters, Lamp Post Meters, Etc., Etc., Meter Provers (sizes 2, 5 and 10 feet), Pressure Gauges of all kinds, Pressure Registers, Pressure and Vacuum Registers, Pressure Indicators (sizes 4 inch, 6 inch and 9 inch), King's Pressure and Vacuum Gauges, Dry and Wet Centre Seals, Dry and Wet Gov. ernors, Exhauster Governors, Photometers of all descriptions. Letheby's Sulphur and Ammonia Test Apparatus complete—also Testing and Chemical Apparatus of all kinds, and of the most perfect description, for all purposes relating to Gas.

GOODWIN'S IMPROVED LOWE'S JET PHOTOMETER.

Agents for Bray's Patent Gas Burners and Lanterns.

Special attention to repairs of Meters, and all apparatus connected with the business.
All work guaranteed first class in every particular, and orders filled promptly.

G. B. EDWARDS, Mang'r, New York.
E. H. B. TWINING, Mang'r, Chicago.
A. B. STANNARD, Agent.

D. McDONALD & CO., GAS METER MANUFACTURERS.

(Established 1854.)

51 Lancaster St., Albany, N. Y. 34 & 36 West Monroe St., Chicago, Ill.

STATION METERS, EXPERIMENTAL METERS, METER PROVING, PRESSURE & VACUUM REGISTERS, PRESSURE GAUGES, ETC.

Also STAR GAS STOVES, RANGES, and HEATING STOVES.

We use only the very best materials, and employ the most skilled labor, and by our long experience (29 years) and personal supervision of every detail, we feel justified in assuring the public that our goods will give perfect satisfaction. Every Meter emanating from our establishment will bear the State Inspector's BADGE, and will be fully warranted by us. Our Annual and Calendar will be sent to Gas Companies upon application.

KING'S TREATISE ON COAL GAS.

The most complete work on Coal Gas ever published. Three vols., bound, \$30.

A. M. CALLENDER & CO., No. 42 Pine Street, New York.

THE GOODWIN GAS STOVE AND METER CO.,

1012-18 Filbert St., Phila., 142 Chambers St., N. Y., 76 Dearborn St., Chicago.

Agents, WALDO BROTHERS, 88 Water Street, Boston.

WM. W. GOODWIN, PRES. & TREAS.
W. H. MERRICK, VICE-PRES.
S. LEWIS JONES, SEC.
SAMUEL V. MERRICK, SUPT.

SOLE MANUFACTURERS OF THE

G. B. EDWARDS, Mang'r, N. Y.
E. H. B. TWINING, Mang'r, Chicago.
A. B. STANNARD, Agent.

"SUN DIAL" GAS STOVES

The Most Economical, Efficient, and Durable Gas Stove Made.

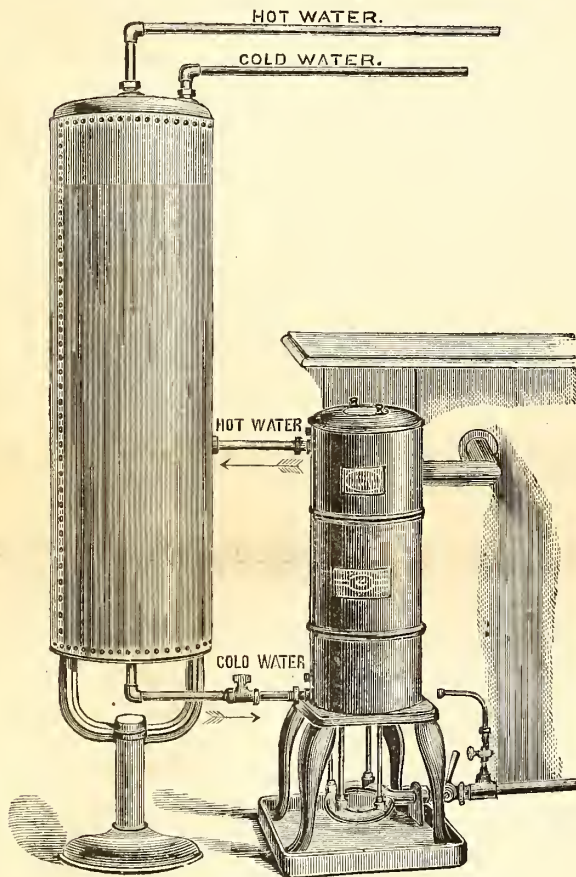

I.—Safety Hot Water Generator and Boiler.

Safety Hot Water Generator and Boiler.

Cut I. represents our Safety Gas Hot Water Generator and Boiler, arranged for home use. This most easy, quick, and economical way of preparing a warm bath, or for heating water for any domestic purpose, entirely supersedes any necessity for the use of ranges or stoves—a great comfort, particularly in hot weather. The boiler being self-filling, as the hot water is drawn off, can never become empty, thus preventing the possibility of any accident.

We beg to call attention to the cast iron pan which is now attached to the legs of the Generator (see illustration). This is to catch the drippings from the Coil, which many persons suppose come from a leak, when in fact they are produced by condensation. This condensation is caused by the hot flame coming in contact with the coil filled with cold water.

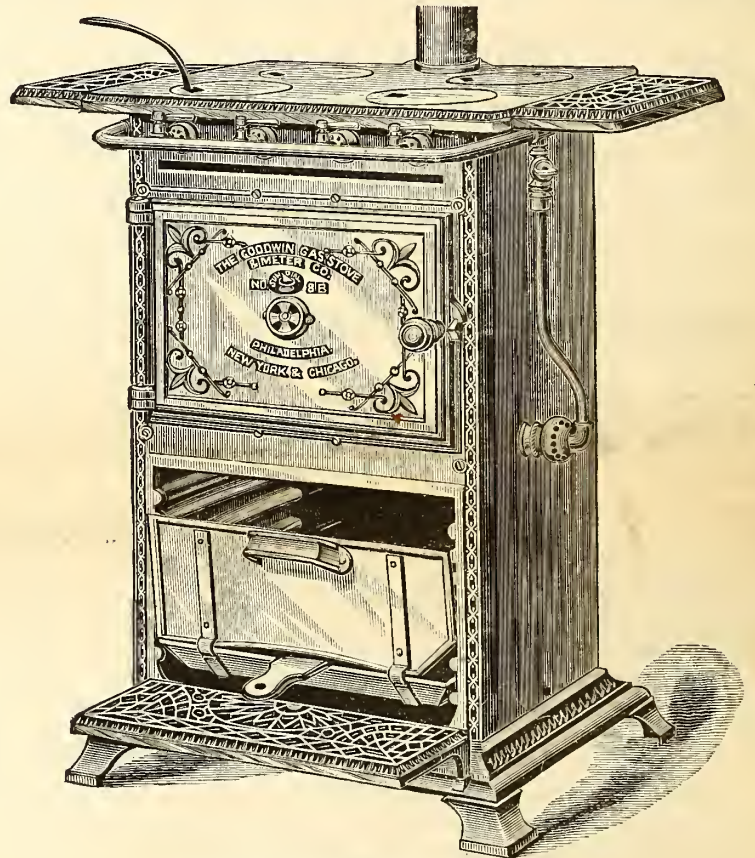

II.—Gas Cooking Stove No. 8 B.

New Style Gas Cooking Stove.

Cut II. represents our New Style Cooking Stove. As will be seen, it has an ornate cast iron base and front, and extension shelves. The oven burner, which is atmospheric (unless otherwise ordered), is of an entirely new and improved pattern (patent applied for). The ovens are of greater capacity than those of the old style. The top, in conjunction with the outlet pipe, is designed to carry off all products of combustion; hence the outlet pipe must be connected with a flue, or the stove will not work properly.

This Stove has 4 boiling burners in top of hot plate. All fittings are nickel plated. We are making this style of Cooking Stove in the following sizes—viz., No. 7 B, No. 8 B, No. 9 B, and No. 10 B.

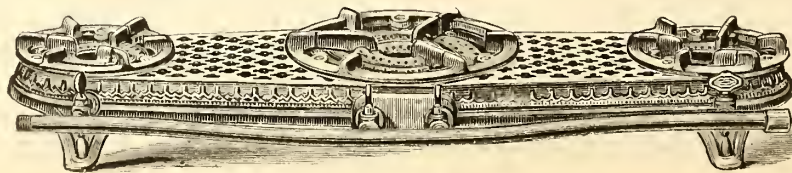

III.—Improved Hot Plate, No. 108.

New Style Hot Plates.

Cut III. represents our New Style of Hot Plates, of which we are making No. 106 (two small boiling burners), No. 107 (two medium sized boiling burners), and No. 109 (two medium and one large boiling burner). See new Catalogue and Price List for further particulars.

THE AMERICAN GAS LIGHT JOURNAL

PUBLISHING OFFICE No. 42 PINE STREET

DEVOTED TO THE INTERESTS OF ILLUMINATION, VENTILATION, WATER SUPPLY AND DISTRIBUTION, & GENERAL SCIENCE.

VOLUME XLIII.—No. 10.
Whole No. 634.

NEW YORK, MONDAY, NOVEMBER 16, 1885.

\$3 PER ANNUM
IN ADVANCE.

A. M. CALLENDER & CO., Proprietors. C. E. SANDERSON, Manager.
JOS. R. THOMAS, C. E., Editor.

ENTERED AT THE POST OFFICE AT NEW YORK, N. Y.,
AS SECOND CLASS MATTER.

Published on the 2d and 16th of each month, at No. 42 Pine Street, N. Y.

Terms of Subscription, Including Postage.—For the United States and Canada, \$3 per annum. European countries, \$3.50 (15 shillings—18 francs). All payments to be made in advance. Single copies, 15 cents.

Remittances should be made either by post-office order, registered letter, or bank draft on New York, payable to the order of A. M. Callender & Co.

Collections are invariably made directly from this office, for subscriptions, advertisements, etc. We have agents to solicit the same, but they are not authorized to receipt for money.

Correspondence.—Wishing to make this JOURNAL a gazette of intelligent discussion to those of our readers who may wish to gain or give information on the subjects to which its columns are devoted, correspondence is solicited for publication from all who make the study of those subjects a pleasure or a profession.

The American News Company, Nos. 39 and 41 Chambers street, New York, are agents for this JOURNAL. Newsdealers will send orders to them.

Books—We will forward by express, at publisher's lowest rates, any book—scientific or otherwise—to any address in the United States or Canada. No books will be sent C. O. D.

CONTENTS.

An Asterisk (*) denotes an illustrated article.

EDITORIALS—

The Gas Consumers' Association, and the New York State Political Canvass.....	253
Gas-Heated Bakers' Ovens.....	254
Personal.....	254
Death of Mr. Alfred Odiorne.....	254
Death of Mr. F. W. Hartley.....	254
Thirteenth Annual Meeting of the American Gas Light Association —Official Report—Continued from page 230.....	255
Report of Executive Committee—Report of Finance Committee—Reports of Secretary and Treasurer—Committee on Nominations—Committee on Place of Meeting, 1886—Roll Call—*Difficulties Encountered in the Construction of a Gasholder Tank, by Emerson McMillin—Discussion.	
The Formation of Coal.....	260
Poisoning by Illuminating Gas.....	260
ITEMS OF INTEREST FROM VARIOUS LOCALITIES.....	261

Gas Matters in Long Island City, N. Y.—Another Reduction in Price of Gas at Toronto, Can.—Gas vs. Electricity in the State Capitol Building and Grounds at Madison, Wis.—Doings of the Sioux City (Iowa) Gas Light Company—Electric Wires Did not Cause the Fire in the Steamship Waesland—There is no Mistake in this Case—Cottage City, Mass., will Probably have a Gas Company—A Combination among the "Carbon Point" Manufacturers—Change of Official Designations—New Gas Company—Natural Gas at Toledo, Ohio—Personal—It was a Work of Necessity—Brockton (Mass.) Has an Electrical Experience—But it was only an Experimental Station—Another Gas Consumers' Benefit Company—Poisoned by Inhaling Gas.

CORRESPONDENCE—

Mr. Allen Advertises the "Allen-Harris Process".....	263
The Market for Gas Securities	264

THE GAS CONSUMERS' ASSOCIATION AND THE NEW YORK STATE POLITICAL CANVASS.

When the pet scheme concocted by the Gas Consumers' Association for the purpose of saddling on the gas companies of New York city the duty of maintaining a commission charged with the regulation of the metropolitan gas supply, at an estimated annual outlay (to the gas purveyors) of \$40,000, was defeated by adverse vote of the New York State Assemblymen, on date of April 30th last, the "gas reformers" were thrown into a sort or species of mental condition that hovered between despair and insanity. When the most acute symptoms of their peculiar malady had been dulled, as a consequence of the "passing of the days," the doughty band resolved and determined it should make itself further heard in the matters over which it held a self-constituted conservatorship. With that great display of genius so characteristic of all its public doings, the Association concluded it would be a master-stroke to "print a book," and distribute or circulate the same among the constituents of those legislators whose negative votes had doomed the commission measure to quiet and dusty repose in the many pigeon holes which serve as burying places for "defeated bills." The "book," of course, was to contain a full explanation of the blessings which would have been reaped by the gas consumers of New York city had the Sherwood-Thurber-Schultz *et al* measure been made a law; and it was also to specify the corrupt manner in which the project was defeated. The title selected for the wonderful volume was, "The History of a Legislative Shame," and the "history" was duly circulated in the districts represented by the defaulting Assemblymen. Not satisfied with that effort, at about the time the nominations for legislators to serve in 1886 were to be made, the same districts were thickly strewn with another literary production (the last one was a letter) of the "reformers," and this time they had grown bolder, or at least more rabid, in the nature of the assertions put forward. Incidentally, though, it might be remarked the letter bore no individual signatures, the utterers thereof hiding their identity under the shield afforded by the term, "The Gas Consumers' Association." We do not here propose to follow out the effect exerted on each individual aspirant for an assembly nomination who was thus attacked, but will single out the most noteworthy case, and present it as a fair sample of the success that attended the operations of the libellous action of the association clique.

The Hon. Geo. W. Greene represented, in the 1885 session of the New York State Legislature, the second assembly district of Orange county. The voters who selected him to watch over their interests will, as a class, compare most favorably in point of intelligence and discrimination with those from any other section of the Empire State. Mr. Greene's legislative course at Albany was carefully observed by those who sent him there; they had no complaint to make with regard to his fidelity and honesty. In short, they were perfectly satisfied with their servant's record; and, knowing this to be the case, naturally enough Mr. Greene placed himself in the field as a candidate for renomination at the hands of his party. When such candidacy was announced the "reformers" put in motion the wheels of their "literary bureau," and the second district of Orange was literally covered with their "tracts." The attacked aspirant met the slanderous charges in a manly way, and appealed to the *Monroe Herald* to grant him space in its columns to the end that he might refute the slanders insinuated (rather than openly charged) against him by his anonymous foes. The proprietor of the *Herald* immediately assented, with the following result. Mr. Greene opened his

attack by stating that the Gas Consumers' Association had been flooding the assembly district with copies of a letter which "broadly insinuated that your representative is corrupt, and that the association is in possession of damaging facts to substantiate their insinuations, which will be forthcoming in case the incumbent should be renominated. It is difficult to write of such dastardly and scoundrelly assassins with any degree of moderation. The men who wrote and are causing to be circulated that letter knew they were infamous liars when they insinuated that they or anyone else are in possession of a single fact even tending to establish venality or corruption on the part of your representative. He challenges them to publish any such charge over their signatures, that the person so publishing may show his willingness to assume the responsibility of his charge, and no longer cowardly hide behind the name of the Gas Consumers' Association."

Now it would appear to the impartial observer that this language was sufficiently plain to be understandable; and, in fact, it might be voted by some as rather emphatic, if not decidedly pungent. However, the parties challenged made no response, and the possessors of the "damaging facts" held their peace and their tongues—at least so our information goes, and we have no reason to doubt the correctness of the story. While the first portion of Mr. Greene's published answer to his would-be defamers' aspersions is sufficiently interesting, it is where the gentleman goes on to give some of the reasons why he opposed the original commission measure that he becomes particularly instructive. After alluding to objections held by him against sections four and ten—and these alone would furnish sufficient cause whereon to base a negative vote—he said:

"Section twelve of the proposed bill contained the following: 'The corporations affected by this act shall provide the most approved appliances for correctly ascertaining the amount of gas supplied to consumers at the *place of consumption*, and for preventing the waste of gas, and also for properly testing its quality, purity, illuminating power, and pressure, as *said board shall from time to time direct*.'" The italics are ours.

From that wording of the section Mr. Greene directs attention to the fact that absolute power would be vested in the commissioners to say whose patent and whose meter should be put in use in every house and business place in the city, and without any limit as to how often they might be changed. If the commissioners said, "Jones' is the meter, Jones' must go in." Of course, it is easy to see, in the light of all this, where the possibilities of a pretty job were concealed. In the second bill presented the defects in sections four and ten were partially remedied, but the features of section twelve were reincorporated in the amended measure under the section numbered six. While the second bill was being considered in the Senate, reformer F. B. Thurber was told by Mr. Greene that if the sixth section were properly amended he (Mr. Greene) would vote for the bill in the House. Messrs. Sherwood and Potter, of Consumers' Association, approved of the amendment, but Mr. Thurber held out. The amendment proposed by Mr. Greene provided for the appointment "of a competent board of three who should make a public test and trial of the various instruments used for measuring gas, and who should make an award in accordance with the results of such trial; that when changes were made the meter thus receiving the award should be used; that no subsequent change should be made within a year, and not then without a like public test, trial and award." This amendment, chiefly (as asserted by Mr. Greene) through the influence of the Thurber interest, was rejected; and Mr. G. thus accounts for "reformer" Thurber's pertinacity in regard thereto:

"But Mr. Thurber and his attorneys have not left the matter in doubt. Hon. S. T. Hopkins, of Greene county, N. Y., informed me at the time of the Grant funeral ceremonies that Mr. Thurber had solicited him to take \$10,000 of the stock in a new meter company then formed or to be formed, and in which Mr. Thurber was interested. Hon. John Raines, of Ontario county, N. Y., on the same occasion informed me that Mr. E. B. Harper, President of the Mutual Reserve Fund Life Association, of New York city, had stated to him that one of Mr. Thurber's attorneys had solicited him (Mr. Harper) to take \$5,000 of the stock of the new meter company." Of course, under such circumstances, there is little reason for wondering why Mr. Thurber was solicitous about the fate of section six. As said before, all this has been public property for some time back, and may be found in the columns of the *Monroe Herald*, of date of October 6th.

To show what effect was carried by the anonymous publications referred to, we may state that Mr. Greene was renominated and re-elected; and a like result appears to have followed in other localities of the State where the "Consumers' Association" tried the "offensive partisanship" dodge.

GAS-HEATED BAKERS' OVENS.

If one may judge from the crowds continually surrounding the booth occupied by the "Martha Washington Flour Company's" exhibit at the American Institute Fair, now being held in this city, we should certainly conclude

that cooking by the aid of gas heat is an object of decided interest to the public. The exhibit is located in Section 20, on main floor of Institute building, and the exhibitors have leased, and keep in active duty in their stall, a specimen of the Thompson Oven Company's portable iron gas oven. The oven structure is 48 inches in height, 41 inches in depth, and 33 inches wide; the oven compartment proper is divided by a central shelf, and is calculated for a baking duty of 300 pounds of flour in ten hours, with a gas consumption of 21 cubic feet per hour. The cook in charge of the oven at the Fair says the work accomplished by it is perfectly satisfactory in every respect. The working heat may be reduced or increased at will. We would advise every visiting gas man to make an inspection of its operation.

PERSONAL.

In our comments in last issue on the Cincinnati meeting of the American Gas Light Association we spoke of the personal sacrifice made by President Vanderpool in being in attendance at the sessions thereof. If further corroboratory proof is needed in the premises, we think the same is amply furnished by the information that Mr. and Mrs. Vanderpool sailed for Europe, in the steamship *Aurania*, on Saturday last.

DEATH OF MR. ALFRED ODIORNE.

We regret to be called upon to chronicle the demise of Mr. Alfred Odiorne, former Superintendent of the Springfield (Ills.) Gas Light Company, whose death occurred at his late residence in that city at an early hour on the morning of November 4.

Mr. Odiorne was born in Woburn, Mass., on August 16th, 1819, and at an early age identified himself with the gas business. He visited Springfield for the first time in 1854, in company with his brother George, they having secured a joint contract to erect a gas works in that city. When the plant was completed, and the operation of same assured of success, the subject of this sketch returned to his Eastern home; but in October, 1867, at the solicitation of the proprietors of the Springfield works, he assumed the Superintendency of the Illinois establishment until relieved by death of all earthly care. Mr. Odiorne was a member of the Western Gas Association. He was a progressive engineer, and an honest, upright man.

DEATH OF MR. F. W. HARTLEY.

The English fraternity of gas engineers has encountered a severe shock in the sudden death of Mr. Frederick William Hartley, late Manager of the famous gas engineering firm operating under the title of Alexander Wright & Co., in Millbank street, London. His death occurred on the evening of Saturday, Oct. 17, and the "snuffing out of life's candle" is attributed to heart disease, over which complaint Mr. Hartley had been a gentle, patient sufferer since April, 1884. Mr. Hartley enjoyed a great reputation among his European brotherhood, and strict truth is adhered to in the assertion that his name and fame were held in almost as great esteem and favor on this side of the Atlantic as they were in his own country.

Mr. Hartley was a most voluminous writer, and his compositions always displayed evidence of research, perspicacity and soundness. His articles on "Cooking by Gas," "Coal Gas as a Fuel," and the "Calorific Power of Coal Gas," are probably those which attracted the greatest attention among American gas engineers; but it is also true that his volumes on "Gas Meter Testing" and "Gas Measurement," also the "Gas Analyst's Manual," have been widely circulated in America. He was an Honorary Member of the Gas Institute. To employ the words of our English contemporary in its initial notice of the death of its valued contributor, "He was an upright, honorable man; respected as a manufacturer, and implicitly relied upon as an experimentalist."

PUBLICATION POSTPONED.

Under the heading of "Gas Governors" (for which see page 236, issue of Nov. 2), it was stated that a fully illustrated description of an "automatic differential gas governor" would appear in this number of the *JOURNAL*. The description of same is unavoidably postponed until the number for December 2 makes its appearance.

EXPLOSIONS IN MINES.—The causes of explosions in mines and the means of preventing them are to be made the subject of especial investigation by a permanent commission in Austria. The scope of immediate inquiry includes safety lamps, coal dust explosions, meteorological observations, ventilation, and the use of gunpowder for blasting.

[OFFICIAL REPORT—Continued from page 230.]

Thirteenth Annual Meeting of the American Gas Light Association.

HELD AT COLLEGE HALL, CINCINNATI, OHIO, OCT. 21, 22, 23.

FIRST DAY—MORNING SESSION.—WEDNESDAY, OCT. 21.

REPORT OF EXECUTIVE COMMITTEE.

The following report of Executive Committee was read by the Secretary. On motion, the report was accepted and its recommendations ratified as the action of the Association.

CINCINNATI, OHIO, Oct. 21, 1885.

To the Members of the American Gas Light Association: Gentlemen—Your Executive Committee would respectfully report the following acts and recommendations for your approval:

The hours for holding the sessions during the present meeting to be as follows: Wednesday, meet at 10 A.M.; adjourn at 12 M.; reconvene at 2 P.M.; adjourn at 6 P.M. Thursday, meet at 9:30 A.M.; adjourn at 12:30; reconvene at 2 P.M.; adjourn at 6 P.M. Friday, meet at 9 A.M.; adjourn at 11 A.M.; reconvene for final adjournment at 5 P.M.

Recommended, that the salary of Secretary and Treasurer be fixed, until further action of the Association, at \$500, and his expenses in attending the meetings of the Association.

The following papers have been approved: "Natural Gas," by W. H. Denniston; "Stoking Machines," by M. S. Greenough; "Improved Furnaces," by Austin C. Wood; "The Result of a Month's Working with Limed Coal," by James Somerville; "The Thermophote, or Self-Registering Photometer," by T. O'Connor Sloane; "The Present State of the Gas Business," by J. C. Pratt; "Difficulties Encountered in the Construction of a Gasholder Tank," by Emerson McMillin; "Automatic Street Main Governors," by Wm. Enfield; "The Relations of Corporations to Municipalities," by J. B. Crockett, Jr.; "Naphthaline," by J. H. Walker, Sr.

Your Committee, taking cognizance of the fact that we are honored this year by the presence at our meeting of R. P. Spice, Esq., Past-President of the Gas Institute of England, take pleasure in proposing him as an honorary member of the Association.

For the Committee,
A. B. SLATER, Chairman.

REPORT OF FINANCE COMMITTEE.

Mr. John Andrew, of Finance Committee, read the following report, which was, on motion of Capt. W. H. White, received and ordered spread on the minutes.

CINCINNATI, OHIO, Oct. 20, 1885.

To the Members of the American Gas Light Association: Gentlemen—Your Finance Committee would respectfully report that they have examined the books and accounts of the Secretary and Treasurer, C. J. R. Humphreys, for the year ending Sept. 30, 1885, and find the same to be correct.

Very respectfully,
JNO. ANDREW, } Finance
WM. CARTWRIGHT, } Committee.

REPORT OF SECRETARY AND TREASURER.

Mr. C. J. R. Humphreys, Secretary and Treasurer, here presented the following detailed report covering fiscal and membership statistics of the Association for year ended Sept. 30, 1885:

<i>Receipts.</i>	
From initiation fees.....	\$160 00
" dues for year 1882.....	5 00
" " " 1883.....	25 00
" " " 1884.....	120 00
" " " 1885.....	990 00
" " " 1886.....	5 00
Sale of "Proceedings".....	7 75
Interest on the funds of the Association.....	88 60
Total receipts.....	\$1,401 35
Cash brought forward from last year.....	2,263 48
Total amount to debit.....	\$3,664 83
<i>Expenditures.</i>	
Printing of Vol. VI., and postage on same....	\$772 21
Expense of Washington meeting.....	307 70
Printing, etc.....	125 85
Salary of Secretary and Treasurer.....	500 00
Postage, stationery, and sundries.....	95 48
Total expenditures.....	\$1,801 24
Cash on hand carried to credit of next year ..	1,863 59
Total amount to credit.....	\$3,664 83

Mem. of cash on hand—

Deposit in South Brooklyn Savings Bank.....	\$1,115 89
Deposit in Williamsburgh Savings Bank.....	744 28
Cash in Treasurer's hands.....	3 42
Total as above.....	\$1,863 59
Due from members, including dues for 1886.....	1,730 00

Roll call for the year shows as follows—

<i>Active Members.</i>	
Number on roll call Oct. 1, 1884.....	271
Admitted at last meeting.....	16
	287
Number dropped from the roll.....	11
Died during the year ..	4
Resigned	2
Now on roll, Oct. 1, 1885.....	270
	287

Honorary Members.

Number on roll Oct. 1, 1884.....	6
" " " 1885.....	6

Deceased Members.

Thomas Butterworth.....	Rockford, Ills.
George Cornell.....	Youngstown, Ohio.
I. Herzog.....	New York, N. Y.
Francis Thompson.....	Charlestown, Mass.
C. J. R. HUMPHREYS, Sec. and Treas.	

On motion of Mr. A. B. Slater the report was received and ordered spread on the minutes.

COMMITTEE ON NOMINATIONS.

The President appointed Messrs. W. A. Stedman, G. A. Hyde, Thomas Turner, T. Littlehales, and D. D. Flemming a committee to nominate a board of officers for ensuing year.

COMMITTEE ON PLACE OF MEETING, 1886.

On motion, Messrs. W. H. White, I. N. Stanley, W. H. Pearson, Walter Wood, and J. P. Harbison were appointed a committee to name a city where-in to hold the fourteenth annual meeting of the Association.

ROLL CALL.

Calling the roll disclosed the presence of the following members:

Honorary Member—R. P. Spice, London, Eng.

Active Members.

Anderson, John, Ironton, Ohio.	Gates, F. W., Hamilton, Ont., Can.
Andrew, John, Chelsea, Mass.	Graves, Henry C., Dayton, Ohio.
Barret, A. H., Louisville, Ky.	Graeff, G. W., jr., Philadelphia, Pa.
Baumgardner, J. H., Lancaster, Pa.	Gardner, Jas., jr., Pittsburgh, Pa.
Battin, Isaac, Albany, N. Y.	Geggie, David H., Quebec, Canada.
Baxter, Wm. H., Petersburg, Va.	Greenough, M. S., Boston, Mass.
Beal, W. R., New York, N. Y.	Gribbell, John, New York, N. Y.
Boardman, A. E., Macon, Ga.	Griffin, John J., Philadelphia, Pa.
Blodget, Chas. W., Brooklyn, N. Y.	Gilbert, T. D., Grand Rapids, Mich.
Bush, John S., New York, N. Y.	Goodwin, W. W., Philadelphia, Pa.
Butterworth, Wm. C., Rockford, Ills.	Harbison, John P., Hartford, Conn.
Cabot, John, New York, N. Y.	Helme, Wm., Philadelphia, Pa.
Clark, Walton, New Orleans, La.	Hickenlooper, A., Cincinnati, Ohio.
Cartwright, Wm., Oswego, N. Y.	Hookey, Geo. S., Augusta, Ga.
Cartwright, J., Fishkill, N. Y.	Hopper, Thos. C., Philadelphia, Pa.
Cartwright, Matt, Rochester, N. Y.	Howard, L. J., St. Louis, Mo.
Cressler, A. D., Fort Wayne, Ind.	Humphreys, Alex. C., Phila., Pa.
Cole, T. W., Altoona, Pa.	Humphreys, C. J. R., Lawrence, Mass.
Coggshall, H. F., Fitchburg, Mass.	Hyde, G. A., Cleveland, Ohio.
Collins, A. P., New Britain, Conn.	Isbell, Chas. W., New York, N. Y.
Connelly, T. E., Pittsburgh, Pa.	King, E. J., Jacksonville, Ills.
Connelly, J. S., Pittsburgh, Pa.	Leach, Henry B., Taunton, Mass.
Copp, Austin M., Boston, Mass.	Lindsley, Edward, Cleveland, Ohio.
Cornell, Thomas C., Yonkers, N. Y.	Littlehales, T., Hamilton, Ont.
Cowing, John H., Buffalo, N. Y.	Loomis, Burdett, Hartford, Conn.
Coyle, Patrick, Charlestown, Mass.	Ludlam, Edwin, Brooklyn, N. Y.
Curley, Thomas, Wilmington, Del.	McElroy, John H., Pittsburgh, Pa.
Cushing, Oliver E., Lowell, Mass.	McMillin, Emerson, Columbus, O.
Denniston, W. H., Pittsburgh, Pa.	McIlhenny, John, Phila., Pa.
Dickey, R. R., Dayton, Ohio.	McDonald, Wm., Albany, N. Y.
Dingee, F. A., Philadelphia, Pa.	Nash, C. H., St. Joseph, Mo.
Flemming, D. D., Jersey City, N. J.	Neal, Geo. B., Charlestown, Mass.
Floyd, James R., New York, N. Y.	Nettleton, C. H., Birmingham, Conn.
Floyd, Fred. W., New York, N. Y.	Page, G. S., New York, N. Y.
Fullager, John, Cincinnati, Ohio.	Pratt, John C., Boston, Mass.
Fry, Chas. C., Lynn, Mass.	Pearson, Wm. H., Toronto, Ont.

Pritchard, Chas. F., Lynn, Mass.
 Prichitt, Sam'l, Nashville, Tenn.
 Ramsdell, G. G., Vincennes, Ind.
 Rankin, Benj., Louisville, Ky.
 Reinmund, Henry J., Lancaster, O.
 Robinson, Wm. L., Uniontown, Pa.
 Roots, D. T., Connersville, Ind.
 Roots, F. M., Connersville, Ind.
 Slater, A. B., Providence, R. I.
 Smallwood, Jas. B., Baltimore, Md.
 Stanley, Ira N., Brooklyn, N. Y.
 Starr, Jas. M., Richmond, Ind.
 Smedberg, Jas. R., Lancaster, Pa.
 Stedman, Wm. A., Newport, R. I.
 Stein, E., Philadelphia, Pa.
 Spencer, R., Burlington, Iowa.
 Smith, Jas. H., Newark, Ohio.
 Simpkin, Wm., Richmond, Va.
 Somerville, Jas., Indianapolis, Ind.
 Taber, R. B., New Bedford, Mass.
 Tayler, Geo. H., Warren, Ohio.
 Thomas, Jos. R., New York, N. Y.
 Townsend, S. S., New York, N. Y.
 Turner, Thos., Charleston, S. C.
 Vanderpool, Eugene, Newark, N. J.
 Walker, J. H., jr., Milwaukee, Wis.
 Weber, Oscar B., New York, N. Y.
 Wells, Geo. H., Nashville, Tenn.
 White, Wm. H., New York, N. Y.
 Wood, Austin C., Syracuse, N. Y.
 Wood, Gideon, New Bedford, Mass.
 Wood, Walter, Philadelphia, Pa.

Pressing routine business having been disposed of, the President announced that reading of papers was in order. Mr. Emerson McMillin, of Columbus, Ohio, thereupon read the following paper, entitled,

DIFFICULTIES ENCOUNTERED IN THE CONSTRUCTION OF A GASHOLDER TANK.

The members of our Association are profited at every session by hearing of the successful experiments and undertakings of their fellow members; but, believing that we may be equally profited by recounting our mistakes and failures; I have thought it advisable to give a short history of difficulties encountered, and mistakes made, in the construction of a tank during the year 1884.

That you may better comprehend the remarks, I present a topographical survey of the ground, also plan and sectional elevation of the tank.

The city of Columbus is located on "drift" formation. The drift deposit is from 60 to 120 feet deep. It is chiefly composed of a greenish blue clay, thickly interspersed with lime boulders. The surface, in many places, is covered with a few feet of gravel; and at a depth of 25 to 40 feet, another seam of gravel and sand is reached.

The plot of ground in which our tank was excavated was barely large enough to contain it, the brick wall on three sides of the tank touching either alley or street lines.

You will notice, by the topographical survey, that quite a depression in the ground existed near the center of the lot. This depression was originally caused by a stream flowing through the grounds, and which had, ages ago, deposited sand and gravel to a depth of 10 to 20 feet. On this deposit, in the lowest place, had been carted earth removed in the construction of neighboring streets and in grading lots. On the south side of the tank, however, was found solid, greenish-blue clay up almost to the level of the streets.

The excavation was commenced on the south side, going down in nearly a semi-circle, and the earth was carted to the north side. Fearing that sand or gravel might be reached before we had attained the desired depth, we carried down a well four feet in diameter (which you will notice is shown in the plan), making this well three feet deeper than the tank excavation. The tank when completed was to be 93 feet 6 inches inside diameter, and 27 feet deep to top of coping stone. A cone, about 10 feet high, and over 60 feet in diameter, was left in the center.

It was necessary to start a steam pump to drain the depression or pit before the work of excavation could be commenced; and from the time pumping was first started, until the brick walls were up, the pump was run constantly day and night, and much of the time it was found necessary to reinforce it with an additional pump or with a steam siphon. A driven well had been put down years ago, just at the periphery of the tank, to which driven pipe was attached a wood pump. On breaking off this pump the water flowed out of the pipe and gave us an artesian well, until a pick struck sand in our new excavation 30 feet deep, when the artesian well suddenly ceased to flow.

The east and north sides of the excavation were "spouty," and after reaching a depth of 12 or 15 feet sliding commenced, and continued until the excavation was completed, causing us much extra labor and expense. As before stated, sand was struck in the well at a depth of 30 feet. This would not permit us to go as deep as we desired. Leaving three feet of clay in the bottom above the sand, our brick wall would be one foot above ground at the southeast side, and six feet above ground at the northwest side of tank. Reaching the full depth on the south, we began removing the graded roadway, and soon discovered, much to our regret, that the underlying sand and gravel laid in rolls, and, in a large section of the tank, reached up through our intended three feet of blue clay bottom. However, the surface of the sand was covered with rather a compact bed of fine gravel, and we did not anticipate any serious trouble in making a tight concrete bottom.

We now found it necessary to bury a drain pipe (shown in drawing)

around the entire excavation, putting it about three feet inside of what was to be the inside line of brickwork, and running branches out at a few of the wettest places to the outside line of wall. These drain pipes carried all the water to the well outside of the tank, and in which the steam pump was located. Fortunately we had solid earth where our inlet and outlet pipes entered the tank, and a steam siphon (throwing an inch and a-half stream of water) was sufficient to keep the pit dry while we were putting down these pipes and the drip receptacles underneath.

The specification for constructing the bottom required a 12-inch thick ring of concrete to be put down—the ring to have an inside diameter of 89 feet, and an outside diameter of 101 feet, making the ring 12 feet wide; the concrete to be of broken limestone four parts, sharp sand two parts, and good hydraulic cement two parts, all to be thoroughly mixed dry, and again when wet, and to be put in position and thoroughly rammed down immediately on being wetted. The whole to be, when completed, a solid, compact and water-tight mass. The pier foundations were constructed in the same manner. The remaining bottom of the tank, including cone, was to be covered 12 inches thick with three parts of coarse gravel, two parts of sand, and two parts of good hydraulic cement, to be put down in the same manner as specified for the limestone concrete. The entire surface was to be made smooth and even with mortar composed of two parts sand and one of cement; and upon top of this was to be put a one-half-inch thick plaster of best Portland cement—this to guard against the porosity of the other cement mortar. The limestone was broken so as to pass through a two-inch ring.

The specification for the construction of the bottom was adhered to throughout, so far as the company was able to enforce the contract. Sixteen rest stones, eight inches high and twelve inches wide, were laid on the foundation, projecting into wall 9 inches, and into tank 31 inches.

The original specification for brickwork required the lower section, to the height of 8 feet 6 inches, to be made 34½ inches thick, or the thickness of the length of four bricks; the second section, 7 feet 6 inches high, to be 30 inches thick; the third section, 6 feet high, to be 25½ inches thick; and the fourth or top section, 4 feet 8 inches high, to be 21 inches thick.

After seeing the unfavorable character of the ground, the great tendency of the dirt walls to slide, and the height the wall must project above ground, the dimensions of the brickwork were changed, the sections being 43, 34½, 30, and 27 inches, respectively, and at two points, where no embankment could be made to sustain wall above ground, buttresses were built below the roadway, reaching back to solid earth and up to tank wall (as shown in drawing), the buttresses only coming up flush with sidewalk. In many places at the bottom the walls were built out solid to the bank, giving a thickness, for a short distance, of over 4 feet. The piers were carried up full size from the bottom. The specification required the walls to be built of the best hard-burnt brick; the joints to be carefully rubbed up and slushed full of cement mortar, except the 9 inches back of the front 9 inches of wall, which was to be thoroughly grouted. No part of the brickwork was permitted by the specification to be carried up more than 3 feet above any other part of the wall.

The mortar was to be composed of one part of good hydraulic cement to two parts of sharp sand. The cement and sand to be carefully mixed dry, then again when wet, and to be used inside of half hour after being wetted. Bricks were all wet before being laid. At every three feet in height a ring of one and one-half by three-sixteenths-inch band iron was built into center of wall; and in the northwest section, above the natural surface, these bands were put in at every 18 inches in height of wall.

By the specifications and contracts the walls and bottom were to be absolutely water-tight when completed, and if found not so, they were to be made tight at the contractor's expense.

The tank was completed about the first of August, 1884, and by the middle of following September the holder was completed. The tank was filled with water to a height of 20 feet, and was found to leak badly. The water was pumped out and the Portland cement was found fractured in several places, indicating, as we thought, that the pressure of water below had broken the bottom before a sufficient weight of water could be put into the tank to neutralize the upward pressure, though we had taken the precaution to pump the water from under the bottom until we had four feet of water in the tank. We were now satisfied that the concrete was too porous, and we put on a plaster 3 inches thick all over the bottom (not including cone, which is blue clay), and as an extra precaution against breaking this cement we put in six automatic valves that opened to the pressure from below and closed from pressure above. It was in sinking the 3-inch pipes attached to these valves that we first discovered the treacherous character of the bottom. In places where we expected to pierce three or four feet of clay we would not go down six inches until we would find gravel; while perhaps not five feet from that point we would find the clay four feet thick. With the valves in and the bottom cemented, we again filled the tank two-thirds full, and found it leaking almost or quite as badly as before. The long nights of November were

now upon us, and we were needing the holder badly. Pumping the water out the second time, we determined to put in a bottom that would be impervious to water. Coating the bottom with hot asphalt, we put down three complete layers of roofing felt, each laid in asphalt; next a course of hard brick laid flat and the joints poured full of asphalt; then a course of brick on edge and filled and coated with hot asphalt. After giving the walls a thin coating of cement we filled the tank with water, having confidence that it would be practically tight. We were, however, doomed to disappointment. We had, in fact, improved it but little. By pouring tar down into the water outside of the holder, covering the surface of the water twice each day with sawdust, and then sprinkling dry cement on top of the water to carry down the sawdust, we finally got the tank so it might have been used; but as the

then began a regular siege in hunting for weak points. By stopping the pumps for a few minutes the water would surge up at some point, and not by any means always through an automatic valve. While it was easy enough to see where the water came through the asphalt paving, we could not be certain that it did not come through the concrete ten feet from that point. We succeeded, however, in finding several weak places, and it now became a race with us to get these places fixed before the pumps would pump out sand enough to make others. The walls were straight and free from cracks, but the cement near the bottom appeared to be worthless; and when we would stop the pumps the water would gush through the joints near the concrete at one or two points where the wall was four feet thick. We cut out these weak joints 9 inches back, and rebuilt with Roman cement.

Explanation.

- Fig. 1.—Plan of Tank.
- Fig. 2.—Vertical Section of Tank.
- Fig. 3.—Section of Bottom, on a larger scale.
- A.—Brick Wall.
- B.—Cone of Drift Clay.
- C.—Drift Clay Bottom.
- D.—Gravel, with Sand beneath.
- E.—Sewer Pipe below Concrete.
- F.—Well, 3 feet deeper than the Tank.
- H.—Automatic Valves.
- J.—Concrete of Limestone, Sand, and Cement.
- K.—Cement of Sand Plaster.
- L.—Roofing Felt and Asphalt.
- M.—Brick laid in Asphalt.
- N.—Buttresses.

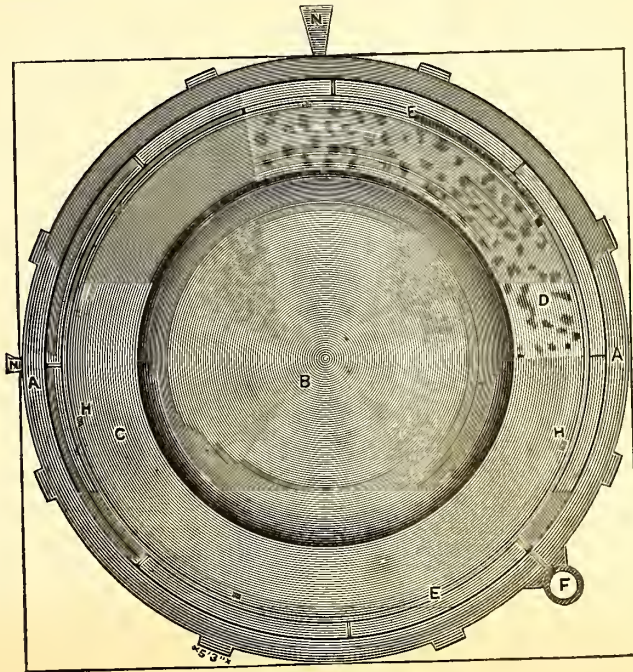
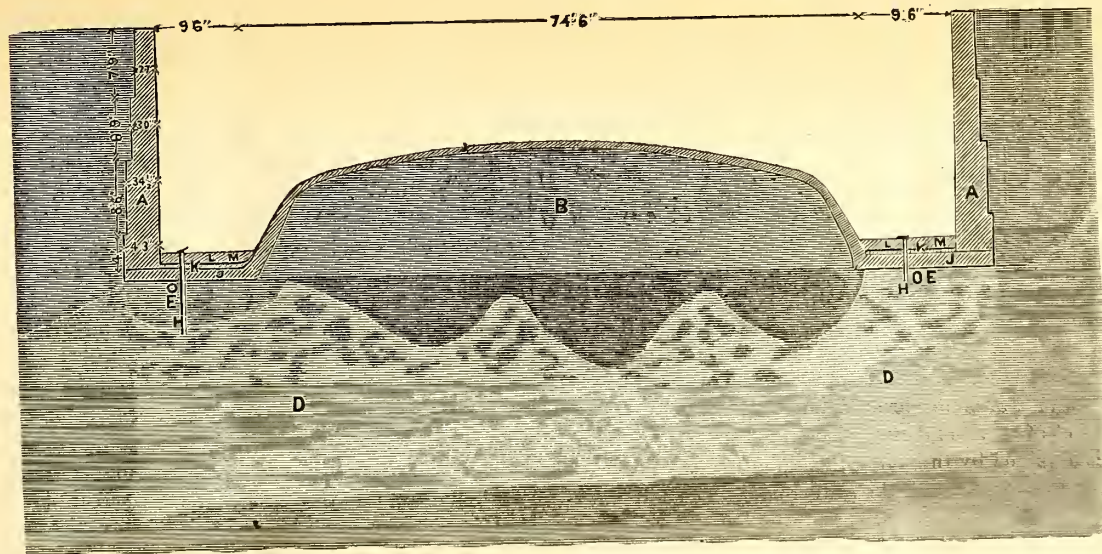

Fig. 1.



Figs. 2 and 3.

nights of heaviest consumption had by this time passed, we concluded to abandon further work until spring.

Feeling quite sure that the incessant pumping, day and night, from the well was probably drawing out fine sand enough to weaken the bottom, and that if the tar could be prevented from reaching the well, it, together with the cement and sawdust, would eventually close up the leakage, we concluded to drive two 4-inch pipes ten feet below the bottom, and then fill up the well solid for eight or ten feet, and thereby cut off the drain pipes. This we did in the latter part of May, 1885. Great was our surprise, however, when we discovered that we were pumping a copious supply of tar and pitch from a depth ten feet below the bottom of the tank. Things now indeed looked serious. Again we pumped the water out of the tank, put in two steam pumps, buried their suction four feet below bottom of the tank, and

At the weak points in the bottom we removed the brick and roofing-felt covering, cut down a little into the concrete, and laid down, in Roman cement, two courses of 2-inch oak plank, the top course at right angle to the course beneath, covered these with pitch, relaid the brick pavement, and after giving the entire brick wall from top to bottom two coats of Roman cement plaster, we were again ready to fill up with water.

The pumps were set six feet above the floor, and the water pumped from beneath the bottom was discharged into the tank; and when the height of water reached the pumps they were disconnected, their suction plugged, and left in position. The tank was then filled from the water works to a height of 13 feet, and left standing four days, when it appeared to be practically tight. Another 12 feet in height of water was then admitted; with this additional pressure the tank leaked some, but so little that we con-

cluded to put it into use, which we did about September 1st of last year, or almost one year after the completion of the holder.

It would be impossible for you to have a full conception of the numerous difficulties encountered, even after you have heard this brief description of our troubles. Our most serious difficulties occurred during our last effort to repair tank, caused by the pitch that had been used in putting down the asphalt bottom. Sometimes whole days and nights would be spent in trying to get our pumps to work. A pump would be taken all apart and thoroughly cleaned, put together, set to work, and in ten minutes time would again be so clogged with pitch that it would cease to take water. The packing alone for two small pumps would, for days at a time, cost us \$2.50 to \$3 per day. Hemp packing would be cut and torn to pieces in a few moments, and gum would both cut and dissolve.

I have told you of some of the *difficulties* encountered, and you can doubtless see where *mistakes* were made without my enumerating them. There were three mistakes made, however, that will not be apparent to you without further information.

First, the concrete was not sufficiently rammed. Do and say what we would, we could not get the sub-contractor to ram the material as the specifications required. We were compelled, owing to the sliding tendency of the earth walls, to cover the bottom with concrete as fast as a few feet were graded. In this way the south and southwest sections, after the concrete was put on, received the travel of wagons and carts passing around the cone in removing the earth from other portions of the pit. That part of the bottom was good, compact, and water-tight. Other portions that were not well rammed would, when the plaster was removed, let the water run through like a sieve.

Another mistake I made was in letting the contractor persuade me that more of the wall ought to be grouted than was provided for in the specifications, and less of it made with slush joints. Grouting does not make as good work as slushing, though I know the custom is to grout most of the wall. The excess of water greatly weakens the tenacity of the work; and when the excess is absorbed by the brick there must of necessity be unfilled spaces left in the wall.

The third, and perhaps the most serious, mistake I made was in using Louisville cement. As this cement could be had at one-third the cost of English Portland or Roman cement, we were tempted to use it, thinking the walls could be made heavy enough to stand, and still make a saving in the cost of the work. The samples of cement submitted with bids for doing the work were good, but that used in the wall and bottom was irregular in quality; and it is not possible to test each barrel as the work progresses, as time alone can determine the properties of a cement. In this particular, at least, I advise you not to follow my economical practice.

Discussion.

Mr. Gilbert—Is Mr. McMillin familiar with the operation of the system by which his city is supplied with water?

Mr. McMillin—Yes, sir.

Mr. Gilbert—It would seem to me as though you penetrated the same strata of porous material which gave them so much trouble in getting a water supply.

Mr. McMillin—Our city of Columbus is supplied with water under the Holly plan, and the water works are located on the banks of the river. There is from 10 to 20 feet of a gravel deposit over the bottom of the river; and the water supply is obtained by tunneling through this gravel. A great many tunnels have been driven through the gravel bed. The water percolates through those tunnels, and the result is a good, clear, and cold water supply. The only objection to it is that it is rather limey. That gravel deposit is not identical with the one encountered by us. It is a more recent deposit—it is a river deposit, pure and simple.

Mr. Greenough—I think Mr. McMillin is to be thanked for bringing to our notice the history of his misfortunes. As a general rule the Association's members hear only of the successes which one of their number may achieve; but it appears to me that it is sometimes equally as instructive and valuable to learn of the failures of others. Seemingly, one likes to hear of the misfortunes of other people, because then he can take some comfort in thinking that he is not alone in encountering trouble. As a supplement to the history of his misfortunes, the account of which has afforded us so much pleasure and interest, I may say that some years ago, in the building of a holder, we had in Boston a somewhat similar experience to that narrated by Mr. McMillin. We had water within three feet of the surface of the ground all the time, so that the pumps had to be kept going continually. A consequence was that when the tank was filled with water it was found to leak—the pumps went down below the wall. We pumped out the water from the tank (there was perhaps a foot in depth left around the edge of the ring), but could not then find the source of leak. It was not until all the water had been taken out that we were able to discover the existence of a little crack, under the wall, about large enough to insert your finger. I mention

this to illustrate the great danger of pumping too fast while excavating for a tank. If there is any sand that can by any possibility get into the pump, you may pump out a little from under the concrete bottom; then when you put the weight of the water on it, down it goes, and you have a leak.

Mr. McMillin—I think that we escaped the difficulty you speak of by having a drain pipe about 3 feet inside the wall. This drain pipe was laid with a tight joint; and it was along the line of drain pipe that we took the sand out.

Mr. Littlehales—In my experience it is far more satisfactory to make an annular ring rather than remove the entire body of earth. If you leave a central core you have something left to shore up against. Even if you have a shifting character, or alternation of clay and gravel, you have something to hold it there in position. My experience is that the cost of removing the core is more than compensated in the additional security gained from it.

Mr. McMillin—I think that is true; and if I were going to place another gasholder alongside of this I should adopt that plan. We did not anticipate any trouble. We had excavated to the same depth for a tank but 200 feet away from the one under discussion, and had no trouble at all.

Mr. Ramsdell—I wish to say a word with regard to the matter of cement. I think what Mr. McMillin names as his third mistake was the most important one of all in respect to the construction of that tank. In 1881 we put up a new holder. Our soil at Vincennes, Indiana, is a difficult one to build a tank on. We have no clay whatever; it is all gravel and sand. We found, if we were to sink the well to the depth originally intended, we would strike quicksand. Accordingly we stopped at a point two feet above the original plan. I figured in like manner with Mr. McMillin in regard to the cost of the cement; and I did not find that Louisville cement would be much cheaper. The Louisville brand is, of course, a great deal lower in price per barrel; but when it is remembered that the Portland barrels contain a greater weight, and that it is so much stronger, there is really very little difference in the respective amounts required for the work in hand. For instance, in the mortar for the brickwork we could use four parts of sand to one of Portland cement; while, with the Louisville sort, we could only use two parts sand to one part cement. And so also with the concrete. We have a concrete bottom built in three layers of four inches each, thus making a solid depth of one foot. In that work we used a proportion of seven or eight parts broken stone to one of cement. The bottom of our tank is perfectly tight; and the whole tank is tight. On the morning after we finished building it we found the water in the tank had lowered about two feet. I was very much alarmed until I discovered the lowering was due to the absorption of the water by the porous bricks. I think, in the long run—regarding the quantity of cement used in a tank—there is very little difference in cost as between the Portland and Louisville cements.

Mr. Helme—I wish to ask Mr. McMillin whether his faith is at all impaired in the ability of concrete to retain water. I have not a great deal of faith in it. I always put in two or three courses of brick. I do not pay much regard to the quantity of cement used; of itself that is a small matter compared with the failure of a tank. If I had any doubt about my cement I should use half cement and half sand. There is another thing about concrete. Many handle the rubble, mix it upon the bank, and then dump it over. It is well to mix it in the pit, spread it as quickly as possible after it has been mixed, and never disturb it again. I always looked upon concrete as a good foundation—if well made out of brick and proper cement. In fact, it is the kind of bottom I have always found best calculated to stand and hold water. If you skimp your cement and are careless about your sand you may count on having trouble. I would like to know what your opinion is about concrete holding water. Do you put on asphalt and use brick?

Mr. McMillin—I put in two courses of brick. One flat course was laid on top of the asphalt, the other course was placed on edge on top of the first, and then three courses of roofing felt were laid over all.

Mr. Helme—When that was done your tank retained water?

Mr. McMillin—It leaked a little worse than it did before we put it on. (Laughter.) It did not seem to make any difference.

Mr. Helme—We built a tank last year, and came very near dumping the purifying house into the hole. We had to work quite lively for a while. We struck quicksand, as you did, on one side. In order to get around it we collected some round stones, each four or five feet in length, and put up a derrick. At the point that bothered us so much we took the sand out and dumped the rocks right in on top until we got a wall strong enough to keep the quicksand back. We went all the way around until we closed the thing in. As we had four feet diameter, on the inside, wherein to build the wall, we put down a good tank, and it holds water very well. We put down four courses of brick, care being taken not to lay any two courses so that the seams would be parallel. When the brickwork was completed it was all coated over with cement. We found it answered very well indeed.

Mr. Harbison—I have not a particle of faith in the contract system of building tanks, and I think Mr. McMillin's greatest mistake was in having the work done by contract instead of under his personal superintendence. I

allude to it now in order that members of the Association, who may by and by build tanks, will not fall into such mistake. At Hartford, Conn., we had an experience quite similar to that detailed by Mr. McMillin, and the teaching of the experience was such that we do not want any more tanks built by contract. We are perfectly willing to have the holder built by contract, but not the tank. I think if he had done the work himself he would not have been so unsuccessful. That was his mistake.

Mr. Beal—It will not do to give all contractors a black eye. In 1884 I built a tank, and three-fourths of one side of the excavation was in solid rock formation. The remaining fourth was in quicksand. The job was given out by contract to the lowest bidder; but we were careful to note that the contractor did his work. It was completed in October, 1884, was filled immediately afterward, and has had no water in it since. So, I beg to say a good word in behalf of the contractor. I might say, in addition, that Louisville cement was not used, neither was Portland cement employed. I have no hesitation in saying to the gentlemen present that a good cement is to be found in the Hudson River district—I refer to Rosendale cement. It will, without any doubt, make a good tank every time.

Mr. Spice—It strikes me that my long experience in tank building may perhaps be worth something to you. I will state it very briefly. Experience has led me to the conclusion, primarily, that the safest way to take hold of a job of that sort is to first dig an annular space. Let that space be timbered, and kept vertical all the way down by means of cross timbers and curbing. Then you have it entirely under your control. Then I begin with a bed of concrete. And, with regard to the different kinds of cement, my simple rule is always to use the best material of every kind that I employ. If I go to a tailor I get the best suit of clothes that he can give me, because I believe that the best is always the cheapest in the end. That principle will apply to everything pertaining to gas apparatus and gas works construction. Get the best of everything. I begin by getting my concrete in, being careful to have a good, large space, even if it be considerably larger than is absolutely necessary. On the center of that I commence to place my bricks, and have determined that the bricks should be laid longitudinally. I lay a ring of stretchers, not all around the tank, but close to the circular row of stretchers. Outside of that I place a circular layer of firebrick. I begin with brick that are $9 \times 4\frac{1}{2} \times 3$. Outside of the inside layer I put another row of firebrick; then another layer of 3 inch; and so on, or as wide as I want the base. Then I put on the inner ring another layer of 3-inch brick; and on the row beyond the second row of firebrick a 3-inch brick; then firebrick; and then 3-inch brick again. Then a 3-inch brick on top of the first one; and a 3-inch on the second—not the second tier, but beyond the firebrick. In that way I get a groove. I put into that groove some stiff cement—so stiff that it would just run out of an iron bucket. I run in a quantity of cement, and upon that I bed my next course of 3-inch brick. In accordance with that plan I go all the way up. I keep on laying brick so as to form a channel, into which I pour the cement; then I have only to build on the inner ring, and on the outer ring, with the aid of a trowel, spread the cement and bed the bricks in the ordinary way. All the way through the course I keep on forming channels. The idea is to prevent any single joint being connected with another single joint. Every joint is broken vertically, horizontally, and lengthwise; and then these divisions are so many walls of cement; so that no water can possibly run straight through. The firebrick, to begin with, are laid, not so as to fill the groove, touching brick to brick, but so as to leave a margin of half an inch; so that there are so many cells, making so many walls of cement dividing those brick walls. In that way I found I could get the best results over any other plan that I have ever tried—and I may add I have tried all. The conclusion I came to is that the safest way of building a tank is by stretchers; no single joint being connected with another joint, and continuing on in that style all the way up, finishing out, of course, with flat work at the top.

Mr. King—I think it does not always follow that the most expensive way is the best. In the experience of our company, gained before my time, however, while excavating for a tank, they encountered quicksand. After resorting to all manner of expedients in attempts to overcome the difficulty—meeting with failure in all of them—they were about to abandon the job, when my father suggested they commence to wall back to the blue clay and puddle. The scheme was successful, and the tank is, I think, as tight to-day as any other tank in the country. Yet at one time a very serious question with them was how to overcome the quicksand difficulty.

Mr. Lansden—Some 20 years ago I made an excavation for a tank which was almost all in sand. We could drive the well down 150 feet. I made the excavation at a time when the water was in the ground, and kept it down by pumps from the outside. I laid a series of tile from bottom of the tank to the center. Over that I laid oak plank, 12×3 . I broke the joints, and put a crosswise covering of planking of similar thickness, leaving only an open space, where my pump was placed, in the center. On top of the planking I laid two courses of brick with Louisville cement. I then placed a $1\frac{1}{2}$ -inch pipe in the central opening and kept on pumping the water up. I

built an arch around the pipe and filled in with cement, keeping the pump running, and had everything complete and ready so as to let the water in when we stopped pumping. I let in about one foot depth of water, disconnected the pump, and put the cap on. I never had any difficulty at all with that tank. I like the Rosendale cement because it sets so quickly.

Mr. McMillin—It will not set half as quickly as the Portland article.

Mr. Lansden—I have used Portland cement but very little.

Mr. Clark—Recently I read about the experience of a former Superintendent of the New Orleans (La.) Gas Light Company, gained while building a holder. The soil there is alluvial with quicksand below. He had almost reached the bottom when the quicksand began to pour in. He drove sheet piling down—do not remember to what depth. He got it finished one night, but the next morning he had three feet of sand there. He tried it again. Then the sheet piling that had been driven down began to rise. Bricks were hauled in and placed on top of the piling until there was a ton of weight to each foot. This kept the piling down, but still the sand was coming up, and the ground was lowering outside. The earth seemed to be seeking its own level. The tank structure was finally accomplished by taking out 20 feet at a time all round, and starting a man in with concrete the moment a particular section was ready. When a section was secured the sand did not give any trouble. No wall was built until the whole thing was bottomed. Putting in the concrete saved it. In the meantime, the diameter of the tank had been diminished by 14 inches. That tank never leaked. The water in that locality stands in the soil at a point within three feet of the surface; but after the tank was finished not a drop leaked in.

Mr. Thomas—I do not think, as a general thing, that the great difficulty in building tanks lies so much in the walls as it does in the bottoms, although I fully agree with everything that Mr. Spice has said in relation to their construction. A short time since I was called on to examine a tank which had been built in a wet, mucky place, and the tank bottom had been covered with only seven inches of concrete. Under the concrete a 10-inch pipe had been run in from the well on the outside of tank, extending under the wall three or four feet into tank. The well was on the side of a hill; and I suppose the point where the well discharged over the surface was probably ten feet below the tank coping. After the tank was built they pumped the water from well into it. The pipe leading from tank into well was about six feet above the well's bottom. When they commenced pumping the water over into the tank it was drawn from the bottom of the well; and as they progressed with the pumping sand made its appearance. In fact, they were simply pumping out the bottom from under the concrete. They had a sort of "perpetual motion" going on. After they had pumped the water up above the orifice of the well, of course, the fluid ran out. On taking up the tank bottom the mason work, concrete, etc., was found to be completely honeycombed. The water was running everywhere under it. After the bottom was made good, the pipe was plugged tight on the inside, and then water was pumped into the tank—care being taken to raise the pipe in the well so as not to pump from under the tank. After filling the tank with water this time it proved all right; and I think it is to-day as tight a tank as may be found in this country.

Mr. A. C. Wood—I have had some little experience in building gasholder tanks, having built several at our Syracuse (N. Y.) works, and have also done similar construction for other gas companies. I have in all cases succeeded in making a good job. One of the most important points is, as Mr. Spice remarked, to use good material. I once built a tank for a 100-foot gasholder, where the inside tank was 103½ feet, with about the dimensions Mr. McMillin spoke of in his specification. The ground was lower by 15 feet on one side of the lot than it was on the other. The excavation was in the bed of an old water-course. I had a good foundation until I began to approach the bottom of excavation, which was, of course, in gravel and boulders. As we uncovered the water came up in large quantities all through the bottom. It was not, according to the nature of the situation, expedient to there excavate an annular space; but I intended to leave a cone in the center about 15 feet high. We got it down to 6 feet, when along came a very rainy season, and the water almost flooded us at times. We were then obliged to suspend excavating and commence on the brickwork. I had about six feet head of water coming up from this gravel to counteract; and it would flow up to the six feet level in half an hour. Having plenty of boulders and cobble stones at hand, I built a wall to the outside of the work. That kept us free from the water. We put in the bottom concrete in four courses, each course being three inches thick. We built brick walls. About every seventh course we had a solid brick wall, with inside and outside courses of brick laid in mortar with tight joints. The bricks were pounded close together and grouting placed between. Nothing but square bricks were laid. Every course of brick was inspected—not only on the contract jobs, but also on our own. In that way we got a water-tight tank. I have succeeded in building tanks in that way without any trouble. I remember building a small tank on the side of a hill having a clay bottom—the blue clay being about two feet thick on top of the quicksand. The

water-course was at the foot of the bluff. We experienced some little difficulty there. If you can only confine quicksand you can build upon it as well as upon any other foundation. Another important point to be considered is the proportion of the material used. Mr. McMillin and several other gentlemen speak of using one-half hydraulic cement. I think that we are very apt to make our mortar too rich, and to depend too greatly upon the virtues of the hydraulic cement. We have a very good cement with us, and I have always used it in building our tanks. We employ what bricklayers usually term a "third," but it is really a "quarter"—one part of hydraulic cement and three parts of sand. With that we have always succeeded in getting a tight job.

Mr. Boardman—I have a great deal of faith in concrete holding water. I built a reservoir holding 2½ millions gallons of water, and lined it entirely with concrete. There is not a single break in it; it is as tight as can be. A roadway has been cut through the land within less than fifty feet of that tank, the roadbed of which is about three feet above the bottom of the reservoir; and in that roadway seldom is there seen any water leaking through. There is nothing but concrete in it; and the concrete was composed of one part of cement to four parts of gravel and sand.

Mr. Stedman—Lest some of our new members might be discouraged by hearing of the hardships the older members have been through in excavating and building tanks, I want to say that we put one up at Newport, R. I., thirteen feet below tide water, the base of brickwork being 20 inches thick, whilst the least thickness of same reached 16 inches. The tank was 102 feet six inches in diameter on the inside, and the bottom was covered with 8 inches of concrete. That was all the work that was done on it. It was perfectly tight from the first. In that excavation the annular system would hardly do, because we had to blast through about sixteen feet of solid rock. I suppose that even Mr. Spice will admit that the annular system of excavation would not have done there. I want to say with regard to the statement made just now about the absorption of water by brick, that we put cement on the surface of the bricks to prevent them from absorbing the water. The mason who built the tank for me had had quite an experience in building such work, but he insisted on putting two courses of bricks on the bottom, else he would not guarantee the tightness of the tank. I said if he would omit the bricks I would guarantee its tightness. I knew the quality of the cement was good, and there was no doubt it would be tight. Some one has spoken about water in a tank lowering two feet by reason of absorption of the fluid by the bricks. I should have suspicion regarding bricks of that sort.

On motion of Mr. Thomas, the thanks of the Association were tendered to Mr. McMillin.

[To be continued.]

The Formation of Coal.

According to the *London Journal*, Prof. Williamson, of Owens College, Manchester, England, on date of Monday, October 12, lectured (before an audience assembled in Palatine Hall, Lancashire,) on the above-named subject. The lecturer commenced by expressing his intention of placing before his audience the leading features of coal, so far as the present knowledge of it extended. He said they should remember that the rocks which they found in and about Lancashire, whether in quarries or elsewhere, were brought into their present position by the action of water. The transporting power of water to carry substances was entirely dependent upon the velocity of its motion—that was, when it had to deal with materials of the same relative weights. Coal was, however, something more distinct than those deposits from water—more than a mere accumulation of substance inorganic in origin. Long ago geologists knew that coal was of vegetable origin, and they could take this for granted; for if they found fragments of what had been leaves now converted into coal, they could readily understand heaps of leaves being converted in the same way.

They would now try to learn how coal reached its present position. Coal seams were found parallel to each other, with layers of rocks—it might be of shale or sandstone—between them. In Lancashire the coal seams belonged to the carboniferous series, and lay beneath the red sandstones of the vale of Eden and Cheshire, and above the limestone rocks of Craven and Derbyshire. Coal might be formed at any period of the world's history, but the great bulk of it belonged to the carboniferous age. How, they might ask, did the beds of coal assume their present position, and what had been the changes the vegetable masses had undergone. In the early part of the present century it was observed that the Mississippi, like other large rivers, overflowed its banks, covering vast areas of forest land, and depositing a large quantity of vegetable matter in the Gulf of Mexico, which would gradually become coal. Nothing was more natural than to suppose that what was taking place then took place also in bygone times; and that coal beds were so accumulated. But a serious difficulty arose with regard to this; for the vegetation brought down the rivers in that way must have accumulated in irregular lumps, very different to the way in which coal seams were found

—some, perhaps, being only six inches thick, and extending over hundreds of square miles in an uninterrupted course. It was thought that coal beds had been produced like peat; but, although this was not strictly true, there was no doubt that coal had been formed where it was still found. The latter fact was discovered by Sir William Logan, who noticed, while working in the South of London, that, wherever a bed of coal was found, there was beneath it a bed of blue clay of remarkable appearance, crammed with remains of plants called *stigmaria*. The next step in the solution of the problem was made during the construction of a railway from Bolton to Manchester, when, from discoveries made of forest trees, it became clear that this clay was a soil in which forests of these *stigmaria* trees grew. These trees threw down year by year masses of decaying vegetation, which, perhaps in the course of vast ages, had become coal.

The next question was how coal seams were formed in layers one above another. The lecturer then explained the depression of parts of the earth's surface (thus letting in water), the production of other layers of clay, and the consequent formation of other beds of coal. With regard to the changes this mass of vegetable matter had undergone to convert it into coal, they had to come in contact with chemistry. A chemical statement was made of the amount of hydrogen, carbon, oxygen, and nitrogen contained in wood fiber, Irish turf, Cologne lignite, Wigan cannel, Newcastle, Harley, and Welsh anthracite, in which it was shown that, although the quantity of hydrogen in all remained about the same, the carbon gradually increased, and the oxygen and nitrogen diminished, as they proceeded from the wood fiber to the anthracite. The great change that took place in the formation of coal was the escape of the gas and the increase of carbon. Speaking of the greater heat as they went lower into the earth, the lecturer said it could be accounted for by the great pressure from the outside; and thus this vegetable mass subjected to high pressure and temperature would change its appearance. Allusion was then made to the examination of coal under the microscope; and the lecturer dwelt at some length upon the different plants that had been found in coal. Included in these plants were the club moss, a detailed account of the structure of which was given; the fern, the conifer, and plants now only found in watery or marshy places, and forming the only known instances of fresh-water deposits in the coal of the present day. The ferns that were found in coal grew, he said, in many cases like the tree ferns which are now found in Australia, New Zealand, and other places, and the appearance of of them had never changed. Although he had been engaged for fifteen years in the study of plants found in coal, there were still large numbers of things of which he could not make out anything, but which he had no doubt would be discovered in time. Although very few plants were now brought to light below the Devonian system of rocks (and, according to Darwin, there must have been a vast array of vegetable life of lower origin yet undiscovered), it did not follow that, because they were not yet discovered, therefore they were not there; for he hoped that as they were now finding out new plants and new species, this would still more be carried out before many years had passed. Taken on the widest scale, the whole system of flora throughout the entire world seemed to sustain the theory of evolution propounded by Darwin.

Poisoning by Illuminating Gas.*

The *Sanitary Engineer*, in issue for November 5, explains that this is the inaugural thesis of its author, and is a very excellent *resume* of what is known with regard to poisoning by illuminating gas, to which is added the results of a number of experiments made by Dr. Bruneau upon the manner in which it produces death, and other experiments on the action of propylene upon animals.

The first chapter is devoted to the chemical composition of illuminating gas, giving the results of numerous analyses of the gas of different cities, and of that manufactured from different sorts of coal.

In the next two chapters Dr. Bruneau gives in detail the description of various experiments to determine the action of propylene, one of the constituents of illuminating gas, upon animal life. He shows that this gas is without poisonous action; in fact, in one of his experiments a guinea-pig breathed for some time a mixture of 25 per cent. oxygen and 75 per cent. propylene without apparent injury. The effects of the other constituents of illuminating gas are discussed, with reference to their poisonous effect upon animals, and it is shown that the only one of any importance, from this point of view, is carbonic oxide. This gas is present in illuminating coal gas in proportions which vary between 5 and 13 per cent. It adds little to the illuminating power of the gas, and one of the questions in practical hygiene is to find some means to remove it from illuminating gas without incurring too great cost. It has been suggested that this may be done by passing the gas through a solution of the proto-salts of copper.

[The fact that some of the "illuminants" in the gas are also absorbed by

* *Empoisonnement par le Gaz de l'éclairage*, par Paul Bruneau, 99 pp., 8vo. Paris: G. Carre, 1885.

proto-salts of copper would make the carrying out of this suggestion quite impracticable, even if there were no other difficulties in the way.—Ed.]

The presence of about one-half of one per cent. of carbonic oxide in air is sufficient to kill animals. Paralysis and other grave symptoms appear when the proportion is only one-tenth of one per cent.

Accidents due to illuminating gas may be caused either by the escape of the gas into the soil in the vicinity of the house from leaks or breaks in the street mains, or to openings in gas pipes in the house itself. When the leak is in the street it may penetrate the soil for long distances and be drawn into houses in cold weather through the cellar floors and walls by the aspiring force which the column of warm air within the house is constantly exerting through these surfaces on the gas contained in the surrounding soil. A very important point to be noted in this connection is, that in passing through a considerable distance in the earth illuminating gas loses all, or nearly all, of its characteristic odor, and thus it may be present in dangerous quantities without its presence being suspected. This fact has been observed in a number of instances, as, for example, in a case in Breslau where the gas had traveled 35 meters through the soil; there was no odor in the house, and the presence of the gas was doubted by the employees of the company.

Following the analyses of Biefel and Poleck, the statement is made that gas escaping under such circumstances shows that the hydrocarbons have disappeared in the proportion of 50 to 75 per cent., that the marsh gas is diminished one-half, the tarry vapors have been condensed and retained in the soil, while the carbonic oxide is found in somewhat relatively greater proportion than in the gas in the mains. After a time the soil becomes saturated, and if the leak goes on for several days the odor may become perceptible.

Accidents from illuminating gas are usually produced in cold weather—most frequently in the months of December and January—this being partly due to the aspiring power of warm houses already referred to, and partly to the fact that the gas does not readily escape upward through frozen soil. It is at this time of the year, also, that the most gas is consumed, and the gas issues from the gasometers at the works under much greater pressure than it does in summer.

The characteristic symptoms of poisoning by illuminating gas are those of poisoning by carbonic oxide. When the proportion present is small and the inhalation of the mixture goes on for some time, as may be the case for several days when the odor of the gas is not perceptible, the symptoms may be very much like those which occur at the beginning of an attack of typhoid fever. If illuminating gas is breathed pure, or nearly pure, the effects are almost like those of lightning—the person falls powerless and unconscious; he does not give a cry, and cannot open a window or break a glass to obtain fresh air. When diluted with air it sometimes produces vomiting and congestion, and is followed by paralysis, which, in the case of recovery, may last for a long time.

The work closes with the report of a number of cases of poisoning by gas, the regulations for gas lighting in Paris, and a very badly edited bibliography of the whole subject.

ITEMS OF INTEREST FROM VARIOUS LOCALITIES.

GAS MATTERS IN LONG ISLAND CITY, N. Y.—Mr. Chas. A. Kittle, General Manager and Superintendent of the East River Gas Light Company, of Long Island City, reports that the alterations and improvements to plant of company have been completed, and adds that the corporation is now in position where it can meet any demand likely to be made upon it by the gas consumers of the locality. About a twelvemonth was occupied in perfecting and carrying out construction details, and the work was thoroughly performed. Among the various things accomplished we note the following: A telescopic, non-trussed holder (with eight wrought iron columns) having a calculated capacity of 200,000 cubic feet, was put up by Messrs. Deily & Fowler, proprietors of the well-known Laurel Iron Works, with shops at Philadelphia, Pa. The tank excavation was made through a tough specimen of rock, but Messrs. Rowland & White, of Jersey City, N. J., are adepts in the matter of excavating for and building holder tanks, and their art did not forsake them at Long Island City. Manager Kittle should, and quite likely does, feel safer now than was the case with him some five or six years ago—or when he first assumed charge of the plant—as at that period he was obliged, for about three months, to supply gas to consumers without employing a holder at all. There was a nominal apparatus of that sort on the works, but it was better calculated to answer the purposes of a sieve than to store gas. The second item is a new purifying house, 36' x 68', and fitted up in the most complete style. Under the same roof is to be found the station meter room, in which an 8 x 8 meter was put up by the American Meter Company, of this city. The meter carries a "tell-tale," and the finish of the apparatus reflects great credit upon its manufacturers. One of Messrs. Con-

nolly & Co.'s automatic governors has also been installed, and Mr. Kittle is perfectly satisfied with its action. The water supply of works is derived from a six-inch artesian well, driven to a depth of 100 feet, and capable of supplying close to 60,000 gallons every 24 hours. The main system has been increased by the burying of over five miles of conduits, diameters of same ranging from 12 to 16 inches. The new plant went into duty on Friday, Oct. 16th, and no hitch of any sort occurred. The company is now equipped for an output of, say, one-half million cubic feet every 24 hours; and we hope that Mr. Wm. Steiway, the enterprising owner, or chief controller of the financial portion of the corporation's affairs, and Superintendent Kittle, as well, may shortly encounter that 24 hours when the maximum duty of the plant will be needed to meet the requirements of the gas consumers. In dealing with new consumers the manager offers to put in services, set meters, and make connections without charge for same. [The owners or managers of the smaller companies throughout the country might do well to make a note of that practice, for be it remembered Long Island City is not metropolitan in its proportions as yet. At any rate, it will not be the fault of her gas suppliers if her growth be retarded, since they are anxious to do what is right and fair by the people of the place in so far as the important questions of sufficiency and cheapness of artificial illumination are concerned.] The charge for gas to users of least quantity is scheduled at 20 cents per hundred cubic feet. We believe that a scale of discounts is in vogue there, but are not posted as to the figures. Take it all in all, the East River folks are to be congratulated upon the enterprise displayed, and there can be small doubt about the fact that substantial pecuniary return will be their just recompense.

ANOTHER REDUCTION IN PRICE OF GAS AT TORONTO, CANADA.—Mr. W. H. Pearson, Secretary of the Consumers Gas Company, of Toronto, has been authorized by his directors to give notice of another considerable reduction in the selling rates for gas in that city. It has been the policy of this company, or at any rate, from about the date of Mr. Pearson's accession to the Secretaryship, to share with its patrons its success in business. We believe the financial year of the Toronto company terminates on the 30th day of each September, and an examination of the accounts for 1884-5 disclosed such a satisfactory balance that it was determined this time to make a more than ordinarily liberal annual concession. In accordance with such determination, on date of November 3d, the following notice was published—prices being, of course, in quantities of one thousand cubic feet—the scale to take effect on quantities supplied from 1st day of last October:

	Gross.	Net.
To consumers of under 200,000 cu. ft. per annum....	\$2.00	\$1.25
“ “ over 200,000 “ “ aud under 500,000, 10 cents additional discount.....		\$1.15
“ “ over 500,000 cu. ft. per annum, 15 cents additional discount.....		1.10

The additional discount to both classes of largest consumers to be applied at the end of each year, or September 30th. Gas supplied to cooking stoves, engines, etc.—registered on separate meters—is scheduled at a gross figure of \$2, but the discount allowed on same, in consideration of prompt payment, makes the net price equal to *one dollar* per thousand.

In January, 1877, the all round charge for gas in Toronto was \$2.50 per thousand, a pretty heavy meter rent being also charged. This latter has been entirely done away with, even in those cases where gas is used for other purposes than lighting. In addition to the decreased charge, the Toronto consumers are in receipt of a gas that will average fully 25 per cent. higher in illuminating value than the article supplied in 1877. It is needless to say that this is progress, and there is not a gas maker in the United States who requires to be told that gas (to the user of the smallest quantity) at \$1.25 per M., at any point or locality of Canada, is cheap, and very cheap at that. Indeed, such result could only have been brought about by careful, judicious, and intelligent management. We understand the managers of the Toronto plant are making provision for a great increase in business, by the erection of large and improved apparatus, and we imagine the anticipation as to output will be more than realized. Truly, Mr. Pearson is "a man of business."

GAS VS. ELECTRICITY IN THE STATE CAPITOL BUILDING AND GROUNDS AT MADISON, WIS.—One of our correspondents residing in Madison, Wis., informs us that Governor Rusk, acting under the provisions of chapter 145, laws of 1885, has recently devoted much time and consideration to the subject of lighting the capitol building and grounds. [It may be here explained that Madisonians are justly proud of their State House—a beautiful stone structure erected at an expense of one-half million dollars.] The law provided that electric lighting be employed in case it could be done cheaper than gas could be contracted for. Propositions were submitted from four electric light companies, but only two were sufficiently definite whereon to

make an estimate of cost. Under one of these it appears that the annual cost would approximate to the following :

<i>Western Edison.</i>	
Cost of plant.....	\$19,960
Five per cent. interest on plant investment.	\$998.00
Seven per cent. wear and tear.....	1,397.20
200 tons coal.....	1,248.00
Labor.....	1,200.00
Oil, waste, etc.....	290.00
Breakage.....	905.00
Total.....	\$6,038.20

The other reducible proposition footed up as follows :

<i>Brush System.</i>	
Cost of plant.....	\$16,187.50
Interest at 5 per cent.....	\$809.37
Wear and tear.....	1,133.12
Labor.....	1,200.00
Fuel.....	1,248.00
Oil, waste, carbons, etc.....	1,195.00
Total.....	5,585.49

The Madison City Gas and Coke Company, in competition, made a proposition to furnish gas in quantities aggregating two millions cubic feet per year, which will adequately light the building and grounds, at the rate of \$1.75 per thousand cubic feet, without charge for meter rents. Of the three propositions it is quite easy to determine the one most advantageous to the interests of the State, since the gas supply would cost annually but \$3,500, or show a saving of close to \$2,100 per annum over the cheaper of the above itemized propositions of the electrical promoters. Our correspondent further adds that, "besides being more economic, the use of gas is certainly the more convenient, and its continued employment means the saving from disuse of all the valuable fixtures and connections with which the building is equipped. In the above estimates as to probable cost of installing an electric service a large sum that would have to be expended in extending coal vaults, enlarging boiler and engine rooms, defacing building, etc., are not considered. In fact, careful calculators agree that cost to put in a complete system of electric lighting would not fall far short of \$28,000." If the provisions of the law governing the lighting of the Wisconsin State House are regarded, it is hard to see on what basis (supposing the above to be lowest figures which they can present) the electrical promoters rest their hopes of ousting the Madison gas men.

DOINGS OF THE SIOUX CITY (IOWA) GAS LIGHT COMPANY.—Within the past five years the population of Sioux City has almost trebled in number—from 7,000, in 1880, to over 20,000 in 1885—and this rate of increase obliged the directors of the gas company there to be up and doing. Last spring the gentlemen in charge authorized Treas. and Supt. Kellogg to "put their house in order," and some short while back Brother K. reported back to headquarters that he had, among other things, in accordance with instructions, erected a new purifying house, 26' × 35', and equipped the same with four cast iron boxes, each 6½' × 11 feet; a new bench of sixes, heated by improved furnaces; a new Connelly & Co. 8-inch automatic governor, with 6-inch by-pass; ending up, as far as the manufacturing plant was concerned, with a general overhauling of connections, etc. Distribution facilities were increased by the addition of three miles of cast iron mains, and those already in use were carefully examined at all doubtful points. With these matters attended to Supt. K. and his brother officers are ready to vanquish the darkest afternoon and evening that will visit Sioux City during wintriest days of '85 and '6.

ELECTRIC WIRES DID NOT CAUSE THE FIRE IN STEAMSHIP WAESLAND.—In our item columns of issue of Oct. 16th mention was made of a slight fire that occurred aboard the steamship Waesland during one of her voyages between Antwerp and New York. It was there said that electric lighting wires were responsible for the damage which ensued; but subsequent investigation proves that statement to have been an error. The chief officer of the steamer (the Waesland left this port for Antwerp on Saturday, Nov. 7th) informed the writer that the vessel was lighted by oil lamps and sperm candles; that electric illumination had never been employed on board; and, finally, that electric appliances were not used in connection with the ship's steering apparatus. He seemed decidedly averse to making any mention of the real cause of fire; and, in fact, did not openly admit that such an untoward event occurred. The item on which we based our remarks was forwarded in the regular way by a correspondent who is a thoroughly straightforward and reliable gentleman; and in answer to our query regarding the source of his knowledge, he explained that his informant in the premises

was the American *Exchange and Review*, published in Philadelphia, Pa., and everywhere recognized among the insurance men of the United States as a standard authority on their business.

THERE IS NO MISTAKE IN THIS CASE.—An exceptionally severe southwest storm of wind and rain visited this section on date of Thursday, October 29th, and, as is the usual experience during the progress of such visitations, the electric lighting wires were more or less disturbed. No accident of any moment is reported as having occurred in New York city, where great vigilance is exercised by the electrical promoters in looking closely after service conduits; but in the sister city of Brooklyn a different state of affairs is reported. The premises Nos. 43 and 45 Fulton street are occupied by a tailor, named Rosenberg, and this tradesman maintains an arc light in front of his show windows. At about 11 o'clock on the night above noted the canvas awning over sidewalk took fire, and a passer-by climbed up one of the awning frame poles with the intention of extinguishing the blaze. He made his way to the desired spot, and, possibly to prevent a stumble, seized hold of the object nearest him, which happened to be the electric conduit feeding the carbon below. The shock threw him down, and he fell in such a manner that his arm rested on the wire. When rescued the sufferer was unconscious, his arm was badly lacerated, and blood was gushing from mouth and nostrils. He was removed to the Long Island College Hospital, but the injuries received were so great that his death ensued on the evening of the following Sunday. Deceased was identified as Michael Clifford, of No. 5 Hicks street, Brooklyn. An examination of the wire showed that, as a consequence of chafing, the insulating material had worn thin, and the action of the elements completed the rupture. The damage done to premises was slight. On the same night the wooden framework of a show window at building No. 255 Fulton street was set on fire in similar manner. The damage was slight. Other trifling accidents were also reported. There can be no doubt as to the necessity of speedy action in the matter of enforcing the underground placing of electrical conduits; and despite the appointment of commissions to determine how best the work can be accomplished, we seem now to be almost at a greater length than ever from a probable solution of the difficulty. The stormy periods sure to be witnessed during the coming winter and spring seasons may be counted on to once more emphasize the evil of attempting further procrastinatory legislation. The dangers are admitted; the remedy is evident.

COTTAGE CITY, MASS., WILL PROBABLY HAVE A GAS COMPANY.—Cottage City, Marthas Vineyard, wants a gas company, and it is said that attempts are now being made to secure the desired capital. We understand that about \$10,000 will be sufficient wherewith to start the enterprise on the scale proposed.

A COMBINATION AMONG THE "CARBON POINT" MANUFACTURERS.—A despatch from Pittsburgh, Pa., says that the manufacturers of carbon points held a meeting at the Forest House, Cleveland, Ohio, on Thursday, the 29th ult., the object of the conclave being the formation of a "protective association." Beyond the mere statement that while they confessed business was decidedly active during the year, and plenty of "points" were disposed of (it was asserted that such sales were owing to the closeness of competition, unproductive of profit), and that the question of advancing rates were about the principal topics discussed at the "convention," we are unable to give precise details of the action taken.

CHANGE OF OFFICIAL DESIGNATIONS.—Hereafter Mr. E. McMillin will be officially known as Engineer and General Manager of the Columbus (Ohio) Gas Company; Mr. Wm. Enfield becomes Superintendent of Works; and Mr. Fred. J. Day assumes the duties of Superintendent of Distribution.

NEW GAS COMPANY.—A gas company has been chartered to operate in the town of Charlotte, Mich. Charlotte is the capital of Eaton County, is located at the junction of the Chicago and Lake Huron and Grand River Valley Railroads, and is about 59 miles east of Grand Rapids.

NATURAL GAS AT TOLEDO, OHIO.—Capitalists in the vicinity of Toledo, Ohio, are interested over the natural gas question, although it cannot truthfully be claimed that much practical encouragement has as yet been vouchsafed them through the success so far met with. The chief boring operation developed gas when at a depth of between fourteen and fifteen hundred feet, but the flow was far beneath the expectations of its owners. The output was probably close to 40,000 cubic feet each 24 hours. This result, however, does not seem to have disheartened the prospectors, since they have determined to sink another well at a point about two miles south of the one above mentioned. The new location is on the line of territory in which the Findlay and Bowling Green wells are situated.

PERSONAL.—Mr. Adam Weber, proprietor of the Manhattan Fire Brick Works, New York city, has returned from his European trip much improved

in health. During his stay in Europe he was the recipient of many courtesies, among which we may note a dinner given for his entertainment by the Continental Association of Gas Engineers. The festive event was celebrated in Munich.

IT WAS A WORK OF NECESSITY.—Police officer M. J. Casey, of this city, on the afternoon of Sunday, Nov. 8, awoke to his importance while patrolling through Broadway between 32d and 33d streets, and decided that John Nelson, a foreman in charge of a gang of laborers then making repairs to a line of gas pipe running through the roadway at the point above indicated, was responsible for too great a breach in the orthodox rules for observing the Sabbath. Accordingly foreman Nelson was arrested, and on Monday was arraigned before the presiding magistrate at Jefferson Market police court. General Charles Roome, President of the Consolidated Gas Company, was in attendance, and made affidavit that the work on which Nelson and his men were engaged was a necessity, whereupon defendant was discharged. Thus it would appear that officer Casey, in his interpretation of the Penal Code, was slightly in error.

BROCKTON, MASS., HAS AN ELECTRICAL EXPERIENCE.—At about 8 o'clock on the evening of Saturday, October 24, the good people of Brockton were thronging the shops intent on their usual Saturday evening purchases, the promenades were crowded, and Brockton's electric lights (Edison system) were at their best—which of course is not saying much for them. Without the slightest premonition the purchasers and sellers and promenaders were treated to a "display of darkness;" although that assertion might be slightly modified in respect to the delegations who happened to be in establishments where gas still held sway. The city rink had one of the largest crowds of the season on its floors; and at the Peoples Theater a large audience was listening to the "Chimes of Normandy;" both places patronized the electric light company, and hence were left in darkness. All sorts of improvised methods of illumination were resorted to, and, as might be supposed, the electrical suppliers were loudly condemned. An official of the Edison Company explained the eclipse with the statement that "the whole trouble was caused by a leak in the Elm street main. They could not find it, and in order to make an examination had to shut off the northern circuit, too." All of which, no doubt, will go a great length in satisfying the shopkeepers of Brockton!

BUT IT WAS ONLY AN EXPERIMENTAL STATION.—Of course, the above occurrence attracted attention from the residents of the neighboring towns, but more especially did it receive the notice of those dwelling in localities where the electricians are now putting in plants. At New Bedford Mr. C. R. Price, in charge of the local Edison corporation, was appealed to for information as to the likelihood of such an event happening there. He greeted the inquirers with the statement that the Brockton station had always been regarded as an "experimental" station. He admitted that similar "accidents" had occurred in Brockton before, and would likely occur there again; but in Lawrence and New Bedford these happenings were outside the pale of possibility. It was the experience gained at Brockton that enabled them (the electricians) to do perfect work at other points, etc., etc. And we would submit it is rather rough on the Brocktonites that they should be obliged to put up with such explanations, and "pay the piper" besides. Surely, if the scheme is found to work satisfactorily at other points, would it not be fair to remove Brockton from the realm of experimentation? The bare truth about Brockton is this—it is not nearer to nor further from the experimental stage, in regard to its "electric station," than any other city or town in the country which now harbors those interested financially in the development of electric lighting establishments.

ANOTHER GAS CONSUMERS BENEFIT COMPANY.—Among the recent certificates of incorporation filed at Albany, N. Y., we note one that gives birth to the "Gas Consumers Benefit Company," of Long Island. The incorporators are S. W. Knowles, H. L. Favis, E. H. Brown, D. Birdsall, and R. F. Brown. The concern is capitalized at \$100,000, and principal office of company is to be located in Brooklyn. Its objects, as set forth, are the "manufacture and sale of gas fixtures, gas burners, and other machinery and appliances for the utilization of gas for light, heat and power."

POISONED BY INHALING GAS.—The following cases are reported: At Charlotte, N. C., on night of Oct. 26th, W. O. Moore, of Chester, S. C., accompanied by a female, registered at the Central Hotel, and both were shown to a room. At 4 o'clock following morning the smell of escaping gas attracted the attention of a porter, and the escape was traced to apartment occupied by Moore and his companion. Investigation developed the fact that Moore was dead, while the woman, though unconscious, was still alive. The physicians summoned said she would probably recover. A defective burner key was responsible for the gas escape. On morning of October 28th John W. Piper, of Franklin Falls, N. H., owner of an orange grove in South Florida, and at the time above mentioned an inmate of the Grand View Ho-

tel, Jacksonville, Fla., was found in an insensible condition in his apartment. The room was filled with gas that had escaped from a turned-on burner. His recovery was looked upon as doubtful. "At Baltimore, Md., on date of Nov. 6th, John Knell, with his family, consisting of wife and three children, were found at their home on St. Mary street, all (except a son) apparently dead. They were affected by escaping gas. Elizabeth, aged 13, the second daughter, is dead, and Mary, the elder daughter, is in a precarious condition. Mr. Knell, his wife, and the boy are likely to recover."—N. Y. Sun, Nov. 7.

Correspondence

[The JOURNAL is not responsible for the opinions expressed by correspondents.]

Mr. Allen Advertises the "Allen-Harris Process."

CITIZENS GAS COMPANY, POUGHKEEPSIE, N. Y., Oct. 30, 1885.

To the Editor AMERICAN GAS LIGHT JOURNAL:

You have from time to time referred to me as "Mr. Allen, of Poughkeepsie," and "Friend Allen," to which I do not by any means object, and only hope that you may never have occasion to refer to me in any other terms than those of friendship. But I desire to say that I am not "engaged on the work of amusing others (if not himself) with comparisons as to the relative dangers of water and coal gas." It has not been a matter of mere amusement for me in attempting to write intelligently upon the very important practical and scientific subject of the manufacture of gas for illuminating and heating purposes. I have endeavored to give some information in relation thereto. You are mistaken in saying that "he has turned his attention to the matter of proving that marsh gas is one of the most deadly poisons known to the toxicologist." I stated that marsh gas was more dangerous to life and health than carbonic oxide, against which so much has been (very unjustly) said. I showed that light carburetted hydrogen, or marsh gas, the basis of coal gas, is the same gas as that which is found in the bottoms of wells and in mines, and that it would not sustain life for a minute—it being an entirely irrespirable gas. I did not say "poisonous." I further stated that carbonic oxide had been used for years as an anæsthetic, its action being similar to that of chloroform; showing that carbonic oxide is not an irrespirable gas, but may be breathed without unfavorable results. To sustain my statements I quoted such famous authorities as Dr. M. Ozanam, M. G. Tourdes, Adam Wurtz, Leblanc, Devergie, and others, who have safely used carbonic oxide as an anæsthetic upon man and the lower animals. Dr. Ozanam says: "The twenty-five experiments which we made, and several of which have been repeated upon the same animals, show that the use of this gas is not as dangerous as was formerly believed, since we have but one case of death among many animals so delicate as rabbits." M. G. Tourdes says: "The two fundamental facts are the harmlessness of the gas used, and its anæsthetic action." In comparing the effects of carbonic oxide with gas from coals, Leblanc and Tourdes found that when carbonic oxide was purposely used to produce fatal results upon animals, 12 per cent. mixed with air killed rabbits in seven minutes, and that 2 per cent. of coal gas killed such animals in twelve minutes—which is as 84 to 24 in favor of carbonic oxide. These are important facts, and fully sustain my statement, heretofore made, that carbonic oxide is not as dangerous to life and health as coal gas. I fully agree with you that the mere statement of these matters "will fall short of transmitting his (my) name to posterity."

In referring to my statement that we have "purified an average of 113,000 cubic feet per bushel of ordinary slacked lime—no other process has ever approached such results—the highest average obtained by the largest and best coal gas companies has fallen short of 5,000 cubic feet," you exclaim, "Oh! Mr. Allen!" which was a very mild way of expressing doubt as to the truth of such statements. We have indubitable proof of what we have done in that respect. As to what the "largest and best coal gas companies have done," I took the report of Prof. Love, expert gas chemist, of New York, in relation to the average quantity purified by the Manhattan Gas Light Company, the Metropolitan, etc., as published, I think, in your own columns, which I considered good authority.

You call my attention to repeated cases of death from water gas made under the Lowe and other water gas processes. I have nothing to say in relation thereto, unless it be, that if such cases are really exceptional under similar circumstances with coal gas, death must have resulted from impurities in the gas produced by internal, intermittent, and changeable heats, and not from pure water gas as produced under the Allen-Harris process. We have pursued, for more than ten years, our original system of uniform, high external heats, and continuous production of gas, and, by practical working, have perfected our process, as shown by three new letters patent for improvements obtained by us during the past few months. People have been exceptionally exposed to the effects of our gas without a single case of death, or even one day of illness.

If I should say that instead of drawing our retorts once even in eight days, as heretofore, we have not, under our present system, drawn them or lowered their temperatures since we fired them on the first of October of last year, and that we do not expect to draw them during the coming winter, nor until the furnaces require repairing, you may be more surprised than at my stating that we had purified 113,000 cubic feet of gas per bushel of ordinary slacked lime; but nevertheless it is true, and we extend to you a hearty invitation to come and examine our works for yourself.

Still the main point covering all these matters relating to coal and water gas is, "How do customers like the gas furnished; and the bills when presented?" The electric light company's managers have worked here for six months past, but have only 15 lights among our consumers—two of which are put where no gas was used before—while they have 50 or more among the old Poughkeepsie Company's patrons, and who, I think, have been furnished with as good gas as is usually made under the old process. This tells more than words in favor of the "Allen-Harris water gas," which gives a pure, brilliant, uniform, white light, and consumers are satisfied.

A. L. ALLEN.

The Market for Gas Securities.

During the fortnight transactions in Consolidated gas were on a large scale, and at the time of writing (noon of Oct. 31) quotations for same show that the upward movement still progresses—sales being recorded at 104½, with bid and asking prices at 104½ and 105 respectively. Those of our readers who followed the advice, steadfastly given in this column, to buy Consolidated have no reason to grumble at the result, and we urge those who hold the shares not to relax their grip. The security is a "good thing," even at present figures. Other city shares are fairly steady. Brooklyn gas stocks are dull and strong. The old Brooklyn Company's regular semi-annual dividend of 6 per cent. is payable to-day. Chesapeake, of Baltimore, Md., is offered at 62, and that asking price seems to be ridiculously high. Consolidated of same city is rated at 44 to 45. At auction, on Nov. 4th, 58 shares Ithaca (N. Y.) gas at 53½; 52 shares Cincinnati (Ohio) gas at 184½; 30 shares Citizens, Brooklyn, N. Y., at 90; and one share Metropolitan, same city, at 96. This last stock seems to us to be a decided purchase at the market rate.

Gas Stocks.

Quotations by Geo. W. Close, Broker and Dealer in Gas Stocks,

16 WALL ST., NEW YORK CITY.

NOVEMBER 16.

All communications will receive particular attention.

The following quotations are based on the par value of \$100 per share.

	Capital.	Par.	Bid	Asked
Consolidated.....	\$35,430,000	100	104½	105
Central.....	440,000	50	60	70
" Scrip.....	220,000	—	47	57
Equitable.....	2,000,000	100	134	137
" New Stock....			123	125
" Bonds.....	1,000,000	—	107	110
Harlem, Bonds.....	170,000	—	—	—
Metropolitan, Bonds....	658,000	—	113	—
Mutual.....	3,500,000	100	134	135
" Bonds.....	1,500,000	1000	104	107
Municipal, Bonds.....	750,000	—	—	—
Northern.....	125,000	50	50	—
" Scrip.....	108,000	—	—	—
Gas Co's of Brooklyn.				
Brooklyn.....	2,000,000	25	125	130x
Citizens.....	1,200,000	20	88	90
" S. F. Bonds....	320,000	1000	106	110
Fulton Municipal.....	3,000,000	100	158	159
" Bonds.....	300,000	—	104	108
Peoples.....	1,000,000	10	86	87
" Bonds.....	290,000	—	105	110
" ".....	250,000	—	90	95
Metropolitan.....	1,000,000	100	95½	96½
Nassau.....	1,000,000	25	128	—
" Ctfs.....	700,000	1000	101	102
Williamsburgh.....	1,000,000	50	162	—
" Bonds... ..	1,000,000	—	111	114
Richmond Co., S. I.	300,000	50	64	75
" Bonds.....	40,000	—	—	—
Out of Town Gas Companies.				
Buffalo Mutual, N. Y.	750,000	100	80	85
" Bonds... ..	200,000	1000	95	100
Citizens, Newark.....	918,000	50	103	115
" " Bonds.	124,000	—	105	110
Chicago Gas Co., Ills. ...	5,000,000	25	130	140
Peoples G. L. & C. Co.,				
Chicago, Ills.....			8	12
Cincinnati G. & C. Co. .			184	187
Consolidated, Balt.	6,000,000	100	44	45
" Bonds... ..	3,600,000	—	107	107½
Chesapeake, Balt.			—	62
Central, S. F., Cal.			58	63
Capital, Sacramento, Cal.			54½	56
Hartford, Conn.	750,000	25	132	138
Jersey City.....	750,000	20	135	140
Laclede, St. Louis, Mo. .	1,600,000	100	97	100
Louisville, Ky.	1,500,000	50	95	100
Montreal, Canada.....	2,000,000	100	181	182½
New Haven, Conn.		25	166	170

Advertisers Index.

	Page
GAS ENGINEERS.	
Jos. R. Thomas, New York City	220
Wm. Henry White, New York City.....	274
Wm. Farmer, New York City.....	264
GAS WORKS APPARATUS AND CONSTRUCTION.	
James R. Floyd, New York City	275
T. F. Rowland, Greenpoint, L. I.....	275
Delly & Fowler, Phila., Pa.....	275
Kerr Murray Mfg. Co., Fort Wayne, Ind.....	275
Stacey Mfg. Co., Cincinnati, Ohio.....	275
Bartlett, Hayward & Co., Baltimore, Md.....	275
Morris, Tasker & Co., Limited, Phila., Pa.....	274
Davis & Farnum Mfg. Co., Waltham, Mass	276
Tanner & Delaney Engine Co., Richmond, Va.....	274
R. D. Wood & Co., Phila., Pa.....	274
Southwark Foundry and Machine Co., Philadelphia, Pa.....	274
PROCESSES.	
National Gas Light and Fuel Co., Chicago, Ills	267
Burdett Loomis, Hartford, Conn.....	267
GAS AND WATER PIPES.	
A. H. McNeal, Burlington, N. J.....	272
Gloucester Iron Works, Phila., Pa.....	272
Warren Foundry and Machine Co., Phillipshurgh, N. J.....	272
Melfert Foundry and Machine Co., Reading, Pa.....	272
Cincinnati and Newport Iron and Pipe Co., Newport, Ky.....	272
Fox & Drummond, New York City.....	272
Ohio Pipe Co., Columbus, Ohio.....	272
SCRUBBERS AND CONDENSERS.	
G. Shepard Page, New York City.....	273
REGENERATOR FURNACES.	
Charles F. Dieterich, Baltimore, Md.....	176
GAS ENGINES.	
Schielcher, Schumm & Co., Phila., Pa.....	280
Clerk Gas Engine Co., Phila., Pa.....	268
GAS REGULATOR.	
Helme & McIlhenny, Phila., Pa	266
RETORTS AND FIRE BRICK.	
J. H. Gautier & Co., Jersey City, N. J.....	270
B. Kreischer & Sons, New York City.....	270
Adam Weher, New York City.....	270
Laclede Fire Brick Works, St. Louis, Mo.....	270
Brooklyn Retort and Fire Brick Works, Brooklyn, N. Y.....	270
Borgner & O'Brien, Phila., Pa.....	270
Wm. Gardner & Son, Pittsburgh, Pa.....	270
Henry Maurer, New York city.....	270
Chicago Retort and Fire Brick Works, Chicago, Ills.....	270
Baltimore Retort and Fire Brick Co., Baltimore.....	270
Standard Gas Retort and Fire Brick Co., Ironton, Ohio.....	270
Oakhill Gas Retort and Fire Brick Co., St. Louis, Mo.....	270
Evens & Howard, St. Louis, Mo.....	264
CEMENTS.	
C. L. Gerould, Manchester, N. H.....	266
Brooks, Shoochridge & Co., New York City.....	266
E. Thiele, New York City.....	266
Howard Fleming, New York City.....	266
GAS STOVES.	
American Meter Co., New York and Philadelphia.....	271
The Goodwin Gas Stove and Meter Co., Phila. Pa.....	252
GAS METERS.	
Harris, Griffin & Co., Phila., Pa.....	278
American Meter Co., New York and Philadelphia.....	279
The Goodwin Gas Stove and Meter Co., Philadelphia, Pa.....	279
Helme & McIlhenny, Phila., Pa.....	279
Maryland Meter and Mfg. Co., Baltimore, Md.....	278
D. McDonald & Co. Albany, N. Y.....	279
Nathaniel Tufts, Boston, Mass.....	278
EXHAUSTERS.	
P. H. & F. M. Roots, Connerville, Ind.....	269
Smith & Sayre Manufacturing Co., New York City.....	274
Willraham Bros., Philadelphia, Pa.....	276
GAS COALS.	
Penn Gas Coal Co., Phila., Pa.....	277
Perkins & Co., New York City.....	276
Newburgh Orrel Coal Co., Baltimore Md	277
Despard Coal Co., Baltimore, Md.....	277
Chesapeake and Ohio R.R. Coal Agency, N. Y. City.....	277
Westmoreland Coal Company, Phila., Pa.....	277
Monongahela & Peters Creek Gas Coal Co., Pittsburgh, Pa.....	277
GAS ENRICHERS.	
Forest City Naphtha Co., Cleveland, Ohio.....	267
VALVES.	
Ludlow Valve Manufacturing Co., Troy, N. Y.	272
John McLean, New York City.....	272
GAS LAMPS.	
Siemens Regenerative Gas Lamp Co., Philadelphia, Pa.....	273
G. Shepard Page, New York City.....	249
Albo-Carbon Light Co., Newark, N. J.....	266

GAS KILNS AND OVENS.

Thompson Gas Kiln and Oven Co., New York City..... 269

PURIFIER SCREENS.

John Cabot, Lawrence, Mass..... 266

STREET LAMPS.

J. G. Miner, Morrisania, New York City..... 269
Bartlett Street Lamp Mfg Co., New York City..... 269

BURNERS.

G. Gofrorer, Phila., Pa..... 274
G. Taylor, New York City..... 267

PURIFYING MATERIAL.

Connelly & Co., New York City

STEAM BLOWER FOR BURNING BREASE.

H. E. Parson, New York City..... 238

PIPE COVERINGS.

Ghalmers-Spence Company, N. Y. City..... 267

GAS FIXTURES.

Mitchell, Vance & Co., New York City..... 269

STEAM PUMPS.

A. S. Cameron Steam Pump Works, N. Y. City..... 269

SHAFTING, PULLEYS, ETC.

A. & F. Brown, New York City..... 267

STEAM ENGINES.

Westinghouse Machine Co., Pittsburgh, Pa..... 277

PIPE WRENCH.

J. H. Williams & Co., Brooklyn, N. Y..... 266

HYDRAULIC MAIN.

A. E. Boardman, Macon, Ga..... 269

BOOKS.

The Chemist's Assistant..... 264
King's Treatise..... 279
Scientific Books..... 278
Management of Small Gas Works..... 278
Newhigging's Gas Manager's Handbook..... 270

Position Wanted,

As Traveling Salesman to Sell to Gas Companies.
Has traveled two years selling gas retorts in Missouri, Illinois, Iowa, Wisconsin, and Minnesota. Best of references given.
Address GEO. O. DAYTON,
634-t 1917 Papin Street, St. Louis, Mo.

TO GAS COMPANIES
CONTEMPLATING ENLARGEMENT

The Grand Rapids Gas Company will offer for sale in 1886 a Complete Ten-Inch Plant for making coal gas.
Grand Rapids, Mich., Oct. 6, 1885.

WM. FARMER, ENGINEER,
32 Park Place, Room 36, New York.

THE CHEMIST'S ASSISTANT; OR, KINDERGARTEN SYSTEM OF CHEMISTRY.

A system by which the elements and their valences are represented by illustrations and solid bodies.
BOX AND PAMPHLET COMPLETE, \$2.50.

EVENS & HOWARD,

916 Market St., St. Louis. Mo.
Works, Howard Station, Mo. Pacific R.R.

Fire Brick, Gas Retorts

AND
RETORT SETTINGS.

Sewer Pipe, 3 to 24 in. diameter.
Glass Pot Clay, Ground Fire Clay, in barrels and in bulk. All kinds of Fire Clay Goods.

Iron Sponge,
GAS EXHAUSTERS,
AUTOMATIC GAS GOVERNORS,
CONNELLY & CO., Limited,
No. 407 BROADWAY, NEW YORK CITY.

CONNELLY'S AUTOMATIC GOVERNOR FOR STREET MAINS.

We give herewith a few late letters from gas companies using our Governor, and also a cut (exact reproduction) of two pressure sheets from the Quincy (Ill.) Gas Works. A careful inspection of the cut will reveal more concerning the Governor's accuracy and reliability than we could express in all the columns of the JOURNAL. It shows clearly that the Governor is endowed with more than human intelligence, and fully verifies a late remark of a certain "Western Member"—"Connelly's Governor is brains in iron." At Quincy the stores close early, and on all week nights excepting Saturday the Governor begins to reduce the pressure at about 8:30 P.M.; but on Sunday evening (when the consumption is so light that the Governor puts on only 19-tenths pressure) it is *one-half hour later* beginning to reduce—its action being the reverse of that followed by nine out of ten intelligent managers under the same circumstances or conditions. Although the consumption is much less on Sunday nights than on others, the volume per hour remains the same until 9 o'clock, when the church lights are extinguished. The Governor thus shows a finer discrimination than human intelligence is capable of. We do not boast of what our Governors "can" or "will" do, but submit evidence of **WHAT THEY ARE DOING!** We now have 43 of these machines in practical operation, and experience has taught us that a machine so delicate and sensitive in its construction, liable to be placed under such widely varying conditions, *cannot be perfected on paper.* Our late improvements enable us to send out a Governor to *any works*, capable of being adjusted to any possible conditions or requirements after it is in place. A 20-inch Governor can be sent to one works and adjusted to hold 3-tenths day and 40-tenths night pressure, and its duplicate or counterpart may be sent to another works having same consumption and initial pressure, and be set to hold 10-tenths day pressure and 11-tenths night pressure—both working perfectly as desired. Such range of adjustment is absolutely necessary in an Automatic

Governor, not only to secure the desired action in the beginning, but to be prepared to meet the new conditions sure to follow the building of a heavier holder or a large increase in capacity of the mains. No Governor in this country or abroad, in use or illustrated on paper, is constructed with such a range of adjustment, and to secure it would require a radical change in principle.

Another important feature of our Governor *not found in others* is the *absolute impossibility of the valve sticking in its seat* and shutting off the gas. We do not permit the valve to *enter* its seat; it is so constructed that it bears at *right angles* on a knife-edge seat, and *must* fall away from it when its supporting pressure is reduced in the least degree. The great value of this feature will impress itself on the careful Gas Manager. In short, our experience has enabled us to meet every possible requirement in Automatic Governors (as the accompanying letters attest), and we can unhesitatingly guarantee every Governor sent out to give perfect satisfaction in every respect, or will remove same at our expense. It is useless for us at this late day to waste any words on the *economy* and *satisfaction* derived from such a machine; and no progressive Engineer or Superintendent would to-day plan a works without locating an Automatic Governor. As they are finely finished and highly ornamental, their proper place is in the Office or Meter Room. As one of these Governors will *save its cost* in a short time, no company should hesitate to place one. The more perfect distribution and satisfaction given consumers are additional advantages that cannot be estimated in dollars and cents. We publish below a few letters, and will publish others in the following numbers of the JOURNAL.

CONNELLY & CO., Ltd., 407 Broadway, N. Y.

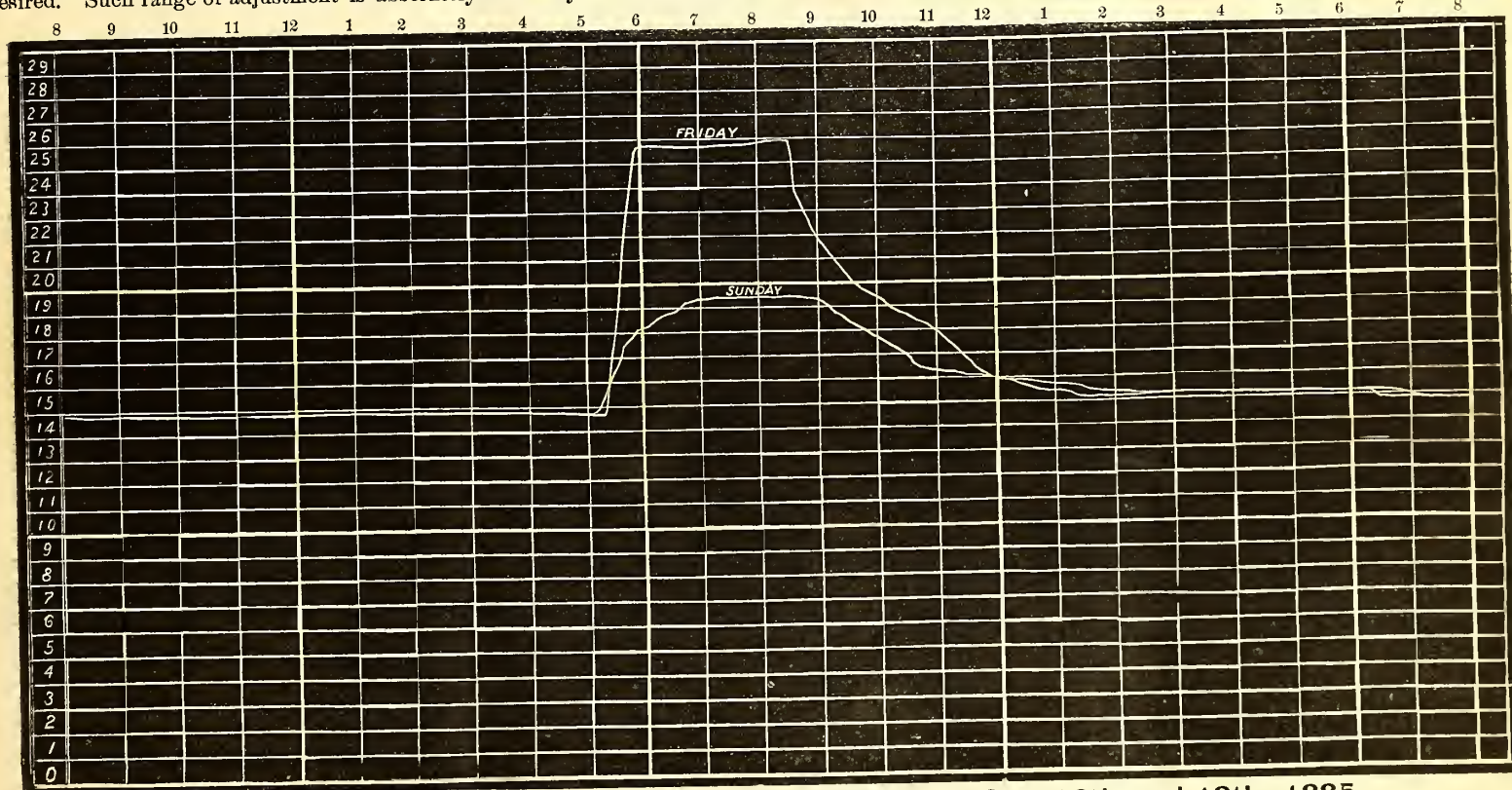

Card Showing Pressure at Quincy (Ill.) Gas Works, for Oct. 16th and 18th, 1885.

Quincy, Ill.

QUINCY GAS LT. AND COKE CO., QUINCY, ILL., Oct. 21, 1885.

Messrs. CONNELLY & Co.—Gentlemen: Yours of 27th is at hand. You are at liberty to use the pressure sheets in the way you wish, and also my name in testifying to the merits of the Connelly Governor, as *I cannot say too much in its praise.*

Yours very truly, A. W. LITTLETON.

Long Island City, N. Y.

EAST RIVER GAS LT. CO., LONG ISLAND CITY, N. Y., Nov. 11, 1885.

Messrs. CONNELLY & Co.—Gentlemen: Replying to yours of 10th inst., I would say that the 16-inch Governor furnished by your firm has afforded me infinite relief from the anxiety always felt regarding conditions of pressure in our mains. Heretofore we have had to rely upon such humanity as is generally found about all medium-sized gas works—the reliability of which most men connected with the gas business are familiar with; but now we have become perfectly satisfied that when any demand is made, either day or night, let it be large or small, it will be instantly met. Behind our Governor we carry full holder pressure—52-tenths; before it our minimum pressure is 15-tenths, and the maximum 30-tenths. We allow the Governor to govern us, and find that our rules have been altered by it. It takes off pressure sometimes as early as 9 o'clock, giving the varying pressure needed until, at 12:30, it stands at the minimum point. On Sunday night it elects to give us only 20-tenths, instead of maximum 30-tenths; and it is allowed to do so, as its judgment of what is needed is perfect. Close watching during a storm will convince anyone how sensitive it is, and how quickly it answers the varying conditions caused by the wind, and by its watchfulness always maintaining a steady, even pressure at the point required. In fact, the instrument is far in advance of any other used for a like purpose that I know of.

Yours truly, C. A. KITTLE, General Manager.

Cleveland, Ohio.

PEOPLES GAS LT. CO., CLEVELAND, OHIO, Nov. 9, 1885.

Messrs. CONNELLY & Co., LTD.—Dear Sirs—Yours of the 6th came duly to hand. With reference to the Governor, in view of my short experience with it (only about three weeks) perhaps I ought to be modest in expressing an opinion; but from the standpoint of experience I feel justified in saying *it does its work perfectly.* Cards are at the works, or would enclose some to you. Will let you have them when you come this way. Meantime I am

Very truly yours, EDWARD LINDSLEY, Eng. and Supt.

Athens, Ohio.

ATHENS GAS LT. CO., ATHENS, OHIO, Nov. 9, 1885.

Messrs. CONNELLY & Co.—Gentlemen: Your favor inquiring after the working of the Connelly Governor received. It has now been in use more than a year, and we find it as recommended in every particular. It does all the work required of a Governor, and strictly *automatically.* I have not the first disadvantage to suggest, after a trial at all seasons of the year. We consider this investment the most profitable and economical of any about our works, and have recommended it to all inquirers. Our leakage account has been reduced one-half.

Beaver Falls, Pa.

BEAVER FALLS GAS CO., BEAVER FALLS, PA., Nov. 9, 1885.

Messrs. CONNELLY & Co.—Gentlemen: It affords me no little pleasure to reaffirm that in my opinion no gas works is by half complete that lacks the advantages to be derived from an Automatic Governor such as yours has proved to be after more than a year's steady work—with positively no attention but oiling. The second Governor we purchased of you will shortly be placed in 6-inch line supplying the town of New Brighton.

Hastily yours, J. M. CRITCHLOW, Supt.

Helme's Automatic Regulator

As Applied to the

FOULIS GAS GOVERNOR.

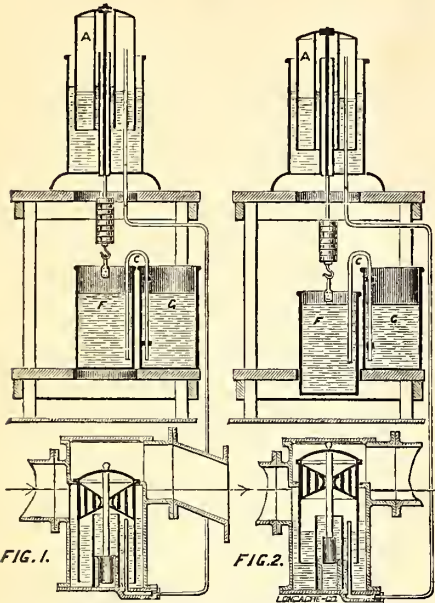

This Regulator and Governor combined are absolutely free from friction, excepting what is due to the moving of the float *A* and valve through the water. There are no journals to carry weight, and the moving parts are so nicely balanced that they do not rub against the surroundings.

The well-understood action of the inverted syphon in a fluid is made available in loading and unloading the float of the Regulator. As the demand for gas increases the float *A* descends, and with it the vessel *F*, drawing into it from the tank *G* a portion of the fluid it contains. This additional weight increases the pressure at the Governor sufficiently to overcome the friction in the pipes due to the increased amount of gas passing. When the shutting off begins a reverse action takes place. The float and vessel *F* begin to rise, and in doing so return to the tank *G* the fluid taken from it while descending.

From this it can be seen that any desired variation in pressure can be arranged for at the Governor, so as to maintain a uniform pressure in center of town. When once adjusted to the minimum day pressure and maximum night pressure it requires no further attention. For prices and further particulars inquire of

HELME & McILHENNY,
Nos. 1115 and 1117 Cherry Street, - - Philadelphia, Pa.

DYCKERHOFF PORTLAND CEMENT

Is superior to any other Portland Cement made. Its extraordinary strength permits a greater addition of sand, while its acknowledged uniformity insures the most reliable and strongest work. It is therefore the most economical to use. Circulars, with testimonials and tests, sent on application.

E. THIELE,
SOLE AGENT, U. S.,
78 William Street, - - New York.

GIBBS PORTLAND CEMENT

Is guaranteed to be the finest English brand, and unsurpassed by any grade imported for making concrete and setting masonry.

Extract of paper, with tests, read before the Am. Soc. of Civil Engineers, sent on application.

HOWARD FLEMING,
Sole Agent for U. S.,
23 Liberty St., New York.

GEROULD'S IMPROVED RETORT CEMENT.

Used by most of the Gas Companies of the United States with perfect satisfaction. Manufactured by

C. L. GEROULD,
Manchester, N. H.

N. B.—As Manchester is a shipping point, all freight can be shipped as cheaply as from Boston or New York.

BROOKS, SHOBRIDGE & CO. Best English PORTLAND CEMENT

WORKS: GRAYS, ESSEX, ENGLAND
New York Office, No. 7 Bowling Green.

HOWARD FLEMING, 23 Liberty Street, New York.

IMPORTER OF THE BEST

Portland & Roman Cements

"DINAS" SILICA FIRE BRICKS AND BLOCKS
For Coke Ovens and Gas Works.
Correspondence invited. Lowest prices.



THE ALBO-CARBON LIGHT!

A new system of Carbureting heated Gas by means of a solid material, whereby its illuminating power is increased more than three-fold.

SUPERIOR TO ALL OTHER SYSTEMS FOR
Economy, Safety, Illuminating Power and General Practicability,

The Albo-Carbon process enables Gas Companies to supply a light equal to the Arc Light, at a much less cost. Several Gas Companies are now using this system. The process is extensively used in Europe, and is being rapidly adopted in this country.

The Albo-Carbon Light Co., - - Newark, N. J.

GENERAL AGENCIES:

1004 Walnut St., Philadelphia, Pa. Law Buildings, Lexington Ave, Baltimore.
94 Fifth Avenue, Chicago, Ill. 35 Federal Street, Allegheny, Pa.
522 Pine Street, St. Louis, Mo. 120 S. Fourth Street, Minneapolis, Minn.

CHURCH'S REVERSIBLE SCREEN FOR GAS PURIFIERS

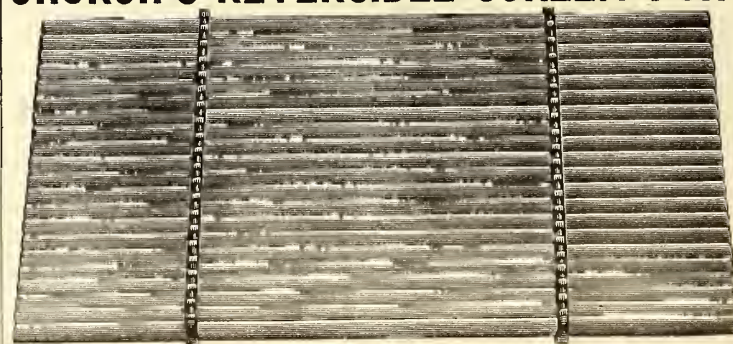

Very Durable
Easily Repaired.

Oval Slats, with
Malleable Iron
Cross Bars.

Apply to

JOHN CABOT,
LAWRENCE, MASS.

PATENTED JULY 9, 1878.

References in all parts of the country. Send for circular and list of companies who now have the Screen in use.

BROCK'S PATENT DROP FORGED CHAIN PIPE WRENCH

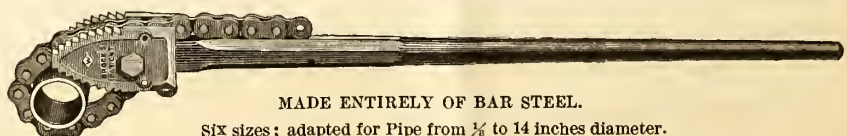

MADE ENTIRELY OF BAR STEEL.

Six sizes; adapted for Pipe from 1/2 to 14 inches diameter.

Each number will fit a range of sizes equal to six or more pairs of common tongs, while it will outwear an equal number of any kind. Jaws are hardened to a saw temper, and can be sharpened with a file. Does not crush pipe; has a quick grip; never slips; chain will not unhitch while in use, but can be instantly released.

All parts are interchangeable, and can be readily renewed.
J. H. WILLIAMS & CO.,
Manfs. of Every Description of Iron and Steel Drop Forgings.
No. 14 BOWNE STREET (Near Hamilton Ferry), BROOKLYN, N. Y.

NATIONAL GAS LIGHT AND FUEL COMPANY,

Sole Owners and Licensees of the Springer Patent Cupola and Process for the U. S.,

Chicago.

Builders, Lessees, and Purchasers of

GAS WORKS

UNDER THE

Springer Cupola Gas Generating System.

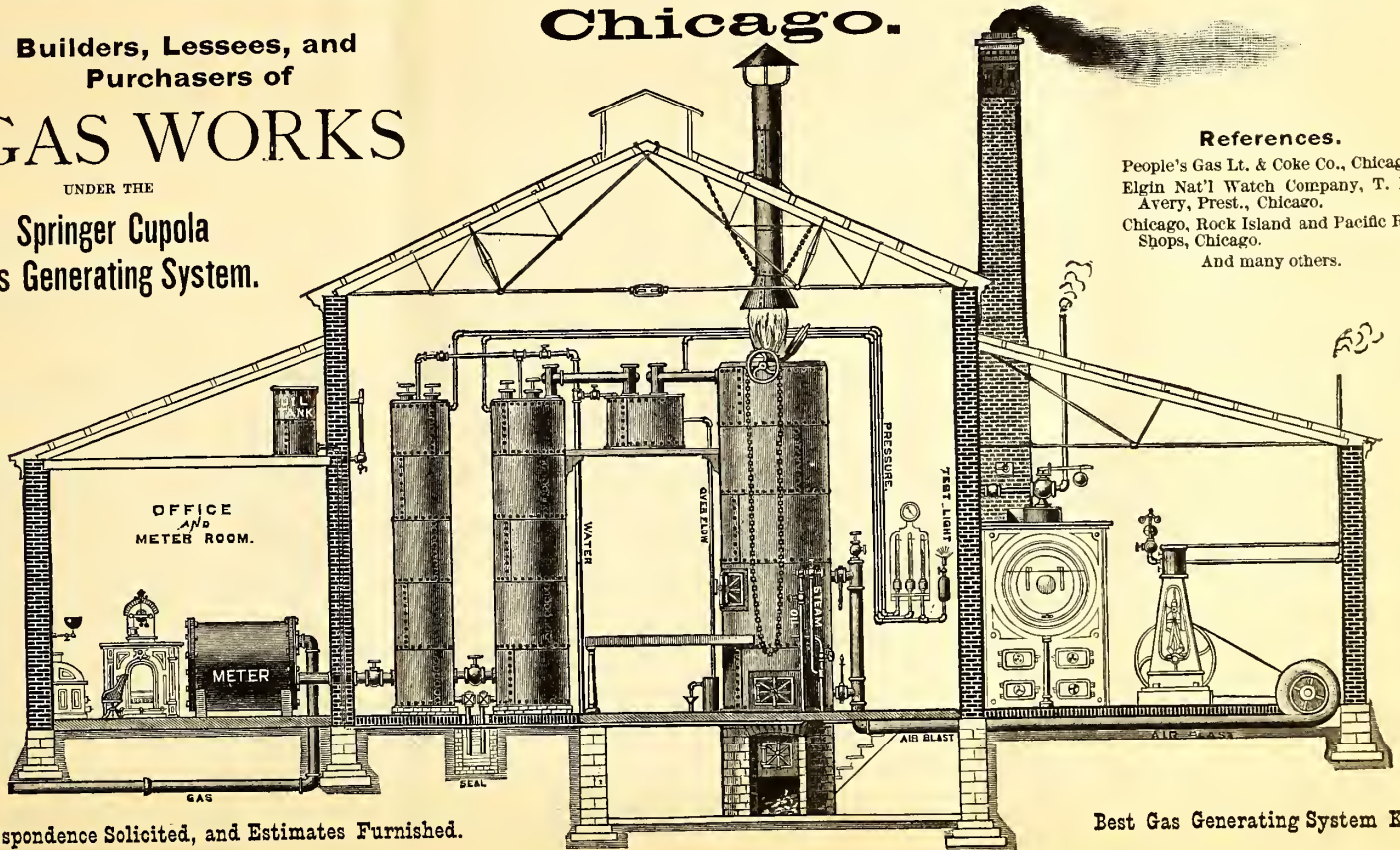

References.

People's Gas Lt. & Coke Co., Chicago.
 Elgin Nat'l Watch Company, T. M. Avery, Prest., Chicago.
 Chicago, Rock Island and Pacific Ry. Shops, Chicago.
 And many others.

Correspondence Solicited, and Estimates Furnished.

Best Gas Generating System Known.

Orders from Cities, Towns, and Public Institutions Promptly Executed. Address

NATIONAL GAS LIGHT AND FUEL COMPANY, - - - No. 162 Washington Street, Chicago, Ill.

BURDETT LOOMIS, HARTFORD, CONN.

Builder of Gas Works.

LOOMIS'S PATENT WATER GAS APPARATUS, FOR MAKING ILLUMINATING OR HEATING GAS FROM BITUMINOUS SLACK, ANTHRACITE COAL SCREENINGS, COKE, LIGNITE, OR WOOD.

More gas can be made with this apparatus, using **BITUMINOUS SLACK**, than by any other process using same amount of best quality Anthracite Coal, and with less oil. No clinker; no filling up of superheater with ashes, as they are separated from the coal in the process of blasting and easily removed. Plans and estimates furnished.

TAYLOR'S AUTOMATIC GAS CHECK.

Pat. Sept., 1885. Just the thing for street lamps. No moving parts; only the gas moves, and checks itself by opposing currents; cannot get out of order or wear out; the cheapest and best of all governors. Samples, by mail, 10 cents. Send for circular.

G. TAYLOR, 60 Duane st., N. Y.

OFFICE
43
PARK PLACE
WORKS
57, 59 AND 61
LEWIS ST.
60, 62, 64 & 66
Cannon
ST.

PROGRESS MACHINE WORKS.

A. & F. BROWN

NEW YORK

Shafting, Pulleys, HANGERS.

F. Brown's Patent Friction Clutch.

Send for Illustrated Catalogue and Discount Sheet to

A. & F. BROWN,

No. 43 Park Place, New York City.

Forest City Naphtha Co.,
REFINER OF
NAPHTHA and GASOLINES

ALSO MANUFACTURER OF
A Special Grade of Naphtha for Gas Companies
FOR ENRICHING COAL GAS.

Correspondence solicited.
No. 43 Euclid Avenue, Cleveland, Ohio.

PIPE COVERINGS.

FIREPROOF, NON-CONDUCTING COVERINGS FOR
**Steam Pipes, Boilers,
AND ALL HOT SURFACES.**

Made in sections three feet long. Easy to apply; light and cheap.

Asbestos Materials, Fibre, Braided Packing, and Cement.

CHALMERS-SPENCE COMPANY, 419 & 421 EIGHTH ST., N. Y.



These Goods are used at the Continental Works, Brooklyn.

THE CLERK GAS ENGINE.

Highest Award American Institute, New York, 1883. Silver Medal American Institute, N. Y., 1884.
Gold Medal Awarded Crystal Palace Electrical Exhibition, London, 1882.
Highest Award for Motive Power British Section International Exhibition of Electricity, Paris, 1881.

Reliable.
No Boiler.
Steady.
No Coal.
Simple.
No Ashes.
Compact.

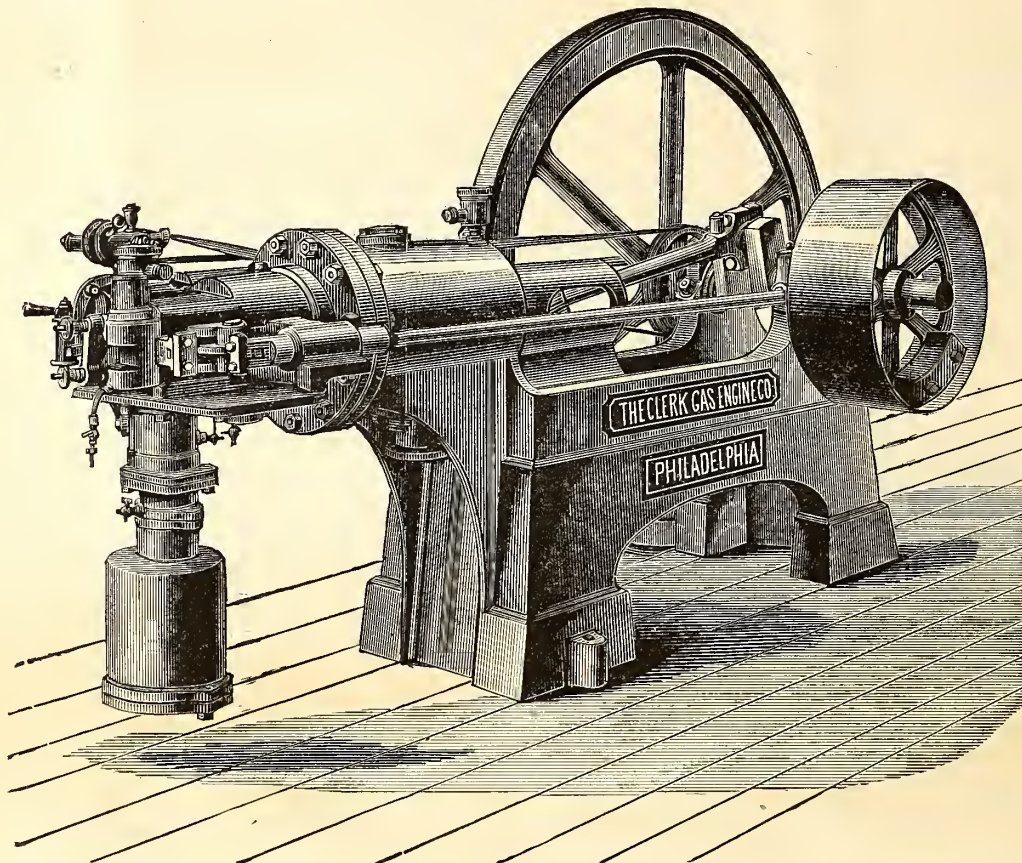

Economical.
No Engineer.
No Explosion
No Gearing
Wheels.
No Danger.
No Parts
requiring
frequent
renewal.

REQUIRING ONLY A MATCH TO START IT--GIVING ITS FULL POWER IMMEDIATELY.

We would inform the public that during the last few months we have improved THE CLERK GAS ENGINE to such an extent that we can now offer an engine vastly superior to our former pattern. These improvements have enabled us to sell our engine at a GREATLY REDUCED FIGURE, partly on account of the decreased weight (our engine weighing about half that of others giving the same Brake H. P.). The consumption of gas has been decreased to a considerable extent, and the Brake H. P. has been increased some 25 to 30 per cent. All parts of the old design that were considered defective have been remodeled and new designs added. We now have an engine second to none as regards power, consumption, and ease of working. With our new engine all trouble in starting has been removed, the noise reduced to a minimum, and the regularity of motion is now all that can be desired. We guarantee all we claim for it, and the material and workmanship being of the best, enables us to guarantee the engine for twelve months.

SOLE MAKERS,

THE CLERK GAS ENGINE CO.,

WM. W. GOODWIN, President. E. STEIN, Secretary. S. LEWIS JONES, Asst. Secretary. L. P. GARRET, Supt.

Main Office, 1012-1018 Filbert Street, Philadelphia, Pa.

BRANCH OFFICES,

142 Chambers St., N. Y.

4 West Fourteenth St., N. Y.

76 Dearborn St., Chicago

General Agents,

THE GOODWIN GAS STOVE & METER CO.

Of Philadelphia, New York, and Chicago.

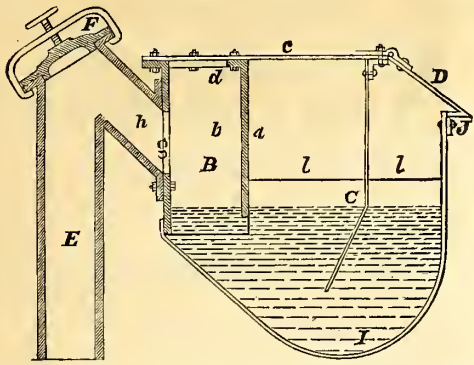

Boardman Hydraulic Main,
Patented October 7, 1884.

For description, see AM. GAS LIGHT JOURNAL of Feb. 2, 1884.
For terms, apply to
A. E. BOARDMAN, Macon, Ga.

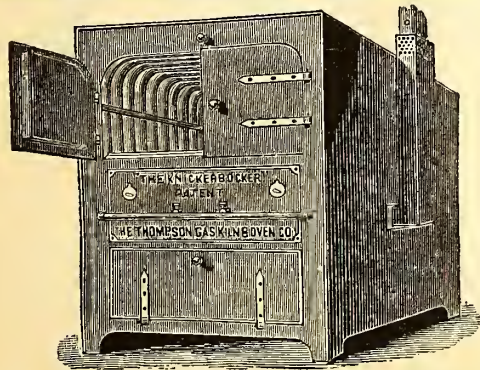

"The Knickerbocker" Portable Gas Oven,
ON EXHIBITION AT AMERICAN INSTITUTE FAIR.
Thompson Gas Kiln & Oven Co.
59 Carmine St., N. Y.
Send for Circular by mail.

MITCHELL, VANCE & CO.,

MANUFACTURERS OF

Chandeliers

and every description of

GAS FIXTURES.

Also manufacturers of Fine Gilt Bronzes and Marble Clocks,
warranted best time-keepers. Mantel Ornaments, etc.

Salesrooms, 836 Broadway, N. Y.

Special Designs furnished for Gas Fixtures for Churches, Public
Halls, Lodges, etc.

THE GLOBE
STREET LAMP.



MINER'S PATENT
STREET LAMPS.

Are adapted for use of Streets, Parks,
Depots, Ferries, & Private Grounds.

WITH POSTS OR BRACKETS.

Jacob G. Miner,

No. 823 Eagle Ave., New York N. Y.

C. BARCALOW, PREST.

J. V. BARCALOW, SEC. & TREAS.

BARTLETT
Street Lamp Mfg. Co.

MANUFACTURERS OF

Bartlett's Patent

GLOBE LAMPS.

FOR

**Streets, Parks, Railroad Stations, Public
Buildings, Etc.**

LAMP POSTS A SPECIALTY.

Office and Salesroom,
No. 35 Howard Street, N. Y. City.

Gas Companies and others intending to erect lamps and posts
will do well to communicate with us.

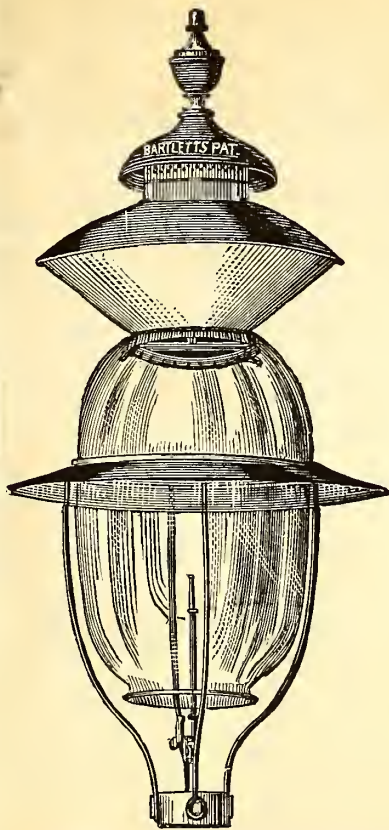

F. M. ROOTS.

S. C. ROOTS

D. T. ROOTS.

P. H. & F. M. ROOTS,
PATENTEES AND MANUFACTURERS OF

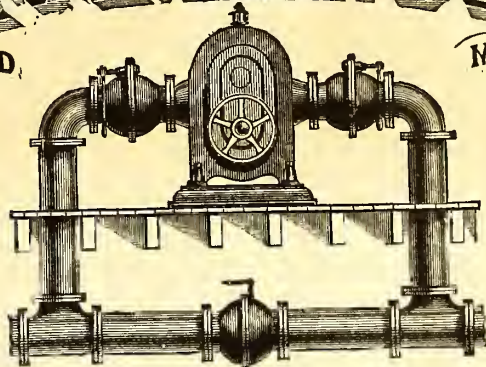
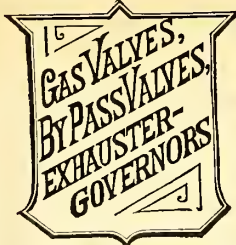

IMPROVED GAS EXHAUSTER,

WITH ENGINE ON SAME BED PLATE, OR WITHOUT.

BYE-PASSES, GAS VALVES, GOVERNORS, ELBOWS, PIPE-FITTINGS, Etc., FURNISHED TO ORDER,

P. H. & F. M. ROOTS, Patentees & Manufacturers, **CONNERSVILLE, IND.**

S. S. TOWNSEND, General Agent, 22 Cortland St. and 9 Dey St., N. Y.

JAS. BEGGS & CO., Selling Agents, 9 Dey St., N. Y.

COOKE & CO., Selling Agents, 22 Cortland St., N. Y.

✽ SEND FOR ILLUSTRATED CATALOGUE AND PRICE LIST. ✽

THE **A. S. Cameron Steam Pump,**

THE STANDARD OF EXCELLENCE.

Upward of 30,000 in Use.

BEST GAS WORKS PUMP
Ever Introduced.

Adapted to Every Possible Duty.

A. S. Cameron Steam Pump Works,

Foot East 23d St., N. Y.

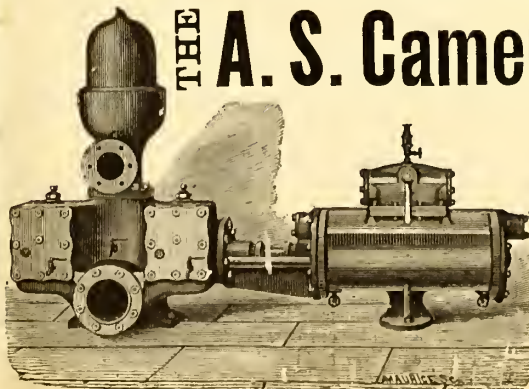

J. H. GAUTIER & CO..

CORNER OF

GREENE AND ESSEX STREETS,
JERSEY CITY, N. J.

MANUFACTURERS OF

**Clay Gas Retorts,
Gas House Tiles,
Fire Bricks, Etc. Etc.
Ground Clay, Fire Brick and
Fire Sand in Barrels,**

J. H. GAUTIER.
C. E. GREGORY.T. B. GAUTIER.
C. E. GAUTIER.**BROOKLYN**

**Clay Retort & Fire Brick Works,
(EDWARD D. WHITE & CO.)**

Manufacturers of Clay Retorts, Fire Brick,
Gas House and other Tile.

VAN DYKE, ELIZABETH, RICHARDS & PARTITION STS.
Office, 88 Van Dyke St., Brooklyn, N. Y.

LACLEDE FIRE BRICK MFG. CO.,

MANUFACTURERS OF

Fire Brick, Gas Retorts,

AND

ST. LOUIS STANDARD SEWER PIPE.

Blast Furnace and Cupola Linings, every description of Fire
Clay Material, Fire Clay Flue Linings, Chimney Tops
Dry Milled and Crude Fire Clays, etc.

OFFICE AND DEPOT

901, 903, and 905 Pine Street,
ST. LOUIS, MO.

ESTABLISHED IN 1845.

B. KREISCHER & SONS,

OFFICE FOOT OF HOUSTON ST., E.R., N.Y.

Gas Retorts,**TILES, FIRE BRICK.****AND EVERYTHING IN THE FIRE CLAY LINE.****MANHATTAN
FIRE BRICK & ENAMELLED CLAY
RETORT WORKS.****ADAM WEBER.****CLAY GAS RETORTS
AND RETORT SETTINGS****FIRE BRICKS, TILES, ETC.,**

Office and Works, 15th Street and Avenue C., N. Y.



JAMES GARDNER, JR.

Works,
LOCKPORT STATION, PA.

—ESTABLISHED 1864.—

WILLIAM GARDNER & SON,

Successor to GARDNER BROTHERS.

WILLIAM GARDNER.

Office, COAL EXCHANGE,
PITTSBURGH, PA., P. O. Box 373.

Fire Clay Goods for Gas Works.

C. H. SPRAGUE, No. 70 KILBY STREET, BOSTON, MASS., Agent for the New England States.

OFFICE, 418 to 422 East 23d St., New York.

ESTABLISHED 1856.

WORKS, PERTH AMBOY, NEW JERSEY.

HENRY MAURER,**Excelsior Fire Brick & Clay Retort Works**

CLAY GAS RETORTS, BENCH SETTINGS, FIRE BRICK, TILES, ETC.

STANDARD GAS RETORT AND FIRE BRICK COMPANY,

J. ANDERSON, PRES. & MANG'R.

OF IRONTON, OHIO.

C. PETERS, SECRETARY.

Clay Gas Retorts, Fire Brick, and Fire Clay Goods of Every Description.

Plans of Livesey-Somerville, McIlhenny, and other Furnaces, and Competent Workmen Supplied.

CHICAGO**Retort & Fire Brick Works,**

OFFICE AND FACTORY,
Clark, Forty-Fifth, and La Salle Streets,
CHICAGO, ILL.

GEORGE C. HICKS, PRES. PAUL P. AUSTIN, SEC. & TREAS.

STANDARD

Clay Retorts and Settings.**BLOCKS & TILES**

Of every Shape and Size to Order.

Standard Fire Bricks.**NEWBIGGING'S****Gas Manager's Handbook.***Price, \$4.80.*

EVERY GAS MAN SHOULD HAVE ONE.

Orders may be sent to this Office.

OAKHILL**GAS RETORT & FIRE BRICK**

COMPANY.

PARKER, RUSSELL & CO.

City Office, 711 Pine Street,

ST. LOUIS, MO.

Our immense establishment is now employed almost entirely in
the manufacture of**MATERIALS FOR GAS COMPANIES.**

We have studied and perfected three important points. Our re-
torts are made to stand changes of temperature, the strongest
heats of the furnace, and the abrasion of feeding and emptying.
Our customers are in almost every State of the Union, to all of
whom we refer.

THOS. SMITH, Prest. AUGUST LAMBLA, Vice-Prest. & Sup

BALTIMORE**RETORT & FIRE BRICK CO.**

MANUFACTORY AT

LOCUST POINT, BALTIMORE, MD.

Connection with the City by Telephone.

Clay Retorts, Blocks & Tiles,**FIRE BRICK, FIRE CLAY,
AND FIRE CEMENT.**

Red and Buff Ornamental Tiles and Chim-
ney Tops. Drain and Sewer Pipe (from
2 to 30 inches). Baker Oven Tiles
12 x 12 x 2 and 10 x 10 x 2.

WALDO BROS., 88 WATER ST., BOSTON, MASS

Sole Agents for New England States

THE AMERICAN METER CO.,

MANUFACTORIES,

508 to 514 West Twenty-second St., N. Y. Arch and Twenty-second St., Phila.
Nos. 244 & 246 North Wells Street, Chicago, Ill.

AGENCIES,

No. 177 Elm Street, Cincinnati, Ohio. Nos. 122 & 124 Sutter Street, San Francisco, Cal.
No. 810 North Second Street, St. Louis, Mo.

NEW

INCANDESCENT

Gas Fires

AND

OPEN

Fire Place Heaters.

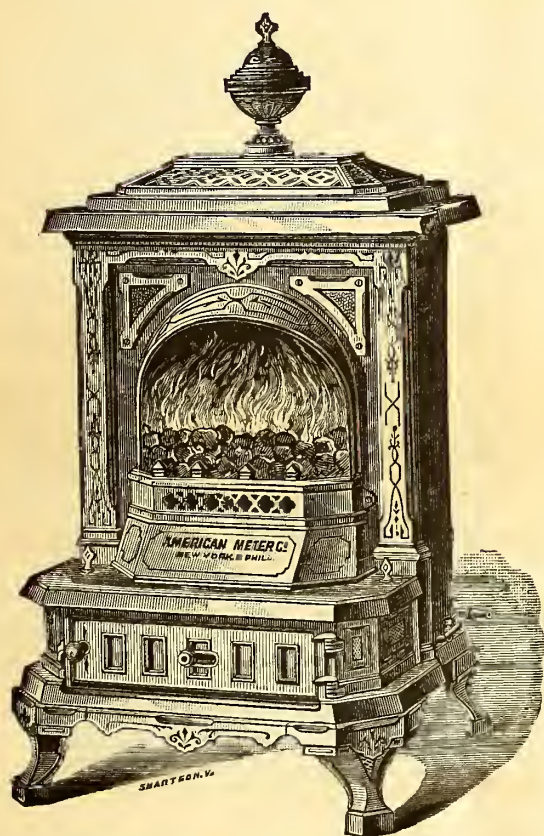

Open Fire Place Heater No. 19.
Fitted with the New Incandescent Gas Fire.

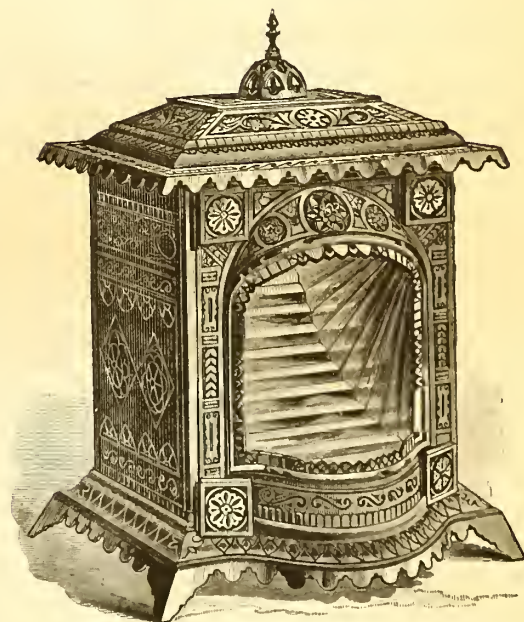

Open Fire Place Heater No. 17C.
Fitted with Illuminating Burners and Copper Reflector.

We call attention to Special Apparatus Heated by Gas for Manufacturing Purposes. Gas Furnaces for Tinmen's use; Furnaces for melting Solder and Type Metal; Apparatus for bending Carriage Panels (in successful operation in Carriage Manufactories); Water Heaters for Kitchen Boilers, Baths, etc., and for attaching to Heating Coils and Pipes for Conservatories.

THE COMPANY MANUFACTURES

GAS STOVES FOR COOKING AND HEATING PURPOSES

In all Sizes, for Domestic, Restaurant, and Hotel Use.

These Stoves may be seen in operation at our Retail Store, No. 223 Sixth Avenue, N. Y. Call and examine.

SEND FOR CATALOGUE OF TWENTY DIFFERENT STYLES OF HEATING STOVES.

A. H. M'NEAL,

BURLINGTON, N. J.

Flange-Pipes

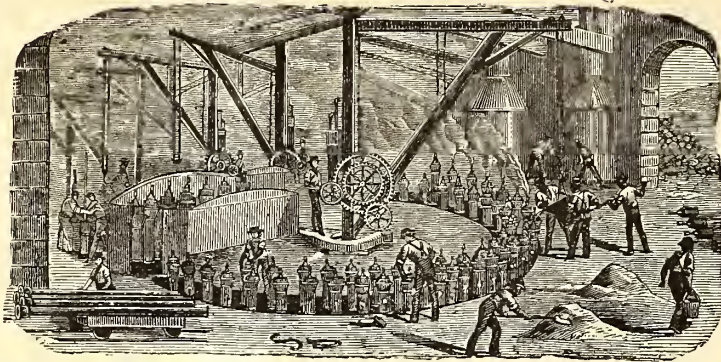

General Foundry Work.

CAST IRON PIPES FOR WATER AND GAS.

JAMES S. MOORE, Pres.
BENJAMIN CHEW, Treas.

JAS. P. MICHELLON, Sec.
WM. SEXTON, Supt.

GLOUCESTER IRON WORKS, GLOUCESTER CITY, N. J.

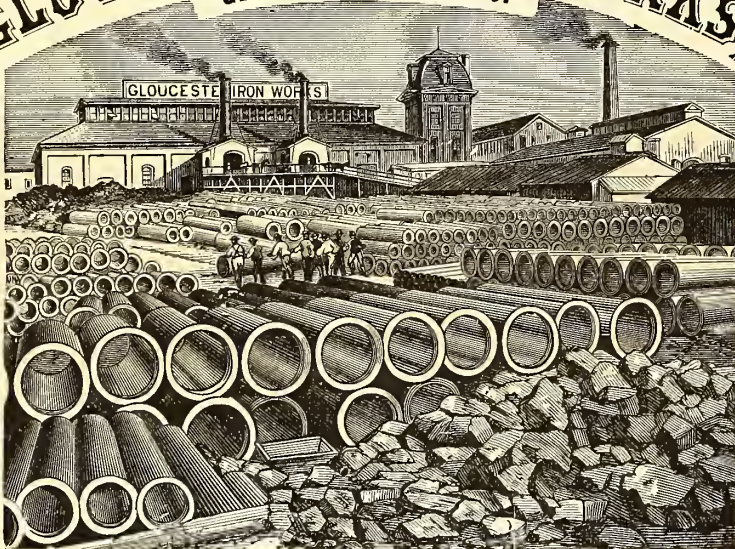

Cast Iron Gas & Water Pipes, Stop Valves, Fire Hydrants, Gasholders, &c.
Office No. 6 North Seventh Street, Philadelphia.

ESTABLISHED 1856.

WARREN FOUNDRY AND MACHINE CO.,

WORKS AT PHILLIPSBURGH, N. J.
NEW YORK OFFICE, 162 BROADWAY.

Cast Iron Water and Gas Pipe

FROM TWO TO FORTY-EIGHT INCHES DIAMETER.
ALSO ALL SIZES OF

FLANGE PIPE for Sugar House and Mine Work.
Branches, Bends, Retorts, Etc., Etc.

436-1

MATTHEW ADDY, President.

W. L. DAVIS, Selling Agent.

GEO. P. WILSHIRE, Sec. & Treas.

Cincinnati and Newport Iron and Pipe Company,

NEWPORT, KY.

Lamp Posts
AND
BENCH CASTINGS

A Specialty.

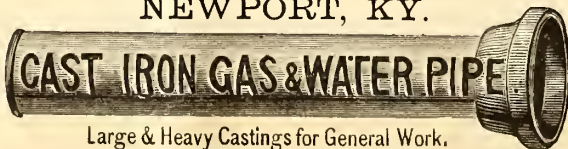

Large & Heavy Castings for General Work.

Manufacture Pipe from 2 to 48 inches. All work guaranteed first quality.

Branch
AND
SPECIAL CASTINGS
FOR GAS & WATER CO'S.

Hydraulic Main Dip Regulators, also
Check Valves, Foot Valves, Yard-
wash and Fire Hydrants.
Send for Circulars.

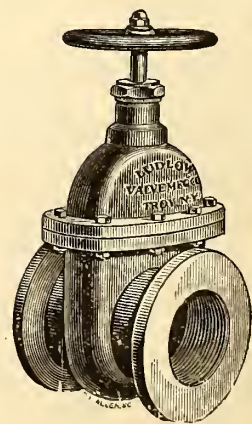

Valves.—Double and Single Gate, 1/2 in. to
48 in., outside and inside Screws. Indica-
tor, etc., for Gas, Water, Steam, and Oil.
Send for Circulars.

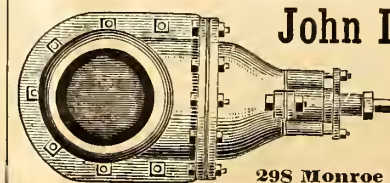

John McLean

Manufacturer of
GAS
VALVES.

298 Monroe Street, N. Y.

Mellert Foundry and Machine Co. Limited.



Specials—Flange Pipe, Valves and Hydrants,
Lamp Posts, Retorts, etc.
Machinery and castings for Furnaces, Rolling Mills, Grist and
Saw Mills, Mining Pumps, Hoists, etc.
GENERAL OFFICE, - - - READING, PA.

CAST IRON

Gas and Water Pipes,

From 2 to 48 Inches in Diameter.

FOX & DRUMMOND,

160 Broadway, N. Y. City.

THE OHIO PIPE COMPANY,

MANUFACTURERS OF

Cast Iron Gas & Water Pipe,

BRANCH AND SPECIAL CASTINGS.

Gas-House Bench Castings, Hydraulics, Lamp Posts, Flange Pipe
and Specials, Architectural Castings, Building Columns,
Joists, Cellar Grates, Sash Weights, etc.

GENERAL FOUNDERS AND MACHINISTS.
Columbus, Ohio.

LUDLOW VALVE MFG. CO.

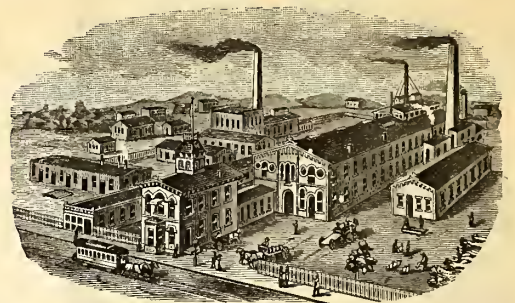

OFFICE AND WORKS,

935 to 954 River Street and 67 to 83 Vail Av.
TROY, N. Y.

Siemens's Regenerative Gas Burners, For Lighting and Ventilating.

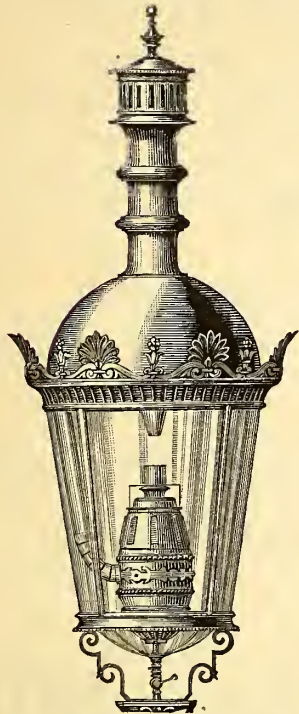

THE CHEAPEST, PUREST, AND MOST BRILLIANT OF ALL GAS LIGHTS.

Superior to the Electric Light in Economy, Beauty, & Steadiness.

SPECIALLY ADAPTED FOR LIGHTING HALLS, FACTORIES, OPEN SPACES, ETC.

Numerous Tests made by various Gas Companies in the United States show an Efficiency of Ten Candle Power per Cubic Foot of Gas.

General Agents:

- SIEMENS LIGHTING CO., 347 West Main St., Louisville, Ky.
- MEYER, MARSHALL & CO., 528 California St., San Francisco.
- DENNEHY, WOLF & O'BRIEN, 85 & 87 Dearborn St. Chicago, Ill.
- WILCOX & McGEARY, - No. 11 Bissel Block, Pittsburgh, Pa.
- T. T. RAMSDALL & CO., - 20 Swan Street, Buffalo, N. Y.
- SIEMENS GAS ILLUMINATING CO.,
Room 6, No. 157 Broadway, New York City.
- W. D. COLT, - - - - 1420 F Street, Washington, D. C.
- JOHN KIEFER, - - - 344 Lawrence, Street, Denver, Col.

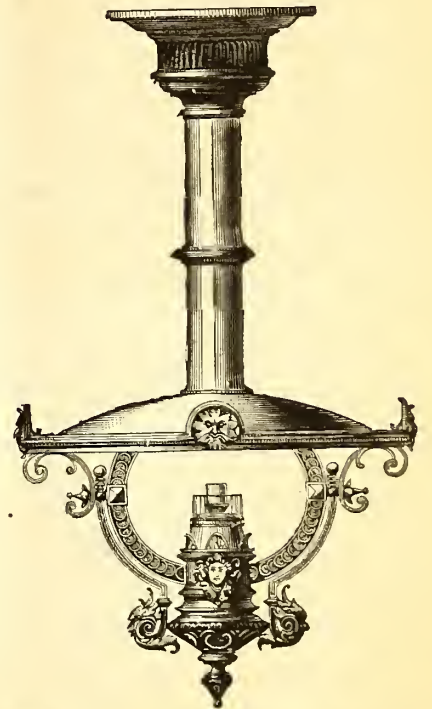

THE SIEMENS REGENERATIVE GAS LAMP COMPANY,
SOLE MAKERS FOR THE UNITED STATES,
N. E. Cor. 21st. St. and Washington Av., Philadelphia. Pa.

THE "STANDARD" WASHER-SCRUBBER, KIRKHAM, HULETT & CHANDLER'S PATENT.

Total Capacity per 24 Hours of "Standard" Washers Ordered During the Following Years.

1877.....	4,000,000 cubic feet.
1878.....	4,750,000 "
1879.....	24,545,000 "
1880.....	42,967,500 "
1881.....	36,462,500 "
1882.....	39,300,000 "
1883.....	57,735,000 "
1884.....	26,177,500 "
Total....	235,937,500 cubic feet.

Total Number and Capacity per 24 Hours of "Standard" Washers Erected and in Course of Erection in the Several Countries

	Number.	Cubic Feet per Day.
Great Britain..	151	157,070,000
Western Hemisphere.....	38	39,337,500
Australia.....	18	12,150,000
New Zealand.....	2	650,000
France.....	6	4,550,000
Belgium.....	8	5,420,000
Germany.....	16	8,200,000
Holland.....	4	4,160,000
Denmark.....	1	150,000
Russia.....	2	3,500,000
Spain.....	1	350,000
India.....	1	400,000
Total.....	248	235,937,500

THE CONTINUED POPULARITY

Of these Machines

Will be recognized from the following extracts from letters from representatives of some of the companies having them in use:

PROVIDENCE GAS COMPANY, }
PROVIDENCE, R. I., Nov. 24, 1884. }

GEO. SHEPARD PAGE, Esq., New York:

Dear Sir—We are now using less than a gallon of water per thousand in the "Standard," and the gas at the outlet will not color turmeric paper.

Yours, etc.,

A. B. SLATER, Treasurer.

PORTLAND GAS COMPANY. }
PORTLAND, ORE., Nov. 29, 1884. }

GEO. SHEPARD PAGE, New York:

Dear Sir—Our Scrubber appears to run to our entire satisfaction, and we are pleased to say that it takes out all the ammonia from the gas. This is very satisfactory to us, as we were ruining our meters at a fearful rate heretofore. The amount of water used is very inconsiderable as compared with our old process. The machine runs very smooth and still.

Very respectfully,
H. C. LEONARD, Secretary.

"Standard" Washers Ordered Recently.

	Cu. Ft. per Day
Anneberg Gas Co.....	200,000
Bombay Gas Co.....	400,000
Brussels Co.....	1,250,000
CHICAGO, two, 1,000,000 each.....	2,000,000
Chemnitz Gas Co.....	1,000,000
CITIZENS GAS CO., BUFFALO.....	750,000
Coke Works in Zabre, Ober-Schlesien.....	1,500,000
Cokerel der Friedenschutte, Upper Silesia.....	1,000,000
Dumfries Corporation.....	250,000
Dunedin Gas Co., New Zealand.....	400,000
GEORGETOWN, D. C.....	250,000
King's Lynn Gas Co.....	300,000
Leiden, Holland.....	600,000
Lincoln Gas Co.....	400,000
Liverpool Gas Co.....	2,000,000
".....	3,000,000
LOUISVILLE GAS CO.....	1,500,000
Numea Gas Co.....	100,000
PITTSBURGH GAS CO.....	1,500,000
PAWTUCKET, R. I.....	500,000
PORTLAND GAS CO., Oregon.....	562,500
SAN FRANCISCO GAS CO.....	4,000,000
Sheepbridge.....	40,000
ST. LOUIS GAS CO.....	2,000,000
Sydney Gas Co.....	2,500,000
WASHINGTON, D. C. GAS CO.....	2,000,000
Whitechurch Gas Co.....	175,000
Total.....	29,677,500

GEO. SHEPARD PAGE, No. 69 WALL STREET, NEW YORK,
SOLE AGENT FOR THE WESTERN HEMISPHERE.

R. D. WOOD & CO.,

400 Chestnut Street, Phila., Pa.

Cast Iron Gas & Water Pipe, Water Machinery & Gas Apparatus

Cast Iron Pipe, Fire Hydrants, Eddy Valves, Lamp Posts, Large Loam Castings, Flanged Pipe, Sugar House Work, Iron Roofs and Floors, Wrought & Cast Iron Tanks, Turbine Water Wheels and Pumps.

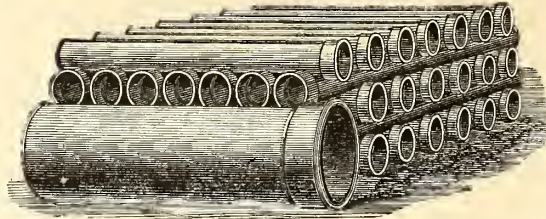

Casholders, Lime Trays, Center Valves, Purifiers, Bench Work, Exhausters, Condensers, Governors, Scrubbers, Gas Valves, Station Meters, Cast Iron Pipe Fittings.

Manufacturers of Heavy Castings and Machinery of Every Description.

ENGINEERS & CONTRACTORS FOR THE ERECTION OF GAS WORKS, & ALL MACHINERY CONNECTED THEREWITH

Estimates and specifications furnished for erection of new works or the extension or alteration of old ones.

Foundries and Works, - - Millville, Florence, and Camden, N. J.

SMITH & SAYRE MFG. COMPANY,

G. G. PORTER, Prest.

245 Broadway, N. Y.

CHAS. W. ISBELL, Sec'y.

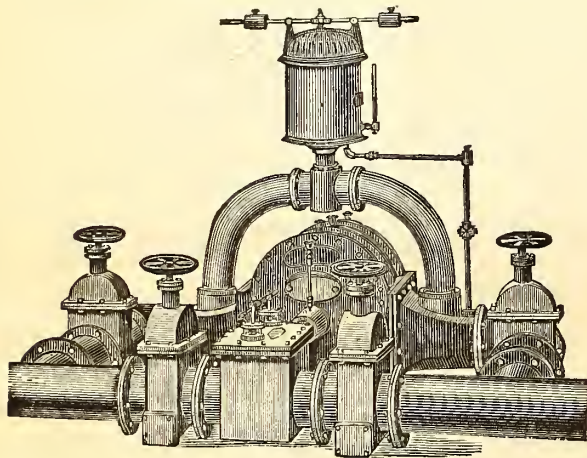
**Machinery & Apparatus for Gas Works**

Drawings, Plans, and Estimates Furnished for the Improvement, Extension, or Alteration of Gas Works, or for the Construction of New Works.

Mackenzie's Patent Rotary and Steam Jet Gas Exhausters, Governors, Compensators, Condensers, Washers, Scrubbers. Isbell's Patent Automatic Street Pressure Governor, Gas and Water Valves, Hydraulic Main Dip Regulator, Bench Castings, etc. Purifying Boxes and "Standard" Scrubbers. Isbell's Patent Self-Sealing Retort Doors.

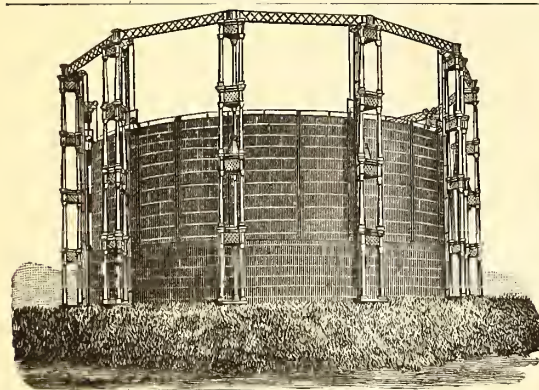

W. E. Tanner, Pres., W. R. Trigg, V.-Pres., A. Delaney, Supt.

Tanner & Delaney Engine Co.
RICHMOND, VA.

Gas Apparatus,

INCLUDING

Condensers of various styles, Scrubbers, Holders, Purifiers, Castings for Retort Houses, Etc.

ALSO STEAM ENGINES AND BOILERS.
Plans, Specifications and Estimates Furnished.

MORRIS, TASKER & CO.,

Limited,

Builders of Gas Works,

PHILADELPHIA, PA.

To Gas Companies.

We make to order **CAP BURNERS** to burn any amount under a stated pressure. Send for samples.

Also, SERVICE CLEANERS, DRIP PUMPS, and STREET MAIN PROVING APPARATUS.

C. A. GEFROERER,

248 N. 8th Street, Phila., Pa.

SOUTHWARK FOUNDRY AND MACHINE COMPANY,

Successors to MERRICK & SONS. Established in 1836.

No. 430 Washington Avenue, Philadelphia, Pa.

MANUFACTURERS OF

Single and Telescopic Gasholders,

BENCH CASTINGS,

Washers, Scrubbers, Condensers, Purifiers,

And all apparatus necessary for the construction of improved new gas works and in the extension of established works. Also manufacturers of

Gas Engines, and of all descriptions of Steam and Hydraulic Machinery, and of Boiler and Tank Work.

Plans, specifications, and estimates furnished promptly on application.

WM. HENRY WHITE,

Consulting & Constructing

Gas Engineer & Contractor.

ESTIMATES, PLANS, AND SPECIFICATIONS FURNISHED FOR NEW WORKS OR EXTENSIONS OF EXISTING WORKS.

32 Pine St., New York City.

Correspondence solicited.

KERR MURRAY MFG. CO.,

MANUFACTURERS OF

Single Lift and Telescopic GASHOLDERS.

Built, 1884:

Altoona, Pa.	Capacity, 160,000 cubic feet.
Pittsburgh, Pa.	250,000 "
"	230,000 "
Bellaire, Ohio.	50,000 "
Youngstown, Ohio.	60,000 "
Canton, "	60,000 "
Akron, "	80,000 "
Xenia, "	10,000 "
Adrian, Mich.	65,000 "
Ypsilanti, Mich.	25,000 "
Muskegon, "	70,000 "
South Bend, Ind.	70,000 "
Anderson, "	20,000 "
Plainfield, "	10,000 "
Springfield, Illinois.	100,000 "
Evanston, "	50,000 "
Freeport, "	35,000 "
Elgin, "	60,000 "
Sheboygan Wis.	20,000 "
Key West Fla.	10,000 "

Plans and estimates furnished for the erection of new and the rebuilding of old works. Address

Kerr Murray Mfg. Co.,
FORT WAYNE, IND.

JAMES R. FLOYD,
(SUCCESSOR TO HERRING & FLOYD)

Oregon Iron Works,
531 to 543 West 20th St., N. Y.
Practical Builders of Gas Works,
MANUFACTURERS OF
ALL KINDS OF CASTINGS
AND
APPARATUS FOR GAS-WORKS.

BENCH CASTINGS
from benches of one to six Retorts each.
**WASHERS: MULTITUBULAR AND
AIR CONDENSERS; CONDENSERS; SCRUBBERS**

wet and dry, and
EXHAUSTERS
for relieving Retorts from pressure.
BENDS and BRANCHES
of all sizes and description.

**FLOYD'S PATENT
MALLEABLE RETORT LID.**

**PATENT
SELF-SEALING RETORT LIDS.**

**FARMER'S
PATENT BYE-PASS DIP-PIPE.**

**SABBATON'S PATENT
FURNACE DOOR AND FRAME.**

**BUTLER'S
COKE SCREENING SHOVELS.**

GAS GOVERNORS,

and everything connected with well regulated Gas Works at low price, and in complete order.

SELLER'S CEMENT

for stopping leaks in Retorts.

N. B.—STOP VALVES from three to thirty inches—
at very low prices.
Plans, Specifications, and Estimates furnished.

CONTINENTAL WORKS.

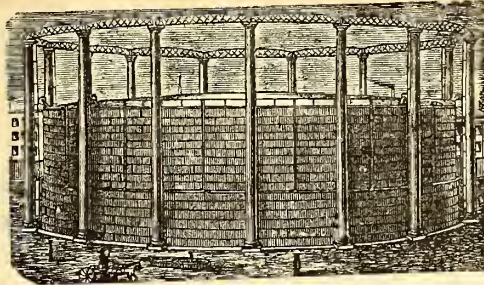

GASHOLDERS OF ANY MAGNITUDE.

T. F. ROWLAND, Proprietor,
GREENPOINT, BROOKLYN, N. Y.
ENGINEER AND MANUFACTURER OF
GAS-HOLDERS.
CONDENSERS, SCRUBBERS, VALVES,
PURIFIERS, RETORTS, and HY-
DRAULIC MAINS,

and all other articles connected with the Manufacture and Distribution of Gas. Plans and Specifications prepared and Proposals given for the necessary Plant for Lighting Cities, Towns, Mansions, and Manufactories.

H. RANSHAW, Prest. & Mangr. WM. STACEY, Vice-Pres. T. H. BIRCH, Asst. Mangr. R. J. TARVIN, Sec. & Treas.

STACEY MFG. CO.,

MANUFACTURERS OF

Single and Telescopic Gasholders,

IRON ROOFS, BRIDGES, LAMP POSTS,

Water and Oil Tanks, Coal Elevator Cars,
COKE CRUSHERS, BENCH CASTINGS,

And all kinds of Wrought and Cast Iron Work used in the erection of Coal and Oil Gas Works.
Rolling Mill Machinery and Heavy Castings a Specialty.

Foundry:

33, 35, 37 & 39 Mill Street.

Wrought Iron Works:

16, 18, 20, 22, 24 & 26 Ramsey Street.

Cincinnati, Ohio.

BARTLETT, HAYWARD & CO.,

Office, 24 Light.

BALTIMORE, MD.

Works, Pratt & Scott.

PURIFIERS.
Roofs.
Bench Castings.

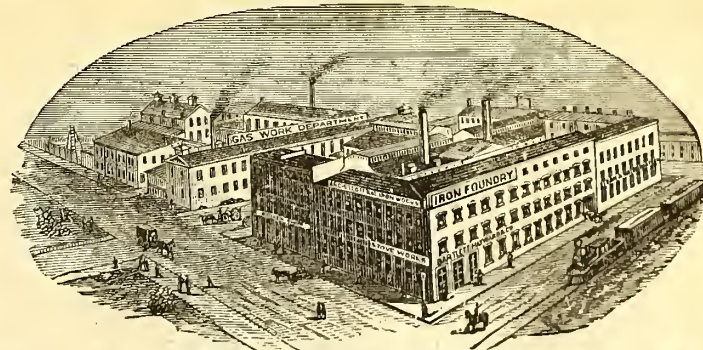

CONDENSERS
BOILERS.
SCRUBBERS.

GASHOLDERS.

CONSTRUCTING ENGINEERS AND BUILDERS OF GAS WORKS.

1842. **DEILY & FOWLER,** 1885.

Laurel Iron Works.

Address, No. 39 Laurel Street, Philadelphia, Pa.

MANUFACTURERS OF

GASHOLDERS,

Single or Telescopic, with Cast or Wrought Iron Guide Frames.

Holders Built Since 1880:

Mount Joy, Pa.	West Point, N. Y.	Galveston, Texas (2d.)	Kalamazoo, Mich. (3d.)	Newport, R. I.
Rockaway B'ch, N.Y. (2)	Fitchburgh, Mass.	Marlboro, Mass.	Glen Island, N. Y.	Portland, Oregon.
Zanesville, O. (2d.)	New London, Conn.	Denver, Col.	Warren, Ohio.	Allegheny, Pa. (2d.)
Lancaster, O.	Derby, Conn.	Chicago, Ill. (West Side)	Bath, N. Y.	Atlanta, Ga. (2d.)
Blackwell's Island N. Y.	Bridgeport, Conn.	Pittsburgh, Pa. (S. Side)	Lynn, Mass.	N.Y. City (Central Gas Co.)
Waltham, Mass., (1st.)	Allegheny, Pa. (1st.)	Pawtucket, R. I.	New Bedford, Mass.	Lynchburg, Va. (2d.)
Dorchester, Mass.	St. Hyacinth, Can.	Brookline, Mass.	Waterbury, Conn.	Staylesville, R. I.
Wheeling, West Va.	Norwalk, O.	Sherbrooke, Can.	Deseronto, Can.	Rondout, N. Y.
Lansing, Mich.	Brattleboro, V.	Burlington, N. J. (2d.)	Hoosic Falls, N. Y. (2d.)	Athlone City, N. J.
Flint, Mich.	Waltham, Mas (2d.)	Bridgeton, N. J.	Bethlehem, Pa.	Augusta, Ga.
Galveston, Texas (1st.)	West Chester, Pa.	Bay City, Mich.	Atlanta, Ga. (1st.)	Waltham, Mass. (2)
Milton, Pa.	Baltimore, Md.	Erie, Pa.	Savannah, Ga.	
Scranton, Pa.	Hollidaysburg, Pa.	Jackson, Mich.	Montgomery, Ala	

GAS COALS.

GAS COALS.

GAS COALS.

JAMES D. PERKINS.

PERKINS & CO.,

F. SEAVERN.

General Sales Agents for

The Youghioghenny River Coal Company's OCEAN MINE YOUGHIOGHENY GAS COAL.

The Coal from the Ocean Mine (recently operated by Messrs. W. L. Scott & Co., of Erie, Pa.,) is now used by all the leading Gas Companies in the United States from Maine to Texas, and is recognized as *the only reliable Youghioghenny Gas Coal.* (See Map on p. 87 of this Journal, Feb. 16, 1885.)

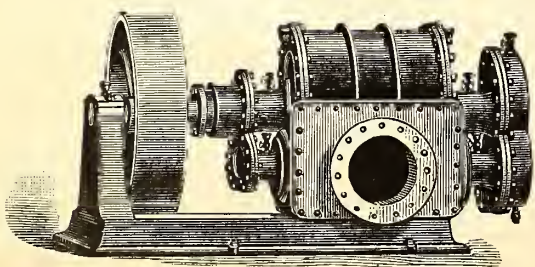
P. O. Box 3695,
New York.**PERKINS & CO., 228 and 229 N. Y. Produce Exchange****BEAVER STREET
ENTRANCE.**

Gas Exhauster Driven by Belt.

The Wilbraham Gas Exhauster,

"BAKER SYSTEM,"

WITH ENGINE ATTACHED, ON SAME BED PLATE OR WITHOUT.

Best, Cheapest and Most Durable Exhauster known.

WILBRAHAM BROS.,

No. 2320 Frankford Avenue, Philadelphia, Pa.

Chas. F. Dieterich's Regenerator Furnace.

CAN BE ADAPTED TO ANY BENCH WITHOUT DISTURBING THE ORDINARY SETTINGS.

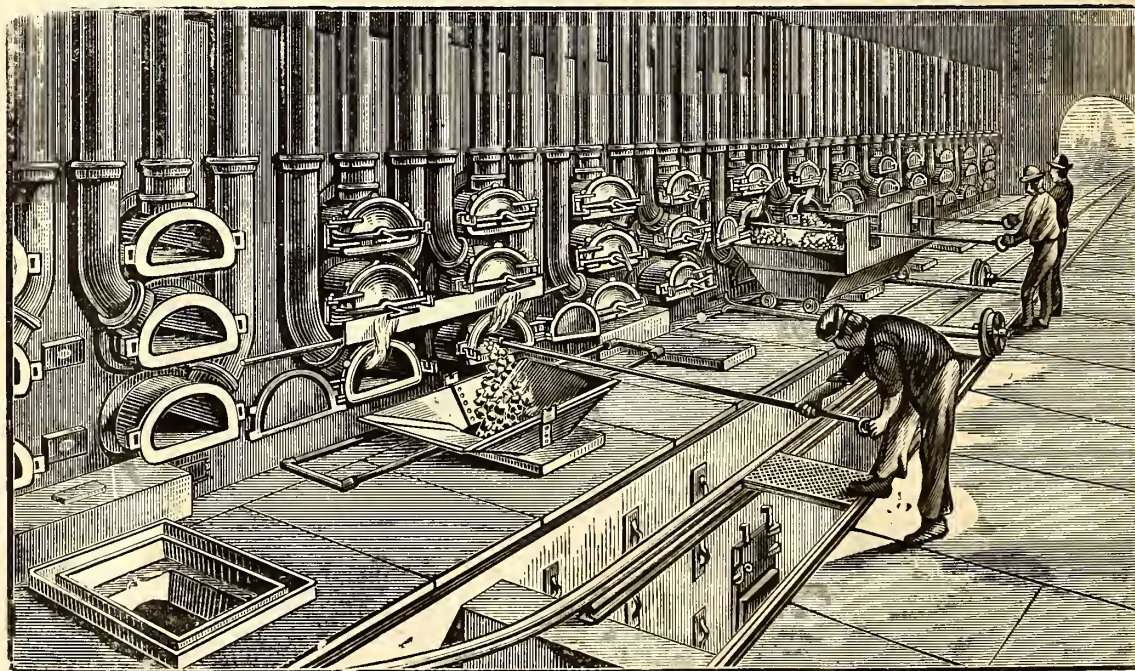

These Furnaces have been in operation at the works of the People's Gas Company, Baltimore, since June, 1878. A bench of sixes, with retorts 20 in. by 12 in. by 8 ft. 6 in. will burn off 1,350 pounds of coal in 3 hours. Twenty-five per cent. of the coke is sufficient to thoroughly burn off the charges.

We refer by permission to the following Companies who are using these Furnaces:

A. B. SLATER, Providence Gas Co. S. G. STINESS, Pawtucket Gas Co. JAS. H. ARMINGTON, Brooklyn Gas Lt. Co.

State, city, and factory rights granted on reasonable terms. For full particulars apply to

CHAS. F. DIETERICH, Engineer P. O. Box 512, BALTIMORE, MD.

GAS COALS.

GAS COALS.

GAS COALS,

Newburgh Orrel Coal Co.,

MINERS AND SHIPPERS OF

**Newburgh Orrel, Tyrconnell
and Palatine Gas Coals.**

ALSO SHIPPERS OF FOUNDRY COKE.

Mines Situated at

Newburgh, Flemington & Fairmont, W.Va.

HOME OFFICE,

25 S. Gay St., Baltimore.

**CHARLES MACKALL,
MANAGER.**

CHAS. W. HAYS, Agent in New York,

Room 92, WASHINGTON BUILDING, No. 1 Broadway.

Shipping wharves at Locust Point. References furnished when required. Special attention given to chartering vessels.

THE DESPARD COAL COMPANY

OFFER THEIR SUPERIOR

DESPARD COAL

To Gas Light Companies and Manufacturers of Fire Clay Goods
Throughout the Country.

ROUSSEL & HICKS, } AGENTS. { BANGS & HORTON,
71 Broadway, N. Y. } { 16 Kilby St., Boston.

Mines in Harrison Co., West Va. Wharves, Locust Point, Balt.

Company's Office, 15 German St., Baltimore, Md.

Among the consumers of Despard Coal we name: Manhattan Gas Light Co., N. Y.; Metropolitan Gas Light Co., N. Y.; Jersey City, (N. J.) Gas Light Co.; Washington (D. C.) Gas Light Co.; Portland (Maine) Gas Light Co. Reference to them is requested.

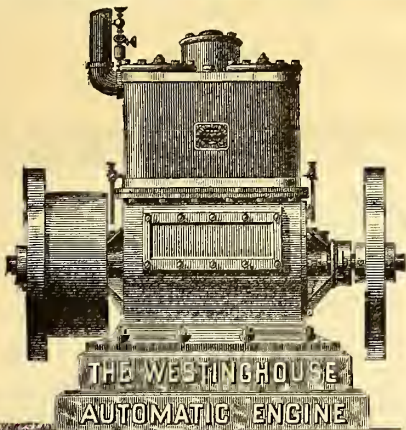

INTENDING PURCHASERS will not fail to note the unsparing and unanimous condemnation which the WESTINGHOUSE ENGINE receives—from its competitors. To the thinking man this fact is significant, and doubtless has much to do with the creation of our counter argument which we append below.
Very respectfully, Westinghouse Machine Co.,
PITTSBURGH, PA.

SALES FOR OCTOBER, 1885.

58 Engines, aggregating 2,055 H.P., distributed as follows

1 of 125 H.P.	2 of 45 H.P.	3 of 15 H.P.
1 " 100 "	2 " 40 "	1 " 12 "
3 " 75 "	7 " 35 "	3 " 10 "
1 " 65 "	6 " 30 "	3 " 8 "
4 " 60 "	3 " 25 "	3 " 5 "
4 " 50 "	5 " 20 "	1 " 4 "

Of these, 7 were second orders; 2 were third orders; 1 was a fifth order; 1 was a fourteenth order; 1 was a fifteenth order. Total, 12 repeated orders (23 per cent. of sales) from actual users.

SALES DEPARTMENT CONDUCTED BY

Westinghouse, Church, Kerr & Co., 17 Cortlandt Street, New York City.

Fairbanks, Morse & Co., Chicago, Cincinnati, Cleveland, Louisville, and St. Paul.

Fairbanks & Co., St. Louis, Indianapolis, and Denver.

Parke & Lacy, San Francisco, and Portland, Or.

Parke, Lacy & Co., Salt Lake City, Utah, and Butte, Montana.

D. A. Tompkins & Co., Charlotte, N. C.

Keating Implement & Machine Co., Dallas, Texas

Robert Middleton, Mobile, Ala.

H. Dudley Coleman, New Orleans, La.

Imray & Co., Sydney and Melbourne, Australia.

R. Rogers, 43 Rue Laflite, Paris.

F. E. Averill, Delft, Holland.

Thomas G. Foley & Co., Buenos Ayres, S. A.

**THE
PENN GAS COAL CO.**

OFFER THEIR

Coal, Carefully Screened & Prepared for Gas Purposes.

Their Property is located in the Youghiogheny Coal Basin, near Irwin and Penn Stations on the Pennsylvania Railroad, and on the Youghiogheny River.

Principal Office:

209 SOUTH THIRD STREET, PHILA., PA.

Points of Shipment:

Pennsylvania Railroad Piers; Greenwich Wharves, Delaware River; Pier No. 1 (Lower Side), South Amboy, N. J.

Chesapeake & Ohio Railway Coal Agency,

FOR THE SALE OF THE

**Superior Kanawha Gas Coals, Cannelton Cannel,
Also, SPLINT AND STEAM COALS,**

From the Kanawha and New River Regions, on the line of the Chesapeake & Ohio R'way.

C. B. ORCUTT, Sales Agent. | OFFICE, 150 BROADWAY, N. Y.

FRANCIS H. JACKSON, PRESIDENT.

EDMUND H. MCCULLOUGH, SEC. & TREAS.

THE WESTMORELAND COAL CO.

Chartered 1854.

Mines situated on the Pennsylvania and the Baltimore and Ohio Railroads, in Westmoreland County, Penn.

POINTS OF SHIPMENT:

PHILADELPHIA, BALTIMORE, SOUTH AMBOY, N. J.
WATKINS (SENECA LAKE), N. Y.

Since the commencement of operations by this Company its well-known Coal has been largely used by the Gas Companies of New England and the Middle States, and its character is established as having no superior in gas-giving qualities, and in freedom from sulphur and other impurities.

Principal Office, 224 South 3d St., Phila., Pa.

A. M. SCOTT, PRESIDENT.

A. DEMPSTER, C.E., SECRETARY.

W. K. GILLESPIE, TREASURER.

MONONGAHELA AND PETERS CREEK GAS COAL CO.,

PRODUCERS OF

Coal Bluff Gas Coal.

MINES LOCATED ON THE MONONGAHELA DIVISION OF THE PENNSYLVANIA RR.,
IN THE CENTRAL PORTION OF THE PITTSBURGH COAL FIELD.

Points of Shipment—Buffalo, Cleveland, Erie, Chicago, New Orleans.

Since the introduction of Coal Bluff Gas Coal it has taken rank among the few first-class Gas Coals, and acknowledges no superior in gas-giving qualities, ease of working, quality of coke, and freedom from impurities.

General Eastern Agents, ANDREW LANGDON & CO., Buffalo, N. Y.

Western Agents, - - - F. R. BUELL & CO., - Milwaukee, Wis.

General Office, 127 Fourth Ave., Pittsburgh, Pa.



INTERNATIONAL--1876--EXHIBITION.

The U. S. Centennial Commission

HAVE DECREED AN AWARD TO

HARRIS, GRIFFIN & CO.,

Twelfth and Brown Streets, Philadelphia, Pa., No. 49 Dey Street, N. Y. City, and No. 75 North Clinton Street, Chicago, Ill.,

FOR THE FOLLOWING REASONS :

The Exhibit consists of a Series of METERS from the Largest Size Station Meters for the use of the MANUFACTURE OF GAS, to those for the use of the ORDINARY CONSUMER. The Instruments are WELL MADE, RELIABLE as to INDICATION, and embody a number of sundry improvements which, with the general character of the Exhibit, entitle the whole to commendation.

Attest—J. L. CAMPBELL,
Secretary, pro-tem.

Signed—A. T. GOSHORN,
Director General

J. B. HAWLEY,
President.

CHARLES E. DICKEY.

JAMES B. SMALLWOOD.

CHARLES H. DICKEY.

Maryland Meter and Manufacturing Co.,

DICKEY, TANSLEY & CO.,

Established 1866.

Nos. 22 and 24 Saratoga Street, Baltimore, Md.

No. 46 La Salle St., Chicago, Ill.

MANUFACTURERS OF

DRY GAS METERS, STATION METERS, GLAZED METERS, TEST METERS, METER PROVERS, PRESSURE AND VACUUM REGISTERS, GOVERNORS, INDICATORS, SERVICE AND METER COCKS, AND METER CONNECTIONS.

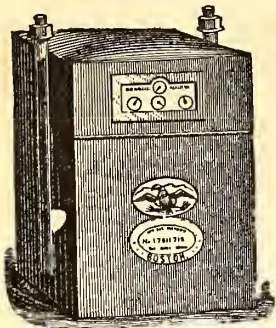

Dry Gas Meter.

With 39 years' experience and the best facilities for manufacturing, is enabled to furnish reliable work and answer orders promptly.

NATHANIEL TUFTS,

No. 153 Franklin Street, Boston, Mass.,

MANUFACTURER OF

DRY GAS METERS.

Station Meters of any Capacity.

Test and Experimental Meters, Pressure Registers, Pressure Gauges, Pressure and Vacuum Gauges.

METER PROVERS, PHOTOMETERS, STREET LANTERNS, ETC., ETC.

Patent Cluster Lanterns for Street Illumination.

SCIENTIFIC BOOKS.

We are prepared to furnish to Gas Managers, and others interested in the topics treated of, the following books, at prices named :

KING'S TREATISE ON THE MANUFACTURE OF COAL GAS. Three vols.; \$10 per vol.
GAS MANUFACTURE, by WILLIAM RICHARDS. 4to., with numerous Engravings and Plates, in Cloth binding. \$12.
THE GAS ANALYST'S MANUAL, by F. W. HARTLEY. \$2.50.
ANALYSIS, TECHNICAL VALUATION, PURIFICATION, and USE OF COAL GAS, by REV. W. R. BOWDITCH, M.A.; with Engravings; 8vo., Cloth. \$4.50.
GAS MEASUREMENT AND GAS METER TESTING by F. W. HARTLEY. \$1.60
GAS CONSUMER'S HANDBOOK, by WILLIAM RICHARDS, C.E.; 18mo., Sewed. 20 cents.

GAS CONSUMER'S MANUAL, by E. S. CATHELS, C.E. 10 cts.
PRACTICAL TREATISE ON HEAT, by THOMAS BOX. Second edition. \$5.
GAS WORKS—THEIR ARRANGEMENT, CONSTRUCTION, PLANT, AND MACHINERY. \$8.
COAL; ITS HISTORY AND USE. by PROF. THORPE. \$3.50.
THE GAS WORKS OF LONDON, by COLBURN. 60 cents.
THE GAS FITTER'S GUIDE, Showing the Principles and Practice of Lighting with Coal Gas, by JOHN ELDRIDGE. 40 cents.
GAS WORKS, AND MANUFACTURING COAL GAS, HUGHES. \$2.20.
THE MANAGEMENT OF SMALL GAS WORKS, by C. J. R. HUMPHREYS. \$1.

A PRACTICAL TREATISE ON GAS AND VENTILATION with Special Relation to Illuminating, Heating, and Cooking by Gas, by E. E. PERKINS. \$1.25.
PURIFICATION OF COAL GAS, by R. P. SPICE. 8vo. \$3.
HOW TO MANAGE GAS, by F. WILKINS. Paper. 20 cents.
THE GAS MANAGER IN THE LABORATORY, by a Practical Student. 8vo., Cloth. \$1.50.
THE DOMESTIC USES OF COAL GAS, AS APPLIED TO LIGHTING, by W. SUGG. \$1.40.
DISTILLATION OF COAL TAR AND AMMONIACAL LIQUOR, by GEO. LUNGE. \$8.50.
A TREATISE ON THE COMPARATIVE COMMERCIAL VALUES OF GAS COALS AND CANNELS, by D. A. GRAHAM 8vo., Cloth. \$3.

The above will be forwarded by express, upon receipt of price. We take especial pains in securing and forwarding any other Works that may be desired, upon receipt of order. All remittances should be made by check draft, or post office money order.

A. M. CALLENDER & CO., No. 42 Pine Street, New York,

T. C. HOPPER, Pres. G. J. McGOURKEY, Vice-Pres. (New York). WM. N. MILSTED, Gen. Supt. & Treas. (New York). WM. H. DOWN Sec.

AMERICAN METER COMPANY,

WET AND DRY GAS METERS.
STATION METERS.
EXHAUSTER GOVERNORS.
DRY CENTRE VALVES.
GOVERNORS FOR GAS WORKS.

PRESSURE REGISTERS.
PRESSURE & VACUUM REGISTERS.
PRESSURE & VACUUM GAUGES.
CRESSON GAS REGULATORS.
MARSLAND WATER METERS.

METER PROVERS.
PORTABLE TEST METERS.
EXPERIMENTAL METERS.
AMMONIA TEST METERS.
BAR AND JET PHOTOMETERS.

Manufactories:
512 W. 22d St., N. Y.
Arch & 22d Sts., Phila.

GAS STOVES,
SUGG'S "STANDARD" ARGAND BURNERS,
SUGG'S ILLUMINATING POWER METER,
Wet Meters, with Lizar's "Invariable Measuring" Drum.

Agencies:
177 Elm Street, Cincinnati.
244 & 246 N. Wells Street, Chicago.
810 North Second Street, St. Louis.
122 & 124 Sutter St., San Francisco.

HELME & McILHENNY,

(Successors to Harris & Brother. Established 1848.)

GAS METER MANUFACTURERS,

CONTINUE AS HERETOFORE AT THE OLD ESTABLISHMENT,

Nos. 1115 and 1117 Cherry Street, Philadelphia, Pa.,

To Manufacture Wet and Dry Gas Meters, Station Meters, Experimental Meters, Meter Provers, Center Seals, Pressure Registers,
GOVERNORS, INDICATORS, PHOTOMETERS, & ALL OTHER KINDS OF APPARATUS FOR USE IN GAS WORKS.

From our long practical experience of the business, and from our personal supervision of all work, we can guarantee all orders to be executed promptly,
and in every respect satisfactorily.

WM. WALLACE GOODWIN, Prest. and Treas.

WM. H. MERRICK, V.-Prest.

S. L. JONES, Sec.

S. V. MERRICK, Supt.

THE GOODWIN GAS STOVE AND METER COMPANY,

Successors to W. W. GOODWIN & CO.

1012, 1014 and 1016 Filbert St., Phila., Pa. 142 Chambers St., New York.
76 Dearborn St., Chicago, Ill.

WALDO BROS., Agents, 88 Water St., Boston.

MANUFACTURERS OF THE "SUN DIAL" GAS STOVES, FOR COOKING AND HEATING PURPOSES.

Dry and Wet GAS METERS, Station Meters (Square, Cylindrical or in Staves) Glazed Meters, King's and Sugg's Experimental Meters, Lamp Post Meters, Etc., Etc., Meter Provers (sizes 2, 5 and 10 feet), Pressure Gauges of all kinds, Pressure Registers, Pressure and Vacuum Registers, Pressure Indicators (sizes 4 inch, 6 inch and 9 inch), King's Pressure and Vacuum Gauges, Dry and Wet Centre Seals, Dry and Wet Governors, Exhauster Governors, Photometers of all descriptions. Lethby's Sulphur and Ammonia Test Apparatus complete—also Testing and Chemical Apparatus of all kinds, and of the most perfect description, for all purposes relating to Gas.

GOODWIN'S IMPROVED LOWE'S JET PHOTOMETER.

Agents for Bray's Patent Gas Burners and Lanterns.

Special attention to repairs of Meters, and all apparatus connected with the business.
All work guaranteed first class in every particular, and orders filled promptly.

G. B. EDWARDS, Mang'r, New York.
E. H. B. TWINING, Mang'r, Chicago.
A. B. STANNARD, Agent.

D. McDONALD & CO.,

GAS METER MANUFACTURERS.

(Established 1854.)

51 Lancaster St., Albany, N. Y. 34 & 36 West Monroe St., Chicago, Ill.

STATION METERS, EXPERIMENTAL METERS, METER PROVERS, PRESSURE & VACUUM REGISTERS, PRESSURE GAUGES, ETC.

Also STAR GAS STOVES, RANGES, and HEATING STOVES.

We use only the very best materials, and employ the most skilled labor, and by our long experience (29 years) and personal supervision of every detail, we feel justified in assuring the public that our goods will give perfect satisfaction. Every Meter emanating from our establishment will bear the State Inspector's BADGE, and will be fully warranted by us. Our Annual and Calendar will be sent to Gas Companies upon application.

KING'S TREATISE ON COAL GAS.

The most complete work on Coal Gas ever published. Three vols., bound, \$30.

A. M. CALLENDER & CO., No. 42 Pine Street, New York.

THE "OTTO" GAS ENGINE.

Guaranteed to Consume 25 to 75
Per Cent. LESS GAS than ANY OTHER GAS ENGINE
PER BRAKE HORSE POWER.

TWIN ENGINES Impulse every revolution.
THE STEADIEST RUNNING GAS ENGINE YET MADE.

ENCINES AND PUMPS COMBINED,

For Hydraulic Elevators, Town Water Supply, or Railway Service.

Special Engines for Electric Light Work.

OVER 15,000
IN USE.

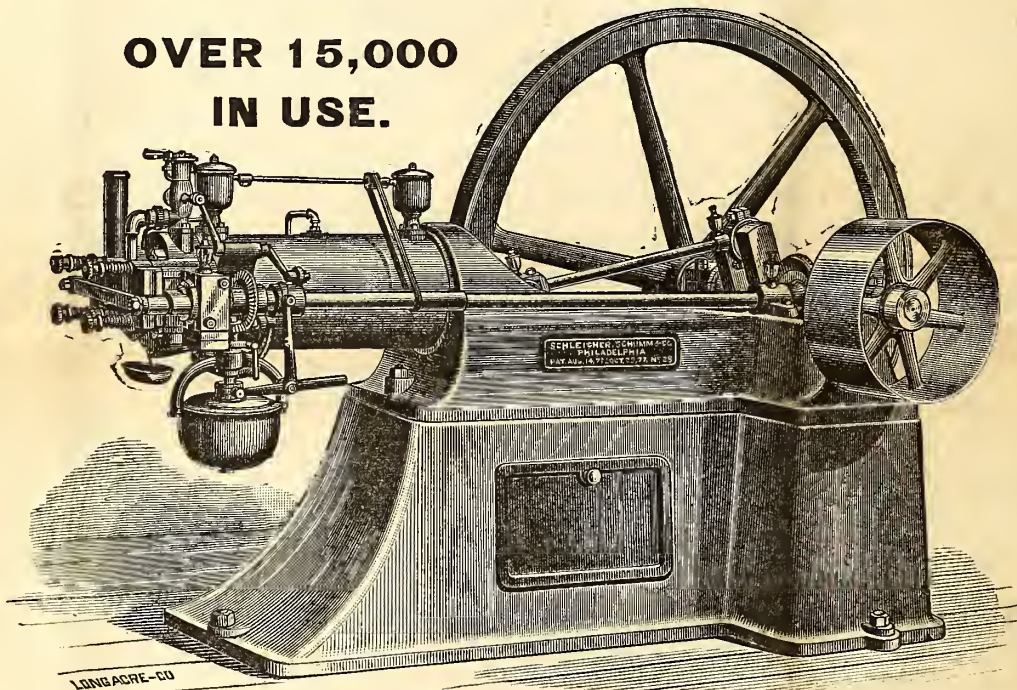

The Otto Gas Engine is now consuming, at a moderate computation, 2000 millions cubic feet of gas per year, nearly all of which is furnished during day time only.

**THE ONLY HIGHEST AWARD, ONLY GOLD MEDAL,
AT ELECTRICAL EXHIBITION, PARIS, 1881.**

MADE IN SIZES FROM 1 TO 25 HP. INDICATED.

FOR PARTICULARS, PRICES, ETC., APPLY TO

SCHLEICHER, SCHUMM & CO.,

Works:

Branch Office:

N. E. Cor. 33d & Walnut Sts., Phila., Pa.

214 Randolph Street, Chicago, Ill.

THE AMERICAN GAS LIGHT JOURNAL

PUBLISHING OFFICE NO. 42 PINE STREET

DEVOTED TO THE INTERESTS OF ILLUMINATION, VENTILATION, WATER SUPPLY AND DISTRIBUTION, & GENERAL SCIENCE.

VOLUME XLIII.—No. 11. }
Whole No. 635.

NEW YORK, WEDNESDAY, DECEMBER 2, 1885.

\$3 PER ANNUM
IN ADVANCE.

A. M. CALLENDER & CO., Proprietors. C. E. SANDERSON, Manager.
JOS. R. THOMAS, C.E., Editor.

ENTERED AT THE POST OFFICE AT NEW YORK, N. Y.,
AS SECOND CLASS MATTER.

Published on the 2d and 16th of each month, at No. 42 Pine Street, N. Y.

Terms of Subscription, Including Postage.—For the United States and Canada, \$3 per annum. European countries, \$3.50 (15 shillings—18 francs). All payments to be made in advance. Single copies, 15 cents.

Remittances should be made either by post-office order, registered letter, or bank draft on New York, payable to the order of A. M. Callender & Co.

Collections are invariably made directly from this office, for subscriptions, advertisements, etc. We have agents to solicit the same, but they are not authorized to receipt for money.

Correspondence.—Wishing to make this JOURNAL a gazette of intelligent discussion to those of our readers who may wish to gain or give information on the subjects to which its columns are devoted, correspondence is solicited for publication from all who make the study of those subjects a pleasure or a profession.

The American News Company, Nos. 39 and 41 Chambers street, New York, are agents for this JOURNAL. Newsdealers will send orders to them.

Books.—We will forward by express, at publisher's lowest rates, any book—scientific or otherwise—to any address in the United States or Canada. No books will be sent C. O. D.

CONTENTS.

An Asterisk (*) denotes an illustrated article.

EDITORIALS—

Public Electric Lighting in New York City.....	281
Friend Harbison was "Justified".....	282
Receipts of the "Novelties" Exhibition.....	282
Thirteenth Annual Meeting of the American Gas Light Association —Official Report—Continued from page 260.....	282
First Day, Afternoon Session—Natural Gas, by W. H. Denniston—Discussion —Election of Officers—Reporting Progress—Proposed Exhibition of Gas Appliances—Proposition to Change Time of Annual Meeting—The Result of a Month's Working with Limed Coal, by Jas. Somerville—Cooper's Coal Liming Process, by R. P. Spice.	
Three-Hour Charges, by A. B. Slater.....	288
Special English Correspondence.....	289
Death of Mr. F. W. Hartley—Disposal of the London Sewage—The Sulphate Market, and Direct Trade between Producer and Consumer.	

ITEMS OF INTEREST FROM VARIOUS LOCALITIES..... 290

No Charge for Gas Supplied to the Engine Houses—Electric Light for the Streets of Denver, Col.—Milwaukee (Wis.) Thinks Gas is Good Enough—A Gas Company Changes Hands—Wooden Gas Mains Still in Favor at Green Bay, Wis.—The Natural Gas Industry at Findlay, Ohio—Another "Experimental" Station—Smashing the Glass in Lamp Post Lanterns—Progress Made on the Works of the Bay State Gas Company, of Boston, Mass.—Death of Mrs. Ellis Lever—The Lights "Go Out" at Dundas, Canada—What Prof. Douglas has been Doing at Ann Arbor, Mich.—Ordered to Abate a Nuisance Chartering another Gas Company for Brooklyn, N. Y.—The Growing List.

The Market for Gas Securities..... 292

PUBLIC ELECTRIC LIGHTING IN NEW YORK CITY.

The Board of Aldermen of this city appears to have been attacked with an economical spasm, but we have grave fears that the usual remedies, or those heretofore administered on previous similar occasions, will be applied in sufficient time to counteract all danger of the said spasm becoming permanently seated. Indeed it may be confidently asserted that "the Board's economical colic" will never reach the chronic stage—and more's the pity. In view of that diagnosis it is not to be supposed that anything accruing to the relief of our metropolitan taxpayers will ever come out of the preamble and resolution submitted (at Board meeting of Nov. 17th) by Alderman Hartman for the consideration of his colleagues. This document was as follows:

Whereas, It appears, from the departmental estimate of the Commissioner of Public Works, that if the proposed substitution of 2,062 electric lights, at an estimated cost of \$526,841, for 5,135 gas lights, estimated to cost \$89,862.50 is carried into effect, as requested by certain resolutions of the Common Council, heretofore passed, the city will certainly lose the sum of \$436,978.50 each year; and

Whereas, When it is considered that, in addition to the greatly enhanced cost of electric lights, the streets and highways are incumbered by unsightly wooden poles from which are suspended wires that obstruct the streets, impede the work of the firemen in extinguishing conflagrations, and menace the lives of persons brought into contact with them when charged with the electric current—several deaths having already occurred from this cause—it is evident that lighting the streets of this city by gas is far more economical and less dangerous than if lighted by electricity; be it therefore

Resolved, That the Commissioners for lighting the city, viz.: the Commissioner of Public Works, in conjunction with the Mayor and Controller, be and they are hereby authorized and directed to discontinue the use of electricity in lighting the public streets of this city when the existing contracts therefor shall have terminated, and immediately where no such contract exists, and that thereafter no public street, avenue, highway, or public place, except the front of the city and public parks, shall be lighted by electric lights at the expense of the corporation of the city of New York." The matter was referred to Committee on Streets.

Now, it would appear from the above as though Ald. Hartman had made out a pretty good case against the electric lighting of the city's streets; but it would seem equally clear that he convicts "the Board" of either imbecility or knavery—possibly of both, since its membership may, without any great stretch of imagination, be supposed to contain a fair sprinkling of each sort. "The Board" knew very well—when it was at divers times so lavish in passing resolutions authorizing the erection and maintenance of electric lights at certain points—what such lights would cost the city; and it was also its business to be conversant with the cost of the gas lights which were to be displaced. Still, things of so trifling a nature are not to be seriously considered by "an alderman;" and we must confess that the portion of the resolution "directing" the Gas Commission to forbear from future renewal of existing electric lighting contracts is ridiculous in the extreme; and ridiculous simply on account of the tender relations involved (by at least one member of that body) between it and the electrical promoters. Our highly belauded reformer-Mayor, Mr. Wm. H. Grace, was "at one time" an ardent believer in the virtues of arc electric lighting, and believed in it to such a degree as to cause him to become an investor in the shares of one or more of

the electrical companies formed in this city some three or four years ago. We should not wonder if he were a shareholder still; and on the presumption that such is the case, "Gas Commissioner Grace" would quite naturally not wish to "stand in the light" of "electrical investor Grace." By no means; but would rather believe in lighting the city (electrically) well, even if the price of each arc furnished does amount to the round sum of \$255.50 annually. This supposition opens up the possibility that certain members of the aldermanic body are in opposition to our reformer-Mayor, and would thus basely seek to interfere with the profitableness of his "electric" shareholdings. On the other hand, of course, appears the well-known inclination of our city fathers to "turn an honest penny" on every possible occasion; and their financial scent may have been quickened somewhat by the intimation that the local Brush Company declared a dividend on its shares during last November. In either case, whether they seek to "wing" the Mayor or "earn the penny," in so far as our attempting to find a motive for Alderman Hartman's action is concerned, we submit that but little hope is held out for comforting assurance on the part of the taxpayer.

It is a mistake to suppose that the gas companies of New York city are over-anxious for the securing of the city's street lighting at the prices at present paid. A schedule of 4,000 hours, with burners consuming in excess of the stipulated quantity, is recompensed at the rate of \$17.50 per lamp per annum—and one company (the Equitable) is in fact supplying the lamps located along its mains at an annual charge of but \$12. Those conversant with the conditions of gas manufacture and distribution in New York city will at once concede that money must be lost (in this latter case) to the purveyors if the stipulations of the contract are faithfully carried out. But while the authorities are so exacting with the gas companies, witness their prodigality to the electrical promoters.

At the present time there are 703 public arc lights maintained by the municipality, at a total cost of \$179,616.50; and these arcs displace 3,210 gas lamps, the former total cost of same being but \$56,175. No doubt it is true the light afforded by the arcs is greater than the volume formerly supplied by the displaced gas lamps; but he who would claim that (were the amounts expended for electricity and gas equal in sum) the city was more efficiently illuminated by the former than by the latter lighting agent, could certainly be looked upon as a possible owner of electric lighting shares. Perhaps the 1886 Board will be less favorably disposed toward the electrical promoters than was its predecessor; but we incline to the idea that relief may not be looked for in that direction.

FRIEND HARBISON WAS "JUSTIFIED."

Mr. Jno. P. Harbison, of the Hartford (Conn.) Gas Light Company, had quite a unique experience recently, and in view of the peculiar circumstances attending the case we herewith present a summary of the same. Mr. H., as previously reported in the JOURNAL, has been engaged in making alterations to the mains of the Hartford Company, and has been watching the work pretty closely. Towards dusk on one evening in November a gang of pipe layers were about finishing a particularly nice piece of main substitution, when a slight accident occurred in the handling of the pipe that momentarily allowed of the escape of a large volume of gas. Mr. Harbison was close by when the event happened, but before he could reach the exact spot of difficulty the usual crowd of loungers had closed in about the place. Pushing his way through he had gained the edge of the trench, when he noticed an onlooker peering into the cut and calmly smoking a pipe. Mr. Harbison shouted to the fellow (his name is Corcoran), "Stand back; there is danger in that pipe;" and failing to do as requested, Mr. H. shoved the offender down the trench bank. Corcoran immediately struck out at the gas man, and probably had cause to repent of his action, as the Hartford Company's Treasurer speedily "sent him to grass." Mr. Harbison instructed a police officer to arrest Corcoran, and that worthy was conveyed to the lock-up. Next morning Mr. H. appeared in court to make a charge of assault against Corcoran, and was rather surprised to find himself placed in the position of being called upon to answer a similar charge preferred by Corcoran. When the testimony on both sides had been given the Court decided, "It was clear Mr. Harbison was not to blame in the premises. His conduct was in the interest of everyone concerned in the repairs to the pipes, and in that of the people who had to pass the place. He interfered, with more or less violence, to prevent an accident. The justification of Mr. Harbison's act inhered in the fact that there was danger, and his course was undoubtedly in Corcoran's interest as well as in the interest of others."

Mr. Harbison not caring to press the charge against Corcoran that offender was discharged. Superintendents of gas companies might do well to "post" their men in regard to this decision.

RECEIPTS OF THE NOVELTIES EXHIBITION.—Mr. H. R. Heyl, of the Board of Managers of the Franklin Institute, reports that 145,000 persons visited the "Novelties." The gross receipts were \$43,000.

[OFFICIAL REPORT—Continued from page 260.]

Thirteenth Annual Meeting of the American Gas Light Association.

HELD AT COLLEGE HALL, CINCINNATI, OHIO, OCT. 21, 22, 23.

FIRST DAY—AFTERNOON SESSION.—WEDNESDAY, OCT. 21.

The next paper read was that presented by Mr. W. H. Denniston, Supt. of the East End Gas Light Company, of Pittsburgh, Pa. It bore the title of

NATURAL GAS,

and is as follows:

There is no apology necessary, and so none is offered, for the writing of this paper. The reason for its preparation, shortly and simply stated, is that I was asked by our Secretary to prepare an article on the subject of "Natural Gas," and I returned him an affirmative answer. If the choice of subjects had been left with me, this one would not have been selected; but I have undertaken it in the hope that a short article, of modest pretension, as to experience with, or knowledge of, the subject, would open up a discussion on the question, so that others who are more able, and have had greater experience in the premises, might debate the various phases regarding its utility (also the probable results), and the likelihood of its becoming a competitor with coal gas as an illuminating or fuel agent.

I remember at our last meeting one of our members thought the subject hardly worth discussing, because of the limited extent of territory where natural gas was to be found, and because the prospect of its approaching to anything like an important competitor of coal gas was too remote.

Since that meeting there has been a regular boom in natural gas. Within the past few months large sums of money have been expended in developing gas territory, and even in "wild catting" and prospecting. Of course, it is known that natural gas had been found in a great many places—indeed nearly all over the world; also that in many of the States and Territories, and in Canada it had been discovered in paying volumes, and utilized in salt manufacturing operations, and as fuel for steam boilers, etc. Ten years ago, or when I was interested in producing oil, I remember how pleased we were to obtain from one of the wells a strong flow of gas. It was used under several boilers at first; then, as the pressure weakened, a fuel supply for only one boiler could be obtained; and finally we had again to return to the use of coal. In very many places, therefore, it was known and used to a limited extent; but this present general utilization of natural gas is of quite recent growth. In my own immediate neighborhood (Pittsburgh, Pa.) where a short time ago the capital invested was counted by thousands, and where it had been in use to some extent for years, there are now millions of dollars in the business, with a prospect of millions more being put out in the same direction before the maximum of such ventures will be reached. We can better realize the immensity of this business in and around Pittsburgh by means of comparison. Take a single manufacturing establishment that had been buying—not a single car load of coal—but the contents of an entire train of 50 or 60 coal-laden cars every day in the week. The cessation of that single purchaser would in itself materially curtail the output of some of our largest mines; but that single stoppage is a "mere bagatelle." Imagine, if you can, a great city with its wealth centered in its manufacturing establishments—many of them gigantic in their proportions—and picture all, or nearly all, of these immense establishments employing natural gas for fuel where formerly coal alone was used, and you may form some idea of the magnitude of the revolution in heating methods. Why, there is a single corporation, only a few months old, whose capital is now between four and five millions of dollars; and it would require the foresight of an Elijah to predict what its capital may be one year hence. That corporation is now selling at the rate of 1½ to 2 millions dollars worth of gas per annum, and is then not disposing of its entire product. Computed at the same rate as that sold, nearly another million dollars' worth goes to waste.

But this natural gas industry or field of production is not confined to Pittsburgh and vicinity. As I have said, it has been found in nearly all parts of the globe; and, therefore, as there "is no telling where lightning may strike," so also is there no predicting where the next gusher will be found. Indeed, who will say, judging the future by the past and present, that ere long Western Pennsylvania may not be piping fuel to the metropolis, and Eastern Ohio—supplying Chicago and the West with a cheap substitute for corn-cob fires!

Well, when found what is it? It is as different as the different grades of petroleum or rock oil. In some places the illuminating qualities of the gas are placed at 10 to 12-candle power, when used in ordinary burners. In the vicinity of Pittsburgh—especially the Murrysville gas—the illuminating value is of only about 8-candle power. In its crude state it affords a very good fuel medium, but it is a poor illuminator.

Nearly two years ago, or when the first natural gas pipes were laid within our city limits, and in our "East End" district, I had a pipe run to the gas

works, and endeavored to make an illuminating gas out of the natural product. I succeeded, too.

Now, I am not a chemist, nor do I claim to be an expert gas engineer; but, for a short time, I had the valuable assistance of Messrs. Robert Young, of Allegheny City, and J. H. McElroy, of the old Pittsburgh gas works. You all know who and what they are, and are conversant with the fact that they are not novices in our business.

The only experiments of which I have personal knowledge were those made by the aid of the crude apparatus then at hand. The gentlemen named have since made more extensive and more careful investigations; but the result originally reached was that the product from the wells in the Murrysville neighborhood was almost a pure marsh gas, having about 8-candle power. It needed no purification, and was almost odorless. Heating it made no difference in its quality. We passed it through small pipe and large pipe; through iron and through clay pipe. Under high heats and low heats it was still, comparatively, the same. Then we used rich coal gas, petroleum—crude and refined—also gasoline and benzine as enrichers, and made gas of different grades—that is, it differed in its illuminating qualities—but, everything considered, it was an unsatisfactory substitute for coal gas as an illuminating agent. The experiments, though, were well worth the trouble and expense to which we had been put, for we felt that natural gas would not immediately destroy the coal gas interests, whatever might be the result in the unknown future.

We did not claim all the wisdom in the world, or that we had exhausted every device for gaining the end sought, and we did not assert that something would not be forthcoming to make it an active competitor; but we felt easy, at the time, as to our coal gas investments, although it was even then apparent that natural gas would soon be the fuel for the mills.

We found that the kind of burner used would make a difference as to the amount of light afforded by a given quantity; also, that, if there were too large a quantity of the naphtha enricher used, the gas would smoke; if not enough, a blue flame was the result. In either case the gas was unsatisfactory. It was next to impossible to regulate it so as to ensure a steady or unvarying quality of illumination—indeed, at times, there is a decided variation in the composition of the gas that issues from the same well. While this experimenting above noted was going on—you may believe it or not—my position was far from being a "happy one." All along the line there was a howl about poor gas, just as soon as it became known that experiments with natural gas were being made. It was some months after it had been entirely cut off before I could convince our customers that I was selling them coal gas.

It was not so much the quality that caused the dissatisfaction, but rather the idea that I was still sending out natural gas and selling it to them (mixed with benzine) at coal gas prices. I challenged tests; I told them they were getting good 17-candle power coal gas. The experiment had a most demoralizing effect, and I do not now know that our company has entirely recovered from it yet, although during the past year we have thrown a "sprat to the whale" in the shape of a 20 per cent. reduction from the price then charged.

Since the time I speak of "companies and companies" have been formed; private parties have invested and speculated; individuals and companies have been bought out, and combinations have been effected. The territory of Messrs. McElroy and Young has been invaded, and they have sought to and do control, at least to a large degree, what at first seemed to be an influential competitor. Now gas of both sorts—for lighting and heating—is being delivered by them to the same class of customers, through different main systems, of course. They at last seem to be satisfied that natural gas has come to stay for some time, and so have made their preparations accordingly. In other localities where natural gas has been found and utilized, in nearly every instance a diminution of the supply has been observed. This is especially the case at East Liverpool, Ohio; Erie, Pa., and throughout the oil territory of Northwestern Pennsylvania, and even at Sharpsburgh, near Pittsburgh, as well as at other places of lesser note. Like the great oil pools, the end may come, and in the same way.

The supply around Pittsburgh now seems inexhaustible, and it is found on all sides of the city—to the north, south, east, and west. Whether it is inexhaustible or not is the problem now in process of solution. The oil supply in the most wonderfully prolific districts did dwindle down to "oil." The gas output may follow the same course. The gas-containing strata developed in different ages of the world's formation may not have sufficient capacity for storage of an indefinite supply, and the manufacturing facilities "down below" may not be equal to the demand. What causes it? Why is it found in certain localities and not in others? Is it of animal or vegetable origin? Or is it of animal origin in one place, and vegetable or a compound of both sorts at another place? These are all questions upon which there are held all sorts and varieties of opinions. This fact, however, remains—those of us interested in coal and coal gas, who are residents of the natural gas bearing sections of the country, need to learn all we can about this very subject.

Already parties are claiming that plans have been perfected which will insure its use for illumination as universally as it is now being employed as a fuel. It is a menace to the coal gas interests. Whether or not it will injure such interests to a greater extent than has been done by water gas, electricity, or other lighting methods, no one can foretell with certainty. If made a success as an illuminant, there is no good reason why the coal gas companies should not employ it in connection with their present plant, for the reason that a large proportion of their capital is invested in street mains, and changes can be easily and cheaply made in our distribution systems if found desirable to supply natural gas either in part or in whole.

The pressure at which the gas is delivered in the city of Pittsburgh will soon be regulated by means of high and low pressure pipes. The large or delivery mains from the wells will be maintained at heavy pressure, while the mains for tapping and distributing the output to consumers will be carried at low pressure.

I have used natural gas as fuel under the retorts, and found it a good substitute for coke. I only used it when there was a demand for all the coke made. I then paid (for a quantity of gas equal in fuel effect to the coke that would have been used) a sum equal to what the coke would have been worth in the yard. In that way I supplied my coke customers, and used their money in turn to pay for our fuel gas.

Since writing the above I mentioned to a friend that I had prepared a short article on the subject of "Natural Gas," which was to be read at the next meeting of the Association. He in turn asked me what I thought of Emerson McMillin's article on that subject. I had to plead ignorance, because I had been away from home at the time that paper was published in the AMERICAN GAS LIGHT JOURNAL. On my return I did not have time enough to spare even to read the daily papers; so I did not hunt up the JOURNAL which contained the paper mentioned until last Sunday. On that day I looked it up and read it over carefully. It furnished me with excellent Sunday reading. Our Secretary knew of that paper, and I can hardly understand why he should have asked me to dilate upon the theme after Mr. McMillin had handled it so carefully. I would recommend those who have not seen the McMillin article to get a copy of the JOURNAL (date of August 17, 1885,) and read it. They will find a vast deal of information on this subject that is presented in a most interesting manner. I know the difficulty experienced in inducing members to prepare papers to be read and discussed at our annual meetings; and while I would have preferred that someone else had been called upon to formally present this question, I feel that I have only performed a duty in complying with the request of the Secretary. I leave it with the Association to decide whether or not the matter presented by me is worth their discussion.

Discussion.

Mr. Deuniston—In the paper I have made some facetious remarks about piping gas to the Metropolis and to Chicago. While reading the newspapers yesterday I noticed that a proposition had been mooted by capitalists to convey natural gas in pipes to the seaboard; so that although I have referred to the project in a humorous way, there may be really more in it than we now anticipate.

The President—This is a very interesting subject to all of us, and I hope the paper will meet with a full discussion. Perhaps some of the members would like to ask Mr. Deuniston some questions. He is no doubt prepared to answer them.

Mr. Wood—Does Mr. Deuniston know whether they are using natural gas in the gas works at East Liverpool, Ohio?

Mr. Deuniston—Yes, they are; but the supply has diminished quite perceptibly. Some years ago, you will remember, they started a coal gas works there. Afterward they used the natural gas; and they have carbonized no coal for a long time. I understood from the man in charge that the supply of natural gas was becoming so limited that perhaps they would have to return to the use of coal again.

Mr. Wood—What was the pressure at East Liverpool?

Mr. Deuniston—I cannot state; I know, however, that it varies (in the Pittsburgh, Butler, and Venango districts) from 5 to 500 pounds. It has been diminishing rapidly in the immediate neighborhood of Pittsburgh. The wells struck in my own district at first had quite a strong pressure, but it has been diminishing. They do not pretend to rely upon them now for a supply, but are bringing the gas from points further south, or where the pressure is from 50 to 300 pounds. They are now laying 12 to 15 miles of 24-inch pipe to wells where at first they had but a 6 or 8-inch pipe, in order to supply what is now needed for the mills about the city. The Consolidated Company referred to in the paper has between 250 and 300 miles of pipe laid in and about Pittsburgh. There are probably 500 miles of pipe in the neighborhood of Pittsburgh at the present time—all intended (and needed) to furnish the supply of natural gas.

The President—What is the amount of natural gas distributed per day in Pittsburgh, estimating by the amount of coal displaced?

Mr. Denniston—I asked for some data about that, but am not sure that I have it. I can only tell you they are distributing now to about 50 glass works and say fifteen hundred private consumers in the two cities. The demand is constantly increasing. They cannot begin to hire the requisite labor for the necessary work of fitting the houses for the supply of fuel gas. I am speaking now of private houses in which the gas is to be employed for cooking and heating. I was told that this Consolidated Company had outstanding contracts approaching an annual value of $1\frac{1}{2}$ millions of dollars. This sum, of course, included all gas supplied. In supplying the gas for fuel and heat they use a special cut-off valve. As you are aware, the gas flow ceases—momentarily, it may be—and then goes on again. That peculiarity would make its use as a domestic fuel very dangerous. It is easy to imagine what the result might be, under the circumstances, in the case of a heating or cook stove. They have a valve so arranged that when the supply stops no gas can enter the building till one goes outside and turns it on again. In that way they claim to obviate what was a very serious objection. I am asked a question as to the amount of coal displaced. I am told, in making contracts, they make a reduction from the price of lump coal of from 10 to 20 per cent., depending upon the amount consumed, the method of consumption, etc.

The President—I saw a statement to the effect that the displacement is equal to 10,000 tons of coal per day.

Mr. Denniston—I think the amount of coal supposed to be so displaced in Pittsburgh, as near as we can judge, is not far from 10,000 tons per day. Nearly all the manufacturing concerns are using it—that is, those who can get it. They do not use any coal where they can get the gas. There are pipes sticking up and flaming all about our city, and the place is illuminated at night by the flame from gas pipes so standing up in the air. In addition, along many lines of pipe, the people out in the country are using the gas (where it is escaping from the pipes) for heating and cooking.

The President—What arrangement do they make in private houses for the use of the gas? Do they have to change the ranges? Does it displace all other fuel in private houses?

Mr. Denniston—Yes. I have it in my own house. It is run in through a separate pipe. Of course, there is an entirely separate plant, mains and services. It is run into the house something like the ordinary coal gas service; and then the pipes are run up through the flues of the building. The pipes are not run around the walls nor under the laths; they do not want to put them in in such way; but they use your flues to place the pipes in them. For instance: In an eight-room house, four rooms above and four below, they run the pipe up through the flues from below, bringing it over the cellar to the flue, and bringing it out at the grate on both the first and second floors of the house. It goes up from the cellar into the flue, and comes out at the grates. Of course, the pipes can be run under the floor or around the room, but they prefer not to do so, because they do not think it is as safe. In their way of arranging the pipes should there be any escape of gas, by reason of displacement of the joints, or from any other cause, the escape goes into the flue, and is carried to the outside.

Mr. Leach—What do they charge for gas, and how do they estimate the quantity consumed? I judge that they do not meter it.

Mr. Denniston—They started out with meters, but some of those with whom I conversed thought it better not to have meters. As long as they had such an enormous supply I advised that no meters be used, but supply the consumer with all he wanted; that when the supply decreased, then would be time enough to resort to measuring. The meters, as a rule, have been removed; but in some places they are still in use. Some of the smaller companies on the south side use meters; and in that case they sell the gas for ten cents per thousand cubic feet. They started out on a basis of 50 cents, but now make their contracts according to size of house supplied. They have a maximum and a minimum price for a certain size of house; and they will supply you with all you want for the maximum price. Suppose you could, by economy, get along with \$50 worth of gas per year, but that if you turned it on and used it generously you might take up \$75 worth—they will charge you \$75 for the supply, and you can use it or not. If you do not use it, they have the maximum amount anyhow; so that they are safe in that event. I do not believe the natural gas sold in Pittsburgh today would average over three cents per thousand feet if sold by meter. It seems pretty low, but there is a vast quantity also that is wasted. When (as the result of a diminished output) meters will be employed to register the quantities consumed, I think we will witness far greater economy in its use.

Mr. Harbison—This natural gas topic is a most interesting one to us, whether discussed in Pittsburgh or at the meetings of this Association. I have been a greatly interested listener to what Mr. Denniston said in his paper, and also to the remarks made by him in the discussion. The practical question for us is, "In what way can we reap some benefit in our cities from the use of this wonderful natural gas?" I was particularly impressed by a statement that a company had been organized for conveying the gas to the seaboard. I wish the company might continue its effort and solve the

problem of carrying it to some of our inland towns. The greatest practical question with us now is, "What does our gas cost in the holder?" And in view of that it would seem pertinent to inquire why not use meters in the supplying of natural gas at Pittsburgh. Would not that plan check the waste complained of, and permit of diverting the surplus to those cities and towns not on the lines of the gas bearing territory? Once brought to such unfavored locations, the conveyors of same could sell their "gassy merchandise" to the local gas companies; and these latter might carburet or enrich it up to an illuminating power of 17 or 18 candles, and distribute the same to their consumers. Why cannot this be done with profit to the companies controlling the natural gas supply, and why would it not insure a great saving to the gas companies that would buy it? Perhaps it would enable the gas companies of New England particularly (for they are a conscientious people) to bring the selling price of 17 or 18 candle gas down to \$1 per thousand cubic feet! This is the point that all New England gas men have in their minds—\$1 per thousand cubic feet. We do not wish to receive a higher price than that for our gas if, by selling it at that price, we can pay a sufficient dividend to our stockholders. New England shareholders are not very exacting. They are satisfied with a return of anywhere from 8 to 20 per cent. per annum. If we can obtain this natural gas so much cheaper than we can make gas from coal, it will enable us to reach the dollar figure, and thus clean out all oil lamps and electric lights, and yet sell our gas at a profit. I wish Mr. Denniston would suggest to the gentlemen who have organized a company for the purpose of carrying the natural gas to the seaboard that they should not forget the New England towns. Give us some of the gas that is now going to waste at what, to them, would be a remunerative profit, and thus enable us, after paying fair living salaries to our managers and employees, to get our gas down to the dollar mark and still return a sufficient compensation to the stockholders. I believe that will be a movement in the right direction. I have seen the natural gas burned in Bradford, Pa., for lighting and heating, and I have heard of it in Pittsburgh. While I have not seen it there yet, I have seen in that city the pipes through which it was being conveyed; and I may add that one pipe went through the gas works. I will not say there was an outlet from it to the gas works; but the pipe entered their premises. They had a pretty strong pressure there, and I thought if that pipe were connected with our Hartford holders I would not be in any danger of leaving the city without a supply of gas, however dark the nights might be. If I could get the gas into our holders, under sufficient pressure, I would not care particularly about regenerative furnaces, enlarged retort house room, or anything of that sort. I do wish some practical idea of that kind may be carried out. I hope Brother Denniston will not stop where he is, but will try to see whether something cannot be done in the direction indicated. We could then sell our coke much more easily, as we would not make so much, and would get better prices for what we did make—which would help us out on our residual account. I think in Connecticut we should have to bore pretty deeply before striking a natural gas vein. I do not think, if we bored in the vicinity of Boston, we could strike a natural gas vein there that would raise our holders, or our hopes, very high.

Mr. McElroy—I made a two-inch pipe connection to supply natural gas to our holder; but, as Mr. Denniston says, the consumers can tell it just as soon as it is sent out. As quickly as one per cent. of natural gas was mixed with the coal gas the consumers observed the change. A mixture of natural gas and coal gas affords such a light body that it will not hold the flame; the least puff of wind will blow it out. We used a very small percentage of natural gas, enriched to proper degree, in mixture with our coal gas, and then found that our street lamps would become extinguished during stormy nights. As a consequence I took out the pipe which Mr. Harbison thinks would be of such advantage to him; and do not now use a foot of natural gas, nor a particle of oil. I have not done so for over a year. Of course, like all the others, I desired to see what was in it. I was deeply interested in making the experiment; and on its termination came to the conclusion there was no money in it. We found, when enriched to the proper standard, that it cost us more than we could put coal gas in the holder at. I would not take it as a gift and make illuminating gas from it.

Mr. Helme—How did you regulate the pressure?

Mr. McElroy—For private consumers we had what is called a "suspension valve," which will only permit of a certain pressure from the main. At that time it was the only way of supplying it. The valve would furnish the pressure to which it was adjusted. If the gas were shut off—as, for instance, during repairs in the streets, etc.—that valve cuts off the supply, which cannot be renewed until the pressure is restored, when the valve reopens. This, of course, limits the danger of explosion. With the low pressure main, as at present employed in Allegheny and Pittsburgh, a small opening controls the valve so as to keep the pressure in the city at a uniform rate. Practically natural gas is inodorous. It does possess a slight and peculiar scent; but as it issues from the wells the odor given off would be a poor guide to the

source of emission. They are now taking extreme precautions in the laying of pipes. The pipe joints are made with a ring surrounded by broken stone; that is covered with tarred paper which leads up to a funnel, and the funnel goes to the sidewalk. At these funnels you may "smell for it" or "light for it," and so detect leakages. If there is a leak we can tell whether it is in a main pipe or at a joint; and whether it is the manufactured or natural gas that is escaping. We can always tell our gas from the natural. One trouble is they are constantly digging up our streets and breaking our mains while laying their pipes. I think natural gas has been of great benefit to Pittsburgh, although it has ruined our coke and coal trade. Men who were retailing 13 or 14 car loads of coal per day do not now retail one. Formerly I could sell all my coke at home; now I cannot sell one-tenth part of it. I have either to give it away or throw it into the river. The quantity of natural gas which is now being used in Pittsburgh is incalculable. A six-inch pipe will deliver 14,000,000 cubic feet per day. I suppose there are 10 ten-inch pipes; 24 six-inch pipes, and 10 or 12 eight-inch pipes, all leading into Pittsburgh. The 24-inch pipe spoken of by Mr. Denniston is not yet finished. It is being laid by a Philadelphia company. Just as soon as that is down they intend to duplicate it; and then the facilities will not be large enough. When the mills stop the valve lifts and the gas flows off. Two or three injunctions have been served to stop that practice. The people would not stand the noise or heat in summer. The gas must be allowed to escape somewhere. One man ran his escape into the river, and the boys inquired why "the water was blowing up so high."

Mr. Harbison—Has the sale of natural gas reduced the sale of your coal gas?

Mr. McElroy—No; we are increasing our output rapidly. A proposition has been made to us by which the proposers agreed to put the natural gas into our holders at a cheaper rate than we can place coal gas in them. They have not yet succeeded in doing it.

Mr. Howard—Do they use the gas under low pressure in manufacturing establishments?

Mr. McElroy—No; as Mr. Denniston says, they are very careless in economizing the gas. Sometimes the high pressure fractures the pipes and curtails the delivery; and, consequently, those who require a very high pressure have to quit, while those who can run at very low pressure continue. There is one manufacturer there who can run under a four-inch pressure. He can run all the time; others cannot. The use of this gas saves from 8 to 10 per cent. in the oxidation of material. If there is any impurity in the iron, such as phosphorus or sulphate, it is burned out. It makes a better iron out of the same stock than coal does. Our flint glass men were formerly obliged to use covered pots—which were very costly—because they could not make that material without protecting it from the fumes of the fire. Now they are making it in tanks. They build a long tank right over the furnace, into which every man dips. In that way one blower does not get ahead of another. The men are enabled to turn out 50 per cent. more glass. With a coal fire if a workman was "blowing" any article he had to quit and go home as soon as his pot was burned out. Now they can all work till the tank is empty.

Mr. Clark—I would like to know what percentage of enricher is used in carbureting the natural gas to 16 or 17 candle power. Also, how natural gas compares with water gas as a diluent.

Mr. Denniston—I cannot reply to the latter question, as I have had no experience with water gas. I can answer you, however, about the other. As I recollect it—taking the gas from Mr. Young's works—the proportion necessary to produce a gas of 18 to 20 candle power was 600 parts coal gas, 300 parts natural gas, and 100 parts benzine or naphtha. The results given are those obtained two years ago; I do not know what has been done since. We found that mixture would make a very good light. Could we have kept it constantly at that grade it would have afforded a satisfactory light to the consumers; but, as Mr. McElroy remarked, there was no economy in that kind of gas. We found we might as well make coal gas as to be bothered with the mixing process. Even though we got the natural gas for nothing, the expense of working it up made it equal, in the end, to the cost of the coal gas. Whenever it comes to the point that you can get natural gas at a price to compete with coal gas, and so that you can make both fuel and light out of it, then you may have reason to fear it. Till that time I do not fear it as an illuminant. A question was asked about metering natural gas. There is a meter in process of construction now (and I give this information for the benefit of the meter men of the Association) which is calculated to work by "injecting the gas at one end and passing it out at the other." I do not know whether or not it is to be protected by letters patent, but the experimenters are working at it now. It will be a machine somewhat on the principle of the steam engine register, with inlet and outlet. If it is ever perfected, I do not think there will be much of a field for it until the output of natural gas has largely decreased from the present volume.

Mr. McElroy—A patent has been applied for.

The President—Did you experiment with natural gas pure and simple as an illuminant?

Mr. Denniston—At our East End works we tried that experiment. Afterwards I found that the very trial I was engaged on had been gone through with once before—and here comes in one advantage of our Associations, in that these reunions afford us knowledge of what has been done in different places, thus preventing repetition of experimental work on the same lines. I tried the experiment of heating the gas, and running it through coiled pipes of large and small sizes. Then I placed an ordinary six or eight-inch gas pipe inside the retort, or after the manner of an inside retort, and closed it up. The clay retorts were destroyed in a short while—of course, pure natural gas was being then operated upon. I next attempted to run naphtha in with it; but it would not work. The gas would invariably smoke. The ceilings in consumers' houses were speedily blackened, because of the naphtha experiment. The poorest results were experienced when we attempted to use the least quantity of coal gas. In fact the only satisfactory light obtained from the natural gas was when the mixture consisted of 600 parts coal gas, 300 parts natural gas, and 100 parts naphtha. I may say this afforded a fairly good light, but it was a hard matter to keep it steady in grade. Mr. Young attempted some experiments with other ingredients, and with different proportions of the same ingredients; but the trials all resulted in failure.

Mr. McMillin—It does not follow because the Pittsburgh gas is not a good illuminant that a like state of the case will be reported from other sections where natural gas is found; and it does not follow because it is odorless at Pittsburgh that it will also be odorless elsewhere. In fact I have in mind a place, not very far from Pittsburgh, either, where the natural gas possesses considerable odor. In the new district at Findlay, Ohio, sulphuretted hydrogen is so prevalent in it that the gas ought to be purified to remove the foulness of smell. I say it ought to be, although they are using it in an unpurified state. I have been much interested in the paper of Mr. Denniston, and in the discussion. I am glad to see the Association is beginning to realize the fact that, in the supply of natural gas, it has a "big elephant" on its hands. A year ago you would hardly have listened to such a discussion as the one brought out here to-day. I doubt not there will be gas wells put down all over the country. Within five years there will be some town in every State of the Union lighted with natural gas. There is no reason why friend Harbison should need to take his supply of natural gas from Pittsburgh; he may get it in New England. The question of the use of natural gas is exciting interest here in Cincinnati. It is barely possible that General Hickenlooper may have a competitor in the natural gas supply, although there are now no natural gas wells of any importance within 200 miles of him. You may be surprised to hear that there are gentlemen in this city who have been in correspondence with me for some time, and who are figuring to bring gas through 200 miles of pipe to Cincinnati. The parties who have the matter under advisement supposed it would take about three million dollars to accomplish the task. No doubt three million dollars will do a great deal; but it appears the cost of that pipe would probably be $2\frac{1}{2}$ times three million dollars. I have made some figures on it. The gentlemen I have referred to said to me that the capitalists investigating this question will not be frightened out if the cost does not exceed ten million dollars, provided that outlay will bring fifty millions feet of gas per day to the city of Cincinnati from the Big Sandy region. It is, however, probable that wells can be put down at a point much closer than Big Sandy. The field that supplies Findlay extends through here. In fact Cincinnati is the very keystone of the arch; but, owing to the erosion of the river, the gas has probably escaped in past ages, and has not been accumulated. But the field of supply extends on down south. Towas in northwest Ohio will have natural gas in abundance after a while. Columbus will have it also, and will not have to go more than thirty miles to get it. I think that gas wells in the lower Silurian, the horizon that Ohio obtains gas from, could be successfully tapped 50 or 100 miles nearer to Cincinnati than is the Big Sandy Well. I was in Pittsburgh a few days ago, and was surprised to see the wonderful change in that dirty city. I inquired of some parties, who had been using gas for some time, as to its cost. The rule there, as generally understood, is for users to pay what their coal had formerly cost them; and the saving is in other directions; therefore they are loth to give you the exact figures, because they have to tell the gas man that their coal cost them one price, when their books might show another figure. Some gentlemen, who were using millions of feet of it, said that it was probably costing four cents per thousand cubic feet. It does not follow, because the experiments of Messrs. McElroy and Denniston failed to make a good illuminating gas of it, that all experiments in the future will also fail. What perfected thing are we using to-day that did not fail the first time it was tried; and the first time this natural gas was tried, by these gentlemen, at least, was only two years ago. The water gas men can sell gas in some towns in competition with coal gas; and we know that it costs them more than four cents per thousand feet to make it; and I do not believe that it is half so good as the natural gas for a diluent of rich or high illuminating gas. I do believe that it is possible to use even this Pittsburgh gas as an illuminant; and that further experiments will

demonstrate how it can be done successfully and economically. Referring to the attempts at measuring the natural gas with a meter; I want to say that I suggested a mode to our State Geologist, Professor Orton, and he made some experiments in regard to it which were quite successful. That method is now being adopted by our geological survey. It is simply using an air meter, placed with the orifice at the open pipe; and if the current is too great for the vanes, and there is danger of twisting them off the axle, I place over the exit pipe a tall box, some two feet square at the top, and five feet high, with the object of allowing the current to slow up by being enlarged. The bottom of the box is just large enough to go over the orifice. In that way we are able to measure it very accurately; and on repeating the experiments we found that we arrived at the same result each time.

On motion of Mr. Harbison, the thanks of the Association were tendered to Mr. Denniston for his paper.

ELECTION OF OFFICERS.

Mr. Stedman, Chairman of the Committee on Nomination of Officers, reported that the Committee recommended the election of the following gentlemen as a board of officers for the ensuing year:

For President.—A. C. Wood, Syracuse, N. Y.

For Vice-Presidents.—Malcolm S. Greenough, Boston, Mass.; Thomas Turner, Charleston, S. C.; A. B. Slater, Providence, R. I.

For Secretary and Treasurer.—C. J. R. Humphreys, Lawrence, Mass.

For Finance Committee.—Wm. Cartwright, Oswego, N. Y.; C. H. Nettleton, Birmingham, Conn.; James Somerville, Indianapolis, Ind.

For Executive Committee.—J. P. Harbison, Hartford, Conn.; Emerson McMillin, Columbus, Ohio; Edward Lindsley, Cleveland, Ohio; F. C. Sherman, New Haven, Conn.; J. H. McElroy, Pittsburgh, Pa.; Thomas Curley, Wilmington, Del.

On motion of Capt. White the report was accepted. The Secretary was instructed to cast the ballot for the Association for the nominees. The President appointed Messrs. W. H. White and G. S. Hookey as tellers. Secretary Humphreys cast the ballot as instructed, and the tellers reported a unanimous election of the candidates named by Committee. The President thereupon declared the result, and said: Gentlemen, I have great pleasure in introducing to you, as your next President, Mr. A. C. Wood, of Syracuse. (Applause.)

President-elect Wood—Mr. President and Gentlemen of the Association: I thank you for this renewed expression of your confidence and esteem, and fully realize the importance of the position and distinguished honor you have conferred upon me; and when I remember the gentlemen so eminently distinguished in our profession who have preceded me, I feel it is an honor anyone may feel proud of. I have always taken great interest in the prosperity of our Association, for I thoroughly believe in the great good it has already and is to accomplish. This getting together for consultation on the details of the methods, appliances, and conduct of our business has been productive of great benefit, not only to the companies we represent, but to the general public. There is perhaps no other industry in the country representing so large a capital that has a similar organization. Certainly none devotes its energies in promoting the welfare of the public as does this of ours, for the friendly rivalry that has resulted from our coming together and comparing results obtained from new, or improved old appliances, has resulted in a large reduction in the price of gas and improvement in its quality, and at the same time enables us to make fair returns to our stockholders. It is neither expedient nor desirable at this time that I should make any extended remarks. I will only again thank you for the distinguished honor conferred.

REPORTING PROGRESS.

The President—Is the committee which was appointed to name the place for next meeting ready to report?

Capt. White—The committee reports progress.

PROPOSED EXHIBITION OF GAS APPLIANCES.

Mr. A. C. Wood—Several members of the Association have explained to me they would very much desire that, in connection with the next annual meeting, there might be an exhibit of gas appliances. I move that the committee to name place of meeting be empowered to report a plan of operation for carrying out that object—that is, to arrange for an exhibition of gas appliances at the time and place of next meeting, and in connection with it. Agreed to.

PROPOSITION TO CHANGE TIME OF ANNUAL MEETING.

At this point Mr. J. P. Harbison suggested the advisability of selecting some other month than October for holding the annual sessions, and moved that the matter be referred to Executive Committee for consideration and report, the Committee to be instructed to hand in its conclusions on the subject at some period during the present sessions of the Association. The motion was carried. In the debate on the question Messrs. Harbison, Boardman, and Lindsley favored a change, while Messrs. Somerville and others were

opposed to any alteration in the time as provided in Art. XVII. of the Constitution.

The reading of papers was now resumed, and President Vanderpool stated that two communications had been received on the subject of working with limed coal. One of these was contributed by Mr. Jas. Somerville, of Indianapolis, Ind., the other being handed in by the Hon. Member, Mr. R. P. Spice, of London, England. It was agreed that the papers be read in succession, thus paving the way to joint discussion on prominent features of either or both. Mr. Somerville's paper had for its title—

THE RESULT OF A MONTH'S WORKING WITH LIMED COAL.

The author read as follows:

At the last meeting of the Western Gas Association Mr. G. S. Page read a paper on the advantages of adopting the "Cooper Coal Liming Process"—a process with which, no doubt, you are all familiar. I listened with much interest to that paper, and those of you who have had the pleasure of hearing the gentleman speak need not be told by me that his words carry conviction with them—that he has the power, to an eminent degree, of convincing his hearers; and although I had some doubts as to the success of the process, yet before he had finished his essay these doubts had vanished, and he had succeeded in making a convert of me on the spot. Indeed, I began to blame myself for not sooner adopting a process which promised such rich results at so small an outlay.

On my arrival home from the meeting I had two carloads of lime dumped in the coal shed, and proceeded to make ready for the experiment, which consists of thoroughly mixing one ton of coal with 60 pounds of lime slacked with its own weight of water. I began the use of this mixture on the first day of last June, and continued it during the entire month—all the coal carbonized being thus treated. As we are making sulphate of ammonia, and running our works regularly every day, I concluded that by comparing this month with previous and following months a very fair and complete test of the process would be made—the conditions being the same, and lime exclusively used in purification.

The first result which I consider worthy of recording was the transformation that occurred in the coal shed, owing to the slackening of so much lime. It had the appearance of having been newly whitewashed; the coal men were changed to dusty millers; and I can assure you the effect was quite startling to one so long accustomed to the familiar gloom and blackness of that part of the works. The retort house also had quite a changed look. As the charges were drawn a fine white powder would rise and settle on roof and rafter, main and stand-pipe, bringing them out in bold relief. In winter you have observed on the trees and foliage the beautiful effect of hoar frost, from which observation you may get some idea of the influence which the fine white dust exerted upon the appearance of everything in the retort house. But, however pleasant these results were, they were not those which I had in view, and about which I have now to record some disappointment.

The make of sulphate did not increase at the rate which I had anticipated. The heats were not so good, owing, I suppose, to putting so much damp lime in the retorts; and, consequently, the yield fell off somewhat. The amount of fuel was also increased to 10—and even 15—per cent., and the men complained a trifle about the coke clinkering more rapidly in the furnaces. The candle power was not affected in any way. The boxes purified 1,036,000 cubic feet more gas during the month, but the yield of coke was just the same. The coke had a few whitish specks scattered through it; but no one would observe anything unusual about it unless as a result of close examination. The contractor took it all away, and made no sign of disapproval.

To conclude: The make of sulphate was 20 pounds per ton of 2,000 pounds of coal carbonized—one pound more than in the previous and following months. The cost of the lime and labor for mixing was \$117.32. The saving in purification was \$6.22, and the value of the extra sulphate obtained was \$26.22—leaving a deficit of \$84.88.

Thus ended the experiment. I should add that last year the yield of sulphate was 21 pounds per ton; but in May of this year I began to use fresh coal from a new mine, and the make of sulphate fell forthwith $1\frac{1}{2}$ to 2 pounds per ton of coal carbonized; showing, I think, that freshly mined coal does not contain so much nitrogen as does coal that has been exposed for some time.

When Mr. Somerville had finished reading, President Vanderpool introduced Mr. R. P. Spice, who remarked: Before presenting the facts contained in the paper that I am about to read, let me say I desire to thank you (I should have done so earlier) for the honor conferred in electing me an honorary member of this Association. I assure you that I esteem it a very high honor. Indeed my surprise is so great that I hardly know what to say to you about it. Permit me, however, to say I thank you most sincerely; and in the few future years which may be left me I shall always regard this Association, and its interests, with great pleasure indeed. (Applause.)

Mr. Spice thereupon delivered the following remarks on the subject of

COOPER'S COAL LIMING PROCESS.

It has been said that there is *nothing new* in using lime with coal in the gas retort, and to a certain extent this is true, just as it may be true, as we read in Ecclesiastes, that "there is no new thing under the sun."

But I am not concerned to show, nor have I ever said, that the mere mixing of lime with coal and distilling the one in the presence of the other, is either new or novel. On the contrary, I unreservedly admit that Mr. Paterson, of Warrington in Lancashire, is entitled to credit for having carbonized coal in that way as far back as about forty years ago.

Probably other men of genius may have had recourse to the same expedient since then, with the sole object of effecting the removal of a portion of the sulphureted hydrogen from coal gas; and in that way helping their insufficient purifiers to complete the work of purification, in a period of difficulty occasioned at the time by having purifiers of too small capacity, and unable to supplement them by larger vessels.

All such attempts, however, were merely temporary expedients to tide over the difficulty which was occasioned by deficiency of purifying space and power, and when this want had been met by the erection of larger purifiers, the expedient having served its purpose, was no longer had recourse to.

In more modern times, when the demand for higher degrees of purity arose, and the removal of sulphur compounds was called for by public opinion in England, extensive and expensive additions to purifying plant were occasioned and adopted. Chemical research led up to the use of the "Sulphide of Calcium" method as recommended by the London Gas Referees, and formulated by Dr. Odling, in 1872, and that has been, till recently, the only known method of keeping the sulphur compounds down within satisfactory limits.

The coal liming process as now known, which was formulated in a laboratory in Victoria street, Westminster, and patented by Mr. Cooper, in 1882, had not previously been promulgated; and when it was made known the invention was treated to the old and familiar luxury of "the cold shoulder," misrepresentation and acrimonious criticism, the usual fruits of the spirit of unbelief, the sad and much too common lot of inventors.

Facts, however, are proverbially stubborn things, and as the facts are *all* in favor of the process at the end of two years' uninterrupted working, all denials of the undoubtedly great commercial and sanitary value of it must prove to be utterly futile and unavailing,

Let whosoever Will,
Attempt to "block the Bill."

The time, indeed, has already come when men who have remained unbiased, while waiting for issues, are beginning to open their eyes to the force of the evidence which has been established in favor of the method; and already my ears have, in this country, been greeted by the common-sense remark, "What can be done at Tunbridge Wells in gas making can be done in America or anywhere else." My reply has been, "Certainly." Nothing, indeed, can be more obviously true; let any man, who may be so minded, assert the contrary, and he will, by so "holding the mirror up to nature," exhibit himself as being one of a lower order of intelligence and mediocre ability; unable to lead, unwilling to follow, and incompetent to do what another man has done and is doing every day, in working a process which, if carried on under the same conditions, *must* produce similar results anywhere and everywhere alike.

The coal used at the Tunbridge Wells Works is from the Newcastle collieries, except about two per cent. of cannel; it contains about 1 per cent. of sulphur, more or less within small limits, just as it may come from one colliery or another. It has been worked continuously since the 31st of October, 1883, now within a few days of the completion of two years, and the purification has been effected as follows:

One purifier, 20 feet square and 5 feet deep, charged, as it happened to be when gas from limed coal was first turned into it, with 30 tons of oxide of iron, has practically done all the purification of about 230 million feet of gas in two years, and has been opened only once in that time—at the end of the first thirteen months' work; when, owing to the deposit of sulphur, the oxide had so greatly increased in bulk as to render the removal of a portion of it imperative, on account of the increased pressure which was so occasioned. It was then found that the 30 tons contained an average of 40 per cent. of sulphur, 30 per cent. being in the upper of the two layers and 50 per cent. in the lower; and, the box having been emptied, only one-half of the quantity, or 15 tons, was returned to it, the other half being placed in the store. Since then this reduced quantity of oxide has been doing the work, with a catch purifier charged with 7½ tons of oxide; and this, as previously, has very little to do. Very recently the gas has been passed through a second catch purifier, by way of precaution.

Formerly, on what may now be called the old system, six of these 20-foot square purifiers were employed to do the work, two being lime boxes and four oxide, and were all required. One of these six vessels would go only ten days in the winter months before being exhausted, and the average number of changes was twenty per annum; whereas, by using limed coal, one

purifier only has been opened once in two years, and possibly may continue to do effective work much longer, for we have not yet discovered the limit of its vitality.

Thus the problem of "how to make gas in close vessels," so long desired, has been shown to be not only practicable but economical, and conclusively demonstrated. Words need not be employed to "point the moral or adorn the tale." Purification is no longer a trouble or a nuisance, as hitherto it always has been; and so marked is the improvement in its effects that gas works may be planted in any residential suburb of a town or city, and the manufacture of gas carried on without giving forth any vapors or odors which the most fastidious can designate as being offensive to olfactory organs or health.

The oxide of iron need never more be removed for exposure to the atmosphere for revivification, because, as four-fifths of the impurities contained in crude gas are retained and converted into other elements in the retort, only one-fifth go forward to the purifier; and thus the quantity to be dealt with is so small that one per cent. of common air is sufficient to effect constant revivification of the purifying material *in situ*, without any variation or diminution of vitality, and this will go on until at least 90 per cent. of sulphur has been deposited in the oxide—which will have served the purpose of a carrier or sponge until it becomes surcharged.

Hitherto I have not directed attention to this advantage, nor dealt with it in the way of showing the money saving resulting from it. It is, however, by no means an insignificant item, and one of more importance now than when the market value of sulphur was much higher than at the present time. Formerly—say three years since—oxide of iron was delivered at the Tunbridge Wells Gas Works at \$11.25 per ton, and the spent material was taken back at an allowance of \$5; the net cost of the supply being therefore \$6.25—the spent oxide having been used till it contained about 45 per cent. of sulphur. Now, if 50 tons only had to be thus bought and sold in a year, to maintain the stock in a proper state of efficiency, the net cost of the material would be \$312.50.

But at the reduced value to which sulphur has fallen, without any apparent chances of recovery, it is no longer profitable for the oxide dealer to take the spent oxide away at the former or at scarcely any price; hence, but for the coal-liming process, by means of which it is now practicable and convenient to work the oxide until it has taken up 90 per cent. or more of sulphur, the entire cost of it would have to be debited to the purification account; and this would be, for 50 tons per annum, \$562.50. This cost, however, thanks to coal-liming, will be avoided entirely, because with 90 per cent. of sulphur it will be worth not merely as *much* but *more* than the original cost of new or fresh oxide.

Of course all such details as these will vary with the ever varying circumstances of particular and individual cases. Proverbial philosophy suggests that every tub should be allowed to stand on its own bottom; but there is not an anti-coal-liming tub standing on its own base anywhere in the gas world which cannot easily be kicked over and rolled away.

Take, for instance, the objective individual who says to me: "Your argument does not apply to my case, for my purification costs me nothing, as I get my new oxide for old without any cost whatever—the new being delivered at my works and the old taken away for the value of it." I say such a man is one of the favored few, and is to be congratulated on his geographical position; but he has to be reminded that the question of the cost of the oxide is not *all* in any one instance in the world, putting aside geography; for unless recourse be had to magic the material has to be *handed*—to be put into the purifiers, taken out and revived, and put in again, in constantly recurring periods, almost amounting to perpetual motion; an ever-recurring and ceaseless repetition of disagreeabilities, costing money—often much more than the average cost of the raw material. But all this is got rid of by changing the elements in the retorts.

Take, by way of illustration of the saving in cost of labor formerly employed in the purifying department at Tunbridge Wells, when unlimed coal was used (which is a favorable one for objective men, inasmuch as a purifier ran for ten days in the winter months without being changed, which was an unusually easy state of things); twenty of these purifiers being emptied and recharged in the course of a year, the cost of the labor only was \$300; but for the *two years'* purification of limed coal gas, the cost of opening the single purifier, which has practically done all the work, has been only \$15. The account for labor only in the purifying house, comparing two years' purification of unlimed coal with two years of limed coal, is this:

Two years on the old lines.....	\$600 00
Two years on the new.....	15 00
Saving.....	\$585 00

But, it will be said, this is not a net saving, inasmuch as there will be a set-off in the cost of labor employed in liming the coal. And that is so; but the cost of effecting this is trifling in comparison with the expense attendant on working the purifying plant with unlimed coal.

I have not at hand, and therefore cannot give, the figures representing the small additional cost of labor in the coal store, where the lime is slaked and added to the coal; but I can say that one man was employed as coal wheeler before, and that one does the work now, with a very little occasional assistance. The lime is slaked by its own weight of water, supplied conveniently under pressure through a flexible tube fitted with a fine spreading nozzle, and then mixed with such coal as contains the ordinary percentage of sulphur—the proportion for such coal being 2½ per cent. of lime plus the water; and as nothing is lost, all matter being indestructible, the whole of the lime becomes incorporated with the coke, and the water goes forward as ammoniacal liquor.

The coke is improved by the addition of the lime and its value increased for many purposes; the noxious products evolved by its combustion being reduced, and its calorific power increased; and as regards the cost of thus using lime in carbonization, all depends upon relative circumstances. If the lime costs less per ton than the selling value of the coke, and all the coke which is made is sold by weight, as all coke should be, the lime will have cost something less than nothing; and this is not an imaginary case, for I have met with just such an one in this country.

In the case I now refer to, which is situated in one of the Western States, the quantity of coal carbonized is 6,000 tons per annum, and all the coke produced is sold, none being used on the works; the fuel used for heating the retorts being a cheap kind of coal, and the gas is purified by lime only.

All the lime used in the purifiers is entirely wasted, and costs something to cart it away; a purifier has to be emptied and recharged with fresh lime every other day in the summer months, and every day in winter. But by liming the coal, which contains 5 per cent. of sulphur, and using oxide of iron in the purifiers, the labor involved in constant changes will be saved, and the lime will cost less than nothing, because all will be sold with the coke at a higher price than it cost.

Under these conditions the increase of profit will be, by the returns from sale of the lime, which is now wasted..... \$1,575.00
And the increase in quantity and value of ammonia, at present price..... 600.00

Total..... \$2,175.00

In the spring of this year I met with a more extreme case of the kind at a gas works on an island in the Mediterranean, where coke is sold at an average exceeding \$5.00 a ton, and the lime cost only \$1.33; therefore, in that case, every ton of lime, after having been used in the retorts, would, when sold, realize a profit of \$3.67.

I do not hold these examples forth as common cases, but, although exceptional, they are strictly true. I do not give the names of the places because I do not consider it right or proper to publish any information concerning the business affairs of my clients unless I am specifically authorized to use the information obtained.

Any engineer or manager of a gas work can determine what the result may be in his own case, as to profit, by taking into account the selling value of the coke, the cost of the lime, and the quantity of the coke left for sale after using what may be required for use on the works; sometimes the coke is all sold, as in the case I have quoted, but in no case should the quantity used exceed 30 per cent., and 70 per cent. should be for sale.

The next item I will refer to is the cost of wear and tear, which, instead of being increased, as the disaffected ones anticipated, through the alleged rapid destruction of furnaces, etc., has proved to be less than before, the exact difference of cost between the year 1883, when unlimed coal was worked, and 1884, when the coal was all limed, amounted to 8 cents per ton of coal carbonized in favor of the limed coal process.

I have now only to add to the other economies which I have dealt with the very important one of the production of ammonia. This is increased to the extent of 30 per cent., and the truth of this has been confirmed by the accounts of the Tunbridge Wells Company. All the liquor is worked up into sulphate, and in the last half year, ending 30th June, the quantity made was 70 tons 12 cwt., and realized the sum of \$2,415.00 from the carbonization of 5,833 tons of coal. Comment on this is not needed, the figures will speak for themselves.

As regards the character of the gas thus produced, it contains not more than 250 grains of sulphureted hydrogen at the inlet to the purifier, instead of the ordinary quantity contained in crude gas when made in the ordinary way, which ranges from 500 to 1,200 grains, and 15 grains of sulphuret of carbon, instead of from 30 to 60 grains; less than 1 per cent. by volume of carbonic acid, and 4 per cent. of carbonic oxide, instead of the usual 6 per cent. contained in ordinary coal gas, and the 28 per cent. in water gas, as that gas is made in New York and Brooklyn; so that unlimed coal gas contains 50 per cent. more CO than that made from limed coal, and limed coal has 700 per cent. less of that noxious element than New York and Brooklyn water gas; and as to sulphur compounds, the average has been found to be about 12 grains in 100 feet.

The proved advantages which I claim for the process are: Diminished cost of gas; the saving being more or less according to the varying circumstances of each particular case, the amount depending, of course, on the cost of materials and value of products.

The ease and certainty of effecting and maintaining quality and purity within prescribed limits.

And the non-pollution of the atmosphere by offensive odors in the vicinity of the works.

[To be continued.]

[A Paper read before the Society of Gas Lighting.]

Three-Hour Charges.

By Mr. A. B. SLATER.

The question, "What are the best conditions to be maintained in the distillation of coal for the manufacture of illuminating gas?" is one upon which a variety of opinions still exist; and although we now produce a much larger quantity of gas from the same given plant than formerly, yet only a comparatively slight substantial improvement has been made in the manner of distilling the coal, since a large portion of the illuminating value of the coal is still wasted. Some of our members, without doubt, can remember when it was the ambition of the foreman of the retort house to produce and keep up a "cherry-red" heat in the iron retorts; and an average yield of 3½ feet of gas per pound of coal was not uncommon, while 4 feet per pound was considered extra good work. The yield of tar was much larger then than now; and the lighter products distilled from the tar were so great that while the tar distiller paid \$2.50 per barrel for that residual, his net profits were then in excess of those now obtained from the products extracted out of the tar made at some gas works, and for which he pays at the rate of 50 cents per barrel. Then small retorts were used; low heats were the rule; the time occupied in distilling the charges often ran from five to six hours; large quantities of clinker formed in the furnaces, necessitating the drawing of the grate bars, dropping the whole contents of the furnace, and cutting or breaking out the mass of clinker which adhered to the furnace walls, thus greatly cooling off the retorts even to the extent of cracking, and causing them to leak badly when the next charge was introduced. The heat, as they thought, would carbonize a certain quantity of coal in four, five, or six hours, as the case might be—the last hour of time being necessary to accumulate heat sufficient to take the next charge; and so, with low heats and the loss of retort duty, the results could be but moderate. Later, when 4½ feet of sixteen candle gas, without aid of enricher, was reported, the statement was derided as being an impossibility, the denial usually being supplemented by the remark, "It's no use; you can't get more out of the coal than there is in it." Now still greater results are common; and even a product of 5 feet of seven-teen-candle gas, without enricher, has been made.

During the last eight or ten years close attention has been given to the application of the principles upon which more perfect combustion, as applied to the heating of retorts, depends; and this study has resulted in the development of various forms of generator and regenerator furnaces, which already show marked improvement over the old heating methods pursued. But why can better results be obtained with regenerator furnaces than those secured under the old style of furnace systems? Simply because in the new practice the combustion is more perfect; the heat is better utilized; the necessity for dropping the fires to remove clinker is overcome; and better and more uniform heats are constantly maintained. In short, the best form or kind of furnace is the one which will secure the most perfect combustion, and best utilize the heat produced—this, too, in the best itself rather than in the furnace proper, thus securing the minimum of wear and tear in the furnace, as well as affording great saving in the consumption of fuel.

Now, why should the charge remain in the retort five or six hours, or even four hours, provided the necessary heat can be developed to properly distill the coal in three hours? We all know very well that when we run four-hour charges the gas which comes off during the last hour is both small in quantity and poor in quality; and the gas chemist tells us that much the larger portion of the impurities is carried over during the last part of the time which the charge is run. In fact, oftentimes in an experimental works we find the meter will stop entirely (sometimes before the end of the last hour) when a four-hour charge is run. A fair illustration is afforded from an experiment made by Mr. C. D. Lamson, of the Boston (Mass.) Gas Works, and reported to the New England Association of Gas Engineers at their annual meeting in February, 1876. With the ordinary furnace, in an experimental works, during the first three hours he produced 11,340 cubic feet of 14.37 candle gas = 4.72 cubic feet, or 67.82 candle feet, per pound of coal. During the fourth hour he produced 1,000 cubic feet of 2.57 candle gas = .42 of a cubic foot, or 1.08 candle feet, per pound of coal; thus showing that, of the total quantity obtained during four hours, the quantity produced during the last hour was only a fraction over 8 per cent. in quantity, and less than 1.6 per cent. in illuminating value as stated in candle feet. At the end of

the fourth hour he had carbonized 200 pounds of coal per retort, with a yield of 68.92 candle feet per pound of coal; and at that rate, for 24 hours, his yield in candle feet per retort would have been 82.704. At the end of the third hour his yield in candle feet was 67.82 per pound of coal; but with three-hour charges for 24 hours his product, upon the yield which he shows for the three hours, would be 108.512 candle feet per retort, or over 31 per cent. more.

It may be said it would be difficult to carbonize 200 pounds of coal every three hours with the old style of furnace. That is quite true; but still it is being done with regenerator furnaces every day, and over 40 to 50 per cent. more coal per charge is worked off every three hours. The above figures are made on the basis of 4.72 cubic feet per pound of coal for three-hour charges; but, as a matter of fact, instead of 4.72 cubic feet per pound of coal, 5 feet and over is obtained, which makes the difference in favor of three-hour charges still greater.

After stating these facts I will leave the question of gain secured during the fourth hour to be ciphered out by the advocates of four-hour charges.

Another illustration may serve to point out some of the points involved. Suppose it were possible to introduce the coal and remove the coke from the retorts continuously, or without interruption, and also to maintain the required degree of heat in the retorts; then the gas would be uniform both in quantity and quality. Now take the other extreme. With a given heat in the retort, introduce all the coal the retort will hold; of course the heat is at once reduced, and the conditions are constantly changing from the beginning of the first to the end of the last hour; and just in proportion as the conditions change from the approximately perfect ones in the first case, just in that proportion will the results be different, with consequent development of loss in the same ratio. The richer gas comes over during the first two hours. During the third hour the gas is less both in quantity and quality; and when four-hour charges are run the last hour will show the gas still poorer in both these respects, and thus deteriorate the whole volume produced during the previous three hours. One alleged objection to three-hour charges has been raised in that the retort is opened twice more in 24 hours than when four-hour charges prevail—consequently more air is taken into the vessel. A moment's reflection will show that the quantity of air remaining in the retort when the lid is put on is, in any case, infinitesimal in quantity. In my judgment one of the principal objections to three-hour charges has been the inability to maintain the proper degree of heat, as is the case with the old-style furnaces. Another objection is raised by the stokers, who naturally prefer to charge at longer intervals, because they have more time to "lay off and smoke." To the manager who often depends more on the whims and preferences of his men than upon his own judgment and knowledge of the fact, this objection is made effective; and so it has always been that when any change from the routine of old established customs and habits is made, especially in the retort house, the men are almost sure to show dislike and disapproval of it; and representations are made to the manager or superintendent which generally settles the matter in favor of the views held by the "hands."

Our attention was called to the results obtained from light and heavy charges of coal (at the February meeting of the New England Association of Gas Engineers, in 1876,) by Dr. Kidder, of Boston, Mass., when he said, "A fact of common experience in gas making is that richer gas is obtained from light than heavy charges of coal in the retorts, if drawn at the proper time. This does not depress the temperature nearly so much; allows of greater freedom for escaping vapors, with less exposure to incandescent coke; and affords a larger generating surface in the retort, which, with heavy charges, is quite too limited to be effective. Good standard coal or oil gas in contact with incandescent coke will so analyze the hydrocarbon vapors as to wholly destroy the illuminating power of the gas."

SPECIAL ENGLISH CORRESPONDENCE.

COMMUNICATED BY NORTON H. HUMPHRYS.

SALISBURY, Nov. 10, 1885.

Death of Mr. F. W. Hartley—Disposal of the London Sewage—The Sulphate Market, and Direct Trade between Producer and Consumer.

Mr. F. W. Hartley, a gentleman well known in English gas circles as manager of the firm of Messrs. A. Wright & Co., gas meter and apparatus manufacturers, of Westminster, and more widely by reason of his numerous books, pamphlets, and papers, relative to photometry, and the general experimental portion of gas engineering, died suddenly on the 17th ult. I am sure that his name is sufficiently familiar to the readers of the AMERICAN GAS LIGHT JOURNAL to enable them to fully appreciate the fact that in the sudden and premature (for he was only 56 years of age) removal of this talented and conscientious scientist from the scene of his labors, the gas world has sustained an irreparable loss. We always regret the passing away of a useful life, even when it has reached the limits prescribed by the grand old

Hebrew psalmist; yet, under such circumstances, our sorrow is tempered by the consideration that such must be, according to the natural order of earthly things; but in the case of our friend, who has left us when in the zenith of activity, usefulness and manhood, our pain at his untimely removal is increased by the thought that he might have been spared to us for another twenty years or so, to assist us by his skill and ability, no less than to maintain our admiration for his sterling qualities of character, and (to the numerous circle who enjoyed that privilege) our great regard and esteem in social communication with him as a man and a brother. Those of your readers who have not been personally acquainted with the late Mr. Hartley may perhaps be inclined to regard this language as hyperbolic, and put on for the sake of effect; but I may confidently refer to the articles and numerous letters that have appeared in our special technical journals, as a proof that the above is in no way an exaggerated representation of the general feeling amongst English gas engineers, in respect to this greatly regretted event.

The limits of space at my disposal forbid my attempting anything like an obituary notice, such as those which have already appeared in the *Journal of Gas Lighting*, and other periodicals, nor is it necessary for me to do so, much as I should have liked to have enlarged upon this topic. But there is one point to which I should like to be allowed to refer. The late Mr. Hartley was not a man who enjoyed the favors of fortune in a pecuniary sense. He was, in every sense of the word, a self-made man, who rose to the position he attained by dint of untiring industry and integrity. At an early age he attracted the notice of the late Alexander Wright, and entered his service, gradually working his way up until he attained the position of confidential manager, and since the death of his early friend and employer, some 26 years since, he has conducted the affairs of the firm to the entire satisfaction of the proprietors, but with no advantage to himself and those dependent upon his exertions (if I am rightly informed) beyond the salary paid for his services. He married early in life, and has reared a large family of five daughters and three sons. Under these circumstances it is easy to understand that he has not had the opportunity of realizing a competency for his family—indeed so strictly upright and conscientious was he in all his dealings that probably he has refused many opportunities of realizing pecuniary profit, which less scrupulous men would not have hesitated to embrace. So, like many other worthy men, who have been removed from this world before they have completed their regular course, he has left a very inadequate provision for his family. The leading gas engineers in this country have agreed, with praiseworthy unanimity, that the present circumstance affords a suitable opportunity for recognizing his services to the gas industry, in a manner that would not be feasible under any other—by raising a substantial fund for the benefit of his children. Mr. Hartley was amiable and generous to a fault, and a personal friend of many years standing testifies that he was never known to speak ill of any, even of those who opposed or sought to rival him in any way. So the response to this appeal will be liberal, and many will join the writer in feeling that in subscribing their mite to the fund they are only offering an inadequate return for benefits received, through the medium of the published essays and papers from the facile and practical pen that is now at rest for ever. I believe that some amongst this class will be residents on the other side of the Atlantic.

The disposal of the London sewage is a matter that has considerably exercised the minds of the engineers connected with the Metropolitan Board of Works for many years. When we consider the freedom of this vast metropolis, with its population of some five millions, from the scourging epidemics so frequent in some other and less populous cities, which it has now enjoyed for a long time, it is evident that great credit is due to all concerned for their energy and skill, without which this great work could not be carried out in a manner devoid of nuisance or injury to the public health. As it is, London is looked upon as amongst the healthiest localities in the country. The system hitherto followed is simply to take the sewage away. No attempt has been made in the way of utilizing it, either by irrigation or by chemical treatment, although experiments to that end, sometimes on a considerable scale, have from time to time been under the attention of the authorities. Hitherto the practice has been to convey it to Crossness, some 20 miles down the bank of the river Thames, and there discharge it, after applying the best known methods of decolorization and disinfection, into the river. Large storage reservoirs have been constructed capable of containing a day's production—35,000,000 gallons—and other means adopted so that the discharge can be made only when such tidal conditions obtain as will secure its being washed out to sea. This carrying out to sea, however, is not effective in practice, and a large quantity of more or less offensive solid matter remains in the river, accumulating to such an extent at bends and other localities which afford a convenient resting place for it, as to render continual dredging necessary to avoid the hindrance of navigation. It is now practically proved that the river is not capable of discharging the double office of an outlet for the London sewage and a way for navigation. Several schemes have been proposed as an improvement on the existing system. One o

these, called the Canvey Island scheme, has attracted a great deal of attention, and received support in high quarters. Its main features are the purchase of an island of that name, situated at the mouth of the river, and to carry the chemically deodorized sludge to that piece of land, where it is to be utilized, if practicable, for irrigation purposes on a large scale. My object in referring to this matter is to notice an ingenious and apparently feasible suggestion advanced by Mr. J. Orwell Phillips, the Secretary and General Manager to the Gas Light and Coke Company. The works of this company are situated near to the present place of outfall—in fact the main conduit to that spot passes close by the premises of the company. They possess a fleet of vessels engaged in supplying the enormous quantity of coal required by them—no less than some 1½ million tons per annum—also ample landing space for dealing with this enormous bulk of material. Mr. Phillips suggests that but little difficulty or expense would be necessary to make arrangements for preparing the sludge on land adjacent to the gas works, and conveying it to the vessels, which at present make their return journey to the north of England without cargo, and the vessels could part with their unattractive passenger by throwing it out to sea at any desired part of their track. The suggestion is remarkable for ingenuity and originality. Certainly, if the sewage must be thrown away, the Gas Light and Coke Company, possessing these special advantages, are in a position to throw it away so effectually that it will not emulate the proverbial bad penny in “coming back again,” as at present it seems to do, on much lower terms than any other contracting body could possibly be in a position to offer.

The proposed sulphate of ammonia makers association, to which I referred in the concluding paragraph of last month's letter, is making satisfactory progress, and a preliminary meeting is to be held in the course of a few days. The necessity for such an association is perhaps rendered more apparent by the fact that certain dealers in sulphate, in their circular to their customers, have gone out of their way to endeavor to throw cold water upon the movement. A certain Mr. John Angus, of 47 Lime street, London, E. C., evidently belongs to this class, for in the course of a letter published in the correspondence columns of the *Journal of Gas Lighting*, he takes the opportunity to remark, “that it is beyond the power of an association to do any permanent good.” All this serves to show the importance of developing a direct trade—a direct communication with the consumer—and this remark applies to other things beside sulphate. Take coke, for example; the gas engineers who realize the best returns for this residual will be found on examination to be those who look after a good retail trade. It is very nice to settle at one transaction the sale of perhaps several hundred tons of material, and to know that the check in settlement of the same will be dropped into the official letter box at the appointed date with no further trouble. So long as the producer retains full command of the market this will do very well. But if the material is bought to sell again, and the process above indicated is allowed to extend to a considerable proportion of the total sales, the dealer begins to encroach upon the position which the producer should jealously retain. I know one instance of a gas manager who found difficulty in getting rid of his coke, and accumulated a large stock on hand. Instead of casting about in the direction of developing a direct trade, he sold a quantity by contract to a dealer at a low rate; and this dealer easily accomplished the work which the gas people had not sufficient push or energy to do—the development of a retail trade in the neighborhood. So all went on well for a few years. The gas manager's coke yard was always empty, and the coke was promptly paid for. But after a time a “change came o'er the spirit of the dream.” The plausible dealer, having obtained a command of the market, talked about lower rates, together with unpleasant allusions to bringing coke from a distance, and introducing anthracite coal and other fuels as an improvement on coke for certain purposes. So the gas engineer was brought around to low terms, and his last state was worse than the first. If we substitute nitrate of soda for anthracite in this instructive illustration from hard facts, I think it will furnish a fair representation of the state of affairs in the sulphate market during the last few years. The dealers have got the command of the market, and when such is the case, whether with sulphate or any other commodity, the producers must look out for hard times.

After the first meeting of the proposed association I shall be in a better position to deal with the remedy for such a state of affairs. At present it will be sufficient to point out how to avoid getting into it. This can readily be done by looking sharply after the direct trade. If stocks increase, it is better to accept an all-round reduction in price, than to sell off a portion at a largely reduced rate. Also the seductive offers of large buyers who are not *bona fide* consumers must be declined. Of course, it is easy to be wise after the event, but I certainly think that, as in many other branches, there is too much tendency amongst gas engineers to leave the market for residual products to the tender mercies of dealers.

NO GAS AS YET IN THE IRONTON (O.) WELL.—The Belfont Mills well is at a depth of 2,050 feet without any sign of gas. They will go deeper.

ITEMS OF INTEREST FROM VARIOUS LOCALITIES.

NO CHARGE FOR GAS SUPPLIED TO THE ENGINE HOUSES.—It is said that the Philadelphia Company (dispensers of natural gas) furnishes all the ward fire engine houses of Pittsburgh with gas without making any charge for same.

ELECTRIC LIGHT FOR THE STREETS OF DENVER, COLORADO.—The city's annual contract with the Denver Gas Light Company for street lighting in that locality expired with first of October, and the municipal authorities, up to our last advices, appear to have about determined that electricity will be employed as a substitute for gas in street illumination. Proposals were asked for, and those submitted developed the following state of affairs: The Denver Gas Company proposed to light all gas lamps at present in use (450) for the sum of \$35 each per annum—on a three-year contract basis—and to charge \$35 per year for each additional lamp erected that might be ordered put up in new territory. The Company further agreed, if the city would contract for the erection of 100 new lamps (or a total of 550), to light same at an annual charge of \$30 per post. A special proposition was also put in, and to this effect: Should the city desire to more effectually illuminate certain business quarters, the Gas Company would agree to put up high-power Siemens burners, each to give a light equal to 500 candles, to burn every night in the year until 12 o'clock, at a charge of \$144 each per annum—the city, however, to agree to the erection of not less than 40 such burners. The special proposition was further qualified by an agreement of the Company to light (after midnight) the ordinary lamps in the districts occupied by the Siemens burners at a charge of \$20 per annum each, such charge to be deducted from the annual amount received by the Company for the general lighting of the city. Two propositions were received from the Colorado Electric Company, and were as follows: To supply any number of arc lights that might be ordered—on a three-year contract, at \$150 each per annum; five-year contract, \$130 each; ten-year contract, \$110 each. [It might be here said that all bids were adjusted to an agreed moon table.] The same Company proposed, if incandescent lights were preferred, to supply the 450 posts now in use with burners rated to develop 20 candle power, on basis of three-year contract, at \$28 each per annum; five-year contract, at \$25; ten-year contract, at \$23. All the above propositions were referred to the consideration of a joint committee of City Council, and it took them just three days to decide what course to recommend. They reported in favor of the incandescent scheme, and advised that an additional 66 lamps be erected in the business part of the city, thus bringing the total up to 516. The report was accepted by Council, and a resolution was passed which directed the City Attorney to draw up a contract authorizing the authorities to enter into a three-year contract with the Colorado Electric Lighting Company at the figures named. This does not settle the matter, as the action of the Council requires to be ratified by the Board of Supervisors before final disposition of the affair can be reached. We would ask Brother Fay to kindly inform us of the action taken by the Supervisors in the premises. Before dismissing the subject we cannot forbear making inquiry as to why the Aldermen (if they were so well convinced that incandescence lighting was of such superior nature) did not recommend an acceptance of the “ten-year proposal.” Perhaps all that was understood by the electric lighting folks when they made their bids.

MILWAUKEE (WIS.) THINKS GAS IS GOOD ENOUGH.—Some time ago a resolution was passed in the Milwaukee City Council authorizing the lighting of the streets of that place by electricity. Subsequently the Mayor vetoed the resolution, and afterward the Council refused to override the veto. In his message on the subject the Mayor placed great stress on the necessity of placing underground all wires employed in the transmission of electric lighting currents.

A GAS COMPANY CHANGES HANDS.—According to the *Utica Herald* a majority of the stock in the Little Falls (N. Y.) Gas Light Company has been purchased by I. S. Elkins, and that reorganization of the corporation has been perfected. It is now reported Mr. Elkins wants to sell out.

WOODEN GAS MAINS STILL IN FAVOR AT GREEN BAY, WIS.—Supt. J. G. Miller, of the Green Bay Gas Works, reports that extensive additions to the company's mains have been made during the past summer. Much work was also done in the direction of placing the pipe already down at greater depth, or so as to be out of reach of the severe frosts experienced in that region. Square (external) wooden mains, painted with coal tar, are employed. When the plant was first erected (over 16 years ago) ordinary round logs (with roughly bored centers), from which even the bark had not been peeled, were put down; and Mr. Miller avers that, when some of these old conduits were displaced during the summer's main-laying operations, the wood was perfectly sound, although, he admits, “the bark dropped off.”

THE NATURAL GAS INDUSTRY AT FINDLAY, OHIO.—It is said that the seven natural gas wells now in active flow at Findlay supply a greater quan-

tity of gas than could by any sort of possibility be used in the manufacturing establishments now centered there. The *Petroleum Age* is responsible for the assertion that during the fair at that place the streets and road leading to the fair grounds were lit by natural gas. A line of natural gas jets, making a flame of fire several inches thick, extended the whole length of the route, and made the way as light as day. Gas for the lighting and heating purposes of a large residence is supplied for \$40 a year. No meters are used, but consumers burn all that is wanted. Nearly all the factories are using gas in place of coal, and Findlay is booming.

ANOTHER "EXPERIMENTAL STATION."—A wideawake correspondent at Tiffin, Ohio, says he noted, among our "Items of Interest" of last issue, the reference to electric lighting troubles at Brockton, Mass., and goes on to remark, "If that is an experimental station, what would be said of the one in operation at Tiffin? Such a trifling circumstance as the shutting down (at night) by our local Edison company is not regarded of great importance, since the electric company's patrons keep on hand a supply of oil lamps—and so enjoy a really unusual sort of illumination when the electric agent 'goes out.' I have heard the Tiffin station spoken of as being an experimental one, but did not before understand the full meaning of the expression. I might say right here that (as a class of men claiming to be 'scientists,' 'progressive engineers,' etc.) the builders of Edison incandescent plants do not seem to gain anything by experience. The same unsatisfactory performances are witnessed in other places as well as here; and as surely as the lights supplied from the 'experimental stations' of Brockton, Mass., and Tiffin, Ohio, 'go out,' so also will the 'users of the lamps' be treated to like benefits at Lawrence and New Bedford. Perhaps Mr. Price could post our Tiffin electricians up to the point of 'working the game' of 'beyond the pale of possibility,' etc."

SMASHING THE GLASS IN THE LAMP POST LANTERNS.—On date of Nov. 20th Gen. Chas. Roome, President of the Consolidated Gas Company, of New York city, made complaint to Supt. Murray that within a few nights the glass of 133 gas lamps, in the district bounded by Horatio and West 18th streets, Ninth avenue and North River, had been broken by mischievous schoolboys. The superintendent issued the necessary instructions for the detection of the youthful offenders. This item of broken glass figures to a good round sum in the course of a twelvemonth.

PROGRESS MADE ON THE WORKS OF THE BAY STATE GAS COMPANY, OF BOSTON, MASS.—The Beacon Construction Company (Limited), of 425 Chestnut street, Phila., Pa., is the contractor for building the works of the Bay State Gas Company, and work on the contract is being vigorously prosecuted. Up to November 19th the following had been accomplished: In the first place, the works are being erected in the district known as "Calf Pasture," where a plot of 60 acres of land has been secured. The brickwork of two tanks (each 154 feet by 30 feet) has been completed, and the bottom to one has been finished; the central core of remaining one was being removed. Some five to six miles of mains are already down; and the filling in and wharfing of the property is being pushed ahead. The iron work is to be got out during the winter in readiness for putting up (together with the buildings) early next spring. The promoters of the company declare they will be ready to supply water gas to their consumers by Sept. 1st, 1886; and assert that the gas will contain less than 10 per cent. of carbonic oxide. But no matter what be the percentage of that noxious ingredient sent out in their gas this fact remains—the city of Boston required the services of the Bay State Gas Company in no way, shape or manner. Its residents were pretty safe to have cheap and good gas supplied them for years to come; but such assurance is now imperilled. After the war will come the period when the expense of same must be met. It may be of interest to know that the managers of the "Beacon Construction Company" are the following: J. Edward Addicks, Chairman; W. H. Miller, Secretary; R. C. H. Brock, Treasurer; and B. F. Sherman, General Manager.

DEATH OF MRS. ELLIS LEVER.—We regret to announce the death of Mrs. Ellis Lever, which sad event occurred at the homestead—Culcheth Hall, Bowdon, England—on date of Thursday, Oct. 29. Mrs. Lever, in company with her husband (a most estimable gentleman he is) made an extended trip through America some three years ago; and those of the fraternity who then enjoyed the pleasure of meeting in a social way with the voyagers will now deplore the fact that death has removed her from the home circle which she so enlivened and adorned.

THE LIGHTS "GO OUT" AT DUNDAS, CANADA.—At 8 P. M. of Sunday, Nov. 1, the gas consuming portion of the inhabitants of Dundas found themselves without light. The hour of the occurrence was a most unfortunate one, as services in the several churches were just beginning; but clergymen and congregations accepted the situation in a "proper spirit," one of the

ministers putting it thus: "Sing the doxology, and get out as best you may." The trouble was occasioned by a break in an 8-inch main, and Manager Thomas reports that about 20,000 cubic feet of gas escaped—a serious defect in the supply from a small plant. By the next evening everything was in smooth working order.

WHAT PROF. DOUGLAS HAS BEEN DOING AT ANN ARBOR, MICH.—Prof. S. H. Douglas, the active and energetic gentleman in charge of the affairs of the Ann Arbor Gas Light Company, has been making the summer months "count," and a "tallying up" shows in the nature of a great gain in efficiency regarding plant and apparatus. The improvements include, first, the placing of an automatic governor; second, the introduction of a Roots exhaustor; third, the addition of a Pelouze & Andouin condenser; and fourth, the construction of an improved set of regenerator furnaces. An examination of the items given will go to show that the Ann Arbor plant has been almost entirely reconstructed; and in view of the superior manufacturing facilities thus afforded, the Professor determined that he could make a reduction in selling rates, the same to go into effect from date of Nov. 1st. The amended schedule is as follows:

A monthly consumption of under 2,000 cu. ft.....	\$3.00 per M.
“ “ of over 2,000 and less than 5,000.	2.50 “
“ “ of 5,000 cu. ft. and over.....	2.20 “

On all classes of consumption, in consideration of settlement of accounts on or before tenth day of month, a discount of 10 per cent. is allowed. The Professor is just as enthusiastic as ever on the subject of ferric oxide as an agent for gas purification; and well he may be, for the results obtained by him with it at the Ann Arbor plant are excellent in every respect.

ORDERED TO ABATE A NUISANCE.—Complaints having been made to the Poughkeepsie (N. Y.) Board of Health that a most offensive odor was constantly arising from the water in the vicinity of the foot of Pine street, that city, a special committee of the Board was deputed to examine into cause of odors and to report measures for abatement of same. After thorough examination it was determined that the Citizens Gas Company (an outlet from that works discharged into the river at the point complained of) was the offender, and also that the odor developed was detrimental to the health of the people. Expert testimony was secured, and the Health Department of this city was interviewed on the subject, the opinions of the gentlemen consulted all concurring in the verdict rendered. On Nov. 20 the special committee reported its conclusions back to the Health Board, and immediately thereafter the Board adopted the following:

"Resolved, That the Citizens Gas Company, of Poughkeepsie, be notified to abate and remove the said nuisance, within 30 days from the service of a notice upon them, under a penalty of \$200 for non-compliance with the said order, and an additional penalty of \$20 for each day's neglect beyond the specified time."

CHARTERING ANOTHER GAS COMPANY FOR BROOKLYN, N. Y.—On date of Nov. 19th papers were filed with the Secretary of State incorporating the "Peoples' and Consumers' Gas Company, of Brooklyn." The incorporators named are Messrs. Lindley Murray, Geo. A. Hoag, Albert C. Gunnison, Robert H. Rountree, David P. Templeton, Alexander Cameron, Thomas Wilde, John Rooney, and Alfred N. Ladd. The capital stock is fixed at \$3,000,000, par value of shares \$10. Here are some of their "pledges;" and we regret that our space is so limited as to preclude present comment on them—

"That the association shall contract to supply gas of first quality to all consumers at \$1 per thousand feet.

"That all subscribers to this stock and all consumers shall bind themselves to take gas from this association only so long as it shall be furnished at the above stipulated price, and of satisfactory quality, and that no inducement of a lower price offered by any other company shall be allowed to interfere with this arrangement. Consumers will at once see the necessity for this stipulation, if they wish permanency in the price of gas. It will, of course, be the immediate attempt of the combination (which charges \$2.00 for a poor quality of gas) to get this association out of the way by underselling it, and, its ruin being accomplished, they will at once put up their price again. If consumers are satisfied that \$1 per thousand, together with the returns offered by this association, constitute a fair and reasonable charge, they must remember that the only way by which it can be permanently maintained is by a firm support of the association.

"Dividends not exceeding 15 per cent. per annum shall be paid on the capital stock out of the profits, over and above the cost of manufacture and expenses of conducting the business."

THE GROWING LIST.—"Balt., Md., Nov. 23.—Shortly before midnight on Saturday, C. A. Thorpe, of Perryville, and J. White, of Frenchtown, went to bed in a public house on Gay street. At 11 o'clock to-day the chambermaid found the door locked. An entrance was effected, and both men were found dead in bed, and gas was still escaping from the burner. It is supposed they blew out the light."—N. Y. World, Nov. 24.

The Market for Gas Securities.

The dealings in Consolidated gas during fortnight have been marked by lower prices; but towards the close values stiffened considerably, and at time of writing (2 P.M. Nov. 30) bid and asking figures are 103-103½, respectively. The directors have declared a dividend of 3½ per cent., payable on and after Dec. 15th. In the interim "par and one-half" was the figure at which one or two small transactions took place, but the bulk of trading occurred in the region of 2½ to 3. The Senate "Smelling Committee" has so far failed to develop much of interest, save to expose the true nature of reformer Sherwood's opposition. The higher priced Brooklyn shares are so sensitive that notice of the formation of a projected opposition company caused a slight decline in value. Fulton Municipal, after selling up to 161, receded to 159; and Williamsburgh is down to 159-160. These shares are at decidedly "fancy" prices, and it looks as though holders might "make a turn" on the short side. On the other hand, Brooklyn Metropolitan shows an advance of about two points. Mr. Elkins is reported as having purchased control in Little Falls (N. Y.) Gas Company, and is now anxiously seeking for some party willing to "take the bargain off his hands." The death of Col. Peter Donahue, who was largely interested in the finances of the San Francisco (Cal.) Gas Light Company, occurred on Thursday, Nov. 26th.

Advertisers Index.

GAS ENGINEERS.	
Jos. R. Thomas, New York City	306
Wm. Henry White, New York City	302
Wm. Farmer, New York City	292
GAS WORKS APPARATUS AND CONSTRUCTION.	
James R. Floyd, New York City	303
T. F. Rowland, Greenpoint, L. I.	303
Delly & Fowler, Phila., Pa.	303
Kerr Murray Mfg. Co., Fort Wayne, Ind.	303
Stacey Mfg. Co., Cincinnati, Ohio	303
Bartlett, Hayward & Co., Baltimore, Md.	303
Morris, Tasker & Co., Limited, Phila., Pa.	302
Davis & Farnum Mfg. Co., Waltham, Mass.	304
Tanner & Delaney Engine Co., Richmond, Va.	302
R. D. Wood & Co., Phila., Pa.	302
Southwark Foundry and Machine Co., Philadelphia, Pa.	302
PROCESSES.	
National Gas Light and Fuel Co., Chicago, Ills.	293
Burdett Loomis, Hartford, Conn.	293
GAS AND WATER PIPES.	
A. H. McNeal, Burlington, N. J.	300
Gloucester Iron Works, Phila., Pa.	300
Warren Foundry and Machine Co., Phillipsburgh, N. J.	300
Mellert Foundry and Machine Co., Reading, Pa.	300
Cincinnati and Newport Iron and Pipe Co., Newport, Ky.	300
Fox & Drummond, New York City	300
Ohio Pipe Co., Columbus, Ohio	300
SCRUBBERS AND CONDENSERS.	
G. Shepard Page, New York City	301
REGENERATOR FURNACES.	
Charles F. Dieterich, Baltimore, Md.	276
GAS ENGINES.	
Schleicher, Schumm & Co., Phila., Pa.	280
Clerk Gas Engine Co., Phila., Pa.	296
GAS GOVERNORS.	
Connelly & Co., New York City	295
T. C. Hopper, Philadelphia, Pa.	294
RETORTS AND FIRE BRICK.	
J. H. Gautier & Co., Jersey City, N. J.	298
B. Kreisler & Sons, New York City	298
Adam Weber, New York City	298
Laclede Fire Brick Works, St. Louis, Mo.	298
Brooklyn Retort and Fire Brick Works, Brooklyn, N. Y.	298
Borgner & O'Brien, Phila., Pa.	298
Wm. Gardner & Son, Pittsburgh, Pa.	298
Henry Maurer, New York City	298
Chicago Retort and Fire Brick Works, Chicago, Ills.	298
Baltimore Retort and Fire Brick Co., Baltimore	298
Standard Gas Retort and Fire Brick Co., Ironton, Ohio	298
Oakhill Gas Retort and Fire Brick Co., St. Louis, Mo.	298
Evans & Howard, St. Louis, Mo.	297
CEMENTS.	
C. L. Gerould, Manchester, N. H.	292
Howard Fleming, New York City	292
GAS STOVES.	
American Meter Co., New York and Philadelphia	299
The Goodwin Gas Stove and Meter Co., Phila. Pa.	308
GAS ENRICHERS.	
Forest City Naptha Co., Cleveland, Ohio	293

GAS METERS.

Harris, Griffin & Co., Phila., Pa.	307
American Meter Co., New York and Philadelphia	307
The Goodwin Gas Stove and Meter Co., Philadelphia, Pa.	307
Helme & McLenny, Phila., Pa.	307
Maryland Meter and Mfg. Co., Baltimore, Md.	306
D. McDonald & Co., Albany, N. Y.	307
Nathaniel Tufts, Boston, Mass.	306

EXHAUSTERS.

P. H. & F. M. Roots, Connersville, Ind.	297
Smith & Sayre Manufacturing Co., New York City	302
Wilbraham Bros., Philadelphia, Pa.	304

GAS COALS.

Penn Gas Coal Co., Phila., Pa.	305
Perkins & Co., New York City	304
Newburgh Orrel Coal Co., Baltimore Md.	305
Despard Coal Co., Baltimore, Md.	305
Chesapeake and Ohio R.R. Coal Agency, N. Y. City	305
Westmoreland Coal Company, Phila., Pa.	305
Monongabela & Peters Creek Gas Coal Co., Pittsburgh, Pa.	305

VALVES.

Ludlow Valve Manufacturing Co., Troy, N. Y.	300
John McLean, New York City	300

GAS LAMPS.

Siemens Regenerative Gas Lamp Co., Philadelphia, Pa.	301
G. Shepard Page, New York City	306
Albo-Carbon Light Co., Newark, N. J.	292

GAS KILNS AND OVENS.

Thompson Gas Kiln and Oven Co., New York City	297
---	-----

PURIFIER SCREENS.

John Cabot, Lawrence, Mass.	266
-----------------------------	-----

STREET LAMPS.

J. G. Miner, Morrisania, New York City	269
Bartlett Street Lamp Mfg Co., New York City	297

BURNERS.

G. Geffroyer, Phila., Pa.	302
G. Taylor, New York City	293

PURIFYING MATERIAL.

Connelly & Co., New York City	297
-------------------------------	-----

STEAM BLOWER FOR BURNING BREASE.

H. E. Parson, New York City	306
-----------------------------	-----

PIPE COVERINGS.

Chalmers-Spence Company, N. Y. City	293
-------------------------------------	-----

GAS FIXTURES.

Mitcheil, Vance & Co., New York City	297
--------------------------------------	-----

STEAM PUMPS.

A. S. Cameron Steam Pump Works, N. Y. City	297
--	-----

SHAFTING, PULLEYS, ETC.

A. & F. Brown, New York City	293
------------------------------	-----

STEAM ENGINES.

Westinghouse Machine Co., Pittsburgh, Pa.	305
---	-----

PIPE WRENCH.

J. H. Williams & Co., Brooklyn, N. Y.	292
---------------------------------------	-----

HYDRAULIC MAIN.

A. E. Boardman, Macon, Ga.	297
----------------------------	-----

WANTED,

Manager for Small Gas Works,

In town of 8,000 inhabitants. Must do a little of everything.
Address B. G. PLUMER, Prest. Gas Company,
635-1t Wausau, Wis.

WM. FARMER, ENGINEER,
32 Park Place, Room 36, New York.

THE CHEMIST'S ASSISTANT; OR, KINDERGARTEN SYSTEM OF CHEMISTRY.

A system by which the elements and their valences are represented by illustrations and solid bodies.
BOX AND PAMPHLET COMPLETE, \$2.50.

GIBBS
PORTLAND CEMENT

Is guaranteed to be the finest English brand, and unsurpassed by any grade imported for making concrete and setting masonry.

Extract of paper, with tests, read before the Am. Soc. of Civil Engineers, sent on application.

HOWARD FLEMING,
Sole Agent for U. S.,
23 Liberty St., New York.

GEROULD'S IMPROVED RETORT CEMENT.

Used by most of the Gas Companies of the United States with perfect satisfaction. Manufactured by

C. L. GEROULD,
Manchester, N. H.

N. B.—As Manchester is a shipping point, all freight can be shipped as cheaply as from Boston or New York.

HOWARD FLEMING,
23 Liberty Street, New York.

IMPORTER OF THE BEST

Portland & Roman Cements

"DINAS" SILICA FIRE BRICKS AND BLOCKS
For Coke Ovens and Gas Works,

Correspondence invited. Lowest prices.



THE ALBO-CARBON LIGHT!

A new system of Carburetted heated Gas by means of a solid material, whereby its illuminating power is increased more than three-fold.

SUPERIOR TO ALL OTHER SYSTEMS FOR

Economy, Safety, Illuminating Power and General Practicability,

The Albo-Carbon process enables Gas Companies to supply a light equal to the Arc Light, at a much less cost. Several Gas Companies are now using this system. The process is extensively used in Europe, and is being rapidly adopted in this country.

The Albo-Carbon Light Co., - - Newark, N. J.

GENERAL AGENCIES:

1004 Walnut St., Philadelphia, Pa.	Law Buildings, Lexington Ave, Baltimore.
94 Fifth Avenue, Chicago, Ill.	35 Federal Street, Allegheny, Pa.
522 Pine Street, St. Louis, Mo.	120 S. Fourth Street, Minneapolis, Minn.

BROCK'S PATENT DROP FORGED CHAIN PIPE WRENCH

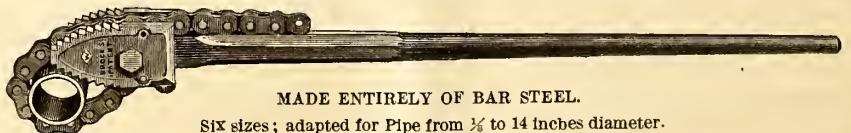

MADE ENTIRELY OF BAR STEEL.

SIX sizes; adapted for Pipe from ½ to 14 inches diameter.

Each number will fit a range of sizes equal to six or more pairs of common tongs, while it will outwear an equal number of any kind.
All parts are interchangeable, and can be readily renewed.

Jaws are hardened to a saw temper, and can be sharpened with a file.
Does not crush pipe; has a quick grip; never slips; chain will not unhitch while in use, but can be instantly released.

J. H. WILLIAMS & CO.,
Manfs. of Every Description of Iron and Steel Drop Forgings.
No. 14 BOWNE STREET (Near Hamilton Ferry), BROOKLYN, N. Y.

NATIONAL GAS LIGHT AND FUEL COMPANY,

Sole Owners and Licensees of the Springer Patent Cupola and Process for the U. S.,

Chicago.

Builders, Lessees, and Purchasers of

GAS WORKS

UNDER THE

Springer Cupola Gas Generating System.

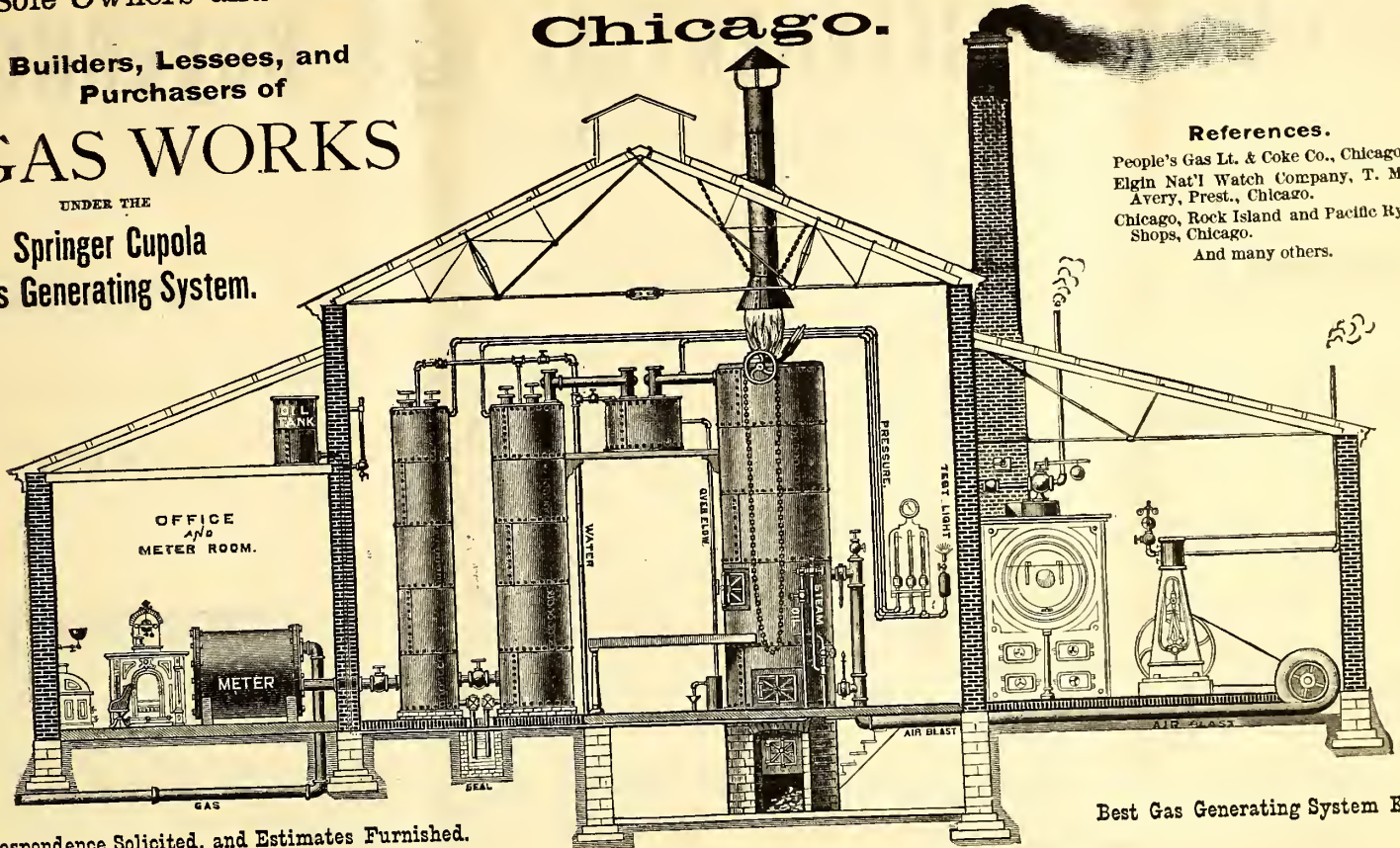

References.

- People's Gas Lt. & Coke Co., Chicago.
- Elgin Nat'l Watch Company, T. M. Avery, Prest., Chicago.
- Chicago, Rock Island and Pacific Ry. Shops, Chicago.
- And many others.

Best Gas Generating System Known.

Correspondence Solicited, and Estimates Furnished.

Orders from Cities, Towns, and Public Institutions Promptly Executed. Address

NATIONAL GAS LIGHT AND FUEL COMPANY, - - - No. 162 Washington Street, Chicago, Ill.

BURDETT LOOMIS, HARTFORD, CONN.

Builder of Gas Works.

LOOMIS'S PATENT WATER GAS APPARATUS, FOR MAKING ILLUMINATING OR HEATING GAS FROM BITUMINOUS SLACK, ANTHRACITE COAL SCREENINGS, COKE, LIGNITE, OR WOOD.

More gas can be made with this apparatus, using **BITUMINOUS SLACK**, than by any other process using same amount of best quality Anthracite Coal, and with less oil. No clinker; no filling up of superheater with ashes, as they are separated from the coal in the process of blasting and easily removed. Plans and estimates furnished.

Taylor's
AUTOMATIC GAS CHECK.

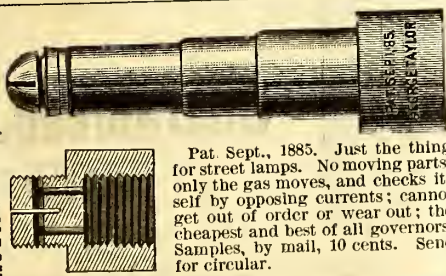

Pat. Sept., 1885. Just the thing for street lamps. No moving parts; only the gas moves, and checks itself by opposing currents; cannot get out of order or wear out; the cheapest and best of all governors. Samples, by mail, 10 cents. Send for circular.

G. TAYLOR, 60 Duane st., N. Y.

The Forest City Naptha Co.,

REFINERS OF

NAPTHA AND GASOLINES.

ALSO MANUFACTURERS OF

A Special Grade of Naptha for Gas Companies

FOR ENRICHING COAL GAS.

Correspondence solicited.

No. 43 Euclid Avenue, Cleveland, Ohio.



Shafting, Pulleys, HANGERS.

F. Brown's Patent Friction Clutch.

Send for Illustrated Catalogue and Discount Sheet to

A. & F. BROWN,

No. 43 Park Place, New York City.

PIPE COVERINGS.

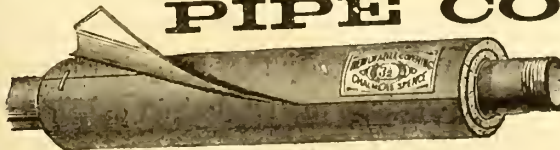

FIREPROOF, NON-CONDUCTING COVERINGS FOR

Steam Pipes, Boilers, AND ALL HOT SURFACES.

Made in sections three feet long. Easy to apply; light and cheap.

These Goods are used at the Continental Works, Brooklyn.

Asbestos Materials, Fibre, Braided Packing, and Cement.

CHALMERS-SPENCE COMPANY, 419 & 421 EIGHTH ST., N. Y.

T. C. HOPPER'S AUTOMATIC DIFFERENTIAL GAS GOVERNOR, PATENTED.

EXCELS
ALL OTHERS
IN
SIMPLICITY,
AND
COMBINES
PERFECT ACTION
WITH
RELIABILITY.

PRICES
ARE
Moderate,
AND
ENTIRE
SATISFACTION
IS
Guaranteed.

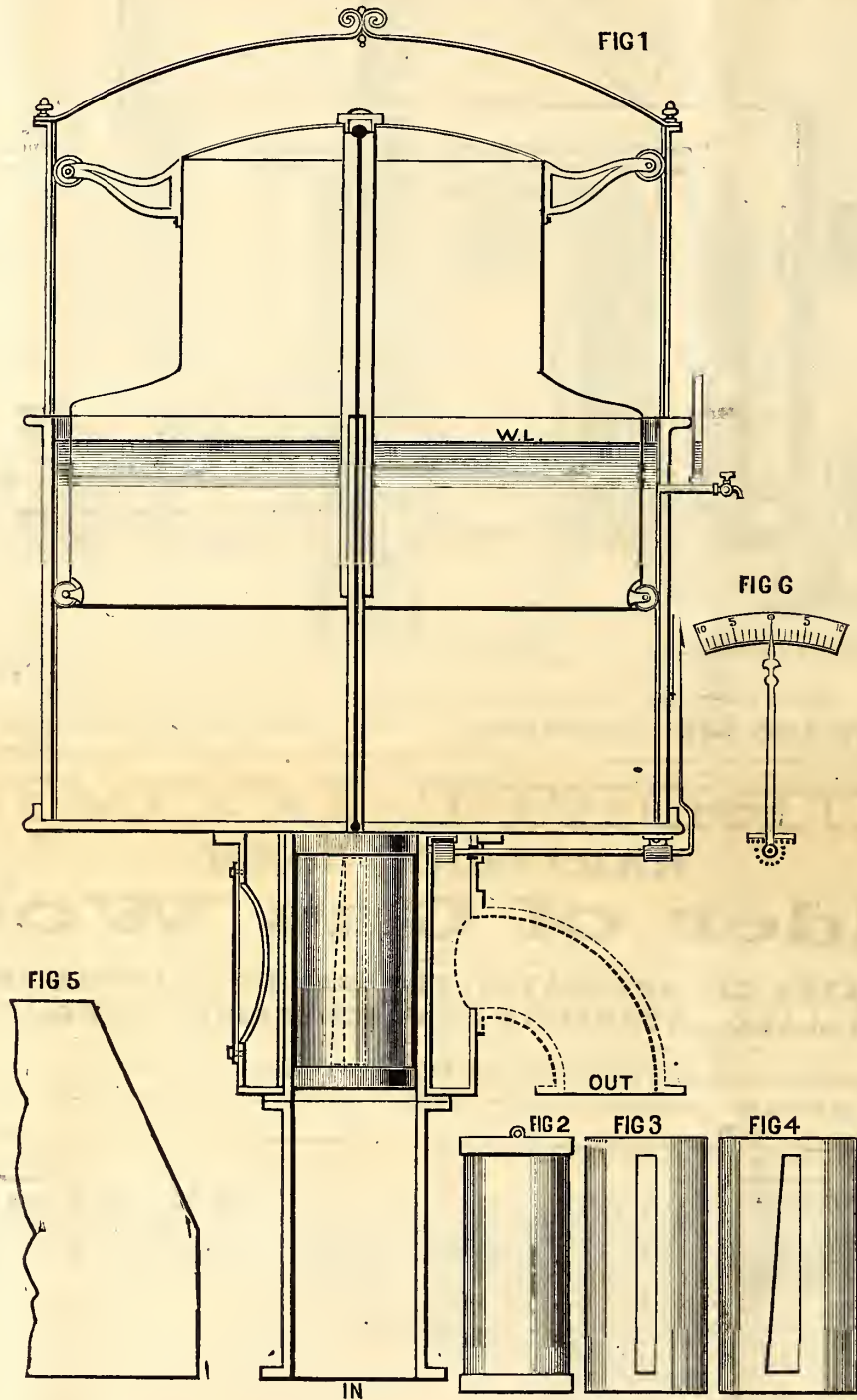

The Governor illustrated above, while similar to those in general use, differs in its action, as the bell (or holder) is of different shape—the object sought being a *differential* pressure to meet exactly the output of gas during the hours of consumption at all seasons. It will do this *without* the aid of weights, and is *entirely automatic* in its action. When the demand for gas increases the bell lowers, and in its descent opens the valve and *increases* the pressure simultaneously. When the demand is lessened the bell rises, partially closing the valve and *diminishing* the pressure. The sleeve [fig. 4] is a very valuable adjunct, as by it the ports (or gas-ways) in valve casing [fig. 3] can be lessened at will, so as to adjust the openings to any desired output of gas for winter or summer consumption a feature found in no other Governor. The bell (or holder) can be adapted to any form of valve at present in use.

Circulars, with full description, will soon be sent to all gas companies, and to all others requesting them.

T. C. HOPPER, - - - **Arch and 22d Streets, Philadelphia, Pa.**

CONNELLY'S AUTOMATIC GOVERNOR FOR STREET MAINS.

We give herewith a few late letters from gas companies using our Governor, and also a cut (exact reproduction) of two pressure sheets from the Quincy (Ill.) Gas Works. A careful inspection of the cut will reveal more concerning the Governor's accuracy and reliability than we could express in all the columns of the JOURNAL. It shows clearly that the Governor is endowed with more than human intelligence, and fully verifies a late remark of a certain "Western Member"—"Connelly's Governor is brains in iron." At Quincy the stores close early, and on all week nights excepting Saturday the Governor begins to reduce the pressure at about 8:30 P.M.; but on Sunday evening (when the consumption is so light that the Governor puts on only 19-tenths pressure) it is *one-half hour later* beginning to reduce—its action being the reverse of that followed by nine out of ten intelligent managers under the same circumstances or conditions. Although the consumption is much less on Sunday nights than on others, the volume per hour remains the same until 9 o'clock, when the church lights are extinguished. The Governor thus shows a finer discrimination than human intelligence is capable of. We do not boast of what our Governors "can" or "will" do, but submit evidence of **WHAT THEY ARE DOING!** We now have 43 of these machines in practical operation, and experience has taught us that a machine so delicate and sensitive in its construction, liable to be placed under such widely varying conditions, *cannot be perfected on paper.* Our late improvements enable us to send out a Governor to *any works*, capable of being adjusted to any possible conditions or requirements after it is in place. A 20-inch Governor can be sent to one works and adjusted to hold 3-tenths day and 40-tenths night pressure, and its duplicate or counterpart may be sent to another works having same consumption and initial pressure, and be set to hold 10-tenths day pressure and 11-tenths night pressure—both working perfectly as desired. Such range of adjustment is absolutely necessary in an Automatic

Governor, not only to secure the desired action in the beginning, but to be prepared to meet the new conditions sure to follow the building of a heavier holder or a large increase in capacity of the mains. No Governor in this country or abroad, in use or illustrated on paper, is constructed with such a range of adjustment, and to secure it would require a radical change in principle.

Another important feature of our Governor *not found in others* is the *absolute impossibility of the valve sticking in its seat* and shutting off the gas. We do not permit the valve to *enter* its seat; it is so constructed that it bears at *right angles* on a knife-edge seat, and must fall away from it when its supporting pressure is reduced in the least degree. The great value of this feature will impress itself on the careful Gas Manager. In short, our experience has enabled us to meet every possible requirement in Automatic Governors (as the accompanying letters attest), and we can unhesitatingly guarantee every Governor sent out to give perfect satisfaction in every respect, or will remove same at our expense. It is useless for us at this late day to waste any words on the *economy* and *satisfaction* derived from such a machine; and no progressive Engineer or Superintendent would to-day plan a works without locating an Automatic Governor. As they are finely finished and highly ornamental, their proper place is in the Office or Meter Room. As one of these Governors will *save its cost* in a short time, no company should hesitate to place one. The more perfect distribution and satisfaction given consumers are additional advantages that cannot be estimated in dollars and cents. We publish below a few letters, and will publish others in the following numbers of the JOURNAL.

CONNELLY & CO., Ltd., 407 Broadway, N.Y.

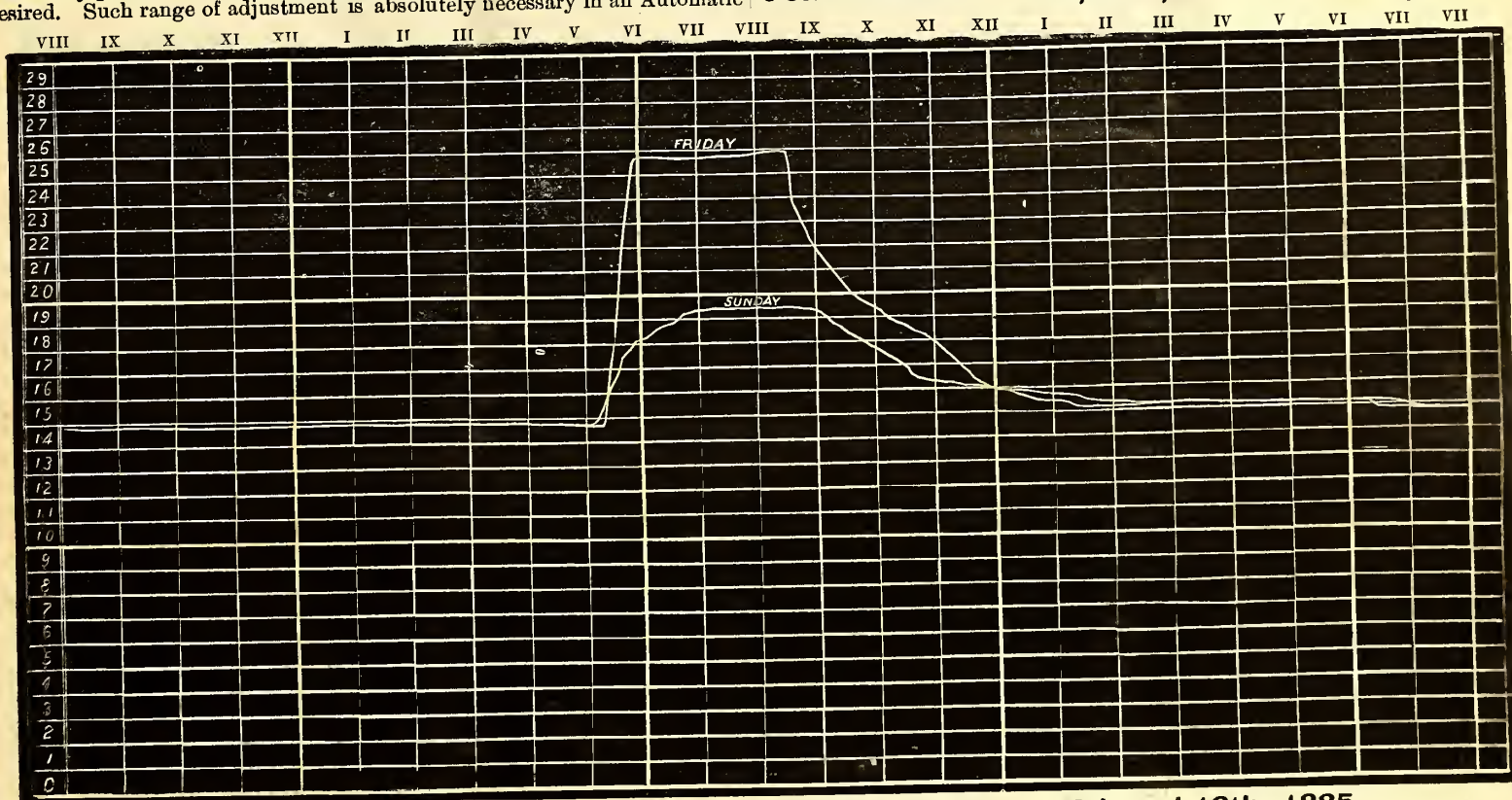

THE CLERK GAS ENGINE.

Highest Award American Institute, New York, 1883. Silver Medal American Institute, N. Y., 1884.
Gold Medal Awarded Crystal Palace Electrical Exhibition, London, 1882.
Highest Award for Motive Power British Section International Exhibition of Electricity, Paris, 1881.

Reliable.
No Boiler.
Steady.
No Coal.
Simple.
No Ashes.
Compact.

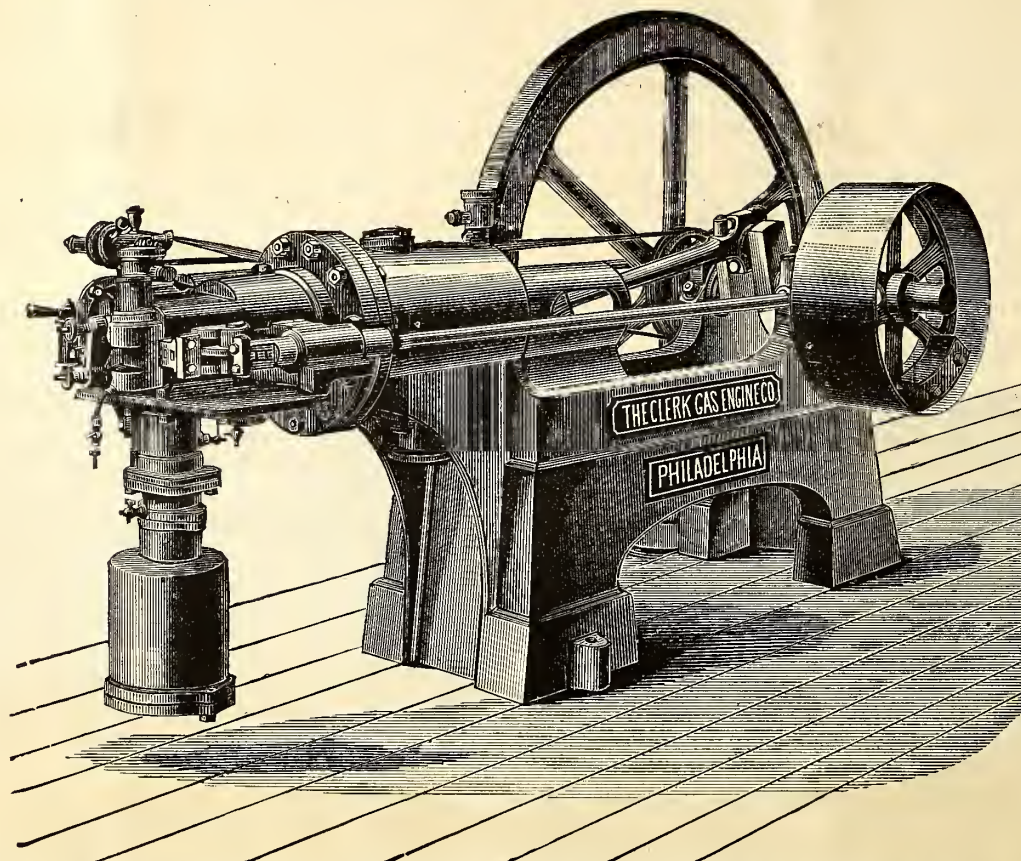

Economical.
No Engineer.
No Explosion
No Gearing
Wheels.
No Danger.
No Parts
requiring
frequent
renewal.

REQUIRING ONLY A MATCH TO START IT--GIVING ITS FULL POWER IMMEDIATELY.

We would inform the public that during the last few months we have improved THE CLERK GAS ENGINE to such an extent that we can now offer an engine vastly superior to our former pattern. These improvements have enabled us to sell our engine at a GREATLY REDUCED FIGURE, partly on account of the decreased weight (our engine weighing about half that of others giving the same Brake H. P). The consumption of gas has been decreased to a considerable extent, and the Brake H. P. has been increased some 25 to 30 per cent. All parts of the old design that were considered defective have been remodeled and new designs added. We now have an engine second to none as regards power, consumption, and ease of working. With our new engine all trouble in starting has been removed, the noise reduced to a minimum, and the regularity of motion is now all that can be desired. We guarantee all we claim for it, and the material and workmanship being of the best, enables us to guarantee the engine for twelve months.

SOLE MAKERS,

THE CLERK GAS ENGINE CO.,

WM. W. GOODWIN, President. E. STEIN, Secretary. S. LEWIS JONES, Asst. Secretary. L. P. GARRET, Supt.

Main Office, 1012-1018 Filbert Street, Philadelphia, Pa.

BRANCH OFFICES,

142 Chambers St., N. Y.

4 West Fourteenth St., N. Y.

76 Dearborn St., Chicago

General Agents,

THE GOODWIN GAS STOVE & METER CO.

Of Philadelphia, New York, and Chicago.

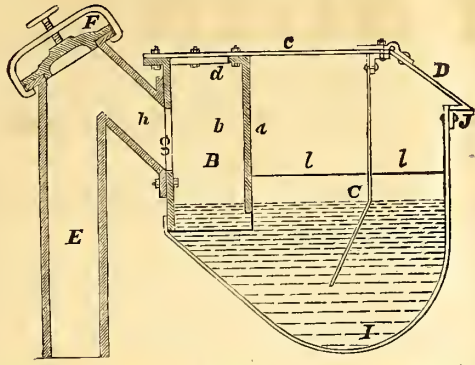

Boardman Hydraulic Main,
Patented October 7, 1884.

For description, see AM. GAS LIGHT JOURNAL of Feb. 2, 1884.
For terms, apply to

A. E. BOARDMAN, Macon, Ga.

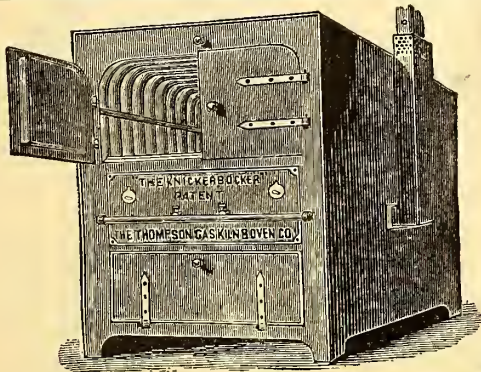

"The Knickerbocker" Portable Gas Oven,
ON EXHIBITION AT AMERICAN INSTITUTE FAIR.
Thompson Gas Kiln & Oven Co.
59 Carmine St., N. Y.
Send for Circular by mail.

MITCHELL, VANCE & CO.,

MANUFACTURERS OF

Chandeliers

and every description of

GAS FIXTURES.

Also manufacturers of Fine Gilt Bronzes and Marble Clocks,
warranted best time-keepers. Mantel Ornaments, etc.

Salesrooms, 836 Broadway, N. Y.

Special Designs furnished for Gas Fixtures for Churches, Public
Halls, Lodges, etc.

EVENS & HOWARD,

916 Market St., St. Louis. Mo.

Works, Howard Station, Mo. Pacific R.R.

Fire Brick, Gas Retorts

AND

RETORT SETTINGS.

Sewer Pipe, 3 to 24 in. diameter.

Glass Pot Clay, Ground Fire Clay, in barrels and in bulk. All
kinds of Fire Clay Goods.

Iron Sponge,
GAS EXHAUSTERS,

AUTOMATIC GAS GOVERNORS,

CONNELLY & CO., Limited,
No. 407 BROADWAY, NEW YORK CITY.

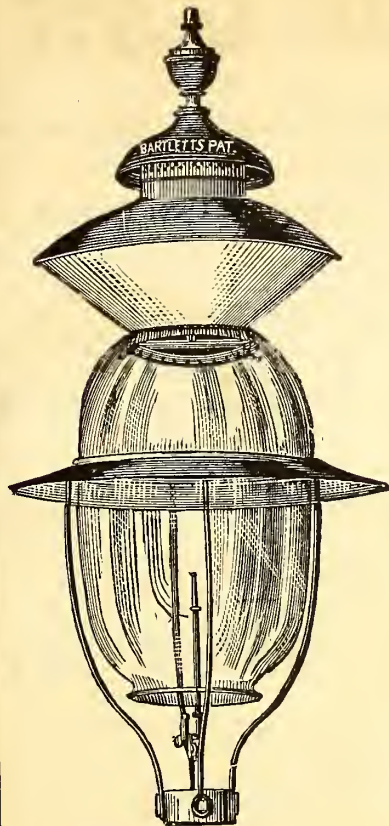

C. BARCALOW, PREST.

J. V. BARCALOW, SEC. & TREAS.

BARTLETT
Street Lamp Mfg. Co.

MANUFACTURERS OF

Bartlett's Patent

GLOBE LAMPS.

FOR

Streets, Parks, Railroad Stations, Public
Buildings, Etc.

LAMP POSTS A SPECIALTY.

Office and Salesroom,

No. 35 Howard Street, N. Y. City.

Gas Companies and others intending to erect lamps and posts
will do well to communicate with us.

F. M. ROOTS.

S. C. ROOTS

D. T. ROOTS.

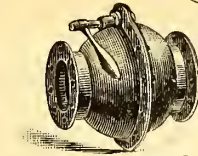
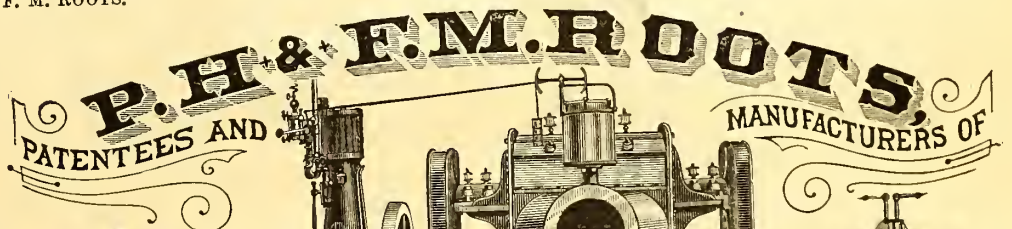

GAS VALVE.

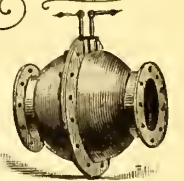

BYE-PASS.

IMPROVED GAS EXHAUSTER,

WITH ENGINE ON SAME BED PLATE, OR WITHOUT.

BYE-PASSES, GAS VALVES, GOVERNORS, ELBOWS, PIPE-FITTINGS, Etc., FURNISHED TO ORDER,

P. H. & F. M. ROOTS, Patentees & Manufacturers, **CONNERSVILLE, IND.**

S. S. TOWNSEND, General Agent, 22 Cortland St. and 9 Dey St., N. Y.

JAS. BEGGS & CO., Selling Agents, 9 Dey St., N. Y.

COOKE & CO., Selling Agents, 22 Cortland St., N. Y.

❖ SEND FOR ILLUSTRATED CATALOGUE AND PRICE LIST. ❖

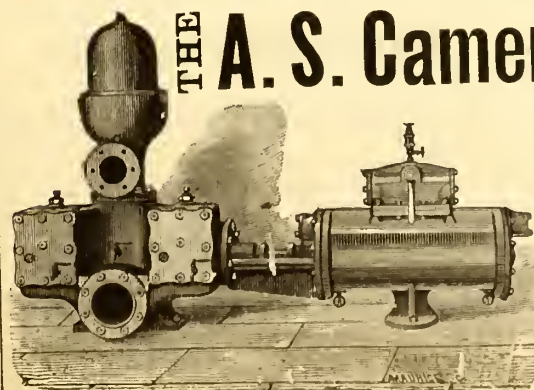

THE A. S. Cameron Steam Pump,

THE STANDARD OF EXCELLENCE.

Upward of 30,000 in Use.

BEST GAS WORKS PUMP
Ever Introduced.

Adapted to Every Possible Duty.

A. S. Cameron Steam Pump Works,

Foot East 23d St., N. Y.

J. H. GAUTIER & CO..

CORNER OF
GREENE AND ESSEX STREETS,
JERSEY CITY, N. J.

MANUFACTURERS OF

Clay Gas Retorts,
Gas House Tiles,
Fire Bricks, Etc. Etc.
Ground Clay, Fire Brick and
Fire Sand in Barrels,

J. H. GAUTIER.
C. E. GREGORY.

T. B. GAUTIER.
C. E. GAUTIER.

BROOKLYN

Clay Retort & Fire Brick Works,
(EDWARD D. WHITE & CO.)

Manufacturers of Clay Retorts, Fire Brick,
Gas House and other Tile.

VAN DYKE, ELIZABETH, RICHARDS & PARTITION STS.
Office, 88 Van Dyke St., Brooklyn, N. Y.

LACLEDE FIRE BRICK MFG. CO.,

MANUFACTURERS OF

Fire Brick, Gas Retorts,

AND

ST. LOUIS STANDARD SEWER PIPE.

Blast Furnace and Cupola Linings, every description of Fire
Clay Material, Fire Clay Flue Linings, Chimney Tops
Dry Milled and Crude Fire Clays, etc.

OFFICE AND DEPOT

901, 903, and 905 Pine Street,
ST. LOUIS, MO.

ESTABLISHED IN 1845.

B. KREISCHER & SONS,

OFFICE FOOT OF HOUSTON ST., E.R., N.Y.

Gas Retorts,

TILES, FIRE BRICK.

AND EVERYTHING IN THE FIRE CLAY LINE.

MANHATTAN

FIRE BRICK & ENAMELLED CLAY

RETORT WORKS.

ADAM WEBER.

CLAY GAS RETORTS

AND RETORT SETTINGS

FIRE BRICKS, TILES, ETC.,

Office and Works, 15th Street and Avenue C., N. Y.

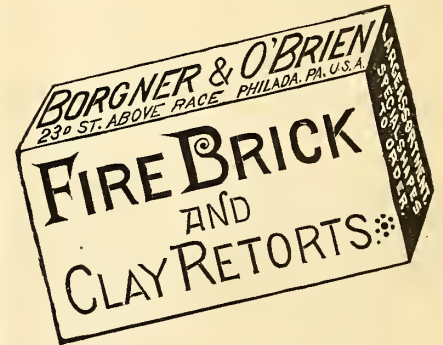

JAMES GARDNER, JR.

Works,
LOCKPORT STATION, PA.

—ESTABLISHED 1864.—

WILLIAM GARDNER & SON,
Successor to GARDNER BROTHERS.

WILLIAM GARDNER.

Office, COAL EXCHANGE,
PITTSBURGH, PA., P. O. Box 373.

Fire Clay Goods for Gas Works.

C. H. SPRAGUE, No. 70 KILBY STREET, BOSTON, MASS., Agent for the New England States.

OFFICE, 418 to 422 East 23d St., New York.

ESTABLISHED 1856.

WORKS, PERTH AMBOY, NEW JERSEY.

HENRY MAURER,

Excelsior Fire Brick & Clay Retort Works

CLAY GAS RETORTS, BENCH SETTINGS, FIRE BRICK, TILES, ETC.

STANDARD GAS RETORT AND FIRE BRICK COMPANY,

J. ANDERSON, PRES. & MANG'R.

OF IRONTON, OHIO.

C. PETERS, SECRETARY.

Clay Gas Retorts, Fire Brick, and Fire Clay Goods of Every Description.

Plans of Livesey-Somerville, McIlhenny, and other Furnaces, and Competent Workmen Supplied.

CHICAGO

Retort & Fire Brick Works,

OFFICE AND FACTORY,
Clark, Forty-Fifth, and La Salle Streets,
CHICAGO, ILL.

GEORGE C. HICKS, PRES. PAUL P. AUSTIN, SEC. & TREAS.

STANDARD

Clay Retorts and Settings.

BLOCKS & TILES

Of every Shape and Size to Order.

Standard Fire Bricks.

NEWBIGGING'S

Gas Manager's Handbook.

Price, \$4.80.

EVERY GAS MAN SHOULD HAVE ONE.

Orders may be sent to this Office.

OAKHILL

GAS RETORT & FIRE BRICK

COMPANY.

PARKER, RUSSELL & CO.

City Office, 711 Pine Street,

ST. LOUIS, MO.

Our immense establishment is now employed almost entirely in
the manufacture of

MATERIALS FOR GAS COMPANIES.

We have studied and perfected three important points. Our re-
torts are made to stand changes of temperature, the strongest
heats of the furnace, and the abrasion of feeding and emptying.
Our customers are in almost every State of the Union, to all of
whom we refer.

THOS. SMITH, Prest.

AUGUST LAMBLA, Vice-Prest. & Sup

BALTIMORE

RETORT & FIRE BRICK CO.

MANUFACTORY AT

LOCUST POINT, BALTIMORE, MD.

Connection with the City by Telephone.

Clay Retorts, Blocks & Tiles,

FIRE BRICK, FIRE CLAY,
AND FIRE CEMENT.

Red and Buff Ornamental Tiles and Chim-
ney Tops. Drain and Sewer Pipe (from
2 to 30 inches). Baker Oven Tiles
12 x 12 x 2 and 10 x 10 x 2.

WALDO BROS., 88 WATER ST., BOSTON, MASS

Sole Agents for New England States

THE AMERICAN METER CO.,

MANUFACTORIES,

508 to 514 West Twenty-second St., N. Y.

Arch and Twenty-second St., Phila.

Nos. 244 & 246 North Wells Street, Chicago, Ill.

AGENCIES,

No. 177 Elm Street, Cincinnati, Ohio.

Nos. 122 & 124 Sutter Street, San Francisco, Cal.

No. 810 North Second Street, St. Louis, Mo.

NEW

INCANDESCENT

Gas Fires

AND

OPEN

Fire Place

Heaters.

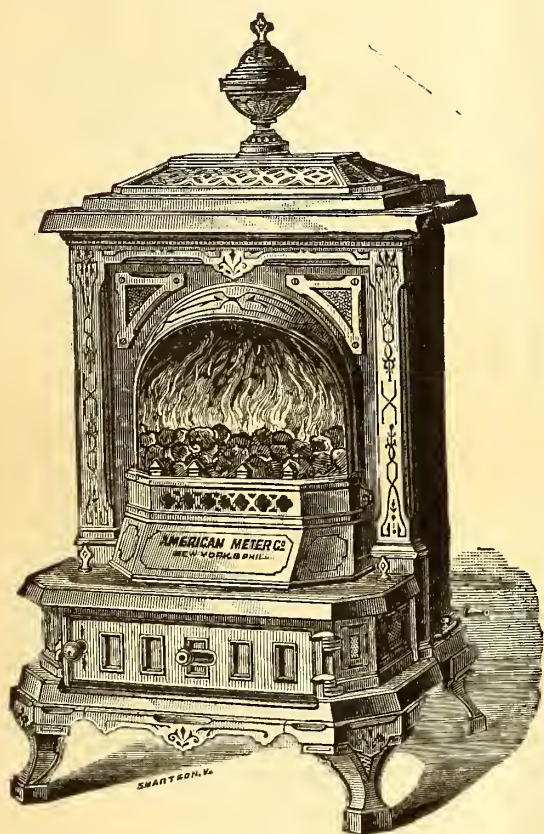

Open Fire Place Heater No. 19.
Fitted with the New Incandescent Gas Fire.

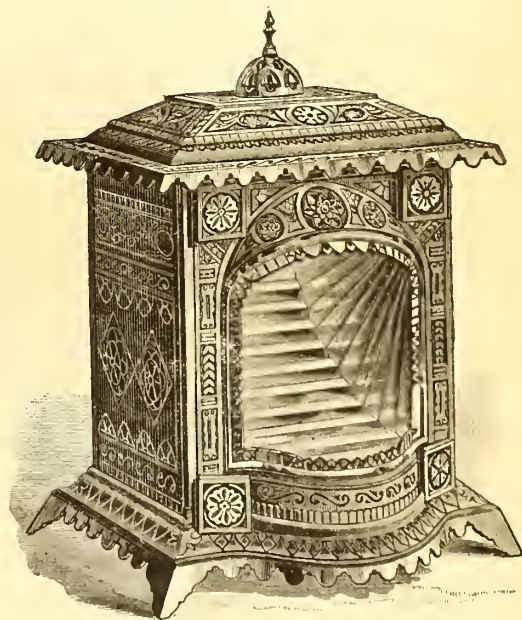

Open Fire Place Heater No. 17C.
Fitted with Illuminating Burners and Copper Reflector.

We call attention to Special Apparatus Heated by Gas for Manufacturing Purposes. Gas Furnaces for Tinmen's use; Furnaces for melting Solder and Type Metal; Apparatus for bending Carriage Panels (in successful operation in Carriage Manufactories); Water Heaters for Kitchen Boilers, Baths, etc., and for attaching to Heating Coils and Pipes for Conservatories.

THE COMPANY MANUFACTURES

GAS STOVES FOR COOKING AND HEATING PURPOSES

In all Sizes, for Domestic, Restaurant, and Hotel Use.

These Stoves may be seen in operation at our Retail Store, No. 223 Sixth Avenue, N. Y. Call and examine.

SEND FOR CATALOGUE OF TWENTY DIFFERENT STYLES OF HEATING STOVES.

A. H. M'NEAL,

BURLINGTON, N. J.

Flange-Pipes

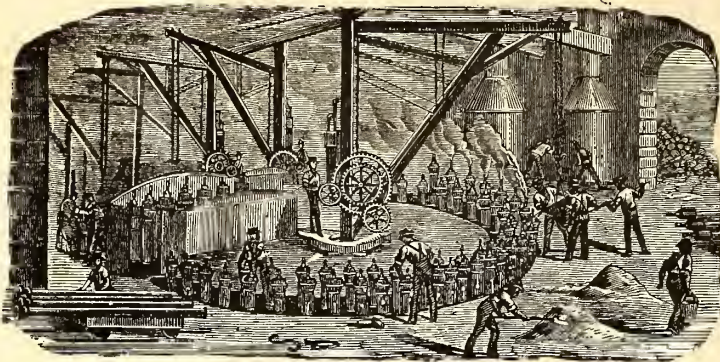

General Foundry Work.

CAST IRON PIPES FOR WATER AND GAS.

JAMES S. MOORE, Pres.
BENJAMIN HEW, Treas.

JAS. P. MICHELLON, Sec.
WM. SEXTON, Supt.

GLoucester IRON WORKS, GLoucester CITY, N. J.

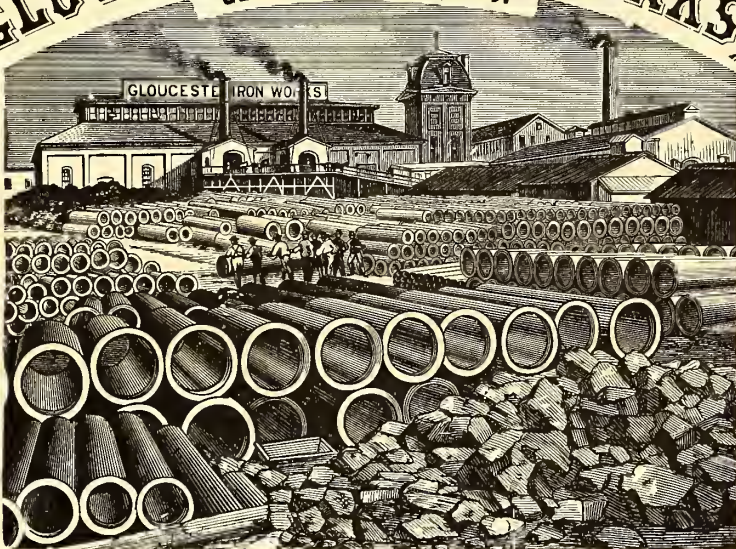

Cast Iron Gas & Water Pipes, Stop Valves, Fire Hydrants, Gasholders, &c.
Office No. 6 North Seventh Street, Philadelphia.

ESTABLISHED 1856.

WARREN FOUNDRY AND MACHINE CO.,

WORKS AT PHILLIPSBURGH, N. J.
NEW YORK OFFICE, 162 BROADWAY.

Cast Iron Water and Gas Pipe

FROM TWO TO FORTY-EIGHT INCHES DIAMETER.
ALSO ALL SIZES OF

FLANGE PIPE for Sugar House and Mine Work.
Branches, Bends, Retorts, Etc., Etc.

MATTHEW ADDY, President.

W. L. DAVIS, Selling Agent.

GEO. P. WILSHIRE, Sec. & Treas.

Cincinnati and Newport Iron and Pipe Company, NEWPORT, KY.

Lamp Posts
AND
BENCH CASTINGS

A Specialty.

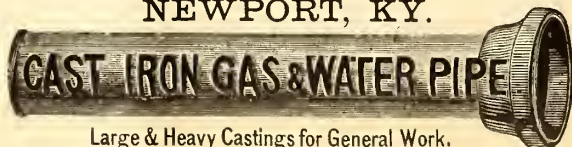

Large & Heavy Castings for General Work.

Manufacture Pipe from 2 to 48 inches. All work guaranteed first quality.

Branch
AND
SPECIAL CASTINGS
FOR GAS & WATER CO'S.

ARNOLD MELLERT, Chairman. P. D. WANNER, Sec. & Treas.
MELLERT FOUNDRY & MACHINE CO., Ltd.,
Reading, Pa.



Specials—Flange Pipe, Valves and Hydrants,
Lamp Posts, Retorts, etc.

NEW YORK OFFICE,

FOX & DRUMMOND, - 160 Broadway.

CAST IRON

Gas and Water Pipes,

From 2 to 48 Inches in Diameter.

FOX & DRUMMOND,

160 Broadway, N. Y. City.

THE OHIO PIPE COMPANY,

MANUFACTURERS OF

Cast Iron Gas & Water Pipe, BRANCH AND SPECIAL CASTINGS.

Gas-House Bench Castings, Hydraulics, Lamp Posts, Flange Pipe
and Specials, Architectural Castings, Building Columns,
Joists, Cellar Grates, Sash Weights, etc.

GENERAL FOUNDERS AND MACHINISTS.
Columbus, Ohio.

LUDLOW VALVE MFG. CO.

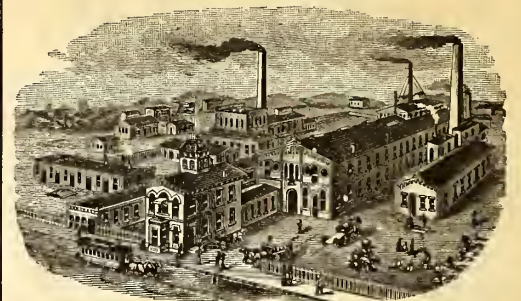

OFFICE AND WORKS,

938 to 954 River Street and 67 to 83 Vail Av.
TROY, N. Y.

Hydraulic Main Dip Regulators, also
Check Valves, Foot Valves, Yard-
wash and Fire Hydrants.
Send for Circulars.

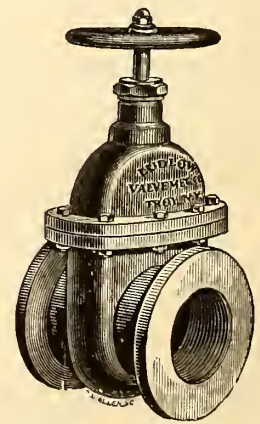

Valves.—Double and Single Gate, 1/2 in. to
48 in., outside and inside Screws. Indica-
tor, etc., for Gas, Water, Steam, and Oil.
and for Circulars.

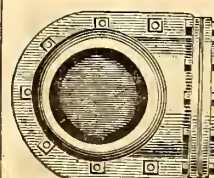

John McLean

Manufacturer of
**GAS
VALVES.**

298 Monroe Street, N. Y.

Siemens's Regenerative Gas Burners, For Lighting and Ventilating.

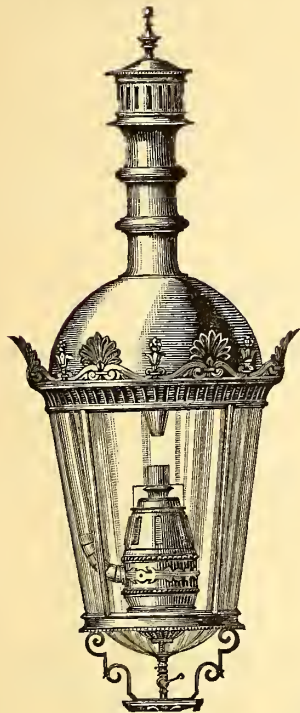

THE CHEAPEST, PUREST, AND MOST BRILLIANT OF ALL GAS LIGHTS.

Superior to the Electric Light in Economy, Beauty, & Steadiness.

SPECIALLY ADAPTED FOR LIGHTING HALLS, FACTORIES, OPEN SPACES, ETC.

Numerous Tests made by various Gas Companies in the United States show an Efficiency of Ten Candle Power per Cubic Foot of Gas.

General Agents:

- SIEMENS LIGHTING CO., 347 West Main St., Louisville, Ky.
- MEYER, MARSHALL & CO., 528 California St., San Francisco.
- DENNEHY, WOLF & O'BRIEN, 85 & 87 Dearborn St. Chicago, Ill.
- WILCOX & McGEARY, - No. 11 Bissel Block, Pittsburgh, Pa.
- T. T. RAMSDALL & CO., - 20 Swan Street, Buffalo, N. Y.
- SIEMENS GAS ILLUMINATING CO.,
Room 6, No. 157 Broadway, New York City.
- W. D. COLT, - - - - 1420 F Street, Washington, D. C.
- JOHN KIEFER, - - - - 344 Lawrence, Street, Denver, Col.

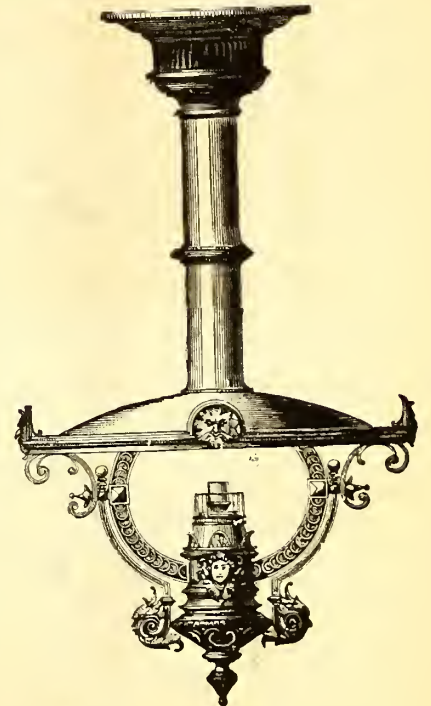

THE SIEMENS REGENERATIVE GAS LAMP COMPANY.

SOLE MAKERS FOR THE UNITED STATES,

N. E. Cor. 21st. St. and Washington Av., Philadelphia. Pa.

THE "STANDARD" WASHER-SCRUBBER,

KIRKHAM, HULETT & CHANDLER'S PATENT.

Total Capacity per 24 Hours of "Standard" Washers Ordered During the Following Years.

1877.....	4,000,000 cubic feet.
1878.....	4,750,000 "
1879.....	24,545,000 "
1880.....	42,967,500 "
1881.....	36,462,500 "
1882.....	39,300,000 "
1883.....	57,735,000 "
1884.....	28,177,500 "
Total.....	235,937,500 cubic feet.

Total Number and Capacity per 24 Hours of "Standard" Washers Erected and in Course of Erection in the Several Countries

	Number.	Cubic Feet per Day.
Great Britain ..	151	157,070,000
Western Hemisphere.	38	39,337,500
Australia.....	18	12,150,000
New Zealand ..	2	650,000
France	6	4,550,000
Belgium.....	8	5,420,000
Germany	16	8,200,000
Holland.....	4	4,100,000
Denmark.....	1	150,000
Russia.....	2	3,500,000
Spain.....	1	350,000
India.....	1	400,000
Total.....	248	235,937,500

**THE CONTINUED POPULARITY
Of these Machines**

Will be recognized from the following extracts from letters from representatives of some of the companies having them in use:

OFFICE METROPOLITAN GAS Co, N. Y. CITY.

We have had the "Standard" Washer Scrubber you furnished to us in action since August, 1882. The ammonia liquor derived from it has a strength of from 12 to 20 oz. Twaddle, and it works uninterruptedly and satisfactorily.

OSCAR ZOLLIKOFFER, Prest.

Dr. E. G. Love, official Gas Examiner for New York city, reported Metropolitan gas for quarter ending June 30th, 1885, as follows: Illuminating power, 25.04; ammonia, grains in 100 cu. ft., 2.46.

LACLEDE GAS WORKS,
St. LOUIS, Mo. Nov. 25, 1884. }

The "Standard" is performing its work to our entire satisfaction. It has passed and freed from ammonia 30 per cent. more gas than it was rated as being able to pass. The test paper shows not a trace of ammonia.

FREDERIC EGNER, Eng. and Supt.

"Standard" Washers Ordered Recently.

	Cu. Ft. per Day
Anneberg Gas Co.....	200,000
Bombay Gas Co.....	400,000
Brussels Co.....	1,250,000
CHICAGO, two, 1,000,000 each.....	2,000,000
Chemnitz Gas Co ..	1,000,000
CITIZENS GAS CO., BUFFALO.....	750,000
Coke Works in Zabre, Ober-Schlesien.....	1,500,000
Cokereel der Friedenshutte, Upper Silesia. ...	1,000,000
Dumfries Corporation.....	250,000
Dunedin Gas Co., New Zealand	400,000
GEORGETOWN, D. C.....	250,000
King's Lynn Gas Co.....	300,000
Leiden, Holland.....	600,000
Lincoln Gas Co.....	400,000
Liverpool Gas Co.....	2,000,000
"	3,000,000
LOUISVILLE GAS CO.....	1,500,000
MUTUAL GAS CO., BUFFALO.....	750,000
MINNEAPOLIS GAS CO.....	1,000,000
Numea Gas Co.....	100,000
PITTSBURGH GAS CO.....	1,500,000
PAWTUCKET, R. I.....	500,000
PORTLAND GAS CO., Oregon	502,500
SAN FRANCISCO GAS CO.....	4,000,000
Sheepbridge ..	40,000
ST. LOUIS GAS CO.....	2,000,000
Sydney Gas Co.....	2,500,000
WASHINGTON, D. C. GAS CO.....	2,000,000
Whitechurch Gas Co	175,000
Total.....	29,677,500

GEO. SHEPARD PAGE, No. 69 WALL STREET, NEW YORK,
SOLE AGENT FOR THE WESTERN HEMISPHERE.

R. D. WOOD & CO.,

400 Chestnut Street, Phila., Pa.

Cast Iron Gas & Water Pipe, Water Machinery & Gas Apparatus

Cast Iron Pipe, Fire Hydrants, Eddy Valves, Lamp Posts, Large Loam Castings, Flanged Pipe, Sugar House Work, Iron Roofs and Floors, Wrought & Cast Iron Tanks, Turbine Water Wheels and Pumps.

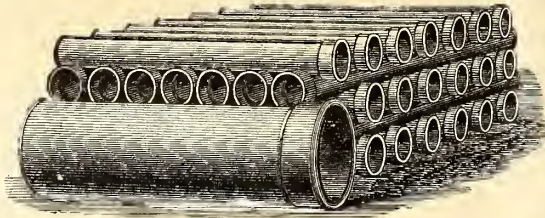

Casholders, Lime Trays, Center Valves, Purifiers, Bench Work, Exhausters, Condensers, Governors, Scrubbers, Gas Valves, Station Meters, Cast Iron Pipe Fittings.

Manufacturers of Heavy Castings and Machinery of Every Description.

ENGINEERS & CONTRACTORS FOR THE ERECTION OF GAS WORKS, & ALL MACHINERY CONNECTED THEREWITH.

Estimates and specifications furnished for erection of new works or the extension or alteration of old ones.

Foundries and Works. - - Millville, Florence, and Camden, N. J.

SMITH & SAYRE MFG. COMPANY,

G. G. PORTER, Prest.

245 Broadway, N. Y. CHAS. W. ISBELL, Sec'y.

Machinery & Apparatus for Gas Works

Drawings, Plans, and Estimates Furnished for the Improvement, Extension, or Alteration of Gas Works, or for the Construction of New Works.

Mackenzie's Patent Rotary and Steam Jet Gas Exhausters, Governors, Compensators, Condensers, Washers, Scrubbers. Isbell's Patent Automatic Street Pressure Governor, Gas and Water Valves, Hydraulic Main Dip Regulator, Bench Castings, etc. Purifying Boxes and "Standard" Scrubbers. Isbell's Patent Self-Sealing Retort Doors.

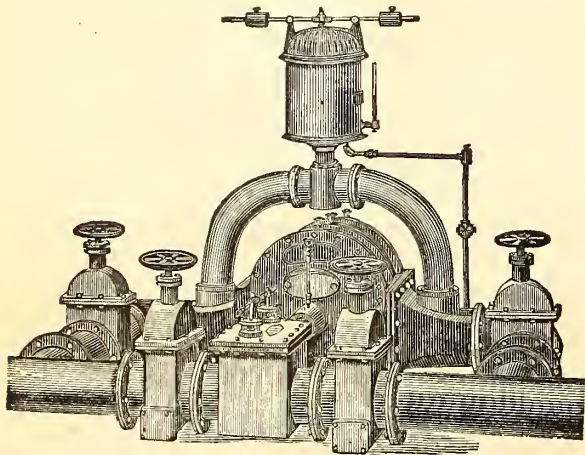

W. E. Tanner, Pres., W. R. Trigg, V.-Pres., A. Delaney, Supt.

Tanner & Delaney Engine Co.
RICHMOND, VA.

Gas Apparatus,

INCLUDING

Condensers of various styles, Scrubbers, Holders, Purifiers, Castings for Retort Houses, Etc.

ALSO STEAM ENGINES AND BOILERS.
Plans, Specifications and Estimates Furnished.

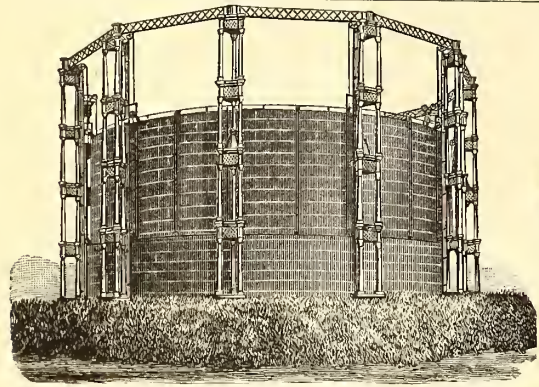

SOUTHWARK FOUNDRY AND MACHINE COMPANY,

Successors to MERRICK & SONS. Established in 1836.

No. 430 Washington Avenue, Philadelphia, Pa.

MANUFACTURERS OF

Single and Telescopic Gasholders,

BENCH CASTINGS,

Washers, Scrubbers, Condensers, Purifiers,

And all apparatus necessary for the construction of improved new gas works and in the extension of established works. Also manufacturers of

Gas Engines, and of all descriptions of Steam and Hydraulic Machinery, and of Boiler and Tank Work.

Plans, specifications, and estimates furnished promptly on application.

MORRIS, TASKER & CO., Limited,

Builders of Gas Works,
PHILADELPHIA, PA.

To Gas Companies.

We make to order **CAP BURNERS** to burn any amount under a stated pressure. Send for samples.

Also, SERVICE CLEANERS, DRIP PUMPS, and STREET MAIN PROVING APPARATUS.

C. A. GEFROER,
248 N. 5th Street, Phila., Pa.

WM. HENRY WHITE,

Consulting & Constructing

Gas Engineer & Contractor.

ESTIMATES, PLANS, AND SPECIFICATIONS FURNISHED FOR NEW WORKS OR EXTENSIONS OF EXISTING WORKS.

32 Pine St., New York City.

Correspondence solicited.

KERR MURRAY MFG. CO.,

MANUFACTURERS OF

Single Lift and Telescopic

GASHOLDERS.

Built, 1884:

Altoona, Pa.....	Capacity, 160,000 cubic feet.
Pittsburgh, Pa.....	250,000 "
" ".....	220,000 "
Bellaire, Ohio.....	50,000 "
Youngstown, Ohio.....	60,000 "
Canton, ".....	60,000 "
Akron, ".....	80,000 "
Xenia, ".....	10,000 "
Adrian, Mich.....	65,000 "
Ypsilanti, Mich.....	25,000 "
Muskegon, ".....	70,000 "
South Bend, Ind.....	70,000 "
Anderson, ".....	20,000 "
Plainfield, ".....	10,000 "
Springfield, Illinois.....	100,000 "
Evanston, ".....	50,000 "
Freeport, ".....	35,000 "
Elgin, ".....	60,000 "
Sheboygan Wis.....	20,000 "
Key West Fla.....	10,000 "

Plans and estimates furnished for the erection of new and the rebuilding of old works. Address

Kerr Murray Mfg. Co.,
FORT WAYNE, IND.

JAMES R. FLOYD,
(SUCCESSOR TO HERRING & FLOYD)

Oregon Iron Works,
531 to 543 West 20th St., N. Y.
Practical Builders of Gas Works,

MANUFACTURERS OF

ALL KINDS OF CASTINGS
AND
APPARATUS FOR GAS-WORKS.

BENCH CASTINGS
from benches of one to six Retorts each.
WASHERS: MULTITUBULAR AND
AIR CONDENSERS; CONDENSERS;
SCRUBBERS
wet and dry), and
EXHAUSTERS
for relieving Retorts from pressure.
BENDS and BRANCHES
of all sizes and description.

FLOYD'S PATENT
MALLEABLE RETORT LID.

PATENT
SELF-SEALING RETORT LIDS.

FARMER'S
PATENT BYE-PASS DIP-PIPE.

SABBATON'S PATENT
FURNACE DOOR AND FRAME.

BUTLER'S
COKE SCREENING SHOVELS.

GAS GOVERNORS,

and everything connected with well regulated Gas Works at low price, and in complete order.

SELLER'S CEMENT

for stopping leaks in Retorts.
N. B.—STOP VALVES from three to thirty inches—
at very low prices.
Plans, Specifications, and Estimates furnished.

CONTINENTAL WORKS.

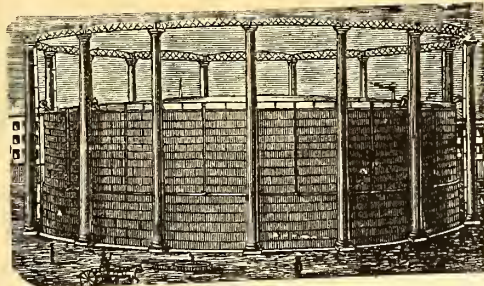

GASHOLDERS OF ANY MAGNITUDE.

T. F. ROWLAND, Proprietor,
GREENPOINT, BROOKLYN, N. Y.

ENGINEER AND MANUFACTURER OF

GAS-HOLDERS.
CONDENSERS, SCRUBBERS, VALVES,
PURIFIERS, RETORTS, and HY-
DRAULIC MAINS,

and all other articles connected with the Manufacture and Distribution of Gas. Plans and Specifications prepared and Proposals given for the necessary Plant for Lighting Cities, Towns, Mansions, and Manufactories.

H. RANSHAW, Prest. & Mangr. WM. STACEY, Vice-Pres. T. H. BIRCH, Asst. Mangr. R. J. TARVIN, Sec. & Treas.

STACEY MFG. CO.,

MANUFACTURERS OF

Single and Telescopic Gasholders,

IRON ROOFS, BRIDGES, LAMP POSTS,

Water and Oil Tanks, Coal Elevator Cars,
COKE CRUSHERS, BENCH CASTINGS,

And all kinds of Wrought and Cast Iron Work used in the erection of Coal and Oil Gas Works.
Rolling Mill Machinery and Heavy Castings a Specialty.

Foundry:
33, 35, 37 & 39 Mill Street.

Wrought Iron Works:
16, 18, 20, 22, 24 & 26 Ramsey Street.

Cincinnati, Ohio.

BARTLETT, HAYWARD & CO.,

Office, 24 Light.

BALTIMORE, MD.

Works, Pratt & Scott.

PURIFIERS.
Roofs.
Bench Castings.

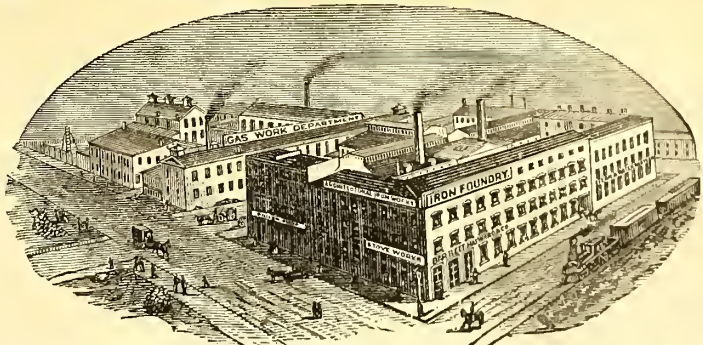

CONDENSERS
BOLLERS.
SCRUBBERS.

GASHOLDERS.

CONSTRUCTING ENGINEERS AND BUILDERS OF GAS WORKS.

1842. **DEILY & FOWLER,** 1885.

Laurel Iron Works.

Address, No. 39 Laurel Street, Philadelphia, Pa.

MANUFACTURERS OF

GASHOLDERS,

Single or Telescopic, with Cast or Wrought Iron Guide Frames.

Holder Built Since 1880:

Mount Joy, Pa.	West Point, N. Y.	Galveston, Texas (2d.)	Kalamazoo, Mich. (3d.)
Rockaway B'ch, N.Y. (2)	Fitchburgh, Mass.	Marlboro, Mass.	Glen Island, N. Y.
Zanesville, O. (2d.)	New London, Conn.	Denver, Col.	Warren, Ohio.
Lancaster, O.	Derby, Conn.	Chicago, Ill. (West Side)	Bath, N. Y.
Blackwell's Island N. Y.	Bridgeport, Conn.	Pittsburgh, Pa. (S. Side)	Lynn, Mass.
Waltham, Mass., (1st.)	Allegheny, Pa. (1st.)	Pawtucket, R. I.	New Bedford, Mass.
Dorchester, Mass.	St. Hyacinth, Can.	Brookline, Mass.	Waterbury, Conn.
Wheeling, West Va.	Norwalk, O.	Sherbrooke, Can.	Deseronto, Can.
Lansing, Mich.	Brattleboro, V	Burlington, N. J. (2d.)	Hoosic Falls, N. Y. (2d)
Flint, Mich.	Waltham, Mas (2d.)	Bridgeton, N. J.	Bethlehem, Pa.
Galveston, Texas (1st.)	West Chester, Pa.	Bay City, Mich.	Atlanta, Ga. (1s.)
Milton, Pa.	Baltimore, Md.	Erie, Pa.	Savannah, Ga.
Scranton, Pa.	Hollidaysburg, Pa.	Jackson, Mich.	Montgomery, Ala
			Newport, R. I.
			Portland, Oregon.
			Allegheny, Pa. (2d.)
			Atlanta, Ga. (2d.)
			N.Y. City (Central Gas Co.)
			Lynchburg, Va. (2d.)
			Saylesville, R. I.
			Rondout, N. Y.
			Atlantic City, N. J.
			Augusta, Ga.
			Waltham, Mass. (2)

GAS COALS.

GAS COALS.

GAS COALS.

JAMES D. PERKINS.

PERKINS & CO.,

F. SEAVERNS.

General Sales Agents for

The Youghioghenny River Coal Company's OCEAN MINE YOUGHIOGHENY GAS COAL.

The Coal from the Ocean Mine (recently operated by Messrs. W. L. Scott & Co., of Erie, Pa.,) is now used by all the leading Gas Companies in the United States from Maine to Texas, and is recognized as *the only reliable Youghioghenny Gas Coal.* (See Map on p. 87 of this Journal, Feb. 16, 1885.)

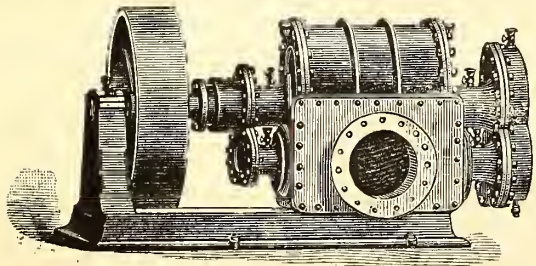
P. O. Box 3695,
New York.**PERKINS & CO., 228 and 229 N. Y. Produce Exchange**BEAVER STREET
ENTRANCE.

Gas Exhauster Driven by Belt.

The Wilbraham Gas Exhauster,

"BAKER SYSTEM,"

WITH ENGINE ATTACHED, ON SAME BED PLATE OR WITHOUT.

Best, Cheapest and Most Durable Exhauster known.

WILBRAHAM BROS.,

No. 2320 Frankford Avenue, Philadelphia, Pa.

F. J. DAVIS & J. R. FARNUM,

TRUSTEES AND AGENTS FOR THE

SINUOUS FRICTION CONDENSER.

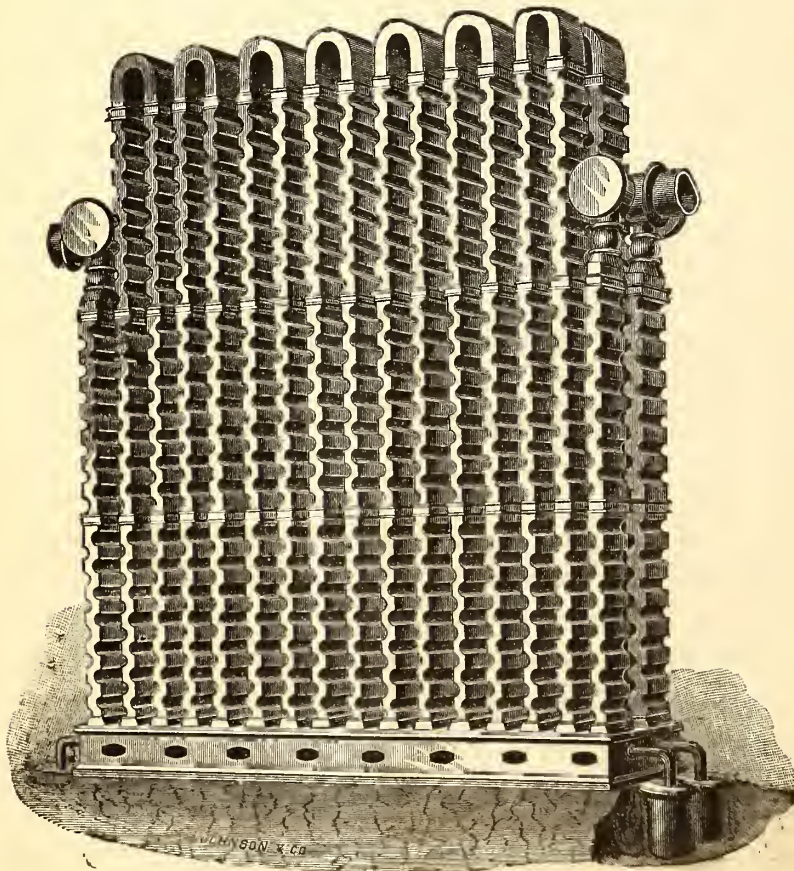

We desire to draw the attention of the gas community to the merits of the **SINUOUS FRICTION CONDENSER.** Companies intending to introduce new condensers into their works will do well to confer with us and examine plans and estimates before contracting for any other pattern. The **FRICTION CONDENSER** is now in use at the gas works located in the following places:

Portland, Me.	Brookline, Mass.	Pawtucket, R. I.	Frederickton, N. B.
Newport, R. I.	Chelsea, Mass.	Jamaica Plain, Mass.	St. John, N. B.
Gloucester, Mass.	Woburn, Mass.	Attleboro, Mass.	Paterson, N. J.
Newton & Water- town, Mass.	Peoria, Ill.	Calais, Me.	Dover, N. H.
	Clinton, Mass.	Fall River, Mass.	Waltham, Mass.
		Nassau Works, Brooklyn, N. Y.	

DAVIS & FARNUM MFG. CO.

MANUFACTURERS OF

Gas and Water Pipes,

AND

GAS AND WATER MACHINERY

OF THE MOST APPROVED PATTERN.

Also, Gasholders and Iron Roofing.

Orders from Gas and Water Companies promptly attended to.

WALTHAM, MASS.

Boston Office, Room 55, Mason Building, 70 Kilby Street.

GAS COALS.

GAS COALS.

GAS COALS.

Newburgh Orrel Coal Co.,

MINERS AND SHIPPERS OF

**Newburgh Orrel, Tyrconnell
and Palatine Gas Coals.**

ALSO SHIPPERS OF FOUNDRY COKE.

Mines Situated at

Newburgh, Flemington & Fairmont, W.Va.

HOME OFFICE,

25 S. Gay St., Baltimore.

CHARLES MACKALL,
MANAGER.

CHAS. W. HAYS, Agent in New York,

Room 92, WASHINGTON BUILDING, No. 1 Broadway.

Shipping wharves at Locust Point. References furnished when required. Special attention given to chartering vessels.

THE DESPARD COAL COMPANY

OFFER THEIR SUPERIOR

DESPARD COAL

To Gas Light Companies and Manufacturers of Fire Clay Goods
Throughout the Country.

ROUSSEL & HICKS, } AGENTS. { BANGS & HORTON,
71 Broadway, N. Y. } 16 Kilby St., Boston.

Mines in Harrison Co., West Va. Wharves, Locust Point, Balt.

Company's Office, 15 German St., Baltimore, Md.

Among the consumers of Despard Coal we name: Manhattan Gas Light Co., N. Y.; Metropolitan Gas Light Co., N. Y.; Jersey City, (N. J.) Gas Light Co.; Washington (D. C.) Gas Light Co.; Portland (Maine) Gas Light Co. Reference to them is requested.

**THE WESTINGHOUSE
ENGINE.**

Chart showing the quarterly
increase of our business.

Heavy lines are Horse

Powers.

Light lines, number of
Engines.

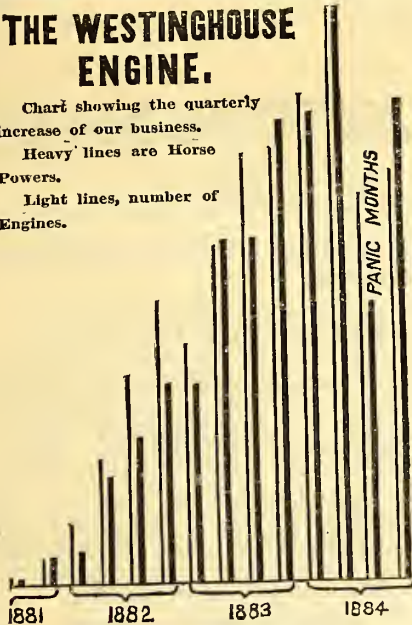

The most successful engine now in the market. No other concern is in a position to give so much engineering attention to its customers. It will pay you to call for bids on your entire plant. Send for Illustrated Circular, and state your Business and Requirements.

**Westinghouse Machine Co.,
PITTSBURGH, PA.**

SALES DEPARTMENT CONDUCTED BY

Westinghouse, Church, Kerr & Co., 17 Cortlandt Street, New York City.

Fairbanks, Morse & Co., Chicago, Cincinnati, Cleveland, Louisville, and St. Paul.

Fairbanks & Co., St. Louis, Indianapolis, and Denver.

Parke & Lacy, San Francisco, and Portland, Or.

Parke, Lacy & Co., Salt Lake City, Utah, and Butte, Montana.

D. A. Tompkins & Co., Charlotte, N. C.

Keating Implement & Machine Co., Dallas, Texas

Robert Middleton, Mobile, Ala.

H. Dudley Coleman, New Orleans, La.

Imray & Co., Sydney and Melbourne, Australia.

R. Rogers, 43 Rue Laite, Paris.

F. E. Averill, Delft, Holland.

Tomas G. Foley & Co., Buenos Ayres, S. A.

**THE
PENN GAS COAL CO.**

OFFER THEIR

Coal, Carefully Screened & Prepared for Gas Purposes.

Their Property is located in the Youghiogheny Coal Basin, near Irwin and Penn Stations on the Pennsylvania Railroad, and on the Youghiogheny River.

Principal Office:

209 SOUTH THIRD STREET, PHILA., PA.

Points of Shipment:

Pennsylvania Railroad Piers; Greenwich Wharves, Delaware River; Pier No. 1 (Lower Side), South Amboy, N. J.

Chesapeake & Ohio Railway Coal Agency,

FOR THE SALE OF THE

**Superior Kanawha Gas Coals, Cannelton Cannel,
Also, SPLINT AND STEAM COALS,**

From the Kanawha and New River Regions, on the line of the Chesapeake & Ohio R'way.

C. B. ORCUTT, Sales Agent. | OFFICE, 150 BROADWAY, N. Y.

FRANCIS H. JACKSON, PRESIDENT.

EDMUND H. MCCULLOUGH, SEC. & TREAS.

THE WESTMORELAND COAL CO.

Chartered 1854.

**Mines situated on the Pennsylvania and the Baltimore
and Ohio Railroads, in Westmoreland County, Penn.**

POINTS OF SHIPMENT:

PHILADELPHIA, BALTIMORE, SOUTH AMBOY, N. J.,
WATKINS (SENECA LAKE), N. Y.

Since the commencement of operations by this Company its well-known Coal has been largely used by the Gas Companies of New England and the Middle States, and its character is established as having no superior in gas-giving qualities, and in freedom from sulphur and other impurities.

Principal Office, 224 South 3d St., Phila., Pa.

A. M. SCOTT, PRESIDENT.

A. DEMPSTER, C.E., SECRETARY.

W. K. GILLESPIE, TREASURER.

MONONGAHELA AND PETERS CREEK GAS COAL CO.,

PRODUCERS OF

Coal Bluff Gas Coal.

MINES LOCATED ON THE MONONGAHELA DIVISION OF THE PENNSYLVANIA RR.,
IN THE CENTRAL PORTION OF THE PITTSBURGH COAL FIELD.

Points of Shipment—Buffalo, Cleveland, Erie, Chicago, New Orleans.

Since the introduction of Coal Bluff Gas Coal it has taken rank among the few first-class Gas Coals, and acknowledges no superior in gas-giving qualities, ease of working, quality of coke, and freedom from impurities.

General Eastern Agents, ANDREW LANGDON & CO., Buffalo, N. Y.

Western Agents, - - - F. R. BUELL & CO., - Milwaukee, Wis.

General Office, 127 Fourth Ave., Pittsburgh, Pa.



INTERNATIONAL--1876--EXHIBITION.

The U. S. Centennial Commission

HAVE DECREED AN AWARD TO

HARRIS, GRIFFIN & CO.,

Twelfth and Brown Streets, Philadelphia, Pa., No. 49 Dey Street, N. Y. City, and No. 75 North Clinton Street, Chicago, Ill.,

FOR THE FOLLOWING REASONS:

The Exhibit consists of a Series of METERS from the Largest Size Station Meters for the use of the MANUFACTURE OF GAS, to those for the use of the ORDINARY CONSUMER. The Instruments are WELL MADE, RELIABLE as to INDICATION, and embody a number of sundry improvements which, with the general character of the Exhibit, entitle the whole to commendation.

Attest—J. L. CAMPBELL,
Secretary, pro-tem.

Signed—A. T. GOSHORN,
Director General

J. R. HAWLEY,
President.

CHARLES E. DICKEY.

JAMES B. SMALLWOOD.

CHARLES H. DICKEY.

Maryland Meter and Manufacturing Co.,**DICKEY, TANSLEY & CO.,**

Established 1866.

Nos. 22 and 24 Saratoga Street, Baltimore, Md.
No. 46 La Salle St., Chicago, Ill.

MANUFACTURERS OF

DRY GAS METERS, STATION METERS, GLAZED METERS, TEST METERS, METER PROVERS, PRESSURE AND VACUUM REGISTERS, GOVERNORS, INDICATORS, SERVICE AND METER COCKS, AND METER CONNECTIONS.

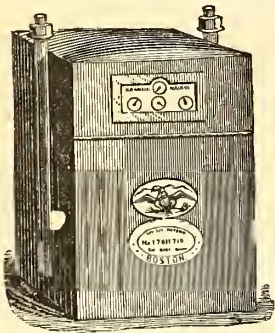

Dry Gas Meter.

With 39 years' experience and the best facilities for manufacturing, is enabled to furnish reliable work and answer orders promptly.

NATHANIEL TUFTS,

No. 153 Franklin Street, Boston, Mass.,

MANUFACTURER OF

DRY GAS METERS.

Station Meters of any Capacity.

Test and Experimental Meters, Pressure Registers, Pressure Gauges,
Pressure and Vacuum Gauges.

METER PROVERS, PHOTOMETERS, STREET LANTERNS, ETC., ETC.

Patent Cluster Lanterns for Street Illumination.

The Bower Gas Lamp.

The Perfected Duplex-Regenerative Gas Burner, under
the combined Patents of Anthony S. Bower,
Geo. S. Grimston, and Thos. Thorp.

The First Gold Medal awarded at the Crystal Palace Exhibition in
London, and two Gold Medals at the Stockport (Eng.) Exhibition of Gas
Appliances. Both in 1883.

GEO. SHEPARD PAGE, JOHN BOWER,
69 Wall Street, N. Y. City.

Parson's Steam Blower,

FOR IMPROVING BAD DRAUGHT IN BOILERS, AND FOR BURNING BREEZE
OR OTHER WASTE MATERIAL.

PARSON'S TAR BURNER,
FOR UTILIZING COAL TAR AS FUEL.

PARSON'S AIR JET TUBE CLEANER,
FOR CLEANING BOILER TUBES.

These devices are all first-class. They will be sent to any responsible party for trial. No sale
unless satisfactory. Manufactured by the WATERTOWN STEAM BLOWER COMPANY.

H. E. PARSON, Supt., 42 PINE ST., N. Y.

JOS. R. THOMAS, C.E.,

May be Consulted on all Mat-
ters Relating to Gas Works
and Gas Manufacture.

ADDRESS THIS OFFICE.

PATENTS.

FRANKLIN H. HOUGH,
Solicitor of American & Foreign Patents,

925 F. ST., WASHINGTON, D. C.

(NEAR U. S. PATENT OFFICE.)

Personal attention given to the preparation and prosecution
of applications for Letters Patent. All business before the U. S.
Patent Office attended to for moderate fees. No Agency in
the United States possesses superior facilities
for obtaining Patents, or for ascertaining the patent-
ability of inventions. Copies of patents furnished for 25 cents
each. Correspondence solicited.

T. C. HOPPER, Pres. G. J. McGOURKEY, Vice-Pres. (New York). WM. N. MILSTED, Gen. Supt. & Treas. (New York). WM. H. DOWN Sec.

AMERICAN METER COMPANY,

WET AND DRY GAS METERS.
STATION METERS.
EXHAUSTER GOVERNORS.
DRY CENTRE VALVES.
GOVERNORS FOR GAS WORKS.

PRESSURE REGISTERS.
PRESSURE & VACUUM REGISTERS.
PRESSURE & VACUUM GAUGES.
CRESSON GAS REGULATORS.
MARSLAND WATER METERS.

METER PROVERS.
PORTABLE TEST METERS.
EXPERIMENTAL METERS.
AMMONIA TEST METERS.
BAR AND JET PHOTOMETERS.

Manufactories:
512 W. 22d St., N. Y.
Arch & 22d Sts., Phila.

GAS STOVES,
SUGG'S "STANDARD" ARGAND BURNERS,
SUGG'S ILLUMINATING POWER METER,
Wet Meters, with Lizar's "Invariable Measuring" Drum.

Agencies:
177 Elm Street, Cincinnati.
244 & 246 N. Wells Street, Chicago.
810 North Second Street, St. Louis.
122 & 124 Sutter St., San Francisco.

HELME & McILHENNY,

(Successors to Harris & Brother. Established 1848.)

GAS METER MANUFACTURERS,

CONTINUE AS HERETOFORE AT THE OLD ESTABLISHMENT,

Nos. 1115 and 1117 Cherry Street, Philadelphia, Pa.,

To Manufacture Wet and Dry Gas Meters, Station Meters, Experimental Meters, Meter Provers, Center Seals, Pressure Registers, GOVERNORS, INDICATORS, PHOTOMETERS, & ALL OTHER KINDS OF APPARATUS FOR USE IN GAS WORKS.

From our long practical experience of the business, and from our personal supervision of all work, we can guarantee all orders to be executed promptly, and in every respect satisfactorily.

WM. WALLACE GOODWIN, Pres. and Treas.

WM. H. MERRICK, V.-Pres.

S. L. JONES, Sec.

S. V. MERRICK, Supt.

THE GOODWIN GAS STOVE AND METER COMPANY,

Successors to W. W. GOODWIN & CO.

1012, 1014 and 1016 Filbert St., Phila., Pa. 142 Chambers St., New York.
76 Dearborn St., Chicago, Ill.

WALDO BROS., Agents, 88 Water St., Boston.

MANUFACTURERS OF THE "SUN DIAL" GAS STOVES, FOR COOKING AND HEATING PURPOSES.

Dry and Wet GAS METERS, Station Meters (Square, Cylindrical or in Staves) Glazed Meters, King's and Sugg's Experimental Meters, Lamp Post Meters, Etc., Etc., Meter Provers (sizes 2, 5 and 10 feet), Pressure Guages of all kinds, Pressure Registers, Pressure and Vacuum Registers, Pressure Indicators (sizes 4 inch, 6 inch and 9 inch), King's Pressure and Vacuum Gauges, Dry and Wet Centre Seals, Dry and Wet Governors, Exhauster Governors, Photometers of all descriptions. Lethby's Sulphur and Ammonia Test Apparatus complete—also Testing and Chemical Apparatus of all kinds, and of the most perfect description, for all purposes relating to Gas.

GOODWIN'S IMPROVED LOWE'S JET PHOTOMETER.

Agents for Bray's Patent Gas Burners and Lanterns.

Special attention to repairs of Meters, and all apparatus connected with the business.
All work guaranteed first class in every particular, and orders filled promptly.

G. B. EDWARDS, Mang'r, New York.
E. H. B. TWINING, Mang'r, Chicago.
A. B. STANNARD, Agent.

D. McDONALD & CO., GAS METER MANUFACTURERS.

(Established 1854.)

51 Lancaster St., Albany, N. Y. 34 & 36 West Monroe St., Chicago, Ill.

STATION METERS, EXPERIMENTAL METERS, METER PROVERS, PRESSURE & VACUUM REGISTERS, PRESSURE GAUGES, ETC.

Also STAR GAS STOVES, RANGES, and HEATING STOVES.

We use only the very best materials, and employ the most skilled labor, and by our long experience (29 years) and personal supervision of every detail, we feel justified in assuring the public that our goods will give perfect satisfaction. Every Meter emanating from our establishment will bear the State Inspector's BADGE, and will be fully warranted by us. Our Annual and Calendar will be sent to Gas Companies upon application.

KING'S TREATISE ON COAL GAS.

The most complete work on Coal Gas ever published. Three vols., bound, \$30.

A. M. CALLENDER & CO., No. 42 Pine Street, New York.

THE GOODWIN GAS STOVE AND METER CO.,

1012-18 Filbert St., Phila., 142 Chambers St., N. Y., 76 Dearborn St., Chicago.

Agents, WALDO BROTHERS, 88 Water Street, Boston.

WM. W. GOODWIN, PRES. & TREAS.
W. H. MERRICK, VICE-PRES.
S. LEWIS JONES, SEC.
SAMUEL V. MERRICK, SUPT.

SOLE MANUFACTURERS OF THE

G. B. EDWARDS, Mang'r, N. Y.
E. H. B. TWINING, Mang'r, Chicago.
A. B. STANNARD, Agent.

"SUN DIAL" GAS STOVES

The Most Economical, Efficient, and Durable Gas Stove Made.

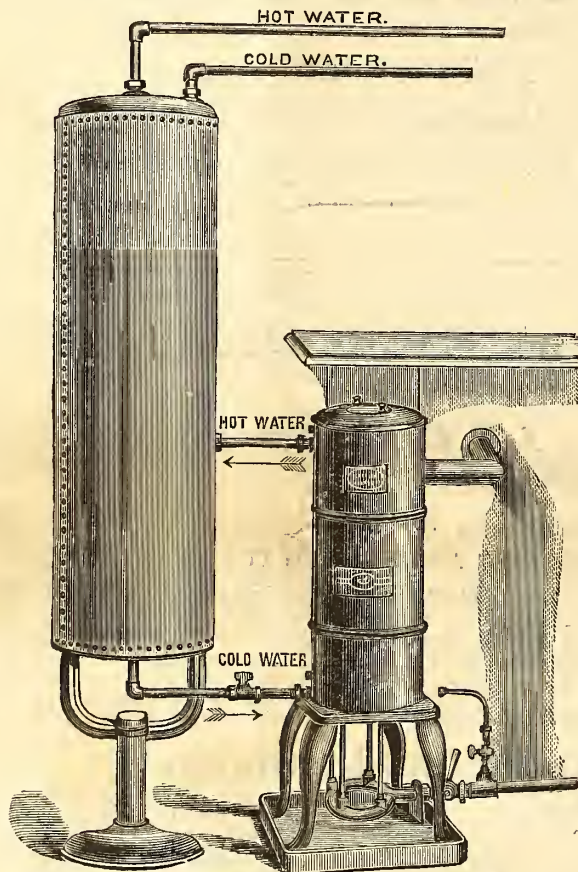

I.—Safety Hot Water Generator and Boiler.

Safety Hot Water Generator and Boiler.

Cut I. represents our Safety Gas Hot Water Generator and Boiler, arranged for home use. This most easy, quick, and economical way of preparing a warm bath, or for heating water for any domestic purpose, entirely supersedes any necessity for the use of ranges or stoves—a great comfort, particularly in hot weather. The boiler being self-filling, as the hot water is drawn off, can never become empty, thus preventing the possibility of any accident.

We beg to call attention to the cast iron pan which is now attached to the legs of the Generator (see illustration). This is to catch the drippings from the coil, which many persons suppose come from a leak, when in fact they are produced by condensation. This condensation is caused by the hot flame coming in contact with the coil filled with cold water.

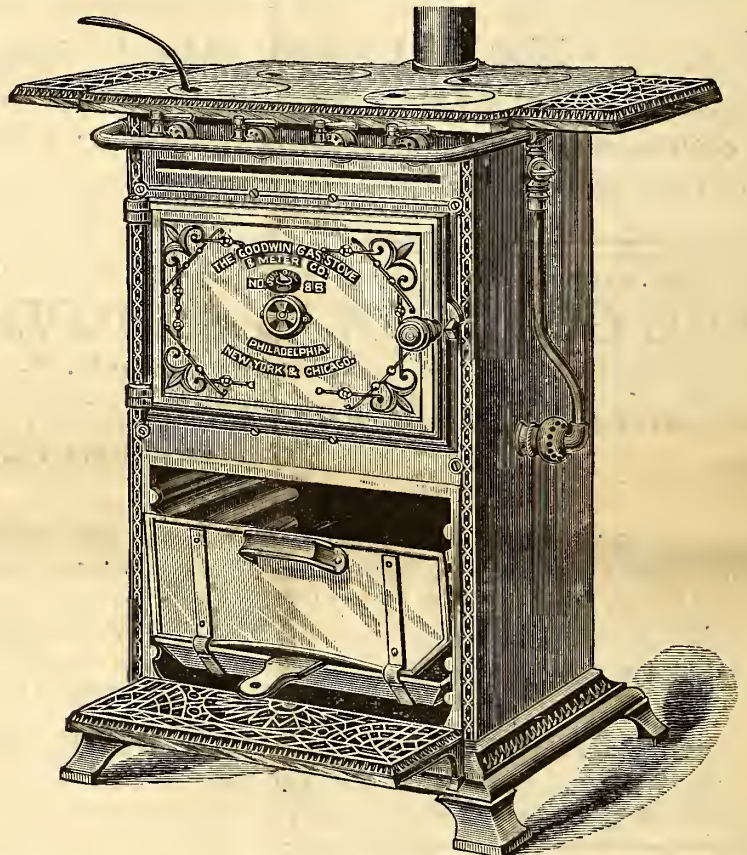

II.—Gas Cooking Stove No. 8 B.

New Style Gas Cooking Stove.

Cut II. represents our New Style Cooking Stove. As will be seen, it has an ornamented cast iron base and front, and extension shelves. The oven burner, which is atmospheric (unless otherwise ordered), is of an entirely new and improved pattern (patent applied for). The ovens are of greater capacity than those of the old style. The top, in conjunction with the outlet pipe, is designed to carry off all products of combustion; hence the outlet pipe must be connected with a flue, or the stove will not work properly.

This Stove has 4 boiling burners in top of hot plate. All fittings are nickel plated. We are making this style of Cooking Stove in the following sizes—viz., No. 7 B, No. 8 B, No. 9 B, and No. 10 B.

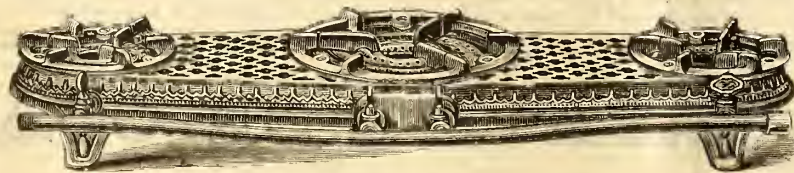

III.—Improved Hot Plate, No. 108.

New Style Hot Plates.

Cut III. represents our New Style of Hot Plates, of which we are making No. 106 (two small boiling burners), No. 107 (two medium sized boiling burners), and No. 109 (two medium and one large boiling burner). See new Catalogue and Price List for further particulars.

THE AMERICAN

GAS LIGHT JOURNAL

PUBLISHING OFFICE No. 42 PINE STREET

DEVOTED TO THE INTERESTS OF ILLUMINATION, VENTILATION, WATER SUPPLY AND DISTRIBUTION, & GENERAL SCIENCE.

VOLUME XLIII.—No. 12.
Whole No. 636.

NEW YORK, WEDNESDAY, DECEMBER 16, 1885.

\$3 PER ANNUM
IN ADVANCE.

A. M. CALLENDER & CO., Proprietors. C. E. SANDERSON, Manager
JOS. R. THOMAS, C. E., Editor.

ENTERED AT THE POST OFFICE AT NEW YORK, N. Y.,
AS SECOND CLASS MATTER.

Published on the 2d and 16th of each month, at No. 42 Pine Street, N. Y.

Terms of Subscription, Including Postage.—For the United States and Canada, \$3 per annum. European countries, \$3.50 (15 shillings—18 francs). All payments to be made in advance. Single copies, 15 cents.

Remittances should be made either by post-office order, registered letter, or bank draft on New York, payable to the order of A. M. Callender & Co.

Collections are invariably made directly from this office, for subscriptions, advertisements, etc. We have agents to solicit the same, but they are not authorized to receipt for money.

Correspondence.—Wishing to make this JOURNAL a gazette of intelligent discussion to those of our readers who may wish to gain or give information on the subjects to which its columns are devoted, correspondence is solicited for publication from all who make the study of those subjects a pleasure or a profession.

The American News Company, Nos. 39 and 41 Chambers street, New York, are agents for this JOURNAL. Newsdealers will send orders to them.

Books.—We will forward by express, at publisher's lowest rates, any book—scientific or otherwise—to any address in the United States or Canada. No books will be sent C. O. D.

CONTENTS.

An Asterisk (*) denotes an illustrated article.

EDITORIALS—

Not in Time.....	309
An Appeal in Behalf of the Hartley Fund.....	309
Some Surprising News from Albany, N. Y.....	309
A Most Important Decision.....	310
Thirteenth Annual Meeting of the American Gas Light Association —Official Report—Continued from page 288.....	310
Joint Discussion on the Somerville-Spice Papers—The Present State of the Gas Interest, by Jno. C. Pratt—Discussion—Second Day, Morning Session— Stoking Machinery, by M. S. Greenough.	
Safe Sea-Carriage of Coals.....	317

ITEMS OF INTEREST FROM VARIOUS LOCALITIES..... 318

A New Gas Company—The Port Chester (N. Y.) Opposition Company—Will They Secure a Foothold?—Trouble over Street Lighting at Pittsburg, Pa.—The Natural Gas Flow was Weak—Retaining the Arc Lights on the Bridges—Cheaper Gas for Columbia, Pa.—Price of Gas Reduced at Grand Rapids, Mich.—Cheaper Gas for Elkhart, Ind.—Proposing to Remove Trustee Clarke—Street Lighting Matters at Hillsboro, Ohio—An Analysis of Natural Gas—Natural Gas Discovery near Washington, D. C.—Killed by the Electric Current—Electric Light for Troy, N. Y.—The National Tube Company Assuming the Role of a Benefactor—And Still the Testimonials Come—An Item or Two from Toronto, Canada—The Death List—Another Addition to It.

CORRESPONDENCE—

Is It a Harmless Anaesthetic?.....	320
Does Mr. Thurber Own Stock in a Burner Company, Then?.....	320
The Market for Gas Securities	321

NOT IN TIME.—We have received from Mr. H. C. Adams an abstract of the official report of tests, made by the Franklin Institute examiners, on the gas lamps exhibited at the late "Novelties" display. Owing to the pressure on our columns we are obliged to defer publication of the article until issue for January 2d. The showing made by the tests will be somewhat of a surprise, even to gas men.

AN APPEAL IN BEHALF OF THE HARTLEY FUND.

Since the first shock caused by the announcement of the sudden passing away of that distinguished member of the English gas fraternity—Mr. F. W. Hartley—has abated, a slight inquiry into condition of business affairs of deceased developed the fact that, contrary to general estimation, he was far from being in an easy financial position when death removed him from the scene of his labors. While this state of affairs would mean but little, under other circumstances, and which here need no explanation, the situation becomes really deplorable when the facts in the case, as it stands, are reported. Mr. Hartley's family, as mentioned by our English Correspondent, in his letter published in our last issue, consists of five daughters and three sons. Of these the two elder boys are in situations the income from which just about enables them to make a bare living; and, in view of their stipends, cannot be relied upon to contribute very largely towards the decent support of the others of their family. The youngest son is still a junior. The two elder girls require some slight amount of capital to properly equip them for the successful carrying on of a business the principles of which had formerly been taught them. The third daughter is a confirmed invalid, while the younger sisters are of too tender an age to expect any other treatment than that accorded to the infantile branches of a family. In view of this lamentable situation, and remembering that Mr. Hartley was in no sense a spendthrift or an improvident man—how could he be either when he so creditably reared such a large family on a mere salary; and, mind you, an English salary, too—we would ask that the American fraternity will endeavor to aid us in an attempt to raise a fair sum of money to be added to the fund (now in process of collection on the other side of the Atlantic) that is to be applied to the purpose of relieving the dead engineer's progeny from possible want. We ask your hearty response to this call, and not alone through charitable motives is the application made, for the deceased, through the medium of his ever ready pen, has placed the entire gas world under obligation to him. Indeed, no one can gainsay the fact that Mr. Hartley's name (and fame as well) is firmly established in the gas circles of America.

Those of our readers who may desire to subscribe to the American section of the Hartley fund can send their remittances to Messrs. A. M. Callender & Co., proprietors of this JOURNAL, and they will forward the same to Mr. W. H. Bennett, Secretary of the British Gas Institute, who has charge of the matter on behalf of your English conferees. A complete list of the donors, in their capacities as individuals or companies, will appear in our columns; and it is presumed that the final treasurer or custodian of the fund will furnish American subscribers with sheets showing the ultimate disposition of the moneys subscribed.

In conclusion, we have but to say that Messrs. A. M. Callender & Co. will contribute the sum of \$25, and earnestly ask that due attention be given to the matters explained above.

SOME SURPRISING NEWS FROM ALBANY, N. Y.

In our "item" column for August 3d mention was made of the fact that articles incorporating a new gas company for Albany, N. Y., were filed with the proper official on date of July 13th. The names of the incorporators were also given, as well as other information concerning the leading features of the scheme. At the time we ventured the prediction that if the newcomers were bent on blackmail, pure and simple, they would likely count

without their host, and based the assertion on the well-known firm financial standing enjoyed by the old Albany Gas Light Company. We must confess, however, that recent subsequent developments have evolved a surprising termination to the Albany affair.

The incorporators of the opposition, or—as it is called—Municipal Company, obtained, on Sept. 15th, after much contention, a franchise from City Councils to pipe the streets, and supply gas. Under its terms the company was to be ready to go on with construction work by first day of 1886, and begin the supplying of gas on or before the first day of 1887. The regular routine of bald lies was proceeded with in the attempt to hoodwink the press, and delude such members of the Council as were really honest into the belief that by favoring the designs of the Benedicts (people in the neighborhood of Tappan have heard of that suggestive Christian name before) the people of Albany were but paving a way to the road of cheap gas. The schemers bound themselves hard and fast by the agreement that they “shall not sell their corporate rights to any other gas company now in existence in this city, or to any gas company, person or persons, in a period of five years from January 1st, 1886.” Matters dragged along for a couple of weeks or so without any particular ripple obtruding itself to mar the easy and sleepy existence so long enjoyed by the old Albany Company, when it suddenly appeared to the minds of the sleepers that a stroke of business in the shape of a haul could be done in one way or another, and “feelers” were accordingly thrown out in the proper direction. The unerring noses of the skilled opposition fry scented the bait, and seine pullers H. M. Benedict, of Brooklyn, and “Tony” Brady, of Albany, made their appearance. It was discovered that while the “Benedicts” of the first part could not sell out to the Albany Company, the combined Benedict representation was at perfect liberty to accept a proposition looking to the purchase of the “stock and good will” of the aforesaid Albany Company. “Barkis was willin’,” and in consequence the matter resolved itself into a mere arrangement of “dollars and cents.” When the directors had secured the consent of a majority of the shares (for we imagine the lesser shareholders had little to say about it one way or another), the details of the “deal” were concluded; and these seem to be as follows: The Municipal Company’s agents agreed to pay the sum of \$500,000 into the Commercial National Bank, on the first day of December, 1885—the deposit to be delivered to a committee representing the stockholders of the old Albany Company—in consideration of which the entire plant of the company, and all of its possessions (excluding surplus) was to be made over to the depositors of the money. The agents further agreed to deposit \$250,000 (as purchase money, at par, of the entire capital stock of the Albany Company) as security that they would, on the first day of June, 1886, complete and pay for the said capital stock, which is to be delivered to them, “all and singular,” on that day. The agents finally agree to purchase the large stock of coke, owned by the Albany Company, and pay for the same at the rate of four cents per bushel. To sum up the amounts that will be received by the holders of Albany Company’s shares when the division is made: The old company is undersold to have a surplus on hand of \$650,000; to which add the \$500,000 bonus for surrender of “good-will,” plant, etc., and the \$250,000 for par redemption of stock, besides amount chargeable to the coke portion of the “deal”—or a grand total of over \$560 per \$100 of stock.

In the meantime the Municipal promoters propose to increase their capitalization from \$700,000 to \$1,000,000; and the Albany idiots (or knaves) who granted the franchise to the schemers can figure out how the Albany gas consumer is to be benefited. Under the old regime that consumer was taxed to enable the Albany Company to pay a dividend return on a capital investment of a quarter of a million dollars; under the new order of things he will be taxed to the extent of paying at least 10 per cent. on a so-called investment of an entire million.

A MOST IMPORTANT DECISION.

Telegraphic advices of date of December 7th convey the announcement that the United States Supreme Court has rendered decision in the case of the Louisville (Ky.) Gas Light Company vs. the Citizens Gas Light Company, of same city; also in the case of the New Orleans (La.) Gas Light Company vs. the Louisiana Light and Heat Producing and Manufacturing Company.

It is matter for regret that the telegraph conveyed so meager an account of the text of the decisions; but it is also matter for congratulation that the highest legal tribunal of the country refuses to see through the glasses favored by the raiders on established gas properties. The Supreme Court holds broadly that gas purveyors, operating under instruments awarding them exclusive control of certain stated districts, for a certain stated term of years, are entitled to protection in such right; and that such instruments in no manner conflict with Constitutional law. We expect to publish, in due season, a complete report of the judgment rendered.

[OFFICIAL REPORT—Continued from page 288.]

Thirteenth Annual Meeting of the American Gas Light Association.

HELD AT COLLEGE HALL, CINCINNATI, OHIO, OCT. 21, 22, 23.

FIRST DAY—AFTERNOON SESSION.—WEDNESDAY, OCT. 21.

Joint Discussion on the Somerville-Spice Papers.

In calling for discussion on the subject submitted by Messrs. Somerville and Spice (see JOURNAL, 2d inst.), President Vanderpool remarked that the members had just listened to two papers which were replete with interesting information. He expressed the hope that the discussion would be exhaustive.

Mr. Harbison—I would like to know whether the liming process is covered by letters patent.

Mr. Spice—It is patented in America.

Mr. Harbison—Would it not be possible to employ a lime material that did not carry so great a weight of water in it? In that event a great saving of fuel might be secured. Mr. Somerville makes a strong point of the increase in the cost of fuel in the carbonization of the coal. To put it in other words—could not dry or air-slaked lime be used, and thus secure the saving in fuel the increased expenditure of which Mr. Somerville found such an important item?

Mr. Spice—As to the inquiry whether we could not use the lime without its containing such a quantity of water, I might say that we should be then using somebody else’s patent instead of our own; and it would also be open to the objection that the men would be smothered by the lime. Mr. Somerville has, in some way or another, misunderstood the exact *modus operandi*. In adding too slight a quantity of water he has, as one result, converted his stokers into millers, and covered his retort house interior with powdered lime. The use of the water is no drawback. We sell more coke than we did before; and instead of increasing our fuel for carbonization we reduced it. Of course, if that quantity of water pure and simple was thrown on the coal, and that wet coal was then put into the retorts, your heats would be materially brought down; but if you mix it with lime no inconvenience of that sort would be experienced.

Mr. Harbison—In that respect Mr. Somerville reports a different result from that detailed by Mr. Spice.

Mr. Spice—I do not know how Mr. Somerville tried his experiment; but my statement of experience is the result of two years’ working.

Mr. Harbison—I am trying to get around the difficulties experienced by Mr. Somerville in his month’s working. I infer from the remarks of Mr. Spice that that gentleman has conquered the difficulties as they were encountered; and as a consequence he does not now have them to contend with. As to Mr. Spice’s remarks about everything being covered over with lime dust, I must say that I do not find, in our lime room (where we are using oyster shell lime), that the men get covered with it as a consequence of handling it dry. Would it be sufficient to take the specified quantity of lime and sprinkle it over the coal; or must it be thoroughly mixed with the rake?

Mr. Spice—We use a charging machine; and a part of that apparatus involves the use of a coal breaker. A man fills a barrow with coal, turns it over into the coal breaker, and then puts a shovelful of lime on top of the coal just as it is going down. That is all he has to do.

Mr. Harbison—Is it necessary to use oxide with the liming process?

Mr. Spice—That is not a hardship, but rather a blessing. It is not a necessity, but that is a part of the story. You use no lime except that which goes into your coke. Instead of the lime being sent away as useless when taken from the purifiers, it goes to market—you sell it with your coke. By reason of the lime addition the weight of your coke is increased 2½ per cent.

Mr. Harbison—If you were to sell the coke by measure there would not be an advantage?

Mr. Spice—There would be no money result gained therefrom, but the quality of the coke would be improved.

Mr. Harbison—In this country, I apprehend, coke is not generally sold by weight. If it were so sold there might perhaps be cause for serious reflection regarding the integrity of the seller. For instance, he might be accused of watering the coke in order to increase its weight.

Mr. Spice—Formerly all coke was sold by measure in England; but now we have an act of Parliament compelling its sale by weight.

Mr. Harbison—What effect has the liming process upon the life of the retort?

Mr. Spice—None whatever. That is the last thing to imagine. The first thing that we found any difficulty about was in the deposit of a dusty material in the flues of the furnace. This dusty deposit merged gradually into a hard substance that tended eventually to choke up the flues. We had to blow them out more frequently than was the case before.

Mr. Harbison—Was the deposit caused by the admixture of too great a quantity of lime with the coal?

Mr. Spice—Not because there was too much, but because of the very presence of the lime there. It presented no difficulty when we understood the nature of the deposit. When my attention was first called to it I said there could be no effect without a cause, and I asked my manager if he had considered the causes. He replied in the negative. I examined the material and divined the cause. I directed him to blow out the flues. In the course of the week he reported what improvement had been made. By the end of the week the heats were as good as ever, and so also were the retorts. This is the simple explanation of the difficulty which had caused the manager to put on a long face when I saw him on the morning that I asked him how he was getting along, and was greeted with the reply, "Not at all." I inquired, "What is the matter? Something new?" He said, "I am losing my heats in spite of all that I can do." He had a sample of the stuff that he had taken out of one of the flues. I told him he was using a new form of coke, or one with lime in it, which tended to form a mass something like cement; and that the deposits were blocks of solid matter which would not have become solid if he had blown out the flues oftener than had been his former custom.

Mr. Harbison—What does Mr. Spice find is the yield per pound? And what is the effect upon the illuminating power of the gas?

Mr. Spice—The illuminating power is not affected in any way. The yield is about 10,200 feet per ton of 2,240 pounds of Newcastle coal—which is considered very good working. We have not found that our annual make has been affected in the slightest degree by the use of this process; but we have found, as a result of critical examination, that there is a loss of illuminating power to the extent of 0.2 of a candle only—a consequence of the admission of air to effect the revivification of the oxide *in situ*. As gas men we would call that nothing to speak of.

Mr. Harbison—I am not sure that I remember the precise statement in his paper as to the cost of slaking the lime and mixing it with the coal.

Mr. Spice—In the absence of apparatus similar to that in use at our works, it has been found to cost one-half penny per ton. It added just so much labor to the coal wheeler. As a practical test, I found that, for the year 1884, instead of having used $2\frac{1}{2}$ per cent. of lime (which is the prescribed quantity), we had used only $2\frac{1}{4}$ per cent. That was as near as a man could work. You must understand that we have not weighed it at all. We found, by practical experience, that a shovelful of lime to a barrow load of coal was the proper mixture.

Mr. Harbison—As Mr. Spice has said, the gas works in this country using mechanical appliances in charging and drawing retorts are quite exceptional. There are only two or three places in America where the work is done in that way. The handling of the lime—slaking it in one building and bringing it into another—has to be done by manual labor. Could he give us an estimate as to what would be the cost under such circumstances?

Mr. Spice—In England we found the labor charge to be about one-half penny per ton. You might put it at one penny if you like. It is nothing serious, though.

Mr. Fullager—Suppose the lime is not sufficiently mixed with the coal; what would be the effect?

Mr. Spice—The lime is always sufficiently mixed with the coal. We put the lime on top of the heap of coal. It is sufficiently damp not to fly about; and there is none of it lost when put on the coal on the floor.

Mr. Harbison—But suppose there were 20,000 pounds of coal on the floor at one time; would the lime then be sufficiently mixed with it?

Mr. Spice—I should not put down so much coal as to have it dry up through all the moisture being expelled. If you do that you will make millers of your men. There is no occasion for that at all.

Mr. Enfield—Has the lime process any effect upon the deposit of carbon in the retorts?

Mr. Spice—None whatever.

Mr. Enfield—Does it cause more or less carbon?

Mr. Spice—It scarcely makes any. We work with very light pressure on the retorts (and with as even a gauge as possible), and are not troubled with carbon in them. In works which were troubled with stopped ascension pipes it was found the coal liming process put an end to that bothersome condition.

Mr. Fullager—What would be the effect if some of the lime were deposited on the tar in hydraulic—the tar being light, and working no seals?

Mr. Spice—We never had any drawn up the ascension pipes. Your idea would have a foundation of practical value if you assume that dry lime were being put into the retort. You must bear in mind that this equal weight of water stops all that. The lime is laid hold of in the retort.

Mr. Fullager—If put on the retort house floor the lime would immediately dry up.

Mr. Spice—Then don't put it there.

Mr. Fullager—You have got to put it there.

Mr. Spice—I assume, as a practical man, that I would put my coals in front of the retort bench.

Mr. Littlehales—I think there is some misapprehension, as to this matter of purification, arising out of the fact that in the large cities of England lime cannot be used on account of the offensive smell. In fact at one time its use was practically prohibited until it was found that the sulphur compounds could not be eliminated except by the aid of sulphide of calcium. The oxide is one of the cheapest and least offensive of purifying materials. America is a "great, glorious and free country," where everybody can do as he likes; and so nobody has any trouble over the use of lime. That fact makes a great deal of difference in our understanding of this question.

Mr. Helme—I would like to ask Mr. Somerville if he used oxide of iron alone?

Mr. Somerville—No; I used part oxide and part lime.

Mr. McMillin—The question of Mr. Eufield is of no little importance. Mr. Spice says that, practically, he had no carbon in the retorts. Perhaps he did not have any before; but it strikes me that the new scheme would have a tendency to prevent the deposition of carbon; and our experience at Columbus, Ohio, leads me to that conclusion. We there use the native coal, which contains 12 or 15 per cent. of water. I mean, of course, we use that as part of our charge mixture, and when we use it our retorts never suffer from carbon deposit. Now, if the water contained in the native coal prevents the deposition of carbon, and even goes so far as to remove it, it strikes me that the water in the lime would have the same effect. I think that not only experience, but also reason, teaches the same thing. The decomposition of water vapor there in contact with the hot surface would have a tendency to take off the carbon.

Mr. Harbison—Do you not find that the water in that coal impoverishes your gas? Is that the way you make water gas?

Mr. McMillin—No. If we could only keep it there it probably would benefit us; but the water usually drops at the hydraulic main—at any rate, it does not get any further than the "standard" scrubber.

Mr. Lausden—I want to understand the cause of this difference between Mr. Somerville and Mr. Spice. Does not Mr. Spice use the coal in a much finer or pulverized condition; or can we in this country, with our lump coal, use it in the same way that he would use the Newcastle coal? Would not our coal have to be crushed?

Mr. Spice—No; your lump coal would do very well. The largest lumps of coal would need to be broken up; and perhaps the smaller the coal is the better would be the result. Still, it is a question of degree—affecting not the grand results, but the exact results of the sulphur compounds. You would not have them so much reduced if you only whitewashed your lumps of coal and put those whitewashed lumps into the retorts. It is a question only of degree. It is only a question of reducing the sulphur compounds with greater or less efficiency.

Mr. Harbison—Would the same result be obtained if the lime was not mixed with the coal in the retort house?

Mr. Spice—I would prefer to mix it. You would spoil your coke by having great blotches of lime on it. The lime should be evenly distributed. The consumers might object to a large patch of lime on the coke.

Mr. Harbison—If the lime were put in after the retort is charged would it not mix thoroughly with the coal?

Mr. Spice—It would not mix sufficiently there. It should be mixed before the charge goes into the retort. I should prefer to have the lime exposed to the heat of the retort house till the water is driven off.

Mr. Harbison—I would like to have Mr. Somerville tell us (a little further than his paper does) what his personal impressions are with regard to this matter; or as to what causes the difference in the results obtained by him and those obtained by Mr. Spice.

Mr. Somerville—I would like to state it was with great regret, and in fact with some mortification, that I failed in this thing. When I started in I did so in good faith; and in the hope that the sulphur compounds could be decreased, and the amount of ammonia be increased, to the extent that Mr. Spice has said. It was an important thing to me. I was turning the ammonia into sulphur, and I did my very best to make the experiment a success. I broke the coal up very fine; in fact I used what is called slack coal for the purpose of thoroughly mixing the lime with it; for I understood that a great deal of the success of the experiment depended upon this thorough intermixture. I have stated the results. I will state where I think that Mr. Spice gets his extra ammonia—for it was the extra ammonia that I was driving at. The water that goes in with the lime helps, to some extent, no doubt, and the nitrogen of the air which he draws in also helps to make ammonia. I think there can be no doubt about that. Then, as to the purification. Of course, the lime going in with the coal purifies, to a certain extent, the crude gas. There can be no doubt about that either. Then, with the most elaborate and thorough scrubber purification which they practice in England—thus taking out a large percentage of the carbonate of soda and of sulphuretted hydrogen—there is very little work left for the ox-

ide of iron to do. This molecule of one per cent. effects, just as Mr. Spice states, actual purification in the closed vessel. The oxide of iron is actually revivifying, it seems to me, by this method: First, the water gives nitrogenous compounds; next the entering air affords still more; and then the scrubbing, taking out a large proportion of the impurities, leaves very little for the oxide of iron to do.

Mr. Wood—Would not Mr. Spice (in using the fine Newcastle coal) so reduce his yield as to lose in value of gas product that gain which he secures in purification?

Mr. Spice—It is simply a question of degree; and this enables me to use a greater proportion of cheap coals. Do you get much less gas from slacked coals?

Mr. Wood—Very much less.

Mr. Spice—We do not want the coal to be in the form of slack or dust; but we do not care overmuch about its being small.

On motion votes of thanks were tendered to Messrs. Somerville and Spice.

The next paper read was that contributed by Mr. John C. Pratt, of Jamaica Plain, Mass., on the subject of

THE PRESENT STATE OF THE GAS INTEREST.

The author read as follows:

Three years ago I had the honor to read before this Association a paper giving my views on the "Future of the Gas Interest." As some of you may remember, I prefaced that paper with an apology for presenting and advocating a policy, that had not been recognized by the gas interest of the country, which very likely would not receive your cordial assent and approval, as proved to be the case.

Still the discussion that ensued, and the criticisms that were offered, though keen and incisive, were in the kind, gentlemanly and courteous spirit ever characteristic of the discussions of this Association.

It is not the object of this paper to vindicate the views I then presented (except so far as events have proved their correctness), but to show, as briefly as I can, the real advance made in what I conceive to be a sound and healthy sentiment and policy by the gas interest in this country.

As a reminder of some of the points I endeavored to enforce, permit me to read a few extracts from the paper referred to.

"Until within the past few years the gas company has not only enjoyed a monopoly, but a comparatively quiet and undisturbed monopoly, of the business of furnishing illumination; we have always had the chronic grumbler, who disputes his bill, and denounces the meter as a fraud and the managers as swindlers. These, as long as human nature remains as it is, we shall always have; but the public are waking up to this subject, and discussing it; the newspapers join in the hue and cry, and are ready to do all they can, by favoring any and every practicable and impracticable scheme, to break down this 'huge monopoly.'

"It is hardly necessary to state all the reasons that are given for this opposition; the whole may be summed up in one sentence, and that is: 'Gas companies are making more money out of the public than they have a right to make.' In proof of this they call attention to the fact that we furnish no reports—that we do not let the public know what we are doing; and the assumption is that we are afraid to do so. I will neither admit nor deny the truth of this last statement; but I fear that if certain companies were compelled to reveal their corporate secrets—to show how much money they were making, and how large a surplus they have accumulated—they would arouse a feeling in the communities where they exist in comparison with which the granger contest with Western railroads would sink into insignificance.

"Admit, if you please—which nobody will deny—that we have the right, under our charters, to keep from the public all information as to our business and profits, is it wise to do so? I claim that it is not. I claim that our business should be so conducted that we should be willing and glad to lay all its details before the public. There is no other manufacturing interest where the relations of the company and the people are so close, and should be so intimate and confidential.

"We are brought into daily, I may almost say hourly, contact with the people; we make their homes cheerful by the light we furnish; for one-fourth at least of the twenty-four hours they are visibly reminded of our existence, and how indispensable we are to their comfort and happiness. These relations create mutual obligations; and for these reasons, and those I have before given—viz., the rights and privileges they have conferred upon us—they have the right to know that the price they are paying us for gas is neither exorbitant nor unreasonable.

"There can be no doubt that this ignorance of our affairs, which are profound mysteries to the public, together with the fact, which cannot be concealed, that many of our stocks sell at a very high premium, is the prime cause of the discontent and fault-finding that are so prevalent and almost universal.

"The people think that the sale of a commodity which enters almost as largely into family use as water and food should not so enrich its manufacturers; and, whether right or wrong in their opinion, sooner or later they will find a way to ascertain the truth, and remove what they believe to be a great injustice.

"I believe the sooner we place ourselves in close and intimate relations with our customers—have no secrets to be kept from them, are able and willing to show them our whole hands—the better it will be for our future prosperity.

"If, then, gentlemen, you agree with me in this statement of my views, have the courage of your convictions, and tell your stockholders what you think there is in the future; what the dangers are, and how they may be

averted, and leave the responsibility with them; tell them it is much easier to keep the field than to drive the enemy out when he has gained a foothold. Give them the facts, all the facts; they may be unpalatable, but are none the less facts; and, however unpalatable or disagreeable they may be, will have to be met."

Finally, I said:

"If, on the contrary, as is very likely to be the case, you think my views radical, visionary, and unsound; if you think me a foolish alarmist, presenting bugbears to be laughed at and scouted—then all I have to say is, let this paper, if it is printed with your minutes, be read five years hence, and see who is the prophet."

At the next meeting of the Association, held in the city of New York, in October, 1884, we listened to the able and instructive address of the President, Mr. Forstall, in which, besides giving many other valuable ideas and suggestions, at much greater length, and with far more ability, than I had done, he enforced and advocated the views I had presented. That address of Mr. Forstall's has become a part of what we may call the standard gas literature of the day, and has been cited as authority at hearings before Legislative and City Committees. I read, in a late number of the *North American Review*, liberal extracts from it in an able article on the gas question. I need not say that I was proud of such an endorsement.

It should also be said that the AMERICAN GAS LIGHT JOURNAL has ably advocated similar views.

Now I come before you again, not by any means claiming superior knowledge or extraordinary foresight; but, in all modesty, to say that what I thought possible, from a careful review of the situation, might develop in five years, has been realized, in some parts of the country certainly, in less than half that period.

I propose, briefly, to review some of the events of the past two or three years; to look at the present situation, and suggest such a policy as, in my poor judgment, it is wise for us to pursue to meet and defeat the common adversary who now menaces us with a bold front—for it must be obvious to every one who watches the course of events, and observes what is going on in almost every part of the land, that there never was a time when the gas interest was in as great peril as it is to-day.

Our present duty is to devise and apply the proper means to defeat this enemy; and I firmly believe that we can accomplish it—and that without resorting to the use of anything more expensive or difficult than plain, practical common sense.

In Massachusetts we have had within the past two years a high carnival of new gas companies. In the legislative session of 1884 an attempt was made, by parties from Philadelphia, Pa., working in the interest of the Standard Oil Company, to secure the repeal of a law which provides that no illuminating gas shall be distributed that contains more than 10 per cent. of carbonic oxide; this, after a hard-fought battle, we defeated. The legislature, at its next session, again refused to repeal or modify the law.

With such a law on our statute books it would seem as if water gas was barred out of our State; but some of these parties think they see a way by which the law can be rendered nugatory (they claim that they can eliminate the poisonous element); and so the past year we have had three water gas companies trying to gain a foothold in Boston and vicinity.

One—an offshoot of the United Gas Improvement Company of Philadelphia—modestly claiming it as their intention to control, by purchase or lease, the whole gas interest of the State, and to have awarded them out of the capital stock the trifling sum of three million dollars for their water gas patents. They have purchased most of the stock of the South Boston Company—about \$400,000—at a premium of ten per cent., and have probably reached the end of their negotiations. Two other companies have organized under our general law, which permits of such organization with a capital not exceeding \$500,000.

One of these companies made application to the legislature for leave to increase its capital to five millions—which application was refused; the people began to see the cloven foot. It is now endeavoring to raise the requisite capital through the agency of a collateral company organized under the laws of Pennsylvania, but thus far it has met with poor success. The stock is difficult to dispose of—the principal party being the same person who built the new works in Chicago, which have gone into the hands of a receiver. The third company is practically doing nothing at present.

Amidst this confusion and excitement the gas companies have settled down quietly in the belief that they have no cause for anxiety. We still survive, and are likely to live and prosper. To be sure, like a certain wise man who, after the horse was stolen, closed and fastened the stable door, we permitted one of these companies—the second referred to—to obtain leave of the city government, by the customary methods, to lay their mains through our streets, and then secured the passage of a bill taking from the city government the power to grant such a privilege without the approval of a Commission appointed by the Governor. However, no harm has yet ensued; nor have we any fear that serious trouble will come upon us in consequence. The city of Boston is not an inviting field for opposition gas companies; the

price of gas is too low to offer an inducement for capital to invest in competition. And it is surprising to see how the people and the press are waking up to a realization of the fact that, while one company, distributing a thousand million feet of gas, with a plant costing five million dollars, and capitalized at half that sum, can sell gas at \$1.50 per thousand cubic feet, two companies, with the plant, mains, taxes, salaries, and the thousand other expenses duplicated, and the capital of the new company doubled by watering, cannot divide that business, distributing the same thousand million feet of gas at as low a price.

The people in our community are just waking up to a knowledge of the fact that the effect of competing gas companies, as Mr. Forstall so truly and tersely put it, is "to make cheap gas practically impossible."

And now, where do we stand? The wheels of time move rapidly; but hardly more so than has the change of position with gas companies in the State of Massachusetts in their relation to the people. Circumstances have led them to the conclusion that it is best to be more open in their dealings with the people; that if the people are let into the secrets of their business, are permitted to know something of their profits, and whether or not they are being charged a fair price for gas, a friendlier and better state of feeling will exist, and much of the hostility toward gas companies will disappear.

Three years ago such a policy had few advocates among them; the methods, business, and profits of gas companies were secrets which the people were not permitted to know of or investigate. Unlike railroad and other corporations deriving their existence and support from the people, the people were kept in utter ignorance of gas matters; and this was deemed a wise and prudent policy. Note the change.

Last winter every company in the State joined in a movement to secure the passage of a law providing for a commission, to be appointed by the Governor, to whom shall be made annually a full statement of the business of every gas company; and that commission is to give full information to the public of the condition, business, and profits of every gas company through the publication of their accounts.

The members of that commission have power to establish the quality of gas sold; practically, they have the power to fix the price at which gas shall be sold. If, upon an examination of the profits of a company, they shall decide that they are unreasonably large, or if, upon complaints made by the consumers, and after the consumers and company shall be heard, they shall decide that a reduction in price is right and proper, that decision would not fail to be regarded by the company; it would not be wise or safe for it to do otherwise. At the same time they are empowered to give ample protection to the gas companies, as no competing company can establish itself in any city or town until that commission is satisfied that the existing company is unfaithful to the public, and that there is a necessity for another company. We are satisfied that a board of honest, impartial men, appointed by the Governor, will give us all the protection we require. And this commission, with these powers, the gas companies, not the people, have asked for and obtained. It cannot be denied that a new era has opened upon the gas interest.

The question more important than all others for us to consider to-day is—How is the gas interest of this country to be protected?

I answer: *First*—By selling our commodity at the lowest possible price consistent with fair and reasonable dividends. Most of us have already reached this conclusion; and the sooner we all establish ourselves there the better will it be for our safety. Mark what I say—*fair* and *reasonable* dividends; and those on a capital predicated upon an amount not in excess of the actual cost of plant. The people will not quietly consent to pay, in their gas bills, unreasonably large dividends; nor will they pay on watered stock.

Second—By giving the people absolute knowledge that we are doing this, by convincing them that we are dealing fairly by them. It is largely our own fault that the people have become jealous and hostile. It is really not that we have wronged or defrauded them; but they have been led to believe it is so, because we have not been open-handed with them. It is this which has poisoned the public mind—filled it with erroneous ideas—and led it to hail the advent of a new gas company as a deliverance from the oppression of a tyrannical monopoly, and the harbinger of cheap gas. "Cheaper gas!" That was the cry of the people in Boston who had a 20-candle gas furnished them at \$1.50 per thousand feet; and almost every merchant, banker and housekeeper signed a petition for the new company, and promised it their patronage.

That was the case in Boston two years ago; it is not so to-day. If we have changed our methods in dealing with the people, I am glad to say they have been quick to discover it; and I venture the assertion that few signers to a petition in aid of a new gas company could be obtained from intelligent citizens to-day.

Third—Educate the people in these matters.

There are many things in the gas question in regard to which the people require information, and such information as we are best able to impart.

There are two instrumentalities generally made use of by these men who have for the past few years been raiding upon the gas interest of the country, and upon these they mainly rely.

One is to satisfy the people and enlist their support by the promise of cheap gas; and the other, by the use of money, to secure votes in the city councils to carry their schemes.

Our business is to set the people right in this matter, and create a public sentiment so strong and powerful that aldermen will not dare to sell their votes to help a scheme which they know their constituents will condemn. For to depend upon it, there is such a thing as pressure of public opinion being brought to bear upon corrupt city governments, with effect, if that pressure be persistent and strong.

Show the people, then, that competing gas companies are inimical to their true interests; that, as a rule, they are swindling, stock-jobbing concerns, and have proved so in almost every place where they have gained a foothold; show them that water gas, as a cheaper and better gas than coal gas, is the veriest humbug that was ever foisted upon the public; that its claim for greater cheapness is a delusion and a fraud; and that if its claims were well founded we should be the first to avail of, and adopt, its use.

Tell them what coal gas costs to manufacture and place in the holder; be not close-mouthed about this. We have been afraid to meet this question, and it is a great mistake we have made—entire frankness is much the best policy. Tell them the simple facts, and demonstrate to them, as you easily can, at the best that is claimed for water gas, the difference in cost per thousand feet is but a few cents—so small, so insignificant, that the consumer never will see it in his bill. That the principal cost of gas is its distribution, which charge is the same with the one as the other, and with a general change of manufacture from coal to water, the price of naphtha would so advance as to turn the scale of cost in favor of coal. Convince them of these things, and no unscrupulous man will have the effrontery to assert, as one of them did before the Boston Board of Aldermen, that he could make and distribute water gas of 25-candle power at a cost of fifty cents per thousand feet.

Show them that behind these new companies is the unseen, hidden hand of the Standard Oil Company—a corporation more powerful than any other in the land—with its untold millions of capital riding roughshod over every interest that stands in its way; a corporation that controls the largest and wealthiest railroads in the land, and compels them to bow to their mandates; a power that controls legislatures and governors, that elects senators, and whose money fills whatever offices it deems necessary for the success of its schemes; a power greater than any other in deciding who shall be the candidates for the highest offices in the gift of the people; a power that breaks and ruins where it cannot buy, that crushes where it cannot control.

Convince the people, by figures and facts—as you easily can—that it is for the interest of gas companies to deal honestly with them; that no company can afford to secure the ill-will and hostility of its customers by dishonest practices; that our business, if conducted fairly and honestly, yields a fair and reasonable profit; that there is no other business where honest, square dealing pays so well as the gas business; that our prosperity depends more than anything else upon maintaining the best and friendliest relations with our customers; and in this, if there were no principle involved, we have the strongest incentive for fair and honorable dealing with them.

Turn on the full blaze of your intelligence; let the people see—yes, compel them to see—with your eyes, all the facts in the case, and they will be your friends. Educate the people up to a full knowledge of all that is involved in this subject, and I hesitate not to say that every honestly managed company will have a sure and permanent tenure of the field it occupies, without interference or interruption.

To produce this intelligent public sentiment, I look upon the appointment of a gas commission, such as we have now established in Massachusetts, as one of the very best agencies. Such a commission affords protection to the people and to the companies. The people obtain a knowledge of the business and profits of gas companies which they can rely upon—coming as it does through a board of impartial men whose duty it is to carefully investigate their accounts; and they will be satisfied that their profits are not in excess of a fair return on the capital invested. Satisfied on that point, hostility on their part will come to an end.

On all questions that may arise between the people and the companies, on all complaints that may be made by consumers, this commission of able and discreet men will act as a board of arbitration, to hear and investigate all such questions and complaints; and their decision will be final, and should be satisfactory to both parties.

If the gas companies behave honorably and fairly toward the people, they can feel certain that their property will not be depreciated in value, or their business ruined by foreign speculators. On every principle of justice and equity the people, and the capital that is invested in the gas interest, have a right to the protection which such a commission affords.

Now let us hear the conclusion of the whole matter—and I give it to you

as my closing benediction: "Be true to the people, and the people will be true to you."

On motion of Mr. Greenough, the thanks of the Association were tendered to Mr. Pratt for his able and interesting paper.

Discussion.

Mr. Greenough—Mr. Pratt alludes in his paper to the duties of the Massachusetts gas commission, but I am not sure I understood him aright. Perhaps he will be good enough to state again what, in his opinion, are the duties of the commission.

Mr. Pratt—It has power to hear the complaints of people, like that possessed by the railroad commission. It can investigate the question for the purpose of determining whether the gas companies are making too much money (as shown by the matter of dividends declared), and whether the price should be reduced in order to bring the receipts within a reasonable dividend limit. Then, when the investigation is completed, it has power to recommend such reduction in price; and, as in the case of the recommendations of the railroad commission, such suggestions would undoubtedly be acted upon.

Mr. Helme—Mr. Pratt says that if we are true to the public the public will be true to us. I take it the public has really very little to do with these opposition gas companies. The schemers at the head of opposition movements care not how much money they spend—as long as it is not their own; and many of them, in fact, have very little of their own to spend. They generally get their "rights" by operating on the city council; and the "rights" are secured in such a manner that you cannot fasten their corrupt practices upon them. How do they operate? They obtain the privilege of building a gas works in a certain city, the next step being to secure promises from the gas consumers to take gas from them at a lower price than the already existing company is furnishing it at. With these two items secured they go off to another city (they do not stay in your city to raise the money), and interview old men and women, also trustees who have no responsibility. They show the "investors" a most beautifully printed bond—one of the handsomest possible specimens of the engraver's art—and grow eloquent over their description of what "a splendid thing" they have got hold of if they can only get the money. They tell them "these beautiful bonds" will pay their holders 6 or 7 per cent. interest, will run for 30 years, and are secured by the works that are about to be built. A good deal of money has been secured in that way. I know some of the men who have contributed, and can "speak by the letter." The bond sellers are good talkers; and, besides, they have the success of the gas business generally to help them out in their arguments. Certainly gas companies, as a general rule, have been successful; and if some of us had not asked rather high profits in the beginning we would now have been driven out. I admit that, and am not ashamed of it. If I had not done so I would have been driven out in less than twelve months. With the profits made by us years ago we are now fighting our present battle. Well, after the bonds have been shown, and the people are told about the glorious prospects of the embryo company, the "financier" says, "I will give you one of these \$1,000 bonds for \$1,000 in money; and I will also give you \$1,000 worth of stock for \$100 in money. In other words, you shall have \$1,000 in bonds and \$1,000 in stock for \$1,100." Hundreds of thousands of dollars have been obtained in that way in Philadelphia alone, and I know many of the men who have so contributed. One man, living on Front street, Philadelphia, who had for years been a large stockholder in the old Chicago Gas Company, was actually led to believe that he was contributing toward the aid of that company when he paid down \$25,000 cash for stock and bonds in the opposition works. When a certain sum of money is "gathered in," they get up a construction company to build the works, and the plant comes into existence. The pipes are laid in the streets, the lamps are put up—and there they are in your way. What can you do but fight them? The people are not true to us in such cases, because, in many instances, they sustain these operations even though they know that the "right" was obtained in an improper manner from the councilmen, or that it was secured as a result of misrepresentation. Where does the support of the public come to the gas company in such a case as that? I confess I do not see it.

Mr. Littlehales—With all deference to the last speaker, I must say I entirely disagree with him. Investors are about the same as other sorts of humanity. The happenings cited by Mr. Helme may occur once or twice; but when (after one or two instances) the people find no return is made on such "investments" they will cease to "invest." It is natural that the gas consumers of different localities, on finding that opposition does (temporarily at least) reduce the price of gas—and often it causes permanent reduction—should encourage opposition movements. Indeed I could cite many instances where a doubling and even trebling of the capital was followed by a permanent reduction in selling rates. Now, if the original company had kept its rates within reasonable limits the necessity of ever assuming a "fighting" position, as mentioned by Mr. Helme, would be extremely problematical. The seeming paradox involved, in the case of increased capital

and reduced rates, is explained on the ground that the original company had taken too much from the public. I think the public, in nearly all cases, will remain fairly true to the pioneer company. I have never yet heard a gas consumer complain or object to a company taking a fair and reasonable dividend. What is objected to—and, in my judgment, the objection appears reasonable—is that during times of business depression, or when many of your consumers are striving hard to "make ends meet," and with but poor success, the price that rated during the prosperous period is still exacted. There is where "the rub comes in." The nearer you bring the gas business down to the practical basis of paying dividends only on a legitimate capital—and sell your gas at such price as will enable you to do but that—then the trouble resulting from opposition gas companies will end.

Mr. Pratt—I fear many of us will be buried before that time comes about.

Mr. Thomas—Mr. Pratt speaks about educating the public up to think favorably of gas companies. I fear that would prove an uphill task. If we had more of the "Sam Jones" order of men, with a more copious supply of other educators thrown in, we would still find that sort of educational process very hard work. The best way to protect the gas consuming interests is in the appointment of State Commissions, moulded on the plan of the railroad commissions. That is the proper policy. These bodies could regulate selling prices in such manner as to make the rates equitable to producer and buyer. In regard to opposition gas companies, the parties who organize them are merely interested in the business for the sake of making large dividends for the "promoters." For instance—the managers of the New York Equitable Company, whose arms, octopus-like, are spreading out over this country, are now selling stock and bonds with the object of establishing an opposition company in Chicago, Ills. These bonds are quoted at from 85 to 95, and the stock is quoted at 40. The managers of the scheme intend to make their profit out of the preliminary financial transactions. What do they care about the price that will in future be charged for gas? When the former opposition Chicago (the Consumers) company was organized the promoters capitalized it at \$5,000,000. They erected a works which they claimed cost \$1,200,000; but I think they would have made a very large dividend if they received \$600,000 for building that plant. The low price charged by the old Chicago Company for its gas has proved a stumbling block—not to the original promoters of the opposition movement, but to the fools upon whom they unloaded. The "investors" are the ones who suffered—and are suffering. A New York man whom I heard speaking on this matter of the Consumers Company, said he intended to put \$10,000 in it. I told him I thought he would be foolish to make such an investment. He replied, "Well, I want to have a little fun. I have plenty of money. I have made a good deal of money out of some of the others; and should I lose that \$10,000 I will not care." There are plenty of such people in existence. Numbers of them are ever ready to invest in such schemes; and these are the parties who do the most mischief. The sensible plan of doing away with opposition schemes is to form State organizations. Frame proper bills, and have them enacted into laws by your Legislatures. Have Commissions created, and clothe them with proper powers. With such bodies in existence the "true inwardness" of the motives impelling opposition schemes could be shown up, and even custodians of trust funds might have their eyes opened. As it is now all that is required in most cities to give the schemers a foothold seems to be the "seeing" of a certain clique of officeholders with the planking down of a certain sum of money. Making an impression upon them in any other way would require the discovery of a new power. If you want to fight opposition successfully commence in the right way. Get your commission; let it regulate the matter of new gas companies; let it regulate the price of gas; in short, let it attend to the carrying on of the business in a business-like manner. Of course, gas companies ought to (and a number of them do) sell gas as cheaply as they can. Some companies heretofore have rather crowded their consumers, through charging excessively high rates; but if the companies will reduce the price so as to pay only fair and reasonable dividends, they will place themselves in proper position to drive this competition (or rather opposition) out.

Mr. Harbison—I heartily agree with the sentiment of the paper when it says, "If you treat the public well they will treat you well:" and I speak from experience. I do not concede brother Helme has a right to glory (if he calls it by that name) in the fact that he now has a fund on hand to fight opposition with, and simply because he has amassed it years ago from his consumers as a result of charging too high a price for gas. I believe, in heart, that is the reason why he is now in trouble.

Mr. Helme—You need not distress yourself much about it.

Mr. Harbison—I will not distress myself at all except for your sake. I have before, in other places, and also before this Association, advocated dealing fairly by the public, in the belief that if you do so the public will deal fairly by you. I do not, in behalf of the company I represent, fear opposition from any outside influence, or monied associations of men, in the establishment of opposition gas works in our city of Hartford, Conn. There is no field for them there, and they realize it. They have been there, have

looked us over, but got no sympathy from any division of our entire population. They have freely acknowledged this to me. I say that much in justification of the gas policy pursued for over a third of a century in Hartford. It has been the constant aim of our company to furnish an excellent illuminating gas, at the lowest possible price, and pay a fair dividend to the stockholders—never beyond 11 per cent; and for the last six or eight years only 8 per cent. The company has never had a dollar of watered capital, no bonds out, and never had any since the first notes were given for the building of the works, the same notes being redeemed at the rate of one hundred cents on the dollar. I have no sympathy with the stockholders of a company suffering from an opposition contest, who, at an earlier period in their history, voted in as directors men who afterwards added largely to the capital stock, and received large dividends on that watered capital stock, or shares not represented by money paid in and actually invested in the works. I have no sympathy to waste on them. I do not think they are entitled to any in this age. I agree fully with what Mr. Littlehales said—that gas companies have rights, and that the consumers also have rights which gas companies ought to recognize; also, that when times are hard the gas company should not grind the last dollar out of people who are laboring hard to make both ends meet. Of course, stockholders are entitled to an equitable return on their honest investment, and managers of companies would not be justified in furnishing gas at a less rate than would enable them to return a fair dividend to the stockholders, some of whom are depending upon their investment in gas stocks for a living. I do not believe that a gas commission is the great panacea for our ills. We have a railroad commission in Connecticut, but that fact does not prevent outside marauders from appearing before our Legislature every year (for the past twenty years) in the endeavor to get a parallel road between New York and Boston, in order to injure the New York, New Haven and Hartford road. They are there every year; they have to be looked after all the time—a railroad commission cannot keep them out. And a gas commission could not keep out opposition in the gas business unless its members were clothed with absolute power by the legislature. Then, again; how is this commission to be appointed, and what would be the means used to get around the commission? Would you place the appointing power in the hands of the Governor? The Governors of all of our States are not beyond suspicion. Are they any better than the average aldermen? There are a great many points bearing on this whole matter; and it is very difficult to declare that any one particular line of action will benefit the entire gas interests of the country. I believe, first of all, that you should devote your energies and abilities to the manufacture of a good illuminating gas, and furnish it at the lowest possible price which will enable you to pay a fair return to your stockholders on the investment. This, I believe, will be the best protection that the gas interests of the country can have. It is the line of policy I trust will be adopted and carried out—carried out where it has been adopted, and adopted where it has not been. I trust every one will labor to that end, and then there will be no trouble.

Mr. Greenough—I will say a word in reply to Mr. Harbison. I think he makes a mistake if he counts too much on the good will of the people of Hartford towards the gas company. The Boston Company has been attacked at various times in the last twenty years; and as long as we had a city government which was a credit to the city it continued to vote that one company was enough in our town at one time. The character of our great cities changes. The city of Boston has undergone a most unpleasant change with respect to its city government. One of the results of this change has been permission granted to a new company to supply gas anywhere in Boston. Now, however, that one horse has been stolen, we have locked the stable door. The Boston Gas Light Company, some five years ago, tried to get a commission appointed in the State of Massachusetts; but in that effort the Boston Gas Company was defeated by other gas companies in the State. Mr. Thomas is right when he says that the policy of protection in this country is to have separate gas commissions in the separate States. That is the best policy, in my judgment; and for Mr. Harbison to oppose it here is, I think, a mistake.

Mr. Harbison—I said they would not be found useful in keeping out opposition unless you gave them power.

Mr. Greenough—Of course you must give them power. As the gas commission stands to-day in Massachusetts, any company that accedes to the recommendation of the gas commission is practically sure of having no competition in its town, because any new gas company wishing to do business in a city or town of Massachusetts where there is an existing gas company, has not only to get permission of the selectmen or aldermen of that town, but has also to get permission of the gas commission. I venture to resent the suggestion that ordinarily the governors of Massachusetts are any such men as have filled some of the aldermanic chairs in our large cities. As long as Massachusetts remains the kind of State that she is, I think we will get honest men appointed on our gas commission; and as long as we have honest men on that gas commission to execute the law as it stands, I think the gas interests of the State of Massachusetts will be practically safe. The mem-

bers of that commission have power, like the railroad commission, to investigate the figures of a company. They are to have full power of ascertaining what business is being done by the different companies in the State; and, in return, the companies are to have protection. It is a fair bargain. The sooner other companies in this country, which may still be enjoying immunity from competition, go before the legislatures of such States as are capable of appointing honest men to office and ask for commissions of that kind, and without waiting until it is too late, the better it will be for the companies. I think that is the remedy at the present time for the competition which is springing up throughout the country. And, in proof of the fact, it is matter of common report that some gentlemen in Boston, who are now scheming for an increase of capital and for a repeal of the water gas law, are also endeavoring to attack the gas commission. They do not want that kind of an investigation into their affairs. They are not the first ones to come into it when there is danger of having their own books examined and their own way of doing business looked into. One of the attacks to be made in Massachusetts this year is to be made on the gas commission, in order that the opposition gentlemen who wish to practice their profession in Massachusetts may not be stopped from doing so. I cheerfully sustain all that Mr. Thomas said.

Mr. Wood—I quite agree with Mr. Harbison that, to furnish a good quality of gas at a low price, and to cater to the public interests in all directions, would strongly tend to protect the existing companies against opposition raiders. In Connecticut, however, they are quite differently situated from most of us. There the gas man is fortified, in that the raiders, in the first place, are compelled to obtain the consent of the State legislature before they can secure a franchise to build a gas works in any Connecticut town. Then, I presume, with that consent obtained, the promoters are obliged to obtain consent of the council or selectmen before they can go ahead with their scheme. Thus it is seen they have to buy up the legislature before they can get at the council. With most of us, though, any set of individuals can form a gas light company by filing articles of incorporation with the Secretary of State and County Clerk, and then, by authority from Common Council, may dig up the streets and erect their works. Dealing fairly with the people will not always succeed in fortifying a company against the action of such common councils as we have in some of our cities; and that has been fully illustrated in the city of Boston. We all know that the old Boston Company furnished a good quality of gas, at a low rate, for many years, and that the dwellers in that city's suburbs were served as far as the company's charter permitted it to advance into the outlying districts. Nevertheless, a simple application to the Boston common council induced the aldermen to grant franchises to two opposition gas companies. Remembering this, it would seem as though catering to the wishes of the public will not save you altogether.

Mr. Helme—I think Mr. Harbison has pressed a little too hard on my case. I believe, were we to examine the history of the Atlanta (Ga.) and Hartford (Conn.) Gas Light Companies, as shown by the records of each during the last 30 years, the managers of the former corporation need not be ashamed of the comparison. Mr. Harbison's company, for a certain period, paid a 12 per cent. dividend. His consumption then was four or five times greater than ours at Atlanta is now; but we never paid over 10 per cent. Now he is charging \$1.60 for gas, and thinks the price is low; but it is paying his stockholders 8 per cent. We all know that the insurance business keeps the city of Hartford in splendid financial condition. When Mr. Harbison went to Hartford, Atlanta was a little cross-roads village; and for four or five years after our gas company was started our annual product was not over eight million cubic feet. We were obliged to charge rather an excessive price. Since we have been in a position to do probably one-third of the business enjoyed by the Hartford company, we have not charged a higher rate than his, nor in fact as high a one. I think we have done justice to the public in that respect. Atlanta is a poor community. Four or five railroads center there; these give employment to mechanics, who constitute the bulk of the population. We have very few capitalists; and those that we have do not want to invest in gas stock. They have better outlets for their money, and can earn 18 to 20 per cent. on it in the other directions. The consequence has been that the gas company has been obliged to get along as best it could, deprived of the moral support which comes from having the "solid men" of the town interested in its local enterprises. The rebuilding of our works cost a greater sum than was originally expended upon them. During the war they had been neglected; heavy artillery traveled over the streets and broke the pipes; the entire works were burned down, and the holder was used as a target for a six-gun battery, for a month or so, when the gunners had nothing better to aim at. We have always sold our gas as low as any company within 250 miles of us. It is true we are nearer now to the coal field. In former times the quality of the coal used was very poor, although latterly it has improved. We could get but 3½ feet of 12 to 14 candle gas to the pound; but our people said, "Better that than nothing." We could not do any better for them then, as there was no railroad commu-

ication to richer mines. Now we are able to get good coal, and are selling gas at \$1—not because we want to, though. For quite a while we charged \$2.50. Where a three times larger business is done (as is the case with Mr. Harbison), where can be the justification for keeping up gas prices? We all know an increased output counts up rapidly in the gas business. Again, this thing of piling up profits, to reserve them for future emergencies, seems to be a moral sin in the judgment of some gas men. I fail to understand why it should be so considered. You watch a man enter a town and start in some sort of business; if successful he will, in a few years, tear down the old store and replace it with another much handsomer and larger. In doing that he commits a sin similar to the one we are charged with. I think it is wise to lay up something against the misfortunes of old age, and against the contingencies and emergencies of business. I think five or six dollars invested for every thousand feet of gas sold is not very extravagant, and few companies can make a better showing.

The Association then adjourned, to reconvene at 9:30 A.M. of following day.

SECOND DAY—MORNING SESSION—THURSDAY, OCT. 22.

When the members were seated and order called for, President Vanderpool announced that the morning's proceedings would be opened by the reading of papers. Mr. M. S. Greenough, of the Boston (Mass.) Gas Light Company, was then introduced; and that gentleman read the following paper on the subject of

STOKING MACHINERY.

It is with some hesitation that I have prepared a short paper upon this subject of "Stoking Machinery." It is one which can only be of personal interest to a comparatively small number of the members of any Association; since by far the larger number of works are too small to make it worth their managers' consideration for a moment; and, secondly, because many of the managers of the larger companies have undoubtedly given the matter their personal attention, and are familiar with the facts which I have to lay before you. At the same time there are also a number of engineers who are probably in the somewhat indefinite position in which we found ourselves in Boston a year ago—believing in the advantages of stoking machinery, in the abstract, but without any detailed or clear idea of what might probably be expected from the use of any given machine. It is to them that I more particularly address myself, as I believe that the examination which I have had occasion to make this summer into the merits of the various stoking machines may save them some trouble in the matter.

Firstly; it is worthy of attention that the two principal operations that take place in a retort house—viz., drawing and charging the retorts—really stand upon entirely different bases as regards economy; although when machinery is to be employed at all it is commonly supposed that it will be employed for both purposes; and, in point of fact, it generally is. In no English gas works that I have visited has one been used without the other; and yet it might very well pay to use a drawing machine in cases where it would not to use a charger. This will appear upon consideration of what must be done by the machines to perform the work now required of the men employed in each occupation. In ordinary cases it is true that the work of each man is so varied as to make it difficult to estimate the due proportion given to each of the different occupations in which a man is engaged who works at the fires. He probably assists in putting in the coal and in hauling out the coke. He helps to strike the lids; to ream the standpipes; to run the scoop; to draw the coke; to charge the furnace; and to remove the clinkers. With the modern improvements in large retort houses, however, it is getting to be more the custom to separate the work and to assign to each set of men a particular duty. With the introduction of generator furnaces there is gradually disappearing from gas works that well-known article, the ancient fireman, who knows it all, and who prefers his own ideas on the subject of heat to those of any other person. Brains are the material with which retorts can now be heated; and the man who tends the fires need have nothing to do with the labor on the charging floor. Coal is often brought in and coke drawn out from the cellar by men who have no other work assigned them. This leaves only the labor of drawing and charging the retorts, cleaning the standpipes, attending to lids, etc.

If it is desired to supplant this work by machinery, it can again be easily subdivided by using a drawing machine. This is, in every case, a comparatively simple piece of apparatus; and though the rough work to which it is put causes the necessity for frequent repairs, yet they are generally of a nature which do not long delay the work, and can easily be made. One man can run a drawing machine without difficulty. It only requires a set of rails in the floor, some arrangement for handling coke, and motive power. If this motive power is air or water, and is furnished from an accumulator at a distance to several machines, it is, of course, not proportionately more expensive to run charging machines at the same time, so far as the power goes; but if the power is to be steam and travel with the machine—a system possessing some advantages—then a set of rails may be all the change required,

in a wide retort house, to allow of the introduction of apparatus with which one man can draw 174 retorts every 6 hours, or a proportionately less number every four. Suppose, for example, that a machine cost \$6,000, and that it takes 20 per cent. for repairs—an estimate sufficiently large—we have \$360 at 6 per cent. interest, and \$1,200 repairs, or \$1,560 a year. Divide by 365, and we have about \$4.30 a day as the daily cost of the machine. Add to this two engineers, at \$3.00 a day, and it makes \$10.30. Add to this, 30 bushels of coke, at 5 cents per bushel, or \$1.50 for fuel, and you get labor, fuel and interest, \$11.80 a day for drawing 120 retorts, or thereabouts, every 4 hours. Suppose this to be done by men who did nothing else; and how many would it take? If it took six in a watch—which I think a moderate estimate—and they got \$2.50 a day, it would be \$30.00 a day for labor, or a saving of about \$18.00 a day, or \$6,400 a year on every machine employed. This would obviously pay for works where a much fewer number of retorts than 120 are used. With charging machinery the case, however, is different. The coal for the charger must be brought to it and put into an overhead hopper, if it is to work to advantage.

I have seen a charging machine used, it is true, when the scoops were filled in a coal shed, brought on a car by a horse to the machine, lifted by the machine and swung into place, and then pushed into the retort by hydraulic power; and it was claimed that there was a saving of money. At the best, however, this can be but little. To properly work a charger there should be a breaker, an elevator, and overhead bins to hold the coal, as well as some conveyance to fill these bins. I am aware that some companies work without a breaker; but when lumpy coal must be used it is, I think, a mistake. If coal is to be run into a scoop it can be done more evenly and more regularly in weight; and if it is to be blown into a retort it can unquestionably be better done if the coal is all of the same approximate size. Suppose, then, that a breaker and elevator are used; this requires power and attention. After elevation the coal needs distribution in bins, and probably some leveling in the hopper of the machine. To the first, then, some attention must be given—even if steam power is furnished; without it—considerable manual labor. To run the coal from the bins to the hopper, level it, and put it into the retort, would probably require an engineer and a helper.

All these essentials make the question of economy a much more difficult one. It is no longer so simple a question of arithmetic as the other. Circumstances will affect each company differently as to the way in which they can most conveniently handle their coal. One thing is very evident—that a much larger interest account must be paid, and that it will be necessary to work a much larger number of retorts by machinery to make it pay than if the drawing machine alone is used. If the full value of a machine is realized—that is, if all the work is extracted from it of which it is capable, then I have no doubt of its paying; but I am not yet prepared to furnish figures which would accurately show its economy.

The three principal motors—steam, air and water—have each their representative machines for stoking. Electricity, the new force, has not yet been applied in this direction; but an electric stoker has been promised. Taking these in order, we have steam in the Ross machines; air in the West machines; and water in the Foulis. It might be said, in a general way, that if only one or two machines are to be used, then it is unquestionably better to carry the power with the machine; but if power is to be supplied to a number, then there is much to be said in favor of concentrating it. In that case the question is to be at once considered of the relative merits of air and water for the conveying of power. On the one hand, it may be said in favor of air that it is perfectly safe to handle; that it continually supplies fresh, cool air to the heated atmosphere of a retort house; and that its conveyance to the machinery over a reel, through tubing, is very simple; and that the plant must be cheaper than hydraulic apparatus. On the other hand, it is to be noted that hydraulic power is now greatly used in many modern gas works for discharging coal, raising elevators, and lifting purifier covers. Although a hydraulic stoker requires a pressure of only about 175 lbs.—and that is more than an elevator needs—yet the views of hydraulic engineers are all turned towards supplying water at much greater pressure; and it is asserted by eminent gentlemen that to be economical it must be used in that way. A company is now delivering it in London at 700 lbs. pressure, and getting all the business they can do. If it is to be so supplied on the premises of a company, it would require but a comparatively small addition to the apparatus to run a stoker. The pressure pipe is carried along the retort house wall high in the air; and connected to it, by ball and socket joints, are hanging pipes, one of which is coupled to the machine, and allows it to serve several benches before [it is necessary to disconnect and couple on to the next pipe—an operation requiring perhaps half a minute to accomplish. I did not see it in use sufficiently, perhaps, to hear any criticisms on its working; but I certainly did hear it said of the compressed air, when supplied through a hose and reel, that the action of heat on the hose tended to make it leak, and that it was frequently necessary to stop the work until a new hose could be put on. Judging from this, and other criticisms which were

made to me, I should not consider that the use of air had been wholly a success; and if I were to express an opinion on the subject of distributing power it would be in favor of water.

The West machine, however, is in no way dependent on the use of air; and, unless I am mistaken, there are machines now being constructed by Mr. West which rely upon steam, and propose to carry their boilers with them. His machine has been adopted by some of the principal English works. I saw them in constant use at one of the Manchester stations; at one of the Birmingham stations; and standing in a house just let down belonging to the South Metropolitan. In all cases it was stated there was an economy in their use; but the economy is so small, as compared with labor, that many other companies doubt the advisability of going to the expense. It must, however, be noted that 3½d. (or 7 cents) per thousand is a high price for retort house labor in England. Their wages are about half what we pay; and I am inclined to think that six-hour charges can be put in with somewhat less proportionate labor than four. At any rate, it is obvious that what might not pay there might handsomely do so here. Many companies there do not have so high a labor account as 3½d.—2½d. is not uncommon, I believe; and one manager of a large company, whose name I am not at liberty to mention, gave me 14.83d. per ton as the cost of his labor when doing the work wholly by hand, and 8.6d. per ton as the cost by machinery, allowing nothing for repairs. Allowing 15 per cent. for repairs and interest, the saving was only 2.96d. per ton of coal carbonized.

To return to the West machines. I should only state in addition that the scoop is D-shaped, like the retorts, and that, as now arranged, it runs in to its whole length, without the wheels which were used at first to support it. The bottom is hung on two hinges, like a butterfly valve, and is opened at once throughout the whole length of the scoop, allowing the coal to fall through on the floor of the retort. It will put 336 pounds of coal into a retort 20 in. by 16 in. by 10 ft. Sixteen inches height in the retort is requisite for the use of this machine, if a heavy charge is desired. It works admirably, charging faster than the drawing machines can draw, and puts in the coal better than it can be done by hand. It requires a flat-bottom retort.

The Foulis machine has been used for many years at two stations in Manchester. It has until lately labored under the great drawback of having no arrangements for mechanically filling the scoop. It has been seen, however, that this is a necessity to its further use; and experiments are just about to be entered upon at the Gaythorne station in Manchester for breaking the coal and filling the scoops by machinery. When this is done its economy can be better compared with the other machines. It works quietly and efficiently—the two machines drawing and charging at the rate of 60 retorts in 40 minutes. The scoop used is connected with the end of a piston-rod worked by hydraulic power. It is of the shape of an ordinary scoop, and is run into the retort, turned over, pulled out upside down, and turned back again when withdrawn. It requires 15 inches height to work in, and less repairs than the West machines used at the other Manchester stations. It was arranged at Manchester to put about 275 pounds of cannel into a retort 22 in. by 16 in.

In spite of the successful working of these machines, there were two large English stations where the engineers preferred to use the Ross stoking apparatus, both for drawing and charging. As regards the drawing machine, there is no doubt about its giving satisfaction. The charger, however, has received much more criticism. It may be of interest, however, to this Association to hear that it is well liked where used abroad. Its most radical defect, and one requiring remedy, was its defective boiler power as furnished by the contractors. The engineer of the charger, to do good work, ought to have a boiler sufficiently large to enable him to work without seriously impairing his pressure; otherwise it is impossible for him to accurately measure his work. If his steam gauge remains tolerably level, and his coal is even in size, the machine will work fairly well. In Birmingham, where Midlands coal was used, which ran both lumpy and fine, it was impossible to do such good work as in London, at the Nine Elms station, where the coal was from Newcastle and contained few lumps of any size. In my judgment it would be equally so with Youghiogheny coal when using this machine, unless a breaker is used for the coal; but if it is, and ample boiler power furnished, the accounts which I received were certainly satisfactory, though it cannot be said of it that it will lay the coal in the retort as evenly as the other two machines. It can be used with flatter retorts than the others, and can give a charge of variable weight; while the others require a certain height for the scoop to work properly, and the weight of the charge is also restricted to the scoop's size.

Besides the three machines which I have briefly described there is also one which was the invention of Mr. Rowland, of Greenpoint, L. I., and which was in successful operation in the New York City Gas Company's works. He has since changed it materially, and has constructed one for the Boston Gas Company, which we hoped to have started long since, but which circumstances have interfered to prevent our using. It was contracted for before my visit to the other side (which I made this summer), and all the

arrangements for breaking, elevating, and carrying the coal throughout our new retort house have been completed this season—some changes in the original plant having been found necessary. It is a combination of steam and hydraulic power, and will be tested thoroughly this winter.

To sum up the results of my examination into the subject of drawing and charging machinery, I can only say this—that I have no doubt it would pay to use a drawing machine in works where sixty retorts were habitually drawn in a row; and a charging machine for works of double that size. Perhaps that number is set too high; but it is possible that I have not made sufficient allowance for the daily trivial expenses, which amount to so little singly and so much when added together. This restricts their economical use to good sized works undoubtedly. If it be determined to introduce them, however, I have shown that there are various ways in which the problem has been successfully solved, and a choice can be made according to circumstances and the individual preferences of the company's manager. Improvements are being constantly made, and it would be a mistaken policy, in my judgment, to erect a large coal gas station at the present day without arranging for the introduction of each kind of machine.

Discussion.

The President—We have listened to a most interesting paper, and I hope the subject will be well discussed. I notice that Mr. Fullager, of the Cincinnati (Ohio) Gas Company, is present. As he probably has had more experience than any other engineer in this country in the use of charging and drawing machines, we would like to hear his experience.

Mr. Fullager—I did not hear the paper read, and therefore am not prepared to discuss it. I can say we have a drawing machine at our West Station which has been working steadily for three years. We required to have a charging machine there also, on account of increasing the weight of the charges to 260 pounds per retort. We have a charger at work in the new station. The retorts in that station are 20 feet through retorts. We draw from each side, and can draw at the rate of one a minute. We are working eighty retorts, forty on a side. We draw 15 the first hour, 10 in the second, and 15 in the third. We have not yet been able to give what would be the results from the charging machine. Up to the present time the machine has worked most satisfactorily, although some drawbacks happen occasionally; but these may be traced to our comparative unfamiliarity with them. I have no doubt that we will master them completely in a short space of time. The drawing machine was a success from the very start. It will pay a company operating six or eight benches to put in the drawing machine. Any company with a daily output of from 1½ to 2 millions cubic feet will find it profitable to put in each class of machine. Even if you do not always use them their presence acts as a check upon the men. The men know, as long as the machines stand ready to be put in operation, that manual labor can be dispensed with. The drawing machine alone will save the labor of two men per day, and an equal number at night. We make that labor saving on ten benches of eights. Three men and an engineer handle the five benches. We charge 310 pounds every four hours. We are able to charge 420 pounds in five-hour charges. It is easier for the men, while we obtain the same results.

The President—Do you find through retorts to work better than single retorts?

Mr. Fullager—They enable the machine to work better; the coke does not pack up at the back.

The President—What about charging? Do through retorts favor that?

Mr. Fullager—Yes; the charge does not pack up against the back of the retort. I think through retorts are preferable to single ones where stoking machines are employed.

Mr. Littlehales—I would ask Mr. Greenough's opinion in regard to the smallest size of plant in which a charging machine could be profitably worked.

Mr. Greenough—My opinion agrees with that of Mr. Fullager. I think that where a stack of sixty retorts is operated it will pay to put in a drawing machine. I believe Mr. Fullager thinks it will pay in works with fifty retorts.

On motion of Mr. Wood a vote of thanks was tendered to Mr. Greenough.

[To be continued.]

Safe Sea-Carriage of Coals.

According to the London *Colliery Guardian*, a case recently heard at the Court of Sessions is one of immense interest to coal owners. It brought to the fore again the momentous question as to whether coal can be safely carried long distances over sea. The case was heard by Mr. Commissioner Rothery, who had three nautical assessors to assist him. The ship *Cithrum* left the Tyne in June last with 1,600 tons of Cowpen steam coal, and a few tons for the ship's use, and with 1,000 tons of other cargo. 1,400 tons of the coal was stowed in the lower hold, with pig iron and coke. The coal reached

from the mizzeumast to a little abaft the foremast, and the remainder of it was stowed in the after part between decks with part bricks. There were also two iron ventilators on each side of the fore-castle, extending through the 'tween decks to the lower hold, and these are fitted with cowles. On the 17th of August smoke was reported issuing out of No. 1 ventilator, but no fire was then suspected. A smell of chemicals, however, continued; rain came on, compelling the closing of the hatches; and an explosion followed which blew up the greater part of the decks, killed a man, injured several others, and the vessel went down. The coal consisted of 924 tons from the low-main seam of Cambois colliery, and 704 tons from the yard seam of the Cowpen pit. Authorities in the north, and Mr. Willis, Government Inspector, showed that there was a small quantity of pyrites in the Cowpen seam coal. The master, chief mate, and second mate of the vessel also gave evidence, and Captain Steinson stated that he had been counselled by the owners, Messrs. Hall, respecting the ventilation, and he had had the fore and aft ventilating shafts plugged up and the connection severed. He disapproved of through ventilation. He thought it might have been better had the vertical ventilators been done away with, and ventilation only been secured from the surface; but the ship carried coal to Hong Kong, and this showed that it was not dangerous. The court found that the coal contained a very small quantity of iron pyrites, which, according to the Government Inspector, if properly cleaned, was quite fit for the long voyages. They had no reason to think the coal was not properly screened and cleaned. Every care seemed to have been taken, and the rule of the owners, that it should only be shipped in fine weather had been observed. They found that the fire had originated in the body of the coal and caused an explosion. The verdict, in short, freed the colliery owners from all blame. The question is to be answered, how did that fire begin? We may point out that chemicals have before now aided in the explosions aboard ship, and that strong smell of chemicals found by the crew of the *Cilurnum* would indicate that something of the kind occurred aboard that vessel. In the case of the *Empress*, of Hull, which occurred about two years ago, the hold of that vessel contained coals and bags of sulphate, etc. The coals were Yorkshire sorts of a well-known non-gaseous kind. Water, as in the case of the *Cilurnum*, got into the hold. There was an agreement of opinion that the mixture would prove sufficient to cause non-gaseous coals to evolve gas freely, and to lead to explosion. There is something feasible in thinking that something of this kind may have caused the recent disaster. This would urge the necessity in future of separating coal from chemical cargo. The court found that the ventilation of the *Cilurnum* was not of the very best character; but, as a matter of fact, that vessel was considered a safe one, and was as well appointed as many hundreds now afloat. Deck ventilators simply contribute to drench the cargo, and to lead to possible disaster. The matter of ship ventilation is still a serious question, when ventilated vessels sink to the bottom from explosions, while non-ventilated sail in safety.

ITEMS OF INTEREST FROM VARIOUS LOCALITIES.

A NEW GAS COMPANY.—The well-known engineering and contracting firm of Messrs. G. B. & W. F. Inmann, whose headquarters are in New York city, have recently completed the erection of a water works plant in the town of Fort Madison, Iowa. When the franchise was originally secured the grant included the right to operate a gas works also; but it was thought the latter permission would not be availed of for some time to come, since the residents of the place appeared to be rather firm believers in the efficiency of gas machines and kerosene. With the completion of the water works, however, some of the more progressive spirits of the place suggested that, as Messrs. Inmann had made such an excellent job of the water system, they had better be called upon to erect the gas plant without further delay. A canvass of the people caused the contractors to view the suggestion with favor, and Mr. Clement A. White (who had charge of the water works construction) is now busily engaged in superintending the erection details of Fort Madison's gas plant. Fort Madison is the capital of Lee county, Iowa. It is located at a point on the Mississippi river 19 miles southwest of Burlington, and is reached by the Burlington and Southwestern and Burlington and Keokuk railroads. It has a population of about 4,800.

THE PORT CHESTER (N. Y.) OPPOSITION COMPANY.—Greatly to the surprise of the people of Port Chester, a gang of laborers recently commenced excavating the streets of that place for the purpose of putting down mains intended to form part of the plant of the Citizens Gas Company—an opposition concern, a charter for which was granted by the local authorities something over a year ago. The owners of the Citizens' franchise have, it is understood, been anxious to dispose of their "rights" to the managers of the old Port Chester Company; but the latter were not willing to be blackmailed, and declined to "buy out" their would-be antagonists. In view of the fact that the spring and summer seasons of the year were allowed to pass by without any attempt being made at plant construction, it would seem as though the

present move is merely an attempt at "bluffing" on the part of the opposition manipulators, although they claim to be in earnest, and assert that they have purchased five acres of land in the vicinity of the Rye Railroad depot whereon to place the necessary buildings, etc. They also announce their intention of not only placing pipe in the town of Port Chester, but will extend the system to the adjoining precincts of Rye, Harrison, and Mamaroneck. A Mr. Olney—presumably of Brooklyn, Bayshore, Babylon, *et al.*, fame—is the "engineer" of the Citizens Company scheme; and, from all that we can hear about it, the entire proceeding possesses a decidedly fishy appearance—scales, smell, and all. The people interested in the old Port Chester Company have large real estate holdings in the neighborhood, and may safely be counted upon to make it warm for Mr. Olney and his backers.

WILL THEY SECURE A Foothold?—For some time back a certain set of speculators have been casting envious glances at the district now occupied, and occupied with credit, by the Northern Liberties Gas Light Company of Philadelphia, Pa. The particular cognomen selected by the enviers to distinguish their "individuality" from that of other operators in the same particular branch of industry, is this suggestive one—the Economy Gas Company. We have heard it hinted that the band might possibly be possessed of economy in one direction—that it was rather economic in the matter of honest business principles; and the hint is borne out somewhat strongly by the initial method of procedure—which, however, in no manner differs from the stereotyped form pursued by others of the raiding class. The first step was to interview the managers of the Northern Liberties Company, in the attempt to induce the latter to either sell or lease their plant to the newcomers. [Right here we cannot forbear from alluding to the stupidity or cowardice (it must, in plain terms, always be either one or the other cause) of shareholders who give up their works to these wreckers in consideration of an "interest guarantee." If the marauders can make money out of your property, what is to prevent or hinder you from making money out of it? Can it be possible that their business talents are so greatly superior to your own; or are you prepared to confess that their acumen only commences at the point where your's terminates? And, again, what earthly value can attach to their "interest guarantees" when the pinch really comes?] Failing in the attempt to convince the Quaker City company's shareholders that they did not know how to manage their own property, the Economy manipulators appeared before Councils and petitioned the Aldermen for a franchise to operate an opposition works in the coveted district. As to the action taken by the authorities thereon we have not yet been advised; but, judging from the knowledge of gas matters possessed by the Philadelphia City Fathers, there is reason to hope the Economy scheme will be negatived. A recent issue of the *Philadelphia Record*, in commenting upon the Economy petition, said: "By their fruits ye shall know them. In other cities the speculators have preyed upon investments in gas works and upon gas consumers. What reason is there to expect any better treatment in Philadelphia?" To which we would reply, "None in the slightest."

TROUBLE OVER STREET LIGHTING AT PITTSBURGH, PA.—The street lamps in the East, West and South districts of Pittsburgh have been lighted by the East End Gas Company, but the contract under which Mr. Denniston operated terminated on November first. In the meantime the city Councilmen had granted a three-year contract (commencing with date of Dec. 1st, 1885) for the lighting to the Pennsylvania Globe Gas Light Company, which only awaited the Mayor's signature to become binding on the city. The Mayor, however, refused to affix his signature to the document, and as the veto would not come before the Councilmen until their meeting on the evening of December 4th, it looked like as though a great portion of the city would be left in darkness. Supt. Denniston did not know exactly how to act; but Controller Morrow told Mr. D. to go on with the lighting as formerly, and the city would pay the bills in accordance with the terms of the contract under which the East End Company performed the work. In this way Pittsburgh's streets were kept from darkness; but we submit it seems rather queer that the Pittsburghers should elect to light their streets with a gasoline or naphtha illumination—for such is the material employed by the Globe Company.

THE NATURAL GAS FLOW WAS WEAK.—The Allegheny County (Pa.) Electric Light Company's station, on Virgin street, Pittsburgh, was compelled to suspend operations on evening of November 30th on account of scarcity of the natural gas supply. Several complaints about an inadequate fuel supply have recently been made by those depending on the natural gas commodity for the working of their factories, etc.

RETAINING THE ARC LIGHTS ON THE BRIDGES.—The Edison Illuminating Company, of Lawrence, Mass., having been awarded the contract for lighting the public lamps of that city under the incandescence plan, naturally enough concluded such permission or award gave it the right to replace the arc lamps, formerly in use on the railroad bridges crossing the Merrimac

river, with those of its own description. The Lawrence Electric Light Company (arc system) contended against the proposition, and the matter was referred for settlement to the Streets Committee of the Board of Aldermen. The Committee, after due notice, gave a public hearing to those interested, and the general sentiment appeared decidedly favorable to the retention of the arcs; but, on the other hand, the testimony advanced at the Committee's session must go far toward throwing discredit upon the incandescent plan of illumination as at present practiced in the lighting of the city's streets. What is claimed to be a valuable and superior lighting agent for the streets ought to be adequate enough to light the bridges. Still it seems not to be so at Lawrence. One objection offered against the arc lights was to the effect that they were extinguished at too early an hour—i. e., "early for morning"—the current being shut off at midnight; but this appeared to have been negatived by the plea of a certain Mr. Jno. Campbell, taxpayer, who thought "twelve o'clock was the proper time to extinguish the lights; for those persons out after that hour, as a rule, were in no fit condition to be seen." At any rate, the deliberations of the committeemen resulted in a unanimous ballot to recommend that "the arc lights now in use on the bridges, and common to the city government, be retained." The charge made by the Lawrence Electric Lighting Company for maintaining each arc in action until midnight is ten dollars per month—a pretty stiff price, by-the-way.

CHEAPER GAS FOR COLUMBIA, PA.—Mr. Robert Beacham, of the Columbia Gas Light Company, writes us that a reduction in selling rates was made by his company on date of Oct. 1st, 1885. Those using over a certain monthly quantity are charged at the net rate of \$2 per thousand; consumers in the lesser grade obtaining their supply at the figure of \$2.50 per thousand, subject to a discount of 10 per cent. if bills be paid on or before the expiration of 15 days from rendering of account. The former net prices were \$2.25 and \$2.50 respectively. Keep it up, Mr. Beacham.

PRICE OF GAS REDUCED AT GRAND RAPIDS, MICH.—The Messrs. Gilbert, of the Grand Rapids Gas Light Company, once more report the right sort of progress, and the following is evidence that they are believers in the efficacy of low selling prices. The new plant of the company was put into successful operation on the 23d day of last Oct., or just in time to relieve the management from the unpleasant predicament of being forced to acknowledge their inability to supply the demands of their patrons. The inauguration of the new plant was made the occasion for announcing the following schedule of prices, the scale to take effect on consumption registered from first day of 1886:

To consumers of 10,000 cu. ft. per month, net price...	\$1.30 per M.
Between 5,000 and 10,000 " " "	... 1.50 "
" 1,000 and 5,000 " " "	... 1.60 "
Less than 1,000 cu. ft. per month " "	... 2.00 "

The above is certainly the cheapest sort of a schedule when one bears in mind the distance separating Grand Rapids from the rich gas coal basins. We do not believe, however, that "bottom rock" has been reached there yet, as the Messrs. Gilbert freely confess that the steady reduction made by them in gas rates during the past six years has been the means of increasing their business in a really wonderful manner. We congratulate them upon a success fairly and honestly earned.

CHEAPER GAS FOR ELKHART, IND.—Mr. Geo. T. Murdock, Sec. and Supt. of the Elkhart Gas Light and Coke Company, forwards the information that on and after January 1st, 1886, the discount granted to all classes of consumers will be increased to 50 cents per thousand cubic feet. This brings the net rate down to \$2. The discount is applicable only to accounts that are settled within the first twelve business days of the month. The Elkhart gas men evidently are not sleeping at their posts.

PROPOSING TO REMOVE TRUSTEE CLARKE.—Messrs. C. R. Cummings, S. A. Kent, and W. S. Reyburn, who are holders of several thousand dollars worth of the first mortgage bonds of the Consumers Gas Fuel and Light Company, of Chicago, Ill., have called a general meeting of the bondholders of that corporation, the principal purpose of the convention being to agitate the question of the removal of Mr. Dumont Clarke from his position as mortgage trustee. The advertisement of meeting reads in this way: "* * * for the purpose of submitting to the holders of said first mortgage bonds the question of the removal of Dumont Clarke as such trustee, and such other matters as may be proper for such bondholders to act upon." Judging by the present standing of affairs, the meeting ought to be a prolonged one, if "all such other matters" are to receive a fair share of attention. The meeting is to be held at the Company's office, No. 94 Dearborn street, at noon of December 19th.

STREET LIGHTING MATTERS AT HILLSBORO, OHIO.—The ten-year contract between the authorities and gas company at Hillsboro, as to the lighting of

streets, has expired; and it appears as though a hitch would occur over the terms to prevail in future. Under the old contract the gas company received \$31.50 per annum for each street lamp, and was also allowed to charge private consumers at the rate of \$3 per thousand cubic feet. The Council has submitted a proposition to the gas company, under which the city agrees to award the former a contract for a term of years if it will accept as compensation \$12 per annum for each street light, and agree to charge but \$1.50 per thousand to private consumers. Of course, the figures submitted by Council are ridiculously inadequate, and there is no reason to suppose that the company would consider them seriously for a moment. It goes without saying, however, that the old prices are also outside of reason now; and we may express the hope that each party to the contract will see the necessity of making concessions. How would \$22.50 per annum for lamps and \$2.10 per thousand to private consumers suit? In the meantime the agents of the Thomson-Houston electric lighting system are endeavoring to induce the Council to try the arc plan of street lighting; but, should such consent be given, before long the authorities would have occasion to regret that they did not conclude a contract with the Hillsboro Gas Company even at the price of \$31.50 per lamp. Perhaps some of our Hillsboro friends will kindly let us know something about the conclusions finally arrived at.

AN ANALYSIS OF NATURAL GAS.—Col. F. W. McCarty furnishes the following figures concerning the composition of the natural gas issuing from the well discovered by the National Tube Works Company on its premises, at McKeesport, Pa.:

Marsh gas.....	94.09
Free hydrogen.....	2.90
Carbonic oxide.....	1.02
Olefiant gas.....	.94
Oxygen.....	.74
Carbonic acid.....	.06

Col. McCarty—who spent a number of years in the Russian petroleum and natural gas regions, in the vicinity of Baku, where he successfully applied the natural fuel product to the heating of boilers, etc.—is an enthusiast on the possibilities of the Murraysville wells. These, he believes, will last forever. Perhaps so, Colonel; but it rather looks as though the flow had already exhibited symptoms of weakness.

NATURAL GAS DISCOVERY NEAR WASHINGTON, D. C.—A despatch, dated Dec. 1st, says that workmen engaged in sinking a drill, for the purpose of determining whether the foundation for a proposed sluice gate could be sunk in the river at a point about 2,000 yards distant from the Washington Monument, were somewhat surprised over encountering a vein of natural gas. The flow was rather weak. The gas possessed a very bad odor, and burned with a flame color not unlike that given off by ignited alcohol. Col. Haies, engineer in charge of the Potomac River improvements, will make further investigations.

KILLED BY THE ELECTRIC CURRENT.—Jas. W. Prashka, engineer at the electric lighting station, corner of Fourth street and Mitchell avenue, St. Joseph, Mo., on the evening of Nov. 16th, was found lying beside the dynamo machine as though life were extinct. He was at once removed to his home, and medical attendance given him. The physicians were powerless, as Prashka never recovered consciousness. No explanation (other than that deceased had been prostrated by an electric shock) can be given, as the victim happened to be alone in the room when the accident occurred.

ELECTRIC LIGHT FOR TROY, N. Y.—According to the Troy Daily Telegram, it now looks as though the streets of Troy are to be lighted under the arc system. At the meeting of the Common Council, Thursday, Dec. 3d, Ald. Riley moved that the contracting board be directed to "cause a sufficient number of electric lights to be located to light the whole city, the location of poles and lamps to be under supervision of city engineer." This proposition did not, in all particulars, meet with favor from Ald. Cridge, who moved an amendment to the effect that "the lights be suspended over middle of the crosswalks." Alderman Riley, rightly believing the difference to be only that supposed to exist betwixt "tweedle-dum and tweedle-dee," gracefully accepted the amendment, and, "as repaired," the resolution was adopted. We suppose the Mayor will have something to say about the Riley-Cridge innovation in public lighting at Troy; and, if that august official is not concerned in the "job," perhaps he might be wise enough to veto the scheme.

THE NATIONAL TUBE COMPANY ASSUMING THE ROLE OF A BENEFACTOR.—In an "item" given elsewhere we speak of Col. McCarty as an enthusiast on the subject of natural gas; and we must now include his employer and patron (Mr. J. H. Flagler, General Manager of the National Tube Works Company) amongst the lists of public benefactors—that is, benefactors according to their way of thinking. The enthusiastic military man has been

engaged in making experiments in the direction of carburetting the natural product up to the point where it could become a satisfactory substitute for ordinary gas as employed for domestic purposes, and the Col. believes he has succeeded. The Tube Company's wells furnish a flow far in excess of that required to meet the fuel needs of the establishment, and when Col. McCarty had convinced Mr. Flagler that the carburetting process was a thing accomplished, the latter gentleman, in the goodness of his heart, asserted that McKeesport's inhabitants should enjoy the boon of "cheap high-power gas." Mr. Flagler, however, proceeded with caution, and at first suggested to the managers of the McKeesport gas company that they had better buy their supply from the Tube Works' wells. See Davitt, of the gas company, offered to try the McCarty mixture under certain conditions; but as the latter did not quite, or even nearly, meet the pecuniary estimates of benefactor Flagler, the "Tube Works man" avows his intention of "piping McKeesport on his own account." Of one thing we are quite certain; and that is this: If trained gas engineers like Messrs. Denniston, McElroy, and others could not make a success out of natural gas, in its application to ordinary lighting uses, Col. McCarty need not be looked upon as the one to succeed where they failed—despite the fact that the Col. spent many years in the Russian gas territory.

AND STILL THE TESTIMONIALS COME.—Reference to our advertising columns will disclose an entire new batch of testimonials certifying to the accurate manner in which the "Connelly Automatic Governor" does its work.

AN ITEM OR TWO FROM TORONTO, CANADA.—An opposition clique is endeavoring to effect an entrance into Toronto. Mr. Pearson's straightforwardness in the past will likely have the effect of keeping out the marauders. It may also be noted that the people are greatly dissatisfied over the electric lighting of their city. The contract calls for the supply and maintenance of lights having a power of 2,000 candles; but the average of several tests, made by independent observers, shows the power of the lights to be not over 400 candles. The gas company has recently placed 9 handsome specimens of the Lambeth lantern at different points on Queen street. The burners in these lanterns each develop a light equal to 150 candles, and their effectiveness is most favorably commented upon.

THE DEATH LIST.—"Terrence Curry, a farmer, of Johnstown, N. Y., came with his 17-year old daughter, on Tuesday, to visit sanitary policeman Pitkin, at No. 93 Perry street. His daughter remained there all night, while he went to the Clinton Place Hotel, Sixth avenue and 8th street. He blew out the gas, and was found dead in bed yesterday."—N. Y. *World*, Dec. 3.

ANOTHER ADDITION TO IT.—"Balt., Md., Nov. 29.—Yesterday morning Mrs. Gotham Lowenthal, aged 75 years, was found unconscious in her room, in the northwestern section of the city, and the apartment filled with gas which had escaped from a burner partially turned on."—Phila. (Pa.) *Record*, Nov. 30.

Correspondence

[The JOURNAL is not responsible for the opinions expressed by correspondents.]

Is It a Harmless Anæsthetic?

POUGHKEEPSIE, N. Y., Dec. 1, 1885.

To the Editor AMERICAN GAS LIGHT JOURNAL:

In your issue for November 16th appears a communication from Mr. A. L. Allen, of Poughkeepsie, N. Y., in which that gentleman presents his views regarding the non-poisonous qualities of carbonic oxide, and also refers to its "exhilarating" effect upon the animal system. It appears to me that these claims are put forward at rather too late a date. The question of the poisonous nature of carbonic oxide, as far as the opinions of eminent chemists and distinguished physicians are concerned, would seem to have been definitely settled long ago. Leading authorities are unanimous in their decision that carbonic oxide is a poison of the most virulent character; and it may be added this determination is concurred in by chemical experts of all civilized countries. As reported in your columns, Profs. Sedgwick and Nichols, of Massachusetts, not long since detailed the result of experiments made by them (at the instance of the State Health authorities) with this gas. Its deadly effect is truthfully and strikingly shown by the researches of these gentlemen. Not the least important evidence presented is that which shows the small quantity of gas required to be inhaled to produce fatal results. Their conclusions verify those of MM. Leblanc and Dumas, who long ago explained that air containing one per cent. of carbonic oxide will kill a dog in 1½ minutes; and that birds die instantly in an atmosphere containing 5 per cent. of it. Dr. Lethely found that air containing one-half per cent. of the gas killed birds in five minutes; whilst if air carried one per cent. a fatal result was reached about twice as speedily. He says that an atmosphere containing 2 per cent. rendered a guinea pig insensible. The animals fell down

insensible, and either died at once—with a slight flutter hardly amounting to convulsion—or gradually slept into death, as if infected with a profound coma. The Dr.'s conclusion was that "carbonic oxide is, in short, a pure narcotic poison."

The opinions above quoted, in so far as they show the true nature of this gas, have been amply verified by what has happened in this country since water gas has been commercially supplied. In the metropolis alone 86 deaths are recorded as having occurred from inhalation of the fatal vapor, and 49 cases of suffocation are also upon the register—many of the latter have no doubt terminated fatally. I submit this, of itself, furnishes all the proof requisite to refute Mr. Allen's "harmless anæsthetic" plea.

The gentleman also states that he purifies 113,000 cubic feet of gas with the aid of one bushel of lime. Are we to infer that that is all the material employed by him in his purifying boxes? To what purpose, then, is the oxide of iron and vitriol received by his company applied to? He claims that the electric light company, after six months' of canvassing, has only placed 15 of its lights amongst the patrons of the Citizens (Allen's) Company, while over 50 have been distributed in the Poughkeepsie Gas Company's district. What are the facts? Investigation develops the following:

In the Poughkeepsie Company's district 53 of its patrons employ electric lights—three of these consumers are interested financially in the success or failure of the electric company; while amongst the Citizens Company's consumers 27 (instead of 15) may be found using electricity. Indeed—with a charge of but \$7.00 per month per light, and lighting hours being from 4 P.M. to 10 P.M., it is matter for wonder that the "light of the future" has made such poor headway in the city of Poughkeepsie.

Since the advent of Mr. Allen and his *pure water gas* in this locality the usual changing about of consumers from one company to the other has been constantly going on; but still, the fact remains that the old Poughkeepsie Company has gained more customers than it has lost, which I take for granted is a good indication the gas consumers of the city are well satisfied with the commodity furnished by the managers of that plant.

Truly yours,

M. A. C.

Does Mr. Thurber Own Stock in a Burner Company, then?

NEW YORK, —, 1885.

To the Editor AMERICAN GAS LIGHT JOURNAL:

My attention has been called to an article in your issue of November 16th, in which my name is mentioned in connection with the Gas Consumers' Association, and a statement made by Hon. Geo. W. Greene, of Orange county, that I was interested in a gas meter job, etc.; that the amendment offered by him to the bill in the Legislature last winter was rejected in consequence of my opposition; that Hon. S. T. Hopkins, of Greene county, stated that I had solicited him to take \$10,000 stock in said meter company; that Mr. E. B. Harper, of New York, had also stated that one of my attorneys had solicited him to take \$5,000 stock. I am not interested in any gas meter company. I do not know any such man as Hon. S. T. Hopkins, of Greene county, N. Y.; consequently never solicited him to take \$10,000 stock in a new meter company. I do know Mr. E. B. Harper, of New York, who writes me that he never made any such statement as stated in the article in question. I did meet Mr. Greene on the train one day going to Albany, when he proposed an amendment (which I did not oppose), and I presumed that it would be offered in the Legislature at the proper time; but never heard of its being offered. These statements were circulated in Mr. Greene's district, but he was re-elected, although by a greatly reduced majority—the reasons for which are well known to both the gas companies and the Gas Consumers' Association. I have no personal feeling against Mr. Greene, notwithstanding the misstatements which have been circulated in his interest. The "History of a Legislative Shame," mentioned in your article, was made up from the letters and statements of unprejudiced newspaper correspondents, and others who were on the ground throughout the disgraceful scenes connected with the killing of the gas bills. These extracts tell their own story.

One of them wrote:

"To accomplish the defeat of the first bill there was more money used in the Legislature than since the time of the memorable Tweed regime, and whoever voted against the bill was justly regarded with suspicion of having received some of the money."

The New York *Evening Post* said:

"We doubt if there is an intelligent citizen in the State who does not know precisely what the cause was. The performance fixes the character of the majority of the Assembly as plainly as if a price mark had been affixed to their coat collars."

The *Mail and Express*, of May 11th, said:

"The citizens of the State, outside of its chief city, have no direct pecuniary interest in the fate of this measure; but they have a common interest in resisting the encroachments of monopoly and in preserving our institutions from the decay that is inevitable when corruption rules at the sources of political power."

This is the only interest I have in the matter; and if, after the facts are placed before them, political parties see fit to take the money of the gas companies and nominate and elect such men, I am sure that I can stand it if they can. It is an encouraging feature, however, for the political future of this country, and even for the permanent welfare of capital, that a majority of the members involved in the legislative corruption of last winter failed to secure a re-election,

Respectfully,

F. B. THURBER,

The Market for Gas Securities.

City gas shares have been somewhat neglected during the fortnight; but, generally speaking, values were well maintained. Consolidated shares enjoyed or experienced the usual sea-saw motion, having sold down as low as 97, and as high as 100. To-day (2 p.m., Dec. 14) sales were made at 100, and that figure may be given as the present ruling market rate. If the true inwardness of the quotations emanating from the regular Stock Exchange headquarters was exposed we venture the assertion that 75 per cent. of the sales reported as occurring below par in Consolidated gas represent the "washing" process. No possible combination of circumstances can occur that will prevent Consolidated shares from reaching 125 before the end of 1886. The Advisory Board of Equitable Company, of this city, have recommended that a dividend of 3 per cent. be paid to shareholders. Of course, there is nothing final in this, as the board of directors must confer, adopt and confirm the recommendation. It is likely that they will assent to the proposition. The new stock will not participate, since it is not yet "full paid." Mutual is strong; Equitable, old stock, shows no change. Brooklyn shares are inclined to weakness, save and except Metropolitan and Nassau. Washington (D. C.) stock is strong; the same remark applies to the old Chicago Company's shares.

Advertisers Index.

Table listing various categories such as Gas Engineers, Gas Works Apparatus and Construction, Processes, Gas and Water Pipes, Scrubbers and Condensers, Regenerator Furnaces, Gas Engines, Gas Governors, Retorts and Fire Brick, Cements, and Gas Stoves, with corresponding page numbers.

Table listing various categories such as Gas Enrichers, Gas Meters, Exhausters, Gas Coals, Valves, Gas Lamps, Gas Kilns and Ovens, Purifier Screens, Street Lamps, Burners, and Purifying Material, with corresponding page numbers.

Table listing categories such as Pipe Coverings, Gas Fixtures, Steam Pumps, Shafting, Pulleys, Etc., Steam Engines, and Hydraulic Main, with corresponding page numbers.

GEROULD'S IMPROVED RETORT CEMENT. Used by most of the Gas Companies of the United States with perfect satisfaction. Manufactured by C. L. GEROULD, Manchester, N. H. N. B.—As Manchester is a shipping point, all freight can be shipped as cheaply as from Boston or New York.

Advertisement for 'THE GLOBE STREET LAMP' and 'MINER'S PATENT STREET LAMPS', featuring an illustration of a street lamp.

Are adapted for use of Streets, Parks, Depots, Ferries, & Private Grounds. WITH POSTS OR BRACKETS. Jacob G. Miner, No. 823 Eagle Ave., New York N. Y.

Advertisement for 'Gas Companies, Notice!' featuring 'ARC AND INCANDESCENT GAS LAMPS'. Production of GEO. H. GREGORY, Gas Export. GAS LAMPS THAT ARE DANGEROUS RIVALS TO THE ELECTRIC LIGHT. Every Gas Company should be interested in the sale of these Lamps, which have reached the enormous sale of 5,000 within four months. U. S. GAS LAMP MFG. CO., 58 Barclay St., N. Y. GEO. H. GREGORY, Manager.

Advertisement for 'CHURCH'S REVERSIBLE SCREEN FOR GAS PURIFIERS'. Very Durable Easily Repaired. Oval Slats, with Malleable Iron Cross Bars. Apply to JOHN CABOT, LAWRENCE, MASS. PATENTED JULY 9, 1878. References in all parts of the country. Send for circular and list of companies who now have the Screen in use.

NATIONAL GAS LIGHT AND FUEL COMPANY,

Sole Owners and Licensees of the Springer Patent Cupola and Process for the U. S.,

Chicago.

Builders, Lessees, and Purchasers of

GAS WORKS

UNDER THE

Springer Cupola Gas Generating System.

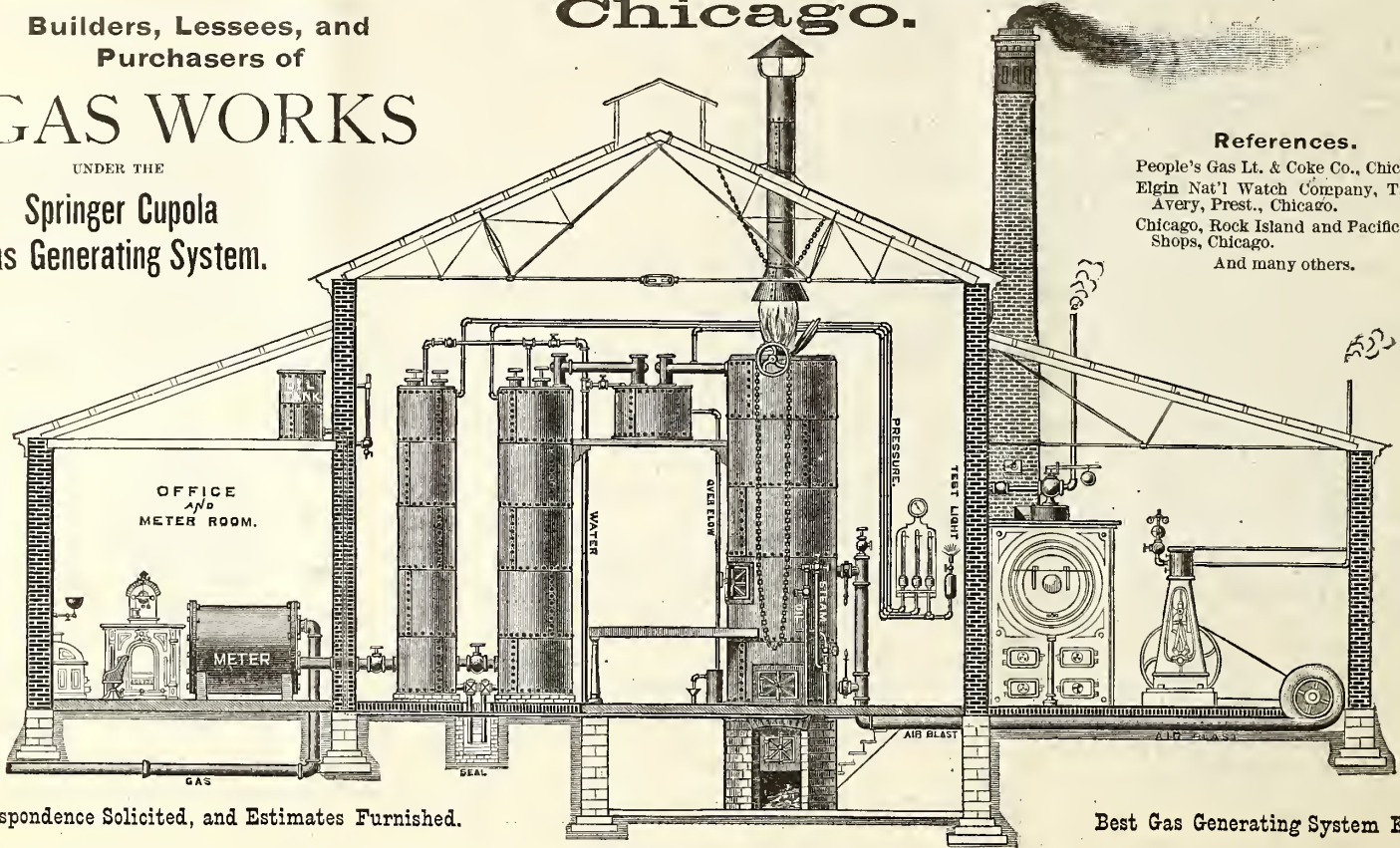

References.

- People's Gas Lt. & Coke Co., Chicago.
- Elgin Nat'l Watch Company, T. M. Avery, Prest., Chicago.
- Chicago, Rock Island and Pacific Ry. Shops, Chicago.
- And many others.

Correspondence Solicited, and Estimates Furnished.

Best Gas Generating System Known.

Orders from Cities, Towns, and Public Institutions Promptly Executed. Address

NATIONAL GAS LIGHT AND FUEL COMPANY, - - - No. 162 Washington Street, Chicago, Ill.

BURDETT LOOMIS, HARTFORD, CONN.

Builder of Gas Works.

LOOMIS'S PATENT WATER GAS APPARATUS, FOR MAKING ILLUMINATING OR HEATING GAS FROM BITUMINOUS SLACK, ANTHRACITE COAL SCREENINGS, COKE, LIGNITE, OR WOOD.

More gas can be made with this apparatus, using **BITUMINOUS SLACK**, than by any other process using same amount of best quality Anthracite Coal, and with less oil. No clinker; no filling up of superheater with ashes, as they are separated from the coal in the process of blasting and easily removed. Plans and estimates furnished.

Taylor's AUTOMATIC GAS CHECK.

Pat. Sept., 1885. Just the thing for street lamps. No moving parts; only the gas moves, and checks it self by opposing currents; cannot get out of order or wear out; the cheapest and best of all governors. Samples, by mail, 10 cents. Send for circular.

G. TAYLOR, 60 Duane st., N. Y.

OFFICE 43 PARK PLACE WORKS 57, 59 AND 61 LEWIS ST. 60, 62, 64 & 66 Cannon ST. NEW YORK

Shafting, Pulleys, HANGERS.

F. Brown's Patent Friction Clutch.

Send for Illustrated Catalogue and Discount Sheet to

A. & F. BROWN,
No. 43 Park Place, New York City.

The Forest City Naptha Co.,
REFINERS OF
NAPTHA AND GASOLINES.

ALSO MANUFACTURERS OF

A Special Grade of Naptha for Gas Companies

FOR ENRICHING COAL GAS.

Correspondence solicited.

No. 43 Euclid Avenue, Cleveland, Ohio.

PIPE COVERINGS.



FIREPROOF, NON-CONDUCTING COVERINGS FOR

Steam Pipes, Boilers, AND ALL HOT SURFACES.

Made in sections three feet long. Easy to apply; light and cheap.

These Goods are used at the Continental Works, Brooklyn.

Asbestos Materials, Fibre, Braided Packing, and Cement.

CHALMERS-SPENCE COMPANY, 419 & 421 EIGHTH ST., N. Y.

CONNELLY'S AUTOMATIC GOVERNOR FOR STREET MAINS.

We give herewith a few late letters from gas companies using our Governor, and also a cut (exact reproduction) of two pressure sheets from the Quincy (Ill.) Gas Works. A careful inspection of the cut will reveal more concerning the Governor's accuracy and reliability than we could express in all the columns of the JOURNAL. It shows clearly that the Governor is endowed with more than human intelligence, and fully verifies a late remark of a certain "Western Member"—"Connelly's Governor is *brains in iron.*" At Quincy the stores close early, and on all week nights excepting Saturday the Governor begins to reduce the pressure at about 8:30 P.M.; but on Sunday evening (when the consumption is so light that the Governor puts on only 19-tenths pressure) it is *one-half hour later* beginning to reduce—its action being the reverse of that followed by nine out of ten intelligent managers under the same circumstances or conditions. Although the consumption is much less on Sunday nights than on others, the volume per hour remains the same until 9 o'clock, when the church lights are extinguished. The Governor thus shows a finer discrimination than human intelligence is capable of. We do not boast of what our Governors "can" or "will" do, but submit evidence of **WHAT THEY ARE DOING!** We now have 43 of these machines in practical operation, and experience has taught us that a machine so delicate and sensitive in its construction, liable to be placed under such widely varying conditions, *cannot be perfected on paper.* Our late improvements enable us to send out a Governor to *any works*, capable of being adjusted to any possible conditions or requirements after it is in place. A 20-inch Governor can be sent to one works and adjusted to hold 3-tenths day and 40-tenths night pressure, and its duplicate or counterpart may be sent to another works having same consumption and initial pressure, and be set to hold 10-tenths day pressure and 11-tenths night pressure—both working perfectly as desired. Such range of adjustment is absolutely necessary in an Automatic

Governor, not only to secure the desired action in the beginning, but to be prepared to meet the new conditions sure to follow the building of a heavier holder or a large increase in capacity of the mains. No Governor in this country or abroad, in use or illustrated on paper, is constructed with such a range of adjustment, and to secure it would require a radical change in principle.

Another important feature of our Governor *not found in others* is the *absolute impossibility of the valve sticking in its seat* and shutting off the gas. We do not permit the valve to *enter* its seat; it is so constructed that it bears at *right angles* on a knife-edge seat, and must fall away from it when its supporting pressure is reduced in the least degree. The great value of this feature will impress itself on the careful Gas Manager. In short, our experience has enabled us to meet every possible requirement in Automatic Governors (as the accompanying letters attest), and we can unhesitatingly guarantee every Governor sent out to give perfect satisfaction in every respect, or will remove same at our expense. It is useless for us at this late day to waste any words on the *economy* and *satisfaction* derived from such a machine; and no progressive Engineer or Superintendent would to-day plan a works without locating an Automatic Governor. As they are finely finished and highly ornamental, their proper place is in the Office or Meter Room. As one of these Governors will *save its cost* in a short time, no company should hesitate to place one. The more perfect distribution and satisfaction given consumers are additional advantages that cannot be estimated in dollars and cents. We publish below a few letters, and will publish others in the following numbers of the JOURNAL.

CONNELLY & CO., Ltd., 407 Broadway, N.Y.

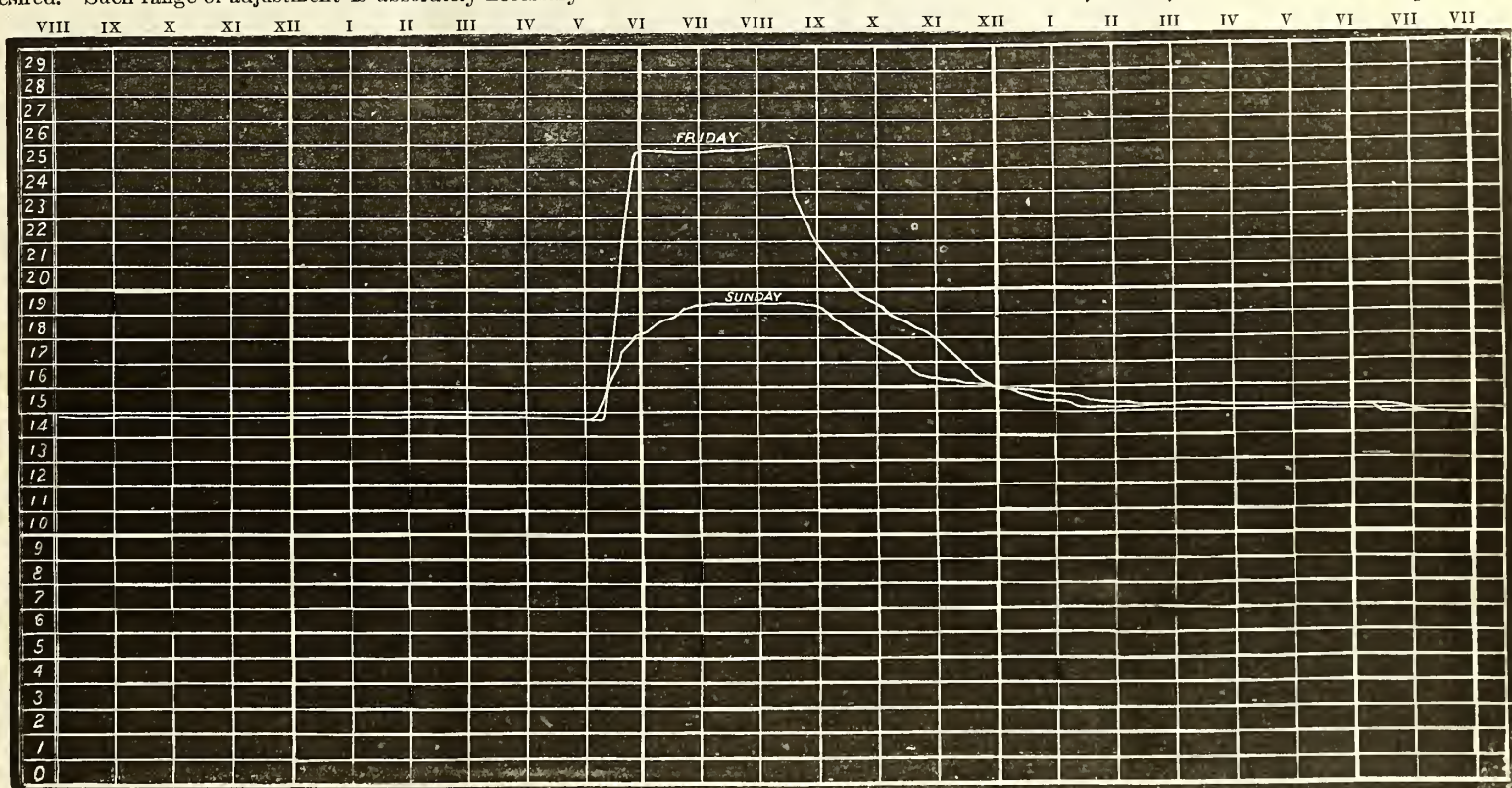

Card Showing Pressure at Quincy (Ill.) Gas Works, for Oct. 16th and 18th, 1885.

Augusta, Ga.

OFFICE GAS LT. CO. OF AUGUSTA, GA., Nov. 28, 1885.

Messrs. CONNELLY & Co.—Gentlemen: In reply to yours of 24th inst., we would say we have had your Automatic Governor in use about eight months. In that time it has always done its work well; it is no eye servant—it requires no watching; in fact, it is the only Automatic Governor that has ever come to my notice. Knowing its value as I do, I can honestly say I would not be without it if its cost was ten times as much. I look upon it as one of the very best investments I have ever made for my company.

Yours very truly, G. S. HOOKEY, Supt.

Greensburg, Ind.

GREENSBURG GAS LT. CO., GREENSBURG, IND., Oct. 17, 1885.

Messrs. CONNELLY & Co., LTD.—Dear Sirs: In answer to yours of the 15th, I will say that we are well pleased with our Governor, and would not do without it under any circumstances. It "fills the bill" in every respect.

Yours, W. S. SMITH, Supt.

Lima, Ohio.

LIMA GAS LT. CO., LIMA, OHIO, Nov. 7, 1885.

Messrs. CONNELLY & Co., LTD.—Gentlemen: In reply to yours of the 6th inst., would say that your Governor is giving entire satisfaction—doing all that you claim for it. Hoping this is satisfactory, I remain,

Yours respectfully, W. H. GIBSON, Supt.

Danville, Ill.

DANVILLE GAS LT. CO., DANVILLE, ILL., Nov. 9, 1885.

Messrs. CONNELLY & Co.—Gentlemen: In reply to yours of 7th inst., I would say that I have had one of your Automatic Governors in use about two months. Since setting up and adjusting it has required no attention

whatever except a little oil once a week. Thus far it has performed its work admirably, and always on time.

Yours respectfully,
J. H. WOODMANSEE, Supt.

Bethlehem, Pa.

BETHLEHEM GAS LT. CO., BETHLEHEM, PA., Nov. 1st, 1885.

Messrs. CONNELLY & Co.—Gentlemen: I wish to say to you that we are glad the delay occurred in the delivery of our Governor, inasmuch as you sent it with the new improvements added. It is a satisfaction to us to know that we waited exactly long enough before buying, and that we did buy exactly what we wanted.

Yours very truly, A. H. RAUCH, Supt.

Frankfort, Ky.

CAPITAL GAS AND ELECTRIC LT. CO., FRANKFORT, KY., Nov. 9, 1885.

Messrs. CONNELLY & Co., LTD.—Dear Sirs: Replying to your favor of the 7th inst., will say that we have been using one of your Improved Automatic Gas Governors for nine months, and find that it is just what it is represented to be—a perfect Automatic Governor. Respt. yours, S. J. SHEA, Supt.

Athens, Ohio.

ATHENS GAS LT. CO., ATHENS, OHIO, Nov. 9, 1885.

Messrs. CONNELLY & Co.—Gentlemen: Your favor inquiring after the working of the Connelly Governor received. It has now been in use more than a year, and we find it as recommended in every particular. It does all the work required of a Governor, and strictly *automatically*. I have not the first disadvantage to suggest, after a trial at all seasons of the year. We consider this investment the most profitable and economical of any about our works, and have recommended it to all inquirers. Our leakage account has been reduced one-half.

Yours very truly, C. H. WELCH, Supt.

THE CLERK GAS ENGINE.

Highest Award American Institute, New York, 1883. Silver Medal American Institute, N. Y., 1884.
Gold Medal Awarded Crystal Palace Electrical Exhibition, London, 1882.
Highest Award for Motive Power British Section International Exhibition of Electricity, Paris, 1881.

Reliable.
No Boiler.
Steady.
No Coal.
Simple.
No Ashes.
Compact.

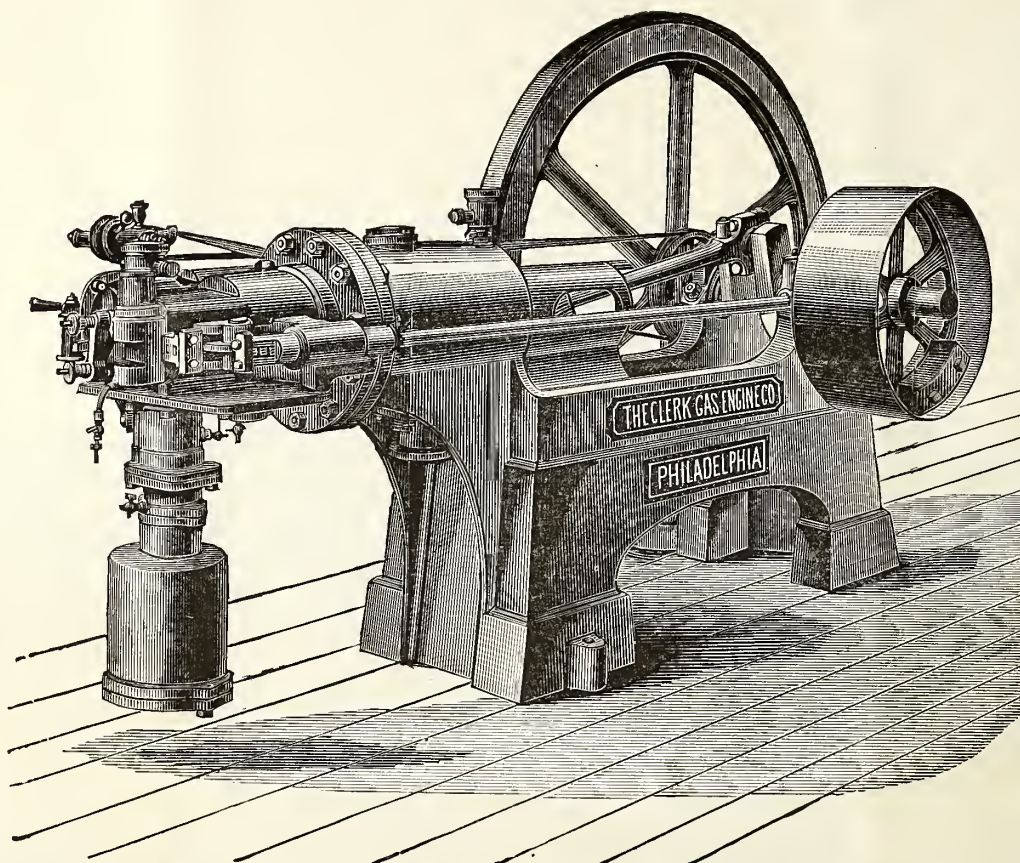

Economical.
No Engineer.
No Explosion
No Gearing
Wheels.
No Danger.
No Parts
requiring
frequent
renewal.

REQUIRING ONLY A MATCH TO START IT--GIVING ITS FULL POWER IMMEDIATELY.

We would inform the public that during the last few months we have improved THE CLERK GAS ENGINE to such an extent that we can now offer an engine vastly superior to our former pattern. These improvements have enabled us to sell our engine at a GREATLY REDUCED FIGURE, partly on account of the decreased weight (our engine weighing about half that of others giving the same Brake H. P). The consumption of gas has been decreased to a considerable extent, and the Brake H. P. has been increased some 25 to 30 per cent. All parts of the old design that were considered defective have been remodeled and new designs added. We now have an engine second to none as regards power, consumption, and ease of working. With our new engine all trouble in starting has been removed, the noise reduced to a minimum, and the regularity of motion is now all that can be desired. We guarantee all we claim for it, and the material and workmanship being of the best, enables us to guarantee the engine for twelve months.

SOLE MAKERS,

THE CLERK GAS ENGINE CO.,

WM. W. GOODWIN, President. E. STEIN, Secretary. S. LEWIS JONES, Asst. Secretary. L. P. GARRET, Supt.

Main Office, 1012-1018 Filbert Street, Philadelphia, Pa.

BRANCH OFFICES,

142 Chambers St., N. Y.

4 West Fourteenth St., N. Y.

76 Dearborn St., Chicago

General Agents,

THE GOODWIN GAS STOVE & METER CO.

Of Philadelphia, New York, and Chicago.

THE AMERICAN METER CO.,

MANUFACTORIES,

508 to 514 West Twenty-second St., N. Y. Arch and Twenty-second St., Phila.

Nos. 244 & 246 North Wells Street, Chicago, Ill.

AGENCIES,

No. 177 Elm Street, Cincinnati, Ohio. Nos. 122 & 124 Sutter Street, San Francisco, Cal.

No. 810 North Second Street, St. Louis, Mo.

NEW

INCANDESCENT

Gas Fires

AND

OPEN

Fire Place

Heaters.

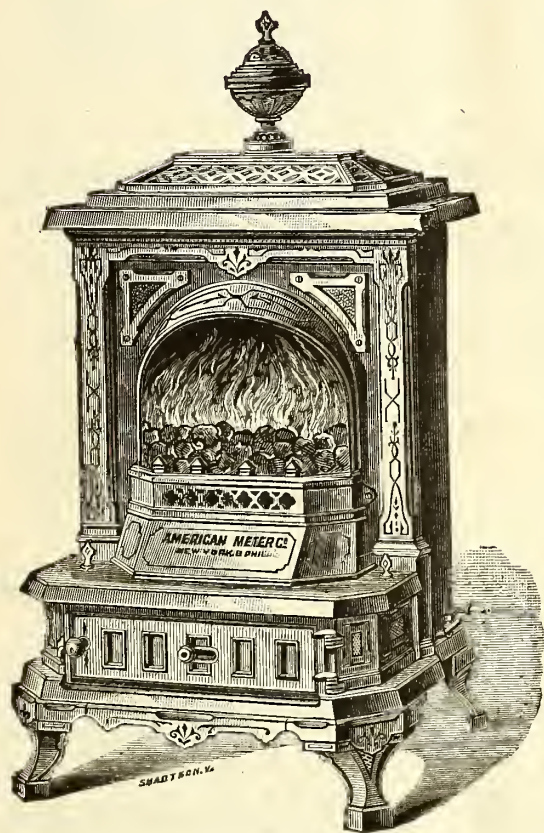

Open Fire Place Heater No. 19.
Fitted with the New Incandescent Gas Fire.



Open Fire Place Heater No. 17C.
Fitted with Illuminating Burners and Copper Reflector.

We call attention to Special Apparatus Heated by Gas for Manufacturing Purposes.

Gas Furnaces for Tinmen's use; Furnaces for melting Solder and Type Metal; Apparatus for bending Carriage Panels (in successful operation in Carriage Manufactories); Water Heaters for Kitchen Boilers, Baths, etc., and for attaching to Heating Coils and Pipes for Conservatories.

THE COMPANY MANUFACTURES

GAS STOVES FOR COOKING AND HEATING PURPOSES

In all Sizes, for Domestic, Restaurant, and Hotel Use.

These Stoves may be seen in operation at our Retail Store, No. 223 Sixth Avenue, N. Y. Call and examine.

SEND FOR CATALOGUE OF TWENTY DIFFERENT STYLES OF HEATING STOVES.

J. H. CAUTIER & CO.,

CORNER OF

GREENE AND ESSEX STREETS,
JERSEY CITY, N. J.

MANUFACTURERS OF

Clay Gas Retorts,
Gas House Tiles,
Fire Bricks, Etc. Etc.
Ground Clay, Fire Brick and
Fire Sand in Barrels,J. H. GAUTIER.
C. E. GREGORY.T. B. GAUTIER.
C. E. GAUTIER.**BROOKLYN**Clay Retort & Fire Brick Works,
(EDWARD D. WHITE & CO.)Manufacturers of Clay Retorts, Fire Brick,
Gas House and other Tile.VAN DYKE, ELIZABETH, RICHARDS & PARTITION STS.
Office, 88 Van Dyke St., Brooklyn, N. Y.**LACLEDE FIRE BRICK MFG. CO.,**

MANUFACTURERS OF

Fire Brick, Gas Retorts,

AND

ST. LOUIS STANDARD SEWER PIPE.

Blast Furnace and Cupola Linings, every description of Fire
Clay Material, Fire Clay Flue Linings, Chimney Tops
Dry Milled and Crude Fire Clays, etc.

OFFICE AND DEPOT

901, 903, and 905 Pine Street,
ST. LOUIS, MO.

ESTABLISHED IN 1845.

B. KREISCHER & SONS,

OFFICE FOOT OF HOUSTON ST., E.R., N. Y.

Gas Retorts,**TILES, FIRE BRICK.**

AND EVERYTHING IN THE FIRE CLAY LINE.

MANHATTAN

FIRE BRICK & ENAMELLED CLAY

RETORT WORKS.**ADAM WEBER.**

CLAY GAS RETORTS

AND RETORT SETTINGS

FIRE BRICKS, TILES, ETC.,

Office and Works, 15th Street and Avenue C., N. Y.



JAMES GARDNER, JR.

Works,

LOCKPORT STATION, PA.

—ESTABLISHED 1864.—

WILLIAM GARDNER & SON,

Successor to GARDNER BROTHERS.

WILLIAM GARDNER.

Office, COAL EXCHANGE,
PITTSBURGH, PA., P. O. Box 373.**Fire Clay Goods for Gas Works.**

C. H. SPRAGUE, No. 70 KILBY STREET, BOSTON, MASS., Agent for the New England States.

OFFICE, 418 to 422 East 23d St., New York.

ESTABLISHED 1856.

WORKS, PERTH AMBOY, NEW JERSEY.

HENRY MAURER,**Excelsior Fire Brick & Clay Retort Works**

CLAY GAS RETORTS, BENCH SETTINGS, FIRE BRICK, TILES, ETC.

STANDARD GAS RETORT AND FIRE BRICK COMPANY,

J. ANDERSON, PRES. & MANG'R.

OF IRONTON, OHIO.

C. PETERS, SECRETARY.

Clay Gas Retorts, Fire Brick, and Fire Clay Goods of Every Description.

Plans of Livesey-Somerville, Melhenny, and other Furnaces, and Competent Workmen Supplied.

CHICAGO

Retort & Fire Brick Works,

OFFICE AND FACTORY.

Clark, Forty-Fifth, and La Salle Streets,
CHICAGO, ILL.

GEORGE C. HICKS, PRES. PAUL P. AUSTIN, SEC. & TREAS.

STANDARD

Clay Retorts and Settings.

BLOCKS & TILES

of every Shape and Size to Order.

Standard Fire Bricks.

NEWBIGGING'S

Gas Manager's Handbook.

Price, \$4.80.

EVERY GAS MAN SHOULD HAVE ONE.

Orders may be sent to this Office.

OAKHILL

GAS RETORT & FIRE BRICK

COMPANY.

PARKER, RUSSELL & CO.

City Office, 711 Pine Street,

ST. LOUIS, MO.

Our immense establishment is now employed almost entirely in
the manufacture of

MATERIALS FOR GAS COMPANIES.

We have studied and perfected three important points. Our re-
torts are made to stand changes of temperature, the strongest
heats of the furnace, and the abrasion of feeding and emptying.
Our customers are in almost every State of the Union, to all of
whom we refer.

THOS. SMITH, Prest.

AUGUST LAMBLA, Vice-Prest. & Sup

BALTIMORE**RETORT & FIRE BRICK CO.**

MANUFACTORY AT

LOCUST POINT, BALTIMORE, MD.

Connection with the City by Telephone.

Clay Retorts, Blocks & Tiles,

FIRE BRICK, FIRE CLAY,

AND FIRE CEMENT.

Red and Buff Ornamental Tiles and Chim-
ney Tops. Drain and Sewer Pipe (from
2 to 30 inches). Baker Oven Tiles
12 x 12 x 2 and 10 x 10 x 2.

WALDO BROS., 88 WATER ST., BOSTON, MASS

Sole Agents for New England States

EVENS & HOWARD,
916 Market St., St. Louis. Mo.
Works, Howard Station, Mo. Pacific R.R.

Fire Brick, Gas Retorts

AND
RETORT SETTINGS.

Sewer Pipe, 3 to 24 in. diameter.
Glass Pot Clay, Ground Fire Clay, in barrels and in bulk. All kinds of Fire Clay Goods.

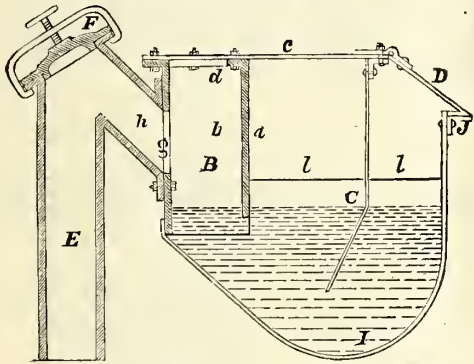

Boardman Hydraulic Main,

Patented October 7, 1884.

For description, see AM. GAS LIGHT JOURNAL of Feb. 2, 1884.
For terms, apply to

A. E. BOARDMAN, Macon, Ga.

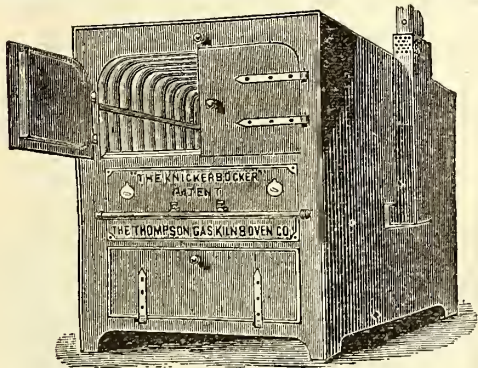

"The Knickerbocker" Portable Gas Oven,
ON EXHIBITION AT AMERICAN INSTITUTE FAIR.

Thompson Gas Kiln & Oven Co.

59 Carmino St., N. Y.

Send for Circular by mail.

MITCHELL, VANCE & CO.,

MANUFACTURERS OF

Chandeliers

and every description of

GAS FIXTURES.

Also manufacturers of Fine Gilt Bronzes and Marble Clocks,
warranted best time-keepers. Mantel Ornaments, etc.

Salesrooms, 836 Broadway, N. Y.

Special Designs furnished for Gas Fixtures for Churches, Public
Halls, Lodges, etc.

Iron Sponge,
GAS EXHAUSTERS,
AUTOMATIC GAS GOVERNORS,

CONNELLY & CO., Limited,
No. 407 BROADWAY, NEW YORK CITY.

C. BARCALOW, PREST.

J. V. BARCALOW, SEC. & TREAS.

BARTLETT
Street Lamp Mfg. Co.

MANUFACTURERS OF

Bartlett's Patent

GLOBE LAMPS.

FOR

Streets, Parks, Railroad Stations, Public
Buildings, Etc.

LAMP POSTS A SPECIALTY.

Office and Salesroom,

No. 35 Howard Street, N. Y. City.

Gas Companies and others intending to erect lamps and posts
will do well to communicate with us.

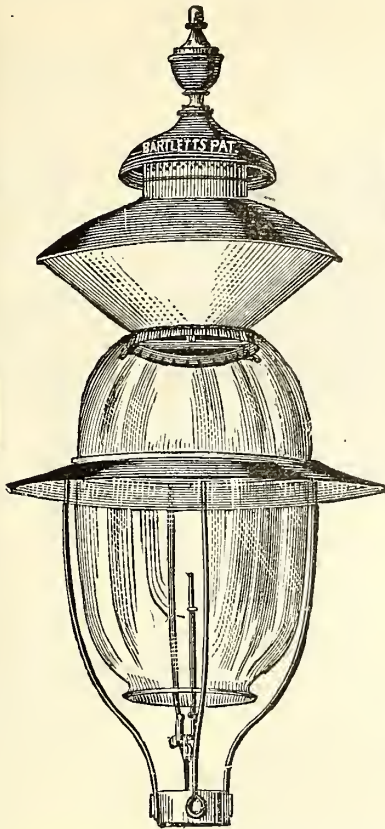

F. M. ROOTS.

S. C. ROOTS

D. T. ROOTS.

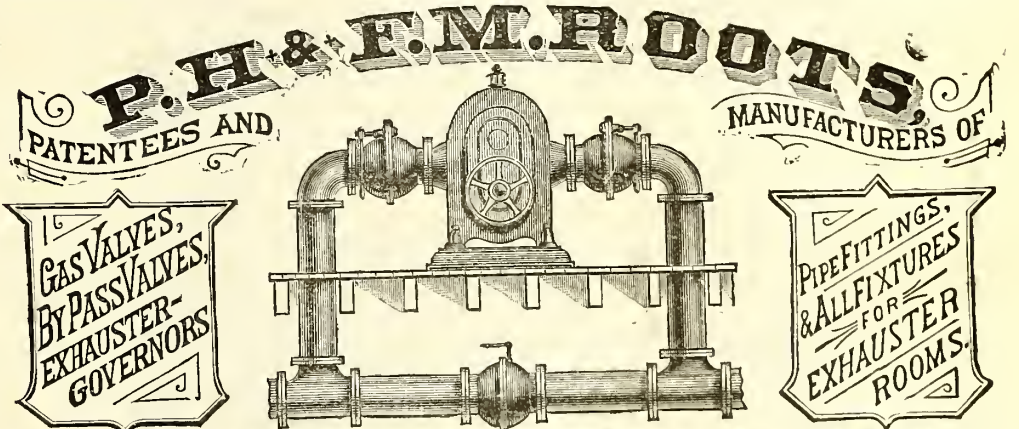

IMPROVED GAS EXHAUSTER,

WITH ENGINE ON SAME BED PLATE, OR WITHOUT.

BYE-PASSES, GAS VALVES, GOVERNORS, ELBOWS, PIPE-FITTINGS, Etc., FURNISHED TO ORDER,

P. H. & F. M. ROOTS, Patentees & Manufacturers, **CONNERSVILLE, IND.**

S. S. TOWNSEND, General Agent, 22 Cortland St. and 9 Dey St., N. Y.

JAS. BEGGS & CO., Selling Agents, 9 Dey St., N. Y.

COOKE & CO., Selling Agents, 22 Cortland St., N. Y.

✻ SEND FOR ILLUSTRATED CATALOGUE AND PRICE LIST. ✻

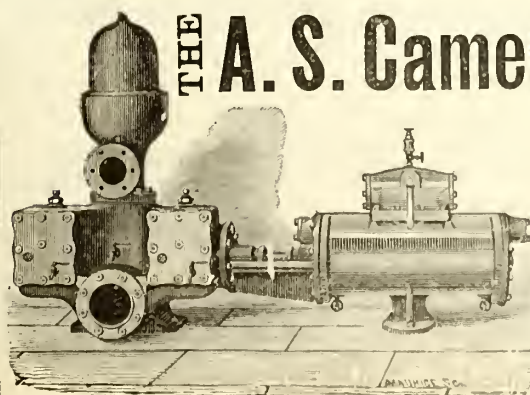

THE A. S. Cameron Steam Pump,

THE STANDARD OF EXCELLENCE.

Upward of 30,000 in Use.

BEST GAS WORKS PUMP
Ever Introduced.

Adapted to Every Possible Duty.

A. S. Cameron Steam Pump Works,

Foot East 23d St., N. Y.

A. H. M'NEAL,

BURLINGTON, N. J.

Flange-Pipes

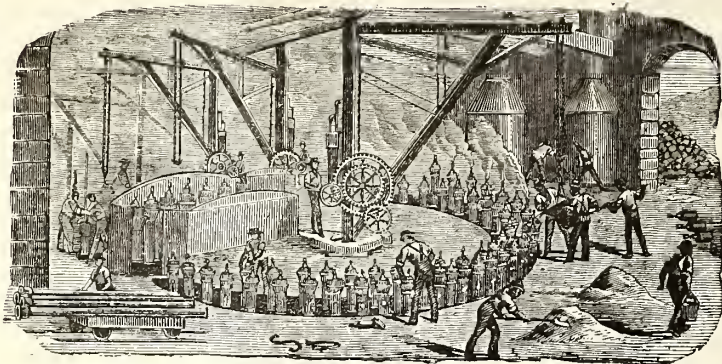

General Foundry Work.

CAST IRON PIPES FOR WATER AND GAS.

JAMES S. MOORE, Pres.
BENJAMIN CHEW, Treas.

JAS. P. MICHELLON, Sec.
WM. SEXTON, Supt.

GLOUCESTER IRON WORKS, GLOUCESTER CITY, N. J.

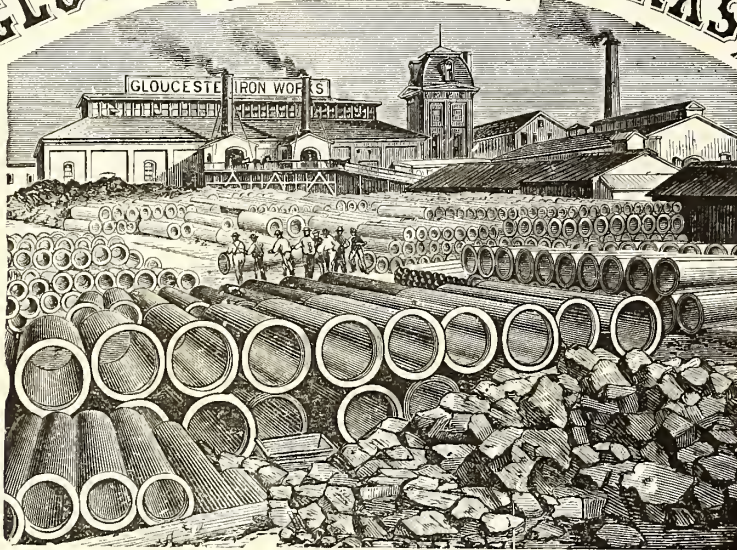

Cast Iron Gas & Water Pipes, Stop Valves, Fire Hydrants, Gasholders. &c.
Office No. 6 North Seventh Street, Philadelphia.

ESTABLISHED 1856.

WARREN FOUNDRY AND MACHINE CO.,

WORKS AT PHILLIPSBURGH, N. J.
NEW YORK OFFICE, 162 BROADWAY.

Cast Iron Water and Gas Pipe

FROM TWO TO FORTY-EIGHT INCHES DIAMETER.
ALSO ALL SIZES OF

FLANGE PIPE for Sugar House and Mine Work.
Branches, Bends, Retorts, Etc., Etc.

436-1

MATTHEW ADDY, President.

W. L. DAVIS, Selling Agent.

GEO. P. WILSHIRE, Sec. & Treas.

Cincinnati and Newport Iron and Pipe Company,

NEWPORT, KY.

Lamp Posts
AND
BENCH CASTINGS

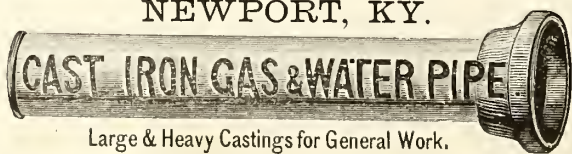

Branch
AND
SPECIAL CASTINGS

FOR GAS & WATER CO'S.

A Specialty.

Large & Heavy Castings for General Work.

Manufacture Pipe from 2 to 48 inches. All work guaranteed first quality.

ARNOLD MELLERT, Chairman. P. D. WANNER, Sec. & Treas.
MELLERT FOUNDRY & MACHINE CO., Ltd.,
Reading, Pa.



Specials—Flange Pipe, Valves and Hydrants,
Lamp Posts, Retorts, etc.

NEW YORK OFFICE,

FOX & DRUMMOND, - 160 Broadway.

CAST IRON

Gas and Water Pipes,

From 2 to 48 Inches in Diameter.

FOX & DRUMMOND,

160 Broadway, N. Y. City.

THE OHIO PIPE COMPANY,

MANUFACTURERS OF

Cast Iron Gas & Water Pipe,

BRANCH AND SPECIAL CASTINGS.

Gas-House Bench Castings, Hydraulics, Lamp Posts, Flange Pipe
and Specials, Architectural Castings, Building Columns,
Joists, Cellar Grates, Sash Weights, etc.

GENERAL FOUNDERS AND MACHINISTS.

Columbus, Ohio.

LUDLOW VALVE MFG. CO.

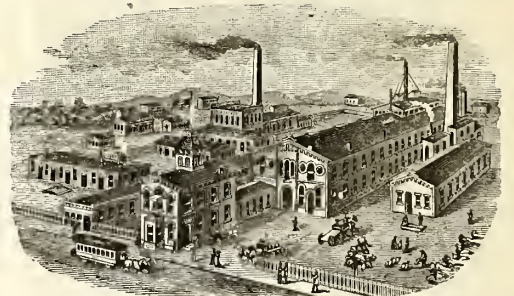

OFFICE AND WORKS,

938 to 954 River Street and 67 to 83 Vail Av.
TROY, N. Y.

Hydraulic Main Dip Regulators, also
Check Valves, Foot Valves, Yard-
wash and Fire Hydrants.
Send for Circulars.

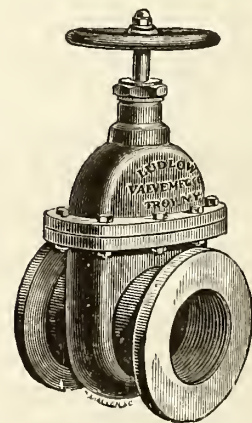

Valves.—Double and Single Gate, 1/2 in. to
48 in., outside and inside Screws. Indica-
tor, etc., for Gas, Water, Steam, and Oil.
and for Circulars.

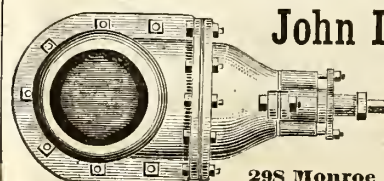

John McLean

Manufacturer of

**GAS
VALVES.**

298 Monroe Street, N. Y.

Siemens's Regenerative Gas Burners, For Lighting and Ventilating.

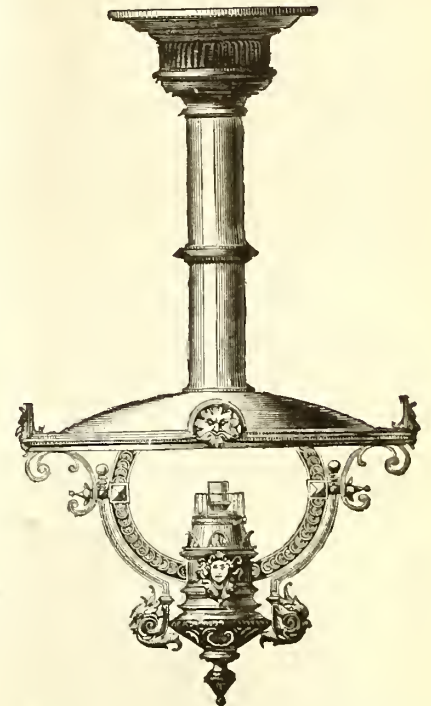
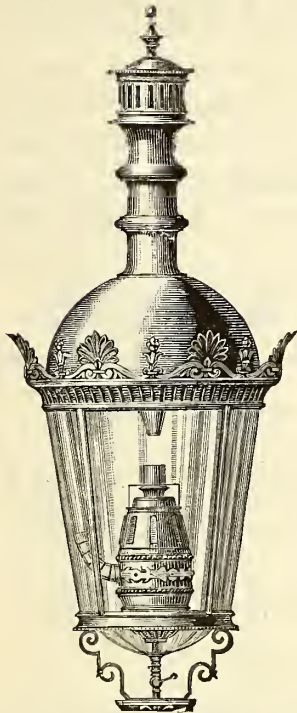

THE CHEAPEST, PUREST, AND MOST BRILLIANT OF ALL GAS LIGHTS.

Superior to the Electric Light in Economy, Beauty, & Steadiness.

SPECIALLY ADAPTED FOR LIGHTING HALLS, FACTORIES, OPEN SPACES, ETC.

Numerous Tests made by various Gas Companies in the United States show an Efficiency of Ten Candle Power per Cubic Foot of Gas.

General Agents:

- SIEMENS LIGHTING CO., 347 West Main St., Louisville, Ky.
- MEYER, MARSHALL & CO., 528 California St., San Francisco.
- DENNEHY, WOLF & O'BRIEN, 85 & 87 Dearborn St. Chicago, Ill.
- WILCOX & McGEARY, - No. 11 Bissel Block, Pittsburgh, Pa.
- T. T. RAMSDALL & CO., - 20 Swan Street, Buffalo, N. Y.
- SIEMENS GAS ILLUMINATING CO.,
Room 6, No. 157 Broadway, New York City.
- W. D. COLT, - - - - 1420 F Street, Washington, D. C.
- JOHN KIEFER, - - - 344 Lawrence, Street, Denver, Col.

THE SIEMENS REGENERATIVE GAS LAMP COMPANY,
SOLE MAKERS FOR THE UNITED STATES,
N. E. Cor. 21st. St. and Washington Av., Philadelphia, Pa.

THE "STANDARD" WASHER-SCRUBBER, KIRKHAM, HULETT & CHANDLER'S PATENT.

Total Capacity per 24 Hours of "Standard" Washers Ordered During the Following Years.

1877.....	4,000,000	cubic feet.
1878.....	4,750,000	"
1879.....	24,545,000	"
1880.....	42,967,500	"
1881.....	36,462,500	"
1882.....	39,300,000	"
1883.....	57,735,000	"
1884.....	28,177,500	"
Total.....	235,937,500	cubic feet.

Total Number and Capacity per 24 Hours of "Standard" Washers Erected and in Course of Erection in the Several Countries

	Number.	Cubic Feet per Day.
Great Britain.....	151	157,070,000
Western Hemisphere.....	38	39,337,500
Australia.....	18	12,150,000
New Zealand.....	2	650,000
France.....	6	4,550,000
Belgium.....	8	5,420,000
Germany.....	16	8,200,000
Holland.....	4	4,160,000
Denmark.....	1	150,000
Russia.....	2	3,500,000
Spain.....	1	350,000
India.....	1	400,000
Total.....	248	235,937,500

**THE CONTINUED POPULARITY
Of these Machines**

Will be recognized from the following extracts from letters from representatives of some of the companies having them in use:

OFFICE METROPOLITAN GAS CO., N. Y. CITY.
We have had the "Standard" Washer Scrubber you furnished to us in action since August, 1882. The ammonia liquor derived from it has a strength of from 12 to 20 oz. Twaddle, and it works uninterruptedly and satisfactorily.

OSCAR ZOLLIKOFFER, Prest.
Dr. E. G. Love, official Gas Examiner for New York city, reported Metropolitan gas for quarter ending June 30th, 1885, as follows: Illuminating power, 25.04; ammonia, grains in 100 cu. ft., 2.46.

LACLEDE GAS WORKS,
St. Louis, Mo. Nov. 25, 1884. }
The "Standard" is performing its work to our entire satisfaction. It has passed and freed from ammonia 30 per cent. more gas than it was rated as being able to pass. The test paper shows not a trace of ammonia.

FREDERIC EGNER, Eng. and Supt.

"Standard" Washers Ordered Recently.

	Cu. Ft. per Day
Amberg Gas Co.....	200,000
Bombay Gas Co.....	400,000
Brussels Co.....	1,250,000
CHICAGO, IACO, 1,000,000 each.....	2,000,000
Chemnitz Gas Co.....	1,000,000
CITIZENS GAS CO., BUFFALO.....	750,000
Coke Works in Zabre, Ober-Schlesien.....	1,500,000
Cokerei der Friedenshutte, Upper Silesia.....	700,000
Dumfries Corporation.....	250,000
Dunedin Gas Co., New Zealand.....	400,000
GEORGETOWN, D. C.....	250,000
King's Lynn Gas Co.....	300,000
Leiden, Holland.....	600,000
Lincoln Gas Co.....	400,000
Liverpool Gas Co.....	2,000,000
".....	3,000,000
LOUISVILLE GAS CO.....	1,500,000
MUTUAL GAS CO., BUFFALO.....	750,000
MINNEAPOLIS GAS CO.....	1,000,000
Nimica Gas Co.....	100,000
PITTSBURGH GAS CO.....	1,500,000
PAWBUCKET, R. I.....	500,000
PORTLAND GAS CO., OREGON.....	562,500
SAN FRANCISCO GAS CO.....	4,000,000
Sheepbridge.....	40,000
ST. LOUIS GAS CO.....	2,000,000
Sydney Gas Co.....	2,500,000
WASHINGTON, D. C. GAS CO.....	2,000,000
Whitechurch Gas Co.....	175,000
Total.....	29,677,500

GEO. SHEPARD PAGE, No. 69 WALL STREET, NEW YORK,
SOLE AGENT FOR THE WESTERN HEMISPHERE.

R. D. WOOD & CO.,

400 Chestnut Street, Phila., Pa.

Cast Iron Gas & Water Pipe, Water Machinery & Gas Apparatus

Cast Iron Pipe, Fire Hydrants, Eddy Valves, Lamp Posts, Large Loam Castings, Flanged Pipe, Sugar House Work, Iron Roofs and Floors, Wrought & Cast Iron Tanks, Turbine Water Wheels and Pumps.

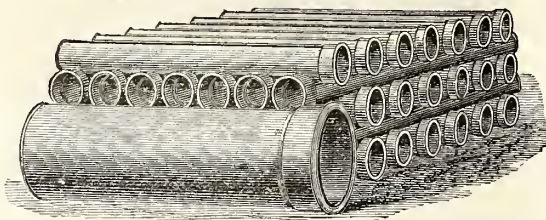

Casholders, Lime Trays, Center Valves, Purifiers, Bench Work, Exhausters, Condensers, Governors, Scrubbers, Gas Valves, Station Meters, Cast Iron Pipe Fittings.

Manufacturers of Heavy Castings and Machinery of Every Description.

ENGINEERS & CONTRACTORS FOR THE ERECTION OF GAS WORKS, & ALL MACHINERY CONNECTED THEREWITH.

Estimates and specifications furnished for erection of new works or the extension or alteration of old ones.

Foundries and Works. - - Millville, Florence, and Camden, N. J.

W. E. TANNER, Pres. W. R. TRIGG, Vice-Pres. A. DELANEY, Supt.

Tanner & Delaney Engine Co.,
RICHMOND, VA.

GAS APPARATUS,

INCLUDING

Condensers of Various Styles

SCRUBBERS, PURIFIERS, HOLDERS,

Castings for Retort Houses, Etc.

ALSO STEAM ENGINES AND BOILERS.

Plans, Specifications, and Estimates Furnished.

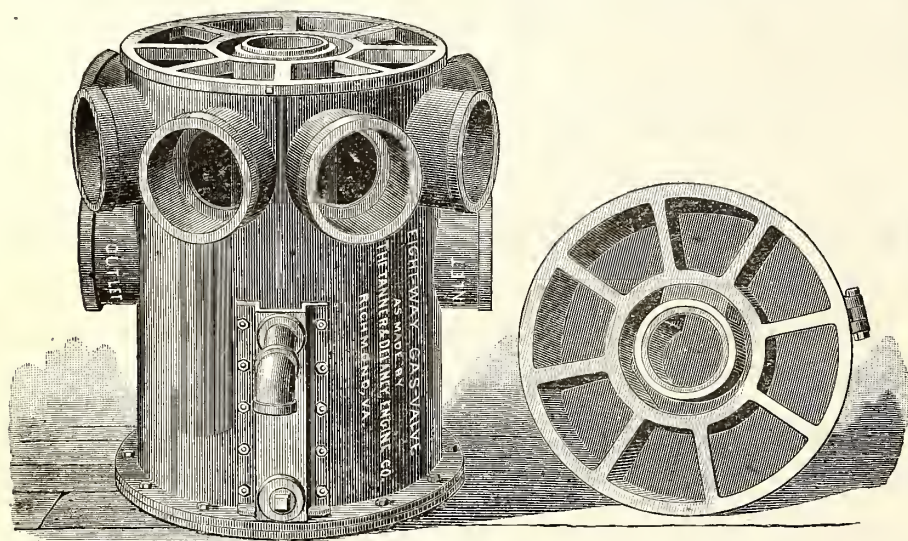
**SOUTHWARK FOUNDRY AND MACHINE COMPANY,**

Successors to MERRICK & SONS. Established in 1836.

No. 430 Washington Avenue, Philadelphia, Pa.

MANUFACTURERS OF

Single and Telescopic Gasholders,

BENCH CASTINGS,

Washers, Scrubbers, Condensers, Purifiers,

And all apparatus necessary for the construction of improved new gas works and in the extension of established works. Also manufacturers of

Gas Engines, and of all descriptions of Steam and Hydraulic Machinery, and of Boiler and Tank Work.

Plans, specifications, and estimates furnished promptly on application.

JOS. R. THOMAS, C.E.,

May be Consulted on all Matters Relating to Gas Works and Gas Manufacture.

ADDRESS THIS OFFICE.

WM. FARMER, ENGINEER,

32 Park Place, Room 36, New York.

THE CHEMIST'S ASSISTANT; OR, KINDERGARTEN SYSTEM OF CHEMISTRY.

A system by which the elements and their valences are represented by illustrations and solid bodies.

BOX AND PAMPHLET COMPLETE, \$2.50.

MORRIS, TASKER & CO.,

Limited,

Builders of Gas Works,

PHILADELPHIA, PA.

To Gas Companies.

We make to order **CAP BURNERS** to burn any amount under a stated pressure. Send for samples.

Also, **SERVICE CLEANERS, DRIP PUMPS,** and **STREET MAIN PROVING APPARATUS.**

C. A. GEFROER,

248 N. 5th Street, Phila., Pa.

WM. HENRY WHITE,

Consulting & Constructing

Gas Engineer & Contractor.

ESTIMATES, PLANS, AND SPECIFICATIONS FURNISHED FOR NEW WORKS OR EXTENSIONS OF EXISTING WORKS.

32 Pine St., New York City.

Correspondence solicited.

KERR MURRAY MFG. CO.,

MANUFACTURERS OF

Single Lift and Telescopic

GASHOLDERS.

Built, 1884:

Altoona, Pa.....	Capacity, 100,000 cubic feet.
Pittsburgh, Pa.....	" 250,000 "
" ".....	" 220,000 "
Bellaire, Ohio.....	" 50,000 "
Youngstown, Ohio.....	" 60,000 "
Canton, ".....	" 60,000 "
Akron, ".....	" 80,000 "
Xenia, ".....	" 10,000 "
Adrian, Mich.....	" 65,000 "
Ypsilanti, Mich.....	" 25,000 "
Muskegon, ".....	" 70,000 "
South Bend, Ind.....	" 70,000 "
Anderson, ".....	" 20,000 "
Plainfield, ".....	" 10,000 "
Springfield, Illinois.....	" 100,000 "
Evanston, ".....	" 50,000 "
Freeport, ".....	" 35,000 "
Elgin, ".....	" 60,000 "
Sheboygan Wis.....	" 20,000 "
Key West Fla.....	" 10,000 "

Plans and estimates furnished for the erection of new and the rebuilding of old works. Address

Kerr Murray Mfg. Co.,

FORT WAYNE, IND.

JAMES R. FLOYD,

(SUCCESSOR TO HERRING & FLOYD)

Oregon Iron Works,

531 to 543 West 20th St., N. Y.

Practical Builders of Gas Works,

MANUFACTURERS OF

ALL KINDS OF CASTINGS
AND
APPARATUS FOR GAS-WORKS.

BENCH CASTINGS

from benches of one to six Retorts each.

WASHERS: MULTITUBULAR AND AIR CONDENSERS; CONDENSERS; SCRUBBERS

wet and dry), and

EXHAUSTERS

for relieving Retorts from pressure.

BENDS and BRANCHES

of all sizes and description.

FLOYD'S PATENT MALLEABLE RETORT LID.

PATENT SELF-SEALING RETORT LIDS.

FARMER'S PATENT BYE-PASS DIP-PIPE.

SABBATON'S PATENT FURNACE DOOR AND FRAME.

BUTLER'S COKE SCREENING SHOVELS.

GAS GOVERNORS,

and everything connected with well regulated Gas Works at low price, and in complete order.

SELLER'S CEMENT

for stopping leaks in Retorts.

N. B.—STOP VALVES from three to thirty inches—at very low prices.

Plans, Specifications, and Estimates furnished.

CONTINENTAL WORKS.

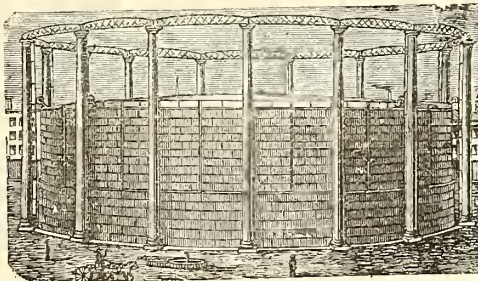

GASHOLDERS OF ANY MAGNITUDE.

T. F. ROWLAND, Proprietor,
GREENPOINT, BROOKLYN, N. Y.
ENGINEER AND MANUFACTURER OF
GAS-HOLDERS,
CONDENSERS, SCRUBBERS, VALVES,
PURIFIERS, RETORTS, and HY-
DRAULIC MAINS,

and all other articles connected with the Manufacture and Distribution of Gas. Plans and Specifications prepared and Proposals given for the necessary Plant for Lighting Cities, Towns, Mansions, and Manufactories.

H. RANSHAW, Prest. & Mangr. WM. STACEY, Vice-Pres. T. H. BIRCH, Asst. Mangr. R. J. TARVIN, Sec. & Treas.

STACEY MFG. CO.,

MANUFACTURERS OF

Single and Telescopic Gasholders,

IRON ROOFS, BRIDGES, LAMP POSTS,

Water and Oil Tanks, Coal Elevator Cars,
COKE CRUSHERS, BENCH CASTINGS,

And all kinds of Wrought and Cast Iron Work used in the erection of Coal and Oil Gas Works. Rolling Mill Machinery and Heavy Castings a Specialty.

Foundry:

33, 35, 37 & 39 Mill Street.

Wrought Iron Works:

16, 18, 20, 22, 24 & 26 Ramsey Street.

Cincinnati, Ohio.

BARTLETT, HAYWARD & CO.,

Office, 24 Light.

BALTIMORE, MD.

Works, Pratt & Scott.

PURIFIERS.

ROOFS.

Bench Castings.

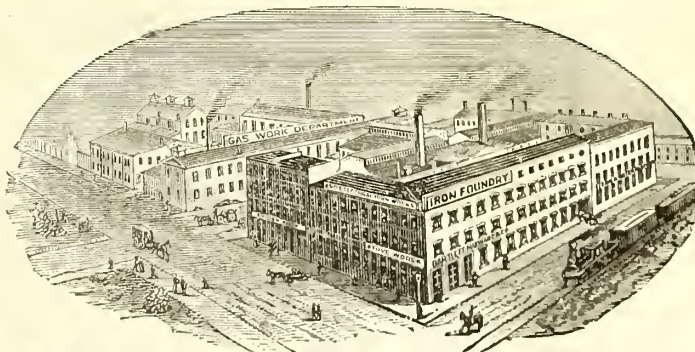

SCRUBBERS.

CONDENSERS.

GASHOLDERS.

CONSTRUCTING ENGINEERS AND BUILDERS OF GAS WORKS.

1842. **DEILY & FOWLER,** 1885.

Laurel Iron Works.

Address, No. 39 Laurel Street, Philadelphia, Pa.

MANUFACTURERS OF

GASHOLDERS,

Single or Telescopic, with Cast or Wrought Iron Guide Frames.

Holder Built Since 1880:

Mount Joy, Pa.	West Point, N. Y.	Galveston, Texas (2d.)	Kalamazoo, Mich. (3d.)	Newport, R. I.
Rockaway Beach, N.Y. (2)	Fitchburgh, Mass.	Marlboro, Mass.	Glen Island, N. Y.	Portland, Oregon.
Zanesville, O. (2d.)	New London, Conn.	Denver, Col.	Warren, Ohio.	Allegheny, Pa. (3d.)
Lancaster, O.	Derby, Conn.	Chicago, Ill. (West Side)	Bath, N. Y.	Atlanta, Ga. (2d.)
Blackwell's Island N. Y.	Bridgport, Conn.	Pittsburgh, Pa. (S. Side)	Lynn, Mass.	N.Y. City (Central Gas)
Waltham, Mass. (1st.)	Allegheny, Pa. (1st.)	Pawtucket, R. I.	New Bedford, Mass.	Lynchburg, Va. (2d.)
Dorchester, Mass.	St. Hyacinth, C. I.	Brookline, Mass.	Waterbury, Conn.	Saylesville, R. I.
Wheeling, West Va.	Norwalk, O.	Sherbrooke, Can.	Deseronto, Can.	Rondout, N. Y.
Lausling, Mich.	Brattleboro, V.	Burlington, N. J. (2d.)	Hoosic Falls, N. Y. (2d.)	Atlantic City, N. J.
Flint, Mich.	Waltham, Mas. (2d.)	Bridgeton, N. J.	Bethlehem, Pa.	Augusta, Ga.
Galveston, Texas (1st.)	West Chester, Pa.	Bay City, Mich.	Atlanta, Ga. (1s.)	Waltham, Mass. (2)
Milton, Pa.	Baltimore, Md.	Erie, Pa.	Savannah, Ga.	
Seranton, Pa.	Hollidaysburg, Pa.	Jackson, Mich.	Montgomery, Ala	

GAS COALS.

GAS COALS.

GAS COALS.

JAMES D. PERKINS.

PERKINS & CO.,

F. SEAVERN.

General Sales Agents for

The Youghioghenny River Coal Company's**OCEAN MINE YOUGHIOGHENY GAS COAL.**

The Coal from the Ocean Mine (recently operated by Messrs. W. L. Scott & Co., of Erie, Pa.,) is now used by all the leading Gas Companies in the United States from Maine to Texas, and is recognized as *the only reliable Youghioghenny Gas Coal.* (See Map on p. 87 of this Journal, Feb. 16, 1885.)

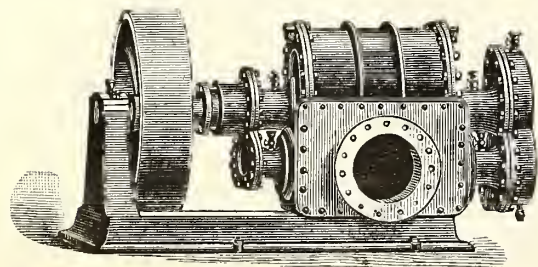
P. O. Box 3695,
New York.**PERKINS & CO., 228 and 229 N. Y. Produce Exchange****BEAVER STREET
ENTRANCE.**

Gas Exhauster Driven by Belt.

The Wilbraham Gas Exhauster,

"BAKER SYSTEM,"

WITH ENGINE ATTACHED, ON SAME BED PLATE OR WITHOUT.

Best, Cheapest and Most Durable Exhauster known.**WILBRAHAM BROS.,****No. 2320 Frankford Avenue, Philadelphia, Pa.****SMITH & SAYRE MFG. COMPANY,**

G. G. PORTER, Prest.

245 Broadway, N. Y.

CHAS. W. ISBELL, Sec'y.

Machinery & Apparatus for Gas Works

Drawings, Plans, and Estimates Furnished for the Improvement, Extension, or Alteration of Gas Works, or for the Construction of New Works.

Mackenzie's Patent Rotary and Steam Jet Gas Exhausters, Governors, Compensators, Condensers, Washers, Scrubbers. Isbell's Patent Automatic Street Pressure Governor, Gas and Water Valves, Hydraulic Main Dip Regulator, Bench Castings, etc. Purifying Boxes and "Standard" Scrubbers. Isbell's Patent Self-Sealing Retort Doors.

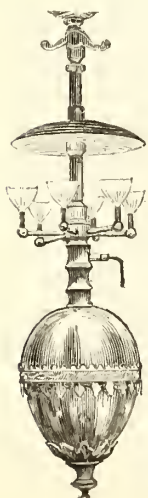
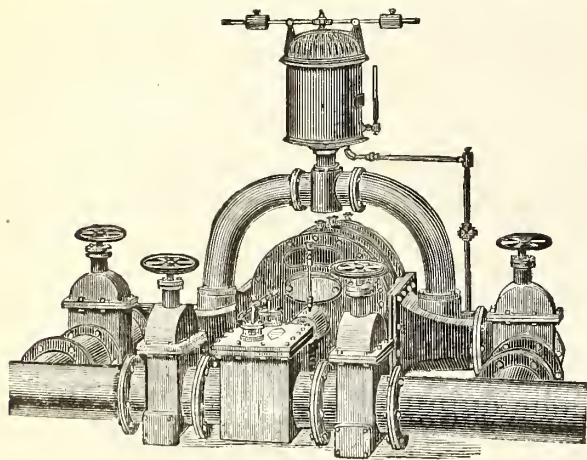
**THE ALBO-CARBON LIGHT!**

A new system of Carbureting heated Gas by means of a solid material, whereby its illuminating power is increased more than three-fold.

SUPERIOR TO ALL OTHER SYSTEMS FOR

Economy, Safety, Illuminating Power and General Practicability,

The Albo-Carbon process enables Gas Companies to supply a light equal to the Arc Light, at a much less cost. Several Gas Companies are now using this system. The process is extensively used in Europe, and is being rapidly adopted in this country.

The Albo-Carbon Light Co., - - Newark, N. J.

GENERAL AGENCIES:

1004 Walnut St., Philadelphia, Pa.
94 Fifth Avenue, Chicago, Ill.
522 Pine Street, St. Louis, Mo.

Law Buildings, Lexington Ave, Baltimore.
35 Federal Street, Allegheny, Pa. ●
120 S. Fourth Street, Minneapolis, Minn.

PATENTS.

FRANKLIN H. HOUGH,

Solicitor of American & Foreign Patents

925 F. ST., WASHINGTON, D. C.

(NEAR U. S. PATENT OFFICE.)

Personal attention given to the preparation and prosecution of applications for Letters Patent. All business before the U. S. Patent Office attended to for moderate fees. **No Agency in the United States possesses superior facilities for obtaining Patents,** or for ascertaining the patentability of inventions. Copies of patents furnished for 25 cents each. Correspondence solicited.

GAS COALS.

GAS COALS.

GAS COALS.

Newburgh Orrel Coal Co.,

MINERS AND SHIPPERS OF

**Newburgh Orrel, Tyrconnell
and Palatine Gas Coals.**

ALSO SHIPPERS OF FOUNDRY COKE.

Mines Situated at

Newburgh, Flemington & Fairmont, W.Va.

HOME OFFICE,

25 S. Gay St., Baltimore.

**CHARLES MACKALL,
MANAGER.**

CHAS. W. HAYS, Agent in New York,

Room 92, WASHINGTON BUILDING, No. 1 Broadway.

Shipping wharves at Locust Point. References furnished when required. Special attention given to chartering vessels.

THE DESPARD COAL COMPANY

OFFER THEIR SUPERIOR

DESPARD COAL

To Gas Light Companies and Manufacturers of Fire Clay Goods Throughout the Country.

ROUSSEL & HICKS, } AGENTS. { BANGS & HORTON,
71 Broadway, N. Y. } 16 Kilby St., Boston.

Mines in Harrison Co., West Va. Wharves, Locust Point, Balt.

Company's Office, 15 German St., Baltimore, Md.

Among the consumers of Despard Coal we name: Manhattan Gas Light Co., N. Y.; Metropolitan Gas Light Co., N. Y.; Jersey City, (N. J.) Gas Light Co.; Washington (D. C.) Gas Light Co.; Portland (Maine) Gas Light Co. Reference to them is requested.

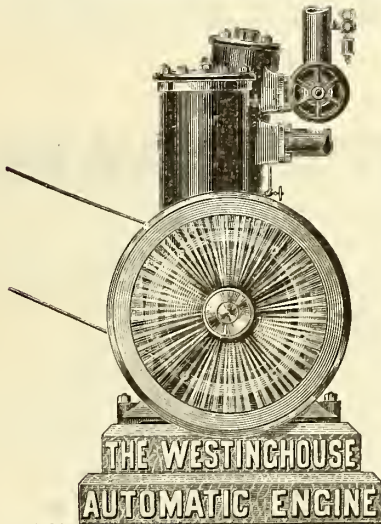

We have carefully investigated the Requirements of the various Manufactures with which we have been brought in contact, and have condensed much information in our Special Circular to

Saw and Planing Mills,
Paper Mills,
Rolling Mills,
Railway Applications,
Electric Lighting,
Cotton Ginning, Etc.

All free on application, by stating your business and requirements.

**Westinghouse Machine Co.,
PITTSBURGH, PA.**

SALES DEPARTMENT CONDUCTED BY

- Westinghouse, Church, Kerr & Co., 17 Cortlandt Street, New York City.
- Fairbanks, Morse & Co., Chicago, Cincinnati, Cleveland, Louisville, and St. Paul.
- Fairbanks & Co., St. Louis, Indianapolis, and Denver.
- Parke & Lacy, San Francisco, and Portland, Or.
- Parke, Lacy & Co., Salt Lake City, Utah, and Butte, Montana.
- D. A. Tompkins & Co., Charlotte, N. C.
- Keating Implement & Machine Co., Dallas, Texas
- Robert Middleton, Mobile, Ala.
- H. Dudley Coleman, New Orleans, La.
- Imray & Co., Sydney and Melbourne, Australia.
- R. Rogers, 43 Rue Laftite, Paris.
- F. E. Averill, Delft, Holland.
- Tomas G. Foley & Co., Buenos Ayres, S. A.

**THE
PENN GAS COAL CO.**

OFFER THEIR

Coal, Carefully Screened & Prepared for Gas Purposes.

Their Property is located in the Youghiogheny Coal Basin, near Irwin and Penn Stations on the Pennsylvania Railroad, and on the Youghiogheny River.

Principal Office:

209 SOUTH THIRD STREET, PHILA., PA.

Points of Shipment:

Pennsylvania Railroad Piers; Greenwich Wharves, Delaware River; Pier No. 1 (Lower Side), South Amboy, N. J.

Chesapeake & Ohio Railway Coal Agency,

FOR THE SALE OF THE

**Superior Kanawha Gas Coals, Cannelton Cannel,
Also, SPLINT AND STEAM COALS.**

From the Kanawha and New River Regions, on the line of the Chesapeake & Ohio R'way.

C. B. ORCUTT, Sales Agent. | OFFICE, 150 BROADWAY, N. Y.

FRANCIS H. JACKSON, PRESIDENT.

EDMUND H. MCCULLOUGH, SEC. & TREAS.

THE WESTMORELAND COAL CO.

Chartered 1854.

Mines situated on the Pennsylvania and the Baltimore and Ohio Railroads, in Westmoreland County, Penn.

POINTS OF SHIPMENT:

PHILADELPHIA, BALTIMORE, SOUTH AMBOY, N. J.,
WATKINS (SENECA LAKE), N. Y.

Since the commencement of operations by this Company its well-known Coal has been largely used by the Gas Companies of New England and the Middle States, and its character is established as having no superior in gas-giving qualities, and in freedom from sulphur and other impurities.

Principal Office, 224 South 3d St., Phila., Pa.

A. H. SCOTT, PRESIDENT.

A. DEMPSTER, C.E., SECRETARY.

W. A. GILLESPIE, TREASURER.

MONONGAHELA AND PETERS CREEK GAS COAL CO.,

PRODUCERS OF

Coal Bluff Gas Coal.

MINES LOCATED ON THE MONONGAHELA DIVISION OF THE PENNSYLVANIA RR., IN THE CENTRAL PORTION OF THE PITTSBURGH COAL FIELD.

Points of Shipment—Buffalo, Cleveland, Erie, Chicago, New Orleans.

Since the introduction of Coal Bluff Gas Coal it has taken rank among the few first-class Gas Coals, and acknowledges no superior in gas-giving qualities, ease of working, quality of coke, and freedom from impurities.

General Eastern Agents, ANDREW LANGDON & CO., Buffalo, N. Y.

Western Agents, - - - F. R. BUELL & CO., - Milwaukee, Wis.

General Office, 127 Fourth Ave., Pittsburgh, Pa.



INTERNATIONAL--1876--EXHIBITION.

The U. S. Centennial Commission

HAVE DECREED AN AWARD TO

HARRIS, GRIFFIN & CO.,

Twelfth and Brown Streets, Philadelphia, Pa., No. 49 Dey Street, N. Y. City, and No. 75 North Clinton Street, Chicago, Ill.,

FOR THE FOLLOWING REASONS:

The Exhibit consists of a Series of METERS from the Largest Size Station Meters for the use of the MANUFACTURE OF GAS, to those for the use of the ORDINARY CONSUMER. The Instruments are WELL MADE, RELIABLE as to INDICATION, and embody a number of sundry improvements which, with the general character of the Exhibit, entitle the whole to commendation

Attest—J. L. CAMPBELL,
Secretary, pro-tem

Signed—A. T. GOSHORN,
Director General

J. R. HAWLEY,
President

CHARLES E. DICKEY.

JAMES B. SMALLWOOD.

CHARLES H. DICKEY.

Maryland Meter and Manufacturing Co.,

DICKEY, TANSLEY & CO.,

Established 1866.

Nos. 22 and 24 Saratoga Street, Baltimore, Md.

No. 46 La Salle St., Chicago, Ill.

MANUFACTURERS OF

DRY GAS METERS, STATION METERS, GLAZED METERS, TEST METERS, METER PROVERS, PRESSURE AND VACUUM REGISTERS, GOVERNORS, INDICATORS, SERVICE AND METER COCKS, AND METER CONNECTIONS.

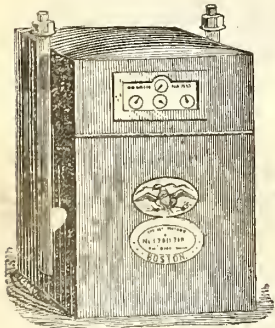

Dry Gas Meter.

With 39 years' experience and the best facilities for manufacturing, is enabled to furnish reliable work and answer orders promptly.

NATHANIEL TUFTS,

No. 153 Franklin Street, Boston, Mass.,

MANUFACTURER OF

DRY GAS METERS.

Station Meters of any Capacity.

Test and Experimental Meters, Pressure Registers, Pressure Gauges, Pressure and Vacuum Gauges.

METER PROVERS, PHOTOMETERS, STREET LANTERNS, ETC., ETC.

Patent Cluster Lanterns for Street Illumination.

SCIENTIFIC BOOKS.

We are prepared to furnish to Gas Managers, and others interested in the topics treated of, the following books, at prices named:

KING'S TREATISE ON THE MANUFACTURE OF COAL GAS. Three vols.; \$10 per vol.
GAS MANUFACTURE, by WILLIAM RICHARDS. 4to., with numerous Engravings and Plates, in Cloth binding. \$12.
THE GAS ANALYST'S MANUAL, by F. W. HARTLEY. \$2.50.
ANALYSIS, TECHNICAL VALUATION, PURIFICATION, and USE OF COAL GAS, by REV. W. R. BOWDITCH, M.A.; with Engravings; 8vo., Cloth. \$4.50.
GAS MEASUREMENT AND GAS METER TESTING by F. W. HARTLEY. \$1.60
GAS CONSUMER'S HANDBOOK, by WILLIAM RICHARDS, C.E.; 18mo., Sewed. 20 cents.

GAS CONSUMER'S MANUAL, by E. S. CATHELS, C.E. 10 cts.
PRACTICAL TREATISE ON HEAT, by THOMAS BOX. Second edition. \$5.
GAS WORKS—THEIR ARRANGEMENT, CONSTRUCTION, PLANT, AND MACHINERY. \$8.
COAL; ITS HISTORY AND USE, by PROF. THORPE. \$3.50.
THE GAS WORKS OF LONDON, by COLBURN. 60 cents.
THE GAS FITTER'S GUIDE, Showing the Principles and Practice of Lighting with Coal Gas, by JOHN ELDREDGE. 40 cents.
GAS WORKS, AND MANUFACTURING COAL GAS, HUGHES. \$2.20.
THE MANAGEMENT OF SMALL GAS WORKS, by C. J. R. HUMPHREYS. \$1.

A PRACTICAL TREATISE ON GAS AND VENTILATION with Special Relation to Illuminating, Heating, and Cooking by Gas, by E. E. PERKINS. \$1.25.
PURIFICATION OF COAL GAS, by R. P. SPICE. 8vo. \$3.
HOW TO MANAGE GAS, by F. WILKINS. Paper. 20 cents.
THE GAS MANAGER IN THE LABORATORY, by a Practical Student. 8vo., Cloth. \$1.50.
THE DOMESTIC USES OF COAL GAS, AS APPLIED TO LIGHTING, by W. SUGG. \$1.40.
DISTILLATION OF COAL TAR AND AMMONIACAL LIQUOR, by GEO. LUNGE. \$8.50.
A TREATISE ON THE COMPARATIVE COMMERCIAL VALUES OF GAS COALS AND CANNELS, by D. A. GRAHAM 8vo., Cloth. \$3.

The above will be forwarded by express, upon receipt of price. We take especial pains in securing and forwarding any other Works that may be desired, upon receipt of order. All remittances should be made by check draft, or post office money order.

A. M. CALLENDER & CO., No. 42 Pine Street, New York.

T. C. HOPPER, Pres. G. J. McGOURKEY, Vice-Pres. (New York). WM. N. MILSTED, Gen. Supt. & Treas. (New York). WM. H. DOWN Sec.

AMERICAN METER COMPANY,

WET AND DRY GAS METERS. STATION METERS. EXHAUSTER GOVERNORS. DRY CENTRE VALVES. GOVERNORS FOR GAS WORKS. PRESSURE REGISTERS. PRESSURE & VACUUM REGISTERS. PRESSURE & VACUUM GAUGES. CRESSON GAS REGULATORS. MARSLAND WATER METERS. METER PROVERS. PORTABLE TEST METERS. EXPERIMENTAL METERS. AMMONIA TEST METERS. BAR AND JET PHOTOMETERS.

Manufactories:
512 W. 22d St., N. Y.
Arch & 22d Sts., Phila.

GAS STOVES,
SUGG'S "STANDARD" ARGAND BURNERS,
SUGG'S ILLUMINATING POWER METER,
Wet Meters, with Lizar's "Invariable Measuring" Drum.

Agencies:
177 Elm Street, Cincinnati.
214 & 246 N. Wells Street, Chicago.
510 North Second Street, St. Louis.
122 & 124 Sutter St., San Francisco.

HELME & McILHENNY,

(Successors to Harris & Brother. Established 1848)

GAS METER MANUFACTURERS,

CONTINUE AS HERETOFORE AT THE OLD ESTABLISHMENT,

Nos. 1115 and 1117 Cherry Street, Philadelphia, Pa.,

To Manufacture Wet and Dry Gas Meters, Station Meters, Experimental Meters, Meter Provers, Center Seals, Pressure Registers, GOVERNORS, INDICATORS, PHOTOMETERS, & ALL OTHER KINDS OF APPARATUS FOR USE IN GAS WORKS.
From our long practical experience of the business, and from our personal supervision of all work, we can guarantee all orders to be executed promptly, and in every respect satisfactorily.

WM. WALLACE GOODWIN, Prest. and Treas.

WM. H. MERRICK, V.-Prest.

S. L. JONES, Sec.

S. V. MERRICK, Supt.

THE GOODWIN GAS STOVE AND METER COMPANY,

Successors to W. W. GOODWIN & CO.

1012, 1014 and 1016 Filbert St., Phila., Pa. 142 Chambers St., New York.
76 Dearborn St., Chicago, Ill.

WALDO BROS., Agents, 88 Water St., Boston.

MANUFACTURERS OF THE "SUN DIAL" GAS STOVES, FOR COOKING AND HEATING PURPOSES.

Dry and Wet GAS METERS, Station Meters (Square, Cylindrical or in Staves) Glazed Meters, King's and Sugg's Experimental Meters, Lamp Post Meters, Etc., Etc., Meter Provers (sizes 2, 5 and 10 feet), Pressure Gauges of all kinds, Pressure Registers, Pressure and Vacuum Registers, Pressure Indicators (sizes 4 inch, 6 inch and 9 inch), King's Pressure and Vacuum Gauges, Dry and Wet Centre Seals, Dry and Wet Governors, Exhauster Governors, Photometers of all descriptions. Lethby's Sulphur and Ammonia Test Apparatus complete—also Testing and Chemical Apparatus of all kinds, and of the most perfect description, for all purposes relating to Gas.

GOODWIN'S IMPROVED LOWE'S JET PHOTOMETER.

Agents for Bray's Patent Gas Burners and Lanterns.

Special attention to repairs of Meters, and all apparatus connected with the business.
All work guaranteed first class in every particular, and orders filled promptly.

G. B. EDWARDS, Mang'r, New York.
E. H. B. TWINING, Mang'r, Chicago.
A. B. STANNARD, Agent.

D. McDONALD & CO.,

GAS METER MANUFACTURERS.

(Established 1854.)

51 Lancaster St., Albany, N. Y. 34 & 36 West Monroe St., Chicago, Ill.

STATION METERS, EXPERIMENTAL METERS, METER PROVERS, PRESSURE & VACUUM REGISTERS, PRESSURE GAUGES, ETC.
Also STAR GAS STOVES, RANGES, and HEATING STOVES.

We use only the very best materials, and employ the most skilled labor, and by our long experience (29 years) and personal supervision of every detail, we feel justified in assuring the public that our goods will give perfect satisfaction. Every Meter emanating from our establishment will bear the State Inspector's BADGE, and will be fully warranted by us. Our Annual and Calendar will be sent to Gas Companies upon application.

KING'S TREATISE ON COAL GAS.

The most complete work on Coal Gas ever published. Three vols., bound, \$30.

A. M. CALLENDER & CO., No. 42 Pine Street, New York.

THE "OTTO" GAS ENGINE.

Guaranteed to Consume 25 to 75
Per Cent. LESS GAS than **ANY** OTHER GAS ENGINE
PER BRAKE HORSE POWER.

TWIN ENGINES Impulse every revolution.
THE STEADIEST RUNNING GAS ENGINE YET MADE.

ENCINES AND PUMPS COMBINED,

For Hydraulic Elevators, Town Water Supply, or Railway Service.

Special Engines for Electric Light Work.

OVER 15,000
IN USE.

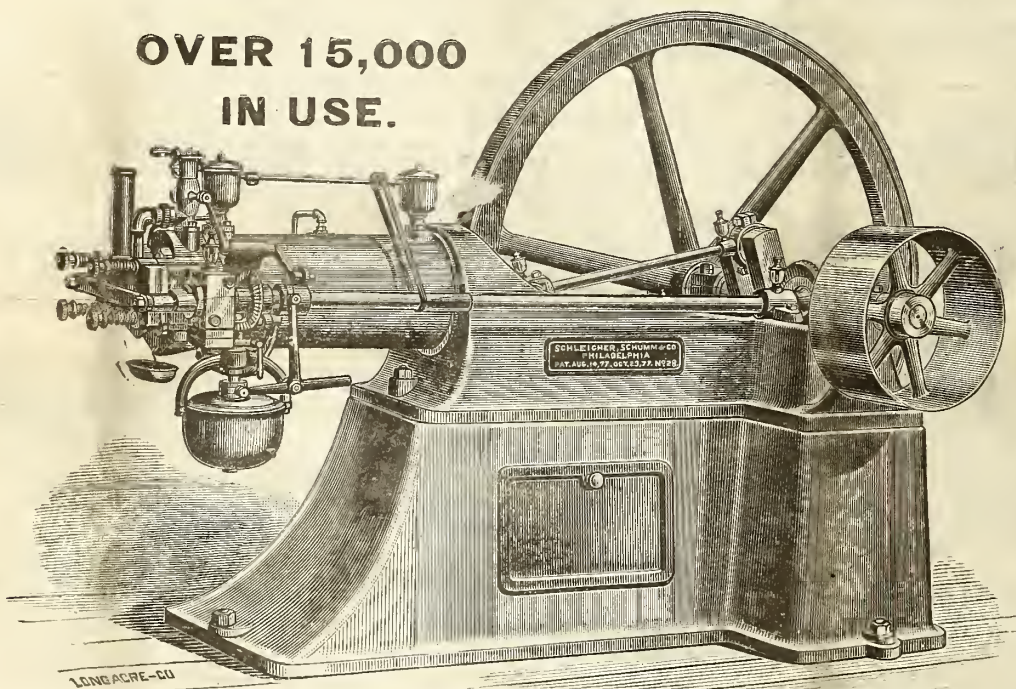

The Otto Gas Engine is now consuming, at a moderate computation, 2000 millions cubic feet of gas per year, nearly all of which is furnished during day time only.

**THE ONLY HIGHEST AWARD, ONLY GOLD MEDAL,
AT ELECTRICAL EXHIBITION, PARIS, 1881.**

MADE IN SIZES FROM 1 TO 25 HP. INDICATED.

FOR PARTICULARS, PRICES, ETC., APPLY TO

SCHLEICHER, SCHUMM & CO.,

Works:

Branch Office:

N. E. Cor. 33d & Walnut Sts., Phila., Pa.

214 Randolph Street, Chicago, Ill.

