





This Stove  Book No. 95

ILLUSTRATING THE SPLENDID

# ALCAZAR

RANGES & STOVES

IS THE PROPERTY OF

*Geo. V. Ayer & Company*

AND OF THE

## ALCAZAR RANGE & HEATER CO.

MILWAUKEE, WIS.

TO BE USED EXCLUSIVELY FOR STOVE  
BUSINESS BUILDING OF THE ABOVE  
NAMED FIRMS





# *Alcazar*

## RANGES - STOVES - HEATERS

FOR EVERY FUEL

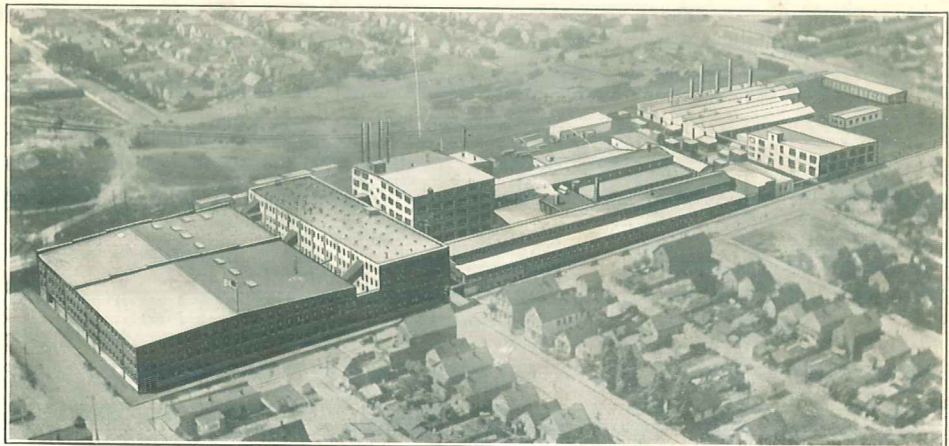

Home Offices and Factory

### ALCAZAR RANGE & HEATER CO.

MILWAUKEE, WIS., U. S. A.

CHICAGO  
DENVER

NEW YORK  
COLUMBUS

SAN FRANCISCO  
DETROIT



# TERMS

Our terms are 30 days net, with 2% discount for cash in 10 days from date of invoice.

All sales are F.O.B. Milwaukee, Wisconsin.

Accounts not paid at maturity are subject to sight draft with exchange, without notice. If purchaser sells out, transfers his stock, or the same becomes encumbered the account shall become due and payable forthwith.

Prices are subject to change without notice.

All goods included in this catalog are of the most durable material and best construction of the kind made for the price asked and all articles operate successfully when directions are followed.

**Claims for shortages or overcharge** must be made within ten days from receipt of goods. Paid freight bill must accompany claim.

**SHIPPING** We ship at "Owners Risk Released" to give our customers the benefit of the lowest freight rate. Any goods we ship become the property of the buyer as soon as delivered by us to the Transportation Company, and the Transportation Company is responsible to the consignee for safe delivery of the goods. In the absence of special shipping directions, we will use our best judgment in the choice of routes.

**BREAKAGE** All our goods are crated in exact conformity with the requirements laid down by the Freight Container Bureau of the American Railway Association. *If goods arrive in any way damaged, do not accept without having Transportation Company's agent make proper notation such as "Received Broken" on the freight expense bill.* If this precaution is not taken, the Transportation Company cannot be held responsible and we cannot replace or repair any damaged parts except at consignee's expense.

**CONCEALED DAMAGE** If damage is not discovered until unpacking, report concealed damage to Transportation Company's agent for inspection and insist that the agent make notation of damage on freight expense bill. Such action on goods received in "damaged" condition or with "concealed damage" will enable you to make claim against the Transportation Company.

**Our responsibility** ceases when we have received a clear receipt from the Transportation Company and in no instance shall the settlement with us be subject to the arrival or non-arrival of goods at destination or to claims for damage to goods in transit. We wish to give every assistance in our power to help our customers trace lost goods or to collect for damages. Should the customer have any difficulty in making claims on goods shipped by us, send Bill of Lading together with Freight Expense Bill with proper notation of loss or damage, and we will gladly in customer's behalf, file claim, and credit customer's account when claim is paid. At the same time the customer should send in a memorandum of what is needed to make good the damage so that the customer may not be inconvenienced.

**Porcelain Enamel** is breakable. It will not be guaranteed. All stoves are coated with enamel of good color, as evenly and as smoothly as the limitations of the art will permit.

Parts to replace parts claimed imperfect will be charged in regular manner when shipped and if upon return of the parts claimed imperfect they are found to be so because of workmanship or material, credit will be rendered for full charge made for part furnished.

*Abuse or misuse of merchandise will not be considered as just cause for return for replacement.*

The return of goods for replacement or credit must first be authorized by us. Goods shipped to us without such authorization will be held at the disposal of the shipper.

Claim for free replacement of parts must be made within one year. When an article has been in use for a period of one year, it is fair to assume that any cause of complaint is not the result of workmanship or material.





GAS RANGE  
AND HEATER  
DIVISION

SUPREME  
RESIDENCE  
CABINET  
LOW OVEN  
KITCHENETTES  
APARTMENTS  
CIRCULATING  
GAS HEATERS  
LAUNDRIES



1910  
1911  
1912

1913  
1914  
1915  
1916  
1917  
1918  
1919  
1920

## OVEN INSULATION

**T**HE oven of Alcazar insulated gas ranges is completely insulated—sides, top, back and door—with Rock-Wool Walls—proved by test to be the ideal insulating material.

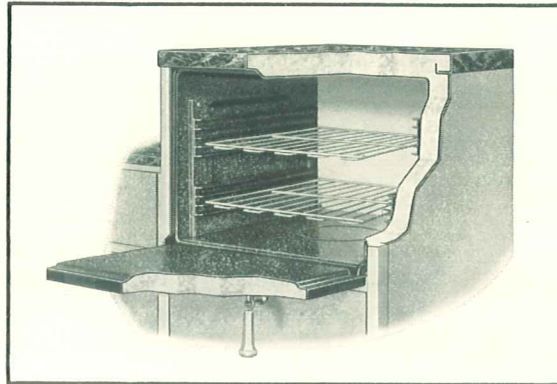

The heavily insulated oven uses less gas — and with a baking-hot oven in summer the kitchen remains comfortable because of this heavy Rock-Wool Wall.

**Oven  
Ventilation**

The new principle of ventilation employed keeps the heat under constant tension and the temperature uniform in every part of the oven which produces more thorough, perfect baking. Food can be placed anywhere in the oven and will come out evenly baked, top and bottom, and thoroughly through and through.

**Perfect  
Baking Per-  
formance**

Dependable baking results, delicious whole meals—juicy roasts, successful baking with a minimum gas consumption. The Alcazar insulated oven does more with less gas than any other.

**Hot Oven  
Cool  
Kitchen**

The heavy insulation keeps the heat in the oven. Radiation is reduced to the minimum. It can be used for hours on hot summer days and the kitchen remains comfortable.

These several advantages are obtained with reduced fuel consumption, for the oven of Alcazar insulated ranges takes less gas to heat and because the heat is retained under tension, baking or roasting progresses a greater part of the time with the gas automatically shut off by the Thermolator.



## DUPLEX BURNERS

### An Improvement That Saves Gas, Watching and Worry

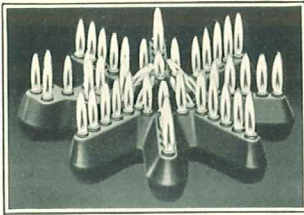

With the gas valve open the Burner brings foods to boiling in the shortest time.

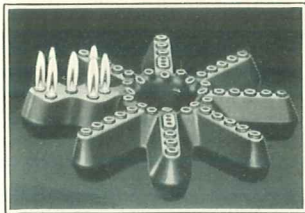

The most efficient flame for continued slow boiling

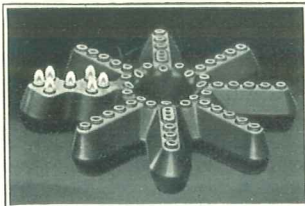

The boiling flame lowered for warming purposes.

WITH these new Burners the risk of kettles boiling dry and burning food is eliminated. With the valve handle turned on full, they provide a large, fast flame for quick heating to the boiling temperature. After the boiling point is reached, the gas valve handle turned lower automatically gives a boiling temperature. This boiling flame is scientifically proportioned so that it will keep vessels boiling, that is, cooking as fast as is necessary, but the heat is properly limited so that very little water boils away.

After a few trials the housewife will learn that she can leave such foods that need long cooking for several hours if need be, without watching.

Among the advantages of the Duplex Burner is the fact that utensil handles do not burn, the kitchen is comfortable on hot summer days and a real saving of fuel is effected because no more is used than needed. Also the convenience of leaving kettles over the burners on which cooking has been done and merely reduce the flame instead of shifting around to a separate simmering burner.

## SPREADER LIGHTER

Ranges equipped with Duplex burners have the Spreader Lighter which automatically lights the burner as you turn on the gas. No matches—no lighter button. A convenience that instantly appeals to the modern housewife.

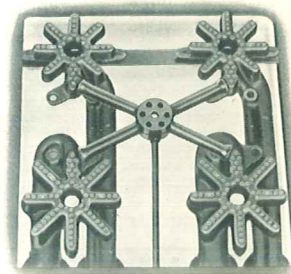

The burners light automatically as the gas valve is opened.

## THERMOLATOR OVEN HEAT CONTROL

WITH the Thermolator, the desired degree of heat is maintained in the oven automatically for various kinds of baking and cooking. When the indicator is set to the desired temperature, it holds the oven temperature at that point.

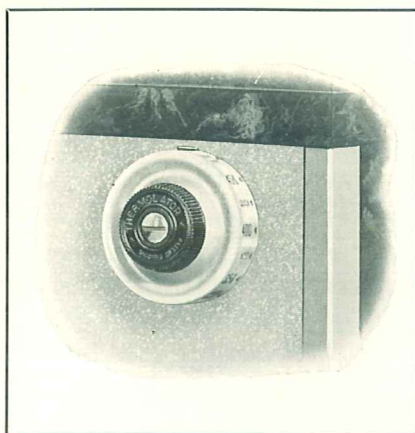

The necessity for continual watching of the food is entirely avoided and time saved. By setting the indicator, the desired temperature is produced in the oven and maintained automatically.

Only enough gas to maintain the heat required is used. Being automatic in operation, the Thermolator takes care of fluctuations in gas pressure. If the pressure increases so as to make the oven too hot, it diminishes the flow of gas to the burners and so prevents a climbing temperature. If the gas pressure diminishes in the

gas mains, it increases the flow of gas to offset the lack of pressure, maintaining the right heat at all times; thus only the amount of gas needed is consumed.

## ALCAZAR SEMICLOSETOP

The Alcazar SemiClosetop makes cooking easier and offers the same advantages with manufactured gas as with natural gas. It consists of a solid keyplate properly reinforced, which covers the entire burner box top with openings over the burners provided with grate fingers adapted to various size utensils.

Ample ventilation provides a sufficient supply of air for good combustion. The entire top plate can be readily removed as well as the burners and the burner box conveniently cleaned within a few moments time.

All Alcazar gas ranges are regularly equipped with the open top grates but will be furnished with the Alcazar SemiClosetop if so desired.

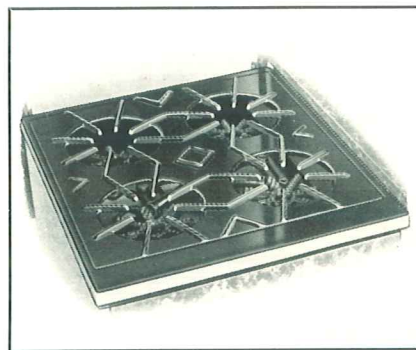

Solid cast iron reinforced keyplate covering the entire burner box top.



## EQUIPPED FOR COMPRESSED OR 'BOTTLED GAS'

**I**N certain sections the compressed gas of various brands, put up in tanks or drums, is used, bringing to such homes the convenience of central gas service.

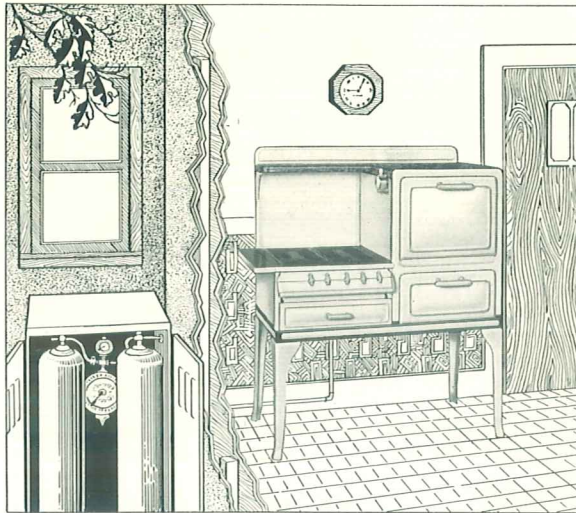

ALCAZAR Gas Ranges work equally well with any of the several brands of compressed gas on the market.

Alcazar Gas Ranges are admirably adapted for use with this gas and will be so equipped when ordered.

This offers the user of bottled gas a choice from a wide variety of ranges in an assortment of sizes and styles to fit any requirement.

Where bottled gas is used, please specify the brand of gas in each instance.

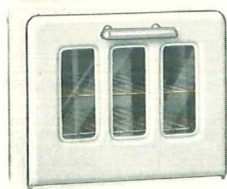

### GLASS OVEN DOOR

Ranges are regularly fitted with solid oven doors but if specially ordered (on ranges where indicated) can be furnished with glass oven door similar to the one illustrated.

## BROILER DRAWER

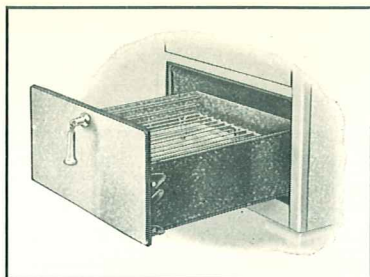

The Broiler Drawer slides out bringing contents within easy reach without danger of scorching hands or arms.

The front door drops to a horizontal position providing a rigid shelf for placing the platter when transferring food to or from the Broiler Rack.

The Broiler Drawer operates on rollers so that it always moves freely in or out, without sticking even though heavily loaded.

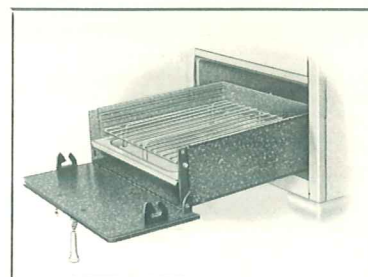

The door drops providing a rigid shelf for platter when transferring food to or from the broiler rack.



## PENDANT HANDLES

The beauty and convenience of the New Alcazar Gas Ranges are enhanced by the Pendant Handles with attractive chromium plated fittings. They make it easy to open the drawers and oven doors, and they stay cool.

## A. G. A. APPROVAL SEAL

This Laboratory Approval Seal is a guarantee of compliance with basic national requirements for safety.





## The NEW ALCAZAR GAS RANGES

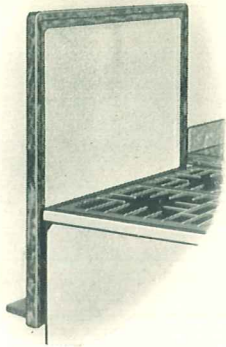

The cover lifts easily and slides partly down behind the range, the upper portion serving as a splash back while cooking.

THESE new Alcazar Gas Ranges introduce what we believe to be the finest ranges ever built. Such beauty, such completeness and such a wealth of conveniences were never before found in any gas range.

In designing and constructing the New Alcazar Gas Ranges, we deliberately set ourselves the task of making the finest, most attractive and most serviceable range in the world. We place before you the result. And we feel sure you will confirm our opinion in every detail.

Place these New Alcazar Ranges in your showroom and sales will result, for their qualities of rare beauty and cooking convenience are unsurpassed.

### Beauty and Utility

Few women could pass an Alcazar Range on your sales floor without stopping to look at it. And once a woman examines an Alcazar Gas Range and makes a mental comparison between it and her old range, she will certainly be a prospect for a New Alcazar.

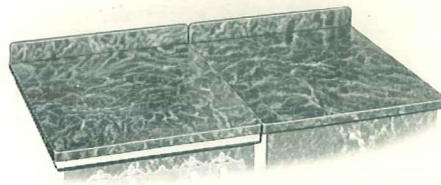

With the cover closed the beautiful Italian marble finished top presents a smooth table-top surface.

### Convenience and Variety

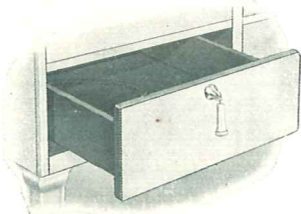

The large deep utility drawers hold large size kettles and slide easily even though filled.

We introduce these New Alcazar Gas Ranges in many different models. Read about them. Note the specifications. Get ready for new business and greater profits which these popular ranges will bring.

1514 X 11-7-31



**No. 4000A — Green**  
**ALCAZAR BUFFET GAS RANGE**  
**Insulated**

Choice of color finishes named. Insulated with Rock Wool. Equipped with Thermolator, broiler drawer and two utility drawers. Porcelain enameled linings. Cast iron oven bottom. For manufactured or natural gas.

**To be specified:** Color—Green as shown above.  
 Marble-Ivory as on page 12B.  
 Marble-Green as Vogue on page 13B.  
 Ivory as Vogue on page 14B.

Alcazar SemiClosetop.  
 Brand of gas, where bottled gas is used.

Oven 16x14x20 in. Cooking Surface 20x22 in. Length 41½ in. Depth 28 in. Broiler 16x8½x20 in. Cooking Height 36 in. Height—Closed 39 in. Open 50½ in.	Number	Code	Ship. Wgt.
	<b>4000A Regular Burners and Lighter</b>	Bufamb	317 lbs.
	<b>4100A Duplex Burners Spreader Lighter</b>	Bufilay	317 lbs.





**No. 4100A — Marble-Ivory**  
**ALCAZAR BUFFET GAS RANGE (open)**  
**Insulated**

Choice of color finishes named. Insulated with Rock Wool. Equipped with Thermolator. broiler drawer and two utility drawers. Porcelain enameled linings. Cast iron oven bottom, For manufactured or natural gas.

**To be specified:** Color—Marble-Ivory as shown above,  
 Green as on page 11B,  
 Marble-Green as Vogue on page 13B,  
 Ivory, as Vogue on page 14B.

Alcazar SemiClosetop.  
 Brand of gas, where bottled gas is used.

Oven 16x14x20 in. Cooking Surface 20x22 in. Length 41½ in. Depth 28 in. Broiler 16x8½x20 in. Cooking Height 36 in. Height—Closed 39 in. Open 50½ in.	Number	Code	Ship. Wgt.
		<b>4100A Duplex Burners Spreader Lighter</b>	Buflay
	<b>4000A Regular Burners and Lighter</b>	Bufamb	317 lbs.

1514 X 12-7-31

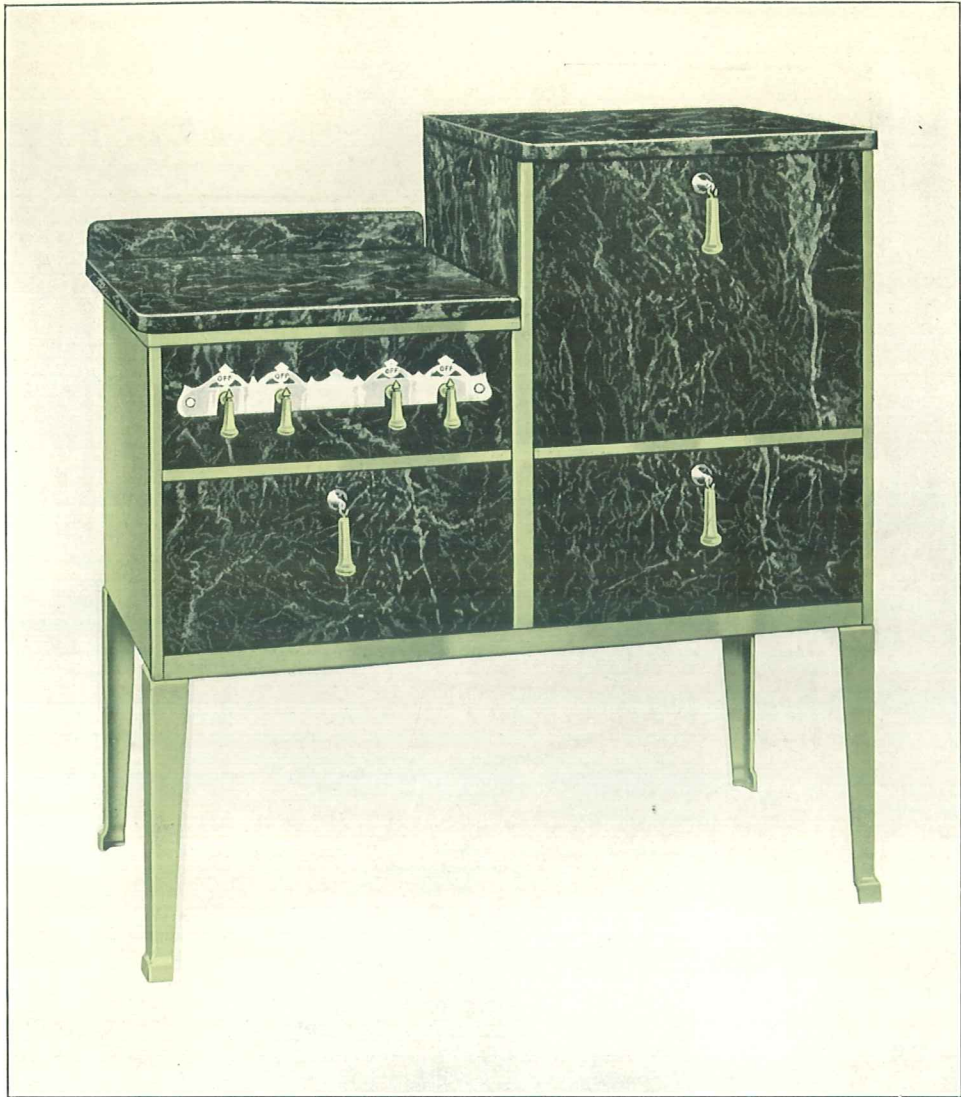

No. 4600A R — Marble-Green  
ALCAZAR VOGUE GAS RANGE  
Insulated

Choice of color finishes named. Insulated with Rock Wool. Equipped with Thermolator, broiler drawer and one utility drawer. Porcelain enameled linings. Cast iron oven bottom. For manufactured or natural gas.

To be specified: Color—Marble-Green as shown above.  
Green, as Buffet on page 11B,  
Marble-Ivory, as Buffet on page 12B.  
Ivory, as on page 14B.

Alcazar SemiClosetop.  
Brand of gas, where bottled gas is used.

Oven 16x14x20 in. Cooking Surface 20x22 in. Length 41½ in. Depth 28 in. Broiler 16x8½x20 in. Cooking Height 34 in. Height—Closed 43 in. Open 48½ in.	Number	Code	Ship. Wgt.
	4600A R Duplex Burnres	Vogamy	308 lbs.
	4600A L Spreader Lighter	Vogabe	308 lbs.
	4500A R Regular Burner	Vogaki	308 lbs.
	4500A L and Lighter	Vogalu	308 lbs.





**No. 4500A R — Ivory**  
**ALCAZAR VOGUE GAS RANGE (open)**  
 Insulated

Choice of color finishes named. Insulated with Rock Wool. Equipped with Thermolator, broiler drawer and one utility drawer. Porcelain enameled linings. Cast iron oven bottom. For manufactured or natural gas.

**To be specified:** Color—Ivory as shown above,  
 Green as Buffet page 11B,  
 Marble-Ivory as Buffet page 12B,  
 Marble-Green as on page 13B.  
 Alcazar SemiClosetop.  
 Brand of gas, where bottled gas is used.

Oven 16x14x20 in. Cooking Surface 20x22 in. Length 41½ in. Depth 28 in. Broiler 16x8½x20 in. Cooking Height 34 in. Height—Closed 43 in. Open 48½ in.	Number	Code	Ship. Wgt.
	<b>4500A R Regular Burners</b>	Vogaki	308 lbs.
	<b>4500A L and Lighter</b>	Vogalu	308 lbs.
	<b>4600A R Duplex Burners</b>	Vogamy	308 lbs.
	<b>4600A L Spreader Lighter</b>	Vogable	308 lbs.

1514 X 13-7-31



**No. 3900 R — Ivory**

**ALCAZAR MAYFAIR GAS RANGE**

Choice of color finishes named. Thermolator, utility compartment. Cooking top porcelain enameled. Top grates and burners japanned. Fitted with three regular size, one giant burner, and Rutz lighter. Porcelain enameled linings. For manufactured or natural gas.

**To be specified:** Color—Ivory as shown above,  
Marble-Ivory as on page 12B.

Alcazar SemiClosetop.  
Brand of gas, where bottled gas is used.

	Number	Code	Ship. Wgt.
Oven 16x14x20 in.			
Cooking Surface 19x21 in.			
Cooking Height 34½ in.			
Depth 27 in.			
Broiler 16x8½x20 in.			
End Shelf 2½ in.			
Length 40½ in.			
Height 44 in.			
	<b>3900 R Insulated. Cast</b>	Maybel	228 lbs.
	<b>3900 L Oven Bottom</b>	Maybate	228 lbs.
	<b>3800 R Not Insulated</b>	Maybuss	208 lbs.
	<b>3800 L Steel Oven Bottom</b>	Mayback	208 lbs.





**No. 2271 R — Marble-Ivory  
ALCAZAR GAS RANGE**

Choice of color finishes named. Porcelain enameled oven, broiler and door linings. Cooking top porcelain enameled, top grates and burners black japanned. Three regular size, one giant burner. Service drawer. For manufactured or natural gas.

**To be specified:** Color—Marble-Ivory as shown above,  
Marble-Green as on page 13B.

Alcazar Semi-Closetop.

Brand of gas, where bottled gas is used.

	Number	Code	Ship. Wgt.
Oven 16x12x18½ in.	2271 R Insulated. Cast 2271 L Oven Bottom	Gapala	230 lbs.
Broiler 16x8½x18½ in.		Gapate	230 lbs.
Cooking Surface 19x21 in.	Above regularly fitted with Thermolator and Lighter		
End Shelf 2½ in.			
Cooking Height 32¾ in.	1271 R Not Insulated 1271 L Steel Oven Bottom	Gapamu	210 lbs.
Length over-all 41 in.		Gaparel	210 lbs.
Depth 25½ in.	Thermolator and Lighter for above may be specified.		
Height 41½ in.			



No. 2270A R — Acme  
ALCAZAR GAS RANGE

A special range — prices on request.

Porcelain enameled in Marble-Green finish only as shown. Cooking top porcelain enameled, burners and top grates japanned. Porcelain enameled oven, broiler and door linings. One giant, three regular burners. Service drawer. For manufactured or natural gas.

**To be specified:** Alcazar SemiClosetop.  
Cast Iron oven bottom.  
Brand of gas, where bottled gas is used.

	Number	Code	Ship. Wgt.
Oven 16x12x18½ in. Broiler 16x8½x18½ in. Cooking Surface 19x21 in. Cooking Height 32¾ in. Length over-all 38½ in. Depth 25½ in. Height 44 in.	<b>2270A R Insulated</b>	Glaudest Glaudiry	225 lbs. 225 lbs.
	<b>2270A L Oven</b>		
	Above regularly fitted with Thermolator and Lighter.	Glaudale Glauldold	205 lbs. 205 lbs.
	<b>1270A R Not</b> <b>1270A L Insulated</b> Thermolator and Lighter for above may be specified.		





No. 1D-091 L — Nile Green  
**ALCAZAR GAS RANGE**  
 Insulated

Porcelain enameled in Ivory and Nile Green or White and Gray. Two insulated ovens, broiler drawer and service drawer. Porcelain enameled oven, broiler and door linings, oven bottoms (cast iron), top grates, frame, burners, burner tray and broiler pan. Six duplex burners, two spreader lighters. Both upper and lower ovens equipped with automatic heat regulator. For manufactured or natural gas.

To be specified: Color—Ivory and Nile Green or White and Gray.  
 Alcazar SemiClosetop.  
 Glass oven door on upper oven.  
 Brand of gas, where bottled gas is used.

Upper Oven 18x14x20 in. Lower Oven 20x14x20 in. Broiler 18x9x20 in. Cooking Surface 31x20 in. End Shelf 3½ in. Cooking Height 34 in. Length over-all 57 in. Depth 28 in. Height 53½ in.	Number	Code	Ship. Wgt.
	1D-091 R	Gaitelot	516 lbs.
	1D-091 L	Gajelote	516 lbs.

1514 X 15-7-31



No. 2000C R  
ALCAZAR GAS RANGE  
Insulated

Ivory porcelain enameled, green handles, marbled oven top and top shelf. Porcelain enameled oven bottom (cast iron), oven, broiler and door linings, top grates, frame, end shelf, burners, burner tray and broiler pan. Insulated oven, four duplex burners and spreader lighter, heat regulator, broiler drawer, service drawer. For manufactured or natural gas.

To be specified: Alcazar SemiClosetop.  
Glass instead of Solid Oven Door.  
Brand of gas, where bottle gas is used.

	Number	Code	Ship. Wgt.
Oven 18x14x20 in. Cooking Surface 21 1/2x22 in. Length over-all 46 1/2 in. Height 54 in. Broiler 18x9x20 in. Cooking Height 34 in. Depth 29 1/2 in. End Shelf 3 1/2 in.	2000C R 2000C L	Superader Superadore	323 lbs. 323 lbs.





No. 1066C R  
ALCAZAR GAS RANGE  
Insulated

Ivory porcelain enameled, green handles, marbled oven top and top shelf. Porcelain enameled oven, broiler and door linings, oven bottom (cast iron), top grates, frame, burners and spreader lighter. Heat regulator, broiler drawer and service drawer. For manufactured or natural gas.

**To be specified:** Alcazar SemiClosetop.  
Glass instead of solid oven door.  
Brand of gas, where bottled gas is used.

Oven 16x14x20 in. Broiler 16x8½x20 in. Cooking Surface 21½x22 in. End Shelf 3½ in. Cooking Height 34 in. Length over-all 45 in. Depth 28½ in. Height 53 in.	Number	Code	Ship. Wgt.
	1066C R	Galetibo	288 lbs.
	1066C L	Galdite	288 lbs.



No. 81

ALCAZAR GAS HEATER

Beautifully porcelain enameled in high furniture finish. Body of heavy steel with cast iron legs and ornamental top. Rounded corners and attractive design lend these Heaters unusual distinction.

	Number	Burners	Radiants	Code	Ship. Wgt.
Extreme Height 44 in. Width 24 in. Depth 19 in.	81	2	8	Gorgantle	254 lbs.
	81N (For Natural Gas)	2	8	Gorkidder	254 lbs.
Extreme Height 44 in. Width 24 in. Depth 15 in.	41	1	4	Gorgel	214 lbs.
	41N (For Natural Gas)	1	4	Gorgarter	214 lbs.
No. 2 E Automatic Thermostat				Gorglow	



# Alcazar Gas Heaters

**H**HEATING by gas is perhaps the simplest, cleanest and most efficient method of househeating. Instant heat is available at the touch of a match for as long or short a period as is required. Coal, wood and ashes are entirely eliminated and smoke and soot become a thing of the past.

Alcazar Gas Heaters have been in use for a number of years, tried under all conditions, and found worthy. Being so designed and constructed that maximum heat results from a minimum of gas consumption, these heaters have earned for themselves an enviable regard.

**Appearance** The beauty of their design and finish adapts them to any surroundings. The attractive porcelain enamel in a pleasing furniture finish lends individuality to the room and harmonizes with all furnishings. Such a finish may be cleaned with an ordinary cloth as easily as any other piece of furniture.

**Kind of heat** There are three kinds of applied heat, radiated, conducted and convected and convected or circulating heat. Among gas circulating heaters Alcazar alone combines these three to the greatest degree.

**Radiant heat** Radiant heat, like the sun's rays, warms the object with which it comes in contact which in turn radiates warmth into the room. The Alcazar gas heater because of its exclusive burner construction discharges a greater amount of radiant heat through its large mica door than any other gas heater. Radiant heat alone is not a satisfactory method of househeating but as an auxiliary it tremendously increases heating efficiency. Everyone enjoys the comfort and cheer of a radiant fire.

**Conducted heat** Conducted heat is that discharged from the body of the heater. By means of an inner asbestos lining conducted heat is distributed most effectively.

**Convected heat** Convected heat is that which is in motion, circulating freely to all rooms of the house. Warm air being lighter, expands, rises and diffuses itself in all directions, replacing cold air which in turn drops to the floor. This cold air is drawn in at the bottom of the heater, becomes heated through contact with the hot surface of the inner unit, expands, rises and continues the process of circulation. Circulating heat permeates every room and when not retarded will thoroughly and evenly heat the whole house.

**Position in home** In order that the Alcazar circulator can function most satisfactorily, freedom of air circulation into all the rooms to be heated must be insured. When the heater is placed in a central location in the home, door openings and stairways usually solve the circulating problem. However, rooms that are detached from the rest sometimes require the installation of grills or registers for proper heating.

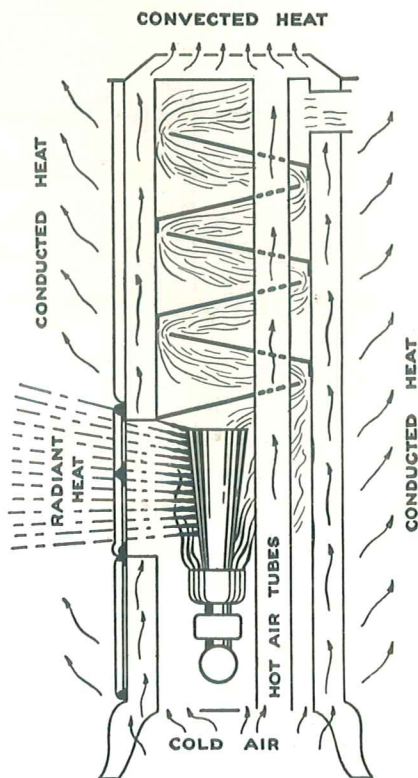

**Example 1:** An average size living room in the ordinary five room bungalow of today according to many architects is 12 x 22 x 8½. To heat such a room to 70° inside when the outside temperature is 0°:

$$C \text{ or Cubical content } (12 \times 22 \times 8\frac{1}{2}) = 2244$$

$$T \text{ or temperature difference in tens } (0^\circ \text{ to } 70^\circ \div 10) = 7.$$

$$T \times C \times 1 \text{ B. T. U. } (7 \times 2244 \times 1) = 15708 \text{ B. T. U.}$$

Therefore, 15708 B. T. U. are required under the stated conditions to heat that particular room.

**NOTE:** In older homes living rooms are much smaller, but for our purpose the figures will serve in as much as the other rooms of the older home were perhaps larger.

The following is a table showing ratings of the two sizes of our gas heaters. By comparing the B. T. U. requirement with this table, the size heater necessary is readily apparent. (N following the number stands for natural gas.)

NO. OF HEATER	INPUT RATE B. T. U.	OUTPUT RATE B. T. U.	STEAM RADIATION EQUIVALENT
41 41N	25,000 - 30,000	20,120 - 24,800	87 - 104 sq. ft.
81 81N	50,000 - 70,000	40,500 - 56,000	174 - 240 sq. ft.

Hence the room in Example 1, requiring only 15708 B. T. U. is easily heated by the smaller or No. 41 model heater. Comparing this figure with 24800 B. T. U., the maximum capacity of the heater it is found that the smaller heater will handle, under the above conditions 1½ rooms of the size stated. By the same reasoning the No. 81 model heater will heat under the above conditions over 3½ rooms of that size which is easily the equivalent of a five room bungalow.

In the above examples, the extreme low temperature was assumed. Naturally, temperatures do not remain at the extreme low for a long period or for long times during the year, but to assure ample heat capacity when needed, the extreme must be used. Always recommend the larger heater for with its extremely wide heating range due to its dual burner construction it is no more costly to operate than the smaller and the reserve capacity is always available.

## TO ESTIMATE COST

Estimating the season cost of operation is very apt to be only a close guess, since the variable factors are more apt to throw computation covering a longer period, into error. The temperature maintained at night, number of hours of maintained temperature, quality and kind of building construction, prevailing outside temperature, number of air changes, wind velocity, amount of sunshine, and etc., all bring in variations which tend to affect season cost.



However, a cost per hour of operation can be easily and definitely established. This, instead of an estimate of season cost, should be the figure used.

Knowing the B. T. U. content of the gas used (natural about 1100 B. T. U. and manufactured about 550 B. T. U. per cubic foot), the B. T. U. requirement of a given space and the cost of the gas per 1000 cubic foot it is easy to determine the cost per hour of heating that space. The following example is worked out using natural gas and the room in example 1.

**Example 2:**

B. T. U. content of natural gas 1100 B. T. U. per cubic foot.

B. T. U. requirement of room = 15708.

$$15708 \div 1100 = 14.3.$$

Therefore, 14.3 cubic feet of natural gas is used per hour.

Assuming natural gas @ 75c per 1000 cubic feet the cost per hour

$$\text{would be } \frac{14.3}{1000} \times \$0.75 = \$0.01.$$

Hence for 1 cent per hour the **room in example 1** could be heated.

At the same gas rate, if Manufactured gas with only one half the B. T. U. content of Natural gas were used, twice the volume would be required and the cost would be 2 cents per hour for heating the same room.

**Example 3:**

The cost per hour of using the larger model heater at its **full lower rating capacity** using natural gas is as follows:

B. T. U. content of natural gas = 1100 B. T. U. per cubic foot

50,000 B. T. U. = Input rate.

$$50,000 \div 1100 = 45.5.$$

Therefore, its consumption is 45.5 cubic feet per hour.

$$\frac{45.5}{1000} \times \$0.75 = \$0.034$$

Hence for 3.4 cents per hour the model 81 can be operated under the above conditions.

As before, if manufactured gas is the fuel, the cost would be twice as much or 6.8 cents per hour.

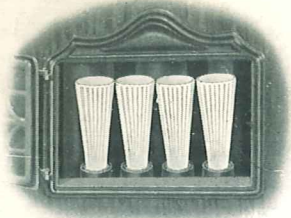

### **Burner**

The burner used in the Alcazar gas heater is exclusive and distinctive. It is of cast iron construction, fastened securely at the bottom of the heater and contains four cast iron cups in which are placed smaller cups holding the radiants. Gas enters the opening between the two cups and the flame burns around the entire circumference of the radiant. In this manner an unlimited supply of secondary air, which is so necessary to perfect combustion, is always available.

### **Gas Cocks**

Gas cocks are adjustable and any desired degree of heat may be had.

### **Combustion Chamber**

The combustion chamber in which the radiants are placed is of cast iron construction in the fire zone giving it unusually long life. The door is tight and so compels the combustion to move upward into the flue without escaping. Being entirely open at the bottom the secondary air supply is not restricted in any manner.

### **No excessive floor temperature**

The heat rays from the radiants are diverted in an upward direction into the heat drum which eliminates excessive floor temperature.

### **Radiants**

The radiants are cone shaped, heavy and will not deteriorate from use. Heat is discharged around the entire circumference of the radiant and is not confined as in the ordinary radiant heater.

### **Heat drum**

Above the cast iron combustion chamber is located the heat drum. In it is arranged a series of baffle plates so designed that the heat generated from the burning gas is retained in the heater for the longest period of time. Small heat loss is the result. This heat drum becomes intensely hot, heating the cold air coming from the floor and is a most important factor in producing circulation.

### **Heat tubes**

Leading from the bottom of the heater, passing through the combustion chamber and the heat drum are two convected heat tubes whose function also is to draw in cold air from the floor and discharge it heated at the top. They considerably increase the hot surface area therefore increasing the amount of circulating heat.

### **Circulating Air Space**

The heat drum and hot air tubes are so arranged as to permit freedom of circulation between the inner unit and the outside heater walls with the result that circulating heat is discharged at the top from all four sides of the heater.

### **Humidifier**

Dry air is not healthful and for that reason a water pan is supplied at the rear and base of the heater. When that water container is kept properly filled the result is healthful, humidified air.

### **Natural or Manufactured Gas**

Alcazar gas heaters are made to burn both natural and manufactured gas but because of a burner difference the type of gas used must be specified. The letter N after the number indicates the heater for natural gas.



**Automatic Thermostat** An automatic thermostat may be had with each Alcazar gas heater and is most emphatically recommended. Not only is it low in price but simple and positive in operation. This thermostat may be set for any desired temperature and by controlling the flow of gas going to the burners so that no more is passed than the amount necessary to maintain the desired temperature, the room cannot possibly become overheated or underheated. Overheating is wasteful, consequently the thermostat saves gas. Underheating is uncomfortable and unhealthful. The thermostat will pay for itself over and over again, not only in gas economy but in home comfort.



Its installation should be on the gas line about twelve inches from the heater, complete installation instructions being enclosed with each thermostat.

It is always desirable to have reserve heating capacity for the unexpected cold snap. The Automatic Thermostat makes it possible to use the larger, or No. 81 Alcazar heater at no greater expense than the smaller, for with the thermostat only the amount of gas necessary to maintain proper temperature is used. Therefore, the automatic thermostat is an investment, not an expense, that will pay rich dividends and should be a part of every Alcazar gas heater installation.

### To estimate capacity of heater required

The capacity heater required to heat any given space depends entirely upon the size of the space, quality and kind of construction, number of windows or glass area, exposed wall area, number of times the air is changed per hour due to ventilation and natural circulation and finally, the difference between the temperature to which the room is heated and the prevailing temperature out of doors.

In order to learn the amount of heat required to heat a given space, long formulas are often used which necessitate a large amount of measuring and computation. Since there are so many factors entering into these computations, as mentioned above, any one factor being faulty or inaccurate, therefore, causes the entire estimate to become at best a rough approximation. Since gas heaters are rated in output of B. T. U. per hour, the following is an extremely simple method based on the B. T. U. requirement per cubic foot of space for estimating the capacity of our heaters. (B. T. U. means British Thermal Unit, the amount of heat necessary to raise one pound of water one degree Fahrenheit, and is the standard unit in heating engineering.)

Average figures indicate that it requires one B. T. U. per cubic foot of space for each ten (10) degrees difference between the desired inside temperature and the prevailing outdoor temperature.

Let T = the difference between inside temperature and outside temperature divided by 10.

Let C = the cubical content of the space to be heated.

Then  $T \times C \times 1 \text{ B. T. U.} = \text{No. of B. T. U. required to heat that given space.}$

This formula applies to average conditions of wall thickness, building quality, number of windows, etc. and is remarkably accurate.



No. 81

ALCAZAR GAS HEATER

Beautifully porcelain enameled in high furniture finish. Body of heavy steel with cast iron legs and ornamental top. Rounded corners and attractive design lend these Heaters unusual distinction.

	Number	Burners	Radiants	Code	Ship. Wgt.
Extreme Height 44 in. Width 24 in. Depth 19 in.	81	2	8	Gorgantle	254 lbs.
	81N (For Natural Gas)	2	8	Gorkidder	254 lbs.
Extreme Height 44 in. Width 24 in. Depth 15 in.	41	1	4	Gorgel	214 lbs.
	41N (For Natural Gas)	1	4	Gorgarter	214 lbs.
No. 2 E Automatic Thermostat				Gorglow	

*Omaha*  
*4000*  
*101 00*  
*LKUD*  
*87 00*



# Alcazar Gas Heaters

**H**EATING by gas is perhaps the simplest, cleanest and most efficient method of househeating. Instant heat is available at the touch of a match for as long or short a period as is required. Coal, wood and ashes are entirely eliminated and smoke and soot become a thing of the past.

Alcazar Gas Heaters have been in use for a number of years, tried under all conditions, and found worthy. Being so designed and constructed that maximum heat results from a minimum of gas consumption, these heaters have earned for themselves an enviable regard.

**Appearance** The beauty of their design and finish adapts them to any surroundings. The attractive porcelain enamel in a pleasing furniture finish lends individuality to the room and harmonizes with all furnishings. Such a finish may be cleaned with an ordinary cloth as easily as any other piece of furniture.

**Kind of heat** There are three kinds of applied heat, radiated, conducted and convected or circulating heat. Among gas circulating heaters Alcazar alone combines these three to the greatest degree.

**Radiant heat** Radiant heat, like the sun's rays, warms the object with which it comes in contact which in turn radiates warmth into the room. The Alcazar gas heater because of its exclusive burner construction discharges a greater amount of radiant heat through its large mica door than any other gas heater. Radiant heat alone is not a satisfactory method of househeating but as an auxiliary it tremendously increases heating efficiency. Everyone enjoys the comfort and cheer of a radiant fire.

**Conducted heat** Conducted heat is that discharged from the body of the heater. By means of an inner asbestos lining conducted heat is distributed most effectively.

**Convected heat** Convected heat is that which is in motion, circulating freely to all rooms of the house. Warm air being lighter, expands, rises and diffuses itself in all directions, replacing cold air which in turn drops to the floor. This cold air is drawn in at the bottom of the heater, becomes heated through contact with the hot surface of the inner unit, expands, rises and continues the process of circulation. Circulating heat permeates every room and when not retarded will thoroughly and evenly heat the whole house.

**Position in home** In order that the Alcazar circulator can function most satisfactorily, freedom of air circulation into all the rooms to be heated must be insured. When the heater is placed in a central location in the home, door openings and stairways usually solve the circulating problem. However, rooms that are detached from the rest sometimes require the installation of grills or registers for proper heating.

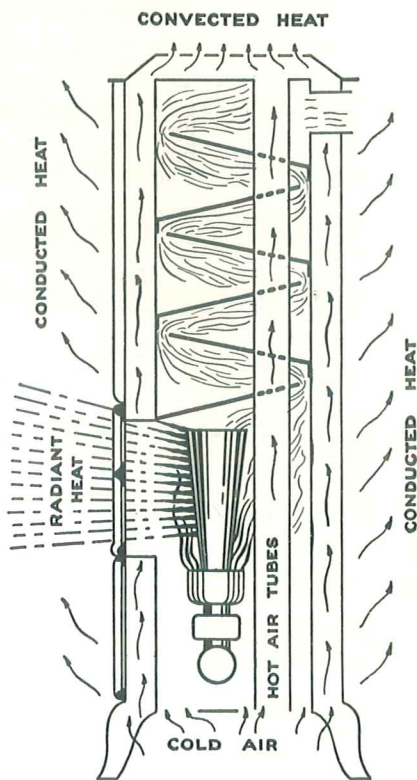

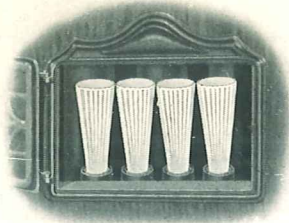

**Burner** The burner used in the Alcazar gas heater is exclusive and distinctive. It is of cast iron construction, fastened securely at the bottom of the heater and contains four cast iron cups in which are placed smaller cups holding the radiants. Gas enters the opening between the two cups and the flame burns around the entire circumference of the radiant. In this manner an unlimited supply of secondary air, which is so necessary to perfect combustion, is always available.

**Gas Cocks** Gas cocks are adjustable and any desired degree of heat may be had.

**Combustion Chamber** The combustion chamber in which the radiants are placed is of cast iron construction in the fire zone giving it unusually long life. The door is tight and so compels the combustion to move upward into the flue without escaping. Being entirely open at the bottom the secondary air supply is not restricted in any manner.

**No excessive floor temperature** The heat rays from the radiants are diverted in an upward direction into the heat drum which eliminates excessive floor temperature.

**Radiants** The radiants are cone shaped, heavy and will not deteriorate from use. Heat is discharged around the entire circumference of the radiant and is not confined as in the ordinary radiant heater.

**Heat drum** Above the cast iron combustion chamber is located the heat drum. In it is arranged a series of baffle plates so designed that the heat generated from the burning gas is retained in the heater for the longest period of time. Small heat loss is the result. This heat drum becomes intensely hot, heating the cold air coming from the floor and is a most important factor in producing circulation.

**Heat tubes** Leading from the bottom of the heater, passing through the combustion chamber and the heat drum are two connected heat tubes whose function also is to draw in cold air from the floor and discharge it heated at the top. They considerably increase the hot surface area therefore increasing the amount of circulating heat.

**Circulating Air Space** The heat drum and hot air tubes are so arranged as to permit freedom of circulation between the inner unit and the outside heater walls with the result that circulating heat is discharged at the top from all four sides of the heater.

**Humidifier** Dry air is not healthful and for that reason a water pan is supplied at the rear and base of the heater. When that water container is kept properly filled the result is healthful, humidified air.

**Natural or Manufactured Gas** Alcazar gas heaters are made to burn both natural and manufactured gas but because of a burner difference the type of gas used must be specified. The letter N after the number indicates the heater for natural gas.



**Automatic Thermostat** An automatic thermostat may be had with each Alcazar gas heater and is most emphatically recommended. Not only is it low in price but simple and positive in operation. This thermostat may be set for any desired temperature and by controlling the flow of gas going to the burners so that no more is passed than the amount necessary to maintain the desired temperature, the room cannot possibly become overheated or underheated. Overheating is wasteful, consequently the thermostat saves gas. Underheating is uncomfortable and unhealthful. The thermostat will pay for itself over and over again, not only in gas economy but in home comfort.



Its installation should be on the gas line about twelve inches from the heater, complete installation instructions being enclosed with each thermostat.

It is always desirable to have reserve heating capacity for the unexpected cold snap. The Automatic Thermostat makes it possible to use the larger, or No. 81 Alcazar heater at no greater expense than the smaller, for with the thermostat only the amount of gas necessary to maintain proper temperature is used. Therefore, the automatic thermostat is an investment, not an expense, that will pay rich dividends and should be a part of every Alcazar gas heater installation.

### To estimate capacity of heater required

The capacity heater required to heat any given space depends entirely upon the size of the space, quality and kind of construction, number of windows or glass area, exposed wall area, number of times the air is changed per hour due to ventilation and natural circulation and finally, the difference between the temperature to which the room is heated and the prevailing temperature out of doors.

In order to learn the amount of heat required to heat a given space, long formulas are often used which necessitate a large amount of measuring and computation. Since there are so many factors entering into these computations, as mentioned above, any one factor being faulty or inaccurate, therefore, causes the entire estimate to become at best a rough approximation. Since gas heaters are rated in output of B. T. U. per hour, the following is an extremely simple method based on the B. T. U. requirement per cubic foot of space for estimating the capacity of our heaters. (B. T. U. means British Thermal Unit, the amount of heat necessary to raise one pound of water one degree Fahrenheit, and is the standard unit in heating engineering.)

Average figures indicate that it requires one B. T. U. per cubic foot of space for each ten (10) degrees difference between the desired inside temperature and the prevailing outdoor temperature.

Let T = the difference between inside temperature and outside temperature divided by 10.

Let C = the cubical content of the space to be heated.

Then  $T \times C \times 1 \text{ B. T. U.} = \text{No. of B. T. U. required to heat that given space.}$

This formula applies to average conditions of wall thickness, building quality, number of windows, etc. and is remarkably accurate.

**Example 1:** An average size living room in the ordinary five room bungalow of today according to many architects is 12 x 22 x 8½. To heat such a room to 70° inside when the outside temperature is 0°:

$$C \text{ or Cubical content } (12 \times 22 \times 8\frac{1}{2}) = 2244$$

$$T \text{ or temperature difference in tens } (0^\circ \text{ to } 70^\circ \div 10) = 7.$$

$$T \times C \times 1 \text{ B. T. U. } (7 \times 2244 \times 1) = 15708 \text{ B. T. U.}$$

Therefore, 15708 B. T. U. are required under the stated conditions to heat that particular room.

NOTE: In older homes living rooms are much smaller, but for our purpose the figures will serve in as much as the other rooms of the older home were perhaps larger.

The following is a table showing ratings of the two sizes of our gas heaters. By comparing the B. T. U. requirement with this table, the size heater necessary is readily apparent. (N following the number stands for natural gas.)

NO. OF HEATER	INPUT RATE B. T. U.	OUTPUT RATE B. T. U.	STEAM RADIATION EQUIVALENT
41 41N	25,000 - 30,000	20,120 - 24,800	87 - 104 sq. ft.
81 81N	50,000 - 70,000	40,500 - 56,000	174 - 240 sq. ft.

Hence the room in Example 1, requiring only 15708 B. T. U. is easily heated by the smaller or No. 41 model heater. Comparing this figure with 24800 B. T. U., the maximum capacity of the heater it is found that the smaller heater will handle, under the above conditions 1½ rooms of the size stated. By the same reasoning the No. 81 model heater will heat under the above conditions over 3½ rooms of that size which is easily the equivalent of a five room bungalow.

In the above examples, the extreme low temperature was assumed. Naturally, temperatures do not remain at the extreme low for a long period or for long times during the year, but to assure ample heat capacity when needed, the extreme must be used. Always recommend the larger heater for with its extremely wide heating range due to its dual burner construction it is no more costly to operate than the smaller and the reserve capacity is always available.

## TO ESTIMATE COST

Estimating the season cost of operation is very apt to be only a close guess, since the variable factors are more apt to throw computation covering a longer period, into error. The temperature maintained at night, number of hours of maintained temperature, quality and kind of building construction, prevailing outside temperature, number of air changes, wind velocity, amount of sunshine, and etc., all bring in variations which tend to affect season cost.



However, a cost per hour of operation can be easily and definitely established. This, instead of an estimate of season cost, should be the figure used.

Knowing the B. T. U. content of the gas used (natural about 1100 B. T. U. and manufactured about 550 B. T. U. per cubic foot), the B. T. U. requirement of a given space and the cost of the gas per 1000 cubic foot it is easy to determine the cost per hour of heating that space. The following example is worked out using natural gas and the room in example 1.

**Example 2:**

B. T. U. content of natural gas 1100 B. T. U. per cubic foot.

B. T. U. requirement of room = 15708.

$15708 \div 1100 = 14.3$ .

Therefore, 14.3 cubic feet of natural gas is used per hour.

Assuming natural gas @ 75c per 1000 cubic feet the cost per hour

would be  $\frac{14.3}{1000} \times \$0.75 = \$0.01$ .

Hence for 1 cent per hour the **room in example 1** could be heated.

At the same gas rate, if Manufactured gas with only one half the B. T. U. content of Natural gas were used, twice the volume would be required and the cost would be 2 cents per hour for heating the same room.

**Example 3:**

The cost per hour of using the larger model heater at its **full lower rating capacity** using natural gas is as follows:

B. T. U. content of natural gas = 1100 B. T. U. per cubic foot  
50,000 B. T. U. = Input rate.

$50,000 \div 1100 = 45.5$ .

Therefore, its consumption is 45.5 cubic feet per hour.

$\frac{45.5}{1000} \times \$0.75 = \$0.034$

Hence for 3.4 cents per hour the model 81 can be operated under the above conditions.

As before, if manufactured gas is the fuel, the cost would be twice as much or 6.8 cents per hour.



COMBINATION  
GAS RANGE  
DIVISION

COMBINATION  
GAS RANGES  
and BUILT-IN  
KITCHEN HEATER  
CABINET  
LOW OVEN  
STYLES



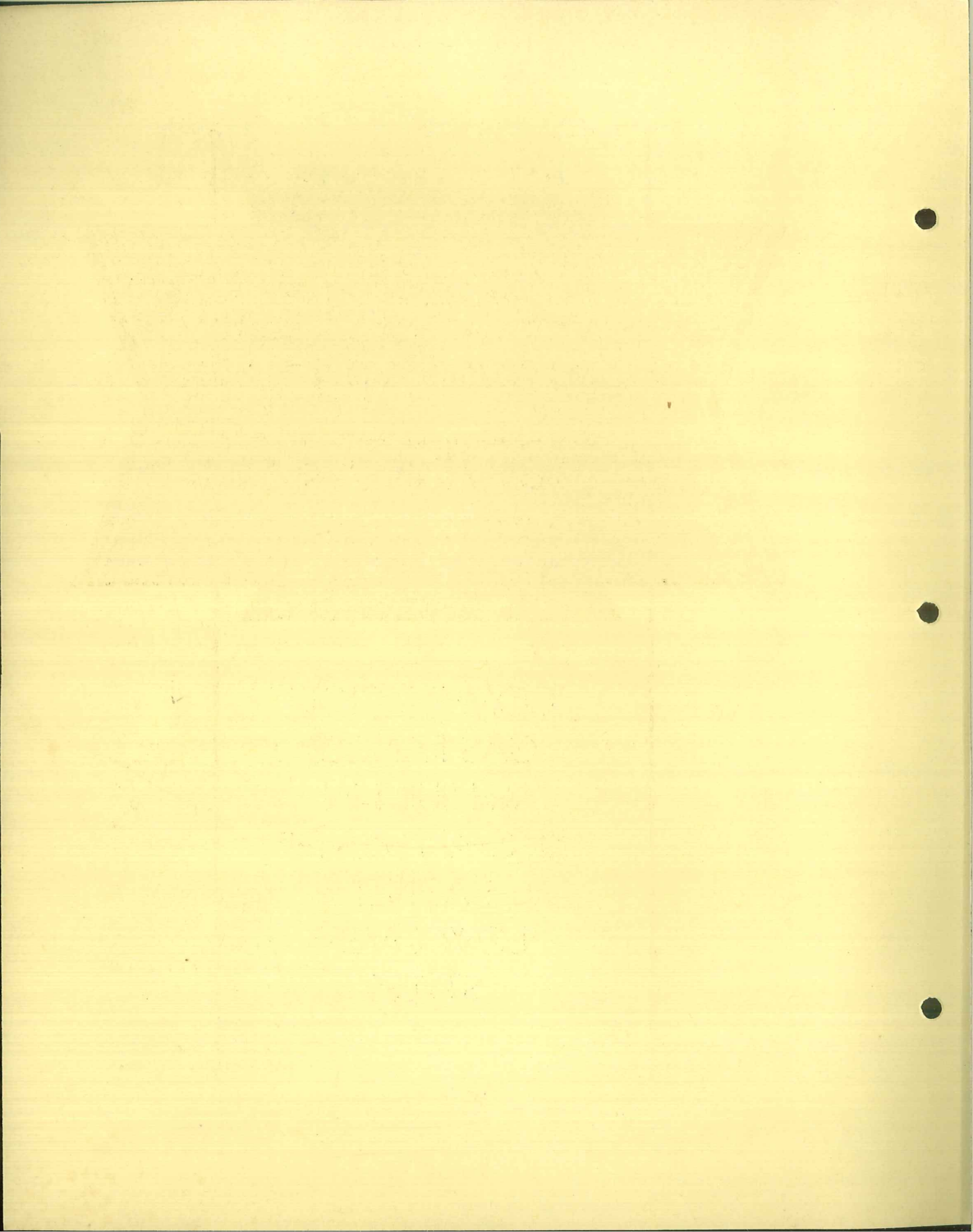

# Alcazar Combination Gas Ranges and Built-in Kitchen Heater

For Gas and Coal or Wood

IN THE Alcazar Combinations the practical, attractive and convenient construction embodies all of the facilities of a complete gas range with the kitchen heater built in to make one attractive unit. The agreeable proportions and graceful lines are decidedly appealing — you can place them on your floor with the confidence that you are offering your trade a distinctive product, unequalled in the field, and one that attracts the eye of every woman entering the store.

These Combination Ranges are the ideal development from the old method of attaching the kitchen heater to the gas range — an arrangement that was more or less cumbersome and left much to be desired in appearance.

Alcazar Combination Ranges are compact and complete, have everything modern methods demand — built for lasting service and are made in a variety of styles to meet every requirement. The heater unit is invaluable when added warmth is needed; in spring and fall when days are chilly but operation of the main heating plant is extravagant, the kitchen heater quickly and conveniently furnishes the necessary heat to take the chill out of the rooms and make them comfortable. The fire can be started quickly and used as long as heat is required with a minimum of expense for fuel. The kitchen heater is likewise convenient at all times for the ready disposal of waste paper and kitchen rubbish.

The kitchen heater is of high grade construction throughout with heavy fire box linings and duplex grates. One of its distinctive advantages is the return flue heat circulation which secures full heating value from the fuel consumed by providing a double flue for heat travel instead of furnishing a short cut to the chimney for the heat to escape. A direct draft damper, however, allows direct travel up the chimney if the heater is used in summer merely for the combustion of kitchen rubbish. The gas kindler, regular equipment on the No. 1700 Series and optional on the No. E2262, is a great convenience in starting fire in the kitchen heater without the use of wood kindling.

The No. 1700 series is provided with the Alcazar broiler drawer, a utility compartment with a drop door, insulated oven, duplex cooking burners, with spreader lighter, Thermolator for oven heat regulation and gas kindler.

The two low oven ranges are ideally suited to the smaller home or apartment kitchen where space is limited. The No. E2262 has duplex cooking burners with spreader lighter and the No. E1262 is equipped with the regular burners.





**No. 1700 R**  
**ALCAZAR COMBINATION GAS RANGE**  
**Insulated**  
**AND BUILT-IN KITCHEN HEATER**

Ivory porcelain enameled, green handles, marbled oven top. Black porcelain enameled cast cook top, burners and top grates. Kitchen heater lids and short center polished blued. Porcelain enameled oven, broiler and door linings, burner tray and broiler pan. Insulated oven, four duplex burners and spreader lighter, broiler drawer. Thermolator, cast iron oven bottom. Return flue kitchen heater equipped with gas kindler. For manufactured or natural gas.

**To be specified:** Alcazar Closetop.

Glass Oven Door, if wanted instead of solid door.

Waterfront for kitchen heater.

Brand of gas, where bottled gas is used.

	Number	Code	Ship. Wgt.
Oven 16x14x20 in. Broiler 16x8x20 in. Gas Cooking Top 19x21½ in. Kitchen Heater Top 11½x21½ in. Cooking Height 33 in. Length over-all 51½ in. Depth 29 in., Height 44½ in.	1700 R 1700 L	Garlix Garlxt	465 lbs. 465 lbs.



**No. E2262**  
**ALCAZAR COMBINATION GAS RANGE**  
**AND BUILT-IN KITCHEN HEATER**

Ivory porcelain enameled, green handles, marbled top shelf. Black porcelain enameled cook top, burners, top grates and end shelf. Kitchen heater lids and short center polished blued. Porcelain enameled oven and door linings and burner tray. Four duplex burners and spreader lighter. For manufactured or natural gas.

To be specified: Alcazar Closetop.  
 Thermolator.  
 Cast Iron Oven Bottom.

Gas Kindler for kitchen heater.  
 Waterfront for kitchen heater.  
 Brand of gas, where bottled gas is used.

Oven 16x12x20 in.  
 Gas Cooking Top 18½x21 in.  
 Kitchen Heater Top 11½x21 in.  
 End Shelf 3½ in.  
 Cooking Height 34½ in.  
 Length over-all 34 in.  
 Depth 29 in., Height 52 in.

Number	Code	Ship. Wgt.
E2262	Garroxe	353 lbs.

1541X7-5-31





No. E1262

**ALCAZAR COMBINATION GAS RANGE  
AND BUILT-IN KITCHEN HEATER**

Spray green porcelain enamel, marbled top shelf, black handles. Cooking top black porcelain enameled, burners and grates japanned, end shelf black rubberoid. Kitchen heater covers and short center polished blued. One giant and three regular burners. Porcelain enameled oven and door linings. For manufactured or natural gas.

To be specified: Alcazar Closetop.

Thermolator.

Cast Iron Oven Bottom.

Lighter.

Waterfront for kitchen heater.

Brand of gas, where bottled gas is used.

Oven 16x12x18½ in.  
Gas Cooking Top 19x20 in.  
Kitchen Heater Top 10¾x20 in.  
End Shelf 3½ in.  
Cooking Height 34¾ in.  
Length over-all 33 in.  
Depth 26½ in., Height 52½ in.

	Number	Code	Ship. Wgt.
	E1262	Garuze	299 lbs.



Patents Pending

No. 3000 R

### ALCAZAR COMBINATION GAS AND ELECTRIC RANGE

Compact, full size range, employing all the latest in both gas and electric cookery. Full size automatic electric oven, **plugs into any baseboard outlet—no special wiring necessary.** Time control can be installed at any time. Three regular size and one giant two-in-one gas burners, instantaneous spreader lighter for cooking top.

Porcelain enameled in Ivory and Nile Green. Oven round-cornered, electrically welded, porcelain enameled both sides, inside is pebbled blue finish. Provided with large vent with visible control. Automatic temperature control. Appliance outlet. Gas cooking section with concealed manifold. Service Drawer. Porcelain enameled Burner Tray.

Oven 14x14x19 in. Cooking Surface including End Shelf 22 $\frac{3}{4}$ x21 in. End Shelf 3 $\frac{1}{2}$ in.	Number	Code	Ship. Wgt.
Cooking Height 32 $\frac{3}{4}$ in.	3000 R	Earstare	242 lbs.
Floor Space 40 $\frac{1}{2}$ x26 in.	3000 L	Earstine	242 lbs.
Oven Unit 1320 Watts			
Broiler Unit 1320 Watts			

Time Control can be added at any time.



## Gas Equipment

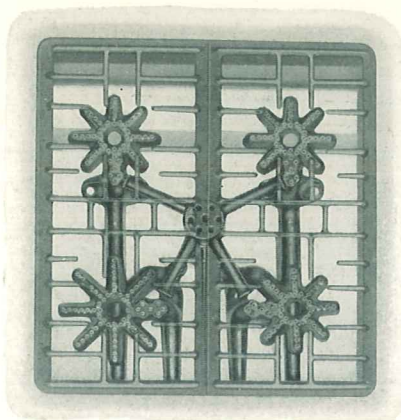

THE TWO-IN-ONE BURNERS provide a complete range of cooking temperatures. A complete turn of the gas cock gives any degree of full flame, boiling flame or simmering flame. No special simmering burner is necessary; each burner acts as a simmerer when desired. No shifting around of cooking utensils—full capacity service always from each of the burners.

NEW SPREADER LIGHTER automatically lights the burners when gas cocks are turned on, without any further operation.

The Two-in-one burners and spreader lighter are so arranged that irrespective of which way the gas cocks are turned on, the burners will light.

Burners are made of one piece cast iron, black porcelain enameled. Readily removed for cleaning and very easy to adjust.

## Electrical Equipment

The electric oven roasts, bakes, broils, is a fireless cooker, and whole meals can be cooked automatically by setting the automatic temperature control to the correct temperature; effects a big saving as electricity is used only part of the time, cooking being done the remaining time on retained heat.

Operates as a **full current control**, eliminating the use of a relay. Non-radio-interfering, not affected by frequency changes or direction of current flow. Works equally well on direct or alternating current.

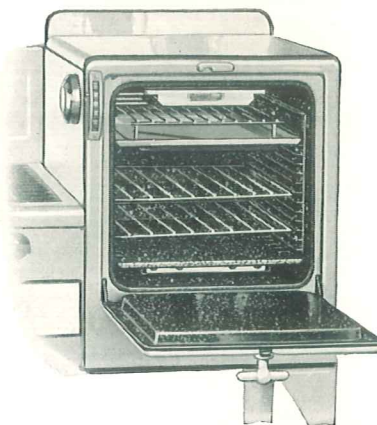

**TIME CONTROL** can be installed at any time. Oven is equipped with eight feet of heater cord and cap plug.

**SWITCH** permits connecting not more than 1320 watts at one time. One switch controls the oven as follows: Pointing up, everything disconnected. First quarter turn to right connects the lower oven unit. The next quarter turn disconnects the lower oven unit and connects the convenience outlet. The next turn of the switch (at the three-quarter point) disconnects the convenience outlet and lower oven unit and connects the broiler unit. The Switch is reciprocating—turns either way.

Needs no special wiring, but will operate from any wall outlet, thus eliminating the electrical installation charge.

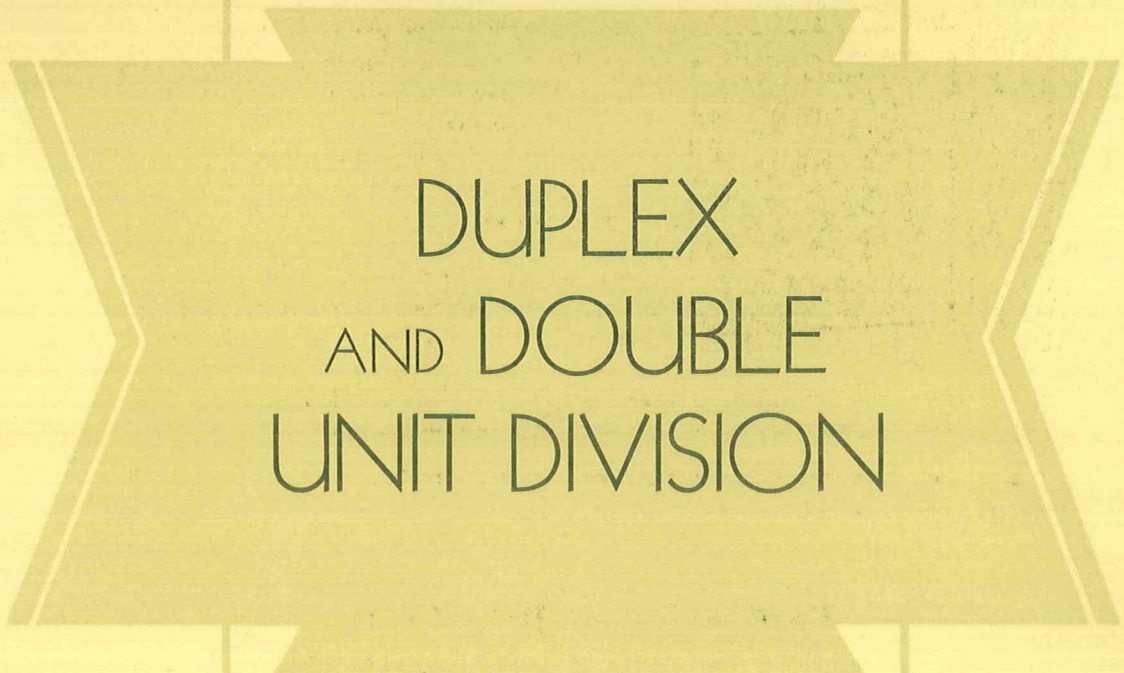

DUPLEX  
AND DOUBLE  
UNIT DIVISION

DUPLEX RANGES  
for COAL or WOOD  
and GAS

DOUBLE UNIT  
RANGES with  
SEPARATE OVENS  
for COAL or WOOD  
and GAS



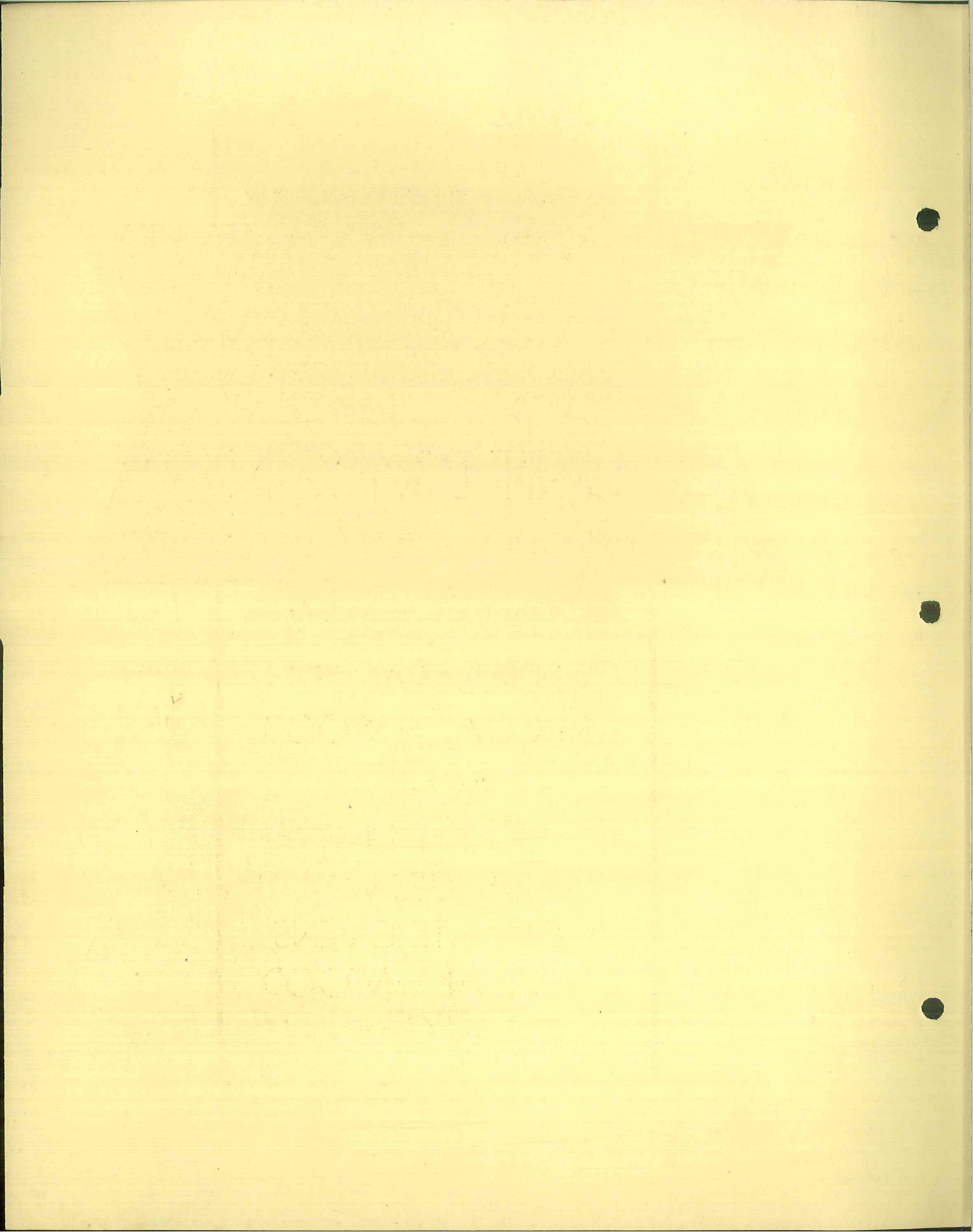

# ALCAZAR DUPLEX

## *Two Ranges in One*

Burns Wood or Coal and Gas, Separately, or Both at Once

**T**HE Pioneer and Original two-in-one range for coal and wood or gas; at once a perfect coal or wood range and a perfect gas range — always ready for service and takes up no more room than one stove. The completeness of the Alcazar Duplex is exemplified in every detail. It is reliable — efficient — economical — convenient and cleanly.

**Fuel** Burns coal or wood, and gas, separately, or both at the same time.

**Top** The frame is of four pieces, and like the key plates and covers, made to resist the action of fire and heat.

**Triplex Expansion Covers** Covers are provided with three lifter holes. One can always be reached from any position; obviates the necessity of bending over a hot range and whirling cover around to insert lifter in hole. The holes, furthermore, being more toward the center cause less strain on the wrist when cover is being lifted. The central ventilated arches and the heavy ribs on the underside of the cover insure its durability. The cover will not fire-crack. Every Alcazar Duplex Range is provided with a reducing cover.

**Cover Lifter** Made to serve both as a cover lifter and grate shaker. It is so shaped that you can lift a cover with greater ease, there being considerably less strain on the wrist than if you used the ordinary kind. Made of malleable iron and is nickel plated.

**Lift-Up Key Plate** The first or left key plate can be raised by means of an always cool, wire handle attached to front end and is automatically held by a ratchet at three different heights. This is a decidedly handy arrangement and very advantageous for broiling, toasting or feeding fuel; it also serves as a check draft to a coal fire, when opened slightly. It is a very simple and practical device and cannot get out of order.

**Flues** Large, clean flues, rightly proportioned, assure a free and perfect circulation to make certain a uniform heating of the oven and to reduce the required amount of fuel to a minimum.

**Oven** Its Distinguishing Feature. Same oven is

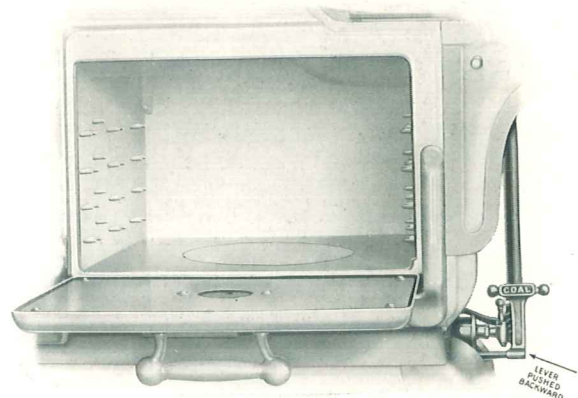

View of oven for coal or wood. Racks have been removed to show its size.



used for both Coal and Gas. Lever on right side of range changes oven from Gas to Coal or vice versa, or for the use of both at same time. There are no loose parts to be lifted out or replaced, therefore cannot be misplaced or lost. It is a simple, automatic device which cannot get out of order. Pull or push the lever and it does the rest.

**For Coal Or Wood**

The Oven has the appearance of a regular range oven and the flue construction insures positively the finest baking or roasting.

**For Gas**

“Pull the Lever” and a round cast iron plate or deflector, in bottom of oven is raised, exposing to view a large, double, powerful Alcazar Burner. By the same movement of the lever, air inlets and ventilators are automatically

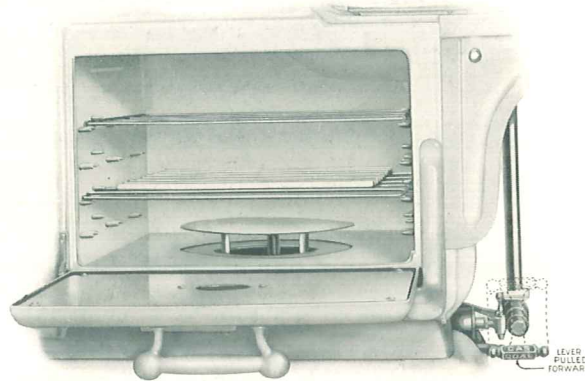

View of oven for gas.

opened. This creates a perfect circulation which insures sweet and wholesome baking on either the upper or lower oven rack. The lower is a closed rack with ventilation opening all around. As the heating is direct, there is not a particle wasted and very little gas is needed to do the work. The top of oven is made especially strong. It is arched, which aids the heat and smoke to move down the right oven flue more quickly. The oven is aluminized. Oven rack can be placed high or low, as desired.

**Oven Door**

Is provided with thermometer which tells at a glance whether oven is hot enough and permits regulation of gas flame without opening door. The door opens downward forming a perfect shelf and is spring balanced. Shuts firmly without slam or jar.

**Fire-Box**

Properly designed and scientifically correct in size, shape and weight so as to hold the right relation to the flues, and insure perfect combustion without waste of heat. Air space behind fire-back, front, rear and left end linings allow same to be thoroughly ventilated and is a guarantee of their lasting qualities. The fireback is made in three heavy sections, — center section being extra heavy and is so constructed as to allow for expansion and contraction. All three sections hang on an iron plate affixed to the oven top and can be taken out and replaced without the use of tools or removing any bolts.

**Grates Duplex**

Simple in operation — save fuel. This grate can be used for either coal or wood, in a moment's time by simply reversing the grates. They are hung on bearings at both ends, independent of the fire-box linings. Can be easily and quickly removed if necessary.

**Ash Chamber** Convenient in size. There is an ash chute which conducts the ashes directly into the ash pan. The galvanized ash pan is large. It has a bail put on in a triangular manner so when lifting it will not cause ashes to drop on the floor. The ash pit door is fitted carefully.

**Top Burners** The gas cooking top is provided with three regular and one giant burners also a simmering burner. Burner tray is porcelain enameled. Concealed manifold with gas valves and lighter button within convenient reach.

**Lighter** The valve is equipped with a button, which, when pressed down, causes a stream of fire to shoot over the top of each burner and, if the gas is turned on, will instantly light any one or all of the burners. There is only one small pilot light. It is well guarded so that it cannot be blown out and on account of the perfect combustion, gives off no odor. So little gas is consumed in proportion to the service it renders, that it is more economical than the use of matches. A cleaner method and always ready.

**Waterfront** Put in place by removing the left end of fire-box lining. Thoroughly tested before shipment. Will answer all essential requirements, heating water thoroughly when coal or wood is burned.

**Kindler-Gas** The Alcazar Gas Kindler does away with necessity of first kindling a fire. By merely putting coal or wood in the fire-box and lighting the kindler, in a few moments the coal or wood is ignited and the gas can be turned off.

**Super Heat Closetop** The Alcazar Super Heat Closetop is an even surface closed cooking top with removable lids over the burners. The entire top becomes the cooking surface as all the heat of the powerful burners is utilized. Even distribution of the heat allows food to be cooked over one of the burners and then moved back so it will continue to boil, simmer or keep warm just as wanted. A number of utensils can be heated at once with the heat of but one burner and they can be set anywhere on the top as the entire top is heated. The even surface permits sliding the cooking utensils around without lifting.

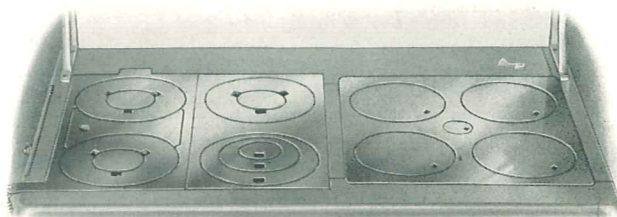

The Super Heat Closetop on the Alcazar Duplex Range

The Alcazar Super Heat Closetop is easily kept clean. It needs only an occasional wiping with an oiled cloth to keep it bright and in good condition. The top can be removed entirely so that the burner-box can be cleaned whenever necessary.



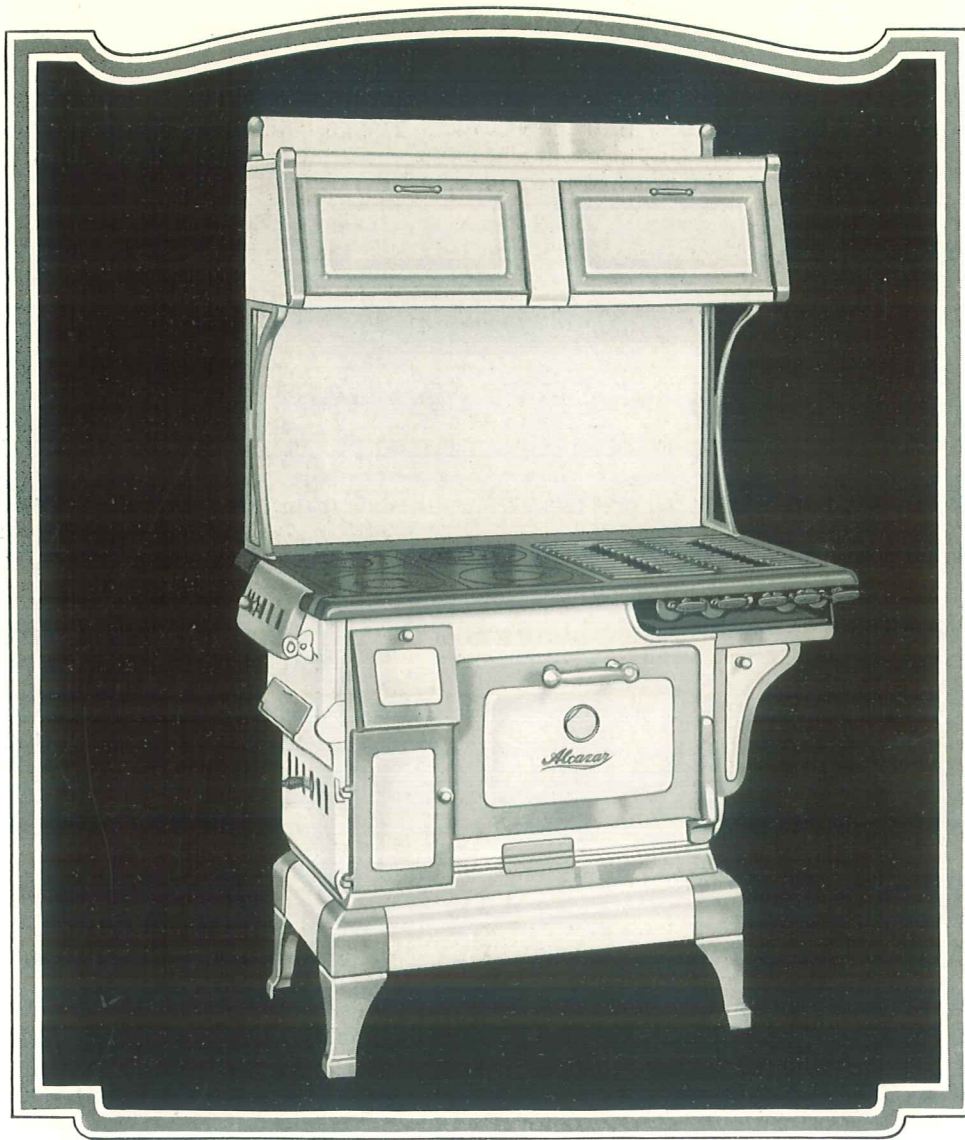

Patented

## ALCAZAR DUPLEX

Two Ranges in One

Burns Coal or Wood and Gas

Porcelain enameled in **White** with **Gray trim, Ivory and Nile Green** or **Ivory and Arabian Tan**. Main Top Grates and Burners porcelain enameled. Four cooking holes for coal, five burners for gas, three regular, one Giant and one Simmering. Concealed manifold. Lighter. Oven Thermometer.

No. of Range	Kind of Gas	Size of Oven	Telegraph Code	Ship. Wgt.
400	Manufactured or Natural	18x18x11	Pythgrel	647 lbs.
400 Closetop			Pythlare	657 lbs.
Color				
Waterfront separate.....				25 lbs.
Waterfront fitted in range..... Add				15 lbs.
Alcazar Gas Kindler fitted in range..... Add				5 lbs.
Buffet Shelf instead of High Closet..... Deduct				52 lbs.
Metropolitan Base No. 280..... Add				80 lbs.

Dimensions Overall: Height 65" Width 43" Depth 31" Cooking Height 32 $\frac{1}{4}$ "

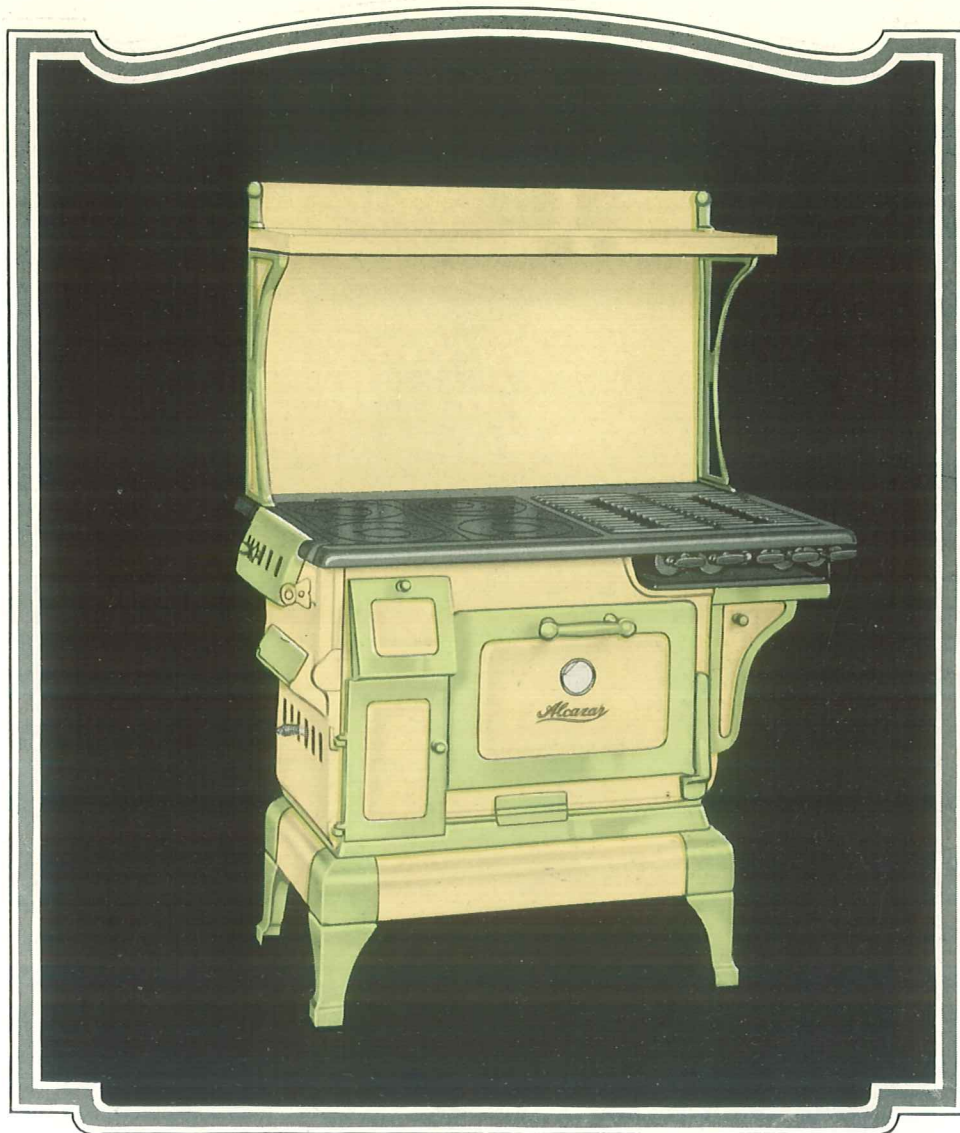

**ALCAZAR DUPLEX WITH BUFFET SHELF** Patented  
**NILE GREEN**

Two Ranges in One — Burns Coal or Wood and Gas

Porcelain enameled in Ivory and Nile Green, Ivory and Arabian Tan or White with Gray trim. Main top, grates and burners porcelain enameled. Four cooking holes for coal, five burners for gas — three regular, one giant and one simmering. Concealed Manifold. Lighter. Oven Thermometer.

No. of Range	Kind of Gas	Size of Oven	Telegraph Code	Ship. Wgt.
400	Manufactured or Natural	18x18x11 in.	Palmgrel	595 lbs.
400 Closetop			Palmclare	605 lbs.
Color				
Waterfront separate.....				25 lbs.
Waterfront fitted in range..... Add				15 lbs.
Alcazar Gas Kindler fitted in range..... Add				5 lbs.
High Closet..... Add				52 lbs.
Metropolitan Base No. 280..... Add				80 lbs.

Dimensions Overall; Height 56½", Width 43", Depth 31", Cooking Height 32½".



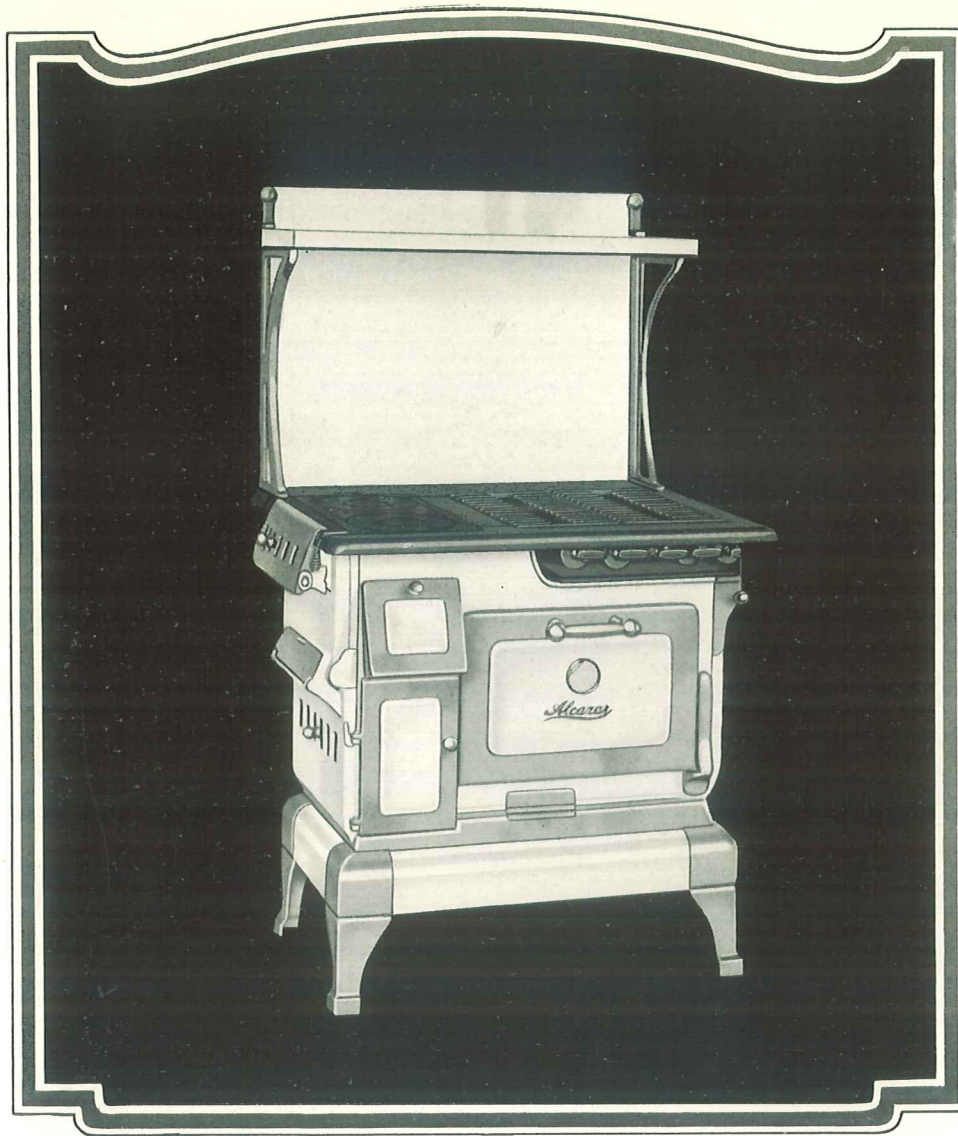

Patented

## ALCAZAR DUPLEX WITH BUFFET SHELF

Two Ranges in One

Burns Coal or Wood and Gas

White porcelain enameled with Gray trim, Ivory and Nile Green or Ivory and Arabian Tan. An Alcazar Duplex Range for small space. Main Top, Grates and Burners porcelain enameled. Two cooking holes for coal, full gas burner equipment, one giant, three regular, one simmering. Concealed Manifold. Lighter. Oven Thermometer.

No. of Range	Kind of Gas	Size of Oven	Telegraph Code	Ship. Wgt.
200	Manufactured or Natural	18x18x11 in.	Pythgrilo	568 lbs.
200 Closetop			Pythmare	578 lbs.
Color				
Waterfront separate.....				25 lbs.
Waterfront fitted in range..... Add				15 lbs.
Alcazar Gas Kindler fitted in range..... Add				5 lbs.
High Closet..... Add				52 lbs.
Metropolitan Base No. 280..... Add				80 lbs.

Dimensions Overall; Height 57½", Width 37½", Depth 31", Cooking Height 33½".

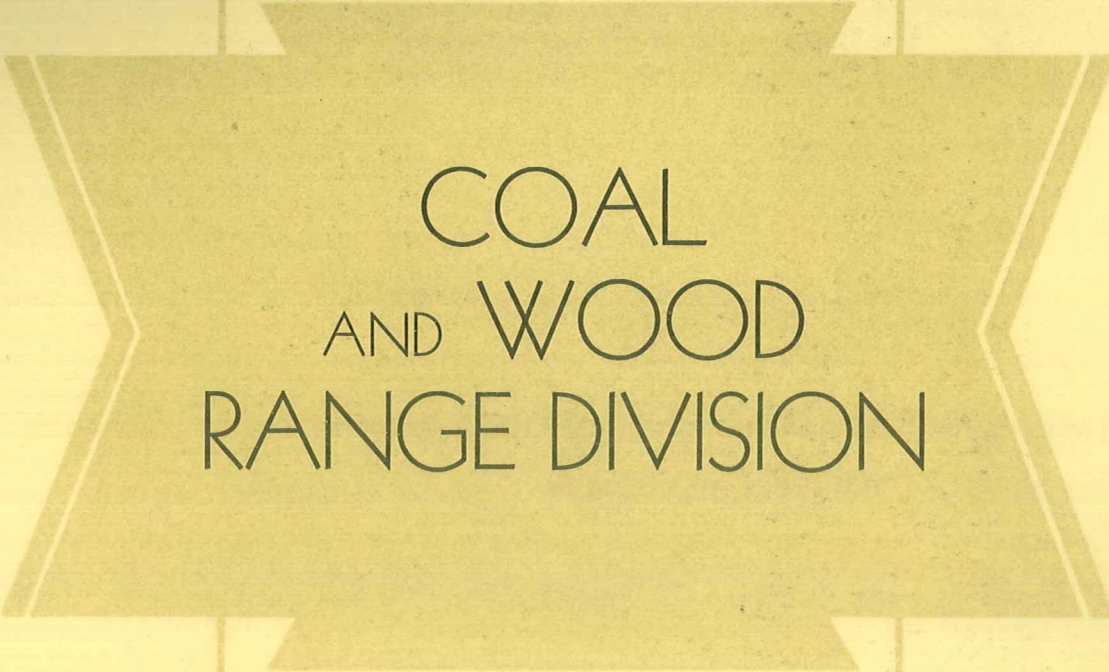

COAL  
AND WOOD  
RANGE DIVISION

ROYAL RANGES  
RESERVOIR  
SQUARE  
with HIGH CLOSET  
with BUFFET SHELF



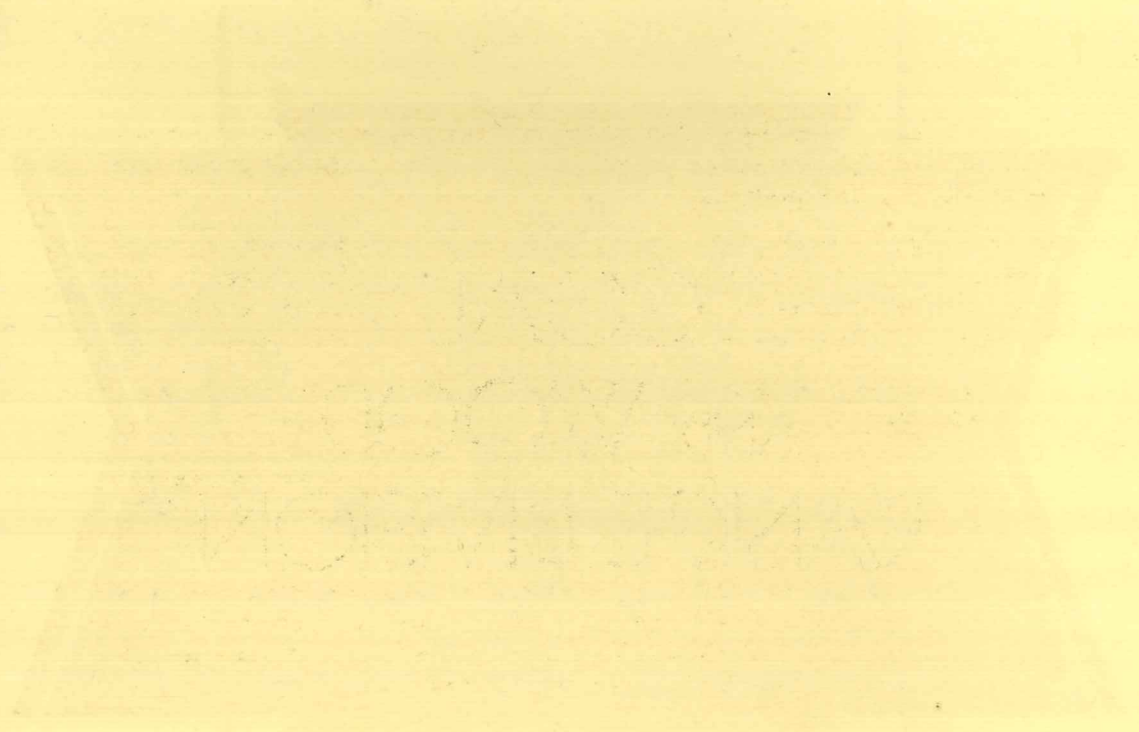

# Alcazar Royal Range

## *For Coal or Wood*

**T**HE Alcazar Royal Range is distinctly a new creation — new in design, to conform to modern demands, and new in construction, embodying many features of proved superiority.

On the ranges in color, the beautiful pastel shades of Nile Green or Arabian Tan are tastefully applied to a background of Ivory. The ranges in white trimmed with Alcazar Gray are of a more neutral tone that fits well into any surroundings. There are no bolts visible to mar the beautiful appearance.

The porcelain enamel surface is impervious to rust or moisture, and can be cleaned as easily as a china plate by rubbing with a damp cloth.

**Body** Is of heavy steel, porcelain enameled inside and out. Specially re-enforced and protected oven top with a cast plate over the top nearest the fire box.

**Oven** The spacious oven is porcelain enameled, absolutely rust-proof, air-tight and dust-tight. The oven bottom is of cast iron, to avoid buckling or warping. Oven door is spring balanced, provided with a friction catch, and fitted with Thermometer.

**Top** The Keyplates and Lids are polished and blued, top frame is porcelain enameled. The first or left Keyplate can be raised by an Alaska cool handle and is automatically held by a ratchet at different heights. Can be provided with French Top if so ordered in place of the two regular right hand Keyplates. The French Top is a single, one-piece plate, used for frying griddle cakes, steaks, etc., directly on the top.

**Fire Box** Large and correctly proportioned — and fitted with heavy cast iron linings properly ventilated; the fire back in three sections and the front in two. Duplex Grates are adaptable for either coal or wood by simply reversing. The ash chamber of ample size is fitted with chutes which guide the ashes into the heavy galvanized ash pan.

**Flues** Flues are of large size and provide an unobstructed course for the proper circulation of heat around the oven, giving it a uniform temperature so necessary for perfect baking and roasting.

**Wood Fire Door** Drop pattern, permits feeding wood from the front when front fire box lining is removed. A Pouch Feed Door is provided at the left end.

**Reservoir** Heated by contact. Made of heavy copper, coated on the inside with pure block tin and surrounded with a steel casing, porcelain enameled.

*Dependable Service, Beauty and Durability* are built into the Alcazar Royal Range.





## ALCAZAR ROYAL RANGE

*NILE GREEN*

**With Buffet Shelf — Copper Contact Reservoir**

Porcelain Enameled in Ivory and Nile Green, Ivory and Arabian Tan or White and Gray. Polished Blued Key Plates and Lids. Porcelain Enameled Top Frame, Reservoir Top and Cover.

No. of Range	No. and Size of Cover	Size of Oven	Telegraph Code	Shipping Weight
8-18 Reservoir Style	6 - 8-inch	18x19x13 in.	Roylandis	423 lbs.
8-20 Reservoir Style	6 - 8-inch	20x21x13 in.	Roylite	475 lbs.
9-20 Reservoir Style	6 - 9-inch	20x21x13 in.	Roylitley	475 lbs.

**To be Specified:**

Color wanted

French Top instead of Key Plates

Waterfront fitted in range..... Add

Waterfront separate.....

15 lbs.  
25 lbs.

Dimensions Overall: Height 55¼", Width 48¼", Depth 30½", Cooking Height 31¾".



**ALCAZAR ROYAL RANGE**

*ARABIAN TAN*

**With Buffet Shelf — Square Style**

Porcelain Enameled in Ivory and Arabian Tan, Ivory and Nile Green or White and Gray. Polished Blued Key Plates and Lids. Porcelain Enameled Top Frame and End Shelf.

No. of Range	No. and Size of Cover	Size of Oven	Telegraph Code	Shipping Weight
8-18 Square Style	6 - 8-inch	18x19x13 in.	Roylack	395 lbs.
8-20 Square Style	6 - 8-inch	20x21x13 in.	Roylack	447 lbs.
9-20 Square Style	6 - 9-inch	20x21x13 in.	Roylackis	447 lbs.

**To be Specified:**

Color wanted		
French Top instead of Key Plates		
Waterfront fitted in range	..... Add	15 lbs.
Waterfront separate	.....	25 lbs.

Dimensions Overall: Height 55¼", Width 41½", Depth 30½", Cooking Height 31¾".





**ALCAZAR ROYAL RANGE**  
*NILE GREEN*  
**With High Closet — Square Style**

Porcelain Enameled in Ivory and Nile Green, Ivory and Arabian Tan or White and Gray. Illustration above shows range equipped with French Top, a single, one-piece plate used for frying griddle cakes, steaks, etc., directly on the top. Porcelain enameled Top Frame and End Shelf.

No. of Range	No. and Size of Cover	Size of Oven	Telegraph Code	Shipping Weight
8-18 Square Style	6 - 8-inch	18x18x13 in.	Roylesque	442 lbs.
8-20 Square Style	6 - 8-inch	20x21x13 in.	Roylesquil	494 lbs.
9-20 Square Style	6 - 9-inch	20x21x13 in.	Roylesquim	494 lbs.

**To be Specified:**

Color wanted	
French Top instead of Key Plates	
Waterfront fitted in range.....Add	15 lbs.
Waterfront separate.....	25 lbs.

Dimensions Overall: Height 64¼", Width 41½", Depth 30½", Cooking Height 31¾".

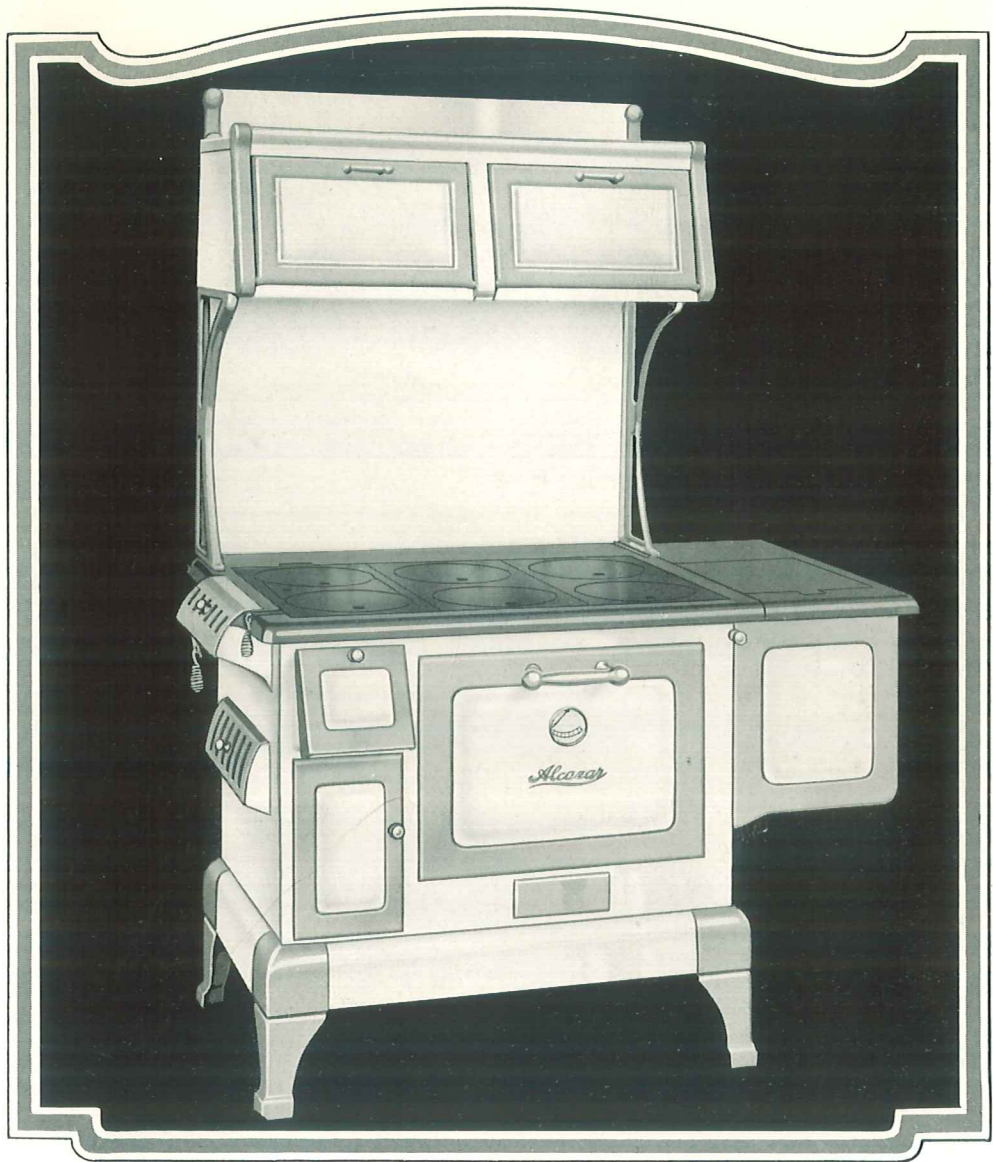

## ALCAZAR ROYAL RANGE

WHITE AND GRAY

With High Closet — Copper Contact Reservoir

Porcelain Enameled in White and Gray, Ivory and Nile Green or Ivory and Arabian Tan. Polished Blued Key Plates and Lids. Porcelain Enameled Top Frame, Reservoir Top and Cover.

No. of Range	No. and Size of Cover	Size of Oven	Telegraph Code	Shipping Weight
8-18 Reservoir Style	6 - 8-inch	18x19x13 in.	Roylabor	470 lbs.
8-20 Reservoir Style	6 - 8-inch	20x21x13 in.	Roylabik	522 lbs.
9-20 Reservoir Style	6 - 9-inch	20x21x13 in.	Roylabam	522 lbs.
<b>To be Specified:</b>				
Color wanted				
French Top instead of Key Plates				
Waterfront fitted in range..... Add				15 lbs.
Waterfront separate.....				25 lbs.

Dimensions Overall: Height 64 $\frac{1}{4}$ ", Width 48 $\frac{1}{4}$ ", Depth 30 $\frac{1}{2}$ ", Cooking Height 31 $\frac{3}{4}$ ".



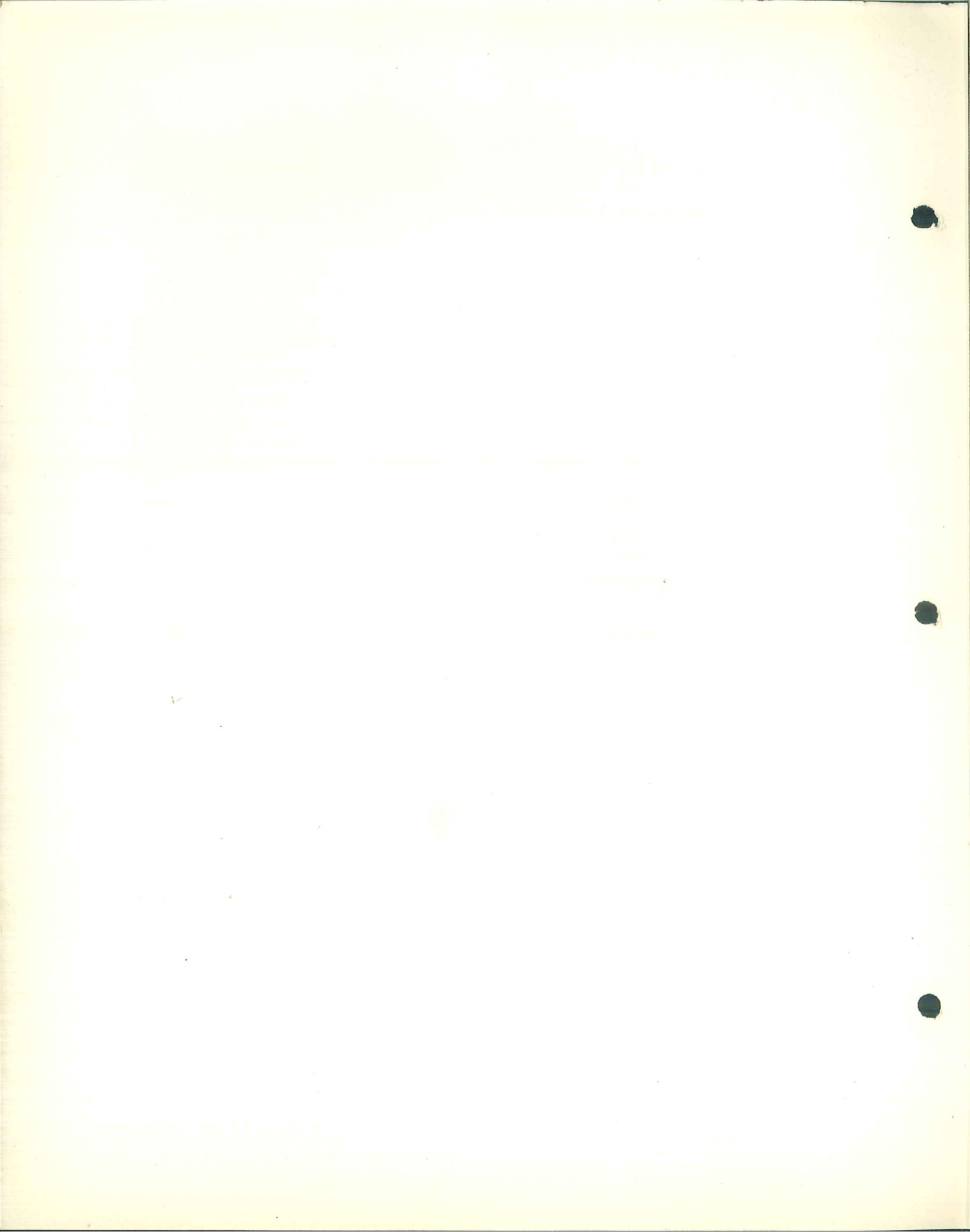

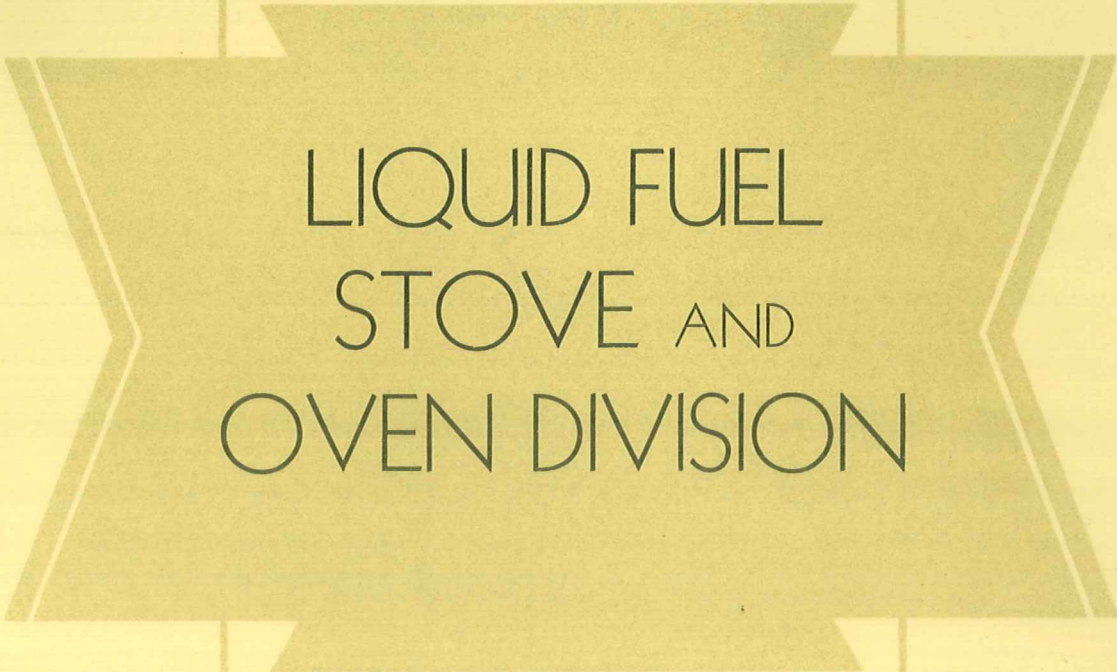

LIQUID FUEL  
STOVE AND  
OVEN DIVISION

PRESSURE GASOLINE  
RANGES, STOVES  
WATER HEATERS  
HEATERS

KEROSENE GAS  
RANGES, STOVES  
LONG CHIMNEY  
RANGES, STOVES  
WICKS  
PORTABLE OVENS



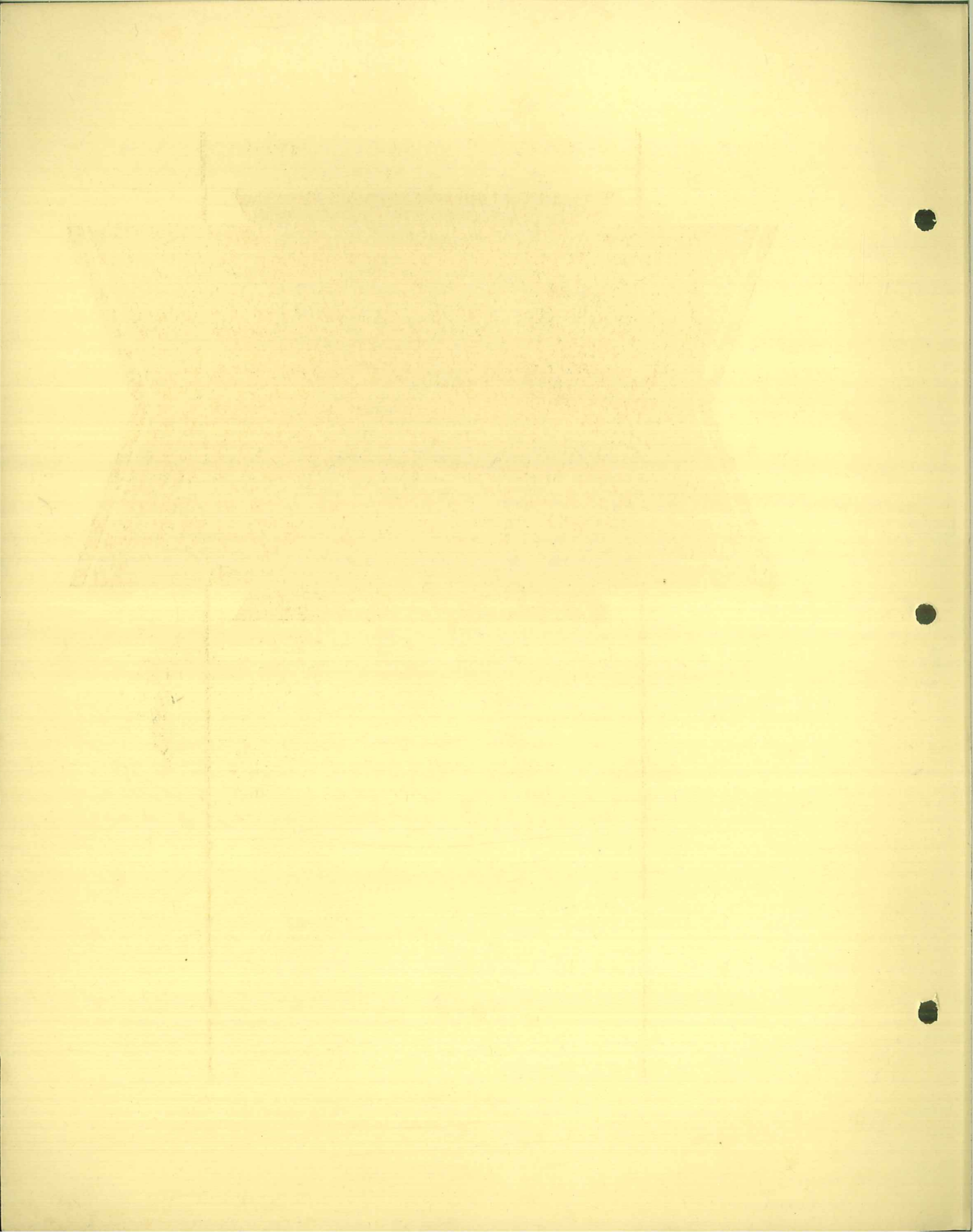

# Alcazar Pressure Gasoline Ranges and Cooks

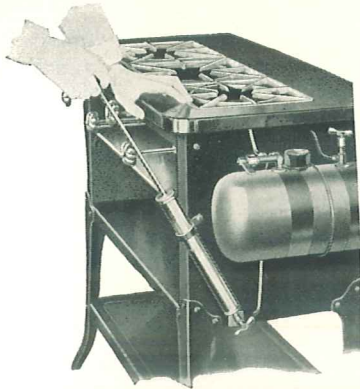

The air-pump is part of the stove itself. Always within convenient reach and easily operated from a natural position.

**Light Direct — Like City Gas. Easy to Use Simple and Dependable**

Baking, roasting, frying, steaming — any foods can be prepared with wonderful success on Alcazar Pressure Gasoline Ranges and Cooks. You cook with a blue gas flame under air pressure — just as though you had city gas service.

**To light** — strike a match and turn a valve — like lighting a city gas range. Lights directly and instantly. No other stove for gasoline gas compares with it.

**It lights directly and instantly** — No blow-torch starting, no priming — no pre-heating tubes or hot blast cups that get out of order.

**Direct safety lighting** — cannot clog — will not flood — is always ready — works every time — simple and reliable.

**No raw gasoline used in lighting** — no danger of flooding when lighting — no gasoline running out should the flame accidentally be blown out or otherwise extinguished while lighting.

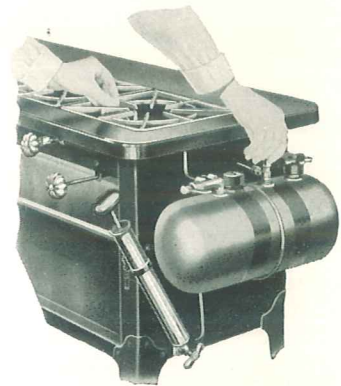

**Lights instantly — like a gas range — no priming, no pre-heating tubes, no hot blast cups.**

**Fuel tank is solid brass** — everlasting — rust-proof and leak-proof. Another desirable feature of Alcazar Pressure Gasoline Ranges and Cooks.

**Oven thermometer** — on all ranges. Temperature readings range from 100 to 600 degrees Fahrenheit. A handy aid for dependable results.



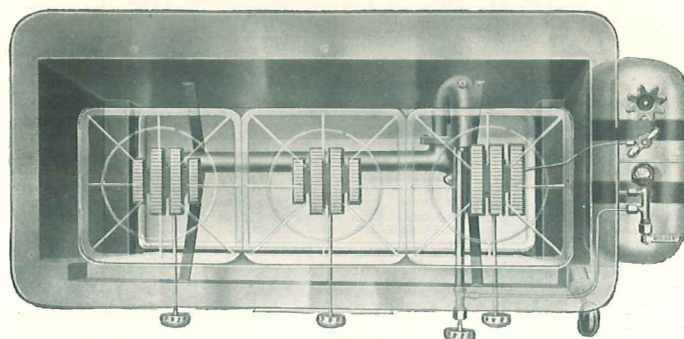

Large open cooking surface — utilizes the heat of the burners to the full extent.

**Uses air for lighting which costs no money** — just a few strokes of the pump provide plenty of air.

**The air pump is built on** — a part of the stove itself; operated from a natural position at a convenient angle — pumps up and down without pushing the stove around.

**Each burner is regulated separately**, turned high or low as required.

**Large open grate area** utilizes the maximum cooking space — two utensils can be placed over one burner — three or four over two. The regular series two burner stove has  $10\frac{1}{2} \times 18\frac{1}{2}$  inches grate surface; three burner  $10\frac{1}{2} \times 28$  inches; four burner  $10\frac{1}{2} \times 38\frac{1}{2}$  inches.

**Perfect combustion provides cleanliness.** No smudge or soot. Utensils do not smoke up. All parts of the stove itself with their durable finish are readily kept clean.

**Each stove is a self-contained unit** — can be set wherever wanted — no connections are required. Fuel and pressure gauge combined. Porcelain enameled valve handles.

**A new touch** of up-to-date smartness is displayed in the variety of sizes and styles which permits suitable selection for every cooking need — cabinet ranges — low oven ranges — 2, 3 and 4 burner cook stoves in various finishes, porcelain enameled, black rubberoid and gray japan.

**The ranges Nos. 948 and 947** are offered in White and Gray or lustrous Ivory porcelain enamel beautifully trimmed in delicate pastel shades of Nile Green or Arabian Tan.

The true color harmony obtained by the pastel shades on ivory porcelain enamel, ideally expresses the new vogue for color in the kitchen. Applied with a sense of moderation, the pleasing tones enhance the natural attractiveness of Alcazar Pressure Gasoline Ranges and bring a new note of cheer to the present-day kitchen.



No. 948 R or L — Nile Green

**ALCAZAR PRESSURE GASOLINE RANGE**

Body Porcelain Enameled in Ivory and Nile Green, Ivory and Arabian Tan or White and Gray. Porcelain Enameled Oven, Broiler and Door Linings, Burner Tray and Broiler Pan. On Ranges in color Top Grates are Black Porcelain Enameled with border in colors; on White and Gray Ranges Top Grates are black japanned. Fitted with Broiler Drawer, Glass Oven Door, Oven Thermometer, Service Drawer, Removable Top Grates, 4 Top Cooking Burners and Oven Burner.

**To be Specified:**—Ivory and Nile Green as shown, Ivory and Arabian Tan or White and Gray. Right or Left Oven.

Dimensions	Number	Telegraph Code	Shipping Weight
Cooking Height 34½ in. Oven 18x14x20 in. Broiler 18x9x20 in. Cooking Top 21½x21 in. End Shelf 3½ in. Length over-all 50½ in. Depth 29½ in.; Height 53½ in.	948 R	Praglut	278 lbs.
	948 L	Praglore	278 lbs.



OF the very newest design, the appealing beauty of this range is delightfully distinctive.

The extra large high oven is porcelain enameled inside — rust-proof and easily cleaned.

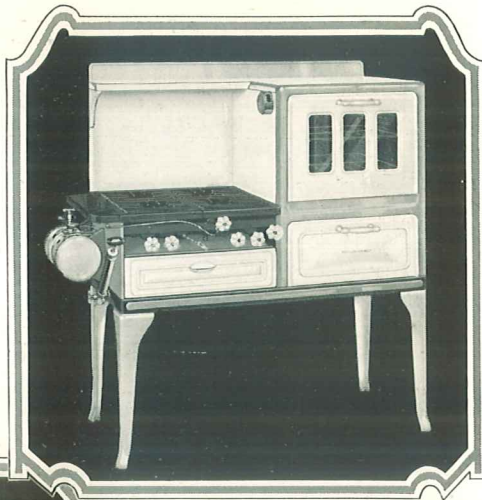

No. 948 R or L  
ALCAZAR PRESSURE  
GASOLINE RANGE



No. 948 R or L Arabian Tan  
ALCAZAR PRESSURE GASOLINE RANGE

WITH every facility that the most exacting housewife can demand, they combine attractive appearance; the beauty of the porcelain enamel finish is doubly important, for it is most practical as well. Cleaned as easily as a china plate.

### BROILER DRAWER

An outstanding feature of the No. 948 Series is the Broiler Drawer. Broiled foods are more appetizing, digestible, nourishing and healthful. In these Alcazar Pressure Gasoline Ranges broiling can be done as frequently as desired because of the convenience of the broiler drawer. This brings the food within reach quickly for turning without risk of scorched hands or arms. The front door drops to a horizontal position providing a rigid shelf for placing the platter when transferring food to or from the broiler rack.

With this broiler drawer, broiling is made delightfully convenient.

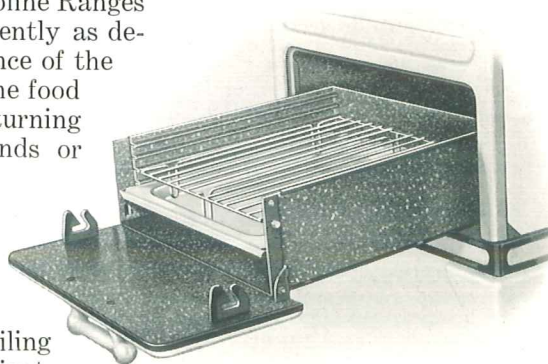

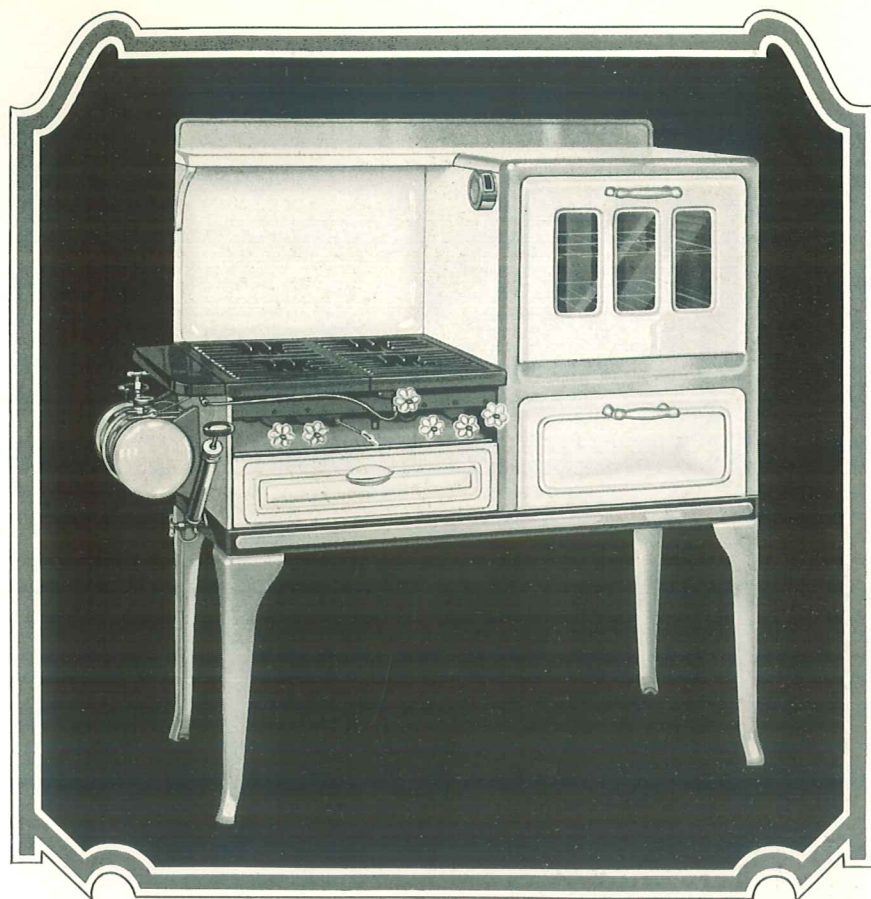

No. 947 R or L

### ALCAZAR PRESSURE GASOLINE RANGE

Body Porcelain Enameled in White with Gray Trim, Ivory and Nile Green Trim or Ivory and Arabian Tan Trim. Porcelain Enameled Oven, Broiler and Door Linings, Burner Tray and Broiler Pan. On Ranges in color Top Grates are Black Porcelain Enameled with border in colors; on White and Gray Ranges Top Grates are black japanned. Glass Oven Door. Oven Thermometer. Service Drawer. Removable Top Grates, 4 Top Cooking Burners and Oven Burner.

**To be Specified:**—White and Gray, Ivory and Nile Green or Ivory and Arabian Tan Porcelain Enamel. Right or Left Oven.

Dimensions	Number	Telegraph Code	Shipping Weight
Cooking Height 34 ½ in. Oven 18x14x20 in. Broiler 18x9x20 in.	947 R	Pragmute	263 lbs.
Cooking Top 21 ½x21 in. End Shelf 3 ½ in. Length over-all 50 ½ in. Depth 29 ½ in.; Height 53 ½ in.	947 L	Pragmable	263 lbs.



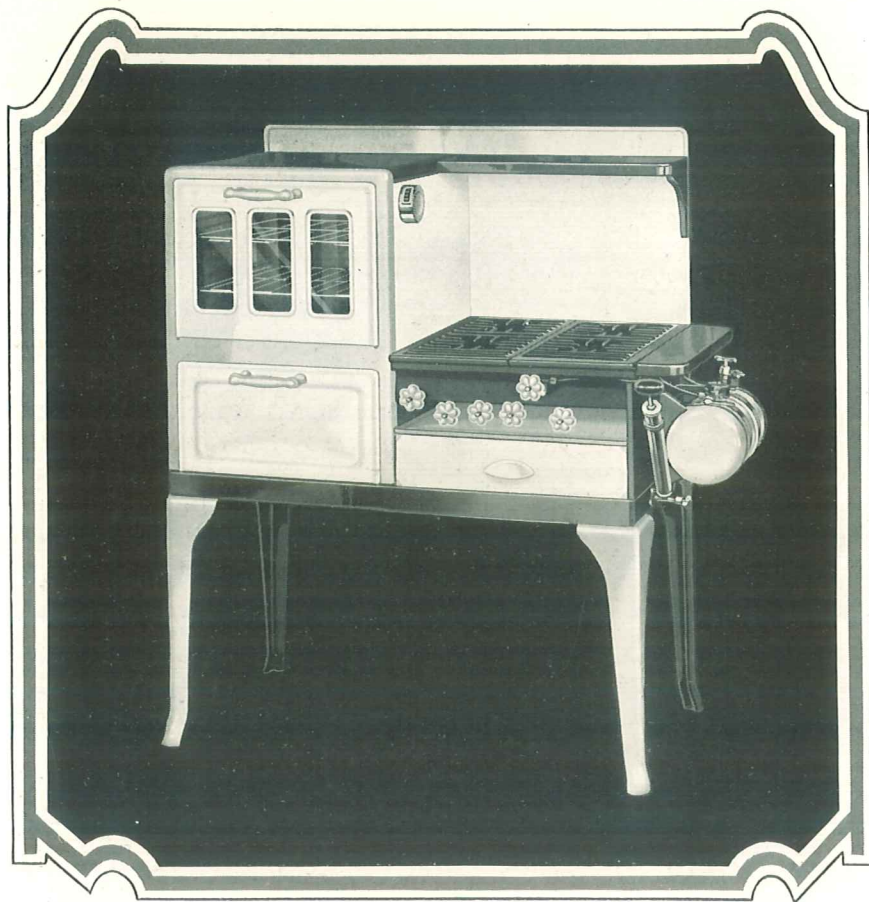

No. 945 R or L

ALCAZAR PRESSURE GASOLINE RANGE

Oven Side, Back Splasher, Oven and Broiler Doors and Service Drawer Front, White Porcelain Enameled. Main Front, Front Legs and Backguard Gray. Anti-rust Metal Oven and Broiler Linings and Door Linings. Porcelain Enameled Burner Tray and Broiler Pan. Removable Top Grates, 4 Top Cooking Burners and Oven Burner. Glass Oven Door. Oven Thermometer. Service Drawer.

To be Specified:—Right or Left Oven.

Dimensions	Number	Telegraph Code	Shipping Weight
Cooking Height 33½ in. Oven 16x12x18½ in. Broiler 16x8½x18½ in. Cooking Top 19x20 in. End Shelf 3½ in. Length over-all 45 in. Depth 27 in.; Height 50½ in.	945 R	Pragmill	232 lbs.
	945 L	Pragmire	232 lbs.



No. 934 R or L

**ALCAZAR PRESSURE GASOLINE RANGE**

White porcelain enameled Oven Door, Side and Back Splashes. Body Sides, Back, Legs and Backguard finished in Gray Japan. Remainder of Range Black. Anti-rust metal Oven and Door Linings. Cast iron oven bottom with removable lid. Removable Top Grates. Three top cooking burners and oven burner. Oven Thermometer. Steel Fuel Tank.

To be specified:—Right or Left Oven.

Dimensions	Number	Telegraph Code	Shipping Weight
Cooking Height 31½ in. Oven 16x12x18½ in. Cooking Top 30¾x19 in. End Shelf 8½ in. Length over-all 60 in. Depth 23 in.; Height 50 in.	934 R	Pacifilde	206 lbs.
	934 L	Paciforte	206 lbs.



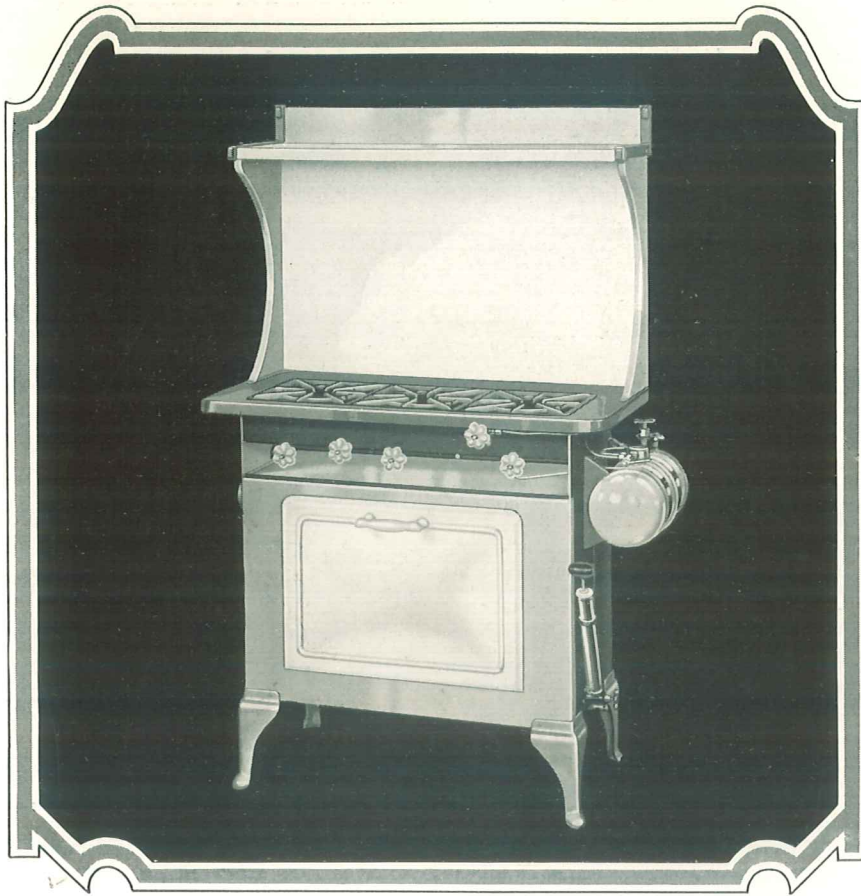

No. 983

**ALCAZAR PRESSURE GASOLINE RANGE**

Low Oven Style

Three Top Cooking Burners and Oven Burner

Main Front, Cooking Top and Burner Tray Gray Porcelain Enameled, Oven Door White. Anti-rust Metal Oven Linings. Oven Thermometer. Removable Top Grates. Provides complete cooking service and is especially desirable where kitchen space is limited.

Dimensions	Telegraph Code	Shipping Weight
Cooking Height 33 in. Oven 20x14x13½ in. Cooking Top 35x17½ in.	Prakure	146 lbs.

**HIGH SHELVES**

Gray Japan Splasher

White Porcelain Enameled Splasher

No.	Shipping Weight	Telegraph Code	For No.	No.	Shipping Weight	Telegraph Code
39	26 lbs.	Jabella	983	309	31 lbs.	Porlabe



No. 1839

**ALCAZAR PRESSURE GASOLINE COOK**

Body finished in Gray Japan. Gray Porcelain Enameled Cooking Top. Porcelain Enameled Burner Tray. Entire back of stoves is closed, making body rigid and protecting the flame against stray drafts. Clean, powerful hot flame without soot or smoke.

No.	Burners	Size of Top	Cooking Height	Telegraph Code	Shipping Weight
1829	Two	25 1/2 x 17 1/2 in.	31 1/2 in.	Prance	66 lbs.
1839	Three	35 x 17 1/2 in.	31 1/2 in.	Prancelf	76 lbs.
1849	Four	43 1/2 x 17 1/2 in.	31 1/2 in.	Prancom	91 lbs.

**HIGH SHELVES**

Gray Japanned Splasher

White Porcelain Enameled Splasher

No.	Shipping Weight	Telegraph Code	For	No.	Shipping Weight	Telegraph Code
29	22 lbs.	Jabez	2 burner	209	25 lbs.	Porline
39	26 lbs.	Jabella	3 burner	309	31 lbs.	Porlabe
49	31 lbs.	Jabite	4 burner	409	36 lbs.	Porlass



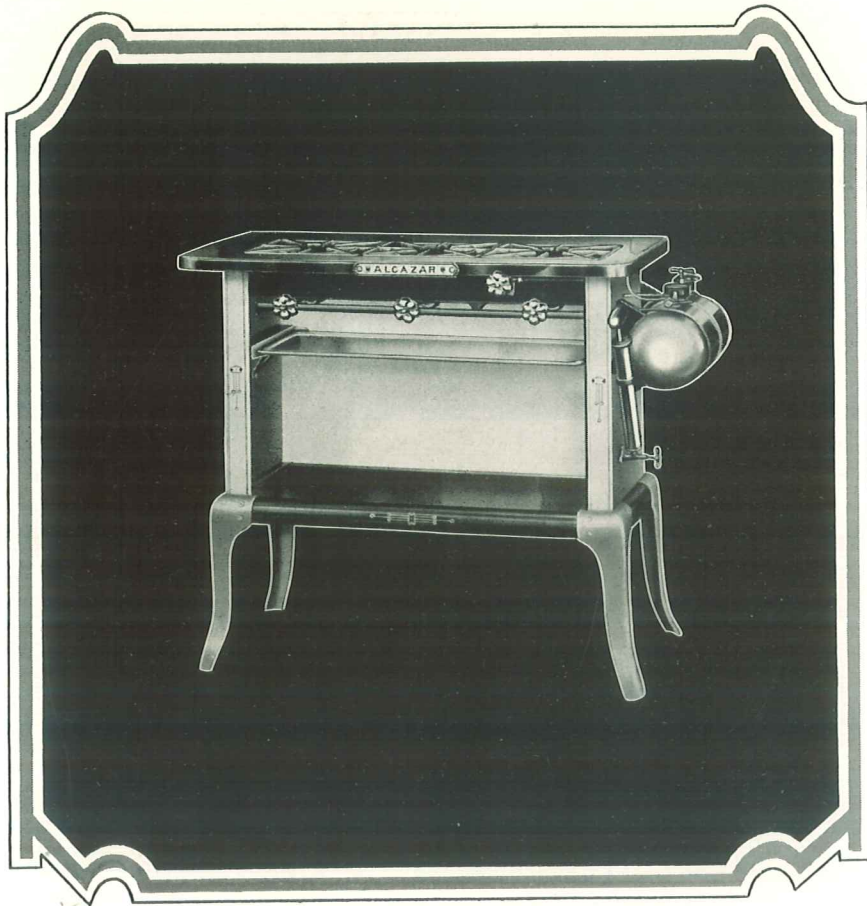

No. 839

**ALCAZAR PRESSURE GASOLINE COOK**

Gray Japan finished body with black rubberoid Top and Lower Shelf. Porcelain Enameled Burner Tray. Intense cooking heat furnishes quick service and economical operation. Extreme simplicity of lighting and dependable service endears them to housewives.

No.	Burners	Size of Top	Cooking Height	Telegraph Code	Shipping Weight
829	Two	25½x17½ in.	31½ in.	Pratique	65 lbs.
839	Three	35 x17½ in.	31½ in.	Pratol	75 lbs.
849	Four	43½x17½ in.	31½ in.	Prature	90 lbs.

**HIGH SHELVES**

Gray Japanned Splasher

White Porcelain Enameled Splasher

No.	Shipping Weight	Telegraph Code	For	No.	Shipping Weight	Telegraph Code
29	22 lbs.	Jabez	2 burner	209	25 lbs.	Porline
39	26 lbs.	Jabella	3 burner	309	31 lbs.	Porlabe
49	31 lbs.	Jabite	4 burner	409	36 lbs.	Porlass



THESE are exceedingly convenient where ready portability is a factor or space is limited.

### ALCAZAR PRESSURE GASOLINE STOVES

Low Style

Finished in black rubberoid.  
Extreme Height, 9½ in. Separate air pump.

No.	Burners	Size of Top	Telegraph Code	Shipping Weight
129	2	25½x17½ in.	Pravity	47 lbs.
139	3	35 x17½ in.	Prawn	58 lbs.

### ALCAZAR PRESSURE GASOLINE WATER HEATER

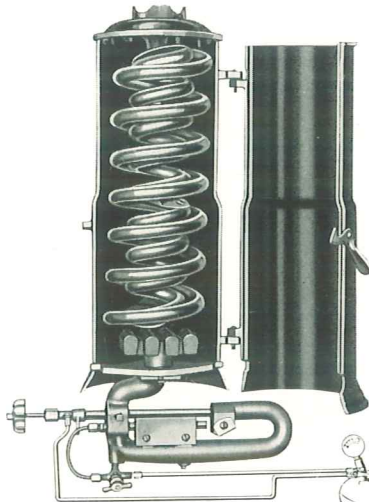

No. 9 Pressure Gasoline Water Heater

SUPPLIES hot water quickly at low cost. The jacket is cast iron finished in black japan. Front half opens as a door making the entire inside readily accessible.

Heavy double ¾ inch copper coil, provides ample capacity for all domestic uses. Can be installed in the basement or kitchen in connection with any hot water tank. Fitted with regular Alcazar Pressure Gasoline Burner.

Must be used in connection with the pressure gasoline Storage Tank.

Total Height.....	21 in.
Diameter.....	7 in.
Copper Coil, dia.....	¾ in.
Shipping Weight.....	35 lbs.
Telegraph Code.....	Primate





No. 275

## ALCAZAR PRESSURE GASOLINE HEATER

Five Double Radiants

Simple, direct lighting — quick, intense heat at low cost — are provided by Alcazar Pressure Gasoline Radiant Heaters.

The pre-heater burner lights instantly. There is no needle point nor pre-heater generator tube to clog with carbon. The pre-heater is of cast iron does not need replacing, and because of its sturdy construction, is not affected by heat.

Alcazar Pressure Gasoline Radiant Heaters because of their convenient portability are invaluable for many needs. In the home, the bedroom, bath, nursery, study, living room or kitchen are all places where extra heat is required at times. In offices, ticket booths, stations, lobbies or similar locations their efficient, dependable service is unsurpassed.

The Body of the No. 275 Alcazar Radiant Heater is of heavy gauge steel, deep brown velvet webbed finish. Cast iron top is porcelain enameled furniture finish. Reflector and front shield highly polished copper. Trim oxidized bronze.

Equipped with combination volume and pressure gauge. Top provides space for heating small utensils or water container. Heats by both radiation and circulation.

### The Most Attractive Portable Heater Made

Width Over-all	Depth	Height	Telegraph Code	Shipping Weight
23 $\frac{3}{4}$ in.	12 in.	24 $\frac{1}{2}$ in.	Presator	80 lbs.



## ALCAZAR PRESSURE GASOLINE RADIANT HEATERS

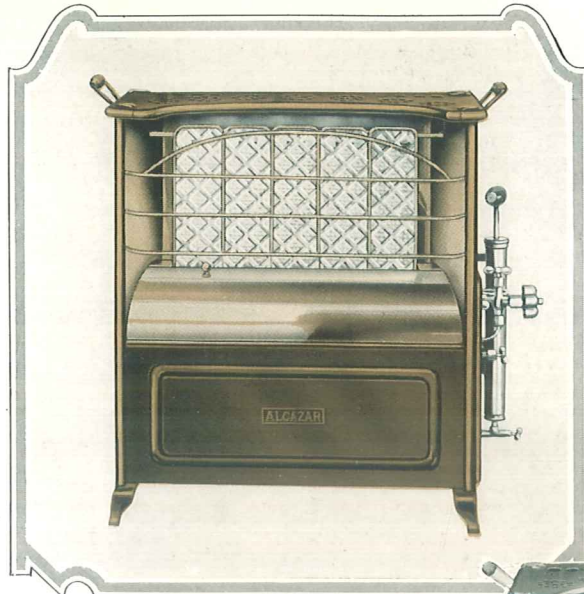

**No. 192 — Five Double Radiants.  
Furniture Finish Porcelain Enamel.**

### Economy

Every particle of combustible material of the fuel is utilized. Scientifically constructed air flues throw the heat where it is wanted.

### Construction

Body is heavy gauge steel with highly polished copper reflector and front shield. The legs are of cast iron and give the greatest possible stability. Radiants are securely held in position and easily removable if occasion demands.

**C**HEERFUL, comforting heat wherever needed, any time. Can be carried from place to place — wherever heat is desired — without a thought given to connections of any kind since the entire unit is self-contained and immediately ready for use as it stands.

### Easy to Light

There is no holding of a match under the lighter to pre-heat with the consequent risk of burnt fingers; no needle point to clog up with carbon; no priming torch, cup or similar device is used.

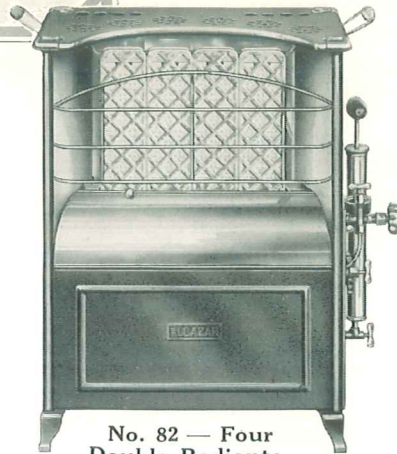

**No. 82 — Four  
Double Radiants.  
Black Rubberoid Finish.**

### FIVE DOUBLE RADIANTS

No.	Finish	Dimensions	Code	Ship. Wgt.
192	Porcelain Enamel	Width of Top, 19 in. Depth, 9½ in. Height, 21¾ in.	Pregas	49 lbs.
182	Black Rubberoid	Dimensions same as above	Pregore	48 lbs.

### FOUR DOUBLE RADIANTS

No.	Finish	Dimensions	Code	Ship. Wgt.
92	Porcelain Enamel	Width of Top, 16½ in. Depth, 9½ in. Height, 21¾ in.	Pregarish	46 lbs.
82	Black Rubberoid	Dimensions same as above	Pregale	45 lbs.

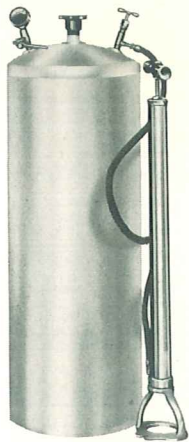

No. 10

## ALCAZAR PRESSURE GASOLINE STORAGE TANK

More than one stove or other gasoline cooking or heating appliances can be connected to the same outdoor tank, providing a gas system which compares favorably with regular city gas.

A wall valve is substituted in place of the tank shut-off valve, the air being drawn from the large tank, led through the small brass tank and controlled by the lighter valve on the brass tank as usual.

The outdoor tank as furnished includes the tank complete with pressure gauge, shut-off valve, pump valve, one cylindrical foot pump and cap for shutting off fuel line. Tubing should be ordered extra by the foot, each length of tubing having two unions and two ferrules for connections. A wall shut-off valve which can be attached to the wall near the stove is required as a safety feature in case the generator valve is not closed.

Code.....Storank Ship. Wgt.....25 lbs.

### LIST OF PARTS

- T1 Solid Ferrule and Union
- T2 Ferrule and Union
- T3 Coupling
- T4 Tee
- T6 Pump only
- T7 Wall valve
- T8 Hollow wire, 10 ft.
- 10 Tank and Pump

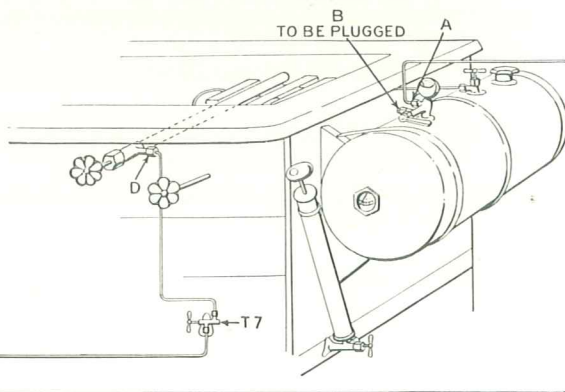
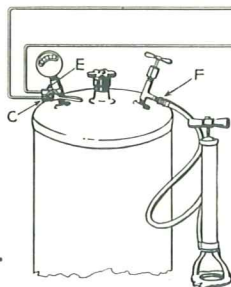

Illustration showing method of attaching Alcazar Pressure Gasoline Storage Tank.



T1



T3

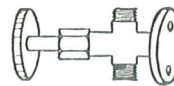

T7

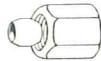

2



T4



T8

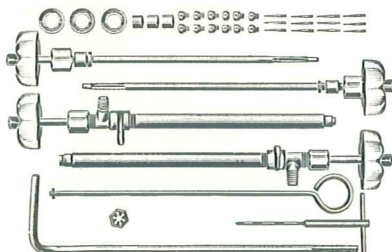

### ALCAZAR PRESSURE GASOLINE SERVICE KIT

Contains necessary tools and parts with directions for properly cleaning and re-conditioning pressure stoves all put up in a serviceable wooden box with sliding cover. Contains the following:

2 Generators complete.  
6 Valve Stem Needles for Stoves.

6 Generator Needles for Ranges.  
3 Filler Cap Gaskets.  
6 Spuds for Stoves.

6 Spuds for Ranges.  
2 Generator Valve Stems complete.  
3 Asbestos Ring Packings.

1 Cleaning Scraper.  
1 Cleaning Drill.  
1 Cleaning Tap.  
1 Cleaning Die.

Shipping Weight.....5 lbs.

Telegraph Code.....Serkit

# Alcazar Kerosene Gas Ranges and Cooks

*Burn 400 Gallons of Air to  
each Gallon of Kerosene Oil*

**U**NEXCELLED convenience and cleanliness — lighted and extinguished simply and quickly — none of the bother of the ordinary oil stove. Automatically the patented brass burner together with the drum generates gas from kerosene oil and air and burns it. The gas produces an intensely hot blue flame — two flames in one. Always under perfect control — a mere turn of the control wheel increases or decreases the flame to the exact degree wanted.

The flame is concentrated directly on the cooking vessel or right up under the oven — no spread of heat as with the ordinary oil stoves. This concentration of heat means cooking more quickly done and less oil consumed as well as a cool kitchen on hot days.

Burning gas as the Alcazar Kerosene Gas Cook does means a clean, sweet kitchen — better air for breathing and makes cooking a pleasure. In addition, the saving of money and the saving of time which it accomplishes makes it by far the best stove.

**Patented  
Brass  
Burner** Is made of solid brass without a seam — rust-proof. Both shells, inner and outer, are drawn in such a manner that they are one — entirely seamless. The finest piece of drawn work ever produced. Mechanics marvel at its construction. Lighting is simplicity itself — just turn up the wick — touch a match and lower burner drum. The flame can then be regulated in intensity as desired. To extinguish simply turn the wick down — the heat stops almost instantly — then the burner drum is raised.

**Oil Inlet** The Oil Inlet on the Alcazar Burner is at the bottom, thus guarding against water which may collect in the kerosene from entering the burner. The union nut connection of the burner to the feed pipe secures positive contact without any chance of tilting.

**Wick  
Raising  
Device** This has two cog wheels with three points of support for the stem. It grips the wick carrier at all times, assuring perfect operation and free adjustment of the wick.

**Burner  
Drum** Scientifically constructed to extract the maximum amount of gas from the oil and mix it with the proper amount of air for perfect combustion. Burns like a gas range — not like a lamp.



# Alcazar Kerosene Gas Ranges and Cooks

- Square Top Grates** Extra large square Top Grates provide more cooking surface and avoid smothering of the flame. Each grate measures  $9\frac{1}{4} \times 10\frac{1}{2}$  inches. Permits the use of two utensils over one burner — three or four over two.
- Removable Tray** Porcelain Enameled Burner Trays can be removed and taken to the sink to wash off drippings from cooking. Highly sanitary.
- Main Body** Entire back and sides of the body are closed, making the same rigid. This closed construction also shelters the flame from stray drafts and protects the person cooking at the stove.
- Glass Tank** The supply of fuel can always be seen — has bail and handle for easy carrying.
- Sub-Tank** Sub-Tank under the Glass Kerosene Oil Fount is made of brass — rust-proof. Another lasting feature of Alcazar Kerosene Gas Ranges and Cooks.
- Feed Pipe** Is easily drained, should occasion demand, by simply removing slip cap at the end and tipping up stove.
- High Shelves** Made in two types, substantial, practical and full size. One all japanned with a splash back in Alcazar Light Gray. The other is made with white Porcelain Enameled Splash Back.
- Assortment** The variety of styles and sizes is ample so that easy selection for any kitchen requirement is provided.

## IMPORTANT

Use only genuine Alcazar wicks in the burners of the Alcazar Kerosene Gas Cooks or Ranges. Alcazar wicks are fitted to Alcazar Burners. They are true to size and the perforations in the wick carrier are correctly spaced to mesh properly with the wick raiser.

To identify the genuine two blue stripes are woven into the wick. Be sure you use Alcazar Blue Stripe Wicks.

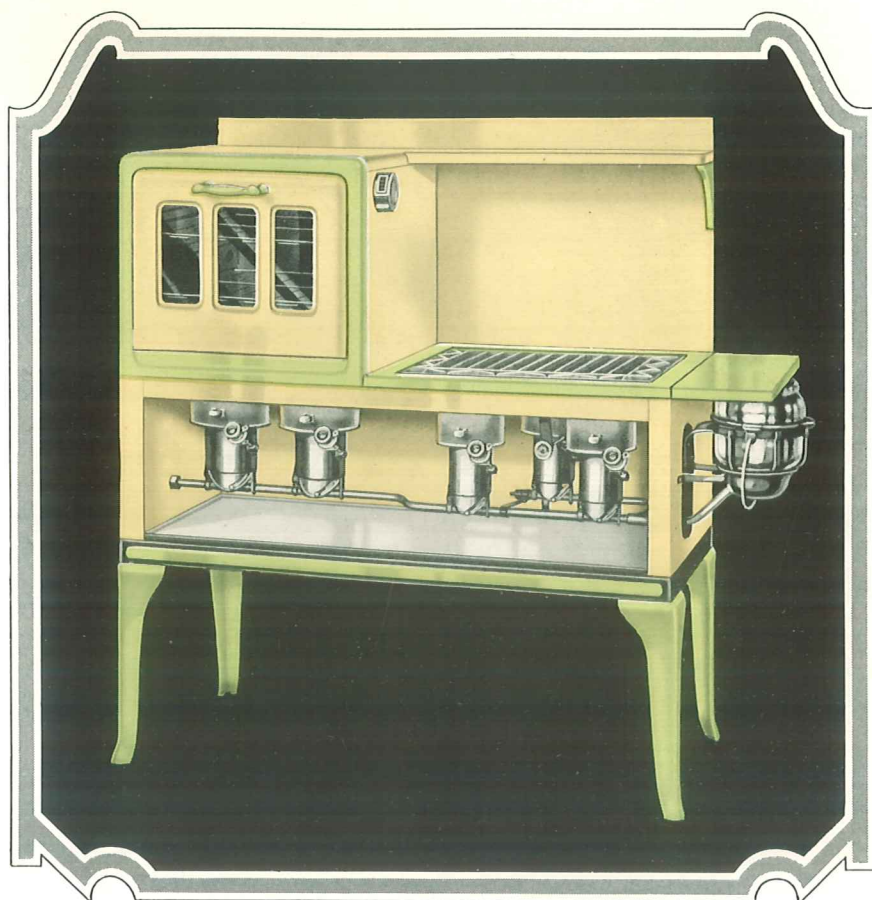

**No. 9950A — R or L — Nile Green  
ALCAZAR KEROSENE GAS RANGE**

**Unsurpassed in Performance — Pleasing in Appearance**

Beautifully Porcelain Enameled in choice of color trims, Ivory and Nile Green, Ivory and Arabian Tan or White and Gray. Main Top Frame and End Shelf Porcelain Enameled. This range is equipped with Five Patented Brass Burners — Two Giant under the Oven and Three Regular for the Cooking Top. Porcelain Enameled Oven Linings and Burner Tray. Glass Oven Door which permits watching the progress of baking or roasting without constantly opening the door. Oven Thermometer. Large Cast Iron Open Top Grate of attractive design. The extra large size of the oven and ample cooking surface provides capacity sufficient for almost any domestic requirements.

**To be Specified:**—Nile Green and Ivory, Arabian Tan and Ivory or Gray and White. Right or Left Oven.

**Cooks, Bakes and Operates as Easily and Perfectly as a Gas Range**  
Extreme Height 54 in. Floor Space 57x23 in.

No.	Burners	Cooking Surface	Cooking Height	Oven Size	Telegraph Code	Shipping Weight
9950A R	2 Giant and 3 Regular	25½x19½ in. End Shelf 9½ in.	34 in.	18x14x19 in.	Kogalla Kogamba	235 lbs.
9950A L						



No. 8400 — R or L

### ALCAZAR KEROSENE GAS RANGE

Finished in Black Rubberoid with White porcelain enameled Oven Side and Back Splashes. Equipped with four regular size Patented Brass Burners—Two under the oven and Two for cooking top. Anti-rust Metal Oven Linings. Oven Thermometer. Removable Top Grates.

To be Specified: Right or Left Oven.

**Simple Operation, Lasting Service and Dependable Results**

Extreme Height 50 in. Floor Space 50x21 in.

No.	Burners	Cooking Surface	Cooking Height	Oven Size	Telegraph Code	Shipping Weight
8400 R	4	21½x19 in.	31½ in.	16x12x18½ in.	Kopple	187 lbs.
8400 L	Regular	End Shelf 8½ in.			Kopplite	





No. 1639

**ALCAZAR KEROSENE GAS COOK**

All Regular Size Patented Brass Burners

Heavy Steel Body attractively finished in Gray Japan. Gray Porcelain Enameled Cooking Top, End Shelf and Burner Tray. The entire Back of Stoves is closed, making the body rigid and protecting the flame against stray drafts. End Shelf furnishes a convenient extension to the Cooking Top. Porcelain Enameled Tray under the Burners can be lifted out entirely for cleaning.

No.	Burners	Size of Top	Cooking Height	Telegraph Code	Shipping Weight
1629	2 Regular	25½x17½ in.	31½ in.	Kafle	61 lbs.
1639	3 Regular	35 x17½ in.	31½ in.	Kafer	73 lbs.
1649	4 Regular	43½x17½ in.	31½ in.	Kafom	83 lbs.

**HIGH SHELVES**

Gray Japanned Splasher

White Porcelain Enameled Splasher

No.	Shipping Weight	Telegraph Code	For	No.	Shipping Weight	Telegraph Code
29	22 lbs.	Jabez	2 burner	209	25 lbs.	Porline
39	26 lbs.	Jabella	3 burner	309	31 lbs.	Porlabe
49	31 lbs.	Jabite	4 burner	409	36 lbs.	Porlass



No. 694

### ALCAZAR KEROSENE GAS COOK

One Giant and remainder Regular Size Burners

Body finished in Gray Japan. Gray Porcelain Enamelled Cooking Top, End Shelf and Burner Tray. The flame is concentrated directly on the cooking vessel or right up under the oven. Quicker cooking with less oil and a cool kitchen on hot days.

No.	Burners	Size of Top	Cooking Height	Telegraph Code	Shipping Weight
693	{ 1 Giant 2 Reg.	35 x 17½ in.	31½ in.	Kagele	73 lbs.
694	{ 1 Giant 3 Reg.	43½ x 17½ in.	31½ in.	Kagembi	83 lbs.

### HIGH SHELVES

Gray Japanned Splasher

White Porcelain Enamelled Splasher

No.	Shipping Weight	Telegraph Code	For	No.	Shipping Weight	Telegraph Code
39	26 lbs.	Jabella	3 burner	309	31 lbs.	Porlabe
49	31 lbs.	Jabite	4 burner	409	36 lbs.	Porlass



No. 639

**ALCAZAR KEROSENE GAS COOK**

All Regular Size Burners

Gray Japan finish with Black Rubberoid Top, End Shelf and Lower Shelf. Wonderfully simple and easy of operation. Perfect combustion means less odor, less dirt, less smut or greasiness on the walls, and the absence of harmful fumes.

No.	Burners	Size of Top	Cooking Height	Telegraph Code	Shipping Weight
629	2 Regular	25½x17½ in.	31½ in.	Kajole	60 lbs.
639	3 Regular	35 x17½ in.	31½ in.	Kajure	72 lbs.
649	4 Regular	43½x17½ in.	31½ in.	Kajella	82 lbs.

**HIGH SHELVES**

Gray Japanned Splasher

White Porcelain Enameled Splasher

No.	Shipping Weight	Telegraph Code	For	No.	Shipping Weight	Telegraph Code
29	22 lbs.	Jabez	2 burner	209	25 lbs.	Porline
39	26 lbs.	Jabella	3 burner	309	31 lbs.	Porlabe
49	31 lbs.	Jabite	4 burner	409	36 lbs.	Porlass



# Alcazar Long Chimney Oil Ranges and Cooks

Attractive Green and Ivory Finish  
That Every Housewife Adores

EQUIPPED WITH PATENTED BRASS BURNERS

THE modern vogue of color in the kitchen is admirably expressed in these Alcazar Long Chimney Oil Ranges and Cooks. Resplendent in beautiful Green and Ivory, they harmonize well with any surroundings and bring a new note of cheer to the present-day kitchen.



**Alcazar Long Chimney Burners**—Are made of brass, drawn out of one piece, rust-proof and seamless, and provide a clean, intense flame, readily controlled.

**Oil Inlet**—The oil inlet is from below which avoids trapping any water which may collect in the kerosene. A union nut connection of the burner to the feed pipe makes a tight joint.

**Wick Raising Device**—The wick raising device is positive in operation, grips the wick carrier firmly and allows free movement of the wick in burner; provided with wick stop and ring for tilting burner drum to facilitate lighting. Porcelain enameled burner drums are fitted with mica door.

**Auxiliary Cooking Top**—Two models of the ranges are equipped with the auxiliary cooking top which enables each burner to supply two holes, one direct and one auxiliary. Surplus heat is carried back to the fireless cooking holes in the rear and two or more vessels of food utilize the heat generated by only one burner thus giving extra cooking capacity without increasing fuel consumption.



All ranges with the auxiliary cooking top are equipped with one solid cover with reducing ring.

**Glass Oil Tank**—Supply of oil is always visible. Has bail for easy carrying.

**End Shelf**—on all ranges furnishes a convenient extension to the cooking top.

**Variety of Models for Choice**—Ranges with built-in oven are made in 4 and 5 burner styles with 2, 3, 4 and 6 cooking holes and cook stoves in 2, 3 and 4 burner sizes, providing ample selection for various needs.



**No. 1200 R or L — Nile Green**  
**ALCAZAR LONG CHIMNEY OIL RANGE**

Ivory porcelain enameled Oven Door, Side and Back Splasher. Main Oven Front and Burner Drums Green porcelain enameled. Balance trimmed in Green and Ivory. Glass oil tank. Oven thermometer. Anti-rust metal oven linings. Two burners under oven, three for cooking top. Burner Drums are fitted with mica door.

Dimensions	Number	Telegraph Code	Shipping Weight
Cooking Height 31½ in. Extreme Height 50 in. Floor Space 60x23 in. Cooking Surface 30¾x19 in. End Shelf 8½ in. Oven Size 16x12x18½ in.	<b>1200 R</b>	Lorise	196 lbs.
	<b>1200 L</b>	Loruce	196 lbs.

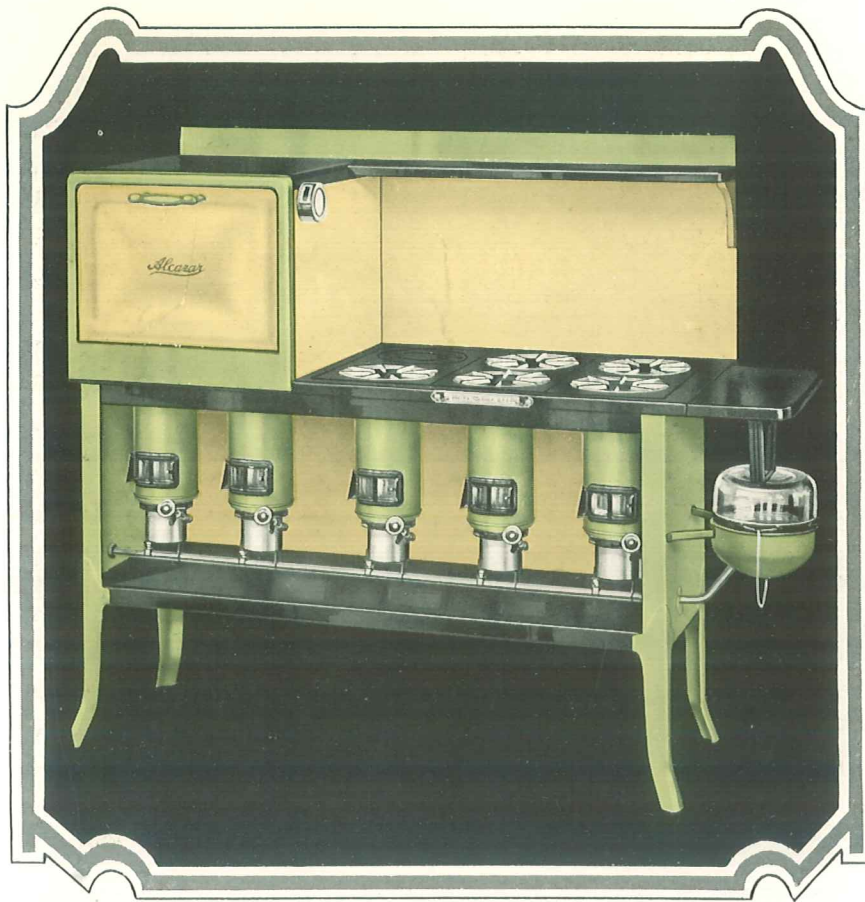

No. 1210 R or L — Nile Green  
ALCAZAR LONG CHIMNEY OIL RANGE

Oven Door, Side and Back Splasher Ivory porcelain enamel. Main Oven Front and Burner Drums Green porcelain enameled. Balance trimmed in Green and Ivory. Glass oil tank. Oven thermometer. Anti-rust metal oven linings. Two Brass Burners under oven, three for cooking top. Three key plates with auxiliary cooking holes on the cooking top provide six openings, thus really doubling the service of the three cooking burners. Supplied with one solid cover with reducing ring. Burner drums fitted with mica doors.

Dimensions	Number	Telegraph Code	Shipping Weight
Cooking Height 31½ in. Extreme Height 50 in. Floor Space 60x24½ in. Cooking Surface 30½x20¾ in. End Shelf 8½ in. Oven Size 16x12x20 in.	1210 R	Lorich	200 lbs.
	1210 L	Lorong	200 lbs.





**No. 1100 R or L — Nile Green**  
**ALCAZAR LONG CHIMNEY OIL RANGE**

Ivory porcelain enameled Oven Door, Side and Back Splasher. Main Oven Front and Burner Drums are Green porcelain enameled. Balance trimmed in Green and Ivory. Glass oil tank. Oven thermometer. Anti-rust metal oven linings. Two burners under oven, two for cooking top. Burner Drums are fitted with mica door.

Dimensions	Number	Telegraph Code	Shipping Weight
Cooking Height, 31½ in.	1100 R	Lorate	174 lbs.
Extreme Height 50 in.			
Floor Space 50x23 in.	1100 L	Lorado	174 lbs.
Cooking Surface 21½x19 in.			
End Shelf 8½ in.			
Oven Size 16x12x18½ in.			



**No. 1110 R or L — Nile Green**  
**ALCAZAR LONG CHIMNEY OIL RANGE**

Oven Door, Side and Back Splasher Ivory porcelain enamel. Main Oven Front and Burner Drums Green porcelain enameled. Balance trimmed in Green and Ivory. Glass oil tank. Oven thermometer. Anti-rust metal oven linings. Four burners. Two key plates with auxiliary cooking holes on the cooking top provide four openings, thus really doubling the service of the two cooking burners. Supplied with one solid cover with reducing ring. Burner drums fitted with mica doors.

Dimensions	Number	Telegraph Code	Shipping Weight
Cooking Height 31½ in. Extreme Height 50 in. Floor Space 50x24½ in.	1110 R	Lorencia	183 lbs.
Cooking Surface 21¼x20¾ in. End Shelf 8½ in. Oven Size 16x12x20 in.	1110 L	Loremb	183 lbs.



**No. 123A — Nile Green**  
**ALCAZAR LONG CHIMNEY OIL COOK**

Finished in Green and Ivory as illustrated. Burner drums porcelain enameled.  
 Cooking height, 31½ in.

No.	No. of Burners	Size of Top	Telegraph Code	Shipping Weight
122-A Green	2	25½x16 in.	Longidle	48 lbs.
123-A Green	3	35 x16 in.	Longmind	61 lbs.
124-A Green	4	43½x16 in.	Longmord	69 lbs.

**HIGH SHELVES**

No.	For	Telegraph Code	Shipping Weight
2-B Green	2 Burner	Sheldor	21 lbs.
3-B Green	3 Burner	Shelter	27 lbs.
4-B Green	4 Burner	Shelquad	32 lbs.



# Alcazar Wicks

Made Where the Stoves are Built

**A**LL wicks used in the stoves illustrated in this catalog are made at the factory where the stoves themselves are built.

This is an important factor toward better oil stove operation. Wicks fit perfectly — they are absolutely true, one being like the other. It is this uniformity in size that insures easy insertion and removal, wicks that operate perfectly in the stove. Absolute control of uniform thickness and size is a safeguard for the user. Every wick comes with an even burning edge, being charred at the factory on an automatic machine, insuring an even flame right from the start.

## REGULAR AND GIANT ALCAZAR BURNER WICKS



Wicks, both for the Giant and Regular size Alcazar burners, are true to size and the perforations in the wick carrier are correctly spaced to mesh properly with the wick raiser.

Only Blue Stripe Wicks are genuine.

**No. 20**—Alcazar Wick for Regular Alcazar Burner, packed three dozen in carton, weighing 10 lbs. Telegraph Code — Rewig.

**No. 30**—Alcazar Wick for Giant Alcazar Burner, packed one dozen in carton, weighing 6 lbs. Telegraph Code — Geewig.



## ALCAZAR LONG CHIMNEY BURNER WICKS



Made for use in Alcazar Long Chimney Oil Stove Burners and will fit Premier, Everite, Star-Leader, Dixie, Globe and many other long chimney burners.

**No. 300**—Alcazar Long Chimney Wick, packed three dozen in carton, weighing 9 lbs. Telegraph Code — Lowig.

## WARNING

Operation of Alcazar Burners cannot be guaranteed unless genuine Blue Stripe Wicks are used. Do not substitute any wicks for the Alcazar Burner — use only the genuine. To identify them, two blue stripes are woven into the wick. Be sure you get Blue Stripe Wicks.

# Alcazar Ovens

**Not Another Oven Like the Alcazar — Nor Nearly as Good**

**T**HE Alcazar Ovens outclass everything in the way of rivals. There is not another Portable Oven like them — Matchless — not in one respect but in all. They are truly “The Housekeeper’s Delight.” Because of the perfect principle of circulation they do all that any coal, wood or gas range oven can do and do it quicker, easier and with greater satisfaction. Besides, Alcazar Ovens have everything desirable — newness of style, splendid materials, excellent workmanship.

**Nos. 36 AND 32 ARE BUILT WITH THE  
DEFLECTOR HEAT DISTRIBUTOR  
Makes Baking in the Alcazar Ovens as Perfect as in the  
Finest Coal or Gas Range**

The heat, when entering at bottom is directed against conical heat distributors which guide it not only to the four sides of the oven but also through an opening in the middle of the deflector plate. Then it comes in contact with a unique contrivance which spreads it. Thus is immediately created a heat circulation that is so completely effective that it insures the greatest degree of baking and roasting efficiency.

## **VENTILATED FLUE SYSTEM**

The heating of the oven is direct. After the heat has completely filled the oven it passes out through holes at the top of the inner lining and is then forced slowly downward through flues between the outer and inner walls until it passes out of the holes at the bottom of the outer wall.

The result of the combined operation of the Deflector Heat Distributor and Ventilated Flue System is marvelous. Cooking is accomplished with a perfection that is a real delight. Bread, pastry, meats, and other articles of food do not dry out, but are done in a nice, palatable and wholesome condition.

**Nos. 36 AND 32 HAVE ALL THESE FEATURES —**

**POLISHED STEEL BODY**

**ASBESTOS LINED THROUGHOUT**

**HEAVY CORRUGATED TIN LININGS**

**TWO SUBSTANTIAL WIRE RACKS**

**LARGE MICA PEEP HOLES**

**POSITIVE LOCKING EVER-COOL DOOR FASTENERS**

**ALUMINUM OVEN TOP CORNERS AND MICA FRAMES**

**ALASKA HANDLES**

The Alcazar line has everything desirable — splendid appearance — extensive variety and as a consequence, salability. They are built for service and are thoroughly dependable for satisfactory results. Put an assortment on display and enjoy this profitable turnover.

## ALCAZAR OVENS

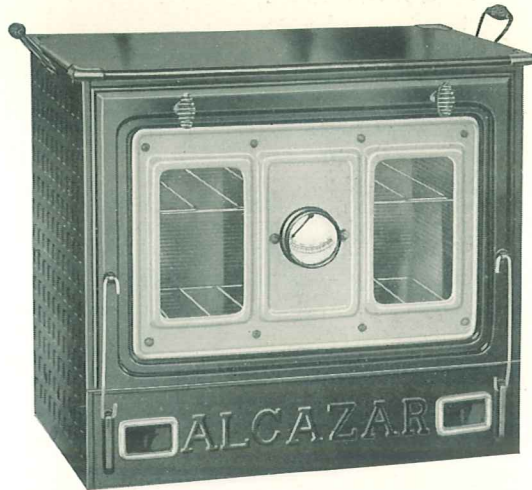

### GLASS DROP DOOR WITH THERMOMETER — PORCELAIN ENAMELED DOOR PANEL

Polished Steel Body. Asbestos lined throughout. Heavy Corrugated Tin Linings. Two Substantial Wire Racks. Large Mica Peep Holes. Positive Locking Ever-cool Door Fasteners. Aluminum Oven Top Corners and Mica Frames. Alaska Handles.

Number	Type	Size	Telegraph Code	Shipping Weight
36	Two Burner	20¼ in. wide 13 in. deep 18¼ in. high	Opimin	30 lbs.

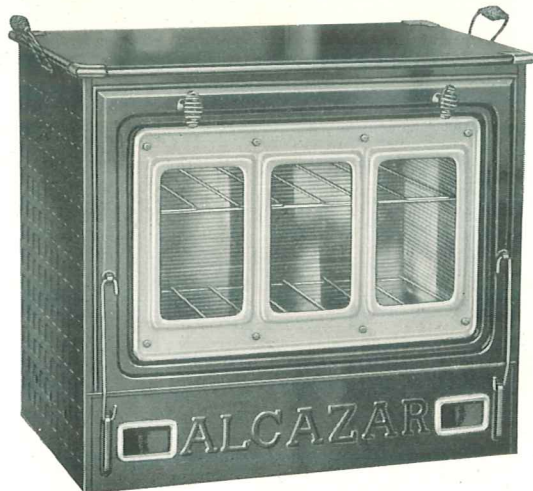

### GLASS DROP DOOR — PORCELAIN ENAMELED DOOR PANEL

Polished Steel Body. Asbestos lined throughout. Heavy Corrugated Tin Linings. Two Substantial Wire Racks. Large Mica Peep Holes. Positive Locking Ever-cool Door Fasteners. Aluminum Oven Top Corners and Mica Frames. Alaska Handles.

Number	Type	Size	Telegraph Code	Shipping Weight
32	Two Burner	20¼ in. wide 13 in. deep 18¼ in. high	Oppolo	29 lbs.



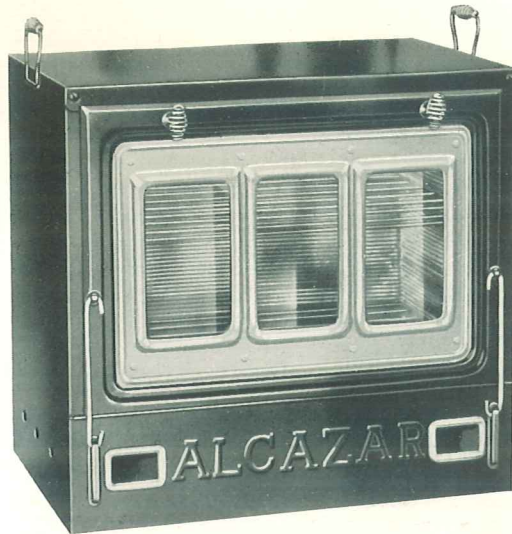

**ALCAZAR OVENS**  
**GLASS DROP DOOR—PORCELAIN**  
**ENAMELED DOOR PANEL**

**For Two Burners**

Polished Steel Body. Asbestos lined throughout. Heavy Corrugated Tin Linings. Two Substantial Wire Racks. Large Mica Peep Holes. Aluminum Mica Frames. Positive Locking Ever-Cool Door Fasteners. Alaska Handles.

No.	Size	Telegraph Code	Ship. Wgt.
24	20¼ in. wide 13 in. deep 18½ in. high	Overcomes	28 lbs.

**GLASS DROP DOOR—POLISHED**  
**STEEL DOOR PANEL**

**For Two Burners**

Polished Steel Body. Asbestos lined throughout. Heavy Corrugated Tin Linings. Two Substantial Wire Racks. Large Mica Peep Holes. Positive Locking Ever-Cool Door Fasteners. Aluminum Mica Frames. Alaska Handles.

No.	Size	Telegraph Code	Ship. Wgt.
20	20¼ in. wide 13 in. deep 18¼ in. high	Overwhelm	27 lbs.

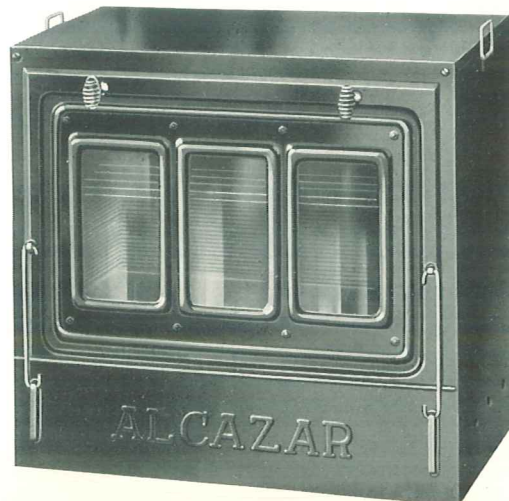
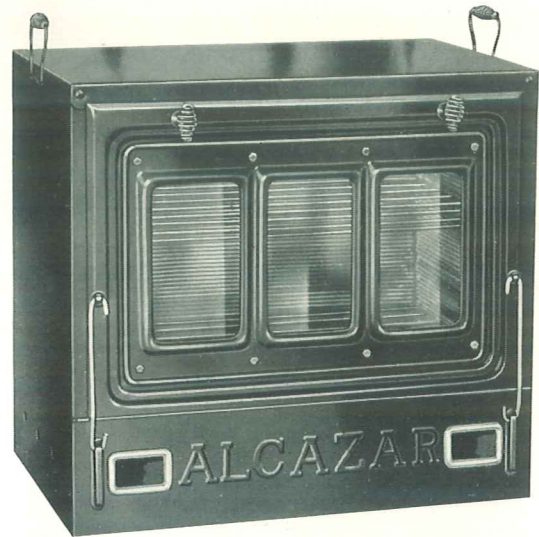

**No. 15 ALCAZAR OVEN**

**For Two Burners**

Glass Drop Door — Plain Polished Steel Panel. Polished Steel Body. Tin Lined Sides. Two Substantial Wire Racks. Lower Rack has Deflector attached. Positive Ever-Cool Door Fastener. Wire Handles.

No.	Size	Tel. Code	Ship. Wgt.
15	21 in. wide 13¼ in. deep 18¾ in. high	Overpower	24 lbs.

# ALCAZAR OVENS

## No. 115 ALCAZAR OVEN

### For One Burner

Glass Drop Door — Plain Polished Steel Panel. Polished Steel Body. Tin Lined Sides. Two Wire Racks with Deflector attached to Lower Rack. Ever-Cool Door Fastener. Wire Handles.

No.	Size	Tel. Code	Ship. Wgt.
115	13 <sup>3</sup> / <sub>8</sub> in. wide 13 <sup>1</sup> / <sub>4</sub> in. deep 13 <sup>3</sup> / <sub>8</sub> in. high	Obelra	18 lbs.

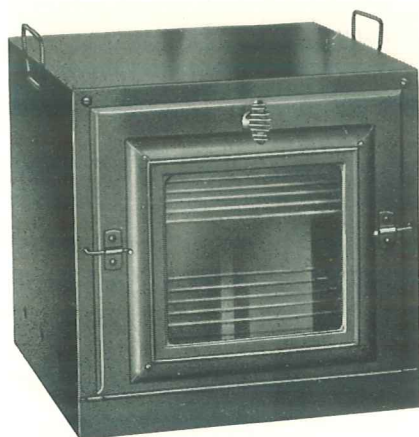
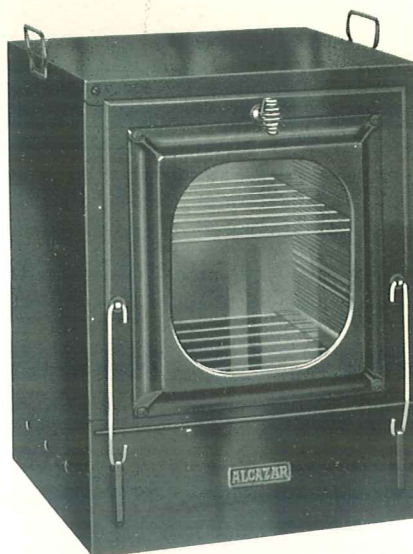

## No. 10 ALCAZAR OVEN

### For One Burner

Glass Drop Door — Polished Steel Body. Two Wire Racks. Lower Rack has Deflector attached. Positive Locking Ever-Cool Door Fastener.

No.	Size	Tel. Code	Ship. Wgt.
10	12 <sup>1</sup> / <sub>2</sub> in. wide 12 in. deep 12 in. high	Otrimble	17 lbs.

## No. 9 ALCAZAR OVEN

### For One Burner

Blue Steel Body; Single Walls; Glass Swing Door.

No.	Size	Telegraph Code	Ship. Wgt.
9	12 <sup>1</sup> / <sub>2</sub> in. wide 12 in. deep 12 in. high	Overuse	14 lbs.

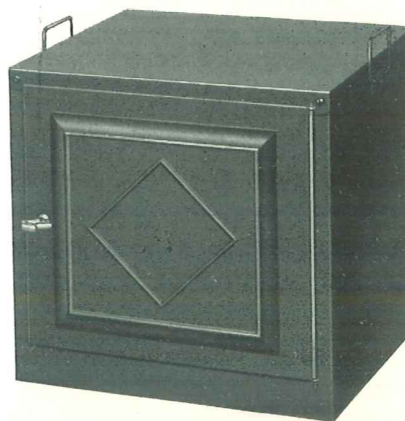



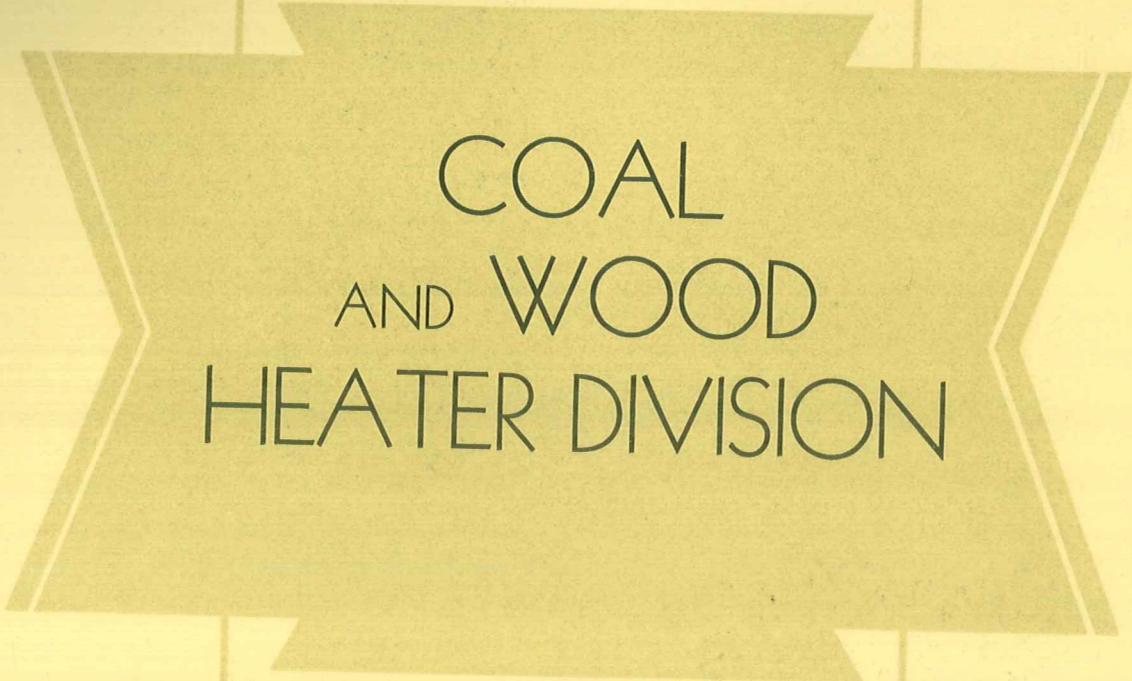

COAL  
AND WOOD  
HEATER DIVISION

DUPLEX  
CIRCULATING  
KITCHEN HEATERS



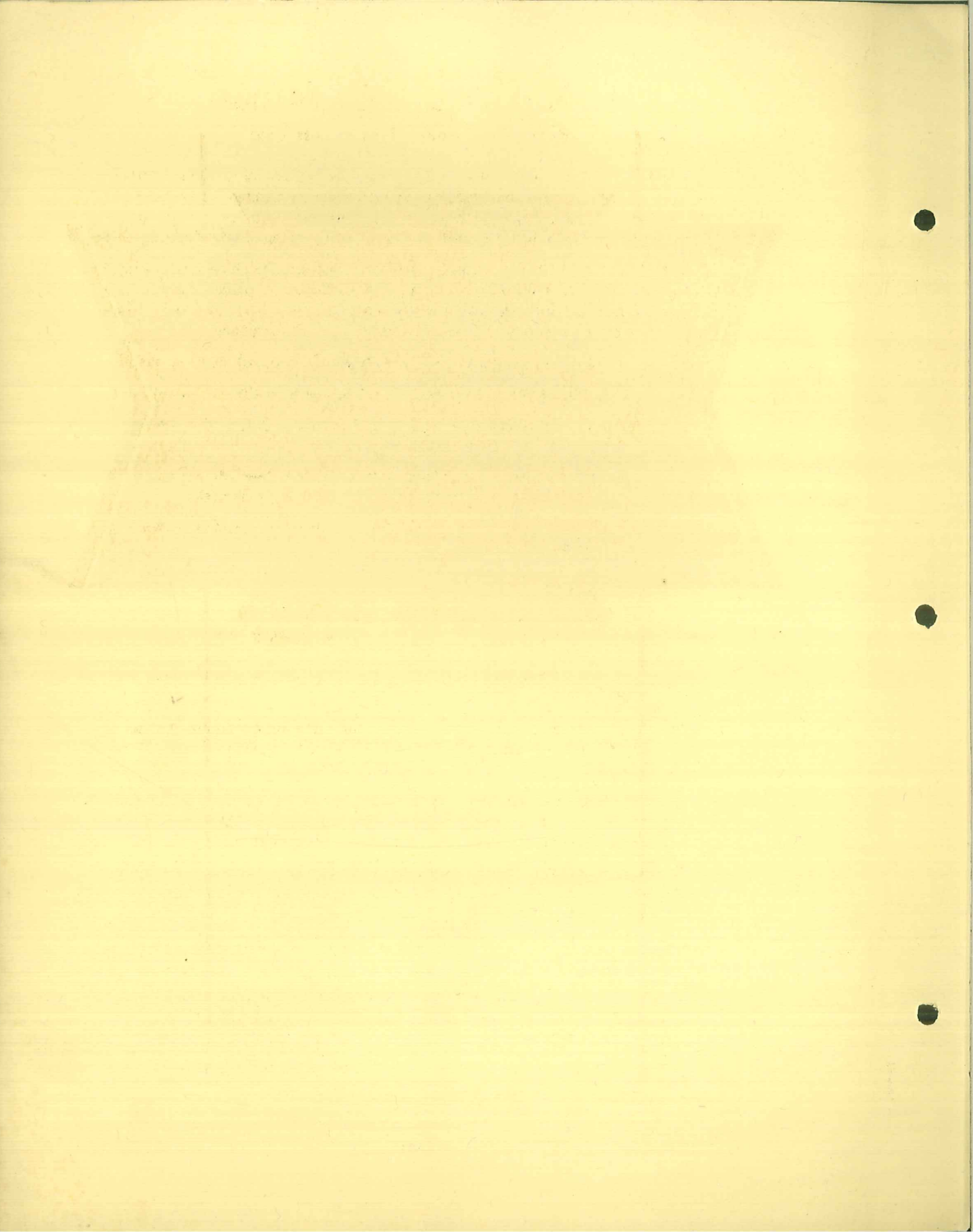

# Alcazar Circulating Heaters

Burn Wood, Coke, Hard or Soft Coal

**E**VERY home and other type of building now heated by inefficient out-of-date equipment is a prospect for an Alcazar Circulating Heater and you will find them among homes, stores, schools, garages, churches, lodge rooms, offices, waiting rooms, theatres, halls, factories, all of which offer a large market.

Alcazar Circulating Heaters, besides beautiful appearance, have many other advantages over old methods of heating. The Heater is placed right in the space to be heated; not installed in some out of the way spot in a dark basement. It is, therefore, built to be a beautiful piece of furniture.

Its initial cost is much less than that of a central heating system.

It does not require tearing up of floors and walls for installation.

There is no heat lost in a labyrinth of piping as is the case with some other systems.

It is more economical because it requires less fuel and every bit of the heated air passes directly into the space to be heated.

The assortment of sizes enable you to meet the greatest number of requirements in this one line.

## Greater Heating Power Because —

It furnishes properly humidified, healthful heat and keeps it in constant circulation.

Its larger radiating surface heats a correspondingly larger volume of air so that the heating value of the fuel consumed is utilized to the utmost.

The large deep fire pot accommodates a heavy bed of fuel; carefully fitted doors, with draft damper in the ash-pit door and check in the smoke pipe elbow permit close control of combustion.

Heavy corrugations in the cast iron fire pot and combustion chamber add strength, durability and at the same time greatly increased heating surface.

The amply large fire door will accommodate extra large lumps of coal or chunks of wood.

A coal chute in the feed door opening which operates automatically with the opening and closing of the door facilitates feeding fuel without spilling.

Each of the heaters shown can be supplied with magazine for hard coal, thus making it a self feeding heater.

## Important Features That Insure Lasting Service

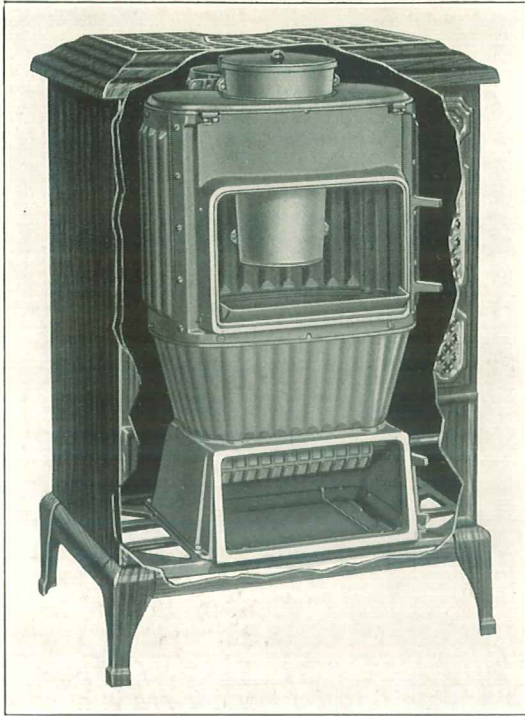

**Interior of the No. 86 Circulating  
Heater — with Magazine**

*Note the double wall construction of the housing, a  
feature of Nos. 88 and 86 Circulating Heaters*

The roomy ash pit is supplied with  
galvanized ash pan.

Screen and mica in the fire door permit  
a cheery view of the glowing fire.

The dome or top casting is shap-  
ed to secure the greatest surface  
for heat radiation.

Attractively designed register  
covers the entire top and has  
center opening for heaters fitted  
with magazine.

The air humidifying water con-  
tainer is porcelain enameled in-  
side and out.

Grates are reversible for wood  
or coal.

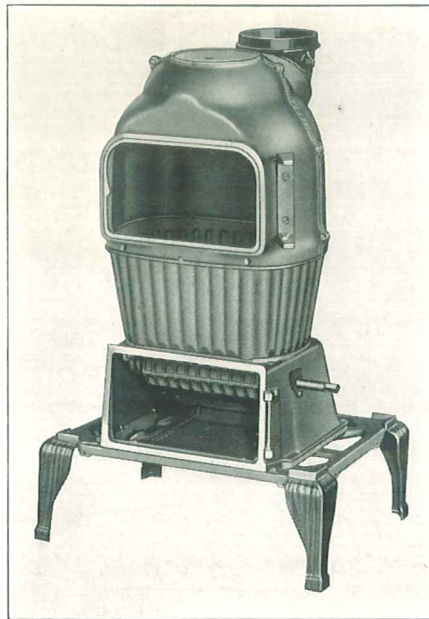

**Interior of the No. 46 Circulating  
Heater — without Magazine**

Contour, design, color, finish — all combine to make a handsome piece of  
furniture that will fit in any room in perfect harmony with furnishings.





### ALCAZAR CIRCULATING HEATER

A most efficient heating unit and a beautiful home furnishing. When you sum up its many advantages, you will readily see why thousands have done away with common stoves and installed this modern, dependable and economical method.

The heater is made sturdy and durable for lasting service. The extra heavy corrugated fire pot holds a deep bed of burning fuel from which all the heat is utilized. Easily keeps coal fire overnight. Any kind of fuel can be used, hard or soft coal, coke or wood.

No.	Height	Body Width	Body Depth	Code	Shipping Weight
88	49 in.	27 in.	18 in.	Cirkobe	397 lbs.
88 with Magazine	49 in.	27 in.	18 in.	Cirkodle	417 lbs.

1541x3-4-31



### ALCAZAR CIRCULATING HEATER

A great improvement over the common heating stove. Heats by circulating warm moistened air. Burns any fuel, wood, coke, hard or soft coal. Pleasing porcelain enamel furniture finish—easily cleaned with a cloth like any other piece of furniture. Sturdily built for lasting service; cleaner and more comfortable.

No.	Height	Body Width	Body Depth	Code	Shipping Weight
86	44½ in.	27 in.	18 in.	Cirkeat	377 lbs.
86 with Magazine	44½ in.	27 in.	18 in.	Cirquine	397 lbs.



### ALCAZAR CIRCULATING HEATER

An attractively finished circulating heater. Burns any fuel, wood, coke, hard or soft coal. Furniture finish porcelain enamel, easily cleaned with a cloth like any other piece of furniture. Cast iron combustion chamber, dome and corrugated fire pot. Duplex grates.

No.	Height	Body Width	Body Depth	Code	Shipping Weight
46	41 $\frac{3}{4}$ in.	22 $\frac{1}{4}$ in.	16 $\frac{1}{4}$ in.	Cirkeater	283 lbs.
46 with Magazine	41 $\frac{3}{4}$ in.	22 $\frac{1}{4}$ in.	16 $\frac{1}{4}$ in.	Cirkinale	294 lbs.





### ALCAZAR CIRCULATING HEATER

The 'fine furniture' appearance of this heater makes it a handsome furnishing that will fit in any room with perfect harmony. Porcelain enamel furniture finish. Burns any fuel, wood, coke, hard or soft coal. Cast iron combustion chamber, dome and corrugated fire pot. Duplex grates.

No.	Height	Body Width	Body Depth	Code	Shipping Weight
44	40½ in.	20¼ in.	16¼ in.	Cirkeatie	261 lbs.
44 with Magazine	40½ in.	20¼ in.	16¼ in.	Cirkinute	272 lbs.

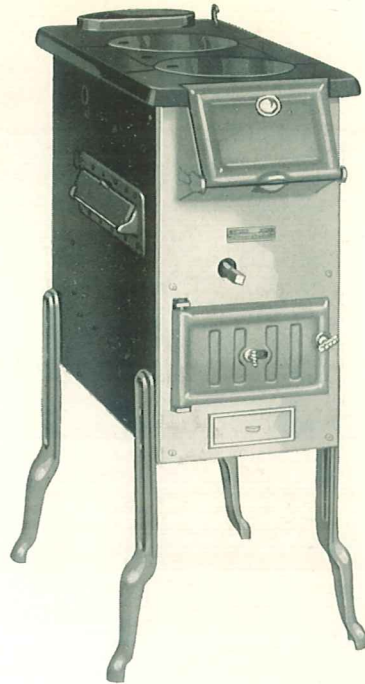

No. 188  
Porcelain Steel Construction

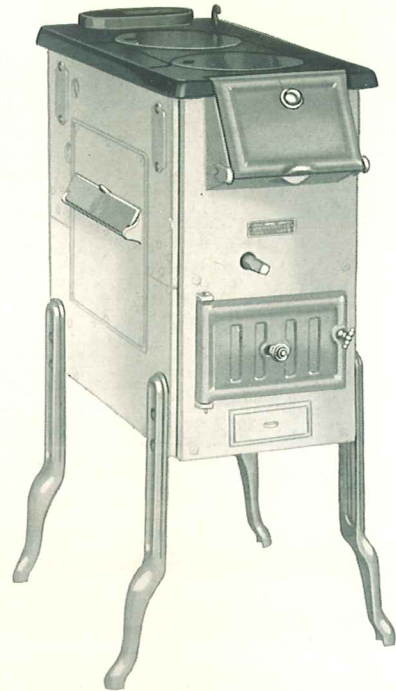

No. 189  
Porcelain Cast Iron Construction

## ALCAZAR KITCHEN HEATERS

Burn Coal or Wood

Porcelain enameled. Two types — porcelain steel construction and porcelain cast iron construction. Cleanliness and durability big recommendation; invariably captivates home lovers. Very practical. Full size fire-box with heavy linings and duplex grates. Top is polished blued and of a size convenient for cooking. Legs are adjustable to various heights. Set to right or left side of gas range or used separate. More heat with less fuel is provided by the double flue system.

Number	Construction	Size of Top	Telegraph Code	Shipping Weight
188	Porcelain Steel	13x25 in.	Kargreyt	168 lbs.
189	Porcelain Cast Iron	13x25 in.	Khartgreyt	215 lbs.
Alcazar Gas Kindler fitted in Heater.....				Add 3 lbs.
Waterfront fitted in Heater.....				Add 8 lbs.
Water Coil fitted.....				Add 5 lbs.
Waterfront ordered separate.....				21 lbs.

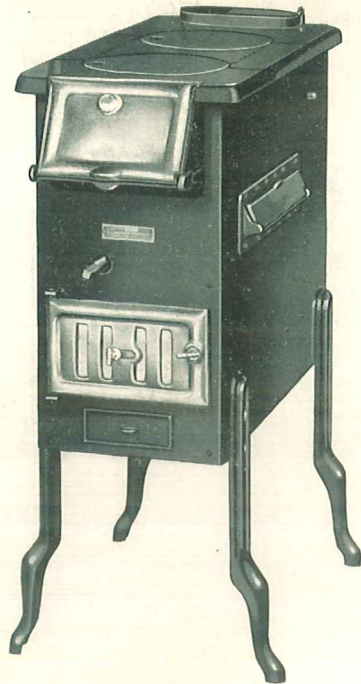

No. 88  
Steel Construction

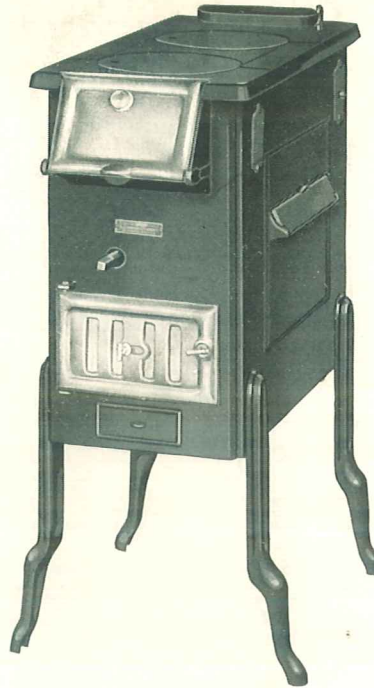

No. 89  
Cast Iron Construction

### ALCAZAR KITCHEN HEATERS

Burn Coal or Wood

Well built. Two types — one with body made of a high grade, heavy sheet steel; other of cast iron. Full size fire-box with heavy linings and Duplex grates. Nickel-plated Feed and Ash-pit doors. Top is of a size convenient for cooking. Two covers provided. Front and side drafts. There is a poke hole door on each side. This arrangement permits the stove to be used at either right or left. Cast legs are adjustable to various heights. Can be attached to side of gas range or used separately. Circulation of the heat by the double flue system secures increased efficiency.

Number	Construction	Size of Top	Telegraph Code	Shipping Weight
88	Steel	13x25 in.	Karkoft	122 lbs.
89	Cast Iron	13x25 in.	Khersont	193 lbs.
289—Same as No. 89 excepting front and front legs finished in white and gray porcelain enamel...			Khortley	196 lbs.
Alcazar Gas Kindler fitted in Heater.....				Add 3 lbs.
Waterfront fitted in Heater.....				Add 8 lbs.
Water Coil fitted.....				Add 5 lbs.
Waterfront ordered separate.....				21 lbs.



# Alcazar

Coal or Wood Ranges  
Heaters - Kitchen Heaters

Special Net Prices  
made confidentially to

---

## TERMS

Net 30 Days, 2 per cent 10 Days

F. O. B.

MILWAUKEE

UP TO 27c. PER CWT.  
FREIGHT ALLOWED

---

*All prices subject to change  
without notice*

**ALCAZAR RANGE & HEATER CO.**  
MILWAUKEE, WIS.

New York    Chicago    Detroit    Denver    San Francisco

## ALCAZAR ROYAL RANGES

### Coal or Wood

No.		
8-18	Sq. with Buffet Shelf.....	\$61.00
8-18	Res. " " " .....	69.50
8-18	Sq. with High Closet.....	67.50
8-18	Res. " " " .....	76.00
8-20	Sq. with Buffet Shelf.....	64.00
8-20	Res. " " " .....	72.50
8-20	Sq. with High Closet.....	70.50
8-20	Res. " " " .....	79.00
9-20	Sq. with Buffet Shelf.....	65.00
9-20	Res. " " " .....	73.50
9-20	Sq. with High Closet.....	71.50
9-20	Res. " " " .....	80.00

**To be Specified:**

Color wanted	
Waterfront in Range .....	3.00
Waterfront separate .....	4.00
French top .....	.50

**NOTE:**

Regularly white and grey.  
Ivory with NILE GREEN or ARABIAN TAN trim same price.

### ALCAZAR CIRCULATING HEATERS

88 .....	45.00
88 with magazine .....	47.00
86 .....	40.00
86 with magazine .....	42.00
46 .....	32.00
46 with magazine .....	34.00
44 .....	26.00
44 with magazine .....	28.00

### ALCAZAR KITCHEN HEATERS

88 Steel .....	12.50
188 " porcelain .....	26.00
89 Cast .....	16.50
289 " semi-porcelain .....	20.00
189 " porcelain .....	31.50

**To be specified:**

Gas Kindler in .....	2.00
Waterfront in .....	2.75
Waterfront separate .....	3.75

# *Alcazar*

## Liquid Fuel

STOVES – RANGES – APPLIANCES  
PORTABLE OVENS

Special Net Prices  
made confidentially to

---

### TERMS

Net 30 Days, 2 per cent 10 Days

F. O. B.

MILWAUKEE

UP TO 27c. PER CWT.  
FREIGHT ALLOWED

---

*All prices subject to change  
without notice*

**ALCAZAR RANGE & HEATER CO.**

CHICAGO      MILWAUKEE      NEW YORK      DENVER  
SAN FRANCISCO      DETROIT



**Alcazar**  
**PRESSURE GASOLINE**  
**RANGES**

No.	
945—R or L.....	\$48.75
946—R or L.....	57.60
947—R or L.....	70.00
947—R or L (color).....	73.50
948—R or L.....	73.50
948—R or L (color).....	77.00

**LOW OVEN STYLE**

983—3 Br. ....	36.00
----------------	-------

**HIGH SHELVES**

for No. 983 above

39—3 Br. ....	4.00
---------------	------

Gray Japaned Splasher

309—3 Br. ....	6.35
----------------	------

White Porcelain Enameled Splasher

**Alcazar**  
**PRESSURE GASOLINE**  
**COOKS**

**TWO BURNER**

829 .....	15.50
1829 .....	17.00

**THREE BURNER**

839 .....	18.50
1839 .....	20.25

**FOUR BURNER**

849 .....	22.00
1849 .....	24.00

**HIGH SHELVES**

For Above

29—2 Br. Japaned.....	3.35
39—3 Br. " .....	4.00
49—4 Br. " .....	5.00
209—2 Br. Porcelain.....	5.15
309—3 Br. " .....	6.35
409—4 Br. " .....	8.00

**PRESSURE GASOLINE**  
**COOKS**  
**Low Style**

129 .....	14.50
139 .....	16.50

**Alcazar**

**PRESSURE GASOLINE**  
**RADIANT HEATERS**

82—Black —4 radiants.....	14.65
92—Porcelain—4 radiants.....	18.00
182—Black —5 radiants.....	16.00
192—Porcelain—5 radiants.....	18.60
275—Fireplace—5 radiants .....	19.35

**WATER HEATERS**

9 .....	12.00
---------	-------

**AUXILIARY TANK WITH**  
**PUMP**

10—(6 gal. gasoline cap.) .....	\$8.75
10 Ft. Lengths brass tubing with fitting for above .....	.75

**SERVICE KIT**

Alcazar service kit .....	\$5.00
---------------------------	--------

**Alcazar**

**OVENS**

36 .....	\$4.70
32 .....	4.20
24 .....	3.55
20 .....	3.15
15 .....	2.50
115 .....	2.15
10 .....	1.45

**PRESSURE GASOLINE  
COOKS**

**Low Style**

.....	14.50
.....	16.50

**Alcazar**

**PRESSURE GASOLINE  
RADIANT HEATERS**

-Black —4 radiants.....	14.65
-Porcelain—4 radiants.....	18.00

-Black —5 radiants.....	16.00
-Porcelain—5 radiants.....	18.60

-Fireplace—5 radiants .....	19.35
-----------------------------	-------

**WATER HEATERS**

.....	12.00
-------	-------

**AUXILIARY TANK WITH  
PUMP**

6 gal. gasoline cap.) .....	\$8.75
t. Lengths brass tubing with fitting for above .....	.75

**SERVICE KIT**

car service kit .....	\$5.00
-----------------------	--------

**Alcazar**

**OVENS**

.....	\$4.70
.....	4.20
.....	3.55
.....	3.15
.....	2.50
.....	2.15
.....	1.45

**Alcazar  
KEROSENE GAS RANGES**

8850 —R or L.....	\$51.50
9950A—R or L.....	60.00
9950A—R or L (color).....	63.50

**Alcazar  
KEROSENE GAS COOKS**

**TWO BURNER**

629—2 reg. Br. ....	\$11.20
1629—2 reg. Br. Porc. ....	12.70

**THREE BURNER**

639—3 reg. Br. ....	\$14.45
1639—3 reg. Br. Porc. ....	16.20
693—2 reg. 1 giant Br. ....	18.95

**FOUR BURNER**

649—4 reg. Br. ....	\$18.35
1649—4 reg. Br. Porc. ....	20.35
694—3 reg. 1 giant Br. ....	23.10

**HIGH SHELVES**

**For Above**

29—2 Br. Japanned .....	\$3.35
39—3 Br. " .....	4.00
49—4 Br. " .....	5.00
209—2 Br. Porcelain .....	5.15
309—3 Br. " .....	6.35
409—4 Br. " .....	8.00

**Alcazar  
LONG CHIMNEY RANGE**

1200—R or L.....	\$36.00
------------------	---------

**Alcazar  
LONG CHIMNEY COOKS**

122—2 Br. ....	\$ 9.25
123—3 Br. ....	11.90
124—4 Br. ....	14.70

**HIGH SHELVES**

**For Above**

2B—2 Br. ....	\$1.90
3B—3 Br. ....	2.10
4B—4 Br. ....	2.35

**Alcazar  
SHORT CHIMNEY WICKS**

**No. 20—regular**

Per doz. ....	\$2.50
Per doz. in 3 doz. lots.....	2.40
Per gross .....	27.00

**No. 30—giant**

Per doz. ....	4.00
---------------	------

**Alcazar  
LONG CHIMNEY WICKS**

**No. 300—regular**

Per doz. ....	\$ 2.50
Per doz. in 3 doz. lots.....	2.40
Per gross .....	27.00

Alcohol  
LONG CHIMNEY WAXES  
1200 N. of 1. 20.00

Alcohol  
LONG CHIMNEY COOKS  
1200 N. of 1. 20.00  
1200 N. of 1. 20.00  
1200 N. of 1. 20.00

Alcohol  
HIGH SHELVES  
For Above  
1200 N. of 1. 20.00  
1200 N. of 1. 20.00  
1200 N. of 1. 20.00

Alcohol  
SHORT CHIMNEY WAXES  
1200 N. of 1. 20.00  
1200 N. of 1. 20.00  
1200 N. of 1. 20.00

Alcohol  
LONG CHIMNEY WAXES  
1200 N. of 1. 20.00  
1200 N. of 1. 20.00  
1200 N. of 1. 20.00

Alcohol  
LONG CHIMNEY WAXES  
1200 N. of 1. 20.00  
1200 N. of 1. 20.00  
1200 N. of 1. 20.00

Alcohol  
TWO BURNER  
1200 N. of 1. 20.00  
1200 N. of 1. 20.00  
1200 N. of 1. 20.00

Alcohol  
THREE BURNER  
1200 N. of 1. 20.00  
1200 N. of 1. 20.00  
1200 N. of 1. 20.00

Alcohol  
FOUR BURNER  
1200 N. of 1. 20.00  
1200 N. of 1. 20.00  
1200 N. of 1. 20.00

Alcohol  
EIGHT SHELVES  
1200 N. of 1. 20.00  
1200 N. of 1. 20.00  
1200 N. of 1. 20.00



THE NEW

# Alcazar

GAS RANGES

## "BUFFET"

No.	
4000	.....\$60.85
4100	..... 64.85

## "VOGUE"

No.	
4500—R or L	.....\$58.25
4600—R or L	..... 62.25

Specify color wanted—

Ivory and Green

Mottled Green

Mottled Green—Marble Doors

## "MAYFAIR"

No.	
3800—R or L	.....\$48.75
3900—R or L (Insulated)	..... 53.75

NOTE—Mayfair furnished in Nile Green  
and Ivory only.

The New  
*Alcazar*  
GAS RANGES

Special Net Prices  
made confidentially to

Geo. V. Ayres & Co.

**TERMS**

Net 30 Days, 2 per cent 10 Days

**F. O. B.**

**MILWAUKEE**

UP TO 27c. PER CWT.  
FREIGHT ALLOWED

*All Prices Subject to Change  
Without Notice*

**ALCAZAR RANGE & HEATER CO.**  
MILWAUKEE, WIS.

New York Chicago Detroit Denver San Francisco

104  
95

# Alcazar

## Gas Ranges

Combination Gas Ranges  
and Built-in Kitchen Heater

Special Net Prices  
made confidentially to

*Geo. V. Ayerst Co.*

### TERMS

Net 30 Days, 2 per cent 10 Days

F. O. B.

MILWAUKEE

UP TO 27c. PER CWT.  
FREIGHT ALLOWED

151.00

*All prices subject to change  
without notice*

**ALCAZAR RANGE & HEATER CO.**

CHICAGO

MILWAUKEE

NEW YORK

DENVER

SAN FRANCISCO

DETROIT



## Alcazar INSULATED GAS RANGES

No.	
1B-091—R or L (one H. Reg.)	.....\$149.00
1B-091—R or L Closetop ( " )	..... 156.00

**To be specified:**

Color wanted .....	5.00
Heat regulator lower oven....	9.00

2000A—R or L.....	87.00
2000A—R or L Closetop .....	92.00
2000A—R or L (with No. 23 cab.)	92.00
2000A—R or L Closetop .....( " )	97.00
1066—R or L .....	81.00
1066—R or L Closetop .....	86.00
1066—R or L (with No. 22 cab.)	86.00
1066—R or L Closetop .....( " )	91.00
1006—R or L .....	79.00
1006—R or L Closetop .....	84.00
1006—R or L (with No. 22 cab.)	84.00
1006—R or L Closetop .....( " )	89.00

**To be specified:**

Color wanted .....	_____
Solid door if wanted.....	_____

**With Thermometer**

566—R or L .....	58.75
566—R or L Closetop .....	63.75
566—R or L (with No. 21 cab.)..	63.75
566—R or L Closetop .....( " )..	68.75

**With Heat Regulator**

566—R or L .....	66.50
566—R or L Closetop .....	71.50
566—R or L (with No. 21 cab.)..	71.50
566—R or L Closetop .....( " )..	76.50

**With Thermometer**

506—R or L .....	56.75
506—R or L Closetop .....	61.75
506—R or L (with No. 21 cab.)..	61.75
506—R or L Closetop .....( " )..	66.75

**With Heat Regulator**

506—R or L .....	64.50
506—R or L Closetop .....	69.50
506—R or L (with No. 21 cab.)..	69.50
506—R or L Closetop .....( " )..	74.50

**To be specified:**

Color wanted .....	_____
--------------------	-------

**Note:**

Nos. 2000A, 1066, 1006, 566, and 506 regularly white and grey. Ivory with GREEN or TAN trim same price.

## Alcazar GAS RANGES

No.	
166—R or L .....	49.50
166—R or L Closetop .....	54.50
166—R or L (with No. 21 cab.)..	54.50
166—R or L Closetop .....( " )..	59.50

**To be specified:**

Color wanted .....	_____
Heat regulator .....	9.00
Cast iron oven bottom.....	.50
Glass oven door .....	1.00
Thermometer .....	1.25

66—R or L .....	40.00
66—R or L Closetop .....	45.00
66—R or L (with No. 21 cab.)...	45.00
66—R or L Closetop .....( " )....	50.00
64—R or L .....	38.00
64—R or L Closetop .....	43.00
64—R or L (with No. 20 cab.)...	43.00
64—R or L Closetop .....( " )....	48.00
58B-682—R or L .....	39.00
58B-682—R or L Closetop .....	44.00

**To be specified:**

Color wanted .....	_____
Heat regulator .....	9.00
Porcelain linings .....	2.00
Lighter .....	1.00
Cast iron oven bottom .....	.50

**Note:**

No. 166, 66, 64 and 58B-682 regularly white and grey. Ivory with GREEN or TAN trim same price.

56—R or L .....	32.00
56—R or L Closetop .....	37.00
56—R or L (with No. 21 cab.)....	37.00
56—R or L Closetop .....( " )....	42.00
54—R or L .....	31.00
54—R or L Closetop .....	36.00
54—R or L (with No. 20 cab.)....	36.00
54—R or L Closetop .....( " )....	41.00

58B-652 R or L .....	30.00
58B-652 R or L Closetop .....	35.00
58B-452 R or L .....	29.00
58B-452 R or L Closetop .....	34.00

**To be specified:**

Heat Regulator .....	9.00
Lighter .....	1.00
Cast iron oven bottom .....	.50

**Note:**

Always specify lighters on above closetops.



## Alcazar GAS RANGES

-R or L .....	49.50
-R or L Closetop .....	54.50
-R or L (with No. 21 cab.)..	54.50
-R or L Closetop .....	( " ).. 59.50

**To be specified:**

Color wanted .....	_____
Heat regulator .....	9.00
Cast iron oven bottom.....	.50
Glass oven door .....	1.00
Thermometer .....	1.25

-R or L .....	40.00
-R or L Closetop .....	45.00
-R or L (with No. 21 cab.)...	45.00
-R or L Closetop .....	( " )... 50.00

-R or L .....	38.00
-R or L Closetop .....	43.00
-R or L (with No. 20 cab.)...	43.00
-R or L Closetop .....	( " )... 48.00

682—R or L .....	39.00
682—R or L Closetop .....	44.00

**To be specified:**

Color wanted .....	_____
Heat regulator .....	9.00
Porcelain linings .....	2.00
Lighter .....	1.00
Cast iron oven bottom .....	.50

**Note:**  
No. 166, 66, 64 and 58B-682  
regularly white and grey.  
Ivory with GREEN or TAN  
trim same price.

-R or L .....	32.00
-R or L Closetop .....	37.00
-R or L (with No. 21 cab.)...	37.00
-R or L Closetop .....	( " )... 42.00

-R or L .....	31.00
-R or L Closetop .....	36.00
-R or L (with No. 20 cab.)...	36.00
-R or L Closetop .....	( " )... 41.00

—652 R or L .....	30.00
—652 R or L Closetop .....	35.00
—452 R or L .....	29.00
—452 R or L Closetop .....	34.00

**To be specified:**

Heat Regulator .....	9.00
Lighter .....	1.00
Cast iron oven bottom .....	.50

**Note:**  
Always specify lighters on  
above closetops.

## Alcazar LOW OVEN GAS RANGES

No.			
78-882	Low oven .....	34.50	
78-882	Br. " .....	38.50	
78-842	" .....	22.00	
78-842	Br. " .....	25.00	

**To be specified:**

Lighter .....	1.00
Heat regulator .....	9.00
(In above without broiler only)	

### For Low Oven Ranges

746—High Shelf—Porcelain .....	5.00
736—High Shelf—Japanned .....	3.50
77—Back guard—Porcelain .....	1.50

### ALCAZAR KITCHENETTES

88-882	Kitchenette .....	21.00
88-882	Br. " .....	24.00
88-842	" .....	16.25
88-842	Br. " .....	19.25
88-642	" .....	14.75
88-642	Br. " .....	17.75

**To be specified:**

Porcelain linings .....	1.25
-------------------------	------

### For Kitchenettes

828—High Shelf—Porcelain .....	5.00
818—High Shelf—Japanned .....	3.50
88—Back guard—Porcelain .....	1.75
80—Back guard—Japanned .....	1.00

## ALCAZAR APARTMENT HOUSE GAS RANGES

250A—	R or L Porc. trim...	27.50
250A—Br.	R or L " " .....	30.50

251A—	R or L Porcelain.....	32.25
251A—Br.	R or L " .....	35.25

**To be specified:**

Heat regulator .....	9.00
Thermometer .....	1.25
Lighter .....	1.00

**Note:**

R means door hinges at right.  
L means door hinges at left.

### ALCAZAR GAS LAUNDRY

122 .....	5.50
133 .....	8.00

## Alcazar KITCHEN HEATER RANGES

No.		
1660—R or L (Insulated) .....	99.50	
1660—R or L Closetop ( " ) .....	104.50	
1600—R or L (Insulated) .....	98.50	
1600—R or L Closetop ( " ) .....	103.50	

A1976—R or L .....	98.50
A1976—R or L Closetop .....	103.50

**To be specified:**

Color wanted .....	_____
Solid door if wanted .....	_____
Heat regulator .....	9.00
Cast iron oven bottom.....	.50
Waterfront in .....	2.75
Waterfront separate .....	3.75

**Note:**

Nos. 1660, 1600, and A1976.  
Regularly white and grey.  
Ivory with GREEN or TAN  
trim same price.

5876—R or L .....	59.50
5876—R or L Closetop .....	64.50

**To be specified:**

Color wanted .....	_____
Solid door if wanted .....	_____
Heat regulator .....	9.00
Porcelain linings .....	2.00
Lighter .....	1.00
Cast iron oven bottom.....	.50
Waterfront in .....	2.75
Waterfront separate .....	3.75

**Note:**

Regularly white and grey.  
White with GREEN or TAN  
trim same price.

Always specify lighter for  
5876 closetop.

## GAS CIRCULATING HEATERS

41 .....	42.00
41N (natural gas) .....	42.00
81 .....	49.00
81N (natural gas) .....	49.00

## Alcazar

### KITCHEN HEATER RANGES

No.		
D1286	.....	72.00
D1286	Closetop .....	77.00
D1286	Br .....	76.00
D1286	Br. Closetop .....	81.00
D1282	.....	71.00
D1282	Closetop .....	76.00
D1282	Br. ....	75.00
D1282	Br. Closetop .....	80.00
D262	.....	59.50
D262	Closetop .....	64.50
D262	Br. ....	63.50
D262	Br. Closetop .....	68.50

**To be specified:**

Color wanted .....	
Heat regulator .....	9.00
Lighter .....	1.00
Gas kindler .....	2.00
Cast iron oven bottom.....	.50
Waterfront in .....	2.75
Waterfront separate .....	3.75

**Note:**

Regularly white and grey.  
Ivory with GREEN or TAN  
trim same price.

Broiler ranges cannot be  
equipped with heat regulators.

Always specify lighter on  
above closetops.

## Alcazar

### KITCHEN HEATER RANGES

(Continued)

No.		
D1262	.....	49.50
D1262	Closetop .....	54.50
D1262	Br. ....	53.50
D1262	Br. Closetop .....	58.50

**To be specified:**

Color wanted .....	
Heat regulator .....	9.00
Thermometer .....	1.25
Lighter .....	1.00
Porcelain linings .....	1.50
Gas kindler .....	2.00
Cast iron oven bottom.....	.50
Waterfront in .....	2.75
Waterfront separate .....	3.75

**Note:**

Regularly white and grey.  
GREEN or TAN trim same  
price.

Broiler ranges cannot be  
equipped with heat regulators.

Always specify lighter for  
above closetops.

### ALCAZAR FOOT RESTS

Per set (3 sets in carton).....	.60
---------------------------------	-----



# Alcazar

**Kitchen Heater Gas Ranges**

**Gas Duplex Ranges**

**Net Prices**

made confidentially to

---

## TERMS

Net 30 Days, 2 per cent 10 Days

**F. O. B.**

**MILWAUKEE**

**UP TO 27c. PER CWT.  
FREIGHT ALLOWED**

---

*All prices subject to change  
without notice*

**ALCAZAR RANGE & HEATER CO.**  
MILWAUKEE, WIS.

New York Chicago Detroit Denver San Francisco

**Alcazar**  
**KITCHEN HEATER**  
**RANGES**

No.	
1700—R or L .....	\$ 91.00
1700—R or L Closetop .....	93.00

To be specified:

Glass oven door if wanted.....	—
Waterfront in .....	2.75
Waterfront separate .....	3.75

E2262 .....	55.00
E2262 Closetop .....	57.00

To be specified:

Thermolator .....	6.50
Gas Kindler .....	2.00
Cast oven bottom .....	.50
Waterfront in .....	2.75
Waterfront separate .....	3.75

E1262 .....	43.50
E1262 Closetop .....	45.50

To be specified:

Thermolator .....	6.50
Rutz Lighter .....	1.25
Cast oven bottom .....	.50
Waterfront in .....	2.75
Waterfront separate .....	3.75

**Alcazar**  
**FOOT RESTS**

No. 10 Per Set.....	.30
---------------------	-----

**Alcazar**  
**GAS DUPLEX RANGES**  
**All Porcelain**

No.	
200—with Buffet Shelf .....	\$ 81.00
200—Closetop with Buffet Shelf..	83.00

200—with High Closet .....	90.00
200—Closetop with High Closet..	92.00

200—with Broiler High Closet ....	96.00
200—Closetop with Br. H. C.....	98.00

400—with Buffet Shelf .....	84.00
400—Closetop with Buffet Shelf..	86.00

400—with High Closet .....	93.00
400—Closetop with High Closet..	95.00

400—with Broiler High Closet ....	99.00
400—Closetop with Br. H. C.....	101.00

To be specified:

Color wanted .....	—
Gas Kindler .....	3.00
Waterfront in .....	3.00
Waterfront separate .....	4.00

**Alcazar**  
**GAS AND ELECTRIC**  
**COMBINATION**

3000—R or L.....	90.00
------------------	-------

To be specified:

No. 130 Time Control .....	8.35
----------------------------	------

# *Alcazar*

## Liquid Fuel

STOVES – RANGES – APPLIANCES  
PORTABLE OVENS

Special Net Prices  
made confidentially to

---

### TERMS

Net 30 Days, 2 per cent 10 Days

**F. O. B.**

**MILWAUKEE**

**UP TO 27c. PER CWT.  
FREIGHT ALLOWED**

---

*All prices subject to change  
without notice*

**ALCAZAR RANGE & HEATER CO.**  
MILWAUKEE, WIS.

New York Chicago Detroit Denver San Francisco



**Alcazar**  
**PRESSURE GASOLINE**  
**RANGES**

No.	
934—R or L .....	\$38.00
945—R or L .....	48.75
947—R or L (Specify color) .....	70.00
948—R or L (Specify color) .....	73.50

**LOW OVEN STYLE**

983—3 Br. ....	36.00
----------------	-------

**HIGH SHELVES**  
for No. 983 above

39—3 Br. ....	4.00
Gray Japanned Splasher	
309—3 Br. ....	6.35
White Porcelain Enameled Splasher	

**Alcazar**  
**PRESSURE GASOLINE**  
**COOKS**

**TWO BURNER**

829 .....	15.50
1829 .....	17.00

**THREE BURNER**

839 .....	18.50
1839 .....	20.25

**FOUR BURNER**

849 .....	22.00
1849 .....	24.00

**HIGH SHELVES**  
**For Above**

29—2 Br. Japanned.....	3.35
39—3 Br. " .....	4.00
49—4 Br. " .....	5.00
209—2 Br. Porcelain.....	5.15
309—3 Br. " .....	6.35
409—4 Br. " .....	8.00

**PRESSURE GASOLINE**  
**COOKS**  
**Low Style**

No.	
129 .....	14.50
139 .....	16.50

**Alcazar**  
**PRESSURE GASOLINE**  
**RADIANT HEATERS**

82—Black —4 radiants.....	13.50
92—Porcelain—4 radiants.....	16.25
182—Black —5 radiants.....	15.00
192—Porcelain—5 radiants.....	17.75
275—Fireplace—5 radiants .....	18.75

**WATER HEATERS**

9 .....	12.00
9—Burner only .....	5.00

**AUXILIARY TANK WITH**  
**PUMP**

10—(6 gal. gasoline cap.) .....	\$8.75
10 Ft. Lengths brass tubing with fitting for above .....	.75

**SERVICE KIT**

Alcazar service kit .....	\$5.00
---------------------------	--------

**Alcazar**  
**OVENS**

36 .....	\$4.50
32 .....	4.00
24 .....	3.55
20 .....	3.15
15 .....	2.50
115 .....	2.15
10 .....	1.45
9 .....	1.25

**PRESSURE GASOLINE  
COOKS**

**Low Style**

.....	14.50
.....	16.50

**Alcazar**

**PRESSURE GASOLINE  
RADIANT HEATERS**

Black —4 radiants.....	13.50
Porcelain—4 radiants.....	16.25
Black —5 radiants.....	15.00
Porcelain—5 radiants.....	17.75
Fireplace—5 radiants .....	18.75

**WATER HEATERS**

.....	12.00
-Burner only .....	5.00

**AUXILIARY TANK WITH  
PUMP**

(6 gal. gasoline cap.) .....	\$8.75
t. Lengths brass tubing with fitting for above .....	.75

**SERVICE KIT**

Alcazar service kit .....	\$5.00
---------------------------	--------

**Alcazar  
OVENS**

.....	\$4.50
.....	4.00
.....	3.55
.....	3.15
.....	2.50
.....	2.15
.....	1.45
.....	1.25

**Alcazar  
KEROSENE GAS RANGES**

No.	
8400 — .....	\$34.25
9950A—R or L (Specify color) ....	60.00

**Alcazar  
KEROSENE GAS COOKS**

**TWO BURNER**

629—2 reg. Br. ....	\$11.00
1629—2 reg. Br. Porc. ....	12.50

**THREE BURNER**

639—3 reg. Br. ....	\$14.25
1639—3 reg. Br. Porc. ....	16.00
693—2 reg. 1 giant Br. ....	18.75

**FOUR BURNER**

649—4 reg. Br. ....	\$18.00
1649—4 reg. Br. Porc. ....	20.00
694—3 reg. 1 giant Br. ....	22.75

**HIGH SHELVES**

**For Above**

29—2 Br. Japanned .....	\$3.35
39—3 Br. " .....	4.00
49—4 Br. " .....	5.00
209—2 Br. Porcelain .....	5.15
309—3 Br. " .....	6.35
409—4 Br. " .....	8.00

**Alcazar  
LONG CHIMNEY RANGE**

No.	
1100—R or L Green.....	\$32.50
1110—R or L " .....	36.00
1200—R or L " .....	36.00
1210—R or L " .....	39.50

**Alcazar  
LONG CHIMNEY COOKS**

122A—2 Br. Green .....	\$ 8.75
123A—3 Br. " .....	11.00
124A—4 Br. " .....	13.75

**HIGH SHELVES**

**For Above**

2B—2 Br. Green .....	\$ 1.65
3B—3 Br. " .....	1.75
4B—4 Br. " .....	2.25

**Alcazar  
SHORT CHIMNEY WICKS**

**No. 20—regular**

Per doz. ....	\$ 2.35
Per doz. in 3 doz. lots.....	2.25
Per gross .....	26.00

**No. 30—giant**

Per doz. ....	4.00
---------------	------

**Alcazar  
LONG CHIMNEY WICKS**

**No. 300—regular**

Per doz. ....	\$ 2.35
Per doz. in 3 doz. lots.....	2.25
Per gross .....	26.00





