

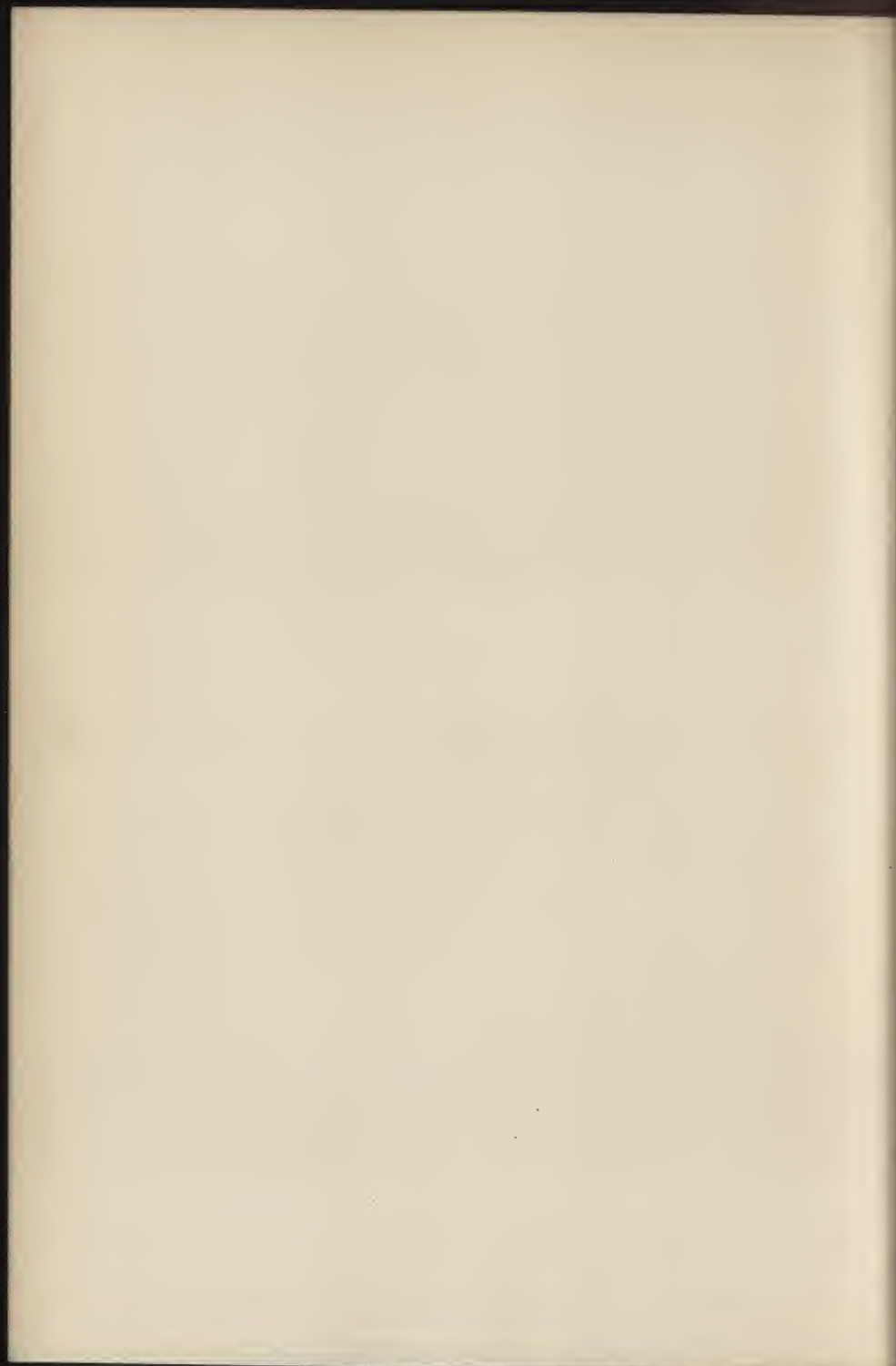



A HANDBOOK OF  
PRACTICAL GAS-FITTING



# A HANDBOOK OF PRACTICAL GAS-FITTING

A TREATISE ON THE DISTRIBUTION OF GAS IN  
SERVICE PIPES, THE USE OF COAL GAS, AND  
THE BEST MEANS OF ECONOMIZING GAS  
FROM MAIN TO BURNER

For the Use of Students,  
Plumbers, Gas-fitters, and Gas Managers

BY

WALTER GRAFTON, F.C.S.

LECTURER ON GAS MANUFACTURE, POLYTECHNIC INSTITUTE, REGENT STREET,  
AND OF THE GAS LIGHT AND COKE COMPANY, LONDON

WITH ONE HUNDRED AND FORTY-THREE ILLUSTRATIONS

LONDON  
B. T. BATSFORD, 94 HIGH HOLBORN

1901

CONS  
TH  
6840  
G73  
1901

THE NATIONAL ANTHROPOLOGICAL  
ARCHIVES

23 D 01  
F + e  
150  
6A

## PREFACE.

---

THIS work is the outcome of a series of articles contributed to the columns of *The Plumber and Decorator*, and upon their completion I have been requested by many readers to publish them in book form, since something of the kind is really needed to show the best and most economical methods of lighting by gas. This I have now done after considerable additions and revision, and have the honour to submit the same, being conscious of many deficiencies, to all interested in the art of gas lighting.

It is hoped it will supply the long-felt want of a practical text-book for the use of the student gas-fitter and plumber especially. The introduction of prepayment meters, incandescent gas lighting and stoves, has done much to require of the gas-fitter a wider knowledge of his trade, especially in regard to the principles of heating and lighting by gas, and that of its many applications.

I have endeavoured to treat the subject matter purely from a practical standpoint, and to show in a clear and comprehensive description the modes of operation adopted in the distribution of gas. At the same time much original matter is dispersed throughout its contents.

Every effort has been taken to briefly explain the essential parts of all illustrations, which are given to serve as types only of the subjects treated upon.

I take this opportunity of thanking the many firms who have so kindly allowed me the use of electros of their specialities. My thanks are also due to Mr G. Pepper and other gentlemen, to whom I am indirectly very much indebted, for valuable information, the sources of which are invariably acknowledged.

WALTER GRAFTON.

EAST HAM, *October 1900.*





# CONTENTS.

---

	PAGE
CHAPTER I.	
REGULATIONS AFFECTING GAS-FITTING . . . .	I
CHAPTER II.	
MATERIALS, TOOLS AND THEIR USES . . . .	9
CHAPTER III.	
THE LAW AFFECTING GAS SUPPLY . . . .	16
CHAPTER IV.	
RUNNING SERVICES FROM MAINS TO HOUSES (Methods of Executing Work, Cutting and Tapping Holes in Mains, Preventing Escape of Gas) . . . .	22
CHAPTER V.	
WET AND DRY METER FIXING . . . .	47
CHAPTER VI.	
GAS SUPPLY FOR DWELLING-HOUSES . . . .	58
CHAPTER VII.	
GAS FIRES . . . . .	78
CHAPTER VIII.	
GAS-FITTINGS FOR WORKSHOPS . . . .	98
CHAPTER IX.	
PUBLIC STREET LIGHTING . . . . .	116
CHAPTER X.	
PUBLIC AND PRIVATE ILLUMINATIONS . . . .	131
CHAPTER XI.	
THEATRES AND PUBLIC PLACES OF ENTERTAINMENT . . . .	141
CHAPTER XII.	
GAS-FITTINGS FOR SHOPS . . . . .	155

CHAPTER XIII.		
GAS-FITTINGS FOR SCHOOLS	- - - -	PAGE 178
CHAPTER XIV.		
THE LIGHTING OF CHURCHES AND OTHER BUILDINGS DEVOTED TO RELIGIOUS PURPOSES	- - - -	191
CHAPTER XV.		
GAS RANGES, COOKING STOVES, AND WATER HEATERS		206
CHAPTER XVI.		
GAS BURNERS	- - - -	228
CHAPTER XVII.		
INCANDESCENT GAS LIGHTING	- - - -	248
CHAPTER XVIII.		
CHIMNEY GLASSES, GLOBES, AND REFLECTORS	- -	265
CHAPTER XIX.		
PRESSURE GAUGES AND INDICATORS FOR THE DETEC- TION OF GAS ESCAPES	- - - -	275
CHAPTER XX.		
THE USE OF GAS AS AN AID TO VENTILATION	- -	286
CHAPTER XXI.		
METHODS OF CALCULATING THE SIZES OF PIPES AND THEIR DELIVERING CAPACITIES IN CUBIC FEET PER HOUR	- - - -	294
CHAPTER XXII.		
FITTING UP GAS AND METER TESTING APPARATUS	- -	300
CHAPTER XXIII.		
LIGHTING RAILWAY CARRIAGES AND SIGNALS	- -	309
INDEX	- - - -	316

## LIST OF ILLUSTRATIONS.

---

FIG.		PAGE
1.	Miller's Patent Combination Die Stock - - - -	12
2.	Small Hand Stock and Dies and Taps - - - -	12
3.	Clyburn Spanner - - - -	13
4.	Ordinary Gas Tongs - - - -	13
5.	Brock's Patent Chain Tongs - - - -	14
6.	Hulett's Service Cleanser - - - -	14
7.	Fiddes and Stagg's Patent - - - -	15
8.	Drilling Apparatus - - - -	23
9.	Rimer Tap - - - -	24
10.	Do. - - - -	25
11.	Bye-pass on Main - - - -	26
12.	Branch from Main - - - -	27
13.	Syphon Box or Drip-well - - - -	30
14.	Cast-iron Service - - - -	31
15.	Common Vice Drill - - - -	32
16.	Service connected to Main - - - -	33
17.	Caulking Tool - - - -	34
18.	Pipe laid in "Shooting" or Trough - - - -	38
19.	Cutting a Hole in Main - - - -	39
20.	Main Cock - - - -	40
21.	Do. - - - -	41
22.	Dressing Tool - - - -	42
23.	Main Cock - - - -	43
24.	Blow-pipe - - - -	44
25.	Cap and Lining - - - -	44
26.	Tye-joint and Mould - - - -	45
27.	Meter Fixing - - - -	51
28.	Syphon - - - -	55
29.	Portable Tube Vice - - - -	59
30.	Three Wheel Pipe Cutter - - - -	60
31.	Cutting Wheels - - - -	61
32.	Supply Pipe for Gasaliers - - - -	69
33.	Tabular-reflector Stove - - - -	83

FIG.	PAGE
34. Gas Burner and Fire Brick - - - -	84
35. Coral Fuel - - - -	85
36. Sectional View of Fire Grate - - - -	86
37. Burner for Grates - - - -	87
38. Do. do. - - - -	87
39. Sectional View of Burner and Grate - - - -	88
40. Plans of Ordinary Grates - - - -	89
41. Interior Gas Grate - - - -	90
42. Adjustable Stand - - - -	93
43. Wing-joint - - - -	100
44. Swivel - - - -	100
45. Swivel Cock - - - -	101
46. Handy Drill - - - -	102
47. Universal Swivel having Fly-nuts - - - -	103
48. Ring Pendant - - - -	107
49. Socket Cock - - - -	109
50. Main Cock with Bye-pass - - - -	112
51. Branch Tee-piece - - - -	113
52. Branching-tee - - - -	114
53. Lamp Column and Lantern - - - -	118
54. Combination Bracket and Column - - - -	118
55. Column Cock - - - -	125
56. Lamplighter's Torch - - - -	125
57. Puttyless Lamp - - - -	127
58. Vauxhall Lamp - - - -	128
59. Millard's Portable Vice - - - -	129
60. Illumination Device - - - -	132
61. Do. do. - - - -	133
62. Bodkin - - - -	134
63. Effective Method of Edging - - - -	135
64. Illumination Jet Burner - - - -	135
65. Illumination Bucket Device - - - -	137
66. Border Lights - - - -	145
67. Foot Lights - - - -	148
68. Plan of distributing Gas in Theatres - - - -	<i>opposite</i> 149
69. Hydraulic Joint - - - -	153
70. Reflector for Windows - - - -	159
71. Upright Back with Single Swing - - - -	160
72. Reflecting Cluster - - - -	162
73. Reflecting Lamp for outside Shops - - - -	163
74. Bracket and Lamp - - - -	164

FIG.	PAGE
75. Veritas Gas Arc Lantern - - - -	165
75A. Veritas Gas Arc Lantern with Swan-neck Pendant -	166
76. Lamp Top with Fly-nut and Key - - - -	168
77. Lamp Fittings - - - - -	169
78. Effective Rail for Shop Window - - - -	172
79. Six-Light Pendant - - - - -	173
80. Star Lights - - - - -	174
81. Inlet Safety Double Check Gas Regulator - -	175
82. Fletcher's Governor - - - - -	176
83. Plans showing Position of Pendants in Schools -	183
84. Do. do. do. do. - - - - -	183
85. Reflecting Pendants with Welsbach Burners - -	184
86. Do. do. do. do. - - - - -	185
87. Reflecting Pendant with Welsbach Burners - -	187
88. Two-wire Globes - - - - -	189
89. Carter's Valve - - - - -	193
90. Suspension Bracket - - - - -	194
91. Three Patterns of Tripod Burners - - - -	195
92. Ling Ornamental Bracket - - - - -	196
93. Pendant and Corona Lights - - - - -	197
94. Standard for Churches - - - - -	199
95. Pillar Light - - - - -	200
96. Incandescent Pendant - - - - -	201
96A. Two Sketches showing Position of Lights in Chapels	204
97. Gas Range - - - - -	210
98. Model Gas Range - - - - -	211
99. New Rapid Water Heater - - - - -	214
100. Horizontal Web Water Heater - - - - -	216
101. Foot Stove - - - - -	217
102. Handy Gas Grill - - - - -	219
103. Square "Standard" Boiling Burner - - - -	220
104. Argand Boiling Ring - - - - -	221
105. Internally Heated Smoothing-iron - - - -	221
106. Bracket with Fitting for Flexible Tubing - -	222
107. "Atlantic" Gas Tubing - - - - -	224
108. Wing-Cap Connections for Flexible Metallic Tubing -	225
109. Two Illustrations of Union-Jet Burners - -	230
110. Batwing Burner - - - - -	231
111. Two Illustrations of Slit-union Burners - -	232
112. Bray's Adjustable Burners - - - - -	233
113. Sugg's "Winsor" Screw Regulating Burner - -	235

FIG.		PAGE
114.	Peebles' Needle Governor Burner - - -	237
115.	Hawkins & Barton's Street Lamp Burner - - -	239
116.	London Argand Burner - - -	240
117.	Regenerative Lamp - - -	243
118.	Section of Fullford's Regenerative Burner - - -	244
119.	Falk, Stadelmann, & Co.'s Acetylene Burner - - -	246
120.	Welsbach Kern Burner - - -	250
121.	Pattern of Globe and Cup for Incandescent Lighting -	253
122.	Section of Bansept Burner - - -	255
123.	Welsbach Mantle - - -	259
124.	Solid-cone Incandescent Light - - -	263
125.	Combination Glass-rod Chimney - - -	267
126.	Bulb with Band - - -	268
127.	Holophane Globe - - -	270
128.	Diagram of Illuminating Results - - -	272
129.	Opal Squat Incandescent Globe - - -	272
130.	Reflector of Silvered Glass - - -	273
131.	Portable Gas-pressure Gauge - - -	273
132.	Thorp's Gas Consumption and Pressure Indicator -	278
133.	Ansell's Gas-leak Indicator - - -	279
134.	Ashworth-Hepplewhite-Grey Test-lamp - - -	282
135.	Diagram of Flame Caps and Percentages of Gas -	283
136.	Diagram representing Imaginary Pipes - - -	298
137.	Apparatus for Testing Meters - - -	306
138.	Coligny-Welch Railway Carriage Lamp - - -	312
139.	Coligny-Welch Lamp open for Cleaning - - -	313
140.	Bray's Cased Enamel Burner for Oil Gas - - -	313

# A HANDBOOK OF PRACTICAL GAS-FITTING.



## CHAPTER I.

### REGULATIONS AFFECTING GAS FITTING.

IN dealing with practical work it will be necessary to give rules to guide the gas fitter, since he may be called upon to undertake all kinds of fitting work, and some theoretical knowledge will often be of use in cases of doubt or difficulty. There is plenty of improvement needed on the part of many employed in running services and erecting fittings. Intelligent ideas on proportioning services, and on the principles of combustion and burners, will tend to the employment of fittings and burners giving higher units of efficiency.

When a house has to be run with gas pipes, or existing fittings have to undergo extensions or alterations, it is of the first importance to employ competent gas-fitters, men who have some recommendation, either in the shape of work done for high class houses or by years of experience. Having tried all methods they are then better able to judge which will more likely suit and give satisfaction to their customers. It is false economy to employ inexperienced workmen, for although the intelligent and experienced gas-fitter may charge a little more in the

first instance, his executed work will more than likely give entire satisfaction.

Gas-fittings should be carefully arranged and made of good materials, for it should be borne in mind that the gas-consumer does not want his fixtures renewed in a year or two, nor does he want the gas-fitter again inside the house to repair his faulty work, completed only a short time ago. It is most annoying to have an escape of gas, or to find that owing to some fault the gas will not pass satisfactorily through the pipes. In addition to these, other defects often occur for want of thought, and as a rule are not discovered until the work is completed.

It is a common fallacy to expect a gas-fitter to know everything about or connected with gas, but he ought to enlighten himself as much as possible on the subject. Bad smells in the house or work-room do not necessarily mean leakage; they may be produced, especially in the country, by burning impure gas, or by bad ventilation. In all that appertains to gas and its fittings, the gas-fitter should be in a position to carry out all work to the satisfaction of the consumer and the gas company.

The requirements for the proper fitting of gas pipes in any house to the satisfaction of the consumer and producer have been partly gathered from large firms of gas-fitters and gas-engineers as well as from experience, and are framed in such a way as to be grasped by any gas-fitter.

1.—Cheap gas-fittings should be guarded against, as they occasion annoyance and expense, whereas money is well spent when laid out on strong and well-made fittings.

2.—In the distribution of gas the first essential is that the pressure should be maintained throughout the system of mains and services at not less than that fixed by the Act of



Parliament affecting any particular city or town—this being the minimum allowed—and no part should have an excess of pressure (excepting that used for high pressure incandescent gas lighting) to compensate for insufficiency of main area in any part, as this excessive pressure tends to increase leakage. Stoves require more pressure than for ordinary lighting purposes.

All internal fittings should be subject to inspection. Model forms will be found on page 8.

3.—All lines of piping throughout the building, except drops, must be laid with a grade so as to drip or drain back into the risers, with no sagging to hold condensation. Drips and drip-pipes, where needed, must be provided at such points as the plan of piping may render necessary.

4.—No principal riser must be less than  $\frac{1}{2}$  in. in diameter in any case, and all risers must be protected from freezing. Where risers or other pipes cannot be covered up on inside partitions, they must be protected by special and effective means.

5.—Wherever practicable, all piping should be exposed, but piping, especially if for the pre-payment system, that must be concealed should first be thoroughly inspected by the gas company's official, to whom the gas-fitter should give due notice when it is ready for examination. Unexposed pipes must be so concealed as to be readily accessible in case of examination or repairs. Floor boards covering pipes should be screwed with brass (preferably) screws and not nailed.

6.—In all cases where extensions are made, care should be taken to extend with such sizes that the rules always prescribed may be maintained.

7.—All drop pipes should, as far as possible, be left perfectly plumb and secured in that position.

8.—Long runs of piping should be firmly supported at frequent intervals, so that no sagging or depressions can occur in which water may collect.

9.—If pipes run across wooden beams or joists the requisite cutting, notching, or boring should not be more than  $1\frac{1}{2}$  in. (if 2 in. the joists are rendered unsafe), nor when of this size more than 3 ft. from the bearings, but put them as near the latter as possible.

10.—Avoid laying pipes under tiled or parquet floors, stone or metal platforms, or hearthstones, unless local conditions render such proceedings imperatively necessary.

11.—All pipes should be of the best quality of wrought iron tube, and all fittings, as elbows, bends, tees, reducers, &c., should be extra heavy malleable or wrought-iron fittings. Above 3 in. in diameter are generally of cast iron. The pipes, especially for exposed positions, should be galvanised or rendered non-corrodible.

12.—The joining of the tubes or pipes should be made in the most solid manner, and perfectly gas tight. Red and white lead mixed being preferable to either alone.

13.—All pipes should be firmly secured in position by means of hooks, iron or brass straps for holdfasts (screws, not nails, must be used for straps) at close intervals, so as to secure the pipe in a direct line.

14.—All pipes completely fitted should be tested. This can be best done by capping or plugging all outlets, where cocks are not provided, and by means of air pumped into the whole system of pipes until a pressure of air equal to a column of water 9 in. high is reached. This column of water should stand or be maintained by the pressure of the air in the pipes for at least 10 minutes, but if the water falls more than 1 in. in that time there are

leaks which must be sought and stopped. When the meter is fixed the gas pressure may be used, and the index noted, but a longer period of time must be allowed with a low pressure.

15.—The most convenient place should be chosen for the meter, whether on the floor or support, and within 2 ft. 6 in. of the main cock. The diameter of the connecting pipes must not be less than the meter unions.

The following are the sizes of wet meters and connections, also capacities per revolution and per hour :—

Size of Meters.	Size of Inlet and Outlet in inches.	Measuring Capacity per Revolution Cubic Feet.	Measuring Capacity per Hour. Cubic Feet.
2 light	$\frac{1}{2}$	$\frac{1}{12}$	12
3 "	$\frac{5}{8}$	$\frac{1}{8}$	18
5 "	$\frac{3}{4}$	$\frac{1}{4}$	30
10 "	1	$\frac{1}{2}$	60
15 "	1	$\frac{3}{4}$	90
20 "	$1\frac{1}{4}$	1	120
30 "	$1\frac{3}{8}$	$1\frac{1}{2}$	180
50 "	$1\frac{1}{2}$	$2\frac{1}{2}$	300
60 "	$1\frac{1}{2}$	3	360
80 "	$1\frac{3}{4}$	4	480
100 "	2	5	600
150 "	3	$7\frac{1}{2}$	900
200 "	3	10	1,200
250 "	4	$12\frac{1}{2}$	1,500
300 "	4	15	1,800
400 "	4	20	2,400
500 "	5	25	3,000
600 "	5	30	3,600
800 "	6	40	4,800
1,000 "	7	50	6,000

From the above table can be ascertained the number of lights which any size of meter will supply. Rule: Divide the measuring capacity per hour by the size of burners in feet it is desired to use. Example: What number of lights will a 30-light meter supply when it is desired to use 5 ft. per hour burners on the principal floor, and 3 ft.

per hour in, say, the bedrooms? Twenty-four 5 ft. and twenty 3 ft. burners, or  $\frac{180}{5}=36$  5 ft. burners.

Sizes and prices of gas meters :—

Size of Meter.	Dry Meter.		Wet Meter.	
	Price.	Stamping Fee.	Price.	Stamping Fee.
	£ s. d.	s. d.	£ s. d.	s. d.
1	1 0 6	0 6		
2	1 4 6	0 6	1 8 0	0 6
3	1 10 0	0 6	1 13 6	0 6
5	1 16 6	0 6	2 10 0	0 6
10	2 7 0	1 0	3 17 6	1 0
20	3 5 0	1 0	5 16 6	1 0
30	4 10 0	1 0	8 18 0	1 0
50	6 5 0	1 0	13 6 6	2 0

These prices are subject to discount to the trade, and meters are guaranteed for five years.

16.—With respect to internal fittings the following sizes and lengths of iron, lead, or composition pipes to be used in the premises, depend upon the number of burners required :—

Internal Diameter of Tubing. Inches.	Greatest Length Allowed. Feet.	Maximum Number of Lights.*
$\frac{3}{8}$	20†	3
$\frac{1}{2}$	30	4
$\frac{5}{8}$	40	10
$\frac{3}{4}$	50	15
1	100	25
$1\frac{1}{4}$	90	40
$1\frac{1}{2}$	120	70
2	160	130
$2\frac{1}{2}$	200	175
3	300	250
4	400	350

17.—With gas stoves and ranges, the following

\* One burner consuming 6 cubic feet per hour.

† Shorter lengths more burners can be used.

regulations should be observed as to the length and sizes of piping :—

Average Size of Oven Inside.	Distance of Stove from the Meter.	Size of Service Pipe Required.
Stove No. 0—11in. × 11in. × 14in.	Under 30 feet	$\frac{1}{2}$ in.
„ „ „	If 60 „	$\frac{5}{8}$ in.
„ „ 1—14in —14in.—24in.	„ 30 „	$\frac{3}{4}$ in.
„ „ „	„ 60 „	$\frac{7}{8}$ in.
„ „ 2—16in.— 16in.—24in.	„ 30 „	$\frac{7}{8}$ in.
„ „ „	„ 60 „	1 in.
„ „ 3—19in.—19in.—24in.	„ 30 „	1 in.
„ „ „	„ 60 „	1 $\frac{1}{4}$ in.

The sizes of piping are for single lines of pipe run from or near the meter. When gas ranges or stoves are supplied by branch-pipes, or when the branch-pipes are run from the main service of the building, the combined sectional areas of all the pipe sections must *exceed* the sectional area of the chief main or supply pipe sufficiently to maintain a good flow of gas.

18.—In case of an escape of gas do not search for it with a naked light, but use a strong solution of soap water to paint the pipes, at the same time have the windows and doors open.

Abridged forms :—

Town or City

Date

190

To the Gas Engineer.

I, \_\_\_\_\_ hereby give you notice that I have completed the laying of the gas pipes in the manner required by your Regulations, at Nos. \_\_\_\_\_ street, the property of Mr. \_\_\_\_\_, and the work is now ready for your inspection.

Size of Main Pipe

No. of Preparations

No. of Burners

Size of Stove (or Stove Pipe)

(Signed)

Gas-Fitter.

Address

N.B.—Gas-fitters or plumbers must send this form to the Gas Office at least three days before plastering is commenced (if a new house). In any case no pipes that are covered will be passed.

—————  
Inspector's Report.

I have inspected the above, and find them as stated (except \_\_\_\_\_) and I recommend that the work be passed, and a \_\_\_\_\_ inch service pipe to be laid.

Distance from nearest main \_\_\_\_\_ feet

(Signature)

Inspector.

Date

190

—————  
Gas-fitters who comply with the regulations of the Gas Company or Local Authority can have their names registered on the list of approved fitters, and they generally designate themselves "Authorised Gas-fitter." Repeated blundering will disqualify any gas-fitter, and cause his name to be removed from the register.

## CHAPTER II.

## MATERIALS, TOOLS, AND THEIR USES.

THE pipes or tubing used for conveying the gas from the main in the street to the house or building are called main-service pipes. The materials of which they are made are chiefly of two kinds—viz., wrought and cast-iron, although lead piping is sometimes employed in this country. The latter is not to be recommended because, even if the nature of the soil be good, it is easily bent out of a straight line by the settlement of the ground. Lead tubing has one great advantage over iron in that it can be laid in one piece from main to meter, requiring only a joint at each end.

For underground, wrought-iron pipes are the best for many reasons, the chief of these being: they are more durable, and having the ends of the piping screwed, they are quickly connected together by means of a socket. The tubing can be obtained in any convenient lengths, each length being supplied with a socket. The principal thing to observe is the screwing of the pipe. No matter whether it be a piece of tube or a connecting piece, as a socket or tee, the threads should be regular, uniform, and equally well cut, so that the pipe is as well threaded as its fittings.

Fittings are often too loose, owing to the cutting taps being too large. When the fittings are obtained from one firm and the tubing from another, the threads or screws very often do not fit well together, being either

too large or too small ; and so to get anything like a tight joint resource is made to tow or hemp-yarn, with a coating of lead paint to fill up the deficiency of metal. This makes a joint of short duration, especially if the service is likely to be subject to overhead traffic. Pressure caused by the settlement of the ground or frost may so affect the metal as to partly disjoint the connection, and leakage occurs. The author believes that it is these badly made joints which are the cause of so much unaccounted-for gas, to be found more especially in provincial towns. They are also dangerous, because the escaping gas may travel underground and finally enter a building, where serious results may follow. Fatal results have happened from similar escapes of gas. The remedy, then, is for all joints to be so connected that we have only a mere trace of packing material in the shape of the lead paint filling up the interstices of the screws, so as to render the joint, in reality, a metal one. The welding of the tubes should be good and not really perceptible, and with no indication of a crack.

Having dwelt briefly upon the defects in wrought-iron tubes, it will also be necessary to comment briefly upon cast-iron services ; but before doing so, we will dispense for the present with the question of the action of various soils or earths upon metal services, since in a succeeding chapter, will be recommended—no matter what the nature of the ground may be—some preservative material, for it should be remembered that many pipes have to be taken through ground which cannot be chosen.

Cast-iron services of small dimensions are unsatisfactory ; in the first place, they are easily ruptured by overhead traffic, and again, the lead joints being small are difficult to caulk sufficiently tight without



bursting the socket end, and all pipes under 3 in. being only of about 6 ft. long, necessitate a greater number of joints than when wrought-iron is used. That the metal should be close in grain and practically free from defects, such as non-uniformity in thickness, is of great importance. The pipes previous to being laid should be tapped with a hammer, and if they emit a clear, bell-like sound it generally indicates a freedom from cracks or flaws; but if the sound be dull the pipe is cracked or imperfect. All pipes bought should have been tested by water under a pressure of at least 70 lbs. per square inch. This is necessary since gas can get through a smaller orifice than would let water pass through.

Gas is distributed over premises by means of either iron, lead, composition, brass, copper or tin tubing; it all depends upon the nature and circumstances of the building as well as the purpose for which the gas is to be used.

For the present we will content ourselves with the mere mention of these pipes, hereafter to be treated upon singly as they may be required in fitting up the various buildings.

To speak of tools singly and severally would entail no end of writing, and as these chapters are for men actually engaged in fitting up gas and water pipes, it will only be necessary to touch here and there upon new and special tools calling for a few words of description. The tool chest or bag of the fitter contains no fixed set or number of tools; it may contain more or less according to the adaptability of the tool as well as the ideas of application possessed by the worker. The fitter's tools, if we take them separately, are not always used for any particular job but are used for various and very dissimilar purposes sometimes.

The threads or screws being of the first importance, it is necessary to use a tool or machine that will, by the aid of manual labour, do good work. There are many such tools, more or less perfect, on the market. A good



FIG. 1.

die stock should be complete in itself as a tool, and should be fitted with a self-centring vice to hold the pipe. It is an advantage to have a "cut off" attachment, although this is not generally found fitted to all machines having a low "range"—*i.e.*, for threading a  $\frac{1}{4}$  in.,  $\frac{3}{8}$  in.,  $\frac{1}{2}$  in.,  $\frac{3}{4}$  in., 1 in.,  $1\frac{1}{4}$  in.,  $1\frac{1}{2}$  in. and 2 in. tube. Machines taking above 1 in. pipe (this being the smallest diameter) have a "cut off" adjunct. This self-acting, feed cutting-off

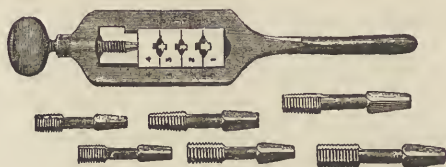

FIG. 2.

apparatus is an important addition to the machine since it can be used also for making nipples and bolts. With each specified size of machine, dies, having an improved, disengaging motion, are included with screw-keys, &c., complete. Miller's patent ratchet combination die-stock is used for screwing iron gas pipes, and with this stock shown in Fig. 1, can be used the drill attachments for drilling mains in trenches. It has three distinct features: 1, direct acting screw stock; 2, a ratchet screw stock; 3, a

ratchet drill brace; which combine to form an exceedingly useful tool.

A small hand stock and dies for brass and copper tube with taper and plug taps to each size, is a most necessary



FIG. 3.

tool and one much required daily. The one illustrated (Fig. 2) is by far the handiest, requiring no changing of dies, and the adjustment is simple. Care, however, should be taken to see that the die is straight before cutting the screw, otherwise, when threaded and screwed into, say, a tee, the pipe will be out of line.

The "Clyburn" spanner (Fig. 3) is a capital tool, made of good material and possessing strong jaws not readily put out of order.

The ordinary gas tongs, as illustrated (Fig. 4), have two disadvantages. Firstly, they soon get out of order,



FIG. 4.

requiring the under, or biting, jaw re-sharpened, and, secondly, for different sizes of pipe you require another pair of tongs, not only for the barrel but also for the socket, and to have a stock of these tools means a great weight to carry about. Brock's patent chain tongs (Fig. 5), are the best for all-round work. Being made entirely of steel they have many advantages, the chief of which are strength and durability. The duplicate reversible

jaws are hardened to the same degree as saws, so that they may be easily sharpened with a file. The parts are



FIG. 5.

interchangeable and duplicates can be had when any part wears out. They can be readily used in places where other tongs cannot be worked, since it is only necessary to have sufficient room to get the chain round the pipe.

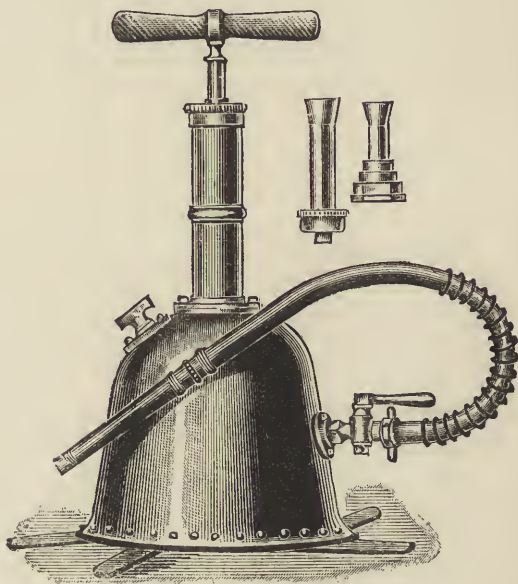

FIG. 6.

#### HULETT'S SERVICE CLEANSER.

They are the only chain wrenches adapted to suit all sizes of pipe, bolts, bars or shafts. The tongs are a little dearer than the ordinary type, but when you consider

that one chain wrench equals six pairs of the former, besides will wear out many pairs, the price becomes in the end less than for common tongs, covering a given period and a like amount of work done.

The last tool we must consider in this chapter is the service cleanser for the removal of naphthalene or other obstruction in services or fittings by compressed air, or by hot water displaced by compressed air at one and the same time. There are three types. "The Original" cleanser is a very good one (Fig. 6). A leading firm



FIG. 7.

FIDDES &amp; STAGG'S PATENT.

manufacture one for services and one for blowing lamp-post services, tubing, fitted with unions, &c., being supplied with it, and another firm make a good one in which they adopt a leather cup (Fig 7) as a plunger instead of the ordinary valve in it. The pump is simple, durable and light, giving a high pressure, and can easily be taken to pieces to have the internal parts renewed by any fitter. The body of the pump is globular in shape.

## CHAPTER III.

## THE LAW AFFECTING GAS SUPPLY.

BEFORE proceeding further with the subject it will be well to consider brief portions of the Gas Works Clauses Acts 1847 and 1871, relating to the supply of gas, and which will help to make our ideas more clear as to what constitutes proper requirements in so far as the law bears upon gas services.

The gas-fitter who carefully reads through these clauses will not be wholly ignorant of the law on gas supply as affects his trade, but will be in a position to say, recommend or do, when occasion arises, just what will satisfy the consumer and the law. And again, gas-fitters are often sent for to do urgent work, and a knowledge of the law safeguards them from doing what they ought not to do without first letting the "undertakers" know about it.

Although these Acts affect all gas companies to some extent, yet each gas company have their own special Act, and this should be studied when in doubt about any branch pipe in any particular district.

The following words have the meanings assigned to them by law, and are of interest. The word "street," includes any square, court, or alley, highway, lane, road, thoroughfare, or public passage or place.

The word "premises," includes public and private messuages, and other buildings, lands and tenements.

"Gas-rate." The expression, "gas-rate," includes any rent, reward, or payment to be made to the undertakers for a supply of gas.

“Undertakers.” The expression, “the undertakers,” means the gas company or other person authorised to construct gas-works.

“Person,” means corporation, whether aggregate or sole.

In commenting on the clauses of the Acts, only such matter will be given as applies to small fittings, and not such as affects gas supply in general, which embraces main-layers' work.

“Streets,” when broken up, must be reinstated without delay, and the “road or pavement which has been so broken up,” must be kept by the undertakers “in good repair for three months after replacing and making good the same, and for such further time, if any, not being more than twelve months in the whole, as the soil so broken up shall continue to subside.” The opened road or pavement must be guarded by fencing or lights, to warn passengers. If the Company delay in reinstating, a penalty is enforced for each day after notice has been served.

1847, Section 13. “The undertakers may from time to time enter into contract with any person for lighting or supplying with gas any public or private building, or for providing any person with pipes, burners, meters, and lamps, and for the repair thereof; and may also from time to time enter into any contract with the commissioners, trustees, or other persons having the control of the streets within the limits of the special Act for lighting the same or any of them with gas, and for providing such commissioners, trustees, or persons with lamps, lamp-posts, burners and pipes for such purposes, and for the repairs thereof, in such a manner and upon such terms as shall be agreed upon between the undertakers and the said commissioners, trustees, or other persons.”

Section 15. "The clerk, engineer or other officer duly appointed for the purpose by the undertakers may at all reasonable times enter any building or place lighted with gas supplied by the undertakers, in order to inspect the meters, fittings, and works for regulating the supply of gas, and for the purpose of ascertaining the quantity of gas consumed or supplied; and if any person hinder such officer as aforesaid from entering and making such inspection as aforesaid at any reasonable time" (usually between 9 and 4) "he shall for every such offence forfeit to the undertakers a sum not exceeding five pounds."

In cases where the quarter's gas bill is not likely to be paid, and no notice is here mentioned to be given by the undertakers, the service can be cut off and summons served upon the party for any sum under £20.

Section 17. "In all cases in which the undertakers are authorised to cut off and take away the supply of gas from any house or building or premises under the provision of this or the special Act, the undertakers, their agents or workmen, after giving twenty-four hours' previous notice to the occupier, may enter into any such house, building premises, between the hours of nine in the forenoon and four in the afternoon, and remove and carry away any pipe, meter, fittings, or other works the property of the undertakers."

Section 18. "Every person who shall lay or cause to be laid any pipe to communicate with any pipe belonging to the undertakers without their consent, or shall fraudulently injure any such meter as aforesaid, or who in case the gas supplied by the undertakers is not ascertained by meter" . . . . "or who shall supply any other person with any of the gas supplied to him, notwithstanding any contract which may have been



previously entered into," is liable to punishment by a penalty of £5, and a further £2 per day for every day that gas is so continued to be used.

Wilfully damaging the company's pipes, lamps or other works, extinguishing public lamplights is also punishable by fine £5.

Provisions are made in these Acts for protecting the public, as to the fouling or contaminating of water by escaping gas from leaky joints, whether wilfully or accidentally, and severe penalties are imposed on the gas companies. The water companies are protected by clauses in the Metropolis Gas Act, 1860. These clauses refer to a question merely between the water companies and the gas companies, providing stringent means to prevent the leakage of gas from pipes.

In Section 50 of this Act, there are definite instructions on the mode of laying pipes. Properly form and join with proper and sufficient materials " . . . . the joints or screws of the branch or service gas pipes connecting with the main gas pipes, and also the joints of the services or branch pipes for conveying the gas from the main gas pipes to the houses and other buildings, and all other joints, inlets, apertures, or openings which are or shall or may be made in any of the main gas pipes belonging to the gas company, in such manner and of such material as shall, as far as reasonably practicable, prevent leakage."

Also, in this Act, the gas companies provide service pipes from their mains which lie within fifty yards of any premises, subject to the occupier agreeing to have a supply of gas for a definite period.

1871, Section 2. "The undertakers shall, upon being required so to do by the owner or occupier of any premises situate within twenty-five yards from the main of the

undertakers, or such other distance as may be prescribed, give and continue to give a supply of gas for such premises, under such pressure in the main as may be prescribed, and they shall furnish and lay any pipe that may be necessary for such purpose, subject to the conditions following (that is to say):—

“The cost of so much of any pipe for the supply of gas to any owner or occupier as may be laid upon the property of such owner or in possession of such occupier, and of so much of any pipe as may be laid for a greater distance than thirty feet from any pipe of the undertakers, although not on such property, shall be defrayed by such owner or occupier.”

Then follows conditions of agreement and security for payment of gas rent.

Section 15. “No consumer shall connect any meter with any pipe through which gas is supplied by the undertakers to such meter, or disconnect any meter from such pipe, unless he shall have given to the undertakers not less than twenty-four hours’ notice in writing of his intention so to do,” under a penalty of 40s.

Section 24. “The undertakers shall supply gas to any public lamps within the distance of fifty yards from any of the mains of the undertakers in such quantities as the local authority of each district or the trustees of any turnpike road or highway board within the limits of the special Act may from time to time require to be supplied, and the price to be charged by the undertakers” is generally settled by agreement.

Section 25 specifies as to the consumption of gas supplied to the public lamps by meter, or “If the gas is supplied to the public lamps in any district by average meter indication, the undertakers shall, for securing

uniformity of consumption between metered and unmetered lamps, from time to time provide the public lamps in such district with proper self-acting pressure regulators and burners to the satisfaction of the local authority of such district; and the average amount of the indications of all the meters attached to the public lamps within such district under the control of the local authority shall, except as hereinafter mentioned, be deemed to be the amount consumed by each such lamp in such district."

Section 26. "In case gas is supplied to the public lamps in any district by the undertakers, they or the local authority of such district may, at their own expense, cause to be affixed to each lamp the instrument known as a street lamp governor, and the undertakers or such local authority (as the case requires) shall be entitled to have access thereto for the purpose of examining the same."

## CHAPTER IV.

RUNNING SERVICES FROM MAINS TO HOUSES.—METHODS  
OF EXECUTING WORK.—CUTTING AND TAPPING  
HOLES IN MAINS.—PREVENTING ESCAPE  
OF GAS.

SERVICE pipes include all pipes which branch from the district supply-mains to the public lamps, and for conveying gas to meters in houses and places of business. In dealing with this branch of the work, it is well to consider the size of the pipe, which should be determined by the probable consumption of gas in any factory or house at some future date, since the branching district mains are usually laid larger than the present district consumption demands. This provisional increase in size of main should be made for at least 10 years' increase in consumption of gas, and in a like manner then, also should the service pipe be laid larger than for present requirements of any large factory or house. This does not, however, apply to small artisan dwellings, but even in this case, corroding influences require consideration. Especially is this necessary when we consider the fast strides that are being made with burners, stoves and coin-freed meters.

We will consider the laying down of large services, although in some localities this part of the work is conducted by the main layer; but in smaller towns it is performed by the general gas-fitter.

As an example, we may assume to have an order to supply gas to a large house or factory where 300 lights are needed and the main passing the building to be a 6 in. one. Referring to table given in Chapter I. we find that to supply 300 lights a 4 in. service will have to be taken from the main, and this will supply sufficient gas for both heating and lighting purposes, allowing for additional lights that may eventually be required. To insert a 4 in.

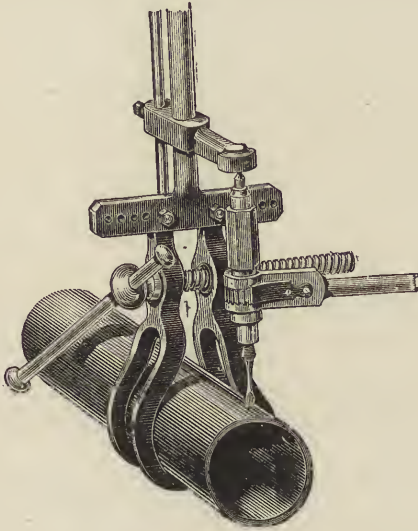

FIG. 8.

cast-iron pipe in a 6 in. pipe cannot well be done by cutting a hole and fixing thereto a cast-iron saddle-socket to the larger pipe ; but the latter will have to be cut and a T-piece let in. The house or factory in question may not be at the end of the street, and seeing that the gas may be wanted for other businesses or heating houses, the work will have to be done without entirely cutting off the supply of gas from the rest of the main.

The ground having been got out covering one length of pipe and also in the direction to which the reduced pipe is to be taken, the following will be wanted for the job:—Hammers, cutting chisels, two 6 in. indiarubber cloth bags for plugging the main (B, Fig. 11), some tarred yarn, old rope or asbestos rope, lead pot and ladle, coke-fire grate, caulking tools, a piece or two of 1 in. lead or wrought-iron piping with two unions or



FIG. 9.

connectors, drilling apparatus as illustrated in Fig. 8, 1 in. rimer taps (Figs. 9 and 10), a socket or collar (C, Fig. 12), and a 6 in. reducing to 4 in. rounded-off socket T-piece. All things being ready, the fitter must take the length of the T-piece, including socket, which will be 3 ft., and mark with a piece of chalk on the 6 in. main an equal length, less 1 in., opposite to the trench in which the 4 in. pipe is to be laid. Continue the chalk marks (A) carefully right round the main. The fitter must now fit up a 1 in. connecting link—if he has not already one on the cart. This is best made up of one bend-union, a bend, and a piece of barrel, and when connected together see what span it has between the centre of bends, which should be of such a length as will leave plenty of room, when connected to main, to allow for cutting operations and for bladdering main between bends.

Now, by means of a centre punch mark off the distance representing the centre of bends on the main. Fit up drilling apparatus, drill and tap two  $1\frac{3}{16}$  in. holes, screwing in temporary plugs; then between these holes

and the ring marks, but quite 1 ft. away from the latter, drill two smaller holes, say  $\frac{5}{8}$  in. or  $\frac{3}{4}$  in. (removing sharp edges which would injure the bladders), through which insert the indiarubber bags rolled up tightly in a line with the neck of each. When in, and to prevent gas escaping, work a little clay between rubber tube and metal.

You are now ready to connect the link or bye-pass by removing the plugs from the 1 in. pipe holes and screwing in the bends, uniting them with the piece of barrel, union and sockets, as shown in Fig. 11. You have now a means of supplying sufficient gas for ordinary use from one end of the main pipe to the other. Next well inflate the rubber bags, B, by means of the mouth or preferably a force pump (Fig. 6), closing taps when they are full of air.

You can now proceed to cut out the portion of main with chisels, working on the chalk line and using a little oil on the chisel to prevent sparks, which will ignite gas should any escape. When the lines are practically cut through, a few blows from a small sledge

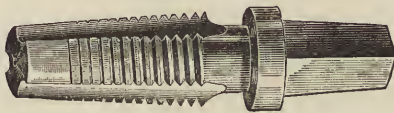

FIG. 10.

hammer on the piece, A A, will effect separation. This is now removed and all dirt in the main must be taken out. The collar, 12 in. long, must now be placed on the left hand portion of main by sliding it along until it is flush with the cut end. You will now be able to get the T-piece in. Its socket is passed over the right hand cut main.

This done, slide back the collar until it is equi-distant on the main and T-piece, as shown completely finished in Fig. 12.

Changes of temperature influence lead-jointing on account of the fact that the rates or co-efficients of expansion and contraction of lead and iron differ considerably, and in time the lead does not completely fill the annular space between socket and spigot. The co-efficients of the linear expansion of lead and cast iron are respectively  $0.0000287$  and  $0.0000112$  of an inch for each degree, increase or decrease, of heat. On account of the lead expanding three times more than iron, and as it has not room to expand radially in the socket, but only longitudinally, the band of lead is consequently rendered thinner when cooled to any extent, as is the case between a hot summer and a cold winter. Again, the length of pipe is lengthened or shortened by an increase or decrease of temperature, and this movement in and out of the socket also tends to loosen the joint. This seems to be borne

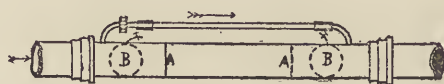

FIG. 11.

out by the increased leakage of gas in winter, irrespective of pressure, although the night pressure is on longer in winter than in summer. Whatever the theoretical aspect of the question may be, the operation of jointing socket pipes should be done with great care, as on its perfect state the soundness or tightness of the joint very much depends.

Tarred yarn, or better, though more expensive, asbestos rope, must be wound round each pipe, and



with a caulking tool rammed into the annular space between socket and spigot ends of the pipes, leaving about 2 in. for lead in front, or, in other words, about half fill the space with yarn. While much of the foregoing is being executed, the lead pot can be suspended over the portable fire.

Prepare now some clay by making it just moist enough to work stiffly, and with it work a clay belt round the pipe, pressing the clay up to the face of the socket, finishing off at the top with a "gate" or "lip." With pipes of larger dimensions, an iron band, hinged in the middle, as a pair of calipers, is some times substituted for the clay belt. This simply clasps closely to the pipe and fastening the ends by means of a screw. At the top of the band is a small opening, around which make



FIG. 12.

a basin of clay, and into which the molten lead is poured. Irregularities in the diameter of the main cause gaps between it and the band, but these are quickly stopped with a little clay.

The molten lead must be skimmed and then poured into the "gate" without stopping until it is full, being sure that you have sufficient to fill socket before adding any, otherwise you will not have the lead-ring in one solid, continuous piece round the socket. The lead being allowed a few minutes to cool is now carefully "set up" with a caulking tool (blunt chisel) and hammer, making the joint complete.

Just tighten the two sockets D D (often neglected),

which may have been impaired by cutting and knocking the pipe. This ensures a perfect job all round.

The 4 in. socket must be closed with a wooden taper plug, adding clay around it to prevent any gas escaping, or it may be accomplished by a disc of wet millboard placed against the inner edge of the socket, and then a circular piece of iron plate pressed home by a clamp makes a good job.

The bladders may now be removed, care being taken not to tear them; then the bye-pass; finally tap and plug with threaded plugs the four holes. This leaves the 6 in. main as represented in Fig. 12, with full quantity of gas passing on.

When time permits, instead of allowing the gas to pass on, we would first connect one length of 4 in. pipe to the T, bladdering near the socket end of the pipe, besides adding the wooden plug. The object in employing the plug as well as the bag is to safeguard against escape of gas, should the latter give way. Now, if the work cannot be proceeded with on that day, due to leaving-off time, the 4 in. socket should be plugged with an *iron* plug and a lead joint made. This doubly ensures safety for the night.

Next day, the ground right up to the house, or, as the case may be, along the footpath of a street, must be got out deep enough to allow a covering of two feet of earth on the top of main when laid. Pipes of this size should be well under the surface of the ground—a great protection against trouble in winter.

The bottom of the trench should be levelled. This is quickly done and saves much trouble in packing up the pipe. The undisturbed earth being to all intents and purposes a firm bottom, very little practice will enable

the gas-fitter to know when the bottom is fairly level before using the levelling rod on the pipe. At intervals, equal to the length (9 ft.) of each pipe, extra soil must be removed to allow for the socket, so that the pipe and not the socket really rests on the ground. Also, when two lengths are to be laid at a time, extra soil must be removed from the sides of the trench to give room for making alternate joints in position. This is especially necessary when laying pipes in ground covered with asphalt, wood paving, or other expensive top covering, the cost per square yard being considerably more than for laying in ordinary gravel or flagged paths. The paths have to be reinstated and the ground maintained usually for six months.

We will now proceed to lay the 4 in. service. The pipe is first "bagged," and then the iron plug removed. This is easily accomplished. Next lay two pipes, if possible, at a time, and to do this connect them by means of tarred yarn and lead on the brow of the trench.

When the joint is made, three men stand across the trench, and by means of pieces of rope passed under the pipe—one at each end and one in the middle—they carefully lower the pipe into the trench, placing the spigot into the socket end of bagged pipe. This double length is levelled to the extent that the spirit level just indicates a slight inclination towards the 6 in. main. This done, the joint is made, always placing the wooden plug temporarily in the opposite end. Proceed in this manner until the whole service is laid.

The ground is filled in as we go along, except just over where the pipe is bagged. However, it is usual after having laid six or eight lengths to bag the last laid length, removing the former bag and plugging the hole

with a  $\frac{3}{4}$  in. iron plug. This enables one to make good the ground, as well as allowing such lamps and houses on the supply to have gas. In doing this, we are

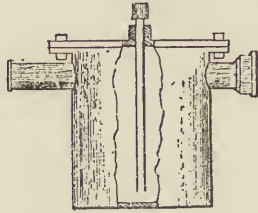

FIG. 13.

considering the laying of the pipe a long distance to the building or down a short street, for, in the latter case, if the pipe be a new or enlarged one, we will have to "pick up" all services both to lamps and houses as we go along. Then the advisability of bagging the pipe after laying several lengths is thus made clear.

In our progress towards the destined end, drains and water pipes often interfere with the levelling arrangements, and in such cases the service is laid over the drain, again dropping on the other side to the proper depth. This will necessitate the introduction of a drip-well, sometimes called a "syphon box," into the service, Fig. 13. By means of the small pipe in the box the condensable liquid is removed by a syphon pump. This pipe comes to nearly the surface of the ground, and a surface box with hinged cover is placed round it for protection against damage. The drip-well will answer for two inclinations towards it, so that since the 4 in. service first drained to the main it now inclines to the well. However, the well is not put in until we come either near to the end of the course or against another interruption, when the fall is back to

the well. The object is to avoid too many syphon boxes, which only entail expense and labour in looking after them.

We will suppose that the 4 in. cast iron service has been continued up to the house. The pipe is taken through the wall in the most convenient and well considered place, being in close proximity to the meter. By

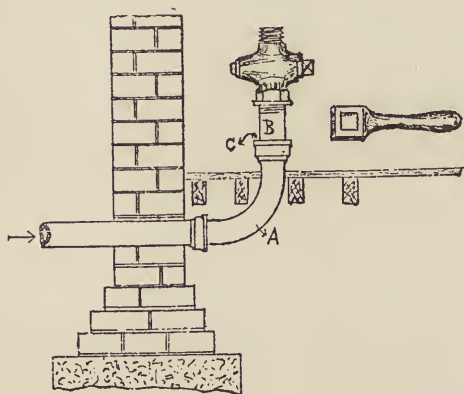

FIG. 14.

means of a bend, connect it to the socket coming through the wall looking upwards (Fig. 14, A). B is a short piece of threaded wrought iron pipe (sometimes galvanised) to which is screwed the main cock, then the piece is connected to the service by the lead joint, C, as shown complete. Of course, all supplies have their own requirements since some houses have no cellar or vault under the floor line, while others have; in that case the meter is fixed in it.

In some large buildings it is usual to have more than one meter, situated in different parts of them. This is also the case when occupied not by one but by many parties,

who may be on different landings. In all such cases this necessitates branching from the one main-supply in two or more directions, according to where the meters are to be placed. A reducing Y or T-piece is put on, say, the end of the 4 in. pipe outside or inside the structure, and then continued by means of wrought iron piping to the meters. On each end coming through the wall is attached a main cock. If, however, the branching is made up of 2 in. cast iron pipe, then one method of finishing is illustrated in Fig. 14.

Reverting to the street 4 in. supply requiring services from it, a useful and common vice drill, Fig. 15, is quickly

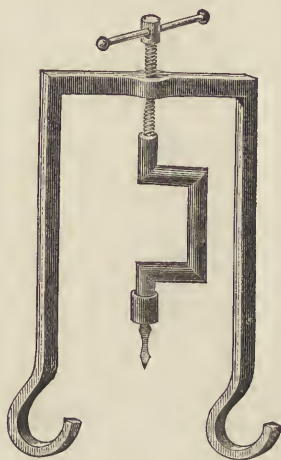

FIG. 15.

set up and  $\frac{3}{4}$  in. or 1 in. holes are soon drilled and tapped. No service either to a public lamp or house should be less than  $\frac{3}{4}$  of an inch in diameter. Nearly all the street lamps in London have now  $\frac{3}{4}$  in. barrel passing up the interior

of the column. This extra large service to supply perhaps only one light seems out of place, but when we consider that in winter they are subject to the severest weather, causing the gas to throw down condensable matter as water and naphthalene, which may get frozen and so render the supply of gas impossible, its size greatly reduces, if not altogether prevents, this evil. The lamp service is taken off the main by a bend and connector, then such length of tubing as is necessary to reach a little above the top of the column; this may have a slight "spring" or "set" in the lower end or an open bend screwed on, to which is connected another piece of tube to reach the connector. There is then a direct incline to the main. Where the main is high or near the

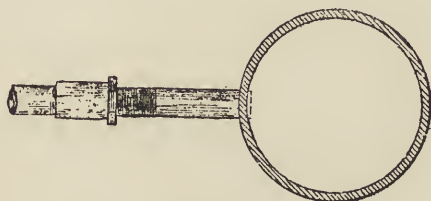

FIG. 16.

surface of the ground, bends in the main cannot be used if a fall is desired (which should be the case) from the lamp or house; only elbows, preferably round ones. But even this method of connection is bad, since the elbow reduces available pressure which can be utilised by running the service direct from the side of the main by means of a connector, Fig. 16. This allows a good fall, and should the service require washing the liquid readily drains to the main. The fall given to many services, especially small ones, is far too little, probably due to the expense in removing a little more ground. The pipes having a good

inclination give much less trouble and are quicker cleared of deposit; besides, there is seldom the need to open the ground.

In making lead joints a few words of caution will not be out of place. Tarred yarn in frosty weather is rather hard to work with, and if warmed at the fire to render pliable it becomes stiff before it can be placed in the joint. Now, tarred yarn in such a state is somewhat brittle, and in caulking it into the joint it gets more or less cut through. To remedy this during wintry weather, an equal quantity of white yarn is twisted with it, the white yarn being unaffected by temperature or the caulking tool. To know that we have rammed the yarn equally in the space and at the same time far enough, a chalk mark is made across the caulking tool (Fig. 17), which answers for all joints and is easily altered when making larger or



FIG. 17.

smaller by changing the position of the mark. If the pipes are wet, a little tallow placed on the part around which the gate of clay is made prevents the spurting of the molten lead. After the lead is run in, the joint is first set up all round with an ordinary chisel to remove the surplus lead, then with three caulking tools—commencing with the thinnest and finishing with the thickest one, the latter being equal to the thickness of the lead—the joint is complete.

Particulars of cast iron gas or water pipes, with open



joints. Pipes  $1\frac{1}{2}$  in. to 8 in., proved at works at about 300 ft. water pressure, or 10 atmospheres:—

Size inside diameter.	Length exclusive of socket.	Thick ness of Pipe.	Length of socket inside.	Depth of lead, about.	Weight of lead $\frac{3}{8}$ in. thick in joint.
Inches.	Feet.	Inches.	Inches.	Inches.	Pounds.
$1\frac{1}{2}$	6	9-32	$2\frac{1}{2}$	$1\frac{3}{8}$	$1\frac{1}{4}$
2	6	9-32	3	$1\frac{1}{2}$	$1\frac{3}{4}$
$2\frac{1}{2}$	6 & 9	5-16	3	$1\frac{5}{8}$	$2\frac{1}{4}$
3	9	5-16	3	$1\frac{5}{8}$	$2\frac{1}{2}$
$3\frac{1}{2}$	9	5-16	4	$1\frac{3}{4}$	4
4	9	5-16	4	$1\frac{3}{4}$	4
$4\frac{1}{2}$	9	5-16	4	$1\frac{7}{8}$	$5\frac{1}{2}$
5	9	7-16	4	$1\frac{7}{8}$	$5\frac{3}{4}$
$5\frac{1}{2}$	9	7-16	4	2	$6\frac{1}{4}$
6	9	7-16	4	2	$6\frac{1}{2}$
7	9	7-16	4	2	7
8	9	$\frac{1}{2}$	4	$2\frac{1}{8}$	$8\frac{1}{2}$

When laying wrought iron services we have to consider the nature of the soil in which they are to be laid, much more so than when laying cast iron pipes. In giving an estimate of the probable lifetime of a pipe, the character of the soil must be known, for whilst all metal piping suffers deterioration more or less, the pipes of small diameter decay or become destroyed first. Cast iron, although principally used for mains, is certainly more durable than wrought iron, and in some districts lead services are scarcely acted upon by ordinary soil. The average lifetime of a wrought iron service, unprotected in any way, is a little over nine years, but if protected by some preservative material it will depend upon the latter's efficiency to battle against the action of the soil. The author has seen services taken up, after only one and a-half year's use, literally riddled with holes, while others which have been in the ground—but protected from the action of the soil—for over twenty years appeared bright and clean, similar to new pipes.

Argillaceous soil is recognised as possessing the least action upon cast iron pipes, and therefore the best ground in which to lay them, but although this is excellent material wrought iron is not so lasting in it, being more readily oxidised than the former. In made ground, pipe against pipe, and unprotected, the lead tube seems to last the longest.

The worst of all subsoils in which to lay pipes is that more or less intermixed with ashes, slag, vitrified cinders, clinkers or chemical refuse in the presence of moisture, and if not protected each specific soil though acting somewhat differently, plays havoc with iron. This is due to electrical energy, also, no doubt, aided by the ever constant vibrations of materials, thus producing a grinding action; but writers on the subject put it down to electrical agency, each of the numerous particles of carbon coming in contact with the iron, and aided by the water present, producing slow and positive decay. We find in many instances where pipes have been taken up, some portions of the tubing good, whilst other parts are very conspicuously marked just as if some hard substance had been rubbing its way into, and in many cases positively through, the metal. This is certainly one of the chief causes of leakage.

There are many methods of protecting services, which may be classed under two headings.

1st. Preserving pipes to be exposed to the atmosphere.

Soapstone is a good protection to iron, and when ground to a powder is one of the finest of substances, and nothing else will attach itself so quickly and firmly to the fibres of iron or steel. It makes a light covering, and when mixed with some colouring matter to form a

paint, will cover a larger surface than white lead or oxide of iron, and will not crumble off under the influence of the weather like other paints. This is especially useful in the vicinity of the sea where the saline atmosphere is very deleterious to exposed pipes.

Galvanising the surface of wrought iron pipes greatly augments durability, and is admirably suited for work which will be exposed to view, and if the light colour is an objection a coat of paint or tar will remedy this and still further protect them. This class of pipe is unsuited for burying in the ground, since the zinc is soon acted upon, but for lamp columns or walls they are admirably suited.

2nd. To preserve pipes to be placed in the ground.

The Barff-Bower process is one of coating wrought iron pipes with an oxide that will prevent corrosion, and is a preventative against either the soil or the atmosphere. This process has proved itself to be efficacious and is strongly recommended. It consists in heating the pipes at a temperature of about 1,200 degs. Fahr. in a closed chamber for about six hours. Atmospheric air in small quantities is allowed to enter, and the oxygen contained in the air is absorbed by the iron, the latter becoming coated with a black oxide, which is the preserving agent against corrosion and will require the influence of many years of exposure to show any effect.

Then we have Dr. Angus Smith's patent solution, which gives satisfaction in many quarters.

The following is by far the best method, although entailing a little extra trouble and cost. The pipes are laid in a long trough or "shooting," made of two pieces of 2 in. and one piece of 3 in.  $\times$   $\frac{5}{8}$  in. rough wooden boards nailed together, or only two pieces of wood nailed

together forming an angular trough. Here and there thin strips of wood are placed across the bottom or sides to prevent the pipes touching the entire length of the trough which would prevent the service at those parts from being coated. Hot pitch is poured into the trough until the pipe is completely covered, Fig. 18. The durability of the pipe is now indefinitely increased, and although the wood may rot, the pitch will still adhere to the pipe to baffle *all corroding agencies* so detrimental particularly to wrought iron; and there can be no doubt

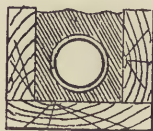

FIG. 18.

that if a good coat of pitch-tar (pitch thinned by tar) be applied to the mains their durability would also be increased very considerably. Tar and sand are sometimes mixed with the pitch, but the author prefers wholly pitch, for this reason, that if the pipes have been previously coated with tar and then pitched, the latter is hard to remove, so that it matters little whether the "shooting" perishes or the earth subsides, the pipe is not exposed. This method also prevents leakage from cracked tubes and bad joints, and taking this into consideration it will amply repay for the extra outlay incurred.

We will now consider the laying down of wrought iron services, which form by far the most common method, and although sizes of cast iron pipe below 3 in. have been given they are not universally employed nor are they to be recommended.

Up to the present we have advocated drilling holes

in pipes, and while this method has many advantages it requires much longer time to drill a hole than to cut one. Of the two methods, the cutting of the hole is mostly



FIG. 19.

practised, and if properly done is quite as good as drilling one. The only precaution is to cut the hole in the first place decidedly smaller than wanted, and a method which will serve for all sizes of wrought iron pipe will be described.

The main having been laid bare, chalk the pipe where the proposed hole has to be cut, then take a socket the same size as the service to be laid, stand it on the main, and with a scriber or knife—working inside the socket—scratch a circular mark equal to the internal diameter. Remove the socket, and we have a circle distinctly shown up by the chalk on the main, Fig. 19. Commence with the half-round chipping chisel to cut away the metal from the inside of circle, but *not quite up to it*, all round, then remove the centre portion, working in this way gradually downwards until through. Now take the rimer (Fig. 9), and with a T-key well rimer out the hole, for we have plenty of metal to work upon. When, as will readily be judged, this has been sufficiently done, remove the rimer and insert the tap (Fig. 10), which should just enter, work it round until a full and good

thread is cut in the hole. The dotted line represents the depth of thread. But to know just when it is the right size, trials by screwing the pipe in must be resorted to, unless a mark is made on the tap or using a rule and measuring how far the tap is in the hole. It is a good plan to mark the tap after making one or two trials through a bit of iron plate until a pipe will screw firmly in; the mark can be made with a file in the fluting of the tap. The object of this is to further facilitate the whole operation and to prevent unnecessary waste of gas, also to ensure a good joint. Remove the tap and screw tightly a capped bend into the hole, the threads having been previously painted with red lead.

If the work has been carefully done—which will not take many minutes to do—the pipe will be as secure as that in the drilled and tapped hole. The rimer

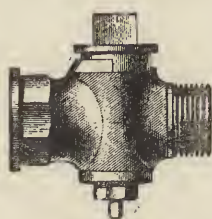

FIG. 20.

removes all traces of irregular or stripped metal around the hole, and the tapping operation is precisely the same as with holes that have been drilled.

To lessen the leakage of gas a little clay may be placed around the tools, but for the taps good hard tallow placed in the flutes answers well, at the same time aiding the tool to work easily.

Presuming that the pipe has been laid from the house it must be joined to the bend by means of a

connector and back-nut; but if not, connect up to the bend such lengths of tubings until the service reaches the house. A connector has generally to be put in at this juncture and united with the portion going through the wall. It will depend upon where the meter is situated as to how far the service will have to go in the building, sometimes only a few inches, at other times a few yards are required. Then screw a main cock, Fig. 20 or 21, on the end of service.

Care must be exercised to see that the "shooting" containing the pipe is properly packed up and having a good fall to the main or to the house, preferably the former, but circumstances will not always allow of this.

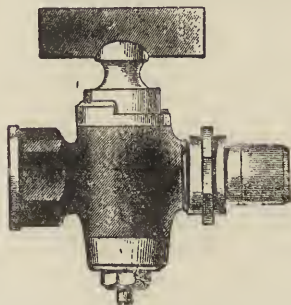

FIG. 21.

If the service falls to the house a bottle syphon is sometimes put in near the latter. All threads previous to screwing up should be painted with lead paint, and in the case of the back-nut a little hemp should be wound round the threads between it and the socket before tightening up.

At times the service cannot be laid back to the main, and in this case a plug is temporarily screwed into the socket of the tube to be laid, and if possible lay two lengths at a time.

The practice of running lead services for the supply of gas is dying out in many quarters, although strongly recommended by some authorities, but much depends upon the kind of soil and the care with which they are laid. They are liable to flatten if near the surface of the ground by overhead traffic, and are also easily bent. However, lead services are only used for conveying gas to all sizes of meters up to 30-light; beyond this size iron piping is employed. Lead services require great care in laying, in so far as to see that all dents or waves of a vertical character are taken out. These must be removed



FIG. 22.

and the pipe straightened by a piece of hard wood about 12 in. long, 2 in. wide, and 1 in. thick. This is grooved out on the 1 in. edge so that it will fit loosely upon, say, a 1 in. pipe. The opposite edge is rounded as shown in Fig. 22. This is a useful tool for dressing lead and composition pipe, the groove preserving the circular shape of the pipe.

Pipes having irregular curves left in, readily cause trouble by water condensing and partly logging the pipe, thus greatly reducing its diameter. They may be similarly protected like iron with pitch and troughing, or, if not, simply placed upon a strip of 3 in. by  $\frac{3}{4}$  in. wood, the latter being carefully bedded in the trench. This prevents sagging and thereby secures a regular inclination to the main if properly packed up.

The lead pipe is taken from the main by means of a wrought iron bend to which is screwed the cap and



lining bearing the lead pipe. The jointing of lead piping to be used for conveying gas is not generally the same as that made by plumbers for lead water pipes. Where it is possible to lay the lead service from the house to the main it is always desirable to do so, because then we have no trouble in making the joints with the gas on. Lead pipe is sold in coils of various lengths, the latter depending upon whether it is light or heavy tube. For underground work the heavy tube should be used. Unfasten one end, and with a tan-pin or other tool coned off, open out acutely the mouth of the tube in the shape of a funnel sufficiently large to admit the end of main

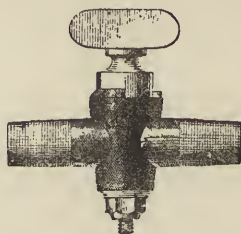

FIG. 23.

cock, Fig. 23. Clean the pipe inside by scraping with a knife, and the edges should be evenly pared off. The cock is now pressed into the end of the pipe, and care must be taken that it is straight and touching the interior of the pipe all round, otherwise the melted solder will run into the pipe. The gas-fitter must now fix the pipe in a vice or have it held firmly by his mate. A little resin or sweet oil is then added as a flux for lead jointing. By means of a blow-pipe and a stick of solder a joint is soon blown, which, if carefully done, far excels the copper-bit joint. A little practice will soon enable the gas-fitter to make a neat and perfect joint. It is the controlling of

the blow-pipe flame that requires attention, and if we cannot keep up a steady blast, the flame is intermittent and heat irregular, causing trouble in making the joint.

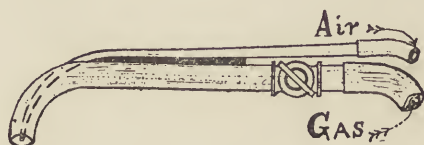

FIG. 24.

A simple and most useful blow-pipe is soon made with a piece of brass tube  $\frac{3}{8}$  in. in diameter, having an ordinary blow-pipe tapering tube inserted near the end; then solder or braze both together and fit with pieces of rubber tubing, and the blow-pipe is complete, as illustrated in Fig. 24. This will answer whether a gas or other flame be used.

Now uncoil the pipe towards the main, making sure that we have a sufficient length that will reach from the main cock inside the wall to the bend on the main before cutting it. The pipe being cut, "tan" the hole

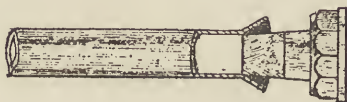

FIG. 25.

sufficiently large to take the cap and lining, Fig. 25. This joint is also made with the blow-pipe, and when completed drill and thread the hole in the main, screwing therein an iron bend to which the cap and lining is connected, previously remembering to place a leather

washer in the cap. When tightened up, the joint should be tried for soundness, after first allowing the air to be displaced by momentarily opening the cock.

Take the dressing tool and go along the pipe, removing all irregularities and packing up the board wherever there appears an opening under it. If no other preservative material is to be used then fill in the earth, taking care when pounding it not to work immediately over the pipe at first until it has a covering of a few inches of soil.

Gas-fitters are sometimes required to make a wiped joint, and should there be any difficulty in making one the writer recommends the tye-joint because it can be

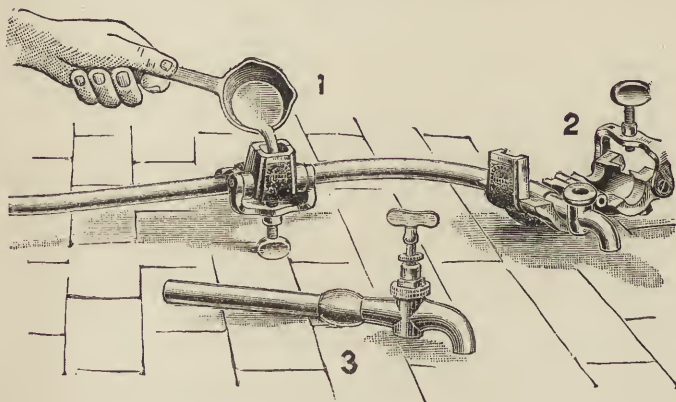

FIG. 26.

easily and effectually done by anyone, and it is quite as good as the wiped joint. The joint is perfectly regular and is capable of withstanding a pressure of from 600 lbs. to 800 lbs. to the square inch. Its great advantage lies in economy and saving of time, since old pipe lead (worth about 1d. or 2d. per lb.) can be used up for making the

joints—which is sometimes an advantage where the lead pipes are wanted for acids—instead of using solder costing 6d. per lb.

The tye mould will make joints in any position desired, either horizontally or vertically, as illustrated in Fig. 26. They can also be made at any angle in any upright position precisely the same. The ends of the pipes to be joined should be fitted into one another, principally to prevent any molten metal from entering the pipe, which, however little, induces the deposition of naphthalene, the first step towards stoppage.

In the illustration, 1 represents two pieces of pipe being joined together; 2, shows a cock being jointed to lead pipe; 3, the finished joint.

## CHAPTER V.

WET AND DRY METER FIXING.—METHODS OF CONNECT-  
ING DIFFERENT KINDS OF SERVICES WITH SMALL  
AND LARGE METERS.—PRECAUTIONS AGAINST  
DAMAGE TO METERS.

THE best position in which to fix a gas meter should be arrived at after a careful study of the requirements of the building, be it a dwelling-house or a place of business. This place should be decided upon ere laying the service down, and in so doing ascertain, if possible, the nature of the spot whether it is subjected to extremes of temperature. When fixing meters in basements this question ought always to be asked, since the answer given will determine the form of connections to employ.

Cellars are generally chosen not because the meter will be out of the way, but because the temperature of such places remains fairly constant throughout the year. The average cellar temperature may be taken as about 58 degrees with a variation of 5 degrees more or less. But instances occur when the fittings to the meters cause more trouble in summer than in winter, especially if the service falls to the meter. This is traceable to the fact that the meter is in such a position that the gas passing from the main is at a higher temperature than that of the service and the atmosphere surrounding the meter, consequently water is deposited in the inlet; or the meter is situated in a hot place supplying gas to fittings subject to other but

lower conditions of temperature, and water is again deposited in the fittings.

The gas-fitter should bear in mind, especially when fixing wet meters, that gas at any particular temperature can always carry a definite amount of aqueous vapour, and that this quantity is rendered variable by conditions of temperature. In winter there may not be the maximum amount of moisture in one cubic foot of gas, while in summer it carries with it more water vapour. Remember, then, that the hotter the gas the greater is the quantity of water it will carry, and it does not require to be saturated with moisture to show that a given volume contains more water at 70 than at 50 degrees.

In the case of a wet meter placed in a hot situation, the gas passing out will be normally saturated with water, and as soon as it travels into pipes which are colder the gas at this lower temperature, requiring less water to saturate it, will give up the surplus moisture to be deposited in the pipes. If nothing be provided for the removal of the condensed water, jumping lights and finally stopped pipes are the result.

Select a position which will not be materially affected by frosty weather or the water will be liable to freeze. All exposed meters should be cased if only in a wooden box, but wet meters require the aid of sawdust or straw as well to ensure against freezing. A situation of moderate temperature should be selected in all cases, if possible, no matter whether for wet or dry meters.

One other consideration; conditions of convenience must not be lost sight of when choosing the position, and in houses where the rooms are on each side of the doorway then a central position is best, because the lights may be divided between two services from the outlet of meter.

This will not only facilitate operations, but smaller sized pipes and less of them can be used, which is economy of a twofold character. Very varied are the circumstances one has to contend with in the daily practice of meter fixing, for while some are placed in cellars on stools, others are in cupboards or on brackets fixed to the wall of the kitchen or in a recess in the wall near the door. Wherever the place is there should be ample room to make good sound connections and joints.

The cost of the service is generally borne by the gas company, but does not include the main cock and fittings to and from the meter. Many companies simply cap the end of the service inside the building, and leave the internal fittings to outside gas-fitters. The occupier or landlord may engage any gas-fitter to complete the work, except the job of fixing the meter, which, in most cases, is done by the gas company, but if not the work is afterwards inspected by their official.

The fixing of meters calls for great care, and the under-mentioned preliminaries should always be remembered.

Wherever the meter stands, be it on a floor or a stool, see also that two blocks of wood, 2 in. thick, are placed under it. When fixing 15-light meters, and above this size, it is very necessary, for in large cities the gas companies buy meters from at least half-a-dozen makers, each manufacture differing in size, so that the fittings require to be materially altered should the meter be removed for repair and replaced by one of another maker, which may stand higher. If higher, the blocks of wood can be removed, and thinner ones substituted if necessary. This prevents altering the connections, presuming that the unions are alike. The non-uniformity of meter unions causes no end of trouble, although one might say it benefits the gas-fitter, but when

it comes to repeatedly reset, say,  $1\frac{1}{4}$  in. to 2 in. lead connecting pipes, it is not an easy matter, for the tube gets hard and the work does not repay one for the arduous task of making it sightly. Besides, all this bending backwards and forwards only tends to injure the pipe. Never in any case force dissimilar couplings together, rather replace the odd unions by those supplied with the new meter.

Uniformity of meter unions is a thing to be desired, and the change may come sooner or later with the adoption of Whitworth's standard threads. The nose of the linings should be uniform in size, tapered and ground, so that with a little tallow in the boss a joint could be made readily without a leather washer. In the case of the smaller sizes of meters the unions should be made interchangeable to a small degree, so that a 3-light could be replaced by a 5-light meter, and a 10-light by a 15-light, or *vice versa*, without having to make new connections when the larger meter is wanted.

The following are recommended:—

Meters.	Threads, per inch.	Equivalent to Gas Tube.
1 and 2 light	14	$\frac{1}{2}$ in.
3 ,, 5 ,,	14	$\frac{3}{4}$ ,,
10 ,, 15 ,,	11	1 ,,
20 ,,	11	$1\frac{1}{4}$ ,,
30 ,,	11	$1\frac{3}{4}$ ,,
50 ,,	11	$1\frac{1}{2}$ ,,
60 ,,	11	$1\frac{3}{4}$ ,,
80 ,,	11	2 ,,
100 ,,	11	2 ,,

In connecting an iron service to any wet meter below 100-light size it is usual to employ lead piping. The work should be carried out as follows:—

Unscrew the cap from the service, but before quite off, paint the threads of the pipe with lead paint mixture; now



wholly remove cap and screw the main cock, Fig. 20 or 21, on. The meter must be placed in the position it has to occupy, which is about 18 in. from the cock. Thoroughly clean the main-cock union, which is best done by filing the lining, also tan-pin, and clean the end of the lead pipe, as previously described. Then insert firmly the union, and blow the joint by means of the blowpipe and rushes. These joints should be blown and not made with a copper-bit, nor the lead pipe inserted into the union; and it is always best to tin all fittings before putting them together, thereby ensuring good joints. The union is screwed on the cock and the pipe carefully bent with good round curves, allowing plenty of piping. The setting of the pipe should be carefully and not hurriedly done over the knee, making good bends which are free

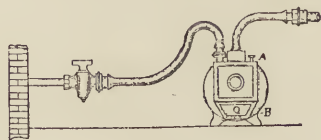

FIG. 27.

from sharpness and kinking, preserving at all times the true terete form. The desired shape obtained, mark off the length, allowing a little extra for making the joint with the inlet of meter, remove pipe, cut and join it to the meter union in the same way as before, then temporarily connect the pipe to the service and meter. If properly done it should fit in its place easily, without any strain. Now remove the outlet union and join it to another piece of pipe, the latter being set according to requirements, and then the proper length cut off. In connecting this pipe to the interior or house service, it may be soldered on the latter by opening out the end, but the

best way is to employ a union which screws direct on the service and the other half soldered into the lead piping. If a Carter's union valve is used it will take the place of the union.

The meter is now carefully levelled, and the bosses of the unions fitted with well-greased leather washers and tightly connected up, make the fixing of the meter complete; as in Fig. 27.

In connecting a meter to a lead service the greatest care is necessary, for in most cases the gas is usually on, and as the joints are made with a naked light there is a risk of igniting the gas.

The meter is set in position and the inlet union removed, cleaned and soldered to a piece of lead pipe. This is now bent to suit the supply-pipe, allowing for the insertion of the main cock, Fig. 23. The length being known, cut tanpin and clean the pipes, then solder on the tap. The service is now cut and tinned sufficiently large to take the other end of the tap. The tap bearing its union connection must be well pressed or ground into the end of supply pipe, the cock being shut. For convenience this pipe is bent up in order to facilitate the blowing of the joint, and the gas-fitter need be in no doubt about firing the gas if he has added tallow and resin, because the pressure put upon the cock in forcing it into the pipe generally suffices to ensure a temporarily tight joint. In making the joint use soft solder and concentrate the heat in order to prevent melting the lead pipe. Having blown the joint, the pipe is bent down again if necessary, taking care to see that the sweep of the pipe is regular. This done, the union may be tightened up. The outlet connection is the same as previously described in Fig. 27.

A third type of connection is one of using wrought-iron

piping which applies only to the large sizes of meters *i.e.*, above 100 light. Its actual shape varies according to requirements, but in any case is easily made up with bends, short-pieces and sockets. The union or flange connections require nice adjustment, and on account of the difficulty to get suitable short-pieces that will just connect up without putting a strain on the meter often gives a good deal of trouble. Do not trust to getting assistance from whatever "spring" the pipe connections will give, because such spring means strain put upon some part which is generally the weakest.

Unions make a good connection if they are threaded well, but often the metal is very thin and thus prevents a good, deep thread being cut. The union should be threaded inside, and where a poorly threaded union exists it must be sweated to the pipe as well in order to ensure a firm, tight joint. Should the union require threading, the taper tap is used at first, the former being held by a pair of tongs. This done, screw the bend or short-piece into it without any lead paint, since the latter will only prevent the tinning of the joint. The pipe and edge of union are then thoroughly cleaned with a file, and by means of borax as a flux, solder is freely blown or sweated into the joint. This makes a first-rate joint. The other joints, including the main cock, must be well painted ere screwing up, and every care should be taken to see that no strain is put upon the meter union when final connection is made. The outlet union and connecting parts are similarly dealt with.

Should the meter have flange connections special care must be taken when tightening up. Rather have the connecting piping a trifle too long than too short, for if not the bolts in tightening will only draw on the pipes. The packing material for flange joints is best made

of millboard, and on no account should three or four folds of brown paper be substituted. The millboard is placed between the flanges and cut to size, then by means of a small bit of round stick dipped into the paint mixture, mark off the bolt holes. Remove the millboard and punch holes through it, the same size as the bolts, at the markings on the board, which correspond with the holes in the flange. This done, it is soaked in water for some time, then a thin coat of paint applied all over it; replace between the flanges, see that the holes correspond, then tightly screw up with bolts. The various parts are all painted and connected up and if properly done there should be no chance of leakage. The mixed lead paint should be fairly thick as much depends upon its proper state or consistency in permanently stopping the possibility of leakage of gas. A joint made with thin paint appears sound at first but after a few days or weeks, allowing for the paint to set, leakage often occurs.

So far we have treated upon the general method of connecting up either a wet or dry meter when it is placed in a situation having a normal temperature and where the fall of the service is back to the main. But exceptional places, as referred to on pages 47-48, require special treatment, and those most often met with are where the service falls to the house or where the dry meter is in a cold situation.

Wet meters have only occasionally a syphon provided on the inlet connection, while all dry meters, in more or less doubtful positions, should be provided with syphoned connections. As previously mentioned under service laying, to halve the fall if the service be at all long, so the rule applies here. A meter which cannot occupy any position but below the line of supply should not have its inlet

connection burdened by all that might condense from the gas as it travels from the main to the meter, but should be relieved by causing as much as possible of the service to fall to the main, the other and shorter portion to fall to the meter. If this latter length be only a few feet no syphon need be provided, but in this instance it would be impossible to wash out the service without some of the liquid running back to the meter, and

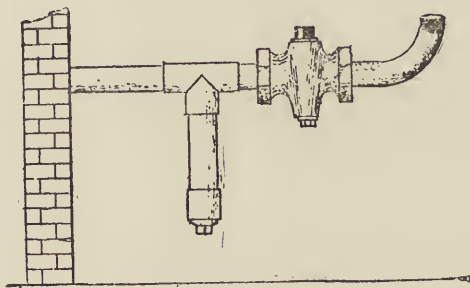

FIG. 28.

it is in cases like this that a syphon becomes of great use. It is generally advisable to syphon the outlet. Dry meters soon get out of order if water from the gas enters them.

Where the service is an iron one, the syphon is best put in on the inlet side of main cock by inserting an enlarging T-piece, Fig. 28. By having the syphon-pipe larger than the service-pipe proper, enables the use of a shorter length having a much greater capacity. A short piece of pipe is screwed in the tee, having previously tightly screwed a socket fitted with a good plug on the other end. No tap or thumb-screw should be used for this purpose, and the gas vendors usually attach a label giving notice to the consumer that the removal of this plug renders them liable to a penalty. The connection is made from the cock by a

bend or straight-piece, as is convenient, to the union or flange of the meter.

Should the service be a leaden one the syphon, made of the same material, is then put between the cock and the meter, care being taken to blow a good joint.

Another provision the gas company may allow is a bye-pass connection between the inlet and outlet of large meters. In many large public buildings where the basement rooms are dark, gas is always wanted in the daytime and to remove the meter say, to test it, would occupy a few hours to do. Meters like 150-light size are cumbersome and to remove one only to be immediately replaced by another would necessitate the gas being turned off for some little time. It is in such cases that the bye-pass is of use, and the quantity of gas consumed in one hour is noted; then if the meter be shut off for two hours the quantity is estimated as being double that found to pass during the one hour, and the index booked accordingly by deducting the amount consumed from the indicated index. For instance, if the index be 15,120 cubic feet and the estimated quantity consumed, while no meter was used, be 4,000, then in the book would be entered 11,120.

The inlet, outlet and bye-pass are provided with cocks, the one on the bye-pass having a fixed key attached. When the cock is shut off the handle of the key is in a line with the connection, and on this connection is fixed a clasp to receive the handle of the key, the clasp being provided with a lock and key. The inspector has the custody of the key. The other cocks are opened before shutting the bye-pass, and the bye-pass must be opened ere shutting off the meter, otherwise the gas will be extinguished.

Meters that have been disconnected must be guarded

against lights; the inlet and outlet should be stopped up with rag or corks. In moving meters about, whether wet or dry, every care should be taken not to drop them suddenly as much damage may be done. Especially must care be taken of a meter that is disconnected for the purpose of verification by the controlling authority, and if a wet one not to spill any water out of it. Large meters are generally tested in position by an official who takes a standard meter about with him, the gas-fitter connecting the two together as required.

The gas-fitter fills a wet meter with water by pouring it in at A until it runs out at B, Fig. 27. As soon as the water ceases to run out at B replace the plugs and the meter is ready for use.

The following table gives dimensions and other data of dry gas meters up to 100-light. For wet meters see page 5. Prepayment meters stand a little higher and some makes are wider, due to the cash box, but the fittings are the same as for ordinary meters:—

Sizes.	Depth, back to front.	Height, including unions. Inches.	Width, including unions. Inches.	Bore of inlet and outlet. Inches.	Feet per revolution.	Feet per hour.
2	$7\frac{7}{8}$	16	$12\frac{3}{4}$	$\frac{1}{2}$	0'08	12
3	$8\frac{1}{2}$	$16\frac{3}{4}$	$14\frac{1}{4}$	$\frac{3}{8}$	0'125	18
5	10	$18\frac{1}{2}$	$16\frac{1}{4}$	$\frac{3}{8}$	0'160	30
10	$11\frac{1}{2}$	$21\frac{1}{4}$	$18\frac{1}{2}$	1	0'300	60
20	$13\frac{3}{4}$	$26\frac{1}{2}$	$22\frac{1}{2}$	$1\frac{1}{4}$	0'500	120
30	$16\frac{3}{4}$	$29\frac{1}{2}$	$25\frac{1}{2}$	$1\frac{3}{8}$	0'830	180
50	21	36	$30\frac{3}{4}$	$1\frac{1}{2}$	1'428	300
60	21	36	$30\frac{3}{4}$	$1\frac{3}{4}$	1'600	360
80	$26\frac{1}{2}$	44	$40\frac{1}{2}$	2	2'500	480
100	$26\frac{1}{2}$	44	$40\frac{1}{2}$	2	2'857	600

## CHAPTER VI.

## GAS SUPPLY FOR DWELLING HOUSES.

THE best and most convenient time to fix up any building with gas pipes is before the walls and ceilings are plastered, not that it cannot be equally well done if the house be in a complete or finished state, but there is nothing to interfere with the running of the pipes and no cutting away of walls and floor boards to be done. Such a house is said to be in a "skeleton" condition.

With all inside work very much depends upon the price to be paid and the desires or wishes of the occupant or owner. A low estimate means cheap materials and hurried work even from the best workmen. The best work consists of using iron piping of the proper size, put together with consideration and care, and in the case of running a finished house, the prevention of excessive damage to the walls and other parts that have to be cut through.

Whether the building be large or small, the size of the tube used in the various parts should be well proportioned. The main object should always be to provide piping rather too large than too small in order that it will supply the burners with gas at low pressure, *i.e.*, seven-tenths of an inch for lighting purposes, and ten-tenths for stoves, but this is sometimes difficult to do without a valve since the gas entering the building is at one particular pressure in the day and another in the evening. Very few small houses have provision made for cooking stoves, and where in many cases they are fixed,



it will be found that the supply-pipe is a branch or continuation of the lighting service, consequently, when both stove and lights are going, there is cause for dissatisfaction, since both may have too little gas, or there is a constant increase or decrease of light according to whether the stove is turned on or off. Stoves should have a separate supply-pipe from the outlet of meter. In fitting up this class of house with prepayment meter and other fittings, provision should be made by inserting a

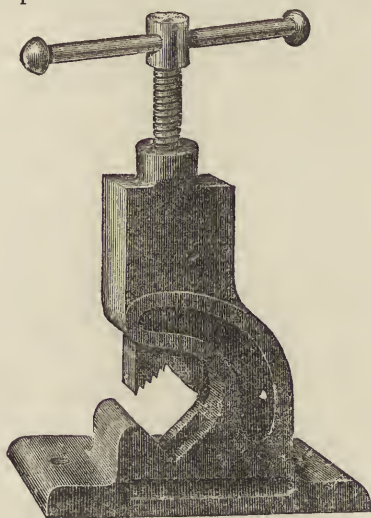

FIG. 29.

tee properly plugged. Then, if a stove be required at some future time the supply can be run without cutting the service. In fact, this provision should always be included in the contract and the stove supply should not be less than  $\frac{1}{2}$  in. iron pipe, and provided with a cock controlling the gas supply.

On account of the many different kinds of houses one has to fit up no certain method or rule can be laid

down, each place requiring distinct arrangement. This presents a difficulty in not always being able to get just the required length or shape of iron piping without resource to cutting or bending of the same.

To enable the gas-fitter to execute the work properly and to prevent him going to and fro to the shop, he should

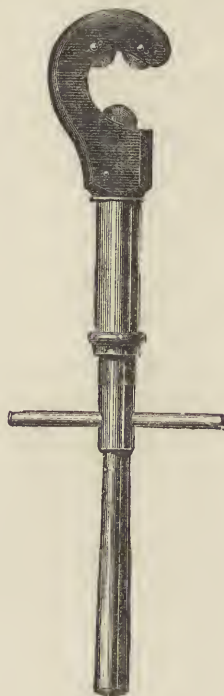

FIG. 30.

have a portable tube vice, similar to Fig. 29, which is of great service. This holds the tube firmly while being screwed or a piece cut off. Cutting iron tube with a file is a long job, and it is not so well or so easily done as with some form of wheel pipe cutter. The three-wheel form,

Fig. 30, is best, especially for heavy work and can be had in three sizes, to cut  $\frac{1}{4}$  in. to 1 in. ; 1 in. to 2 in. ; and 2 in. to 3 in. pipe. The cutting wheels, Fig. 31, are made of steel, and when blunt or damaged can easily be replaced, making the cutter as good as new. In all cases of cutting a pipe, remove with a half-round file any burr formed on the inner edge of pipe, before connecting up.

Having treated to a certain extent upon a few of the necessary preliminaries we proceed to fit up the house.

Many landlords will not pay for iron piping, principally because of damaging the walls, consequently the work has

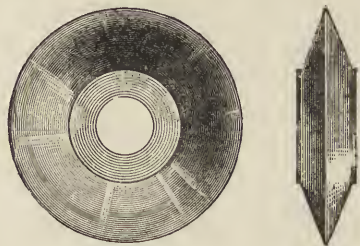

FIG. 31.

to be done with composition pipe, which is far inferior and cheaper. This is used entirely from outlet of meter, but no soft piping should be buried in plaster, where it may eventually get damaged by nails. In Scotland this method is much practised. Iron piping is the best material to use, and in the end gives the greatest satisfaction.

In fitting up a six-roomed house in a finished condition with two gasaliers, pendant, and brackets for the bedrooms, the meter may be fixed under the staircase. The outlet of meter should be directed upwards running it along between the ceiling and the floor of the upper rooms. First pass a long gimlet through the centre pieces in both the front and back rooms until it can be seen

through the boards in the rooms above. Mark the places with chalk. In the case of the kitchen, ascertain the direction the joists run in the room above from the way the floor boards are nailed, and if the table be in the centre of the kitchen endeavour to arrive at a point immediately over the table. But if the latter be at the side of the window, the centre of ceiling may not suit and the proper position must be decided upon from a knowledge of the surroundings. A swing bracket is sometimes fixed on the mantel-shelf, but a pendant is best for the kitchen. Having decided upon the position, next mark where the brackets are to be fixed in the bedroom. The front room bracket should be between the windows; if two brackets are to be fixed, one on each side of the principal window. The middle and back room brackets, on account of the position of window, is best on the window side of chimney breast. All brackets should be at least  $5\frac{1}{2}$  ft. above the floor. Next, well plug the walls with wedges to which the bracket pattress blocks must be securely fastened.

Two copper nose-pieces—screwed to fit the gasalier or pendant, the other end being tinned—must be soldered into the compo pipe to supply the gasaliers, then a length of  $\frac{1}{4}$  in. pipe continued for the bracket in the front bedroom. The back rooms are supplied with  $\frac{1}{4}$  in. tube. The kitchen and bedroom above are supplied by taking a branch from the outlet of meter opposite the most convenient course.

The gasaliers and pendant are secured by means of a piece of 3 in.  $\times$  2 in. wood cut just long enough to fit between the joists. In the case of light pendants the wood is simply nailed to the joists, but for heavy pendants, to be more secure, two strips of wood are first nailed

to the sides of joists, then the bridge wood rests firmly upon these side supports. A hole must be bored in it corresponding with the hole in the ceiling. The nose-piece is so bent that the screwed end of it passes through the bridge wood sufficiently to allow the pendant being screwed on.

All compo joints are made with the blowpipe, and every care should be taken to see that the pipe is laid straight and falling to the meter. To support the pipe, strips of wood are nailed to the joists when the pipe runs in the direction of the latter, but when across the joists, the wood may be dispensed with if care is taken to remove all irregularities out of the pipe by means of a tool similar to Fig. 22. If hooks are used to support or hold the pipe see that the latter is not dented by driving them too far in. In cutting the grooves out of the joists a chalk line should be used in order that the run may be straight, and only cut them deep enough to allow the pipe to pass clear under the floor boards when nailed down, see rule 8, page 4. This applies to all notching and cutting of wood to permit pipes to pass. The boards covering the gasaliers and pendant are cut so that the inspection pieces rest midway on the joists, and they should be screwed and not nailed down.

Where T-joints have to be made in composition pipe, tee-unions with tinned ends may be employed in places where it is difficult to connect otherwise, but this means three soldered joints instead of one. In making a T-joint without the unions, one piece of pipe is soldered to another at right angles or any angle desired. To do this, cut the through-pipe lengthways with the point of a knife, equal to about half the diameter of the branch pipe to be connected, prise the slit open until the point of the turn pin will enter.

With this tool open out the pipe until the hole is of the required size and quite round. When making the hole see that the pipe is not pressed or dented in, but rather, if at all, out. The end of the branch-pipe is chamfered off to the same degree as will allow it to fit, but not pass in, the tapered hole in the through-pipe. Uniformly heat the joint with the blowpipe until the solder flows all round it, and special care must be taken when the through-pipe runs horizontally to see that the underside is properly soldered. This is readily done by placing a piece of mirrored glass below the pipe.

In joining two pieces of pipe of the same diameter without a union fitting, the ends are either obliquely cut off or one end slightly coned out, the other chamfered and let in. Both methods are good when neatly fitted and soldered with the blowpipe. The latter method, if well done, is the best joint for exposed positions, as on walls, there being scarcely any ridge round the pipe, and if clips are used to hold the pipe the joint is entirely out of sight. It is a good plan in some rooms to have the pipes exposed to view by running them on the face of the walls. There are advantages of this method in that leakage is easily detected and greater facility afforded in fitting the pipes together, but the latter have to be rendered sightly by paint or other suitable colouring matter. In making compo joints, see that the parts fit well together before blowing the joint or there will be risk of solder entering the pipe, which may stop it, and all branch-pipes must not be forced into their respective holes or the bore of the through-pipe will be impeded.

Other joints in composition pipe may be made, such as the elbow joint, which is a common one. This is formed by cutting the pipe obliquely, then opening it out with the

turnpin, and using some blunt tool similar to a plumber's bent bolt, or a file handle will do, to bring back that part of the pipe that has least to be bent. The other portion is "bossed" or worked round the end of the tool until the opening is at right angles to the bore of the tube. The end must be trimmed off, then a union or other fitting can be soldered in according to what is required. Many joints can be made with compo without the aid of fittings, if care be taken to see that they are neatly fitted and soundly soldered.

The use of  $\frac{1}{4}$  in. compo is only to supply gas for one light.

Having connected up all burners, look round and see that all irregularities in the pipes are removed, then the gas may be turned on at the meter and all burners lighted to ensure of the air being out of the pipes. This done, turn the gas off at the burners and note the index of the meter and the time. If all the joints have been carefully made there should be no perceptible leakage. Should the meter, however, indicate movement in fifteen minutes it may be due to the pendant or bracket cocks, the plugs of which may not have been properly ground in, and so letting by a little gas. Apply a light to each of the cocks, and if ever such a small blue peep of flame appears, even though it will not remain continuously alight, it may account for the amount indicated by the meter. These small flames represent far more gas than most people are aware of, which can be readily illustrated by allowing sufficient gas to burn to form the amount of flame in question. Say an argand burner is used, then if we have only a ring of blue flame burning it is equal to the consumption of one cubic foot of gas per hour. The plugs greased with tallow will temporarily remedy the leakage, but they should

be re-ground in with a little tallow and fine powder. All unions should be tried when leakage exists, for they often allow gas to escape when least expected. Do not strain them to make the joint sound, or the thread may be stripped and a worse result produced. It may be a faulty washer. The test being satisfactory, the boards may be laid down, unless inspection has to be made by the gas company's official.

In cases where the gas is not laid on the house, air must be pumped into the system of pipes. The best apparatus for this purpose is that by Harrison and Sheard. It is light and portable, and a few strokes of the pump suffices to put on several inches of pressure, which should be more than any likely gas pressure. A gauge indicates leakage.

By fitting up a house with iron piping the work is more expeditiously done, and certainly it is more readily straightened and levelled up as we proceed with the work. Having treated on the fitting together of iron tubes, we need only consider it in relation to house fitting. Iron tubes are often defective in their bore, and no pipes ought to be screwed together without first blowing or looking through them. The latter is easily done by placing a piece of white paper on the floor with one end of the pipe upon it, and by looking through the other end of the tube any contraction in the diameter or iron blisters on the interior surface can be seen. The blowing test only holds good when the pipes are stopped, or nearly so, but there might be quite sufficient restriction in the diameter to cause trouble in a short time, especially as the pipes oxidise. This is a very necessary precaution to take, and much trouble is prevented by making it a practice to see that all pipes are clear before using them. A case



came under the author's notice where an inch service had been laid, and when the gas was turned on very little gas was delivered. The force pump was used to no avail, and the service, which was a long one, had to be broken in several places before the cause was found, which resulted in the discovery of a length of pipe having only about a 3-16th inch bore for several inches. All the delay and extra cost, not to speak of the trouble, might have been saved by inspecting the pipes prior to connecting together.

In running iron piping in a finished house or when relaying the pipes in a house, it is not often convenient to take up more than one or two boards, and as the pipe lengths suitable for the work may be too long to get below the floor they must be cut and put under as is convenient, so we must ascertain the length of the run and the longest length of pipe that will enter the opening. Having obtained the various lengths, as will serve the purpose, they are then temporarily connected above the floor so that there may be no trouble in putting them finally together below the boards. See that the threads of the tubing and sockets agree and when screwed up there is not likely to be any unnecessary sagging due to lopsided threads, since the pipe can only be supported where the boards are up. The pipes are then disconnected and passed in order under the floor, there being room to connect them together again between the two or more boards, socket and barrel tongs being used. As the pieces are joined the piping is passed along and another piece screwed on, in this way making a good job without spoiling the floor.

In fitting up new houses the work is very much simplified, but see that all threads are well painted before screwing tightly up. This is more especially necessary if

the pipes are likely to lie idle long after the house is finished and, in any case, the pipes should be left capped after testing them. Houses carrying 20 or 30 lights should have independent supplies running from the outlet of meter, one to supply the ground-floor rooms and the other to supply the upstairs rooms. These will answer all ordinary needs. In the day-time, the gas in the upper rooms can be shut off, and the ground-floor at night. If the fittings are sound it is a much better practice to keep the gas turned on, especially when soft metal piping is used, as it will prevent rats gnawing holes in them. But as each householder has his own ideas on the subject it is best to provide the supplies with full-way cocks. Branch tee-fittings can be obtained suitable for a number of supplies, or the gas-fitter can make them up. For a double supply, an ordinary tee is fitted with nipples and elbows, the inlet of tee connecting straight to the outlet of meter. The elbows must be screwed up tight, and if not in a line, file a little off the elbow or tee-piece, as the case may be, until they screw up in a line.

The supply-pipe for gasaliers should be fixed in such a way that it can readily be unscrewed when the time comes for fixing the gasalier. This is necessary, for the same gas-fitter may not have the work of putting it up. Never put in a pipe as illustrated in Fig. 32. Here we see in a section of the floor that the drop-pipe has been set to suit the centre-piece. Such cases have come under notice, and the gas-fitter employed to fix the gasalier, not knowing anything about the way the pipe has been fixed, naturally puts his tongs on the pipe to remove it, perhaps to cut a piece off, or to thread it. The force he exerts to make it turn is of no avail, except damaging the centre-piece which he must make good at his own expense. A case like

this is not found out until the carpet and floor boards of the upper room are removed.

The tee should be immediately over the hole, as represented by the dotted lines, and if the service extends no further it is just as well to use a tee rather than an elbow, and a further short piece so that the latter may rest

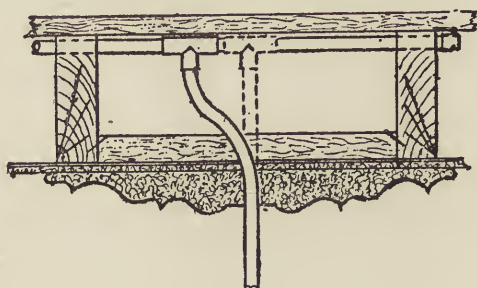

FIG. 32.

upon the next joist. The only other support necessary is a piece of wood about  $2\frac{1}{2}$  in.  $\times$  2 in. of such length that it will go between the joists. A hole the exact size of the pipe to be used must be bored through the wood and immediately over the centre-piece. The wood is now placed in position, resting upon the lath and plaster and nailed to the joists.

Then pass the drop pipe through the centre-piece and wood and finally screwing it into the tee. The  $\frac{1}{2}$  in. tee is quite strong enough to carry far more than the weight of an ordinary 3-light gasalier, and the block of wood prevents any side strain being put upon it. Another way of fixing the drop-pipe, but not so good, is to bend (when heated) a piece of pipe at right angles, the one end to take the gasalier and the other connected to the service on the other side of the joist. The wood must not be omitted with this way of suspending gasaliers. The drawback to this method is that the drop-pipe cannot be removed

without taking up the floor-boards, which although screwed, takes up needless time before the pipe can be got out. When, however, the pipe cannot be removed, cut as much of it away as will clear the centre-piece, yet leaving room to thread the end. When done connect the gasalier by using a ball and socket joint. It will be found that the ceiling plate is an inch or two away from the plaster, and to remedy this, measure the distance between the plate and the ceiling. If this be two inches cut a two inch piece of brass pipe of such size as will pass over the gasalier rod. Slip this long ferrule over the pipe, then the plate, and screw to ceiling.

The piece of tube will press the plate close up to the centre-piece, thus making the fixing of the gasalier sightly. Gasaliers should be fixed at least  $6\frac{1}{2}$  ft. to 7 ft. above the floor and quite 3 ft. from the ceiling.

Water-slide pendants often cause trouble by having defective inner tubes. They either leak or are too small in sectional area, the latter being the most common fault, especially in the two or three-light kinds. A two or three-light pendant should have a  $\frac{3}{16}$  in. to  $\frac{1}{4}$  in. diameter gasway, otherwise, if smaller, there will be an insufficient gas supply when the pressure of gas is below  $\frac{3}{4}$  in. By using large-sized pipes it does not necessarily mean waste; the principal object is to get volume of gas at low pressure, since it is futile to have them well proportioned unless the fittings are also properly constructed. Small pipes mean heavy pressure in order to get sufficient gas, which cannot be consumed with advantage. The use of small pipes is one of the chief causes of complaints about bad gas. It is not the gas nine cases out of ten that should be blamed, but the faulty system of using pipes far too small for the work required of them. To seal the telescopic tubes, it is

better to use glycerine, as this does not evaporate. Water may be used, but there should always be an ounce of glycerine or salad oil added to the tube, which will retard, if not entirely prevent, the evaporation of the water.

In cases where the lights jump it may be due to the inner tube leaking and so allowing water to pass into the arms of the pendant or gasalier. This is best remedied by fixing a new inner brass tube, care being taken to see that the seam of the pipe is good. There are other ways of making sliding fittings, which are also called telescopic, and which dispense with the water seal, chains and weights. With these dry pendants one tube passes within another and the joint slides in the form of a piston, which is made gas tight with a ring of well greased cork, or better, greased asbestos, pressed tightly in a kind of stuffing-box. These are principally used for single and double-pendant fittings. Some pendants are stiff, but all are fitted with ball joints and ceiling plates, unless otherwise wanted.

Many consumers dislike gasaliers in rooms where the ceilings are low, because of the likelihood of knocking one's head against them or the trouble in looking after them, and so prefer brackets in the principal apartments. Rooms not excessively large are effectively lighted from brackets, one fixed on each side of the chimney breast and one on the wall immediately opposite, care being taken to see that they are at least  $5\frac{1}{2}$  ft. above the floor. A height of 6 to  $6\frac{1}{2}$  ft. is preferable, but the distance from floor to ceiling must be considered. This method gives an illuminating effect which is good and pleasing to the eye.

There is another point which deserves attention, *i.e.*, the colour of the paper on the walls of the room. Light-coloured paper reflects a large amount of light back into the room, and this is a factor which must be considered

when estimating the quantity of light required for any room. Dark-coloured papers with the same amount of light upon them would not reflect much light, consequently the room would not be so bright and cheerful. To make such a room appear as bright as if light-coloured paper were used nearly double the light will be required. When fitting up the principal rooms of any better class house we should consider besides the colour of paper, the style of the furnishing and the purpose for which the room is to be used. The walls and ceiling play the greatest part in effectively lighting any apartment. The styles and forms of gasaliers, brackets and pendants are so numerous that to select them is entirely a matter of taste. With the advent of the incandescent gas a number of artistically designed pendants have been introduced to suit almost any purpose, and which are much to be preferred to the hydraulic gasalier. For bedrooms, passages, staircases and other offices, very little ornament is required, and in choosing the gas-fittings do not be misled by elaborate drawings or illustrations as they are often deceptive, making rough articles appear much better than they are in reality. It is better to see the fittings.

Besides good designs, the fittings are enhanced in beauty by being coloured. Brass fittings can be had in the following colours: "Polished brass," "steel bronzed and relieved," "Florentine bronzed and relieved," "green bronzed and relieved," "gold bronzed and relieved." Also "polished copper" and "steel-and copper."

We may consider briefly some of the methods of doing such work be it new or old. To clean old fittings, caustic soda or potash is mixed with water forming a "ley." The metal is put into this solution, which removes the old lacquer and grease. It is next dipped into a fairly strong

solution of nitric acid and water until all the metal is bright and clean, after which thoroughly wash with water under the tap to remove all the acid, then dry with sawdust. It must now be sufficiently heated over a bunsen flame in order to dry the lacquer, which is subsequently applied with a camel's hair brush. This way of cleaning brass gives it a somewhat frosted appearance, but when burnished work is desired, a burnishing chain or irons must be used. A lathe is also required for ornamental cylindrical and knob work.

To clean gasaliers, pendants, &c., the principal parts must be taken to pieces. Screw the arms out of the centre body, then remove the bottom knob, balance weights, pulley frame, outside and inside rod, taking note of the way the several parts are fitted together in order to facilitate connecting up again. Should the parts be very much discoloured immerse in a strong hot lye, consisting of a solution of two pounds of sodium or potassium carbonate in one gallon of water. Take the plugs out so as to be able to tell which top any particular one belongs to. When free from lacquer string the small parts together on copper wire and dip in aqua-fortis until clean, then quickly immerse in water, or, better still, under the running water tap. Repeat the operations until sufficiently clean. Finish by drying with beech sawdust. The larger parts are dipped separately. The smaller parts, such as screws, are placed in a wicker basket and dipped. Many parts, chiefly the prominent, require burnishing with a steel burnisher. Old beer or oxgall aids the process of burnishing, and the fittings should be held by wooden tongs. Sometimes it is beneficial to rinse the article in water containing a little cream of tartar, of such strength that it will be slightly tart to the taste. This helps to keep

the article clean during burnishing—which is very necessary—and if used, dry again in sawdust. Gently heat the parts, then lacquer, and allow to dry off on a hot plate. To fit together again use lead paint mixture on all threads, and beeswax on the plugs. The arms must be screwed up tight, then test for soundness by exhausting the air, and to find leaks use water under pressure. The old chains are usually replaced by new, as the former may be worn out.

Various bronze liquids, powders, lacquers and varnishes are procurable from most oil and colour salesmen, but the gas-fitter may make his own, although some of them entail trouble, especially when only a small quantity is wanted. They are, however, easily stored in well corked bottles.

A simple bronze solution is made with—

1 oz. ammonium chloride (sal-ammoniac).

$\frac{1}{2}$  oz. of sulphate of copper (blue stone).

1 pint of vinegar (white).

The two solids are first well ground up and then the vinegar added, which will dissolve them. This solution is painted on the article with any brush, and before quite dry black lead and polish with a brush. The better the article is polished the better the result after lacquering.

For antique work of any description a green bronze must be used. This is composed of—

1 pint of vinegar.

1 oz. crude acetate of copper (verdigris).

$\frac{1}{2}$  oz. ammonium chloride.

The whole is boiled for some time, and then filtered to remove any solid matter. If tolerably clear, decantation may be resorted to and the clear liquid diluted with water, the solution then being ready for use. If the whole of the article is to be green bronzed, it may be steeped in



the liquid until the desired shade of green is obtained ; but if only parts are wanted green bronzed, then the solution must be carefully applied by means of a small brush. As soon as the desired tint is obtained, the article must be well washed and dried, as before mentioned.

When using gold or bronze powders the articles must be coated with a size made by boiling, say, one pint of linseed oil with 5 oz. gum animi until it is as thick as cream.

Before use it must be diluted with turpentine. The article, being clean and dry, is painted with this size, avoiding any superfluous coating, and when nearly dry, the bronze powder is spread evenly over it by a soft brush or pad of chamois leather and allowed to dry thoroughly. Excess of powder is removed with a brush.

There are many good gold mixtures sold in liquid form, and which dry rapidly owing to the presence of methylated spirits.

All bronzed and burnished fittings should be lacquered to prevent them from rapidly tarnishing. It is, however, of very little use for work exposed to a very damp atmosphere, since all brasswork soon goes black in the presence of moisture.

The chief property required of any lacquer is that it should dry rapidly and hard. A good pale lacquer can be made with a pint of methylated spirits and 4 oz. or 5 oz. of shellac. They must be kept in a bottle, which should be frequently shaken for two days, and at the expiration of the time the mixture is filtered through blotting paper to remove dirt and undissolved shellac.

A better pale lacquer consists of—

1 pint methylated spirits.	$\frac{1}{8}$ oz. gamboge.
2 oz. pure white shellac.	$\frac{1}{4}$ oz. cape aloes.

Allow to stand, then filter if necessary. If crystal

lacquer is wanted, use only the methylated spirits and shellac, leaving out the last two ingredients. Coloured lacquers can be bought, but they are simply the same as the first recipe, but having had colouring matter added according to the tints or colours desired.

*For Light Gold Lacquer.*

No. 1 stock { 1 pint methylated spirits.  
 4 oz. shellac.  
 $\frac{1}{2}$  oz. tumeric powder or solution.  
 $\frac{1}{4}$  oz. arnotto.  
 $\frac{1}{4}$  oz. saffron.

*For Dark Gold Lacquer.*

No. 1 stock and  $\frac{1}{2}$  oz. tumeric powder.  
 $\frac{1}{2}$  oz. dragon's blood.

*For Red Lacquer.*

No. 1 stock and  $\frac{1}{2}$  oz. dragon's blood.  
 $\frac{1}{8}$  oz. gamboge.

*For Yellow Lacquer.*

No. 1 stock, diluted with  $\frac{1}{4}$  pint more spirits.  
 $\frac{1}{4}$  oz. cape aloes.  
 $\frac{1}{4}$  oz. gamboge.

*For Green Lacquer.*

No. 1 stock and  $\frac{1}{2}$  oz. tumeric powder.  
 $\frac{1}{2}$  drachm gamboge.

In making up either of these lacquers the exact quantity of any of the colouring ingredients need not be adhered to, since the colour may want strengthening or weakening according to the nature of the work to be lacquered. The recipes will hold good for all ordinary work that requires lacquering. In all cases filter the mixture in order to get a solution free from grit.

Having treated at some length upon the cleaning and doing up of gas-fittings, we shall now consider

front-door lights as are found outside large houses, and especially those occupied by doctors. When the light is placed over the door, gate, or on pillars, the supply should be taken off at some point conveniently near the meter, in order that the general house supply may be turned off at night. The lamp service should be taken up to above the floor line, near the door, and a cock put in and then carried up or down as is necessary towards the lamp outside. The lamp is provided also with a cock which is usually kept checked or regulated so that the cock inside the house door may be turned off or on without any chance of a larger flame burning one time than at another, and also doing away with the nightly regulation of the flame. The lamp cock may be done away with if a small governor burner be used. The light in the doctor's coloured lamp usually burns all night, and sometimes the same supply feeds the hall light for convenience at night time, when the door has to be answered. The hall light is checked at the burner.

When the service runs downwards outside before rising to the lamp a syphon must be let in at the lowest point. In some situations water soon condenses, and a ready means of letting it out is desirable. The nature of the place must guide one as to whether it is necessary to syphon the service.

It is conveniently done by inserting a tee-piece at the lowest point, then a 3 in. short piece of pipe provided with a cap on one end. Previously drill and tap a  $\frac{3}{8}$  in. hole in the cap and screw therein a  $\frac{3}{8}$  in. brass cock. This is easily turned on when water has to be removed. The service for one light may be  $\frac{1}{4}$  in. iron pipe, but for two lights, or when the gas has to be conveyed a long distance, it is better to use  $\frac{3}{8}$  in. or  $\frac{1}{2}$  in. size.

## CHAPTER VII.

## GAS FIRES.

BEFORE dwelling upon the actual fitting of supply pipes to gas-fires it will be well to consider a few of the principles involved in the manufacture of gas-fires, so as to be better able to understand the working of them, and where to look for failures should they occur. The gas-fitter should be in a position to explain the working of gas-fires and stoves to consumers of gas.

First, then, let us clearly understand what is meant by radiant and convected heat, for the terms are confusing and often misunderstood. These two kinds of heat can be obtained from gas-fires, and much of the future of a gas-fire depends upon the successful application of these methods of heating. Radiant heat is that heat transmitted from a fire to another body, yet does not affect the temperature of the intervening medium. That is to say, the heat emitted from a fire and coming in contact with persons, walls and furniture, imparts warmth to these objects, but the air through which the heat rays have passed is not materially altered in temperature. The air is comparatively cool by this method of heating, which is an advantage, since there will be more oxygen in a given volume of air, and the more beneficial will it be to the lungs, giving us more vitality. Heating by radiant heat causes the objects to be warmed, consequently there will be no absorption of heat from the persons staying in the room. The air will be moderately cool to inhale while the body is comfortably warm, this being much more healthful than having to

breathe hot air to secure the same degree of comfort, if such it can be. To obtain this radiant heat economically, the waste heat of the flue must be utilised to the utmost.

Convected heat or warm air. Here the intervening medium is heated, and not the walls and furniture. It is cheaper to produce convected heat than radiant heat by itself, but when the two systems are combined the heating of large rooms becomes a simple matter. For domestic use the combined heats are best, being cheaper and more satisfactory than either method alone. For offices, public rooms, and entrance halls, the hot air stoves alone give satisfaction, but for dwelling rooms they are not so satisfactory, on account of low temperatures pervading the floor and walls. When warming rooms these systems must be considered in order to get the best results. The chief objection to hot air as a means of warming a room lies in the fact that it is often very dry, and to get over this unpleasantness it should be passed over water or moistened in some way. In such stoves as the "Majestic," "Royal," and "Victor," a vapourising pan is fitted to the fender or to the top of the stove from which water vapour is delivered along with the pure warm air into the room.

Radiant heat, then, results in cool air, while the occupants of the room are warm. Convected heat warms the air, yet leaves the surrounding walls and floor cold, with the occupants of the room in a chilly state. Of recent years coal gas has come to be very generally used for warming and cooking purposes. As a fuel it has many advantages over coal. The chief of these are safety, cleanliness and economy. As regards safety, there is no fear of fire, as there is nothing to fly out of the grate into the room. Cleanliness: Dust always accompanies coal fires, a thing unknown to gas fires. The unpleasantness of

having a room covered with dust after lighting and cleaning a coal fire, not to speak of the constant attention it requires from the poker and coal scuttle, and the additional dust (and probably smoke) added to the room during the time the fire is burning, goes far in favour of gas-fires as the more cleanly. Of course, much may be said for the coal fire, but when trouble, cleanliness and perfection are considered it must take a second place. Economy: Gas as a fuel is decidedly economical, especially for heating water for baths or other purposes. Very great are the number of applications to which gas is and can be applied for heating purposes, where coal cannot be used, independent of economy. The advantages of gaseous fuel will come more and more to be recognised, both for heating purposes and as a motive power.

Much time and trouble have been bestowed in the manufacture of gas-fires in order to get them to a state of perfection, not only in designing the grates, but in perfecting the burners and flue tubes. There are now many good and elegant gas fires constructed to utilise all available heat from the combustion of the gas, so that a room may be warmed quickly and at the least possible cost.

There may be said to be four types of gas-fires in general use: these are reflector stoves, condensing stoves, asbestos or refractory incombustible fuel stoves, and radiating stoves.

In the reflector stove the gas is burned from ordinary flat or rat-tail flame illuminating burners, having a glass or polished metal reflector behind. For the quantity of gas consumed they do not give out much heat, and as many of them are fixed in places where no flues exist or have been provided, they considerably add to the vitiation of the air. They are nevertheless bright and cheerful to look at.

When, however, they are constructed with tubes, and working with a flue and fresh air inlet, they are much more satisfactory. The air for combustion and to be warmed should be taken from the room. The products of combustion in passing to the flue impart their heat to the upright tubes, through which currents of air are heated and pass from the lower to the higher parts of the room. The heating power of such stoves is very great, for large volumes of warm air are rapidly given out. At the same time the room is ventilated by extracting therefrom the air for combustion, and so keeping up a continuous change of air through the apartment. The superficial heating surface of this class of stove is about ten square feet. The reflector stove is the most efficient that can be used with a doubtful chimney draught.

Condensing stoves, as their name implies, are made to cool the products of combustion so that water vapour is produced and collected in a copper pan. This liquid is not by any means pure water, as there are other ingredients from the result of combustion absorbed and contained in it. The sulphur impurity is principally carried down by this water vapour, and although the condensed products are of an acid character and rapidly corrode the lower parts of the stove, they do not contain much of the carbonic acid gas formed. Quite three-fourths, if not all, of this harmful gas passes into the room. For this reason condensing stoves must be provided with an exit flue, and notwithstanding statements to the contrary, they do not overcome this serious objection of vitiating the atmosphere of the room. Another common complaint with this class of stove is that of filling with soot, which in reality is unburnt gas; also the unpleasant odour of garlic frequently given off from these stoves. When properly ventilated they are fairly

satisfactory, and find places in entrance halls, small greenhouses and rooms, under twelve feet square, often not provided with a grate and flue, but non-condensing stoves are to be preferred in the latter situation. Their heating powers are not good.

Fires made up with lump asbestos in ordinary grates, incandescent asbestos fibre, asbestos ball, coral ball and iron-fret fuel come under the heading of refractory fuel stoves. Stoves of this class are decidedly popular, and owe much to their cheerful glow which resembles the ordinary incandescent coal fire. The gas in these stoves is consumed on the Bunsen principle, thereby burning it to the best advantage. But it must be distinctly understood that fires such as those in ordinary grates are not and cannot be expected to be as economical as fires specially designed and manufactured for gaseous fuel. The heat thrown out by nearly all these stoves is radiant heat, but some have attachments to produce and give off heated currents of air. The latter stoves are good, but care must be seen that the flue to carry away the products of combustion is not too large, or it will also convey away much of the heat produced, and so make the fire an extravagant consumer of gas. If these stoves are used in front of the ordinary fire-grate the opening must be entirely closed with a sheet of iron, a hole being cut in the sheet iron to just admit of the nozzle of the stove. Where the fire fits into the recess of the fireplace the existing chimney draught must be restricted by partly closing the chimney, otherwise much of the heat escapes without doing any work. This not only ensures success for the fire, but in the case of sheet iron, gives it the finished appearance of being built in. Incandescent fires economise heat by having studded chambers, internal chambers, or



convoluted flues, so that the products of combustion yield up their heat to the internal material of the stove through which currents of air pass, and in transit gather the waste heat, conveying it into the room, which would otherwise escape by the flue if no provision were made to recover it.

Radiating stoves depend entirely upon a large superficial heating area, so arranged as to absorb all possible heat evolved by the combustion of the gas, and to give it off either wholly by radiation or by the extracting influence of the currents of air passing over or through the heated pipes. The Euthermic stove is a good example of a radiating stove. It not only has great heating powers, but is a ventilating agent on account of the air required to support combustion being drawn from the room itself, and so provides a continuous change of air in it. The heating

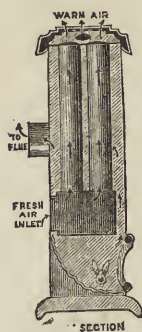

FIG. 33.

surface is a corrugated metal cylinder enclosing a kind of metal drum, having an inlet to it at the bottom and an outlet at the top, thus providing ingress and egress for air. The heated products of combustion pass between these casings, and the corrugated surfaces radiate the heat direct into the room, while the inner surface of the enclosed drum imparts heat to the current of air passing through it.

The products of combustion are discharged from the side near the top of the stove into the flue.

There are so many fire-stoves on the market that to describe or illustrate all would be little short of useless. It is, however, necessary to illustrate one or two of these four types of gas fires in order that there will be no misunderstanding them. Fig. 33 represents one form of tubular-reflector stove and one which is very powerful and efficient. The fresh air inlet may be connected to a pipe

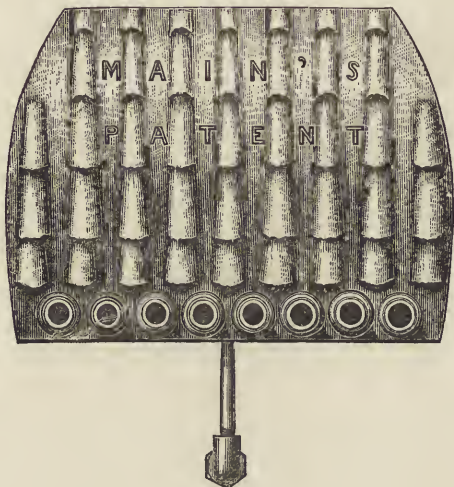

FIG. 34.

from the outside, but it is preferable to warm the air drawn from the interior of the room. This will in nowise vitiate the atmosphere of the room since the air supporting combustion, and the harmful gases arising therefrom, escape by the flue and so ensure a well ventilated room. The flue should be free from down-draughts and, with illuminating burners, such defect is readily observed by beating down the flames or rendering

them very unsteady. This should be remedied by fixing to the chimney or flue-pipe an extracting cowl and down-draught preventer, or Simmance's patent flue.

When fitting gas fires in ordinary coal grates, it is of the greatest importance to employ good burners. Many of the ordinary atmospheric burners are very wasteful and, even with the best of them, the consumption of gas is greater than would be used in a properly designed gas-fire to produce the same heating effect. But many consumers desire to retain their coal grates, and so, where strict economy is not essential, they may be fitted with advantage by either of the following burners.

The burner represented in Fig. 34, is an admirable one and can be purchased for straight and for curved



FIG. 35.

fire-bars. The fire-brick is attached to it and of special design to secure the greatest amount of radiant heat, and further, to add to the general appearance and brilliancy of the fire. It can easily be fitted into any grate without removing or breaking the existing back brick. Should the bars, however, be too close to admit the  $\frac{1}{2}$  in. supply-pipe,

mark carefully just where it should go through, and, by means of a drill or half-round file, a little metal can be removed from the bars. The burner nozzles are horizontal in order to eventually avoid clogging with fractured fuel, a common trouble with the vertical form

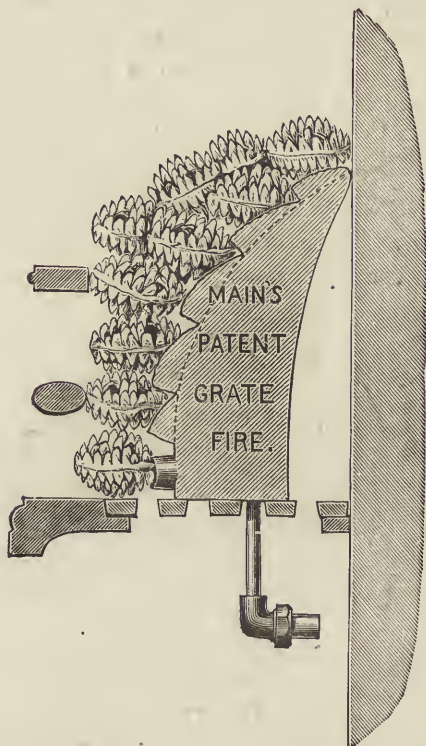

FIG. 36.

of burner. It is a superior burner and does not fire back when subjected to severe tests, consequently it is void of alarming anyone who lights it, and when burning is extremely silent. The most nervous are not disturbed

by a disagreeable hissing noise from the burner, especially when fitted to designed gas fires. Aim at keeping the flame, and thereby the heat, close to the front of the grate, so that the coral fuel (Fig. 35) is rendered incandescent. The flame will work backwards and through the cellular mass as it ascends and cause the whole of the fuel to glow brightly. Fig. 36 shows a sectional view of fire grate, and method of connecting supply-pipe.

The other form of burner for grates, Figs. 37 and 38, is rather different in shape, having vertical nozzles, and can

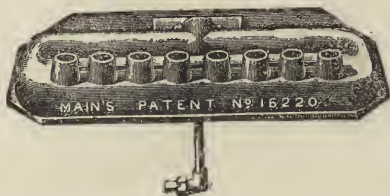

FIG. 37.

be used with or without special fire-brick. When used without special brick, ordinary solid fire-brick should occupy as much as possible of the back of the grate, leaving about a  $2\frac{1}{2}$  in. space between it and the front bars, at a level just above burner. The void is filled in with ball or coral fuel, stacking it so that it is higher at

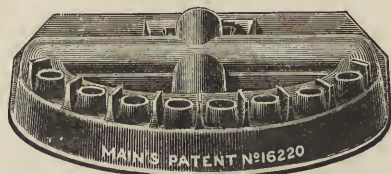

FIG. 38.

the back than at the front. This method is superior to filling the ordinary grate wholly with special fuel, which

latter costs more besides emitting less radiant heat into the room. A sectional view showing method of fixing burner into grates is represented in Fig. 39. These burners are made from  $9\frac{1}{2}$  in. to 14 in. wide, all having the same sized gas supply.

When ordering burners it will be necessary to give dimensions of the grates and to state the position of the gas supply (should one exist), whether on the right or

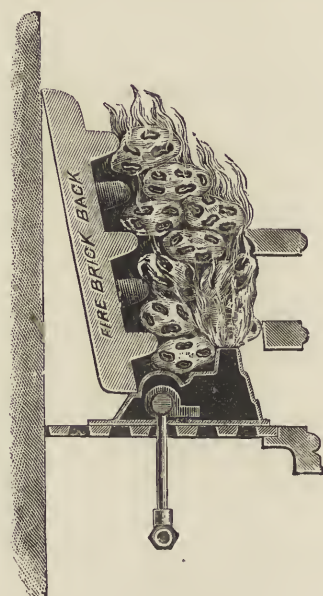

FIG. 39.

left of the grate. This is very necessary if a type of fire such as the "Charing Cross" is desired, for the burners are usually supplied with gas from a chamber common to all. The service is connected with one end of the gas chamber.

The great drawback to these burners lies in their

liability to fire back, but each burner is provided with a separate tap, an advantage when only a little heat is required. But this is achieved by the non-lighting-back burner in so far that the gas can be turned very low without risk of firing-back.

Ordinary grates are of three forms, each represented in Fig. 40. The several points of the grate should be noted on a paper plan or cutting of the inside of grate as from A to B; C to D; F to G, H or I; and the width from K to L. With these inside measurements accurately

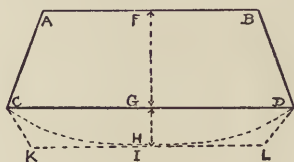

FIG. 40.

taken and marked on the paper templet there should be no difficulty in getting the most suitable burner to fit into the grate.

But with all the care bestowed upon such transformed grates there is never the same result in efficiency and economy as from a designed gas grate. The fire may, however, be rendered better by removing the ordinary coal-grate damper and cutting an oblong hole, 4 in.  $\times$  2 in., in the centre of it, then fixing the damper in its former closed position. With a good draught this will be an ample outlet for the products of combustion, but should it be somewhat inert, a hole 4 in. in diameter should do. These outlets will suffice for consumptions of gas from and under a  $\frac{5}{8}$  in. gas supply, the pressure of gas being 10 10ths of an inch.

There are occasions when a consumer would rather do away with his coal-grate altogether and have it replaced by a gas-grate, but until very recently this was only to be done by placing and fixing a gas-grate in front

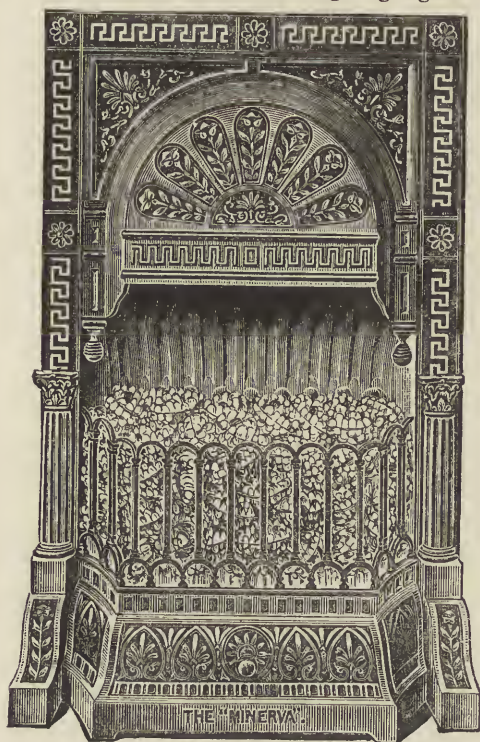

FIG. 41.

of the existing one. The result is often very unsatisfactory, since the designs seldom harmonize, and the front bars interfere with the fixing of the gas fires.

The want has been met by a very handsome art series of Interiors and Complete grates, having elaborate and artistic finish. This finish is not all outward show to



bedim, but to enhance the brilliancy of the fire. The gas fires are constructed to do the work of warming a room in a suitable manner for the comfort of life, with a view to the efficient and economical consumption of the gaseous fuel. Fig. 41 represents one of the series of Interiors for fixing into existing tiled panels of fireplaces, or they can be fitted with slabbed tile panels or other ornamental art metal work. The Complete grate includes the interior, with the addition of the moulding to suit existing mantelpieces. This moulding is of elegant design and made up of painted tiles in brass panels, or heavy brass moulding with ornamental fluted copper sides. The stoves of this class are fitted with a hot-air chamber, which is in one piece, so that the products of combustion cannot possibly escape into the room and thereby securing no vitiation of the air.

The following are two of the sizes made :—

GAS-FIRE INTERIORS.      OUTSIDE MEASUREMENTS.

Name of Fire.	High.	Wide.	Fire.	Clear bore of Supply Pipe.
The Minerva	33 in.	17½ in.—21½ in.	14 in.—18 in.	½ in.—⅝ in.
Griffin	33 in.	17½ in.—21½ in.	14 in.—18 in.	½ in.—⅝ in.

COMPLETE GAS-FIRE GRATES.

The Minerva	38 in.—42 in.	{ 38 in.—42 in. 32 in.—36 in.	14 in.—18 in.	½ in.—⅝ in.
Griffin	38 in.—42 in.	{ 32 in.—36 in. 38 in.—42 in.	14 in.—18 in.	½ in.—⅝ in.

With respect to the bore of the supply pipe, where there is a good pressure of gas the ½ in. pipe will be found sufficient, but if only a bare 10-10ths of an inch, then the ⅝ in. is recommended.

Foulis' patent regenerator gas fire is the last we must briefly describe. It is one of the most effective of the refractory-fuel stoves. The waste heat of the fire is conducted over and down the back of the brick and then up through flue tubes in the body of the stove and thence to the flue, heating in transit the brick at the back and the metal-work of the descending flues, thus utilizing the waste by improving the fire and imparting heat to the currents of air. It is a pattern of fire specially suitable for warming large dining and drawing-rooms having a floor area of from 500 to 600 square feet.

The warming of bedrooms is very necessary and desirable, but care must be taken to secure a stove free from the imperfection of giving off obnoxious and harmful gases, and the chimney should be one having the property of providing no down draught. Fibrous asbestos fires, and those represented by Fig. 33, are to be recommended. If the flue be very bad, condensing stoves may be used, but no stove is recommended by the author for use in a bedroom without direct connection with the outside air. Warm air is very necessary in many cases of disease, and should a moist atmosphere be needed it can readily be obtained by hanging a piece of wet blanket over a towel rail near the stove, one end of the blanket remaining in a basin of water on the floor. The steam kettle requires much attention, and is not so satisfactory in distributing the vapour about the room. The cost of heating rooms will be considered under the heading of ventilation, as it will again be necessary to refer to methods of heating. Heating and ventilation are such allied subjects.

Curb fenders and pedestal stands generally add to the appearance of gas fires. Some have inlaid tiles, while

others are of the open fret-work pattern. The adjustable stand, Fig. 42, is a decided improvement on the usually fixed sizes. It has the advantage of adaptation to various widths of fires. The adjustable arrangement is very simple, providing a ready means of altering the height from 3 in. up to 6 in., and the width from 10 in. to 27 in. This stand is therefore of great convenience.

The next thing to consider is the fixing of the gas-fires. In doing this be certain of the size of burner, as to its maximum consumption of gas, so that the proper size of

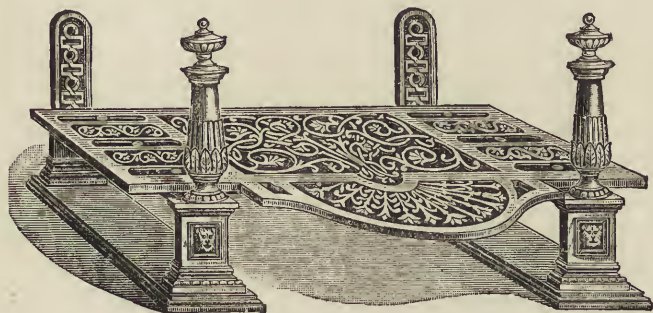

FIG. 42.

supply-pipe only is used. A gas-fire fitted with a too small service generally proves a failure unless the pressure of gas is good, in so far that a brilliant fire cannot be made. The service, as previously mentioned, should not be a branch of the service supplying the lights, but a separate one from the meter outlet, and according to the number of gas fires it has to supply, so must the size of the pipe be determined. The size of the bore of connecting pipe of burner will give a fair guide as to the separate branch-pipes, but it will not indicate the size of pipe that should leave the meter when

more than one fire is to be fitted and supplied. This is generally estimated by rule of thumb (a method of calculation will be given later on), in providing that the first of three fires should be supplied from a  $\frac{3}{4}$  in. service, then the rest of the supply reduced to  $\frac{5}{8}$  in. or  $\frac{1}{2}$  in. pipe, which is usually sufficient for the other two pipes, since the three fires are scarcely ever all going full bore at the same time. And besides the third fire may be on the floor above, and, if such is the case, the  $\frac{1}{2}$  in. pipe will do, since the elevation of ten feet increases the pressure one-tenth of an inch in the rising pipe. Cases have been under notice where two small fires have been supplied from only  $\frac{1}{2}$  in. pipe throughout, but as mentioned on pages 58 and 70, gas is more advantageously burnt when supplied in volume at low pressure. This, then, is only to be secured by using pipes having ample sectional area of bore.

When more than one fire is fixed the maintenance of a regular pressure is very necessary in order that the several fires shall be uniformly supplied. In practice it is found that any additional fire put on the same service reduces the pressure, and consequently this means less gas supplied to each individual fire. Governors are generally fixed to the supply, especially where the gas pressure is much too great, so that the latter may be adjusted to 1 in. But they must be fitted to every fire from a common supply, otherwise, if only one is fixed, the first fire may have sufficient, while the last on the service much too little gas. It will be found better to suit the sizes of the pipes by reducing them to the respective demands to be made upon them. The consumption or discharge of gas through a pipe varies directly as the square root of the pressure, or in other

words, should the pressure be increased four times the volume of gas discharged is doubled. It may be stated that the new burners, which are practically silent and do not light back, work with a less pressure of gas than some of the older forms. This is principally due to the better mixing of the gas with the air prior to combustion, and does not indicate that smaller pipes should be employed.

When extending the supply to suit the needs of a consumer, the gas-fitter must ascertain, by testing with a pressure gauge before leaving the house, whether there is a liberal pressure of gas to meet the requirements. The consumer may say it is good, but it will often be found that the meter is too small for the work it has to do, and is consequently absorbing undue pressure to drive it. This is a very important matter, as a larger meter may be required.

By means of an auger, bore a hole just equal to the outside diameter of the pipe to be used, on the right hand side near the hearth of the fireplace and 2 in. clear of the skirting board. The position of the joist must be known. The supply-pipe is now run from the meter to the fires which may be on the same floor. In passing the first fire a T-piece is inserted opposite to the hole in the floor, and the service continued on to the other fire. Short pieces are now added, so that the supply comes to just above the floor. When the connection is of iron, first screw a round elbow on a short piece of pipe of the required length, then pass it through the hole in the floor and screw to service below the latter. A gas tap having a full bore in the plug, and made with screw-union, is then connected to the elbow. Now take a piece of brass tube and carefully set it to suit the moulding or angles of the grate and the burner

connection. This done, cut the required length, and thread both ends with dies (Fig. 2). The whole is now readily connected up. Prior to final connection the piece of brass or copper pipe—the latter being more effective and cheerful in appearance—is burnished and lacquered, which adds much to the appearance of the connection. In fitting the pipe round the moulding by means of short pieces of tube and elbows, the work not only costs more, but never looks so well as a bent piece of pipe.

It is exceedingly important that the taps for fires should be put in a convenient position within easy reach of any person sitting near the fire, and they should always be fixed on the right-hand side of the fireplace. Many gas-fitters fix the tap under the floor, but this is an expensive mistake, inasmuch as it will not prevent servants turning the gas on or off, besides the inconvenience in getting at the tap where a trap exists. Children, however, may touch the tap, but they cannot turn it if tightened up. Bell pushes are fixed at a convenient height from the floor level, and gas taps regulating fires should equally be placed in easy reach on the side of the mantel. This simply means running the brass or other pipe up and down the wall and fixing the tap to an ornamental board. The first cost will be a little more, but there will be no forgetting to regulate the fire, and thereby save on the gas bills.

A very good tap for gas-fires is made by Richmond and Co., Limited, and protected by patent No. 21574. It is a tap provided with a bye-pass, so that the full quantity of gas may pass or only sufficient to maintain some heat. In turning the tap on it simultaneously turns the bye-pass tap, but in turning the principal tap off the bye-pass is left on, and so allows a little gas to pass. There

are other taps which work on the valve principle, which allows of easy regulation of the fire. They are made with a union attached.

## CHAPTER VIII.

## GAS FITTINGS FOR WORKSHOPS.

THE fitting up of workshops for the supply of gas cannot well be described in detail, for so much depends upon the nature of the work to be executed, the magnitude of the particular shop, and the amount of exposure the pipes are likely to be subject to, that the methods of fitting up such places therefore can only be given in a very general way. Some workshops are above, level, or below the ground line; this being so, each place requires special fittings as regards main supply and the number of branches therefrom. Then, again, the building may be entirely devoted to business purposes, either wholly as workshops, or part as showroom and office. Also, it may have only one floor, or it may embrace several flats or floors.

In every case, however, only iron pipe should be employed, except in rooms where light handicrafts are performed. In engineering shops the fitting materials should be strong and neatly put together, but not necessarily requiring good finish, so long as the joints are gas tight. The principal object always is to see that the available gas supply is a little more than adequate for the requirements of the shop. Small extensions may be required at some future time, and if the supply has in the first instance been really more than actually necessary, it will serve the additional lights, thereby effecting economy. To replace a larger supply is an expense, not to speak of annoyance, to the customer. Good work cannot be turned



out unless the mechanic is provided with sufficient light by which to see to do his work.

Presuming that the size of the service has been selected for a workshop where there are benches practically all round it, and having other machinery in the body or middle of the place, it will be necessary to run the supply around the shop, either near the ceiling or at such a height above and at the back of the bench as will suit the class of work to be carried on. It will be found a very great advantage in such a case, especially if there are many lights, to connect the service again, and so form a loop-service. This can be done by inserting a T-piece near the ceiling or other convenient place. The advantage to be gained over a service, which ends at a burner or is capped off, lies in having a regular and constant gas pressure throughout the service, for by means of the tee-piece the gas can flow most in the direction where the consumption is greatest, yet at the same time not affect the other portion of the supply. Another advantage, when the service is laid along the ground, and all the take offs looking up, it may get stopped up by deposited water, yet it will be found that very few if any of the lights will go out. In all workshops it is recommended to provide one bottle syphon where there is a fall given to the supply, so that all condensed liquid may be readily removed by a syphon pump or other means.

When running the pipe along near the ceiling, reducing tees must be let in from which to supply the brackets, generally one between each window, or one on each side of every window, so to speak; and where there are no windows such a number according to requirements. From these tees  $\frac{3}{8}$  in. or  $\frac{1}{2}$  in. iron pipes are carried down to the position for the brackets. The wooden pattress is not

generally employed when fixing brackets in workshops. It is better to use a wing-joint (known also as a wing-back), Fig. 43, for such places. This is screwed on to the upright or descending pipe before the latter is fastened to the wall. The bracket, after fixing the wing joint and pipe, is now



FIG. 43.

made up, and can be either single or double swing. If a single swing, simply screw a piece of iron pipe the requisite length into the swivel arm, then screw on the elbow cock to carry the burner, if not already fixed on the iron pipe before screwing the latter into swivel. When a double swing bracket is needed the fitting represented by Fig. 44 must also be used.

Wing-joints can be procured with cock attached, and it is sometimes convenient to use them, completing the

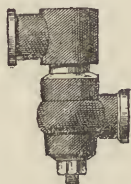

FIG. 44.

single swing bracket with a burner elbow. There are very many useful brass fittings made to take brass or iron pipe, either in the rough or finished state, and by using such necessary lengths of iron or brass pipe, according to the class of work in hand, brackets, pendants, and so forth

are cheaply and expeditiously made up. This is one way of using up many short pieces of  $\frac{1}{4}$  in. or  $\frac{1}{2}$  in. iron pipe which accumulate where there is much cutting up of such sized pipes.

As regards the fittings, brass cocks and swivels are not so apt to corrode and become fixed in the moving parts, and they wear much better than those of iron. Iron fittings soon stick if not in constant use. Finished fittings need never be employed in workshops unless specially desired, and as regards the circular form of backs for brackets they should only be used when a neater appearance and finish is necessary. The rough brass fittings are very strong and durable.

In providing the central bench, lathes, or other machinery with lights, the service is often best fixed to the ceiling or slung to the tie rods of the roof, but occasionally it may be found desirable to run the pipe (not less than  $\frac{1}{2}$  in. size) under the wooden floor, if such there be. When the lights are suspended from overhead, tee-pieces, reducing or otherwise, are let in opposite to where the lights

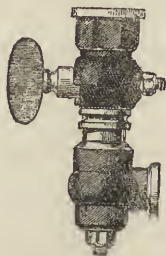

FIG. 45.

are required; into the tees connect an M and F swivel or an M and F cup and ball joint, which are extra strong. Then such necessary length of iron pipe to form the rod of the pendant, and when a swivel is used above, a single

swivel or swivel cock, as in Fig. 45, must be adopted at the bottom end if the arm of the pendant is wanted to rotate. The arm is fitted with a burner cock or burner elbow, according to which swivel is used at the bottom of pendant rod. With the cup and ball joint a straight threaded iron elbow, or tee, if for two lights, is screwed direct on to the pendant rod, the arm or arms fitted with the necessary type of burner cock. Whichever way the pendants are made they are obviously rough but very strong. For better appearance pendant bodies, more or less elaborate, are to be had suitable to form one to four-light pendants.

Many machines, as drilling, planing, and even lathes used for particular work require a bracket that can be moved in any direction, so that the mechanics may adjust the light in a position which will allow the best illumination

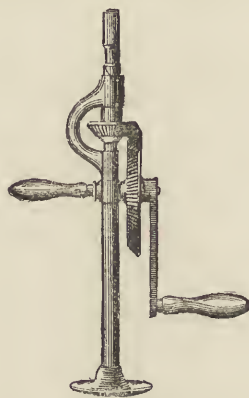

FIG. 46.

on the tool and material wrought upon. It is best to set the pipe to the curves or angles of the machine, fixing the pipe in position by means of clips and screws. The clips are either made out of strips of brass or iron of about

$\frac{1}{8}$  in. thick and  $\frac{3}{4}$  in. wide. These strips are now bent round a piece of pipe the same size as is going to be employed for the gas supply. They have one hole drilled through each arm, and if round-headed screws are to be used the holes need not be countersunk. Brass set screws are best for fixing clips to machinery. The holes that are drilled and tapped in the machine should be  $\frac{3}{16}$ th in. and not greater than  $\frac{1}{4}$  in. in diameter—the depth of the hole being governed by the length of the screws.

Fig. 46 represents a handy drill to take six drills, countersink and rimer. This is an indispensable tool when running service pipes in workshops and other places where clips have to be fastened to metal structures. This drill is specially light, and in use is found a quick hole borer and has the advantage over other forms of brace-drill, in that it can be used in many positions. The drill and

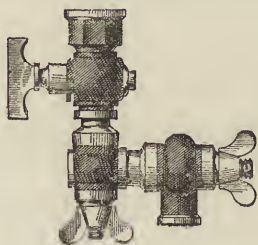

FIG. 47.

tap when used should be lubricated with soapy water in order to prevent them being softened by the heat generated, and to aid the cutting or threading of the metal.

To proceed with the fitting operations a swivel is screwed on the pipe and the bracket made up as previously described, except that instead of using the ordinary double or universal swivel, it is preferable to use a form of universal swivel having fly-nuts, Fig. 47

This is much better and cheaper than going to the expense of a parallel bracket; besides, the bracket when made up with this joint in the centre can be fixed in any position by the thumb and finger nuts, preventing entirely any gradual fall from it, as is more often the case with the ordinary swivel unless the latter is very stiff.

In drawing offices and such like places, where it is useful or necessary that the light should be in a constant position for a given period, the universal swivel with fly nuts need only to be added to the bracket to secure the desired effect. The brackets in drawing-offices are usually double or treble swing, carrying a shade or reflector, and this additional weight on the end of the arm tends to cause the latter to move out of the desired position. This can only conveniently be prevented by fixing this special swivel (not necessarily with a cock attached as illustrated) or having a parallel bracket, which is much more cumbersome.

In fitting up ground-floor workshops care should be taken to see that the service has a fall to the meter or to a syphon, and as free from sagging as possible by using hooks to fasten it to the wall at intervals of 6 ft. to 9 ft., depending upon the size of the pipe. These workshops are generally used for constructing heavy machinery therein; and if the service runs under the ground—there being no kind of flooring but the earth—and across places where traffic will be immediately above, see that the packing under the service is firm and not likely to yield more in one place than in another. In these places condensed water is sometimes a trouble to remove. For this reason, if for no other, the services are better run along the walls and under benches, thus avoiding the cooling effect of the ground. Tees or four-ways are put in the service where necessary.

When fitting up blacksmith's shops avoid fixing the forge light in the soil by wood or otherwise. This method is never satisfactory. The stand pipe gets in the way and the block is never sufficiently firm in the ground, necessitating, as it does, that the service must be more than a few inches under the surface of the soil. A much more effective method of lighting such shops is by six-light pendants, clusters, or ring pendants carrying six or eight burners. Of course, in the case of such machinery as steam hammers, a moveable light near to must be fixed, since overhead lights would probably cause shadows just where light is most required. The supply can be fixed to the stationary part of the machine, and in a convenient yet out of the way part of it, but allowing room for the full play of the swivel joints of the bracket.

In the modern shop the forges are usually arranged around the building, with power hammers in a central position for convenience. With the fires so arranged, the fittings are best suspended from the roof or from the tie rods; the lights being overhead as previously advised, and arranged down the middle of the passage-ways. They are fixed at intervals and should be eight or more feet from the floor.

The pendants should be strong but not necessarily elaborate for mechanical shops. The first two forms of pendants are more easily made up than the ring pendant, so we will describe how to make this last mentioned pendant.

There are two methods of making ring pendants cheaply out of ordinary wrought-iron piping, using not less than the  $\frac{1}{2}$  in. size. The better method will only be fully described. Before constructing, we require to know the extreme diameter from light to light, and if the burner jets

are not screwed directly into the ring but into short bent arms, then the diameter of ring will be the length of two arms less if the lights are to form a circle 30 inches in diameter. These short arms are screwed either into the top of the ring and curved over a little, or into the side and slightly curved up, in order to get the gas flames at an angle of 40 degrees above the horizontal. Flat flames should never be set in a horizontal position, since the atmospheric air, necessary for combustion, in flowing to the flame disturbs it and renders the light very unsteady. Allowing 3 in. for the length of the arm from burner to ring, neglecting the curve in same, we require a ring 24 in. in diameter. A piece of pipe 6ft. 4 in. long will be required. It is now carefully heated in a draw-furnace, or forge, and bent to a stiff wire templet, or chalk line, either by passing through a pipe-bending machine or gradually done by fixing one end in a vice and bending it bit by bit until of the required circle. The ends must now be welded together. Care is necessary when bending piping to avoid kinking or flattening the pipe, and it will be found advantageous to use grooved blocks, which greatly facilitate the work as well as preserve the circular form of the pipe. Good curves can be made by bending the pipe around small pieces of main pipe, but there is a risk of flattening unless the pipe is filled with sand or loam. Should it tend to flatten when sand is not used, it can generally be squeezed in the vice to the proper shape. When a large number of pipes are to be bent to the same shape it is a great saving of time and adds to the efficiency of the work to use iron templet curves, which should have a means of fixing the pipe at one point, while the pipe is quickly made to follow the grooved course in the pattern. Such a plan prevents kinking and flattening of the hot pipe.



and the executed bends harmonize to a great degree of accuracy.

Resuming the construction of the pendant, a cross-piece is now carefully fitted in the ring, having in the middle a straight threaded T-piece, which should form the true centre of the ring when connected. Into the tee tightly screw two short pieces of pipe so that the whole is a little longer than the inside diameter of the ring. Accurately divide the ring as it were into two halves by a line which should be marked on the ring with a centre punch. Now fix the ring in a vice, and with a triangular file make two holes on the inside of it, the same width of

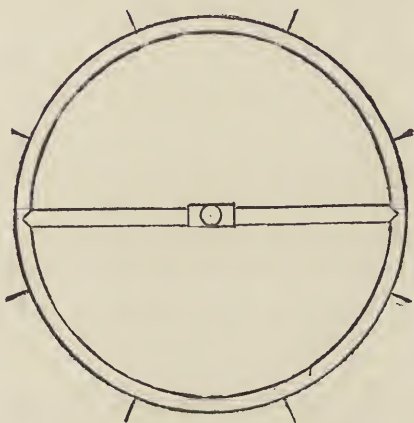

FIG. 48.

the pipe, but opposite the marks. The ends of the cross piece are filed off until they fit neatly into the holes in the ring, the tee pointing upwards, Fig. 48. This done, remove all grease and dirt round the holes and ends of the pipe with a file. The joints are easily brazed by using powdered borax and brass strip.

The ring is now heated, and is best accomplished by using a little coke and a gas blow-pipe. The purpose of the coke is to retain the heat and ensure the pipe being equally heated all round. Apply some borax and the brass strip, which will melt and flow round the joint readily when the required temperature is attained, keeping the heat up for a few minutes longer. Then turn the ring over to see that the underpart is properly brazed, if not, use a little more flux and brass strip. Both joints being finished, allow to cool, then clean off any surplus metal with a file.

The other method is not so effective in appearance, although occupying as much time to make up.

Two pieces of pipe, screwed at both ends, are bent to form a semi-circle. These are connected together, forming a ring by means of T-pieces, the latter facing each other when tightened up. The cross-piece is screwed into the tees, then the central T-piece made tight with a back nut.

The ring must be fitted with the short arms, curved as previously indicated, and if they are to be used the ring must be constructed of  $\frac{3}{4}$  in. piping. The required number of holes are drilled and tapped at regular intervals in the ring to suit  $\frac{1}{8}$  in. or  $\frac{1}{4}$  in. tube, denoted in the illustration by the lines radiating from the ring. The arm tubes must be tapped to take the burners. These tubes may be dispensed with if male brass knee burner sockets are screwed directly into the side of the ring. The pendant rod is fitted at the top with a cup and ball joint, and at the bottom with a socket cock, similar to that illustrated in Fig. 49, then a short piece into the tee of the ring, and the pendant is complete.

When the office is situated near the meter a reducing T-piece is let in the outlet of meter and the supply, fitted with a full way cock, run directly into the office. The

fittings for offices are much more elaborate, and are not usually made up by the general gas-fitter, who can procure them ready made up in a variety of patterns and at moderate prices. Where the office is distinct from the workshops it is advisable to have a separate meter.

As a rule, in large works the whole of the shops or rooms are lighted at the same time, and a governor must be fixed on the outlet of meter to regulate the pressure and quantity of gas to be consumed. But where strict economy is essential governor burners are also necessary, for by their use so close to the point of ignition, not only is gas saved, but what is burned emits more light per cubic foot of gas consumed.

The governors for placing on meter outlets are at least of three kinds, diaphragm, mercurial and glycerine.

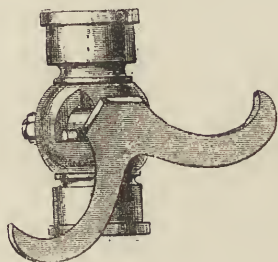

FIG. 49.

The principle employed in each is alike, *i.e.*, by the use of a float or bell so adjusted inside these apparatus to rise or fall according to the pressure on the inlet of same, the way to the outlet is partially closed or opened, thus securing to a large degree uniformity in the volume of gas delivered. By means of a screw and spring in the diaphragm type the valve can be set open to meet the demands when the pressure is high, and any lowering of the

initial pressure the valve automatically opens further and delivers the necessary volume of gas. To facilitate the adjusting of the governor the pressure gauge should be connected to the service.

In many workshops the old iron union jet or batswing burners are still largely used with no regard to economy, pressure, or efficient lighting. Burners should be used which consume under all ordinary fluctuations of pressure a constant quantity of gas, and these in the form of governor burners are now to be had at such very low prices that it is a wonder they are not more generally adopted in workshops. They are made in several sizes to meet almost all requirements.

Passing on to the fitting up of last mentioned type of workshop, *i.e.*, a building consisting of more than one floor and entirely devoted to business purposes, but having trades of a dissimilar kind carried on upon the separate floors, not necessarily by the same firm, requires special care in running the gas supplies. In nearly all such buildings there are difficulties to contend with which are purely incidental to a particular place. As space will not permit of a detailed narration of them we proceed to mention the more prominent features of fitting up a supply for a four-storey building.

For the purpose of an illustration let it be supposed that the aforesaid building is occupied by several firms, and that all require gas for the purpose of lighting or otherwise. In such a case the gas company would run the rising main up to the top floor inside the building, finishing off with, probably, a round elbow. Reducing T-pieces are put in the service at about 18 in. above each floor, and in continuing the rising main from the second floor it should be reduced in size for the next two floors, according to the

number of lights and fires to be supplied. This is very necessary in order to prevent the pressure on the higher floors affecting the lights on the lower ones.

To a great extent the reducing of the rising main with the T-pieces on the route remedies this reduction of pressure in the lower rooms, due to the difference in the elevation of the floors. But while this is essential as regards economy it is not absolutely satisfactory as regards regulating the pressure of gas, and for this reason a governor for regulating the volume or quantity of gas must also be fixed on each branch service in order to secure uniformity of pressure and an adequate gas supply on the several floors. In the early hours of the day the pressure in the mains may not be much more than 15-10th, while in the evening hours it may be 35-10th of an inch. This variation of pressure would alone seriously affect the lighting, and would prove unsatisfactory and wasteful, were the rising main not reduced en route upwards and governors fixed to the branch services. By these means the supply of gas to the burners can be regulated to a very considerable extent, and to get the most light from the gas consumed governor burners should also be used. Failing this class of burner, the adjustable Bray burner answers admirably, for by the adoption of a large top burner, no matter whether a union jet or a slit burner, the pressure is reduced at what is the damaging point to the illuminating power—technically called the point of ignition—so allowing the volume of gas passed by the bottom burner to issue freely at a slower rate. Of course, the bottom burner does not act quite as a governor, it simply allows a certain volume to pass dependent upon the amount of pressure in the service, but as the top burner affords a freer egress to the gas an augmentation of light

follows per cubic foot of gas consumed. Therefore, the efficiency of the top burner is variable, but it is always far more than could be obtained from the same consumption by the single burner under the fluctuations of pressure which do occur in any house. This is quite independent of the quality of the gas. It should be remembered that, to get efficient light cheaply, the essential conditions of pressure and volume must be studied. The one without the other is of no use.

To the tees in the rising main connect fullway main cocks, preferably with a bye-pass, as illustrated in Fig. 50, by means of a 3 in. or 4 in. piece of tube. These bye-pass

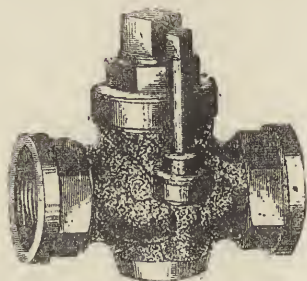

FIG. 50.

cocks are more convenient than the ordinary cock fitted with a  $\frac{3}{8}$  in. brass bye-pass, which takes much longer to fit together, although having the advantage of allowing more gas to pass. The latter is made up of brass tube fitted with a union tap, bent to form a "rider" past the cock. It may be fitted to the cock itself or to the pieces of pipe leading immediately into and out of it, see Fig. 52. When fitted to the cock the  $\frac{3}{8}$  in. holes must not interfere with the plug or threads of it. The principal use of the bye-pass is to supply sufficient gas for two or three lights either in the office or for a bench when the main supply is

shut off, to enable a little work to be carried on after business hours. The meter is now connected; then fix one of the forms of governors to the outlet pipe of the meter.

The same should be done on all floors, and so by this method the governors will remedy all fluctuations of pressure in the rising main. The gas company would take note of each meter index.

The workshop fittings will depend upon the nature of the trade carried on in each case. Such a building is sometimes supplied with gas from one meter which would



FIG. 51.

be on the bottom floor, but the method of supplying gas to the several firms from this meter is seldom if ever satisfactory. This is due, no doubt, to the difference in the quantity apportioned to each firm, which latter may or may not have burned so much gas as its neighbour. A separate meter to each firm is by far the best. It is a different thing when the whole building is occupied by one firm, and even then a separate meter to each department is useful when it is desired to know the exact expenses of any particular trade carried on.

In dealing with a factory only one large meter is sometimes used, and in this case the outlet of meter is fitted at some convenient place with a general distributor or branch tee-piece (Fig. 51), having the required number of outlets leading from it. This is sometimes called a "barrel," but the word is scarcely expressive enough as to

what is meant. When this special tee, as illustrated, is not readily procurable one can be made up as follows:—

The outlet of meter being, say 2 in. in size, and carried to the spot where the branching-tee is required to supply four leading sections of the building, a 2 in. T-piece is procured, into the outlets of which screw 2 in. nipples, and on these latter connect reducing T-pieces, 2 in.  $\times$  1½ in. centre, the centres forming the outlet for two of the supplies. Then screw other nipples—one into each

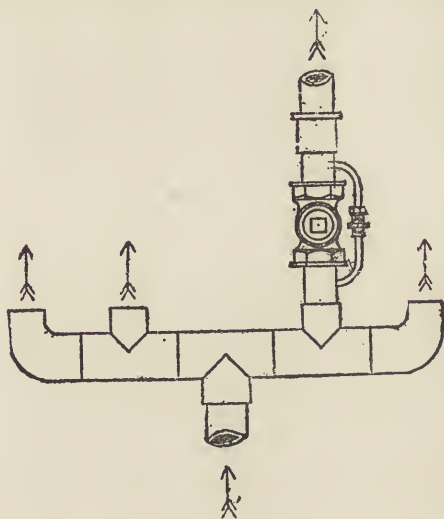

FIG. 52.

end of the tees, on to which screw round reducing elbows 2 in.  $\times$  1½ in. This done, there will then be one 2 in. inlet and four 1½ in. outlets. Any number of outlets can be formed by this method, but due regard must be paid to the size of the inlet as compared with the size of the outlets. Care should be taken to get straight-threaded tees, and to see that they are properly jointed by avoiding all unnecessary



hemp. A short piece of pipe is now screwed into each outlet, and to this connect a male and female or female cock, then, as the case may be, a short piece of pipe to which attach a connector. Lastly, the bye-pass connections are now fitted, the whole being represented by Fig. 52.

The special branch-tees can be obtained having any number up to twelve outlets, but it is a mistake to suppose that one inlet can adequately supply the last mentioned number.

The sizes run as under :—

Reference letter.	Run.	Outlet.
<i>a.</i>	1 in. or $1\frac{1}{4}$ in.	$\frac{3}{4}$ in.
<i>b.</i>	$1\frac{1}{2}$ in.	$\frac{3}{4}$ in.
<i>c.</i>	1 in. or $1\frac{1}{4}$ in.	1 in.
<i>d.</i>	$1\frac{1}{2}$ in.	1 in.
<i>e.</i>	2 in.	1 in.
<i>f.</i>	$2\frac{1}{2}$ in.	1 in.
<i>g.</i>	$1\frac{1}{4}$ in. or $1\frac{1}{2}$ in.	$1\frac{1}{4}$ in.
<i>h.</i>	2 in.	$1\frac{1}{4}$ in.
<i>i.</i>	2 in.	$1\frac{1}{2}$ in.

These tees are specially suitable for steam and hot water owing to the difficulty there is in getting the made-up tee sound at all the joints. The sizes *b*, *e*, and *f* are, however, sometimes useful.

## CHAPTER IX.

## PUBLIC STREET LIGHTING.

IN lighting the main thoroughfares and side roads of the cities and towns in the United Kingdom, many controlling authorities have much to learn if we are to take the system of lighting in France as a pattern to go by. It may not be altogether the system of lighting that should be considered at fault, so much as the existing illumination. Many of the central thoroughfares in our towns are badly lighted, and were it not for the shop-lights, some would have but a dismal and deserted appearance.

The question of the most satisfactory system of lighting important streets and centres of traffic is one regarding which there is considerable difference of opinion, since each parish has its own particular design of column as well as method of distribution. An exception to this may be stated, that in the event of a new thoroughfare being made by the London County Council and the same passing through various parishes, the column adopted would be that of the Council's pattern.

The gas-fitter may have little to do with the forms or designs of columns used by the authorities, but he should have a clear understanding as to what may be called a good or a bad style, as well as the failings and difficulties of fitting them up. Taste goes for a good deal in choosing lamp columns, and it is not expected that any particular column would recommend itself to everybody. Yet it is possible to have a pattern that is demonstrably good and

would command general satisfaction. Then again, the orders of architecture and varying localities have to be studied, which renders the task of adopting a really good standard suitable for all positions futile. Imposing buildings necessarily require special means of lighting, but any ornamentation of the lamp should not interfere with the illumination of the neighbourhood. One thing the ordinary lamp-columns might be of a design which could be much less offensive to the eye, because we have to bear in mind it is in the daytime that they appear more or less unsightly. They have really two objects to serve, first to have an ornate appearance by daylight, and secondly, to carry a lamp or lamps which should emit effectively the light from the flame. The houses opposite play their part by reflecting and diffusing the light according to the styles of architecture.

The columns, and especially the bracket columns, used in Paris are taller and more slender than those in general use in this country. Their appearance by day and the light emitted from the lanterns after dark are consequently regarded with much favour by many. The ordinary column, a type of which is shown in Fig. 53, is used for pavements which are  $7\frac{3}{4}$  ft. and upwards wide, the lantern being either round or square in cross section according to the finish of the column. The round pattern is mostly used on the more elaborate columns. It is also used in the Bloomsbury parish of London. These model columns are either bronze painted or coppered by the Oudry process. In Paris they are washed once a month, and those that are coppered, waxed and polished in a like period. The coppering is an expense but the effect is said to be worth it, of which we question, from the fact that the coppering is not of a permanent nature, nor is it in immediate contact with the iron, but upon a coating of

varnish and black-lead. Exposure to the weather greatly interferes with the general effect, not to speak of the destroying galvanic action, which is a great disadvantage to the method. The up-keeping for coppering costs something like 0'0049 franc per day.

The design of the lamp-post, however, is good, being

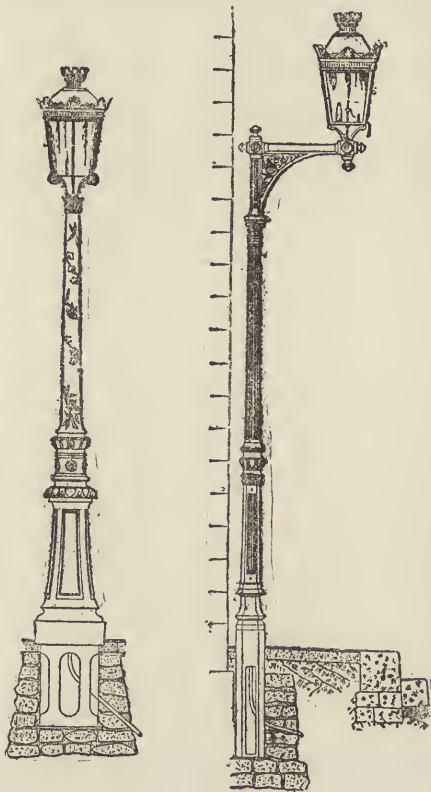

FIG. 53.

FIG. 54.

not too ornamental, while the whole thing is appropriate, strong, and suitable for the purpose.

Lamp-posts require to be strongly secured to the ground in order to stand against variations of rough usage and weather. They should have a general taper to the top, the base being distinguishable from the shaft, with no sudden constriction which at once spoils an otherwise good post. A good lamp on a good post is something to admire, because each part is properly proportioned, one to the other, thus giving an agreeable result. Sudden reductions in the diameter, as at the mouldings, are not effective; they simply become weaknesses for any runaway vehicle to complete the process of reduction—a too often occurrence with this form of post. This is a serious matter, especially when the column is manufactured in one piece, but when composed of shaft and base, the former led into the latter, or as in the case of those in the City of London, bolted together, it is cheaper to repair. The Corporation column base is also provided with a door to allow the fixing of a 1-light dry meter therein. These sectional columns are of what may be called the old pattern, which is no doubt the stronger, and certainly the cheaper of the two cited in the long run, for it is very seldom that a base gets broken when run against, although the shaft may require renewing, while the more modern pattern, if damaged, requires the erection of a complete new column.

To prevent as far as possible these mishaps, see that the columns are erected on the pavement or footpath at least 15 in. from the outside edge of the curbstone. This will prevent the column or lamp being knocked by any passing vehicle skidding the curb, especially in thoroughfares where omnibuses of, say, the "Star" type are plying for fares. The bodies of these 'buses project a good way beyond the wheels, and very often the upper portion of the 'bus strikes the lantern, smashing or otherwise damaging it.

In Paris, the street lamp columns are placed at a minimum distance of 0·55 mètre (1 ft. 9½ in.) from the outer edge of the curb of the pavement, and are fixed in a block of masonry 1 mètre square and 0·70 mètre high (3 ft. 3¼ in. full × 1 ft. 3½ in. full). In the Place de la Concorde and Champs Elysées the columns are fixed from 15 to 25 yards apart carrying single lamps each fitted with two burners. In the Place du Palais Royal the lamps are in clusters of from four to five each fitted with one burner, the whole being supported by one post. The burners employed are the Auer-Bec system of incandescent gas lighting, giving an efficiency of 16 candles per foot of gas consumed. A somewhat similar system is being experimentally tried in Wellington-street, Strand. The burner there used is the Denayrouze atmospheric burner, provided with a larger Welsbach mantle than the "C" size. This burner specially mixes the gas and air, not by the fan as originally produced, but by the careful arrangement of the air apertures and the somewhat conical mixing chamber of the burner. The single burner consumes 9 cubic feet of 16 candle gas at 22-tenths pressure, and gives a light equal to 155 candles, or a duty of 17 candles per cubic foot of gas consumed. They are made in singles, and in clusters of three, five and eight, and are used entirely in Wellington Street, London—one of the large clusters being opposite the Lyceum Theatre. There are also a three-light cluster and two single lights burning nightly outside the railway-station at York. These burners are admirably adapted for street-lighting, and for the lighting of big buildings. The Corn Exchange—a building 70 ft. by 50 ft. by 50 ft. high—at Oxford is lighted with four 5-burner open lights, arranged with a separate supply for the pilot lights, so that all could be turned out by opening one tap fixed within easy reach. They are also

to be seen in some of the street lamps. Compare the above with the general practice of lighting in England, and what do we find? In the main thoroughfares the columns are set at least 40 yards apart, and in side streets 70 and 80 yards apart, running alternately from side to side. These distances ought to be reduced to 20 and 40 yards respectively, especially when considering that the lanterns are fitted with flat-flame burners, consuming 4 to 6 cubic feet of gas per hour, and in all cases only one burner per lamp, excepting busy centres where Bray's, Sugg's, or other makers' high-power lamps exist.

Incandescent gas lighting for public thoroughfares seems to be the most effectual and economical system, and certainly one to be recommended.

Wall-brackets are abandoned in Paris, and ought to be done away with in England from a gas-fitter's point of view, as they are one continual source of trouble in keeping the supply-pipe free from stoppage at that point where the service leaves the ground. An improved form in the shape of a combination bracket and column is depicted by Fig. 54.

The column in this case is something like the ordinary column, but sometimes having a flange at the base, only on three sides, which, in the ordinary post, is all round the bottom. The plain side is to allow fixing close up to the side of the house or wall. These bracket-columns have two distinct advantages over the ordinary wall-bracket. In the first place the fixing is independent of the house and on public property, there being no necessity to get the landlord's permission to fix; and secondly, the column protects the stand-pipe from undue cold, as there is found to be less trouble with stopped pipes by such protection.

The bracket-column is used for narrow footways and in such places where there are telegraph, telephone, and other kinds of mains running near the inside of the curbstone, especially in London, which would greatly interfere with the fixing and running of the supply, consequently the only alternative is to fix in the curb or dispense with the ordinary column and use a bracket-column fixed in the pavement, flush with the wall of the premises abutting the same. These bracket-columns are considerably higher than is thought necessary for ordinary lamp-posts, being about 16 ft. ; and the pattern illustrated has a neat appearance without conspicuously attracting notice. The surveyor of St. Luke's parish, in London, has designed a somewhat similar bracket-column, which is only used and to be seen in that parish.

Ordinary iron brackets vary very much in combination, but the most practical one has the bracket iron set to the level of the lamp, and no bracket should be fitted with a smaller stand-pipe than  $\frac{3}{4}$  in. barrel. The bracket lamps that are used outside shops and public houses do not come under this heading as their connections are generally run from inside the building. All brackets should have a T-piece on the top of the stand-pipe with a plug in the end, which will be found very convenient for clearing the service and a prevention against damaging the wall of the premises on which the bracket is fixed, as there will be no need to disconnect the stand pipe. Wall-bracket lamps require less expensive fittings than for columns, and for this reason are much adopted by lighting committees, but from a gasfitter's point of view they are a source of continual annoyance owing to the exposure of the pipes; they are readily stopped up, especially at the point level with the ground, or in the arms of the bracket. With slight changes



of the weather jumping lights or naphthalene deposits are the result, and where provision is not made for the ready removal of such obstructions, the pipes must be disconnected, which often causes damage to property independent of probably new material as well as time occupied on the job.

In the case of the bracket-column used in St. Luke's parish, the bracket is of cast-iron which drops on to the head of the column, and is held in position by set screws. In fitting this type of bracket-column up, the  $\frac{3}{4}$  in. standpipe is put down the column and the bracket held above it to allow the standpipe to be screwed in the base of the bracket. The bracket and standpipe are then lowered into position and finally fixed by the set screws. When the service has a good fall, a bend or round elbow is screwed on the lower end of the standpipe, then the necessary short pieces and connector sufficient to make connection with the main. Should there be no fall or only a slight one at the most, it is best to use a tee instead of an elbow, connecting a syphon, coil, bucket or plugged pipe form, whichever seems to present itself as the most suitable.

Standpipes are generally of wrought iron,  $\frac{1}{2}$  in. to  $\frac{3}{4}$  in. in diameter; and we would strongly recommend the larger size for all public lamps, since it will be found the most efficient and in the long run the cheapest pipe in the end, there being less likelihood of frequent obstruction either by condensed liquid becoming frozen, or by naphthalene deposits, consequently requiring less attention from the gas-fitter. In Paris, the lamp column service and the standpipe is of lead tube, 27 millimètres internal diameter ( $1\frac{1}{16}$ th in.) connected to a copper nipple by plumber's joint. The nipple screws into a plate on the top of the column, which prevents vibration, then are

attached copper fittings. The whole service in this case is in one piece, consequently, if there be no irregularities in the pipe, there is a direct flow for any condensed liquid to the main; naphthalene would not so readily choke the bore of such a large pipe. For exposed places, as on the face of walls, galvanised wrought iron-pipe is best. This is specially useful for bracket-lamps. Another point to be attended to when fixing standpipes in columns is to see that the former exceeds the latter in height by about 4 in., and also that the pipe is wedged firmly in the centre of the column by at least three wooden wedges. This is very essential when incandescent burners are to be used, as it will prevent vibration, although in London main thoroughfares, the traffic being so heavy, it is a difficult matter to entirely prevent vibration, which acts so detrimentally on the life of the mantle.

Of head irons there are two kinds, which are fixed on the heads of columns or bracket columns to carry the lamp. Some head-irons have a "frog" to carry the lamp, while others a "cradle" for the lamp to drop into. In the case of the frog pattern, there are four bolts soldered to the frame of the lamp, securing it to the frog by four brass nuts. With the cradle pattern the lamp is furnished with a wide rib or flange round the top, which simply rests on the top of the cradle, the lamp being in no other way fixed.

The pitching iron for the ladder to pitch against is sometimes cast with the column forming a T., or is of wrought-iron rod, furnished with an eye and set screw to drop over the head of the column. Also, it is made united with the cradle, the pitching iron being only on one side of the column. Perhaps the worst form is that adopted by the London County Council, which has two hooks rivetted to the head-iron instead of a pitching iron. This form

necessitates a special ladder being made, with an iron bar at the top to drop into the hooks, and the columns not always being of the same length or fixed at one height, causes the ladder to block, in some cases, three parts of the pavement, or to hang perpendicular in others. Then there is the column with no pitching iron of any kind. These are certainly most sightly, but the ladder used having a head-piece rounded out to fit and rest on the column

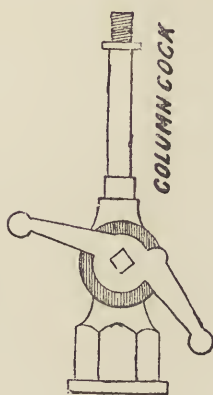

FIG. 55.



FIG. 56.

offers no resistance to side swing, which is necessary for the safety of the gas-fitter when blowing a stopped stand-pipe, since it very often requires the assistance of his mate on the ladder with the force pump.

There are several kinds of public lamp lever cocks more or less defective. The kind with the set screw are the worst, due entirely to the latter being of iron, and to a want of a means of adjusting the degree of tightness

of the plug. The screw being exposed to the weather soon rusts through, there being nothing to prevent the plug of the cock from jumping out, a too frequent occurrence. The best class of cock for general use is the one with the thumb screw and washer, which, in the event of the plug working loose, is easily tightened. Ohren's lever cock is also a good one. The washer is hinged and folds over into a rebate in the end of the plug. The plug of this cock, in the event of stoppage, is easily removed by the hand. All column cocks should be fixed inside the lamp, which would greatly prevent the numerous complaints of bad lights in the summer time, due to naphthalene forming in the cock. This is chiefly found in lamps having the burners fixed higher up than in the ordinary 14 in. lamp, the heat being further removed from the cock. Ordinary lamps, with no glass in the bottom, seldom give naphthalene troubles, proving that the heat from the burner counteracts the change of temperature which the gas undergoes between service and lamp. Of course, much can be said against such a practice. For one thing, it is easier to get at the cocks when fixed underneath the lamp. One form of column cock is illustrated in Fig. 55. The cocks should be screwed on tightly, for the frequent stroke of the torch when lighting tends to turn them, and possibly produce leakage. The torch, Fig 56, is a small lamp fitted on the end of a stick. Small holes are drilled in the brass casing to admit of air to the flame, but wind is warded off by an inner screen, so preventing the light from being extinguished. Much damage is done to the lamps by the torch being roughly used when raising the glass flap in the bottom of the lamp.

Briefly turning to the subject of lamps, which are

numerous and greatly improved upon the old style of lamp, for general use the puttyless lamp, Fig. 57, has much to recommend it, being easily fitted and kept in order. A very good type for ordinary street lighting (for 5 ft. to 8 ft. governor burners) is the Coleman street lamp. This lamp has opal glass top and enamelled earthenware

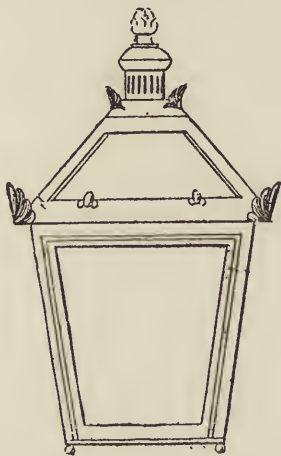

PUTTYLESS LAMP.

FIG. 57.

reflector, which also acts as a mouthpiece to the ventilator and prevents the opal top from cracking. The lamp has no glass bottom, but a small one of tin, and fitted with a small door for the admittance of the torch. This class of lamp is highly recommended for the corners of thoroughfares, for they are fitted at the top with slips bearing the name of the street. The lamplighters, however, do not like them, because of the number of corners to clean. A very similar lamp to this is the "Kingston," manufactured by Messrs. Sugg and Co.

For small refuges requiring 10 to 20 cubic feet of gas consumed per hour, the "Vauxhall" (Fig 58 ), by Messrs. Pontifex and Co., and the "Victoria," by Messrs. Sugg and Co., are recommended. In this latter lamp the Billingsgate pattern of burner and regulator is employed, and fitted with a triple lever cock, so that the gas can be

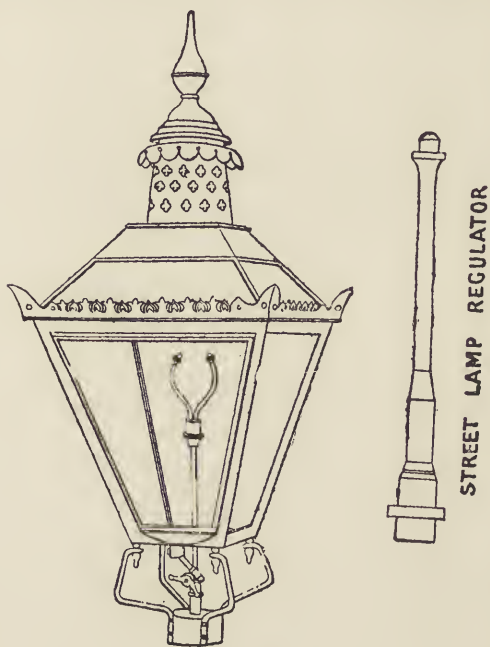

FIG. 58.

turned down at midnight. This lamp is nearly shadowless and extensively used. For large refuges and promenades the "Kensington" and the "Lambeth" types of lamps will be found to give universal satisfaction. These are also manufactured by Messrs. Sugg and Co.

The next class of lamp is the globular, such as that

used in the Bloomsbury parish, at one time the best lighted of all the parishes in London. This class of lamp cannot be highly recommended, for the flame is never steady, caused by the opening in the bottom of the globe, which is usually 5 in. in diameter. The only way to remedy this would be to run the supply through the top of the lamp, and drop down to the burner with  $\frac{3}{8}$  in. copper or brass tube. A hollow metal perforated ball could then be used to cover up the opening in the bottom, and this could be pushed aside by inserting the torch when lighting, and

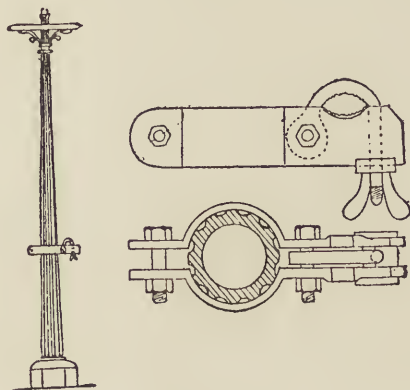

FIG. 59.

it would fall back again when the torch was withdrawn. This lamp does away with a lot of shadows, as it has only two uprights to carry the top of the cradle, instead of four in the ordinary lamp. The worst kind is the sectional globe lamp, which causes more shadows than any other, and is no good at all for street lighting.

In fixing public lamp meters, the cast-iron box, which receives the meter, is sunk in the footway close to the column facing the building, the lid of same being left flush with the pavement. The service and inlet pipe is generally

considered best made of lead, and if this is used troughing should be employed to prevent undue sagging. The outlet should be of lead pipe and should be formed similar to domestic meter fittings, and connected to the iron stand-pipe, but the latter must be supported or suspended by a flange from the top of the column, so that the weight is not upon the outlet of the meter. If supported, it is better to have the stand-pipe fitted with a T-piece at the right height and continued a little down, then capped, the capped end resting upon a brick firmly set in the base of the column. From the centre of T-piece connect to outlet of meter. A very useful tool, shown in Fig. 59, has been invented by E. H. Millard, in the shape of a portable vice for use in hilly districts, where men do not care to push the cart about. It is easily fixed to a lamp column or telegraph post, and can be used by one man—not as with the hand-cart, one man to hold the cart and another to do the work of screwing or cutting the pipe.



## CHAPTER X.

## PUBLIC AND PRIVATE ILLUMINATIONS.

UNDER this heading the gas-fitter has to deal with a variety of fittings, all of which are fixed outside, thereby requiring some judgment and foresight in order to achieve successful results. The Diamond Jubilee provided a large amount of ornamental gas-fitting work both for town and country gas-fitters, which was of a varied kind, no previous celebration ever being equal to it, for the devices were very numerous and elaborate. An occasional royal marriage affects chiefly those in the principal towns, but there are also rural and local events which bring with them extra work if only for a few days. In all cases, whether in town or country, the gas-fitter is called upon to execute or fix the illumination devices. The jobbing man in town gets only private work, while large public illuminations fall into such contractors' hands as Messrs. Defries and Sons, London.

It matters not what form the device may take, gas is the principal illuminant. The gas is conveyed direct from the main to the device, and according to the magnitude of the latter so will the number of independent supplies depend. The supplies are sometimes provided by the gas vendors, being for a temporary purpose, and are removed by them at their own expense. But while a few gas companies may do this for illuminating large buildings, they cannot do it for small private parties, since the cost of laying the supply-pipe to eight or ten feet up the front of the building in each case would more than outweigh the

return from the quantity of gas consumed during the few hours the illumination is required. The limit generally considered to be within the margin of security, is that the supply from the main to the stop-cock on the stand pipe should not exceed 36 ft. in length. Additional length is charged at usual rates. Also, that the whole illumination should produce a bill amounting to not less than 40s., when



FIG. 60.

the cost of gas is under 4s. per 1,000 cubic feet. In places like the metropolis, private inhabitants requiring gas for illumination purposes pay for all the work entailed, such as laying of the services, devices and the fixing of the same.

The Gas Light and Coke Company charge a fixed price of 3s. 6d. per 100 "pin hole" jets per night or part of a night for 150 cubic feet per hour or under.

Jets and burners above this size are subject to special arrangements, while experimental tests are conducted free of charge. Illuminations are then charged for according to the result of the test. Meters can be provided by

consumers if preferred; but the company do not issue meters for illuminations. The supply-pipes should be full size in order to have an ample quantity of gas, otherwise the devices will be inadequately lighted, and nothing spoils a device so much as by being badly provided with gas. Wind, too, will have less effect. To ensure success the service from the main must be large and run to the required height up the front of the building. To the outlet of the stop-cock fix a diminishing T-piece, and from this run two services to the device. This is cheaper than running two distinct



FIG. 61.

supplies from the main, while at the same time providing as much gas. But, of course, there are circumstances which necessitate separate services from the main so as to supply very large illuminations.

All services must have a main cock thereon about 8 ft. from the ground, and which is sealed by the Company, so that no gas can be used without their knowledge. The sealing is effected by cutting a square hole in a rectangular

piece of tin, the same size as the head of the plug, then bending the ends of the tin so as to form a loop, which must be soldered. Red tape is passed through each loop and tied round the cock; the knots are sealed with wax by the Company's representative.

Ordinary letter devices may be single lined, as **V** or double lined as **R** and are made up on a large scale by the principal gas-fitting firms in wrought iron and copper tubes, and vary in length from 12 in. to 60 in.; the respective sizes of tubing ranging between  $\frac{3}{8}$  in. to 1 in. bore. The single letters are simply drilled or punched in the centre of the tube; double letters, by punching two rows of holes as wide apart as the size of the tube will allow, or double piped letters are made. The best devices should all be made of copper tube.

Other devices may consist of a portrait of Her Majesty the Queen, ribbon with motto, stars of various kinds, crowns more or less elaborate, as in Fig. 60. Flambeaux with dates and motto, monograms "V.R." and "V.R.I.";



FIG. 62.

heart with dates and emblems, wreath and bow with "V.R." in centre, block and Roman letters, rose, shamrock and thistle with dates.

Then there are transparencies which have a special feature in that they are of different colours, these forming an attraction in themselves. These are made of fabrics fitted to an iron framing or casing provided with four or five burners inside. The fabric is hand-painted to represent

any special incident of the day, as the Queen, with dates, emblem with motto, crown with wreath and words, rose, shamrock and thistle with dates, as illustrated in Fig. 61, besides many others. This means of illumination requires a small supply of gas which can be taken from the inside fittings by employing flexible tubing.

Another method of illumination, and especially useful for bordering or outlining a building, is by running iron



FIG. 63.

tubing along the top of a building, over doors, and other prominent angles with ordinary No. 1 or 2 burners inserted at distances of 6 in. apart. These burners approximately consume 3 and 4 cubic feet of gas per hour respectively, so that the quantity of gas consumed by any illumination so fitted can be easily arrived at. Jets may be used instead of burners, which are formed by drilling or punching small holes in the tube at the aforesaid or other distances.



FIG. 64.

The size of the holes is very small, being about  $\frac{1}{64}$ th in. in diameter. They are sometimes drilled into the tube, but punching is equally as good and much more expeditiously done. The only thing is to see that they are in a straight line. In fancy work the holes are made after the device is made up, but for straight work it is best to make the holes

first, care being taken to see that all are free when the tubing is connected together.

To punch holes in a straight line fix the tube in a vice with the seam at one side, and with a file run a line along its upper surface from end to end. Then mark off the distances the jets are to be set apart. One of the best tools to punch holes in tube, especially copper tube, is an ordinary carpenter's bradawl cut short, say to  $\frac{1}{2}$  in. Then reduce the diameter of the awl  $\frac{1}{8}$  in. in length by filing to the size required in the form of a needle, keeping the shoulder of the bradawl square, which protects the point, thus converting it into a bodkin, as illustrated in Fig. 62. If carefully done and used straight it will last a long time, enabling the gas-fitter to get through a large amount of work in a very short time. The tool may be used for 1 in. wrought iron tubing if the latter be thinned down a little at the puncturing points. The line being on the tubing allows the latter to be shifted along in the vice as progress is made, so that there is some solidity to the pipe when punching the holes. An effective method of edging can be secured by filing notches with a large three-cornered file at allotted distances in the iron tubing, but not through the pipe so as to produce a hole; then by means of the bodkin punch holes in the sides of the notch so that the holes nearly face each other, but not directly opposite. In this way we get two pencils of flame just passing each other. The method has the advantage, apart from a pretty effect, that the wind may blow some of the lights out, but they immediately re-light one another. Care is required when filing the notches and the maintenance of punching the holes at a regular angle. When properly done, the effect will be as in Fig. 63. The larger the flames the wider apart may be the holes.

Instead of jets so made and arranged as in either of the foregoing ways, short pieces of  $\frac{1}{4}$  in or  $\frac{3}{8}$  in. brass tube carrying glass buckets or star burners may be screwed into the "string coursing" as the line of tubing is sometimes called. If brass tube be used it must be provided with a clamping gallery to support the globes. The form of burner is illustrated by Fig. 64.

Buckets can also be obtained for use with candles or oil, and are strung together as per Fig. 65. These are very useful in making effective displays where gas is not



FIG. 65.

procurable and where there are drawbacks to the fixing of a gas supply.

The buckets being of glass must be securely fastened by the wire they are bound with to the tube design, other wise, during windy weather, accidents may happen by their being blown down into the street. They are of various colours, viz., amber, green, blue, purple, ruby, or opal and crystal, and when assorted along the line of a building or

over arches they give a richness to the illumination; and they also prevent the wind from blowing the lights out. The light colours show to the best advantage.

When illuminations have to be put up away from any building, as across roads and avenues, some staging must be erected, upon which the device can be fixed by hooks or nails. These supporting structures are generally of wood, and those parts which come adjacent to any flames must be covered with sheet-iron.

We have briefly touched upon the subject generally, but before closing some mention of coloured fires is necessary, as no illumination is perfect without some display of this kind.

There are a good many recipes, among which the following may be mentioned as being really good. The mixtures are fired in dishes or ladles of iron about 6 in. in diameter by 3 in. deep in the middle. Any quantity can be taken of the mixtures, but a pound's weight is ample for a fire at a time. The fumes arising therefrom should not be inhaled.

*To produce Purple Fire.*

	Avoirdupois weight.	
Black sulphide of mercury ...	o oz.	10 drams
Black oxide of copper ...	3 "	2 "
Flowers of sulphur ...	7 "	4 "
Saltpetre ...	7 "	4 "
Chlorate of potash ...	13 "	12 "

Costs about 2s. 3d. per lb.

*To produce Blue Fire.*

Nitrate of potash, dry ...	21 "	5 "
Tersulphide of antimony ...	3 "	8 "
Sulphur ...	7 "	3 "

Costs 1s. per lb.



*To produce Green Fire.*

Barium nitrate ...	...24 oz.	10	drams
Flowers of sulphur...	... 4	2	„
Chlorate of potash ...	... 1	10	„
Lampblack ...	... 1	0	„
Metallic arsenic ...	... 0	10	„

Costs 1s. 6d. per lb.

*To produce Crimson Fire.*

Nitrate of strontia ...	...20	0	„
Flowers of sulphur...	... 5	12	„
Chlorate of potash ...	... 5	0	„
Lampblack ...	... 1	4	„

Costs 1s. 6d. per lb.

*To produce Red Fire.*

Nitrate of strontia ...	...21	4	„
Shellac ...	... 7	2	„
Chlorate of potash ...	... 3	10	„

Costs 1s. 6d. per lb.

*To produce White Fire.*

Nitrate of potash ...	...23	4	„
Flowers of sulphur...	... 6	12	„
Realgar (sulphide of arsenic)	2	0	„

Costs 1s. per lb.

*To produce Yellow Fire.*

Nitrate of soda ...	...24	0	„
Flowers of sulphur...	... 6	2	„
Charcoal ...	... 1	14	„

Costs 1s. 6d. per lb.

The several substances can be obtained from any chemist and from some oil and colour salesmen, but they must be *dry*, as the success of any particular fire depends upon this. Some of the ingredients are in lumps and

crystals, but all must be reduced to a powder in a hard, wooden bowl or mortar. By passing them through a sieve, preferably of hair, is a good way to mix them. When mixed keep in stoppered bottles to prevent firing, and do not, upon any account, grind the sulphur with chlorate of potash as ignition may result.

The above mixtures are all of 2 lbs. weight but any quantity can be made up so long as the proportions are adhered to.

## CHAPTER XI.

## THEATRES AND PUBLIC PLACES OF ENTERTAINMENT.

IN all places of entertainment the gas-fitting is an extensive piece of work requiring some skill and care in order to get good lighting results. This is more particularly the case when the building is a theatre, subject as it will be to the adoption of different plays, each requiring some modifications of lighting. Music halls are somewhat similar, but requiring less elaborate and intricate arrangements, while other public places of amusement, as assembly rooms, concert rooms, and public halls, have still a different arrangement for the distribution of gas. But in all these cases the actual fitting together of the pipes is the same, and no faulty connections are allowable as every fixture must be of the strongest.

The gas-fitting is usually done by contract and carried out according to a scheme of work. In London the nature of lighting and mode of supply is subjected to the London County Council for approval. The Council insist upon modern places of entertainment having at least two, and often three, distinct services from the gas company's main in the street. In the case of a theatre a service is required to supply the staircases and landings, and is connected with a separate 10 to 20-light meter, according to the size of the building; a second service to supply the front is connected with a 150 to 200-light meter, and a third to supply the stage and connected with a 400 to 500 light meter. It is, however, also found useful to supplement this last with a 300-light meter, which is

often used on special occasions when additional gas is wanted, and for rehearsals.

Meters must be fixed in properly constructed brick rooms provided with ventilation. These, with the above, are precautions found necessary in case of fire.

Most of the lights in theatres are under control and worked from the prompt side of the stage (right-hand when viewed from the auditorium), where the outlet of the stage meter must be run. The service varies considerably in size, so also do other gas-fittings, being dependent upon the requirements of the theatre, which renders the descriptive treatment somewhat difficult; but in describing generally the nature of the numerous supplies, with precautions and necessities, it is to be hoped the gas-fitter will be able to follow the course of procedure, and from his knowledge of gas-fitting make the necessary connections without recapitulation of much of what has been treated upon. Again, it must not be understood that one hard and fast method should be followed, but the best and simplest means of effectually carrying out the work.

In briefly describing the gas-fittings of a large theatre it is assumed that the requirements are known, and that the cast-iron service from the outlet of meter is a 6 in. one. Proceed to run it to the wall where the manipulating cocks are to be fixed. Should the position of these cocks be shown on paper there will be no need to plot the work out on the wall; but if not, it is as well to do so, and after revision the work can be got on with without the possibility of mistakes, and completed very much quicker.

A main cock is fixed to the service above the stage line; then a short piece of pipe, provided with a flange, to which a chamber, 6 in. square and about 5 ft. long, is bolted. Well soak the millboard in water ere painting with

lead mixture to ensure a good tight joint. Leakage must not be risked by any such neglect of paint, whether in making a flange or a screw-joint, as there is quite sufficient gas escaping from the many cocks without adding thereto by faulty joints. The chambers are of different lengths, cast square or round in shape, and can be obtained having a varying number of outlets on the top and bottom. The supply from the meter is in the centre, and so they really form, when fitted up, a branching tee-piece, already described in a previous chapter. This chamber again supplies other distributing chambers usually with from three to six outlets. One of the chief chamber outlets is provided as an extra one against something special likely to crop up requiring gas at a future date; the supplies can be fitted when needed. By this means gas can be obtained without disturbing any other communications.

Into the chamber screw short pieces of pipe, each provided with a main cock, then a further short piece, to which the distributing tee is connected. This is again fitted with short pieces and cocks of the size necessary for the supplies leading therefrom to the lights. In this way a great number of services can be supplied with gas from one meter.

In theatres and many music halls this is essentially necessary for the requirements of the performance, which may need much, little, or no light at a moment's notice on the stage or in the auditorium. Many of the good effects would be lost or greatly marred if the gasman had to turn down every cock provided, as, for instance, on the services to the border or flash lights. But by having such and similar multiple lights fed from a chamber common to all, the inlet cock to any particular chamber is the principal regulator of the gas supplied therefrom; the cocks on the

separate services being simply used to control, or stop, the supply on any one service when required, and should the gas be adjusted it remains in that position since the principal cock turns the gas on or off. Similarly the supplies to the flash-lights, pilot-lights and circles have to be under complete and rapid control.

Since strains, when fitting the parts together, cannot always be entirely avoided, use only cast-iron cocks fitted with well-ground-in gun-metal plugs. Brass cocks are not strong enough, besides being less satisfactory in respect to leakage. With the very best of care it is difficult to prevent the cast-iron gun-metal plug-cock from leaking, as those who have to do with a case of manipulating cocks only too well know. A smell of gas is always self-evidence of leakage, and the better the connections the less apparent will this drawback be. For smaller buildings the chambers are built up as directed on page 114, but when of larger size than that mentioned the difficulty to get the many joints sound is not worth one quarter the trouble entailed. It is far better to use a branching-tee, or chamber, which is cast in one piece and thus gives much less work, not to speak of probable irritation avoided.

To construct the border lights, procure a length of 1 in. pipe, the width of the stage, and drill and tap holes at intervals of 4 in. to suit 5 ft. per hour iron burners. Now, the flash-lights must be constructed out of  $\frac{3}{4}$  in. barrel of equal length and fitted with special burners to give flames similar to those depicted by Fig. 63. Pilot lights are also required, and are formed out of a similar length of  $\frac{1}{2}$  in. barrel. Three or four pilot-lights will be sufficient to light the flash-lights, which latter in turn ignite the border lights. These three pipes, or sets of burners, form one series of border-lights proper, and are fixed within

an inch or so of each other (the first mentioned being at the top with the other pipes in the order treated below) to an angle-iron batten having sheet-iron fastened to the back of it, with provision to take wire gauze or wire netting to guard the lights from firing the sky borders, as illustrated in section, Fig. 66. The flat-flame burners must not be set as illustrated, but having the flat side of the flame in a line with the pipe. The gas is supplied by means of a leather hose having spiral wire inside, which is found to be much more satisfactory than india-rubber tubing.

The sheet iron is sometimes whitened with a mixture of whiting and tallow, this being found to stand heat much

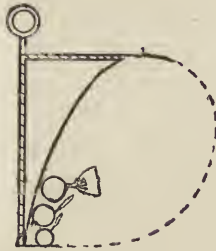

FIG. 66.

better without scaling off, as is the case when ordinary whitewash is used.

This done, the battens are suspended by means of pulleys for convenience, so that they may be easily raised and lowered as occasion demands.

The supplies to the border and flash-lights should be  $\frac{3}{4}$  in., while the burner pipe is 1 in. barrel. The circles are usually of a horse-shoe shape, and are best lighted by three supplies from a chamber. To do this, run a  $\frac{3}{4}$  in. service round each circle, from which the burners of a somewhat similar type to those represented by Fig. 64, are directly

taken. This  $\frac{3}{4}$  in. pipe is supplied by running the  $1\frac{1}{4}$  in. supply from chamber to the nearest end of the service and making connection by diminishing from  $1\frac{1}{4}$  in. to  $\frac{3}{4}$  in.

But before this connection is made two  $1\frac{1}{4}$  in. tee-pieces must be put on. One to supply the other end of the  $\frac{3}{4}$  in. pipe on the "O.P." side by running an inch service under the stage, reducing to  $\frac{3}{4}$  in. at the point of connection. The other supply, also 1 in., is run round inside the balustrade and at the foot of it, to about the middle of the circle, where connection is made by a diminishing T-piece. Syphons must be fixed at the lowest point wherever the supplies drop down from the lever board. Similarly deal with the other two circle supplies. Should the nature of the plays not permit of the services being run in any direction under the stage, as when the cellar is used for disappearing subjects, as in transformation scenes, or where a portion of the stage is made to drop and slide underneath, the pipes would be in the way, if care be not taken to see that they are kept together under the stage by running them close up to the proscenium line.

Bye-passes are fitted to each supply and carried well above the taps.

From the underside of the chamber take a 1 in. service to supply the dressing-rooms, passages, property-room, under the stage, and such other places which require gas always burning, as will not interfere with the progress of the play. All such lights are summed up under one title, *i.e.*, station lights. They must be guarded by using wire globes, as naked lights are not permissible in theatres where there are many articles moved about of an inflammable character. It is usual to have in the daytime, for rehearsals, &c., a form of standard representing a large tee 5 ft. high with a 4 ft. top, made out of  $\frac{1}{2}$  in. or  $\frac{3}{4}$  in. barrel. Near the foot of the



stem insert a tee-piece fitted with a short piece of pipe to which is connected the flexible tube from the supply service. The best service to supply the standard from is the station-lights' supply, since the latter is on all day; and it is desirable to have an hydraulic joint for this near the footlights. The standard can be fixed by employing a piece of cast iron with a hole in the centre, the stem of the former being leaded into this hole, thus making the standard portable. The burners are put into the head-piece at intervals of 5 in. This form of burner is used to enable the manager to see the general effect, and so judge of the proficiency of the performers.

Next come the ground-rows and wing-lights, for which  $1\frac{1}{4}$  in. supplies will be required. Three at least are necessary, fitted with taps and bye-passes. From each of these mains there is an outlet taken to supply an hydraulic joint for each wing. There are usually six sets of wings, each provided with red, white and green lights. Proscenium lights are supplied, three 1 in. services also taken as before, direct from the chamber. The last three 1 in. supplies from chamber are for the footlights, and are generally placed on the wall in front of the stage, but in such a way that when the burners are fitted the flames are level with the stage. The pipes, therefore, are below the level of the stage and lying side by side. It is necessary to note that although there are three services there must only be one row of burners, fitted alternately with clear, red and green chimneys, the latter being supported preferably by a brass clamping gallery, and not a crutch as illustrated in Fig. 67. The crutch allows the chimney to rattle against it. The object of this arrangement is to get a good effect, since if the burners were fitted directly over each service shadows would be produced when the front rows were

lighted. The pipes must be placed close together so as to mark on each pipe the position of the burner in rotation, as front, centre, back, allowing 4 in. apart, which is equal to 12 in. on each pipe, then through these marks drill and tap  $\frac{3}{8}$  in. holes. Now, as the pipes when fitted will be about 1 in. apart it will be necessary to fit on the front and back pipes short male and female elbows. Make up the distance with short pieces of brass tube fitted with another elbow so as to bring the centre of this up-turned elbow immediately over the central pipe. The elbow is now fitted with a tap and argand burner. The burner that is fixed

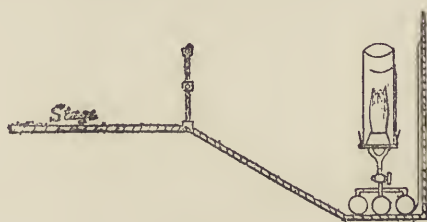
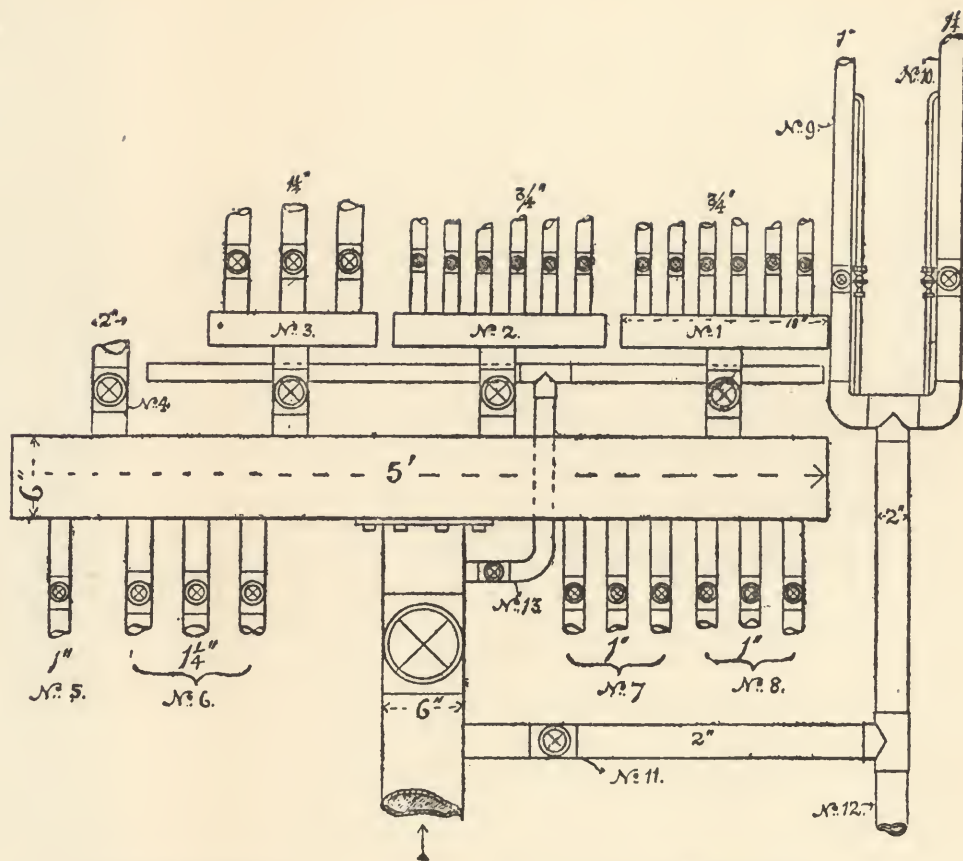

FIG. 67.

directly over the centre pipe will require a short piece of tube screwed into the pipe to bring it to the level of the other burners. Argand burners are the best for footlights, and if they are not fitted with a lever tap, ordinary  $\frac{3}{8}$  in. brass taps must be employed to regulate the flames to one height. As this kind of burner requires a chimney to ensure a good flame, it also affords an easy way of obtaining different coloured lights by using coloured chimneys. The pipes must be securely fixed on a firm base to prevent vibratory motions produced by dancing and other rapid movements on the stage.

The footlights must be screened from the view of the audience by means of sheet iron of such width that no light





- |    |   |     |                                  |
|----|---|-----|----------------------------------|
| 1. | To supply border-lights.                | 7.  | To supply proscenium lights.     |
| 2. | „ „ flash-lights.                       | 8.  | „ „ footlights.                  |
| 3. | „ „ circle.                             | 9.  | „ „ boxes showing bye-pass.      |
| 4. | „ „ extra outlet for future use.        | 10. | „ „ sunlight.                    |
| 5. | „ „ station-lights, dressing-rooms, &c. | 11. | Bye-pass for principal supplies. |
| 6. | „ „ ground-rows and wing-lights.        | 12. | Supply from front meter.         |
|    |   | 13. | Supply for bye-passes.           |

FIG. 68.

To face page 149.

can be seen from the auditorium. It is fixed on its edge and given a coat of the whitewash prescribed on a preceding page. A better and more artistic method is to have a wooden frame fitted with porcelain and mediæval glass. The porcelain acts as a reflector, while the stained glass prevents the glare from dazzling the eyes, at the same time giving a pleasing effect. These lights must also be guarded by wire netting being fixed from the stage to the screen, but a more common way is to use brass uprights fixed at intervals along the front of the stage with brass tubing lacing them together. As a further precaution against setting fire to dresses, brass mesh-net should be fastened to the railing. The whole is represented by Fig. 67.

Before leaving the stage the chief supplies for the boxes and sunlight have to be fixed alongside the distributor, as they are also controlled from the stage, although the meter is fixed in the front of the building. Having run a 2 in. service from the meter to the stage, a T-piece must be put on at a convenient height, so as to carry therefrom a bye pass connection to the 6 in. inlet to chamber a little distance below the cock (see 2 in. connection number 11). The bye-pass must be fitted with a tap as shown in the illustration, Fig. 68, which represents the arrangement of the pipes so as to distribute gas over a large building. Continue the 2 in. supply to the level of the 6 in. chamber, then branch off with a tee, on each of which screw diminishing elbows by means of nipples. For the boxes a 1 in. and for the sunlight a  $1\frac{1}{4}$  in. service will be required, each fitted with cocks. Like all other services, except station lights, bye-passes must be fixed, and in doing this avoid the method represented in Fig. 52, which is unsatisfactory when rapid switching of large quantities of

gas on or off is necessary. The sudden pulsations cause the gas to go out. If, however, the bye-pass gas is taken from below the chamber, or some distance below the cocks of the branching tee, and then allowed to enter the particular services at least 3 ft. above the manipulating tap, no marked effect will be noticed. In the case of the bye-pass gas for border, circle and other lights it will be noticed, upon reference to the illustration, that the supply (usually 1 in. or  $1\frac{1}{4}$  in.) comes from below the principal chamber, and is run up behind the latter and the other pipes from a horizontal feed-pipe. The desired number of bye-pass supplies are taken from this, similar to those represented for boxes and sunlight, and are constructed out of  $\frac{3}{8}$  in. brass tube.

The auditorium is sometimes lighted by a large gasalier, sun-burner, or star-lights. Whichever system of lighting is adopted, great care is necessary to see that the lights are strongly fixed to the ceiling, using extra strong bridge-wood. Ventilation in theatres is absolutely necessary in order to remove the vitiated air. This is much accelerated by fixing the flue or ventilator immediately above the sunlight or other burner, but it must not allow down-draughts or rain to enter. The electric sunlight does not aid ventilation, and in some theatres the auditorium is principally lighted by gas in order to take advantage of the heat generated, which causes a draught upwards, and so is of valuable assistance in bringing about thorough ventilation. In other parts of the building electric light has many advantages over gas in the way of decorative lighting. When the auditorium is lighted by electricity, ventilation is brought about by the system of forced air.

A service must also be run to supply the pilot lights. In constructing the wing-lights see that the coloured lights

are placed projecting outwards and at an angle to each other, but alternately over one another, since if they were not so, the heated air ascending would greatly interfere with the steady burning of the flames in the chimneys. For the white lights this is not so essential owing to the use of flat-flame instead of argand burners. These movable lights, like the rehearsal standard, are supplied from hydraulic joints by flexible tubing. The joint is formed by boring a 1 in. hole in the floor of the stage at convenient places. It is made up by using a piece of  $\frac{7}{8}$  in. brass pipe 13 in. long; into one end screw a bushing-piece, through which passes a 7-16th in. brass pipe of such length that it nearly reaches the top of the  $\frac{7}{8}$  in. pipe and projects through the bushing-piece an inch or two. The 7-16th in. pipe has a long screw on the end that screws through the bushing-piece, to which is connected a tee-piece. This body is now fixed to the stage by means of a flange sunk flush with the floor. A  $\frac{7}{8}$  in. pipe about 13 in. long is fitted with an elbow and suitable connection for the flexible tubing. This pipe slips easily over the 7-16th in. pipe, this making a perfect seal when water has been added to within a little of the top of the annular space around it. The supply is connected under the stage to the tee-piece and provided with a stop-cock, which is manipulated from the stage level by a long key. A plug is also fitted to the T-piece in order to remove any water that may get into the supply. When the joint is not in use a disc and tube is placed on the inner tube instead of the elbow-piece, over which the actors might stumble. The joint, partly in section, is illustrated by Fig. 69.

The refreshment-bar is supplied with gas from a separate meter, as the catering is generally let out to a business firm. From the outlet of the front meter a service

is connected to what is technically called a "pass-meter," which latter registers only the gas consumed in the bar department for heating and lighting. The fitting up of the bar is dependent upon the nature of the utensils to be heated; but in nearly every case the atmospheric flame is used. This kind of burner is seldom made up now-a-days by the gas-fitter, as there are a number of ring and other shaped burners on the market to choose from at low cost. For heating water and coffee, urns are principally employed and are fixed on the counter.

A jet or two should also be fixed on the counter or small tables for the convenience of smokers.

Theatres of any pretensions at all should employ a good gas-fitter and not, as is often done, get a man to come in nightly to work the lever board. This latter plan is more costly, owing, no doubt, to the fact that the man has no interest in the quantity of gas consumed, and does not trouble about leakage or anything beyond manipulating the cocks. Whereas a man on the premises sees to all taps and syphons in the daytime and periodically tests for leakage. A gas-fitting firm cannot always send the same man, and there being so many services in a theatre, some of which require occasional attention, that ere a stranger can locate a defect a considerable amount of time has often slipped away, thus running up a bill for very little work done. While a gas-fitter on the premises soon knows where to look for the defects, and, besides, he can execute extensions or alterations as desired by the manager. Illness falls to the lot of all men at some time or other; and should the gas-fitter be away, a stranger would have a difficulty in knowing which part of the building was supplied by any particular service, and so on. To save great inconvenience every service should be labelled with a brass ticket, bearing



the name of the lights supplied by it. It is also desirable to have the whereabouts of syphons and stray taps stated on paper, and hung on the wall near the lever board.

Music Halls do not require such elaborate fitting up; three or four chief supplies from a chamber or distributing-tee will generally be found sufficient. One for the footlights; one for the sunlight and brackets of the auditorium; one for the station lights; and one for the front and the refreshment bars. Occasionally the hall is lighted by star-lights and the galleries by wall brackets or small star burners. The services are branched right and

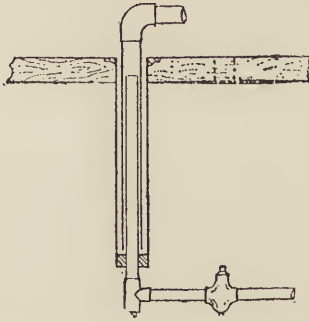

FIG. 69.

left and run under the galleries, tee-pieces being inserted at about every four or five yards, from which drop down with a necessary length of  $\frac{3}{8}$  in. iron piping provided with a reducing male or female elbow. The male end is screwed for  $\frac{3}{8}$  in. brass, so that the back and bracket can be readily fixed. In fixing the sun or star burners, see that the bridge wood is securely fastened to the joists; in all other respects the work is similar to that already dealt with.

In the case of assembly-rooms and town-halls, a distributing-tee with three outlets is usually ample, since in

these places there is no need of so many supplies. The star-lights and wall-brackets are the chief lights to supply. A service for the ante rooms, passages, and corridor is necessary ; and when a kitchen and other apartments are in the same building another supply should be allowed for this purpose only. Sometimes rooms are let off to private individuals, who have the gas measured from a separate meter, although the inlet may be a branch from one of the chief supplies.

## CHAPTER XII.

## GAS-FITTINGS FOR SHOPS.

IN lighting retail shops with gas there is no hard and fast rule to follow, for everything depends upon the class of shop, its magnitude, the amount of work required to be done, and the amount of money to be laid out for gas-fitting. The work is often found partly done in a new and not very extensive shop, as the modern builder goes to the expense of running the barrel when the shop is in a skeleton state, but it will frequently be found that provision has only been made for a centre light and one in the ceiling over the centre of each window, unless the future tenant has been fortunate enough to settle upon any particular shop before the pipes are run. The builder or owner will then make slight additions or alterations from the usual number of supplies to meet the wishes of the shopkeeper. Again, there are many shops built recently or years ago that have not had the pipes run through them, including the private rooms above the shop, and particularly in such cases we find that the owner of the property will not go to the expense of fixing, what might be, permanent pipes in the shop alone. The result being that what pipes and fittings are required the shopkeeper pays for; and consequently the gas-fitter, in order to secure the work, is forced to reduce his estimate to the lowest possible amount, using, thereby, chiefly composition pipes, which are not buried in the walls, but simply run and fixed on them. The private premises above are seldom lighted by gas, but by oil, until

the tradesman sees whether it is worth his while to stay. Should the tenant leave the premises the fittings, including the pipes, are also taken by him, and in most cases the walls must be left in good repair.

The fixing of the meter is usually the work of the gas vendor's men, the outside gas-fitter simply connecting the outlet with the fittings he may have laid. However, the position of the meter in the case of shops is usually under the window or on a bracket in the cellar. It really matters very little where it is placed so long as there is room to fit and readily manipulate the various outlet taps, as well as to see the meter index.

Large shops having work-rooms, show-rooms, and domestic apartments all in the same building, are best supplied from a distributing-tee, having the requisite number of outlets. Each outlet should supply gas to the respective branch of the building, so that in the case of the work-rooms or show-rooms, the whole of the lights can be turned out after closing time. The tap on the shop supply, especially in such shops as jewellers, silversmiths, and a few others which require police inspection periodically throughout the night, should have a  $\frac{3}{8}$  in. brass bye-pass fitted to it. This will allow gas to pass to supply some burners, the lights being turned down to give glimmering flames sufficient, however, to enable the police to see through the sighthole in the door that everything inside is well. But the author wishes to impress upon the reader that these small naked flames are dangerous in so far that large moths—which have a propensity to fly to light—can easily extinguish them, and gas consequently escapes. Such a case came under observation once in a bedroom where a little gas was allowed to burn as a night light. On waking up, the apartment was full of a gaseous mixture, and after opening

windows and door for some considerable time, a match was lighted only to find that gas was escaping from the burner. The latter was lighted and watched, but had not been burning long before it was extinguished by a fairly large moth. Some people may have actually lost their lives by such a means, especially in cases which have been reported that the occupants of the room must have inadvertently blown out the gas. If lights by night are wanted, it is better to use one with a good flame or to have the flames guarded. Having strayed somewhat from the subject, although of importance and allied to it, the experience is of use to others. In some places it is desirable to know the actual quantity of gas used for business purposes, apart from what may be used in other sections of the building, and this can be arrived at by fixing a pass meter to either register the gas consumed for purposes other than required for the business, or to register the gas consumed for the purposes of the business. This latter plan should only be adopted when the shop is not very large.

In all shops the method of lighting the window or windows forms the principal subject for consideration ; but much depends as aforesaid upon the business to be carried on, for while inside lighting suits one shop, it will not another. A few can be classed together which are best lighted from the inside, others again appear best when lighted from the outside, but in some both means of lighting a shop front are adopted. Those that can be classed as coming under the heading of *inside* lighting are prominently lighted by two methods, *i.e.*, reflected light from above and direct light. The window illuminated by reflected light gives the most pleasing result, since the source of light is not immediately in view and often entirely

out of sight, consequently there is not that interference with one's sight so often experienced when looking into a window lighted by burners in or a little above a line with the eyes. The articles in the window are not only better lighted, but better surveyed. This cannot be said of most articles lighted by direct light. The shadows are more marked, and the glare from the lights tends greatly to give a window a bad effect. Then there are shops that cannot be well lighted by either method, and yet of the two the direct lighting seems to be mostly in vogue.

As types, take tobacconists', chemists', perfumers', and hairdressers' shops, which appear to best advantage under the influence of reflected inside lighting. Such as clothiers' and mantlemakers' shops seem better suited to direct inside lighting by using pendants, clusters, or regenerative burners; but relatively speaking more flames are required to get tolerably good results, for it must be borne in mind that these windows extend some distance back into the shop.

*Outside* lighting is best suited for drapers', hosiers', glovers', cutlers', stationers', jewellers' and bootmakers' shops, and in classifying these one has to consider the action of the gas on the goods and the accommodation for fitting, as it should be noted that hosiery goods and the like are best displayed in rows in the window from bottom to top close to the pane of glass. Cutlery goods if illuminated from inside, get rusty, due to the products of combustion condensing thereon, while jewellers and silversmiths find that their goods tarnish very rapidly when gas is burned in the window, this being due to moisture and sulphurous fumes resulting from the combustion of gas. A few are lighted inside, but the best and most prominent prefer outside illumination, although occasionally a window when cased in

can be efficiently lighted by reflected light from the top of the casing by fixing the burners and reflectors there to diffuse the light downwards, thus giving a soft illuminating effect.

*Inside and outside* lighting of windows is often unnecessary, and where found it is entirely owing to one system or the other being faulty. But some shops, as fruiterers', adopt the plan to illuminate the stall and street, also chemists to show off their coloured bottles and so attract the attention of passers by. Some shops, as tobacconists', employ a large lamp also as a means of advertisement.

In fitting the gas pipes for the first of the three methods touched upon it is usual to find the window cased in and covered over with glass at about 8 ft. from the floor. On these squares of glass are placed two, three

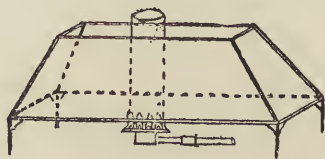

FIG. 70.

or more argand burners, or, better, incandescent burners—single or in pairs—each being provided with a round or square reflector. The reflectors vary a great deal, the best being of plain or fluted sheet mirror glass fitted into a frame, as illustrated in Fig. 70. In shape they are square, rectangular and circular; the circular opal shades being most effective for incandescent gas lighting, since they do not take up much room, besides being carried by the burner.

The supplies are occasionally of iron, but more generally of compo pipe, for it is easier to work and fix, besides being more advantageous in such places. It is very

cheap and useful in numerous places where it would be awkward to run iron pipe. This is often found when running a finished building, where if soft piping must be employed, it would be better to use tin pipe. Although more expensive, it is just as easy to work with, although it melts at a lower temperature than compo. Use the blow-pipe for making the joints. Joints are quickly and neatly made, but it takes a practised hand to make good and neat connections to fittings with soft tube. Tin pipe is also better for all conspicuous positions where bends and curves are needed, as they can be made smoother, while giving better finish to the work. When compo is used, it is chiefly in the windows that its convenience becomes evident, and if nicely dressed and painted will look well. However, iron pipe should form the principal supply along the window casing, putting in tees where needed, from

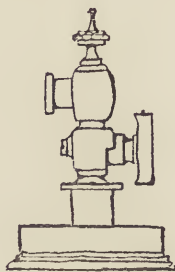

FIG 71.

which run short pieces to the burners. Should the casing not be straight or the burners in such positions that, to fix iron pipe would necessitate many joints and fittings, then use  $\frac{1}{2}$  in. tin or compo pipe, the branches being of  $\frac{3}{8}$  in. tube. Clips should be used to fix all pipes that are exposed to view.

For inside lighting of a shop window it will be found



best to fix the desired number of brackets (at least two) at the top of the casing, using that form which has an upright back with single swing, Fig. 71. Fix them in such positions that they divide the window into three parts as it were. The incandescent gas burner fitted with opal reflectors gives a very good light, or the burner provided with a moveable pyramid showcase reflector after the style shown in Fig. 70. This method allows the top of the casing to be readily cleaned by swinging the bracket and burner out of the way. Much the same result can be obtained without altering the gas supply from the centre of the roof of the window by fixing, at not less than two feet from ceiling, a shortened 2-light pendant. When the window is not cased in, the pendant should not exceed three feet in length, because the higher and more out of sight the burners are the better the effective illumination. Instead of ordinary flat-flame burners, employ incandescent reflecting burners as mentioned above.

Small windows can be effectively lighted with a reflecting cluster as Fig. 72. According to the nature of goods to be placed in the window, so will the cluster have to be fixed either stiff or with cup and ball joint.

As these lights are usually only 18 in. to 24 in. long, the reflector or heat disperser prevents a direct upward current of hot air, and so protects the roof or ceiling of the window from firing. Large clusters vary in length up to 4 ft., and can be obtained also as a ventilating light.

In all cases where the burners are 2 ft. and under from the ceiling, it is necessary to use a mica or talc coronet for the top of the chimney or globe, or by fixing to the roof a copper or tin smoke consumer as a safeguard against fire.

Modern shop fronts are lofty, and the thing to bear in

mind is to keep the actual source of light directly out of sight, if the best illuminating results are desired. Rather than alter burners and fittings that have been fixed somewhat low, the illuminating effect is at once remedied by arranging some kind of dark valance, with a waving edge, near the glass, or, as some traders have tried with advantage, sticking large bills on the window depicting thereon the prices and description of their goods. Either method is good so long as the nature of the business will

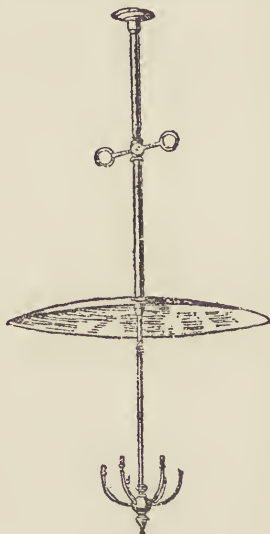

FIG. 72.

allow such to be adopted. Occasionally the window framing is wide enough to take short brackets placed, at distances apart, half-way up the window, using a reflector between the glass and the burner. The results are fairly good, but the shades in such positions become very pronounced and mar the result. It is impossible to use gas in such

graceful and attractive ways as electric lighting lends itself to art decorative purposes.

For outside lighting of shops there are many lamps of various designs to choose from, but those which are most popular have engraved panes, plain or coloured, with glazed opal on the top, containing a cluster of three burners, or by removing the cluster one or two incandescent burners can be fitted. Fig. 73 represents such a reflecting lamp which also affords a means of advertising. They are fixed just above or below the name on the fascia-board;

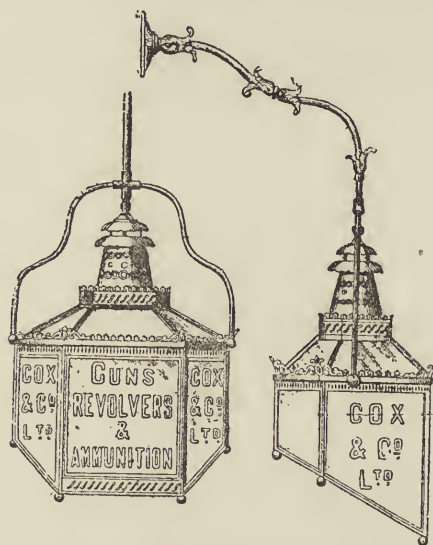

FIG. 73.

never omitting to screw the flange to board, as this materially strengthens the support, or by running the pipe under the fascia-board with T-pieces opposite the places where the lamps are to be fixed. At every tee-piece a strong clip is screwed to support the pipe and lamp. Then

there are lamps with similar back and sides but having a bent or curved front.

All lamps of this type must be fixed so that the bottom or lowest point of them is not less than 7 ft., preferably 8 ft., from the ground.

When, however, a draper, say, wants to make his shop attractive, it is best done by lighting not only the window

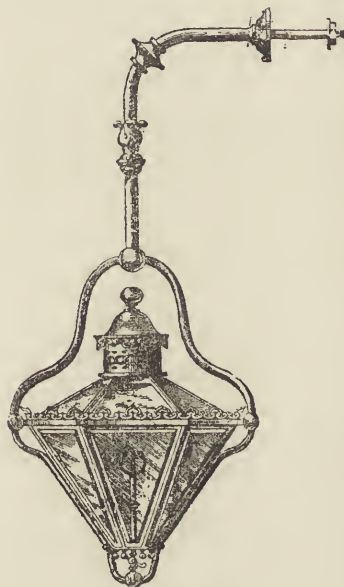

FIG. 74.

but the street; and a good style of lamp is illustrated by Fig. 74, which also shows the bracket and the means of fixing. These lamps are sometimes heavy and must be well stayed, and when fixing care must be taken not to weaken the support, whether of brick, stone or wood, by cutting away too much material, only sufficient to allow the back nut to screw up flush if this be necessary. Then

connect to the supply pipe inside by means of an elbow and connector. Be very careful when hanging a large number of these lamps not to scamp the fixing, for

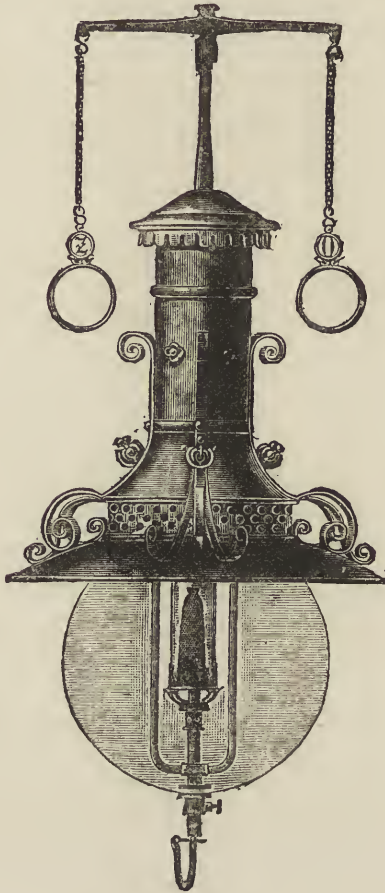

FIG. 75.

if badly fixed heavy winds may blow them down, to the danger of passing pedestrians. As a safeguard, the bracket

is also supported by a chain or strap-irons. Another thing, never suppress the supply of gas to such lamps by running  $\frac{1}{4}$  in. compo, as is often done, to secure an extra few pence profit. Such a pipe is far too small, apart from being an unsuitable pipe; and above all, see that the connection

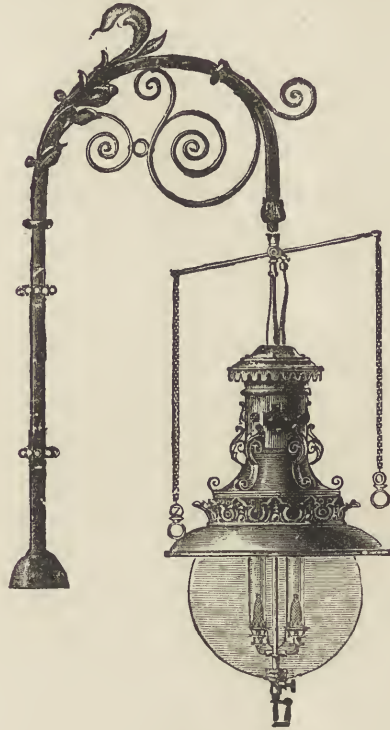

FIG. 75.

is sound, because should these joints leak the escaping gas is not readily detected. Supply them from inside if possible, and not by capping the pipe which has gone through the wall or fascia-board, then drilling and tapping a hole in the bracket outside the flange and making

connection with  $\frac{3}{8}$  in. copper tube. This is an exceedingly bad method and never to be relied upon, as the joint is usually a poor one, made tight by excess of thick paint, and besides, the lamps also suffer for want of gas. The supply should be at least  $\frac{1}{2}$  in. iron pipe, and if more than three lamps are to be fixed it is better to use  $\frac{3}{4}$  in. to 1 in. pipe, according to the number of lamps, for unless the gas is supplied at each end a larger pipe will be required. These outside lamps must be provided with a cup and ball joint to ensure them being upright, as well as helping to break up strains brought to bear upon the fixture by gusty weather.

Another excellent lamp is the "Veritas" gas arc lantern, specially constructed for the incandescent system of gas-lighting by Messrs. Falk, Stadelmann and Co., Farringdon road, London (Figs. 75). They are constructed of enamelled steel throughout, being wind and rain proof, and can be obtained for one to five lights. The lantern can be suspended from any lamp bracket or swan neck pendant, or from the ceiling by using a cup and ball joint, since it is also admirably suited for interior lighting. They are also good lamps for public street lighting, but the suspended patterns, by the use of the swan-neck pendant and a ball joint, are the best. The globes for these lanterns are of six kinds, *i.e.*, clear glass; obscured; clear with obscured centre band; half diagonally and vertically obscured; etched and tinted all over; and globes with wire netting. As a means of advertising, lettering can be engraved on the obscured part of any globe.

To get effective illumination of shop and pavement, the aforesaid lamps should be fixed at not less than 8 ft. from the pavement.

One other method should be mentioned, namely,

removable lamps, but they are fast going out of favour, partly on account of the trouble attached to them. These lamps are lighter in weight, although somewhat similar to those represented by Fig. 73, but have a hanging arm and pipe, which is so constructed that it can be removed during the day and night. For such outside lamps it is necessary to run a service pipe from some part of the shop supply to behind the sign or fascia-board, having tee-pieces let in opposite the places where a lamp top is to be fixed. The lamp tops are provided with or without flynut and key. Fig. 76 represents the lamp top with

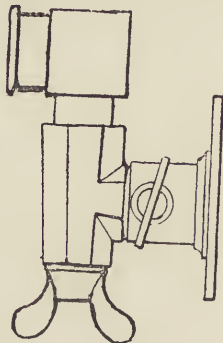

FIG. 76.

flynut and key. They are really swivel joints, and are sometimes found at both top and bottom of the bracket pipe, but more often only at the top. It is convenient to have the bottom fitting provided with a tap, as in Fig. 77, so that the quantity of gas consumed by each burner can be adjusted.

Inside the shop at some convenient place fix a stop cock, so that when the lamps are not required the gas can be turned off and the lamps taken inside. The drawback to these fittings is that, in the daily operation of



taking the lamps up and down, the plug of the swivel gets dirty and more or less abraded by use, and if not kept clean and well greased with tallow the joint is sure to leak. Another thing the gas-fitter should bear in mind, when ordering these outside lamp tops, is to see that they are interchangeable, then, when fixed, it will not matter about any particular lamp being hung always from the same top; the plug should be tight in any socket until it gets very much the worse for wear.

When a jamb rail has to be fixed in a shop window the exact width of the window must be taken, less the amount represented by the blocks, which should be screwed to the side of the window, especially if end plates are not supplied with the rail. The true length of the rail is then known and is made up and charged for at so much per foot run; also extra for each complete body and bracket or additional light. The rail may be partly fixed at one end, and in fixing

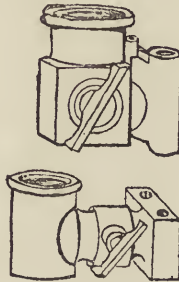

FIG. 77.

the other end a spirit level should be used in order that it may be adjusted to a horizontal position. The supply pipe must be brought through or run on the side of the window and screwed into the end of rail. When the rail has to carry many lights see that the supply is ample by reference to the table, previously given, as to size of pipes and lights.

Sometimes the rail must be fixed to the roof or ceiling of the window, and in such a case it is usual to have a supply of gas by both down-rods. The down-rods cannot always be fixed to come opposite the ends of the rail owing to the gas supply having previously been run; then the necessary length of rail can be made up by extending right and left of the two down-rods. This will add to the appearance of the rail, especially if finished off with ornamental turned ends or by fixing the extra light at the extreme ends. This method answers quite well and effectively, but it is not advisable to extend the rail more than will just carry one heavy body and light, which may be fixed between the end of rail and down-rod, or, as stated above, at the extreme end. The lights are set vertically on the rail or taken therefrom by horizontal or curved rail-brackets, according to the tastes of the customer. For good brass rails, cup and ball-joints should be employed under the ceiling plates.

A second and cheap form of this rail is made up of  $\frac{3}{4}$  in. to 2 in. diameter wrought iron tube, and is found in drapers' and boot and oil shops. The size of the tube depends upon the use the rails are going to be put to besides carrying the lights, and the weight they have to support, since in these shops they are useful as a means of exposing articles for sale. In these cases the lights are few and far between; and as the gas will be conveyed to the burners by these pipes every care must be taken with the joints in order that they may be free from leakage. Use the paint mixture freely and screw the various connections tight home. If the weight they have to support be rather heavy, see that the down-rods are securely fixed to stout bridge-wood between the joists; and when these rails are long and continuous they should be supported at every 7 ft. run of rail. The gas

need not be supplied to every down-rod when this means of support only is adopted, but alternate will suffice—capping the pipe above the bridge-wood—since the rail will be of greater cubic capacity than is needed to adequately supply the number of burners on it. In this class of work it is best to dispense with the cup and ball joint, the rail being fixed and left stiff.

The pipes should be cleaned and freed from dirt, then coated with a suitable enamel, according to the class of business ; as, for an oil shop rail, red enamel ; for a boot shop, black enamel ; and for a draper's rail, which would be of lighter construction, a light blue green or brown. Finished in this way the rails have a much more pleasing result. Brass tube is occasionally used, but it is a needless expense and not so strong as iron tube, although polished brass looks well when new. The position of these rails remains with the shopkeeper, for it depends upon the magnitude of the business done as well as the tastes of the individual to be considered. In one shop the rail is fixed between the counters, while in another shop a rail is formed nearly over the centre of each counter. The height is usually one of general convenience, *i.e.*,  $6\frac{1}{2}$  ft. from the floor. The third form of rail is one used by provision merchants and others who expose their commodities outside and, in fact, seem to transact nearly all the business on the pavement. This class of rail, without exception, is always of iron barrel, sometimes fixed stiff at right angles to the building, from one side of the window to the other, or in a similar position, but using a strong pendant top, placed sideways at each end, the nuts facing each other so that the rail may be pulled up when not in use for lighting, and when in use it is kept and supported in a horizontal position by fixing a chain to the fascia-board and looping the other

end round the centre of the rail. A third way, occasionally approved of by shopkeepers, is to fix to each side of the window a lamp-top with a fly-nut, somewhat similar to Fig. 76. The plugs are removed and screwed on to the rail arms; this done, the rail is lifted up and dropped into one of the lamp-tops already fixed in position, the other being temporarily fixed, without strain on any part, in a horizontal line with the first. This can be best judged by looking at it from a distance, since to measure up the wall often causes the rail to be out of the horizontal and consequently unsightly. Lift the rail off to see that it will go into the sockets easily again, then securely screw up both tops, adding the fly-nuts. Should the rail be long use a

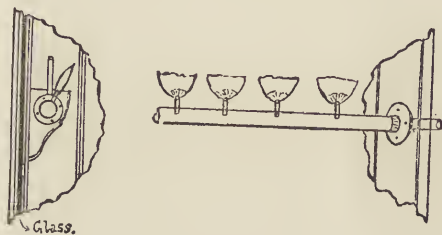

FIG. 78.

chain or rod to support it in the centre. This rail can now be easily removed and taken in at closing time.

A very effective rail is one placed inside the window, rather more than halfway up the pane and four inches from it. The burners are screwed directly into the iron pipe at distances of from 4 in. to 6 in., and at an angle of 25 degs. to 30 degs. from the vertical. Fig. 78 shows the arrangement and methods of fixing.

However, in all these three ways the gas is manipulated from inside the shop. Iron burners are used for outside

rails by drilling and tapping holes at spaces of from 2 in. to 6 in. apart along the rail. Bray's and other makers' better class burners will not stand rough usage; besides, they may be out in all weathers when fitted to the rail, and experience teaches that when the cotton gauze gets wet the burners fail to act. But while slit iron burners rust and require repeated clearing by passing through the slit stout note paper or fine watch spring, as well as giving a poor light efficiency for the quantity of gas burnt, they withstand a fair amount of rough usage, and for this reason are principally employed. Bray's burners will answer all right if the gauze be first removed ere fixing, as the tips are not subject to weather corrosion, but care must be

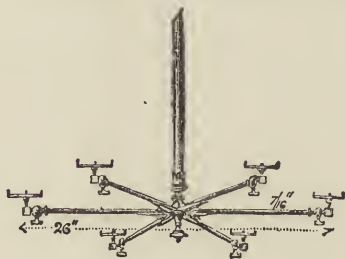

FIG. 79.

exercised not to knock them in the daily handling of the portable rail. No method of rail lighting is economical, for the illuminating value per cubic foot of gas is scarcely two candles, a very poor return nowadays for the quantity of gas consumed.

The general method of lighting the interior of shops is by 2 to 6-light pendants (Fig. 79), star burners, and occasionally by regenerative lamps. The pendants are placed in the centre of small shops and in rows down between two counters, or one row over each counter in large shops. The method of fixing has been dealt with in

a previous chapter; mention here need only be made of the fact that tested cup and ball joints, first taken to pieces and well greased with tallow, must be always employed, as this allows of the pendants being set in any position to the counter, while should anything strike them they will yield to the shock. Star-lights (Fig. 80) are fixed the same as pendants.

To fix counter pillars use a brace and bit to bore a hole in the counter to allow the plate to be sunk level with the top, the gas supply screwing into plate under

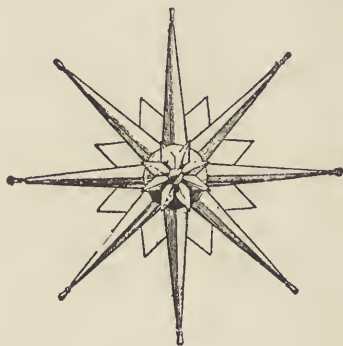
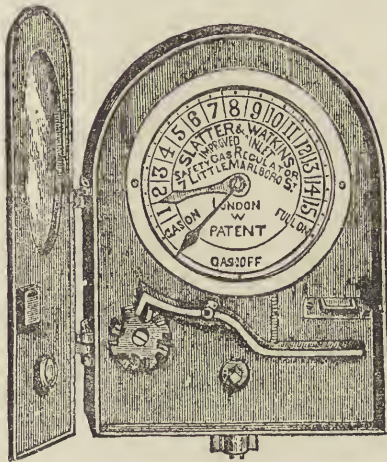

FIG. 80.

the counter. The plate is fixed by screws to the counter, and the pillar screwed into the plate, using a leather washer to ensure the joint being gas-tight.

Shopkeepers as a whole complain of their large gas bills, and a convenient way to reduce these is to reduce the pressure, and consequently the quantity, of gas passing through the meter. High pressures on ordinary burners do not increase the light to anything like the proportion one generally imagines, but, on the contrary, reduce the efficiency of the burners. It is this which causes the consumers to complain that the illuminating

power is worse than formerly, while the consumption has, according to meter, increased in spite of the fact that no extra burners have been used. This pressure can soon sweep away a reduction in the price per 1,000 cubic feet of gas, and cause the bill to be as large as formerly when the price was possibly 3d. per 1,000 cubic ft. more. The gas companies are not to blame, the remedy lies in the consumer's hands—reduce the pressure at the inlet or



INLET SAFETY DOUBLE CHECK GAS REGULATOR.

FIG. 81.

outlet of meter. Too little is equally as bad as too much pressure, and for this reason the controlling authorities compel the gas companies to supply gas under adequate water pressure. Some people think that gas companies give with the one hand and take back with the other in such preponderance over the giving as to nullify entirely the benefits of the gift of a reduction in price. This is quite a mistake. However, many shopkeepers go to the

expense of from £3 10s. to £6 10s., according to the size of the so-called improved inlet double check gas regulator they adopt. These are made by Messrs. Slatter and Watkins, and by Messrs. Carnaby and Co. All these apparatus pretend to do is to check, not govern, the quantity of gas entering the meter, and therefore the full control of the gas throughout the building is not achieved. Any alteration in the initial pressure at once affects the quantity of gas passing the inlet cock; but this they do accomplish, they remove the bulk of the pressure so long as sufficient burners take away all the gas passing. When the burners fail to do this comfortably (7-10ths pressure), pressure accumulates on the outlet, and augmented consumption follows. They offer great convenience in that they can be fixed in any position of the shop, so that it is no trouble to turn the

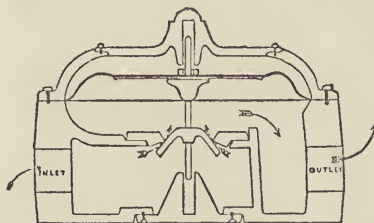

SECTION OF GOVERNOR.

FIG. 82.

key for more or less gas, and in this lies the double check.

This dial, shown open, Fig. 81, is put in communication with the inlet cock of meter by means of cords fastened to a lever fixed on the cock, so that by turning the key the cord is wound up and released at one and the same time, according to which way it is turned. Slatter's regulator has a stop action fitted inside, consisting of a lever acting on a notched wheel by which



the consumer can prevent employées turning on more gas than is allowed by means of the key. There is a broad shaded hand to indicate to what extent the tap can be turned, and it is impossible to wind the black hand past this amount ; herein lies the primary check.

Now by means of a good governor fixed on the outlet of meter there can be no such variation in the consumption due to augmented pressure in the main service. They can be set to any pressure which can be altered at will. One thing governors must be fixed quite level or they are liable to work unsteadily.

Fletcher's governors, Fig. 82, are fitted with gland screws, which renders the task of fixing a very simple one. They cost less than half the price of the aforesaid regulators, and are made to take the usual sizes of iron pipe.

## CHAPTER XIII.

## GAS-FITTINGS FOR SCHOOLS.

THIS is a subject which has not been thoroughly worked out, for in practice various methods prevail, some of which give most unsatisfactory results. In dealing with a subject like this, the gas-fitter is seldom, if ever, consulted as to the method of lighting, but simply called in to develop the scheme of the architect. Also, there are many kinds of schools which may be divided into four distinct groups: (1) those under State or Public control, as Board Schools and Poor Law Institutions; (2) boarding schools and colleges for the three classes of community throughout the country, generally controlled by an elected body of governors; (3) technical day and evening institutions, as polytechnics, controlled by both private and public educational committees; and (4) private schools and colleges under the control of the proprietors or teachers. Much attention is now paid to the health of the scholars or students attending the schools coming under the first three groups by the Education Department of the Privy Council and the other minor authorities; but there is no control other than a purely sanitary one, similar to that affecting ordinary dwellings over private schools.

There are other defects in schools besides the lighting arrangements, but the gas-fitter need only study the number of lights and how best to distribute them in the interests of efficiency and economy. Before going into the actual

fitting of the pipes, it will be as well to consider the requirements of the Education Department of the Privy Council in relation to the size of the schoolrooms and the arrangement of the desks, because these materially influence the mode of lighting. The rooms require to be 18 ft. to 22 ft. wide, and it is stated that if the width does not exceed 20 ft., the desks must be long and to form three or four in a group. If the room be 22 ft. wide, then dual desks, with 18 in. gangways between the groups. When dual desks are used, they being 40 in. long, then the space between them for gangways need only be 16 in.

Schoolrooms vary in height from 9 ft. to 14 ft., but there is not much advantage to be gained by exceeding 12 ft. Considering that the schools are used in the evening as well as in the daytime the question of ventilation and heating must be considered. In lighting schools by gas the air is not only warmed but rendered more impure by the products resulting from its combustion, unless there is proper means of ventilation. A cubic foot of coal gas yields on combustion in the ordinary way half its own volume of carbon dioxide, besides varying quantities of sulphur-dioxide and watery vapour, depending upon the quality and purity of the gas and the kind of burner employed. Cubic space, then, is of great importance, and so far as board schools are concerned the regulation minimum allowance is 80 cubic feet per head, corresponding to nearly 8 square feet of floor area per child. This is a very low standard, and requires that the air must be changed constantly in order to maintain it in a state of purity, without at the same time causing draughts or a lowering of the temperature. Schoolrooms should have 200 cubic feet for each child, and for each lad in a public school 400 cubic feet, but the usual

cubic space provided is 130 cubic feet, with a floor area corresponding to 10 square feet per head.

The lighting of schools is of the greatest importance. In the daytime the glass of the window, exposed to the open sky, should be at least equal to one-ninth of the floor area, and certainly not a fifth or a sixth as advocated by some writers, under which conditions the rooms would be difficult, if not impossible, to keep warm. Now the light entering windows of this size is equal to 4 to 5 candles at one foot, but this is too high a standard to attain by artificial lighting, besides, it is more than required for schools and lecture theatres, let alone the cost. A room is considered well lighted when there are no shadows or rays of light to dazzle the eyes. A useful rule arrived at from practical observation is to allow one candle for every three square feet of floor area. This is sufficient for all schoolroom purposes, and for most large rooms where the walls are of a light colour and not much more than 12 ft. high. Should the lecture rooms be high and somewhat dark allow one candle for every  $2\frac{3}{4}$  square feet of floor area. As previously referred to in an earlier chapter, the colour of the walls has much to do with the illuminating effect, but in schools the colour is nearly always the same, and consequently need not affect the rule as applied to schools. The latest up-to-date school has the inside walls of white glazed bricks. This is the best possible, though somewhat costly, but in the long run does not appear so, since there is no white or ochre washing of the walls, simply a sponge down and they are as clean as on the first day. They have another advantage, in that the amount of light lost on ordinary walls is here reflected back into the room, giving a good effect.

The systems of lighting suitable for schools can

be classified as (*a*) one direct source of light ; (*b*) many direct lights distributed about the room ; (*c*) bracket or lateral lights ; and (*d*) indirect illumination.

As to (*a*) system, briefly, it is not to be recommended for schools, since it is most unsuitable for reading and writing, as the shadows are unpleasant and troublesome and the illumination is not uniform. The burner has to be high up to avoid the radiant heat affecting the children's heads, and even then the wall maps are badly lighted. (*b*) This system is by far the most general method of lighting schools, which has been done by fixing indiscriminately pendant lights of various sizes. But there seems to be no definite rule to guide one in coming to a decision, for much depends on the height of the room, the number and position of the gas flames and the colour of the walls. Many eminent men, as Siemens and Varrentrapp, have investigated the subject, and each recommended a different number of lights to so many scholars on forms. It is now a very costly method. By the use of regenerative burners a much better effect is obtained at less cost. (*c*) Single bracket lights are often used for lofty rooms or for rooms having a gallery, in which case they are usually best fixed at distances round it, thus lighting both the centre and under the gallery. The great objection to this method is that many of the lights interfere with one's view of an object in the distance, and doubly so if the source of light is a powerful one. There is still much to be learnt about this system. The chief point should be to keep the light high up and allow all direct light to travel unchecked into the room, but guide or reflect into space that light from the flame which is nearly all lost on the wall. (*d*) This is the best way to illuminate any room, especially a large one, for every part of it seems to get an equal amount of light.

One great advantage of reflected light is that shadows are practically nil. Persons accustomed to naked flames in a particular room, and then seeing the effect by diffused light, can scarcely realize the result, for it is so pleasing, though at first strange to the eyes; yet how comfortable! This comfortable sensation is remarkable, and all because the direct rays of light have been altered into indirect and with a corresponding reduction of shadows. This method of lighting is not sufficiently patent, but it will be generally adopted ere long. The advantage to children lies in the fact that they can see maps and experimental data on the board without interference from bright rays of light. Besides these benefits, there is the cost to the public to consider, which, in this case, is about  $\frac{1}{3}$  to  $\frac{1}{2}$  of that incurred by direct flat-flame lighting.

The running of the main service is the same as for other buildings, and also the fixing of the meter. The meter is best enclosed by a cupboard, and the various cocks, especially if grouped together by a "lever-board." In one or two cases it has been thought best to have a little place built, entirely away (near the gate) from the main building, in which to fix the meter, so that the gas can be shut off after locking up. The outlet service is then run underground to the school, all branching-off being done inside as needed.

For school-rooms then, fix only 2-light pendants fitted with Welsbach incandescent burners, having milk-white eye screens, as the Cosmos or the Boston fitting, which includes reflecting shade, eye screen and support, costing 3s. each, retail. When incandescent burners are not desired, the ordinary flat flames should be screened with *reflecting globes*. These latter increase the illumination of a room 30 to 50 per cent. as compared with the use of ordinary globes. To

be economical, yet efficient, incandescent burners should be governed at the burners and not anywhere else. By so doing the pressure will be equalised throughout the building. The type of governor known as Borradaile's is a good one for this purpose, and not liable to get out of order. They should be bought adjusted to pass  $3\frac{1}{2}$  cubic feet of gas per hour under 1 in. of pressure.

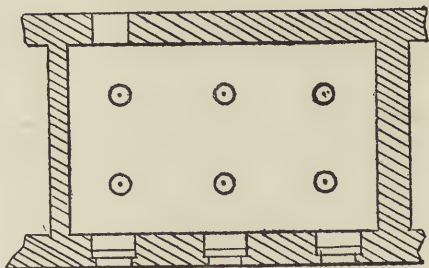

FIG. 83.

Supposing a room 36 ft. long  $\times$  22. ft. wide  $\times$  12 ft. high required lighting. First find the area of the floor,  $36 \times 22 = 792$  square feet, and according to the rule given above we require  $\frac{792}{3 \times 40} = 6\frac{1}{2}$  Welsbach chimney burners. The six lights should be arranged as per illustration, Fig. 83.

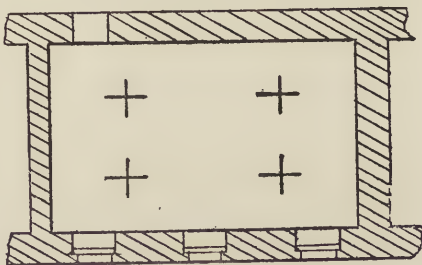

FIG. 84.

They will emit a normal lighting value of 240 candles for the consumption of 21.6 cubic ft. of gas per hour. If,

however, ordinary flat-flame burners had to be fixed, the number would be  $\frac{792}{50} = 16$  consuming 5 ft. per hour, or yielding 160 candles from the consumption of 80 cubic

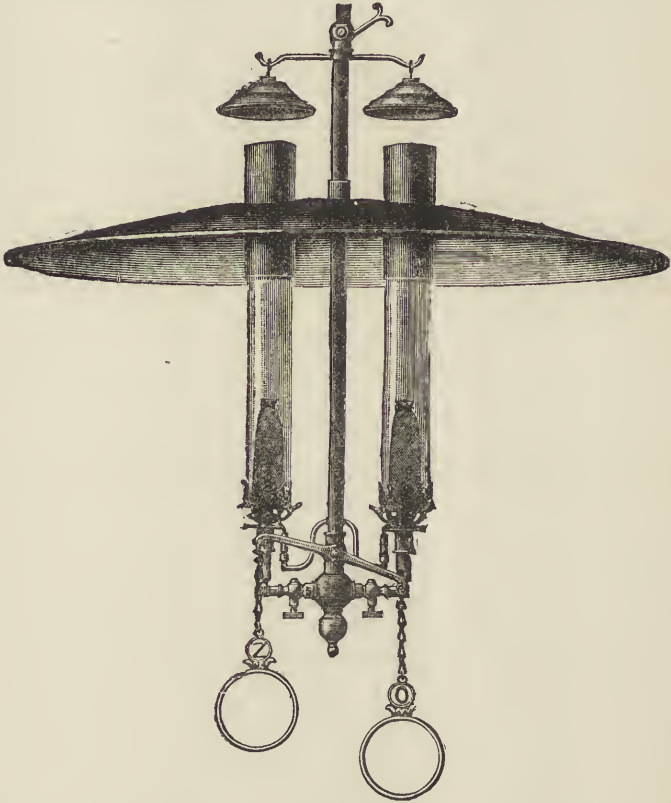

FIG. 85.

feet of 16-candle gas per hour. Four 4-light pendants should be fixed in the position shown in plan by Fig. 84.

The difference in the cost of the two systems is very marked and greatly in favour of the incandescent light



by 58 cubic feet per hour, and an increase of light equal to at least 80 candles.

The rule applied in the second case is the area in square feet divided by 50 which gives the necessary

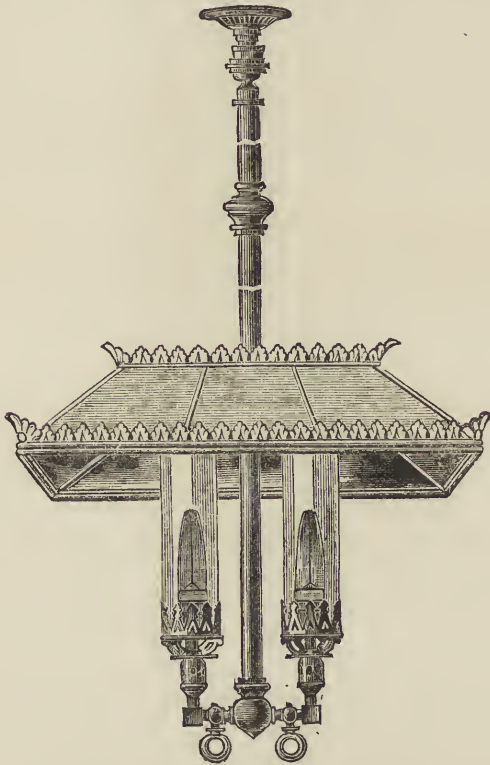

FIG. 86.

number of flat flame burners consuming 5 cubic feet of gas per hour for ordinary lighting.

Taking a modern board school which may have class-rooms on each side of a general hall, the lighting can be effectively done by using reflecting pendants carrying

two or more Welsbach burners, as in Figs. 85 or 86. The hall being 70 ft. long by 21 ft. wide, it would require, according to the rule given, twelve incandescent burners to properly light it, if the walls were coloured by ochre; but when the walls are of white glazed bricks a large amount of light is saved by reflection, so that ten burners will be found enough, if they are equally set apart down the centre of the hall, using only 2-light incandescent pendants similar to the pattern illustrated. Where the inside walls of any building are of white glazed bricks it will be quite safe to alter the rule given to 4 square feet of floor area per candle. The lights must be fixed 9 ft. to 10 ft. from the floor, and each pendant provided with a cup and ball joint.

For the small class-rooms, having ochre-washed walls, the size being, say, 24 ft. long by 20 ft. wide, we would require

$$\frac{\text{area}}{\text{constants } 3 \times 40} = \frac{480}{3 \times 40} = \frac{12}{3} = 4 \text{ incandescent burners,}$$

which can be fixed on to two 2-light pendants in such positions as will equally divide the room, as in the centre of each half of room, Fig. 84, which is between the plan of pendants shown. The pendants which give great satisfaction are of the pattern represented by Fig. 87, but the burners to be provided with milk white eye-screens, thus securing indirect lighting.

The services are run to the several floors and rooms during the building of the school, which greatly assists the gas-fitter in making good fixtures. The many different ways of constructing the roofs and floors of schools somewhat varies the method of running and fixing the gas pipes. Schools with only one floor have either couple close roofs, collar beam roofs, king post roofs, or composite roofs of wood and iron. In the first mentioned the pipes should

run across the ceiling joists, and the branches therefrom  
dropped down through the ceiling by the side of a joist, if a

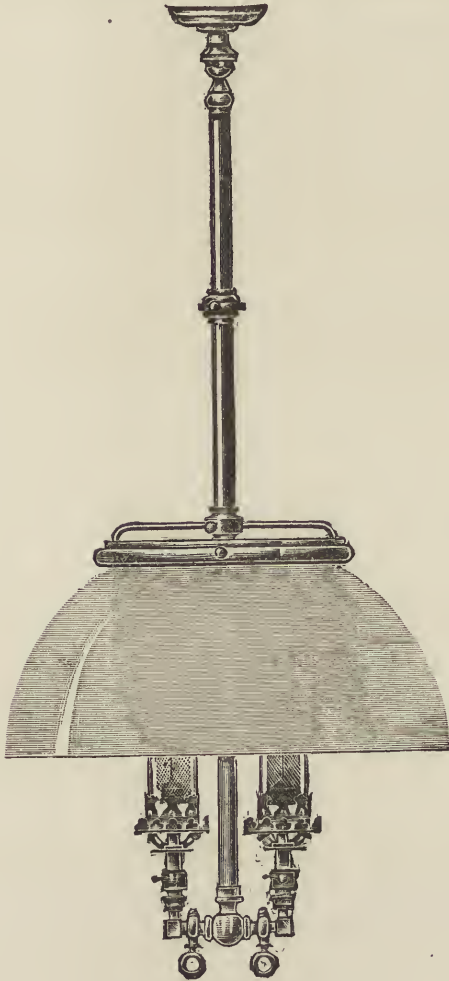

FIG. 87.

bridge-wood be not needed on account of the position of

the lights ; but where the latter is not used, see that the pipe is fixed by a hook or clip to the joist to prevent side swing, and immediately under ceiling fix a cup and ball joint. The bridge-wood is really not needed as a support when the pipes run at right angles to the joists, but is used simply to prevent side swing when the drop from a tee-piece comes between the joists. The collar beam roof in the case of schools or chapels is generally matchboarded and varnished. The pipes are run above the collar, which latter is a support for the rafters, and to carry a ceiling if necessary. This form of roof has the advantage of adding height to the room below, and when boarded and varnished is a fairly good reflector of light.

A gimlet is passed up through the boards directly over the desired positions the lights have to occupy. Holes, equal to the size of the pipe that has to pass through them, are then bored through these places. They should not be excessively large as they become unsightly and of no support to the down-pipe. In all cases of wooden roofs when the supply is run out of sight, the holes through which branches or pendant rods go, should be cleanly bored and of the right size. Composite roofs are now more common, the ties of trusses being usually of wrought iron, because of its tensile strength as compared with timber, and besides, they are of less weight. When so constructed they seldom carry a ceiling, but are left "open," consequently all pipes are visible and fixed along the roof from collar to collar, or from tie-rod to tie-rod as the case may be, the pipe being painted the same colour as the other ironwork. In consequence of the long stretch between the supports the pipe has to be of a larger size than is necessary to supply the lights with gas in order to prevent sagging. For this reason then, the supply-pipe is often run along the roof near the feet of the

rafters, and by means of a tee-piece put in the supply, a service is run along the tie-beam or rod to where the drop-down is wanted, screwing thereon a round elbow. Careful fixing at this point by means of a clip is absolutely necessary.

Schools with two or three floors require the same treatment, as it only necessitates the use of tee-pieces in the rising-main service for the separate floors. The construction of the second and third floors, which also forms a ceiling for the first and second respectively, affects the method greatly. Floors and ceiling of wood and plaster need no description; but many of the modern schools and factories have fireproof floors or nearly so, by being constructed of steel girders and binders, having concrete laid with

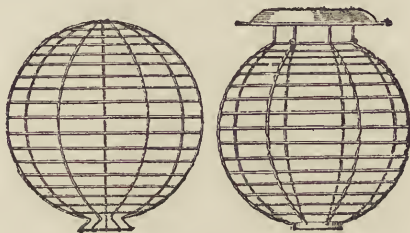

FIG. 88.

pitch-pine wood blocks. The girders, which are often framed, give the ceiling a panelled appearance. On these girders the gas-pipes are slung and fixed by clips and set screws. Each pipe is fitted with an elbow and ball joint. In the central hall the lights would form a line down the centre, one pipe from each girder if required serving the two lights. The class-rooms are similarly treated, except that each room should have a bye-pass cock fixed at 6 ft. from the floor, in the corner where the pipe rises, so that the gas can be shut off when the room is not in use or has been cleaned. The object of the bye-pass is to allow

a little gas to pass to supply the incandescent burners. The buildings being high the pressure of gas is augmented in the top rooms, causing more gas to pass through the bye-pass, and this—unless checked by the adjusting screws on burners—often amounts to such quantities as will blacken the mantles, the black deposit being carbon, the result of incomplete combustion. The rooms are supplied with two or four incandescent burners or their equivalent in flat flame burners.

Cloak rooms and lavatories on each floor require two guarded, 5 ft. per hour, flat flame lights; for this purpose run  $\frac{1}{4}$  in. iron pipe. Each set of stairs must be lighted by placing one light at the top, one at every alternate landing, and one at the bottom. These lights are supplied by  $\frac{1}{4}$  in. iron pipe taken from a  $\frac{1}{2}$  in. rising pipe, which latter also supplies the cloak rooms situated near the stairs on each floor. The lights must be guarded by wire globes, to screw on elbow, and with or without tin tops, as shown in Fig. 88, depending upon whether the flames are near woodwork above.

The upper and lower teachers' rooms must also be provided for by running a supply from the above service or from the nearest class-room.

The stop-tap fixed in the rooms must be supplied with a chained key, or as some prefer, one T-key for each floor kept in a convenient place, but out of the reach of the children. This and all other keys and taps should not be placed higher than 6 ft. from the floor, as this is quite high enough to be out of reach of children yet within reach of adults.

## CHAPTER XIV.

THE LIGHTING OF CHURCHES AND OTHER BUILDINGS  
DEVOTED TO RELIGIOUS PURPOSES.

THE architecture of churches calls for more decoration in gas-fittings than is deemed necessary for chapels, and while art metal-work is considered proper for decorating gas-fittings that are used in ecclesiastical work, so much of it is not so essential when incandescent lighting is adopted, as the latter fittings have in themselves a more pleasing appearance. Churches vary greatly in their architectural design, partly on account of their importance as to whether they are abbeys, parish or relief churches.

The choice of gas-fittings for any particular edifice should be influenced by the surroundings, adopting only those which harmonise and lend themselves to the beautifying of the place. Some do not consider economy or comfort when deciding upon the method of illumination for places of worship, only the number of lights to be distributed according to the area of the floor; consequently some of the congregation have to put up with the full glare of the lights, which in reality places the preacher in partial obscurity so far as they are concerned. Most people know how difficult it is to see in the dark when a candle or light is carried in front of one, but when it is raised above the head the light does not impede the vision, and the place seems better illuminated. Things are always seen to more advantage and with greater ease when the source of illumination is hidden from the eyes. One of the most common defects in churches and chapels lies in the

location of the light or lights for the pulpit or rostrum. Frequently the preacher is seen with difficulty, or he is uncomfortable because he cannot see the congregation well, and handicapped because he cannot impress his sermon by gesture owing to the position of the lights.

Incandescent lighting has considerably altered the old style of gas-fittings and usual method of arranging them in churches, but for all this many clergymen prefer the flat-flame lighting, since it has the advantage of causing less trouble. The adoption of Welsbach lighting in churches, especially if placed high up, as the pendants should be, causes a good deal of trouble in keeping clean and are rather costly on account of the maintenance of chimneys. By employing the new burner no chimney is required.

The usual church fittings comprise pillars fixed on the pews, standards fixed to the floor, pendant, corona and bracket lights. There are a few churches with rows of jets, similar to those used for illumination purposes, placed above the arches or round the columns. This method only lends itself to large buildings, and then the illumination is obtained at great cost, although the plan is considered by many to offer particular advantages for lighting sacred edifices because of the many flames having a decorative effect.

The fixing of the meter is in a corner near to where the supply will enter the building, sometimes in a cupboard, or left exposed. If the meter be conveniently situated a distributing tee, with two or three outlets, may be fixed on the outlet of the meter, one to supply the rows of pendant or corona lights on each side of the nave or middle aisle, and one for the brackets and other lights in the chancel. Instead of a distributing tee being fixed, simply put in tee-pieces at the most convenient places, as if the meter be near the side entrance (chancel side of wall),



put in a tee to supply the chancel, then run below the floor to the corner of the side aisle, putting in a tee to supply that side of the church, continuing with the same size pipe right across the floor to the opposite corner, rising by means of a round elbow to about 18 in. above the floor level. Screw on a reducing tee, having  $\frac{1}{2}$  in. centre to supply the bracket lights in the side aisle or under the gallery. Galleries are not generally placed in modern churches, but where they exist bracket and pillar lights are most usually employed. Assuming that the aforesaid service is  $1\frac{1}{2}$  in. in diameter, on which  $1\frac{1}{2}$  in.  $\times$   $\frac{1}{2}$  in. diminishing tee has been screwed, continue the  $1\frac{1}{2}$  in. supply by adding a 4 ft. length, then screw on a Carter's valve, Fig. 89, fitted with  $\frac{3}{8}$  in. bye-pass, so that the lights on the

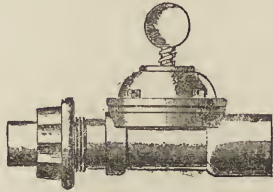

FIG. 89.

middle aisle may be reduced during the sermon or when required. The supply is run up the corner of the wall, and by means of round elbows, bends, or sets, work close round the beam of the roof, finally penetrating a hole cut through the brickwork of the party wall above the arches. Here screw on a diminishing elbow or tee-piece  $1\frac{1}{2}$  in.  $\times$  1 in., continuing with a 1 in. pipe along the top of the set-off course of masonry above the arches, inserting immediately over the centres of the arches a 1 in.  $\times$   $\frac{1}{2}$  in. reducing tee-piece, the  $\frac{1}{2}$  in. opening facing the other side of the aisle. For the last pendant supply screw on an elbow. The 1 in. pipe

must be fixed to the wall with hooks at intervals of about every 4ft., seeing that one is fixed close up to each tee-piece. The pendant is hung from a suspension bracket, which must be carefully fixed by plugging the brickwork or masonry. In cutting the holes avoid larger than will be covered by the bracket arms, the ends of which are ornamented by being curved round, or somewhat as in Fig. 90, which represents one form of suspension bracket suitable for connecting to a supply coming through the wall.

Be particular to notice that the depth of the brackets are alike, otherwise the down-rods of the pendants will



FIG. 90.

not be in a line. From the tee-piece screw a short length of pipe to a little beyond the eye in the bracket and drop down by means of a round elbow, then a further short piece, to which connect a cup and ball joint, having previously examined it for soundness. From the ball joint continue with one long pipe to the pendant or corona, which should be 10 ft. to 14 ft. from the floor, according to the height of the church. When the pendant is not fitted with a lever tap having ring ends, one must be put in

the down-rod about 2 ft. above the lights. Deal similarly with all the others, taking care to have the lights at one height, and central so far as the arches are concerned, and that all joints are well painted and screwed tightly home. The pendant should not have less than four arms, each provided with tripod burners similar to one of the patterns shown in Fig. 91.

The side aisle should be fitted up by screwing into the tee a 4 in.  $\times$   $\frac{1}{2}$  in. short-piece, then an elbow looking down, to which connect a  $\frac{1}{2}$  in. Carter's valve, not necessarily with a union, but fitted as



FIG. 91.

before, with a bye-pass. Now continue directly down with  $\frac{1}{2}$  in. pipe, using a bend at the bottom, from which run the supply under the floor down the side of the aisle, inserting a  $\frac{1}{2}$  in. by  $\frac{1}{4}$  in. tee opposite to where a bracket is to be fixed, which should be between the windows. From the tee-pieces run up on the face of the wall  $\frac{1}{4}$  in. iron pipe to the height of the bracket, namely,  $6\frac{1}{2}$  ft. from the floor. Should two tripod lights be required, a  $\frac{1}{4}$  in. tee piece must be screwed on the rising pipe, from which 8 in. short-pieces, each provided with an elbow are fixed. Into the elbows screw specially bent 9 in. pieces, to form the brackets for the burners. Taps are fixed either on each

bracket or only one on the rising pipe, in which case it would be a female tap with a short wire lever, and not a thumb and finger top to the plug of the tap, as it is seldom used. The whole of the brackets are similarly made up, using ornamental iron clips to set the work off, unless art metal, single or double-arm brackets are desired, as in Fig. 92. The whole of the side lights are manipulated by the Carter valves and bye-passes, all other taps being left on unless incandescent burners are used, when it will be found best to use the individual taps, there being no real necessity for turning down the lights owing to the economy of these burners. In fact, this is really a drawback to the incandescent system, that the light cannot be so easily

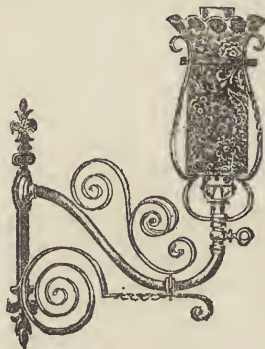

FIG. 92.

reduced to meet the requirements of a church. Of course the valves can be closed a little, and this will remove the bulk of the pressure and curtail consumption of gas. The opposite side of the church is fitted up in like manner, except that the pulpit light must be provided for by running a  $\frac{1}{4}$  in. service from the  $1\frac{1}{2}$  in. pipe between the Carter's valve and the tee-piece, so that there will be no reducing of these lights when the others are checked. There

seems no decided rule about the side or position of the pulpit. In one church it is on the left and in another on the right-hand side, more often on the latter side of the middle aisle. The supply then would be taken from the corner near by and run up the columns usually abutting the pulpit, and fixed so that the rays of light come as it were over the left-hand shoulder. When no such column exists then the next best plan is to suspend the light from above, or fix it to the side of the gallery, if such there be. Avoid fixing directly on the pulpit, thus allowing nothing to be

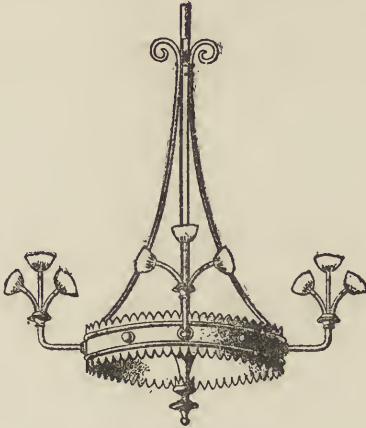

FIG. 93.

in the way of the many preachers who in time will occupy this position, each having a more or less different style of delivery. If the pipe has to be fixed to the pulpit keep it out of sight as much as possible. One incandescent light or a tripod flat-flame light is ample for the purpose of illuminating the pulpit reading-desk.

In lighting the chancel the same means of illumination should be adopted as in the aisles, consequently a tee-piece

instead of an elbow fitting would be screwed on to the pipe projecting through the party-wall above the arches. Should the set-off course of masonry be continuous the fitting would be precisely similar to that already described for the middle aisle. This will furnish the chancel, but where on each side of it there is a chapel, wall brackets will also be necessary. These are supplied by running a separate supply from the meter, unless the whole of the chancel is supplied from a distinct service to that which supplies the body of the church; but in such a case this means running supplies four times up the walls and roof instead of twice. When, however, each rising pipe supplies the whole of the pendant lights on a particular side of the church, the chapel bracket lights are best supplied from a separate branch service, which can also supply the organist and the vestry. The porch and gate-pillar lights are supplied from a branch off the most convenient service.

Pendant and corona lights vary greatly in their decorative design, but one which finds general favour is illustrated by Fig. 93. Halliday's "Clapton" gas lights are suitable for plain lighting, and will stand rough usage. On this account they are more suitable for the adjoining school or hall.

Should standard lights be adopted they must be securely fixed to the floor by screws. The supply is run down the church, screwing on tee-pieces immediately opposite the centre of the archways with suitable short lengths of  $\frac{1}{2}$  in. pipe branching off to a point which is under the centre of the archway, the position the standard should occupy. A good type of standard is represented by Fig. 94. It is not too elaborate but pleasingly decorative. Although this method of lighting finds most favour in Catholic churches it does not find favour as a

means of decorative illumination, because of the low position of the lights.



FIG. 94.

Pillar lights have similar objections, and are not recommended for churches, but are more often used in

chapels for the illumination of the rostrum and reading desk. For the latter position a good design is represented by Fig. 95. They are occasionally useful in positions where no other fittings will answer because of the difficulty of fixing them in the desired place. When used in the body of a building they are fixed to the ends of the pews, the

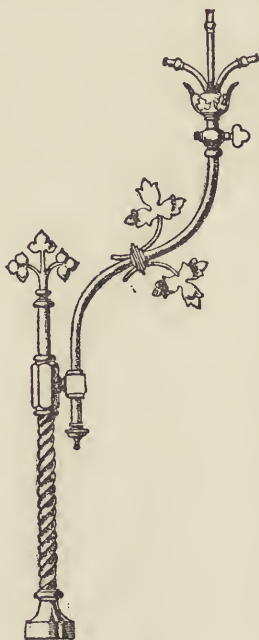

FIG. 95.

iron supply-pipe being secured by brass-clips and screws to the end of the seat.

The same applies to the fitting-up of chapels as to churches; they can only be described in a very general way, as each place requires a somewhat different treatment, depending upon the nature of the building. Consequently



a model plan of running the pipes cannot be given that would meet the requirements of all chapels. One has to judge of the course of the pipes from the position the meter will occupy, and as the latter is scarcely ever fixed in the

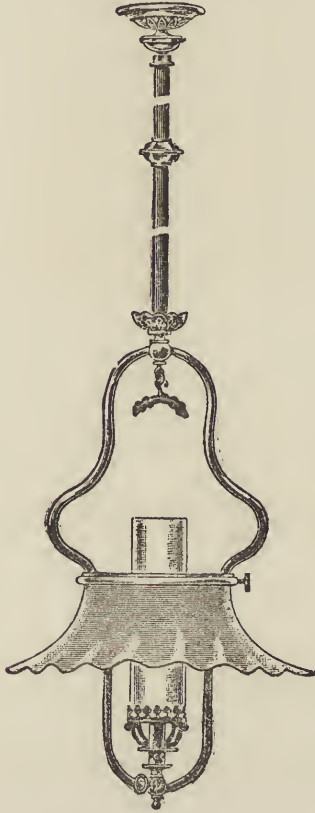

FIG. 96.

same position, the actual method of branching from the outlet of the meter must vary with local conditions.

In fitting up chapels, less expensive fittings are used.

For one thing, chapels are not as a rule very ecclesiastical in appearance, being more of the type of a school-room, and, as such, decorative pendants would not harmonise with the surroundings; but attractive pendants may do much to relieve the bareness of a chapel. Star-lights and from 2 to 6-light pendants are most generally employed to illuminate chapels. A cheap form of pendant can be built up of  $\frac{1}{2}$  in. wrought-iron pipe, fitted here and there with brass set-offs, as a means of ornamentation. The actual fitting of the parts together has already been treated upon in a previous chapter. The pipes should be enamelled or painted light blue colour, which colour will also suit for the tie-rods of the roof.

The most modern way of lighting chapels is by incandescent gas lighting, and for this purpose it is better to have proper fittings than to fit the burners on 2-light pendants. A good effect is obtained by substituting single or double incandescent pendants, of which there are many designs more or less elaborately got up. A serviceable pattern is illustrated by Fig. 96, and can be obtained for the small sum of 9s. to 12s. 6d., including shade. The shades and eye screens vary in price, depending on shape and whether they are etched and of aurora or other colour-tinted glass. This method of lighting is of the best, and the lamps should be so distributed that the supplies will drop from the tie-rods of the roof with as little conspicuousness as possible.

The greatest difficulty the gas-fitter has to contend with is the location of the lights and the number of burners, of whatever kind, with which the pendants should be fitted. There is an old rule for finding the number of burners of a given size for public buildings, and the same holds good for churches and sacred edifices, but the

question of their distribution has to be solved in most cases by a knowledge of the building and local circumstances. The rule is, find the area of the floor in square feet and divide by 50 for ordinary coal gas ranging in quality from 14 to 17 candles, or by 70 for cannel or oil gas.

Example —A chapel is 50 ft. long  $\times$  30 ft. wide  $\times$  20 ft. high, what number of burners are required to efficiently light it? Then  $50 \times 30 = 1,500$  square feet = area.  
 $\frac{1,500}{50} = 30$  flat-flame burners consuming 5 cubic feet of gas per hour.

This would require five 6-light pendants or six 5-light pendants, each fitted with 5 ft. per hour regulator burners, such as Peeble's or Hawkins and Barton's governor burners.

These burners cost very little more than ordinary Bray burners, and have the advantage that they are economical, and under no conditions do they "whistle" when subjected to heavy pressure, a feature of the non-regulator burner, which is most objectionable in a place of worship. The next best burner is Bray's adjustable, which is really two burners, the upper one being placed over the other, a No. 0 or 1 ordinary union-jet gas burner. The under burner will only allow a certain quantity of gas to pass, and removes the bulk of the pressure from the actual point of ignition—which is the upper burner, a No. 5 or 6—consequently the gas issues from this burner under a more feeble pressure, and so the gas is burnt to a very much better advantage, giving as it does three times the amount of light without increased consumption of gas. Having fitted the governor burners, which will consume 150 cubic feet of gas per hour, and giving a light very little more than  $2\frac{1}{4}$  candles per

cubic foot of gas, the total illumination will not be over 338 candles.

The position of the pendants should be midway between the halves of the sides of the chapel, with one in the middle as per sketch I. or as per sketch II. The pendants should be hung 9 ft. to 10 ft. from the floor, depending upon the height of the chapel, in order that there may be no interference or dazzling of the eyes.



I.

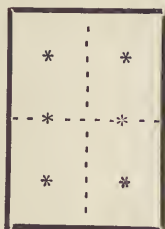

II.

If Welsbach incandescent burners are desired, then use the rule previously given for schools, that is, allow one candle for every 3 square feet of floor area. The normal candle power of a mantle may be taken as emitting 40 candles. For the chapel in question there would be required

$$\frac{\text{area}}{\text{constants } 3 \times 40} = \frac{1,500}{3 \times 40} = 12\frac{1}{2}$$
 Welsbach burners. Then five 2-light pendants, and one or two brackets or pillars for the rostrum should be fixed as in sketch I., unless single incandescent pendants are wanted to take their place, in which case regard must be had to the existing supplies. The light would be equal to 480 candles, with a gas consumption of 43 cubic feet. Fix to all the burners a regulator, so that the quantity of gas will not be more than will pass at 1 in. to  $1\frac{1}{4}$  in. pressure. This is the cause of many gas bills being as high as for ordinary

lighting, since the burners are used where the pressure exists greater than 1 in., but is in reality often 3 in. to 4 in.

The consumption of gas increases with the pressure, as will be seen by the results obtained by a standard experimental meter.

Pressure of gas in inches.	Gas consumed by Welsbach burner in cubic feet per hour.	Candle power per foot of gas.
1	3'55	17'50
1½	4'30	16'49
2	5'20	14'00
2½	5'85	—
3	6'20	—
3½	6'80	—
4	7'20	—

When the mantle is on the burner its brilliancy prevents the detection of an excessive gas consumption. To be strictly economical, the pressure should not exceed 1½ in., and any increase in consumption over this amount reduces the lighting efficiency of the burner.

Comparative continual cost.—In the first case 150 cubic feet of gas are consumed per hour, and emitting not more than 338 candles. In the second case 43 cubic feet are consumed, or a saving of 107 cubic feet of gas per hour, as well as a gain of 142 candles in illumination. To this must be added a little for chimney breakages and renewals of mantles, which latter should not amount to a mantle per burner per year. A much greater economy is shown when the building is a large one, but the extra trouble entailed in looking after the fittings (especially if high up), as chimneys and mantles, must also be thought of, and charged against the lighting.

## CHAPTER XV.

GAS RANGES, COOKING STOVES, AND WATER  
HEATERS.

THE great demand now-a-days for gas heating appliances of every description for domestic and other uses is one to be encouraged. Firstly, because gaseous fuel is half the cost of coal for cooking purposes and heating water; and secondly, it is much cleaner; and thirdly, the gas is more convenient, ever ready, and the heat under complete control.

Under the heading "gas fires," the different kinds of heat have been described, while for heating vessels containing water or liquids, the plan adopted is to allow the Bunsen flames to play upon them, but for roasting as in an oven, the heat from the gas should be converted into radiant heat as far as possible by being first absorbed by the sides and top of the stoves and then radiated into the oven. This is the object aimed at in all good ranges and ovens, securing a uniform heating of the joint or other dish without risk of burning one side more than another.

The calorific value of coal gas is dependent upon its composition or quality. The heating value of London gas depends upon the percentage of oil gas it contains, but it may be taken as falling between 145 to 160 calories per cubic foot of gas.

The British Thermal Unit (heat unit) is that quantity of heat which will raise one pound of water at or about freezing point 1 deg. Fahr. A more correct unit is the calorie, which is based on the amount of heat required

to raise 1 kilogramme of water from 0 deg. to 1 deg. C., and is equal to 3.9683 British Thermal Units. Coal gas *per se* has rather more than twice the heating value of water gas, but if the latter be carburetted with oil, then the value more closely agrees with that of coal gas. Illuminating gas requires 7 to 14 volumes of air to 1 of gas to complete combustion, whereas producer gas only requires approximately  $1\frac{1}{2}$  volumes of air to 1 of the gas.

The method by which gas is burnt for the development of heat in most ranges is on the Bunsen principle. This comprises the use of gas in admixture with about 75 per cent. of air, and when consumed ensures complete combustion. The mixing of the gas and air is brought about by the burner itself, and the quantity of air drawn in is dependent upon the pressure of the gas issuing from the small hole at the base of the Bunsen tube, which latter has one or more holes in it for the admission of air. This mixture of gas and air when lighted burns with a non-luminous flame, and the products of combustion should consist solely of water vapour, carbonic acid and a little sulphur di-oxide. When complete combustion takes place there is no unpleasant smell of "burnt" gas, but should the air be insufficient then carbon-monoxide, a virulent poisonous gas, is liberated. According to Professor V. B. Lewes, carbon-monoxide should not exceed 0.05 per cent. by volume in the air we breathe, and he gives this figure as the margin of safety for human life. Under all ordinary circumstances it would be difficult to get so large a percentage in a bedroom where the gas had been accidentally turned on and when the door of the room was not actually shut. But the greatest difficulty with gas cooking stoves lies in another direction. The unpleasant smells given off from many stoves is the result of gas

lighting back and burning at the orifice from which the gas issues. The air is limited at this point, and so combustion is imperfect, producing thereby acetylene with its characteristic odour. This, however, is not always the cause of smells from gas cooking stoves. A frequent cause of bad odours, besides the gas lighting back, arises from the deflecting frets getting too close to or actually into the flames, and consequently liberating acetylene, &c. This too close contact with the frets or any vessel to be heated so lowers the temperature of the flames that the air cannot complete combustion, and so fails to heat as economically as otherwise would be the case. The little blue flames must only play upon the under surfaces of the plates or frets. Again, nasty smells may arise from dirty stoves where the grease and fat have accumulated, or it may be due to the oven, the flue of which does not act, and so carbonic acid, &c., are confined in it, preventing ingress of good air, and this would give trouble.

The greatest difficulty a gas-fitter has to contend with is the construction of a satisfactory flue to carry away the products of combustion. He has always two things to remember. 1. That a hole cut in a wall of a house independent of its position, always allows a strong current of air inwards especially when the doors are shut. 2. That this is caused by the difference of temperature as between inside and outside, and the chimney communicating with the room having a draught upwards, and so the air that is drawn up must come from somewhere, and naturally it comes from the place of least resistance.

Another cause is that often the ventilating arrangement is defective, for it has been found that frequently a flue, run direct into the open air, acts as a fresh-air inlet on account of the "pull" or draught of the chimneys



overcoming the ascensive power of the fumes from the stove. Concentric tubes of suitable size have sometimes to be used to overcome the cooling of the real flue. Occasionally we come across flues which will not act well until they get warm, then they give no trouble; and when a cooker is connected to such a flue it becomes a nuisance every time it is lighted. A conical cap—single or double—may often be resorted to with advantage. If the draught cannot be set up in this way, the best plan is to run the flue into an existing chimney (if available), taking the precaution to see that there is a primary supply of air to feed the burners when the door and windows are shut. Eddying winds greatly affect chimneys in some houses. Should the existing flue leading from a gas stove be liable to sudden puffs of down-draught, this can usually be stopped by fitting into the top of the chimney-pot a sort of wire basket containing coke. This greatly breaks up sudden gusts of wind tending to go downwards, besides keeping the flue warmer, and so aiding the upward draught. The coke would soon get choked up if smoke from the combustion of coal were allowed to pass up the chimney. The best way is to place the stove in position and try it with a candle, and if it burns steadily when the door is shut and when open, the flue acts properly. Inlet ventilators are always useful, but whether placed near the floor or boxed over so that the air shall enter at 4 ft. to 5 ft. above the floor level must be determined by local conditions. In any case they should be fitted with a slide or flap, in order to close them when required.

The fixing of gas ranges, as illustrated by Fig. 97, is by no means difficult; care should be taken to use the same size of supply as that fitted to the range, and

that there is an up-draught in the flue. These ranges vary in size from 3 ft. to 5 ft. wide by 4 ft. or more high, and are admirably suited for large houses, residential flats or hospitals. Their great feature is compactness, yet complete as a cooking stove. Combination coal and gas

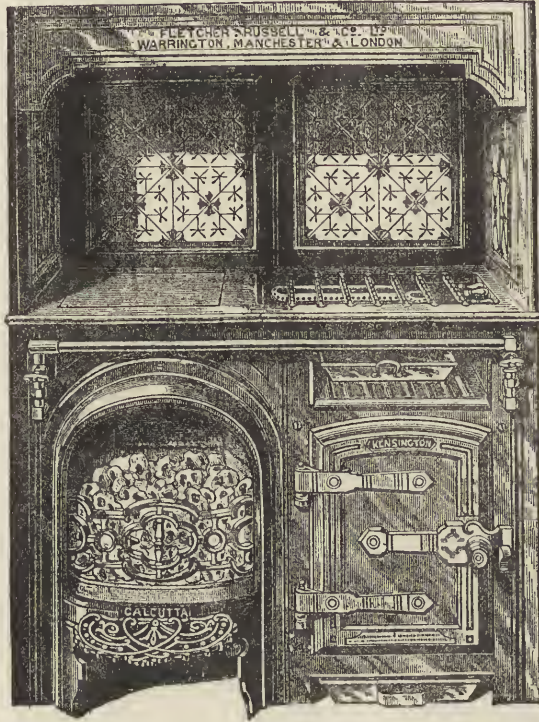

FIG. 97.

ranges are also made on this principle as they do not need building in the fireplace. They are really tenants' fixtures. The parts are interchangeable, and should any part get damaged it can be replaced from stock. Fletcher's "Connaught" range is a treble cooker, and is similar

in many respects to Richmond's "Holborn" range, which is composed of two ranges the same size, with one of larger or smaller dimensions in the centre. When fixing these cookers it is necessary to run a separate service from the meter to ensure a good supply of gas; and in some cases it is desirable to fix a pass-meter to register the quantity of gas used for cooking purposes only. Many consumers consider this necessary in order to check the cost of lighting, as compared with that for

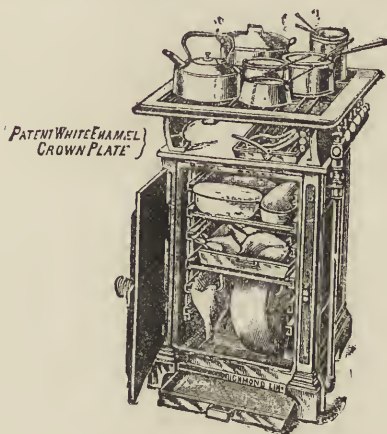

FIG. 98.

cooking. All the gas passes through the principal meter, and that registered by the pass-meter, deducted from the quantity that has passed into the house, gives the lighting consumption.

Of the smaller cookers in general demand, the "Model" gas range, Fig. 98, is a good pattern of what a gas cooker should be. The body and hot plate are made of cast-iron, and the oven is lined with strong enamelled steel plates. The jet and tap are combined,

which is convenient, as the jet can be adjusted without in any way interfering with the burner. The taps are screwed into a cast-iron cored gas bar, having a flat top, which gives them a good depth of thread and a solid seat. Everything is of good material, which denotes durability. In point of cleanliness there is little to be desired, for all the top burners are removable without interfering with the taps, and the oven burners are only fastened with two screws. This is a great feature and one not to be lost sight of when cleanliness has to be considered.

The white enamelled crown plate is also a great advantage owing to the facility with which grease and dirt dropped from the hot plate can be removed, giving the range a very polished appearance. The interior of the oven being enamelled materially assists towards keeping it clean, and, in fact, the whole thing has been designed to give the least amount of trouble with the greatest amount of satisfaction as regards cleanliness. So that it may be an economical cooker, the case of the oven is packed with slag wool or some silicate to prevent loss of heat. The top of the oven is fitted with a fire-brick tile, and the waste heat is caused to pass under and over it, thus economising heat, and what heat is lost is only that necessary to dispel the products of combustion and to ensure ventilation, equal to a change of air once in two or three minutes at a temperature above 300 degs. Fahr. The flue damper should be carefully managed, as in the best gas cookers which turn out good work the ventilation is sufficient for double the consumption for everything except perhaps roasting. By keeping the ventilator always open—and this is often done—more gas is consumed, which, although trifling per day, mounts up

at the end of the year. Good results are obtained, but at greater cost than is really necessary. Economy is the result of care and attention being paid to the regulation of the damper ventilator.

Cookers of this description are well finished and will stand the wear of a lifetime. The best makers guarantee all materials and workmanship, and every care has been taken to make the ranges as complete and perfect as possible to meet the requirements of the highest class of cookery.

There are very many types of gas cookers made by many firms, and which cannot be described in detail. The apparatus is usually easily supplied with gas the only difficulty being the abatement of smells. The repairing of stoves simply resolves itself into one of taking the burners out and thoroughly cleaning them. This is simple enough when the burners are removable, but in the older patterns of cooking stoves where they are fixed, a good deal of time is taken up in taking the stove to pieces. For this purpose the gas-fitter, when employed on gas stove work, will require in his bag such tools as are detailed further on.

Boilers are either made of galvanised iron with a small ring burner, or of copper tinned inside with pure grain tin and fitted with special safety Bunsen burners. The copper heaters are the most efficient and durable. Some are fitted with conical tubes up which the flame and hot gases pass, being thus conveyed right through the body of water, and so giving good results. Boilers attached to gas cookers are not so satisfactory as those specially constructed to rapidly heat water.

The multitubular rapid boiler is one of the best, and has the advantage that the tubes are not small and liable to be choked up with scale, but are easily kept clean. The

"A" size, although not the most rapid boiler, is a specially good one, and will boil one gallon of water of average temperature in four minutes with day pressure of gas. The hot water is pure, and in no way contaminated with the products of combustion. The boiler is fitted with pilot tap and self-lighting burners, with a  $\frac{1}{2}$  in. gas supply. There is no risk of an explosion, as the gas cannot be turned on and lighted unless the pilot burner has previously been lighted, since by turning on the gas tap, the pilot light is turned into position as well as closing the opening to prevent a taper being used.

Next are good water heaters for rapidly providing hot water for baths and other domestic purposes. These

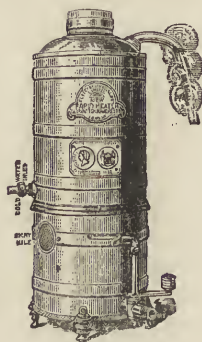

FIG. 99.

heaters are not intended to boil the water, but simply to deliver water at a temperature which may be described as scalding hot. That is, one to two gallons of hot water may be delivered per minute at a temperature of from 110 degs. to 170 degs. Fahr., according to the rate of flow of cold water. The new rapid heater, Fig. 99, has several good features. There is no risk of explosions, and when fitted with a safety water tap the risk of damage by the gas

being lighted before the water is turned on is prevented, as the gas and water taps are connected in such a way that it is impossible to light the gas without first turning the water tap on. The water tap should be connected to the low pressure water service. The water passes over a very large heating surface of well-tinned copper, so that only pure water is delivered.

No rapid heater can safely be used in a small room as they consume a fair quantity of gas in a short time, and unless connected with an efficient flue to convey away the products of combustion they are liable to vitiate the atmospheric air, and so render it unfit to breathe. In a bath-room having no chimney the door should be left open while the geyser or other form of heater is at work, and the gas should be turned out before shutting the door. When there is a chimney leading from the room see that it has a good draught, or the obnoxious gases from the flue will not be carried away but escape into the room, rendering the flue connection not only useless but dangerous. It matters not what form of burner is used to heat the water, whether a luminous or a Bunsen burner, the products resulting from the perfect combustion of the gas are practically the same. The duty from the luminous burners is less, and so to maintain the same efficiency as the Bunsen type more gas has to be consumed, which also means a greater proportion of harmful gases per unit of water heated, besides the possibility of smoking flames. If a flue must be fixed in a room where no chimney exists, the metal flue should be taken straight through the wall, and not provided with any outside elbows or flue piping. An air inlet or air brick must be fixed not many inches below, so that the winds will have the same balanced effect on both the air inlet and the exit flue. To ensure this the

heater must be cased in, but provided with a door to light the burners. The outlet spout of the water heater must not be fitted with a tap or other obstruction. The relative position of the water inlet and outlet must be stated when ordering, as they are not movable and cannot be altered. The gas supply also varies with the size of the heater from  $\frac{1}{2}$  in. to  $\frac{3}{4}$  in. pipe.

The heaters are most easily kept clean and can be obtained in bright copper, nickelled or enamelled copper, the last named requiring no cleaning.

An exceedingly useful water heater is the horizontal pattern, Fig. 100, which represents the single form. The

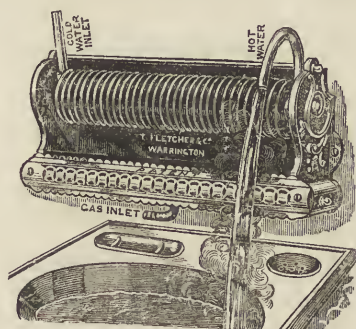

FIG. 100.

heat is conducted to the water by allowing the gas flames to impinge upon solid webs threaded along the water pipe; and so efficient is it, that, with a constant quantity of gas, the water may be raised to any temperature to almost boiling point by merely adjusting the flow of water. The heater is small, being only 14 in. wide by 6 in. high, and is suitable for fixing over lavatory basins without being in one's way. It will deliver a quart of water per minute, raised in temperature from 60 degs. to 130 degs. Fahr., with a gas consumption of 4-10ths of a foot. There is



no drip when the water supply is fitted with a good tap and connection made either permanently with metal pipe or a short piece of thick walled rubber tubing. Should there be an unpleasant smell, it indicates an excessive gas consumption beyond what it is intended to burn. This, however, is readily prevented by checking the quantity of gas. This heater is exceedingly simple to fix, only requiring two screws to fasten it to the wall, and when once in position it gives no trouble, unless the water be very hard and is always made very hot, when in time the pipe gets furred up, as indicated by very little water running out at the spout. This is best cleared by disconnecting the water supply, then slipping a piece of flexible tubing over the inlet pipe. In the other end of the tubing insert the neck of a funnel and pour into the latter a little strong hydrochloric acid, keeping the funnel high up. Now add a little water in order to force the whole of the acid into the metal pipe. In the meantime the acid will run frothing out at the spout, showing that the carbonaceous deposit is being

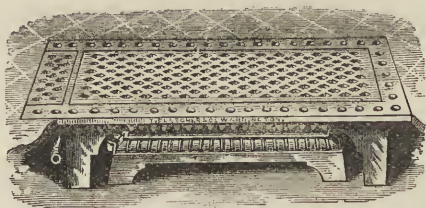

FIG. 101.

dissolved. Repeat until the water runs freely and at full bore. This apparatus is specially useful in all places where a little hot water is required at a moment's notice and without inconvenience.

Fig. 101 represents an exceedingly useful foot stove and cooker, as it is useful for cooking simple things, such as

bacon, chops and the like in a tin on the top of the stove. Water can also be boiled on the burner by removing or lifting the top. For outdoor offices too small for an ordinary fire it will prove useful for not only warming the room, but warming food in the daytime. It is, however, more useful and efficient when placed about the floor of large and lofty buildings, such as halls and churches, as it specially lends itself to the warming of large areas. They are not recommended for low and badly-ventilated places. For every 120 ft. of floor area one small foot stove (14 in. x 7 in.) should be used. A larger size (24 in. x 7 in.) will meet the requirements for every 180 square feet of floor surface, in such places as are difficult to heat by any other means. When used as a chancel stove, a floor box, with perforated cast-iron grid top, can be placed over it, as illustrated, and enables it to be fixed in passage ways. The box being only 30 in. long by 12 in. wide and 6 in. deep over all makes it very convenient for fixing flush with the floor of temporary iron churches, halls, or schoolrooms. One is sufficient for a church 60 ft. by 30 ft. by 25 ft. high. Other forms of tops, also guards, are made. The gas connection is very simple.

There is a great demand for portable gas cooking and boiling burners during the warm season of the year, and brief reference will only be made of the most salient points of them, passing on to a description of how best to supply them with gas.

Of the former class, Fig. 102, represents a simple but handy stove, specially useful in the summer time when coal fires are insufferably unpleasant to work by, besides, no cooking can be done by them without considerably augmenting the temperature of the apartment. By means of this gas grill a breakfast, tea, or, at a push, a dinner,

is most easily and more economically prepared than by coal since as soon as the water boils or the steak cooked, the gas is turned out and the heat almost at once removed. This is a great advantage in the hot weather. Some patterns of this stove have doors and with straight burners made to rotate through half a circle so that the flames can be brought in close contact with the underside of the frets, which radiate the heat down upon the viands to be cooked.

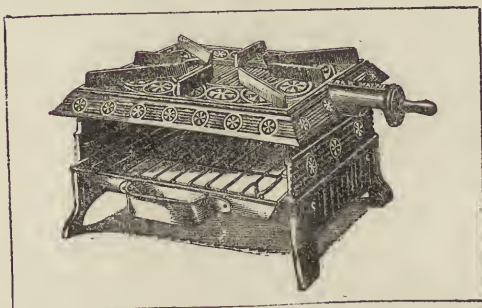

FIG. 102.

These burners are pierced with holes, and when of the straight tube pattern they are not so frugal in point of gas consumption as the oval form illustrated, unless the vessels to be placed on the top are made square, so that the whole of the flames have work to do. They are strong and neatly made of cast iron to stand rough usage. A loose oven can be obtained for use with this pattern, and when this is used the flames must be deflected downwards and should not rise straight up into the oven. It will then be found that very little gas is required to roast or bake, and will prove—where the gas per 1,000 cubic feet is reasonable—very much cheaper than coal and giving less trouble.

Boiling burners vary greatly in shape, appearance and

efficiency, and can be divided into four types. Firstly, burners having gauze through which the gas issues at the point of ignition producing a solid Bunsen flame. Secondly, those having a series of holes or jets in the body of the burner. Thirdly, those having radial slots through which the gas issues ; and, fourthly, the argand burner having an annular space for the gas to pass through so that air can enter the centre of the burner. Those of the first kind are very efficient, and when fitted with nickel gauze are practically indestructible. These burners are carefully constructed to comply with Fletcher's laws ruling the construction of heating burners to give the highest power which it is possible to obtain from using gas in this way.

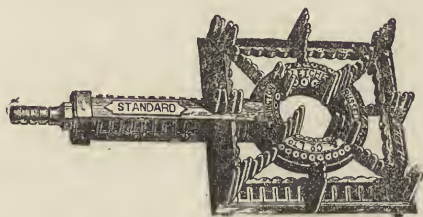

FIG. 103.

Under the second kind come the most generally sold and used, because they are cheaper and have a support for vessels which is broad, strong, and steady, and suitable for carrying all sizes of vessels. Those of the Standard type are of the most perfect kind made for boiling water or for other domestic purposes. They are to be had porcelain enamelled, also fitted with an automatic arrangement to nearly extinguish the gas when the vessel is removed and to again turn on the gas when re-placed on the burner. One of the latest forms is the square Standard burner, Fig. 103, which meets a demand for a good burner with a

square stand. The No. 15 size consumes 15 cubic feet per hour and costs 3s. The same burner, like many others, can be supplied porcelain enamelled or in solid brass. The third kind are made in one casting, plain or porcelain enamelled, and although useful for boiling water on, are

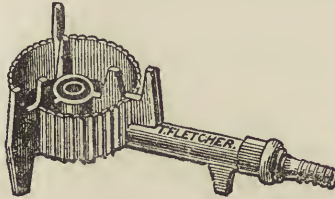

FIG. 104.

specially made to heat smoothing and hatter's irons, also for general workshop use. The fourth kind, as illustrated by Fig. 104, is specially useful for boiling a kettle of water. It is a cheap, simple and everlasting burner. The air supply is self-adjusting, and as the  $\frac{1}{2}$  in. size only consumes about 6 cubic feet of gas per hour, there is no smell unless this is greatly exceeded; while the flame is shorter, more compact and higher in temperature than the ordinary Bunsen.

There is only one more useful domestic article we

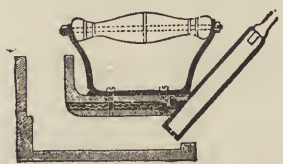

FIG. 105.

must touch upon, and that is the internally heated smoothing-iron. Fig. 105 shows one in section. This form of iron enables the work to be executed in much less time and with great economy, since the iron can be

maintained at an even temperature without fear of becoming too cold before a garment is completely ironed. This is a great boon to the laundry-maid. With this iron there is no standing about waiting for the irons to get hot, no fires to keep up, and no hot and unhealthy ironing room, as it gives off no smell.

A ready means of conveying gas to all such portable gas appliances is very desirable, and whatever method is adopted it must be gas-tight and free from being easily rendered objectionable by leakage or permanent damage. When special backs for flexible tubing are not to be fixed, and there happens to be an ordinary wall bracket near to where the article is to be used, a supply is best taken

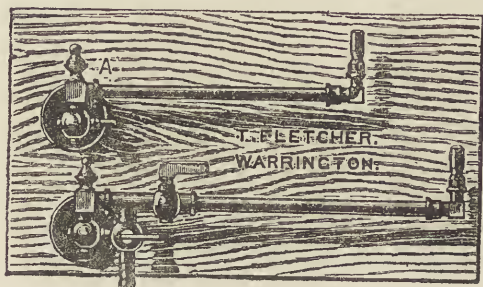

FIG. 106.

from the bracket by unscrewing the bracket-arm out of the swing-joint and inserting a special tee fitted with two taps, as illustrated by Fig. 106. When such good work is not desired the gas-fitter can fit to a suitable tee-piece two male and female taps, and then, by a nipple-piece, connect the tee with swing-joint. Assuming that the wall bracket is not in a desirable position, then take down the bracket, and instead of the elbow behind the wooden block insert a tee-piece, continuing the service by screwing into the

throughway of the tee-piece a suitable piece of piping. The block is replaced after making the slight alteration in it to allow the downward pipe to pass. If the pipe has not to be buried in the wall, as no doubt the supply to the bracket is, the piece of piping should be bent to come out from behind the block, so that the "setting" just lies flush with the wall. This extension pipe should not be less than the size of the permanent supply, in fact it would be all the better for being one size larger, unless a preliminary trial by connecting the burner to permanent supply showed that there was sufficient gas for the purpose required. This determined, continue the service on the face of the wall, securing it neatly with hooks or clips and finishing with a suitable tap to which the flexible tubing is connected. Special cheap brackets are now on the market fitted with gas supply-taps before or after the swing-joint.

A gas supply can also be easily taken from a centre fitting, but in doing this avoid taking the supply from near the end of an arm, or the appearance of the gas-alier may be spoiled. A simple way is by using the patent gas joint for making a quick and gas-tight connection to an ordinary burner when only a small ring burner has to be supplied. It is very good for temporary use.

As regards flexible tubing there are at least four distinct kinds, and each claims special notice. First, the common wired grey india-rubber tubing. This is not to be recommended as it soon cracks, and although it does not exactly leak, gives off a bad gassy odour. In making the connections with it an inch or so of the coiled wire must be drawn out, and when the tube is slipped over the burner nozzle it should be bound with wire, as this rubber very soon loses its elastic power to hold on. The second kind is of better quality india-rubber, and coloured black or

red, and made without a seam. This is a most convenient flexible tube, and although it costs a little more at first, it keeps good a long time. Connections with this tubing seem in time to grow to the metal or wooden nozzle to which it may be slipped over. It does not readily perish, and should it become hardened and not so springy as when new, by simply immersing in scalding water for a few seconds it is restored to its original softness. The greatest drawback to this tubing is its liability to kink, but otherwise it is most useful.

The third kind of flexible tubing is the "Atlantic" gas tubing. This tubing is thoroughly reliable, and very little dearer in price than the last mentioned tubing. It is perfectly gas-tight, fairly flexible, and will not kink, owing to coiled wire, and being braided in a variety of colours has a



FIG. 107.

more superior appearance than the ordinary make of tubing. The prevailing colours are plain green, maroon, or green and black striped. The connection is a patent rubber connection, which can be made in a few seconds, or with  $\frac{3}{8}$  in. brass ends, as illustrated by Fig. 107. It can be supplied in any lengths of from 4ft. to 12ft. at so much per foot above 4ft.

The last flexible tube is a metallic one, made in many sizes of bronze and steel. Fig. 108 shows steel No. 1 for gas and speaking tubes. No. 2 is of stouter make for compressed air, oils, water, &c. The bronze tape is specially made for high pressure steam.

The tube for gas, &c., is very effective, and the



connections are comparatively very light and simple. The "Push-on" connection is simply a brass cap fitted with ordinary rubber, and is very easily fixed to the tubing. They should be put on with tyre cement, to be obtained from all cycle makers or of the Company. These "Push-ons" are kept in sizes,  $\frac{1}{4}$  in.,  $\frac{5}{16}$  in., and  $\frac{3}{8}$  in. The

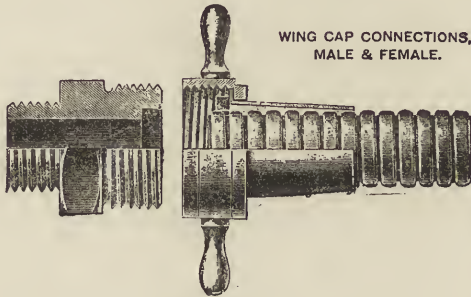

FIG. 108.

"Wing cap" and "Hexagon" connections, male and female, are better, and directions for making them are sent with the flexible metallic tubing.

This form of tubing has many advantages, but it will not stand much strain, for it has a tendency to distort the coils, and thereby destroys the value of the tubing. The coils are sandwiched with rubber, and are perfectly gas-tight. The tubing is manufactured by the Flexible Metallic Tubing Co., Greenwich.

Tools required by gas-fitter when engaged on stove work :—

Tongs: Old fashioned  $\frac{1}{8}$  in.,  $\frac{1}{4}$  in.,  $\frac{3}{8}$  in.,  $\frac{1}{2}$  in.,  $\frac{3}{4}$  in., and 1 in., or Clarke's patent shifting tongs, sizes No. 1 and 2, which taper from  $\frac{1}{2}$  in. to 1 in. Sometimes larger tongs are required varying  $1\frac{1}{4}$  in. to 2 in.

Pliers: Two pairs of two-hole pliers, two pairs of

meter pliers which will take from 3-light to a 50-light meter union.

Spanners: One shifting spanner, one long spanner for back-nuts attached to boiler taps.

Chisels: Two flat pointed iron chisels, one about 6in. and the other about 15in. long. One cross-cut chisel for splitting sockets. Two wood chisels  $\frac{1}{2}$ in. and 1in. Two wood gouges  $\frac{3}{8}$ in. and  $\frac{3}{4}$ in.

Files: One half-round, about 10in. long; one round, about the same length.

Shears: One pair for sheet iron.

Pipe Cutters: One pair to cut from  $\frac{1}{4}$ in. to 1in. pipes. These should be 3 wheel cutters—which enable the cutting of pipes against walls for the insertion of tee-pieces.

Tan-pins: One small, one large.

Blow-pipes: One small, one large, and blow-pipe solder about 1lb.

Bundle of Rushes: One tin case to contain blow-pipe, rushes and solder, with tin box at bottom for resin.

One divided tin box, with lid, for white lead and tallow.

One small can with lid for lead paint, for painting the threads of pipes; one small paint brush.

One set of small broaches with handle for cleaning the gas ways of the air chambers. Stocks and Dies: Two sets taking from  $\frac{1}{8}$ in. to 1in pipe.

Taps: One  $\frac{1}{8}$ in. taper, one  $\frac{1}{8}$ in. plug, one  $\frac{1}{4}$ in. taper, one  $\frac{1}{4}$ in. plug.

Punches: One nail punch, one small punch for sheet iron.

Saws: One key-hole saw, one pad saw for cutting through joists.

One small vice, or "Samson," as it is sometimes called, for holding the pipes.

Screw Drivers : One small and one large.

Bradawls : One small and one large.

Gimlets : One small and one large.

Hand-brace with three drills, rimer and wood bits.

Augers from  $\frac{3}{8}$  in. to  $1\frac{1}{2}$  in. size.

## CHAPTER XVI.

## GAS BURNERS.

FLAT-FLAME burners first claim attention on account of the fact that they form the majority of all gas burners in general use, and also because they are of simple construction and not readily put out of order by fair use. The bulk of the gas supplied throughout England ranges in quality between 14 and 18 candles, as tested at 5 cubic feet per hour. In Scotland the quality of the gas is much richer, ranging between 24 and 28 candles. This difference in the illuminating power of the gas as supplied to the public in England and Scotland necessitates the use of varying sizes of burners and not always of the same type.

We have so often reiterated the importance of consuming gas for illuminating purposes under low pressure, especially necessary for luminous flames, although this may be somewhat inconvenient to users of gas for heating and power purposes, that to speak of it again seems needless; but considering the number and variety of gas burners in use it behoves one to mention that every illuminating burner efficiency is dependent upon the pressure of the gas supplied to the burner. Each burner must be supplied with a particular quantity of gas at a suitable pressure for itself, otherwise it will not be an efficient burner but a more or less wasteful one. That is to say, the highest illuminating value of a gas is only developed from flat-flamed burners by maintaining the proper proportion between the gas and air supply. Too

little air supplied to the flame renders combustion imperfect, and consequently less heat is developed, with the result that all the carbon particles are not raised to full incandescence, the flame emitting less light and some of the carbon escaping as smoke.

If too much air reaches the flame, as is the case when high-pressure gas issues from a jet, currents of air are induced over and above that required to just burn the gas without smoke, tending thereby to cool and produce a non-luminous flame. The gas must issue quietly and without rush from the burner in order to get the greatest illuminosity. The burner tip should be made of some non-conducting material, as lava, enamel or steatite, which are non-conductors of heat. Steatite is a natural stone which after firing is harder than steel, incorrodible and practically indestructible. Iron is commonly used for making burners, but this material conducts away a large proportion of the heat developed by the flame, which rapidly radiates to the detriment of the light. There is no real method of regulating the amount of air to flat-flame burners other than to state that the size and angle of the apertures determine a certain amount of air, providing the pressure of the gas remains constant. A poor quality (16-candle) gas requires for perfect combustion much less air than a rich gas, and so when the former is consumed by flat-flame burners the holes have to be fairly large or the burner slit wider than for 20-candle gas, which latter necessitates the use of burners having smaller orifices, whereby the force of the gas is increased, thus bringing about a greater induced current of air to complete combustion. For by altering the angle at which the two orifices of a union-jet burner are placed, they more or less flatten out the flame; and so, by inducing a larger or smaller quantity

of air, the conditions are obtained for getting perfect combustion with various grades of gas. Therefore, the richer the gas the more obtuse must be the angle formed by the two orifices; while for low quality gas the more acute the angle in order to get good results.

In order to obtain good flat flame burners the orifices for the egress of the gas should be perfectly regular in size, and sufficiently large so as to permit the gas to issue with very feeble pressure or force. Generally speaking, and based upon experimental evidence, from five to seven-tenths pressure gives the best results.

Flat flame burners may be divided into three classes:



UNION JET.

Screwed for Globe-Holders.



UNION-JET.

FIG. 109.

the union-jet or fish-tail, the batwing, and a combination of these burners, as the slit-union, which is rather similar in appearance to the batwing. The union-jet, Fig. 109, is simply a brass cased burner, the jet of which is, in the case of Bray's, made of enamel. This material does not corrode like iron, and is not combustible, at the same time it is harder and less brittle than steatite. Two orifices are drilled at an angle somewhat greater than 45 degs. in the material, the diameter of which depends upon the size of the jet burner and the quality of the gas to be

consumed. They are made in sizes from No. 00000 to 9, each burner value depending on the quality and pressure of the gas supplied to it. The inclination of the holes in the jet varies according to the quality of the gas, in order that the two streams of gas shall impinge against each other at such a point as will give a suitable spread of flame at convenient pressure. This burner is not an economical one for common gas. When adapted and used for very rich gas it proves itself to be one of the most efficient. However, as a class, they are poor light-giving burners, especially when they consume less than 4 cubic feet per hour. This is the more marked the lower the size of the burner, unless the pressure at which the gas is supplied to it is governed, and the particular burner suited to the quality of the gas. They, however, lend themselves for gasaliers and such places when globes



BATSWING.

FIG. 110.

are to be used, as they do not produce a ragged flame like the flame of the batwing burner, the "horny" ends of which soon crack the globes. The efficiency of these ungoverned burners is from  $1\frac{1}{2}$  to  $2\frac{1}{2}$  candles per foot of gas consumed.

The batwing burner, Fig. 110, lends itself to public

lighting, and is more efficient for this purpose. They require a little less pressure than the union-jet type in order to get the most out of them. This type of burner is also used as a standard burner for testing cannel gas of between 18 to 30 candle-power, for which purpose a special burner is prescribed. The slit in the top of the burner must be uniform in width, otherwise the flame will not be regular. The higher the quality of the gas the more contracted must be the slit, and the quantity of gas consumed will be less. The efficiency of the burner is from 4 to 6.1 candles per foot of 30-candle gas consumed.

The slit-union, Fig. 111, possesses characteristic features of each of the foregoing burners. In outward appearance the burner is very like the batwing, but has a recessed top, which produces a flame wider at its base,

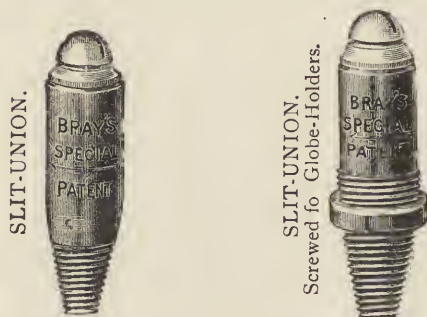

FIG. 111.

resembling the batwing flame, but void of the ragged ends, thus resembling the fish-tail flame at its apex. This burner lends itself to universal lighting, and particularly for use in public lamps.

Bray's adjustable burners have met with much favour, owing principally to the light they give and to the fact that they are cheap and durable. The burner consists of two



burners screwed together. The burner proper fits over a smaller one, so that the gas which is consumed is limited by the capacity of the bottom one. It is designed to secure the good result obtained by the use of a governor near the point of ignition. The small burner takes the pressure away from the actual point of ignition, and although the top burner would pass much more gas were the supply not limited by the bottom jet, the quantity of gas that is passed gets away freely without force and is consumed to the best advantage.

After deciding upon the size of the top burner, the user can regulate the pressure and consumption of gas by fitting the union-jet or slit-union with a smaller sized

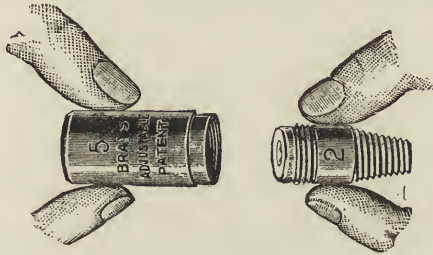

"ADJUSTABLE."

FIG. 112.

bottom burner. Thus a No. 5 top burner would require a No. 4 bottom burner in one position, a No. 2 in another, and a No. 1 in another, according to the pressure of the gas. They are useful in hilly districts, or anywhere where the pressure of gas is too high for an ordinary burner, which usually "whistles" when pressure is excessive. Fig. 112 represents such a burner.

An extreme case may be cited to show the great gain in light obtained by such an adaptation of the burners.

Quality of gas tested by London Argand 16.4 candles.

Illuminating power by bottom burner No. 0 union-jet.

5-10th in. pressure at point of ignition—

Candles.	Gas rate.
1'30	1'55 cubic ft.
4'20	corrected to 5'00 ,,

7-10th in. pressure at point of ignition—

1'53	2'05 cubic ft.
3'97	corrected to 5'00 ,,

10-10th in. pressure at point of ignition—

1'66	2'58 cubic ft.
3'22	corrected to 5'00 ,,

Illuminating power by adding No. 5 union-jet on top.

5-10th in. pressure at point of issue of bottom burner—

Candles.	Gas rate.
6'69	1'55 cubic ft.
21'6	corrected to 5'00 ,,

7-10th in. pressure at point of issue of bottom burner—

5'84	2'07 cubic ft.
14'07	corrected to 5'00 ,,

10-10th in. pressure at point of issue of bottom burner—

4'62	2'43 cubic ft.
9'11	corrected to 5'00 ,,

At 5-10th in. pressure the best result was found, and that represents five times as much light for the same consumption of gas by using No. 5. over No. 0. The flame was not very large nor well shaped, but the other results are given to show that in all cases there is a gain in illuminating power by the use of a second burner.

The "Codic" economiser is a cheap copy of Bray's

adjustable burner, but is not so efficient. The top part only is required as it will slip, not screw, on Bray's ordinary regulator burner.

Sugg's "Winsor" screw-regulating burner, Fig. 113, enables the gas to be finely adjusted to each burner, especially when no governor is used. This is a table-top steatite flat-flamed burner, suitable for interior or exterior use, as in kitchen, bedroom, or warehouse. It gives a



FIG. 113.

good steady light, is economical, adjustable, and above all, durable and satisfactory.

For shops, stalls and other outside purposes, iron burners are frequently used; but they are very uneconomical. The chief claim for them is that they will stand the rough usage attending stall lights. They weather very well, and this the ordinary Bray burner will not do satisfactorily, as the least drop of rain getting on the gauge in the burner interferes with the flow of gas. When Bray's, or similar burners, have to be exposed to the weather it is best to remove the gauge and other stuffing in the brass case. Iron burners, however, get rusty, and in time the slits or orifices get choked up.

In lofty buildings and houses the pressure of gas is very variable, and in order that the supply of gas for lighting purposes shall remain constant it is necessary to fix either a governor on the service or to adopt governor burners. In every case the latter plan will give the most economical and satisfactory result. These burners are indispensable when varying sizes and kinds are used, each requiring its own particular pressure in order to pass the quantity of gas it is constructed to burn. Flat-flame burners require less pressure than incandescent burners, and in order that both will be liberally supplied with gas, no governor should be fitted in the service-pipe, but the pressure controlled at the burners. The supply-pipes will then be charged with gas of greater pressure than needed by any burner, equalising thereby the gas over the whole system of pipes. The excessive pressure and therefore quantity of gas over that actually required to be consumed by a particular burner will be removed and controlled by some automatic means, securing a regular and constant quantity of gas passing the burner. This automatic regulation of the gas is secured in several ways, and in most cases the working or moving parts form the base of the burner. In the chamber below the burner is a float or diaphragm, carefully adjusted to work without sticking. No matter what the variation of pressure may be, the float should restrict or enlarge the gas passage in proportion to the pressure of gas. Some governors have a specially prepared leather diaphragm—which is very flexible—to which is attached a small cone working in a tube having a conical seating, and according to the pressure so is the diaphragm raised, carrying with it the cone which enlarges or diminishes the area of the passage-way through which the gas flows to the burner. Thus it corrects the variations of pressure under the burner and maintains an

uniform consumption at the best rate of gas for developing a high illuminating power. The diaphragm is adjustable and can be regulated for any consumption of gas.

In float governors the float varies in size, shape, and the material of which it is made, but steatite, brass and white metal form the principal varieties, all being durable and efficient. The float regulates the flow of gas by being carried more or less over the gas-way, or by closing the inlet orifice. All the methods aim at maintaining a constant flow of gas independent of what the district pressure may



FIG. 114.

be. The greater the pressure the smaller the orifice; and with low-pressure the float falls, and so gives a larger outlet, thus rendering the quantity of gas passing out of the burner constant to within  $2\frac{1}{2}$  per cent. one from another.

For domestic use, Peeble's needle governor burner, Fig. 114, or Hawkins and Barton's "slow combustion" burners are most reliable, durable, and economical. The parts are

easily cleaned and of the simplest possible construction. They will fit existing fittings, and are made all sizes up to 10 cubic feet of gas per hour. Their chief recommendation is cheapness. A less expensive method of restricting the flow is to cause the gas to pass through a narrow opening before it reaches the point of ignition. This is accomplished in practice by fixing over a small burner another burner having an opening of the proper size for burning to the best advantage the stream of gas which passes through the first burner when the tap is turned full on. Bray's adjustable burners, already mentioned on page 232, are on this principle, the first opening being of such a size that it will not pass more than a certain specific amount of gas at a certain pressure. This is a much more satisfactory way of burning gas, since ordinary No. 4, 5 and 6 burners commonly found in houses consume—with the tap full on and subject to about 2 in. pressure—really 8, 10 and 12 cubic feet instead of 4, 5 and 6 feet respectively. There is thus great waste with a correspondingly high gas bill. Sugg's diaphragm governor burner is the best of this type. The governor is mounted with a table-top steatite flat-flame burner, which produces a steady, silent light. For street lamps, Borradaill's 5 ft. governor burner is an excellent one, as is also Goodson's. Hawkins and Barton's street lamp burner, as shown in section full-size, Fig. 115, is also satisfactory.

An Argand burner may be described as consisting of an annular hollow ring—pierced with holes on its upper surface for the egress of the gas—connected with a metal body having three small supply tubes terminating in a  $\frac{3}{8}$  in. socket. A gallery resting upon the supply tubes serves to carry a glass chimney. The gas issuing from the many orifices at once coalesces and produces a hollow cylindrical

flame. The chimney, of suitable dimensions, serves the purpose of inducting the necessary quantity of air for complete economic combustion, although this latter is not accomplished without the use of a metallic cone or cones, which directs the air upon the outer surface of the flame,



FIG. 115.

and so gives shape and steadiness to it. The principal supply is the central one, as by increasing or diminishing its area, so is a given gas-flame rendered more or less incandescent. The outer air supply ensures shape, and

may be altered considerably without affecting the lighting power of the flame.

The gas should issue under feeble pressure from argand burners, in order to obtain the greatest illuminosity from the gas burnt. The richer the gas the smaller the holes, and vice versa. In the old types of argands the



FIG. 116.

head of the burner consists of iron, which not only conducts away much heat, but the velocity of the issuing gas is very high. This prevents the development of much of the illuminating power, and so the gas is to a great extent wasted. The most efficient burner of this class is Sugg's London Argand, having 24 holes, and generally



known as the "No. 1," but is really called "No. D." It was selected as the standard test burner for London in 1869 by the Gas Referees for London, and is shown half-size in Fig. 116. A, represents supply tubes; B, the gallery; C, the cone; D, the steatite chamber; and E, the 6in.  $\times$  2in. chimney.

This burner is used in many parts of England and the Continent for testing common gas of 16 candle-power, and consumed at the rate of 5 cubic feet per hour. It can also be used for coal gas of varying candle-power up to 18 candles, but will be found most efficient for consuming carburetted water gas up to 23 candles' value at the 5 cubic feet rate. For general domestic use it should be connected to a governor, or the flame adjusted to nearly 3 in. in height by means of the tap on the supply. Care should be taken to see that it is fixed in a perfectly vertical position.

The Regenerative burner is seen in its simplest form, and now on the market as Billing's non mantle incandescent gas burner. This is a very old method of Dr. Frankland's for showing the advantage to be gained in illuminating power by heating the air supply to a flame. Billing uses a common form of argand burner with two chimneys, the one within the other, the outer one being of a greater diameter rests upon a glass or mica disc fixed below the supply tubes. In this way the air to supply the flame passes down between the chimneys—since the top of the inner chimney stands 4 in. above the top of the outer one a draught is produced by the additional length of chimney and the heat of combustion—and so gets heated in its passage downwards by the walls of hot glass; consequently, it does not cool the flame, but carries back to the flame otherwise waste heat, which marvellously increases the light. The gain in light by this simple method of raising the

temperature of the flame is from 60 to 200 per cent., depending upon the quality of the burner employed. Billing's burner is a very poor type of argand, having a small gas-heating chamber below the burner. The inner chimney is 8 in. by  $1\frac{7}{8}$  in., and the outer one 6 in. by  $2\frac{7}{8}$  in., and of bamboo pattern. The length of travel between the heated surface of chimneys is  $4\frac{1}{4}$  in.

Testing this burner against Harcourts' pentane standard, and compared with the London Argand, the following results were obtained:—

Quality of gas by Standard London Argand at 5 ft. per hour 16.62 candles							
Single plain chimney 8 in. by $1\frac{3}{4}$ in. on burner.				With Bamboo glass chimney also on.			
Gas consumed cubic feet.	Light obtained, candles.	Candle power corrected to 5 cubic feet.	Loss of light compared with Standard Argand, per cent.	Light obtained, candles.	Candle power corrected to 5 cubic feet.	Gain in Light by heating air, per cent.	Loss of light compared with Standard Argand, per cent.
4.05	3.20	3.96	75	5.41	6.80	70	59.0
5.05	6.56	6.49	60	16.06	15.88	160	4.4 GAIN.
6.025	13.65	11.27	32	26.81	22.24	97	33.0
7.05	19.21	13.61	18	37.42	26.50	95	59.0

It will be seen that by using one chimney on this burner only 6.49 candles, instead of 16.62 candles, are obtained, whilst by employing a second chimney so as to secure the benefits of regeneration the light goes up to 15.88 candles for the same consumption of gas, yet still being below the true value of the gas. With this burner there is a positive loss of light unless 6 to 7 cubic feet per hour are burnt in it, and then the second chimney must

be used in order to get as good a result as with the standard burner. The results obtained by the addition of the second chimney are exceedingly good compared with those by the single chimney. All figures are corrected for temperature and barometric pressure. The light is very

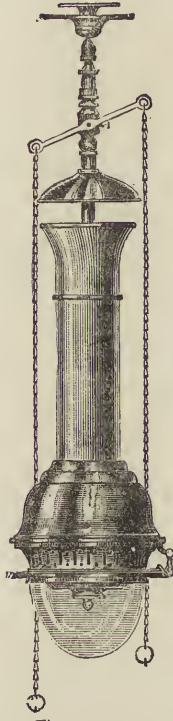

FIG. 117.

pleasing, and could be much improved by the adoption of a better class of burner.

By the use of properly constructed regenerative lamps, as Siemens, Wenham, Thomas and Fullford, as represented by Fig. 117, the gas is most advantageously consumed, and

is a great advance over the older methods of lighting. A section of the burner of the Fullford lamp is illustrated by Fig. 118, showing passage of the air to the flame after leaving recuperative chamber. These lamps are specially adapted for lighting railway stations, offices, and outside shops, since they can be obtained storm-proof.

The luminosity of a coal gas flame really depends upon the number of carbon particles liberated in it, and to the utmost possible temperature they can be heated. With ordinary gas it does not seem possible to obtain much

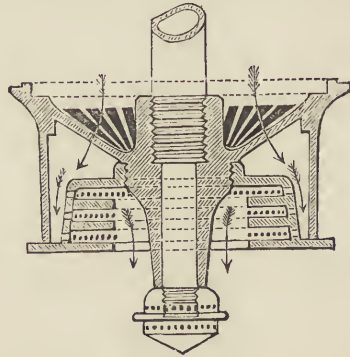

FIG 118.

better results in practice than those already found. Little better results are possible, but the wear and tear on the burner would be so great as to rapidly destroy the materials of which the lamp is made. That for all practical use and a fair life for the burner, 12 candles per cubic foot may be looked upon as the limit of duty obtainable by superheating gas and air prior to combustion.

The Albo carbon light is a cheap and effective method of enriching coal gas, which found considerable favour a few years ago. As a matter of fact it is a method of carburetting ordinary gas, but at a point close to the

burners. The enriching material is recrystallized naphthalene which is vaporized by the heat of the burning gas. The vapours of the naphthalene mix with the gas and are carried by the latter to the point of combustion, producing on combustion a greatly increased illuminating power. The lump naphthalene or albo-carbon is placed in a generator or reservoir, situated above or below the burners, through which the gas must pass. The burners are arranged radially round or above the reservoir in such a manner that the heated products of combustion from one or more burners raise the temperature of a piece of copper on the gas inlet pipe. The heat is either conveyed to the vaporizer by lateral conduction or by superheating the inlet current of gas. The heated gas then immediately comes into contact with and passes between the pieces of albo-carbon material, vaporizing some of it, at the same time carrying the vapour to the burners, where it is consumed to advantage. The reservoir must always be in proximity to the burners, as, if it were placed further away, the naphthalene vapour would be thrown down as crystals in the pipes, due to the reduction of temperature, and finally block the gas-way. The burners are small, union-jet ones, such as are used for oil gas. Common gas burners will not do, as they allow naphthalene to escape combustion and so impart its characteristic odour into the room. Burning at the rate of 5 cubic feet the light is equal to from 25 to 30 candles, and this gives an efficiency of 5 to 6 candles per cubic foot of gas. The trouble of filling the reservoir and the cost of enriching material must be considered when calculating the cost of this system of lighting.

Acetylene gas requires special burners suitable for its consumption, by reason of its extreme richness in carbon

particles. The troubles attending the generation of acetylene from calcic carbide are practically at an end, but the greatest of them has been the difficulty to get a burner that will not readily smoke. Overheating during generation forms benzene which requires three-times as much air for its consumption as does an equal volume of acetylene, and so the fine holes in the union-jet burner retard the flow of benzene vapour which also prevents the proper combustion

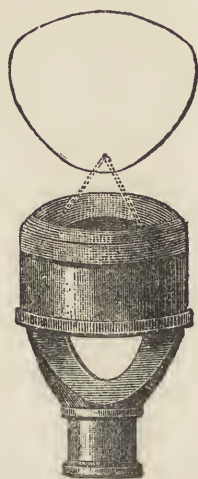

FIG. 119.

of the acetylene, causing a growth of deposited carbon which quickly distorts the flame with a great tendency to smoke. Very many burners have failed because of this rapid growth of deposit. The Naphey or Dolan burner is a marked improvement, although the tendency to smoke still remains. Fig. 119 represents Messrs. Falk, Stadelmann and Co.'s new burner which produces a free-flame that does not smoke even under low pressure. The flame is

perfectly white and smokeless, and burning away from the burner the carbon particles cannot very well choke up the fine apertures. Carbon deposits on gas burners can be removed without the slightest injury to the jets by burning the carbon away. Place the burners in a horizontal position in a Bunsen flame for a few minutes. When cold, the jets should have no black markings on them, but in appearance should be equal to new steatite jets. If they are slit burners pass a piece of paper through the slits to remove any loose dirt, and on again using them, they will be found as efficient as new ones.

The following table shows the efficiency in candles of the different types of gas burners in common use per foot of gas consumed :—

Flat flame, Union-jet,	$1\frac{1}{2}$ to $2\frac{1}{2}$ ;	governed or adjustable.
3 to 4'3.		
Flat-flame, Batswing,	4 to 6'1	with 30 candle gas.
Ordinary Argand,	2'7 to 2'9	with 16 candle gas.
Standard Argand,	3'2 to 3'35	with 16 candle gas.
Albo-carbon light,	5 to 6.	
Regenerative lamps,	10 to 12.	
Acetylene, generally	35, best conditions	48.
Welsbach "C" 1893	burners,	12 to 14.
, , 1898	, ,	19 to 23'4.
, , Bansept	, ,	18 to 20.

## CHAPTER XVII.

## INCANDESCENT GAS LIGHTING.

At the present time, there are two legalized systems of incandescent gas lighting, the Welsbach and the Sunlight. The principle of each system is virtually the same—the employment of an atmospheric burner to heat a mantle—but the mantles differ very greatly, the one giving a white light, the other a yellow light.

The ordinary incandescent burner is a special form of bunsen burner, which causes the gas to mix with such a proportion of air as will ensure a good mixture, and burns with a blue flame, which is a heat producing flame. The gaseous mixture *per se* gives no light, but by adopting a mantle or hood of special construction, and suspending the same over the flame, it is rendered incandescent. The quality of the gas used has a marked effect on the results obtained by the incandescent burner. The gas issuing from the orifices of the burner at a given pressure induces a certain amount of air to enter the burner and mix with the gas on its way to the point of ignition. Practically, the air supply is constant, whether a poor or a rich gas is used, providing the pressure remains constant; consequently, when the gas is of good quality less must be used, and this is secured by reducing the size of the orifices. The Incandescent Gas Light Company adjust their burners to suit 16-candle gas, and when burners are needed to consume rich gas this should be stated when ordering them, so that they may be adjusted



to the requirements. Water gas, for instance, requires much less air mixed with it to bring about a good result with the incandescent burner. The true value of a gas for use for incandescent lighting is dependent upon the amount of heat that can be developed by it when perfectly burned. Combustion must be perfect, and can only result by thoroughly mixing the gas and air in right proportions. The appearance of the bunsen flame varies according to the amount of air allowed to mix with the gas. The colour of the zones of the flame under ordinary conditions is a violet blue, but by adding more air the flame becomes fiercer, and the inner zone changes to a green colour. Any further addition of air causes the mixture to become explosive, and it flashes back into the tube of the burner. In a bunsen burner there are two combustions taking place at the same time. The first takes place at the surface edge of the inner cone of the flame; there the hydrogen and hydro carbons of the coal gas undergo a partial combustion, limited by the amount of oxygen drawn into the burner and mixed with the gas. The chemical actions taking place result in the carbon combining with the oxygen to form a mixture of carbon monoxide and carbon dioxide, and some of the hydrogen is burned to water vapour. The hydrogen and carbon monoxide escaping this combustion produces the outer flame, which, by the addition of external air, is completely burned to carbon dioxide and water vapour. To bring this perfect combustion about it is very essential that the burner should churn the gas and air into as perfect a mixture as possible, not so much in the right proportions, as to ensure that the molecules of the combustible constituents and the oxygen with which they are to unite shall find themselves hand in hand in every part of the mixture when arriving at the point of combustion. The

flame resulting from the combustion of such a mixture is greatly increased in the intensity of its heating powers.

The burners supplied to the public prior to August, 1898, did not thoroughly mix the gas and air, but resulted

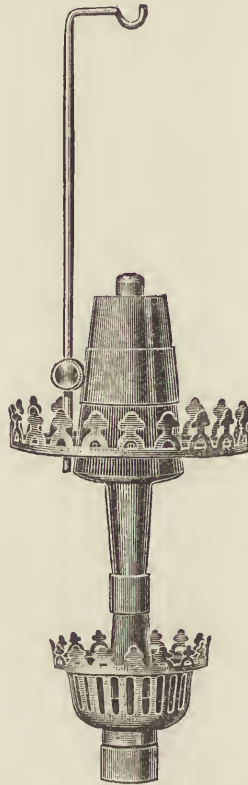

FIG. 120.

in what might be described as a streaky admixture, producing a flame having a lower temperature. The great drawback to the burner of 1893 is its liability to smoke when the pressure of gas increases, and this is

because the quantity of gas sent through the nozzle is in excess of the quantity of air that the burner could draw in, and, in consequence, is imperfectly consumed, and so deposits carbon on the mantle.

The new series of burners issued by the Incandescent Gas Light Company, of which Fig. 120 represents the No. 1 size, is very different, for it is claimed that any augmentation of pressure over that a particular burner is regulated to pass, at a certain pressure, simply results in the flame becoming hotter and hotter and an increase of light. To a limited extent this is true. The proportion of gas consumed by the burner does not greatly increase with an increase of pressure, and, within limits, such increase of gas sucks in extra air to effect complete combustion.

The burner consists, in the language of the specification, of "two cone frustra joined at their smaller ends, the lower cone frustrum being shorter than the upper." It has been found "that when this double-cone pipe is used in a bunsen burner it operates to increase the quantity of air forced through the pipe, produces a more thorough mixture of the air and gas, and at the same time delivers the mixture at a much higher pressure than the ordinary bunsen burner does." The lower cone is called the "mixing cone" and the upper one the "suction cone." The angle of divergence of these cones must fall between 5 and 7 degs.; with any angle above 7 degs. the suction diminishes until it reaches 10 degs., when it is said to almost disappear. The length of the suction cone is about double that of the mixing cone, and this has been found to give the best results. The head of the burner is conical and contains an inner perforated copper cone closed at the top by a toothed disc, the teeth of which partially close the annular space between the two cones,

and thus take the place of the wire gauze. The object of the perforated cone is to assist in mixing the gas and air, and also, coupled with the outer cone, to heat the gaseous mixture to a fairly high temperature before arriving at the point of ignition. The air inlets are much greater in area than usual; in fact, the tube might be said to be open but for the thin strips of metal which serve to connect the tube to the gas jet. The burner requires no chimney, yet has an increased efficiency over the 1893 burner; besides, it is capable of dealing with wider ranges of pressure without waste of gas, all of which are steps in advance.

The burner, it is believed, will not be such a source of trouble in keeping dirt and dust from depositing on the top and jets. The teeth of the burner are wide, and so will allow the gas a free and easy exit. The advantages claimed for the new burner are distinctly three. (1) That 25 to 30 candles per cubic foot of gas consumed at pressures of 6-10ths and 8-10ths, is obtained with all sizes of burner; (2) absolute combustion of flame, no smoke, no objectionable bye-products, and no difficulty by reason of increased pressure; and (3) no chimney is required. These advantages are not borne out by experiments given on page 257. There is one disadvantage, the hissing noise produced by the extra pressure.

By adopting high-pressure gas, or a forced draught of gas and air equal to 10 in. or 12 in. pressure by using Rothgiesser's, Somzée-Greyson or the Hydro-Incandescent Gas Light Company's apparatus, a very great light is obtained by employing a very large mantle. With a consumption of 30 cubic feet per hour the illuminating power was over 875 candles, which is equal to about 30 candles per foot of gas. The high pressure system,

however, shortens the life of the mantle, although, of the two Welsbach mantles, the "Cx" shows greater durability.

For decorative lighting the small burners are of immense service, as the globes and cups are of exquisite designs, and the pretty tints lend themselves to almost any decorative purpose. Fig. 121 represents one pattern



FIG. 121.

of globe and cup on burner. For outdoor lighting the absence of the chimney is an advantage, as it will allow of more pleasing designs in the lanterns. A chimney, however, is a great protection to a mantle so long as it remains whole.

The following figures given by the Company, are the sizes of the burners supplied, but the candle-power claimed cannot be obtained with the gas consumptions given :—

No. of burner.	Gas Consumption at 1 in. pressure in cubic feet.	Approximate candle power.	Price of mantles.
			s. d.
0	$\frac{3}{4}$	20-22	0 9
1	$1\frac{1}{4}$	30-36	0 9
2	2	50-60	1 0
3	3	80-90	1 0
4	4	105-120	1 3
7	7	185-210	1 9

Before passing on to describe the mantles it will be as well to briefly mention two other prominent bunsen burners, *viz.*, the Denayrouze and the Bandsept. The Denayrouze burner was the first to work efficiently without a chimney. It is only suitable for public lighting, railway stations and other large buildings. It can with ease be grouped into clusters of three, five, and eight, with only a slight decrease in duty. The illuminating power varies from 150 to 175 candles according to the pressure. The best results are obtained with a gas pressure of 22-10ths pressure. The efficiency of the burner with a Welsbach mantle is 18 candles per cubic foot. With a higher pressure the consumption is, of course, greater, but the candle power is slightly reduced in proportion to the increased consumption. The mantle is specially made for the Denayrouze Light Syndicate, Ltd., by the Incandescent Gas Light Company under the Welsbach patents, and which can only be supplied through the Syndicate.

The Bandsept burner, Fig. 122, is composed of a series of injection cones so arranged that the air is drawn in at successive points of the burner. It causes a definite mixture of gas and air to reach the point of combustion in a perfectly homogeneous condition, so that the mixture

burns simultaneously throughout and at a maximum temperature. There is very little resistance to the flow of gas and air, and to further complete the mixture, layers of gauze are placed at two points in the head of the burner, which act as "atomizers." The cones are surrounded by a movable collar, pierced with  $\frac{1}{8}$  in. holes—corresponding with the holes in the tube—for the

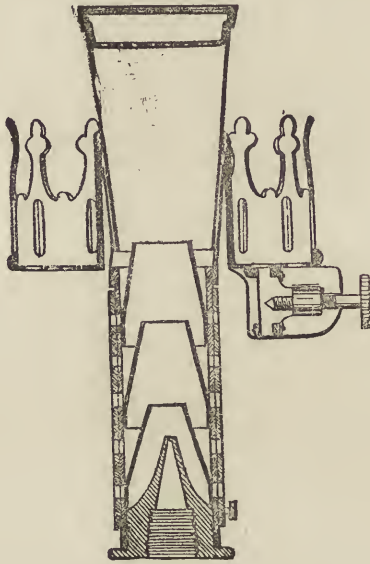

FIG. 122.

admission of air in small streams at low pressure. By means of the collar the air is regulated or adjusted until a green zone—the last of the inner blue cone which is caused by insufficient air—appears just above the wire gauze. The green zone in the interior of the flame indicates that the explosive point is being reached, and it is owing to

this fact that the inner cone of flame is drawn down on the surface of the gauze, but having more than one layer, prevents it passing through, and so the burner does not light back. As stated, the flame is practically a solid one, having a more uniform temperature than an ordinary bunsen flame. The ratio of gas to air in the blue non-luminous cone is 1 volume of gas to  $2\frac{1}{2}$  volumes of air, and in the green cone 1 volume of gas to 3.4 of air. With this burner excellent results can be obtained with the ordinary "C" Welsbach mantle and about 4 cubic feet of gas. It increases the efficiency of any of the mantles in general use at least 25 per cent. compared with the ordinary incandescent bunsen burners. This burner is adopted by the Welsbach Company in Paris, and the aforesaid syndicate owns the Bandsept patents in England.

Results of experiments made in France with this burner :—

Pressure in inches of water.	Gas per hour cubic feet.	Candle power.	Efficiency, or candles per cubic foot.
1.0	2.99	87.7	29.3
1.4	3.10	92.5	30.0

These results of experiments with the Bandsept burner are much higher than can be obtained in London. Using the "C" Welsbach mantle the author has only been able to get 20 candles per cubic foot of gas, although this is 25 per cent. increase of duty. This result is obtained by consuming about 4 cubic feet of gas per hour. There is one drawback to the burner, that should the pressure of gas increase, the extra quantity of gas passing through the jet cannot get through the mantle owing to the resistance offered by it, and so the top row of air holes, instead of acting as inlets for air, allow mixed



gas to escape into the room. This, however, only takes place when the mantle is on the burner, and is specially noticeable if the chimney be removed.

The author has also tested the No. 1 size of the series of new Welsbach burners on a modern photometer, using a certified Harcourt 10-candle pentane unit as the standard of light. The results of the experiments have been corrected for temperature and barometric pressure, and are as under:--

Quality of gas used in these experiments when burnt in London argand burner equalled 16.58 candles—

Pressure Inches.	Gas con- sumed per hour. Cubic feet	Light obtained. Candles.	Corrected candle power per cubic foot of gas consumed.	By using 6 in. by 1½ in. chimney.	
				Light obtained.	Candles per cubic foot of gas.
1'00	0'95	8'46	8'90		
1.25	1'06	12'64	11'92		
1'50	1'22	18'26	15'00		
1'75	1'30	24'96	19'20		
2 00	1'43	30'29	21'20		
2'25	1'60	35'10	22'93		
2'50	1'65	38'60	23'40	31'60	19'15
2'75	1'71	39'00	22'81	36'90	21'57
3'00	1'80	38'30	21'31	40'30	22'40
3'50	1'95	31'20	16'00	46'90	24'05
4'00	2'12	—	—	50'85	23'98

The burner was not quite accurately adjusted to consume at 1 in. pressure one cubic foot of gas, although when corrected for temperature and pressure, the volume passed was practically one cubic foot. It is not to be expected that so small a quantity of gas would heat and thoroughly raise to incandescence this size of mantle, so that the latter would emit 25 to 30 candles. The best result is obtained by consuming about  $1\frac{3}{4}$  cubic feet of gas at a pressure of  $2\frac{1}{2}$  in., although good results are

obtained when the gas pressure is anything between  $1\frac{3}{4}$  in. and 3 in. Above 3 in. the light is seriously reduced. However, by using a glass chimney more air is inducted, and at  $3\frac{1}{2}$  in. pressure the highest duty was obtained by an increase of 50 per cent. above the result obtained without a chimney. This type of burner is a great advance on the old (1893) pattern burner in not requiring a chimney, thereby lending itself more readily to decorative purposes; besides, owing to its absence, there should be less destruction of mantles. The author found that the extra draught caused a greater wear and tear of the mantle as compared with the use of a "C" burner and chimney.

Having briefly described the burners by which the heating power of the gas is to be developed for incandescent lighting, mention may now be made of the mantles. The Welsbach is a thoria-ceria mantle, composed of 98.76 per cent. thorium and 1.24 per cent. cerium. It is manufactured as follows: The network hood, Fig. 123, is made of ordinary cotton, knitted in a cylindrical form by a machine. It is then washed in a solution of hydrochloric acid and ammonia, to remove impurities, after which it is steeped in the liquid containing the preparation of rare earths mentioned above in solution. The mantles afterwards pass through a machine which presses out a certain amount of liquid, leaving only sufficient to soak all the pores. They are then dried to remove the water. The mantle is then looped so that it can be hung up, afterwards stretched on wooden and glass cones to give the required shape, when by means of a gas flame the cotton is burnt out, leaving an earthy ash retaining the desired shape. The mantle is now a very fragile thing and will not bear handling, far less transport, and so to give it the necessary strength to withstand careful

conveyance, it is toughened by being dipped into collodion—a clear, inflammable liquid which soon dries. Having prepared the mantle, it is necessary that it should receive proper treatment on first lighting it. The mantle should be carefully suspended either on a fork or a wire over the burner, and by means of a match or taper apply a light to the top (not the bottom) of it, seeing



FIG. 123.

that it burns evenly downwards. No gas should be lighted until the whole of the collodion has burned off, and this should be done before the chimney is put on the burner. Now light the gas by holding a light close to the mantle and, with only a little gas on, the chimney or globe can easily be lowered over the mantle without damaging it. There is no need to remove the glass chimney when again lighting, but to prevent damage being done to the mantle by the effect of the explosion or

shock which occurs in the chimney, and also to prevent lighting back, close the air holes with a finger and thumb, when it will light quietly. In this way the life of a Welsbach mantle may be prolonged, but owing to its fragile nature it is frequently shortened by fracture, yet on the average it will easily last 500 hours. The mantles vary greatly, although occasionally one will last 1,000 hours. The author has had one in daily use for nearly a year, and it shows only slight signs of giving way. The normal lighting value, on the 1893 pattern burner, is about 40 candles per  $3\frac{1}{2}$  cubic feet of gas extending over from 400 to 600 hours. The light does not seriously diminish during the first few hundred hours, but towards the end diminishes to the extent of 30 to 40 per cent. This is chiefly due to the delicate fabric falling to pieces, and so lessening the area of incandescent material.

It is not positively understood how this mantle made up of thoria and ceria has the power to emit such a fine light. A mantle made from pure thorium oxide gives less light than one made from commercial thorium, and then the latter only emits a little more than 6 candles per cubic foot of gas. It is also strange that the oxide of ceria should only give one candle's light, yet when the two rare earths are mixed in the proportion of 93.7 per cent. thoria to under 2 per cent. ceria, the mantle made from such mixture emits fifteen times more light than can either of the pure oxides by itself. Dr. Bunte believes the emissive power of light possessed by the mantle is due to intense local temperature owing to the catalytic action of the ceria bringing more oxygen to combine with the combustible gases in the flame. By reducing the proportion of thoria the light is gradually reduced. According to the researches of Dr. Drossbach, of Deuben, the maximum illumination

occurs when the mantle contains 99.1 per cent of thorium oxide to 0.9 per cent. cerium oxide. He obtained 14c candles with such a mantle on an ordinary bunsen burner.

The Sunlight mantle—so far as the net-like skeleton of the mantle is concerned—is similar to the Welsbach, but is made of about 50 to 60 per cent. of alumina, with about 30 per cent. of zirconia, and these form a homogeneous body, which is then thinly coated with oxide of chromium. In the litigation in 1896, between the Welsbach and Sunlight Companies, it was clearly shown that Welsbach did not claim an earthy skeleton made by means of impregnation from any refractory oxide whatsoever; but the use of rare earths is the essence of his invention, and his manner of shaping his mantle was by chemical reduction, not by coating. Mr. Justice Wills in giving judgment against the Welsbach Company, clearly pointed out the difference in the inventions when he said: "It was a necessary consequence of the nature of Welsbach's process that his skeleton should be absolutely homogeneous throughout. Take a fragment out of the structure from the back or the front, or the sides, from the rind or from the core, it must be the same in composition. Hence the whole fabric was a compromise between strength and illuminating power, except in a detail so unimportant that I have not thought it worth while to notice it; he could make no use of the great strength and tenacity of alumina, because it has practically no illuminating power. The Sunlight process uses alumina very largely indeed. It makes a hood which is a mixture homogeneous throughout, of alumina and zirconia, and so gets greatly increased strength for the hood, with moderate illuminating power introduced by the zirconia. The idea of this part of the process is, no doubt, taken from the Welsbach patent. But the addition

of a thin coating of oxide of chromium is what gives the illumination, and in this instance the substantial illuminant is not that portion of a homogeneous mantle which is exposed to the flame, but a foreign substance laid on in a thin film, and quite absent from the bulk of the structure. It is true you get much less light than by the Welsbach process." The mantle emits 9 to 10 candles on an average.

The colour of the light emitted by the mantle varies with the alterations in its composition. The Sunlight mantle emits a warm pinkish yellow light, very different from the white light radiated by the Welsbach mantle. This latter light comprises an excess of green and blue rays, and according to Professor Crookes, "the best form of artificial light is one containing little or no ultra violet rays, no excess of yellow rays, and just sufficient red light to communicate a warm, pleasant tone to the surrounding objects. The injurious effects of artificial light on the eye being principally attributable to the invisible ultra violet radiation, the Welsbach light may be considered to be two-and-a-half times as harmful as the Sunlight mantle light."

The light emitted by the Welsbach mantle is not so good a penetrator of fog as the ordinary gas-flame light, and in this respect resembles the arc light, but this is no great drawback. Professor Lewes determined the following figures, which represent the percentage loss of light from various illuminants in passing through an artificial fog solution.

Coal gas flames	...	...	11'1
Acetylene flames	...	...	14'7
Welsbach mantle	...	...	20'8

"This means that the acetylene flame loses 32'4 per cent. and the Welsbach burner 87'3 per cent. more of

their light-giving power than does our old friend the gas flame."

Two new incandescent mantles are about to be placed on the market. One is the "Jasper," the other the "Voelker," both mantles containing thoria and ceria. The former is coated with a silicon solution, and the latter with a solution containing alkaline oxides, which is said to strengthen and increase the life of the mantles. It is also claimed that by these methods the light steadily increases during the life of the mantles. At the time of writing, the author has not completed his experiments to verify these characteristic properties.

The Solid-Cone Incandescent Light is not a light to be recommended if judged by the quantity of gas consumed and the light emitted in the horizontal direction. Fig. 124

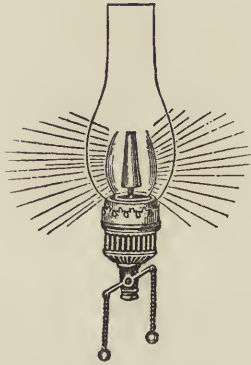

FIG. 124.

represents an argand burner having a prop passing up through the centre air passage, on which is placed a "solid practically incombustible cone of luminous metallic oxides and other substances." This cone is a destroyer, not a creator of light, if judged by the following figures; in fact,

the results obtained at 5 cubic feet per hour will not stand comparison with the result by the London argand at the same rate of gas consumption.

Quality of the gas by London argand at 5 cubic feet per hour = 16.25 or 3.25 candles per foot of gas.

Standard of comparison, Dibdin standard = 10.47 candles.

RESULTS BY SOLID CONE BURNER.

Gas consumed per hour. Cubic feet	With cone	Without cone.	Efficiency candles per cubic foot of gas.
	Illuminating power corrected candles.		
5.00	5.20	—	1.040
5.00	—	10.41	2.082
6.80	—	16.07	3.214
6.95	9.09	—	1.820
8.85	16.69	—	3.340*
8.85	—	14.36	2.872†

\* In this case the cone forced the air against the flame, and so brought about better combustion, but at what cost?

† The flame was slightly smoking, and in no case without the cone on the burner is the light very steady.

Much is claimed for this "latest scientific discovery" which it really does not possess or deserve. It is one of the many worthless burners on the market, since it is destitute of a single point of economy to recommend it.



## CHAPTER XVIII.

## CHIMNEY GLASSES, GLOBES AND REFLECTORS.

IN order to get economic as well as hygienic combustion of illuminating gas when burnt by all circular burners like the Argand type it is necessary to use a glass chimney to not only protect the flame, but to give it shape and stability so that the latter may develop its maximum amount of light. Now the Argand burner is much more suitable for common or low grade gas than for such rich gas as is made from oil, for the chief reason that while the burner could be made suitable, inasmuch as the holes would simply have to be made smaller, yet the difficulty of supplying to a circular flame the most desirable quantity of air to fully develop the illuminating power of a particular grade of gas is not got over by the mere use of another size of chimney. The pressure under which the gas issues from the burner and the general construction of the latter have much to do with the formation, steadiness and brightness of a flame, independent of the diameter and length of chimney employed. But the burner may be of the best possible construction, having all the improved air directing cones, yet without a chimney the flame would be lambent, smoky, and giving very little light. Place a chimney on such a burner as the London Argand, and the flame ceases to flicker and smoke, assuming a good shape, while emitting a bright light. The cause of this is not far to seek. The

gas issues from good Argand burners at a much slower rate than from flat-flame jets, owing to the lower pressure necessary to be used to get the gas out of the many orifices, which should offer very little resistance to the flow of gas, thereby removing from this type of burner that property of sucking in its own supply of air for combustion. The chimney then takes the place of pressure and inducts such a quantity of air, at a slow speed, as will best develop the illuminating power. The quantity of air, and the rate at which it flows in, is dependent upon the length of the flame and chimney employed. It is principally owing to this slow rate of flow of gas and air that the Argand gives, with common gas, a better development of light per unit of gas consumed than can be obtained with flat-flame burners. Air directing cones, however, are necessary to ensure good shaped flames, the same being free from peaks or forks of flame.

The common Argand burners to be found in shops have no means of directing the in-current of air to the flame, and so much of the air passing through the chimney is not utilised except in distorting and cooling the flame, thus robbing it of light. Gas-fitters are in the habit of using chimneys which are too long, rather than endeavouring to improve things by trying one or two chimneys of different lengths, and selecting the one which gives the best result, which is easily judged by the eye. Take, for instance, the London Argand using its proper size chimney, 6 in. by 2 in., the gas may be 16.33 candles' value, but substitute an 8 in. by 2 in., and the same gas gives only a light of 15.32 candles. Again, a 12 in. by 2 in. chimney inducts so much air that the flame is cooled to such an extent that the 16.33 candle gas only gives a

light of 11·14 candles, conclusively proving that the length of a chimney can be overdone, and so, when consumers use long chimneys the only conclusion they come to is that the gas is bad.

The thickness and colour of the chimney will affect the light emitted by the flame. Even thin chimneys obstruct a certain amount of light, but as it is necessary



FIG. 125.

to use a chimney with the Argand burner one can only say that a particular chimney bears a certain merit over another by the amount of light it allows to pass through the glass. Mica chimneys are now much used for incandescent burners, but size for size with glass ones they are very inferior as diffusers of light. Using an 8 in. mica chimney made up of two pieces, as compared with a glass one the

same size, the loss of light in one case was equal to 20 per cent., which becomes less as the light grows more bright, but taking the mica chimneys as a class they obstruct the incandescent light to the extent of 15 per cent. The Patent Premier rod chimney is a very durable one, and has the great advantage that broken rods can be replaced by new ones. They are not so easy to clean unless taken to pieces, and in the hands of gas consumers this is found to be an objection. Further, they invariably destroy the mantles through the rods breaking or bending into them. Comparing a 7 in. plain against a 7 in. rod chimney it was found that the latter gave less light by only obstructing 2'34 per cent. The Combination glass rod chimneys, Fig. 125, are also durable and can be repaired by replacing the broken or damaged parts by



FIG. 126.

new ones. The lower portion of these chimneys is composed of glass rods drawn in lens form, which have the effect of diffusing the light more evenly than is the case with the plain chimney. The upper portion is a plain glass cylinder, jointed to the rod cylinder by means of a brass band. By the use of rod chimneys the light is not increased, but better diffused, although it is claimed

that they increase the light. They are also unsuitable for street lamps. The Jena bulb chimney is an improvement on the ordinary chimney for incandescent gas lighting. Fig. 126 represents one form of bulb and band or frill. Testing this frosted bulb it only showed a loss of light of 2.42 per cent., while one having the upper portion or bulb proper frosted, with the lower or base portion clear glass, being what is called half-obscured, improved the light to the extent of 2.42 per cent., as compared with a plain glass one. This was due to the frosted portion acting as a reflector, since the whole of the light passed through the lower portion horizontally, while the bulb diffused additional rays in the same direction. The Jena bulb has holes in the neck at about the level of the burner, and the current of air passing through the gallery is checked by a cone, and so the air is brought more immediately against the mantle, with the result that the light is very much increased. The bulb at the top has three holes in it instead of one like the bulb chimney. All chimneys should be perfectly upright in position on the burners.

The Improved Standard globe chimney has several advantages over the ordinary straight chimney for incandescent gas lighting, the essential being that it induces a fair draught, at the same time it is so far away from the mantle that the flame cannot destroy it, and consequently more economical. These are strongly recommended for street lamps.

Globes are principally used to ornament the apartment and to add to the appearance of the light, since they can be obtained almost in any colour and shape. Also sometimes, to counteract the discomfort caused to the eye, it becomes necessary to use globes to distribute the light

and to protect the eyes from such lights as the direct incandescent mantles. In choosing globes one must be guided by the requirements and surroundings of any particular place. But whatever advantage is gained by the use of globes, it is only at the expense of light. For general purposes, frosted, ground glass and opal globes are used, and for house use they are made tinted in a variety of colours, especially pink and ruby, to tone or neutralize the effect the Welsbach light has upon the complexion. All such globes obstructed a large amount of light, and what does pass through is not always satisfactorily diffused.

Blondel and Psarondatri's patent Holophane globes

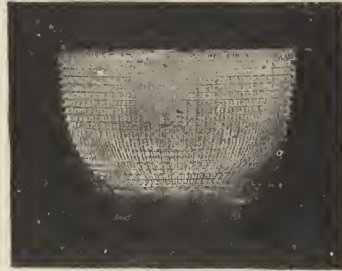

FIG. 127.

are excellent diffusers of light. Fig. 127, represents one of the globes made of clear glass, so moulded that the exterior consists of horizontal lenses, produced by lines of prismatic form running round the globe, whilst the interior has vertical ribbings of prisms which break up and diffuse the light. The horizontal prisms direct the rays downward, where most required, and give an increased illuminating power over the working angles; at the same time, the large emissive surface makes the light pleasant to the eye. They do not stand well in draughty places owing to their prismatic

formation, as they readily crack along the lines, but in other respects are exceedingly satisfactory globes. They are made in five or six shapes, also rose tinted.

The following Table by Professor V. B. Lewes, shows the mean loss or gain in light due to the globes used at angles between the horizontal and 45 degrees below it; the results being as follows :—

Percentage gain or loss of light due to using various globes with Welsbach mantles.

Globes.	Percentage Gain or Loss in Light.
Holophane, tulip shape, gain of 12'3 per cent.	
„ conical	„ 13'1 „
„ conical, pink	„ 1'1 „
White Opal Globe, loss of	0'5 „
Ground Glass Globe	„ 12'4 „
Frosted Glass, tulip	„ 11'2 „
„ „ pink	„ 23'2 „
Pink Opal Globe	„ 34'1 „

The above results not only show the great gain obtainable by the use of Holophane globes, but show the serious loss of light involved by the use of pink tinted globes.

The figures do not ascribe a power of creating light to the Holophane globes, but they simply represent that some of the light emitted by the mantle, which would otherwise be lost in the upper part of the room, is arrested by the upper prisms and deflected downwards. The light from a larger surface than the source is more uniformly distributed, and thus prevents sharp shadows and glaring contrast between the light and the objects illuminated by it.

The ordinary crystal prismatic globes are deficient in the useful qualities that characterize the Holophane

light diffusing globes. The Holophane is the only globe that combines complete diffusion with an increase of light over bare light at any particular angle.

Fig. 128 represents a diagram which shows clearly the

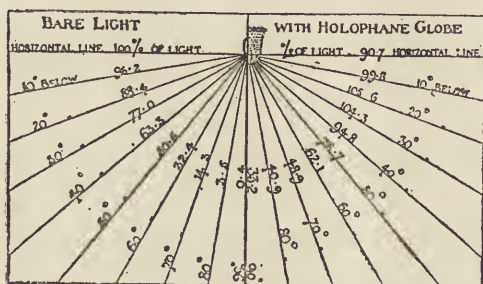

FIG. 128.

advantage of the globe for illuminating purposes below the horizontal line.

Of the other incandescent globes it is quite a matter of taste or fancy with many of them as to which to adopt. The number of fancy shapes, as well as being colour tinted,

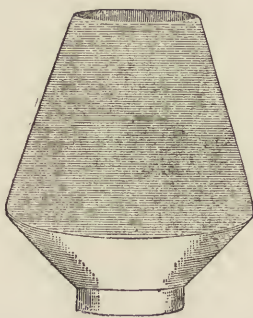

FIG. 129.

renders the task of selection a difficult one. But for shops, and houses generally, the opal squat, with clear base (Fig. 129), gives excellent results. They are made in several



sizes, even to suit the No. 1 new burner. They are specially suitable for shops where, by printing on the glass, they may be used as a means of advertising commodities to advantage.

Bray's "canopy" globes are exceedingly satisfactory, being specially made for flat-flame burners, and are very useful in lighting some shop-windows. They reflect and diffuse the light in a downward direction to a greater extent than the ordinary gas shade globes, which are becoming to an extent old-fashioned, although there are many fancy and

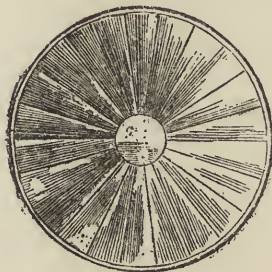

FIG. 130.

useful flat-flamed globes still in demand. The gas-fitter should be careful to select only those with wide bottom openings of from 4 in. to 5 in. in diameter. Globes with narrow openings at the bottom cause the air to pass to the flame at too great a speed, producing flickering and unsteady lights. The comet fitting globes are the best to use, as the flames are always much more steady.

The object of reflectors is to throw back rays of light which would otherwise either be lost or wasted in illuminating that which is not wanted. Some are made in six sizes from 6 in. to 12 in. in diameter, of silvered glass or copper in one piece or in segments (Fig. 130), with or without a hole in the centre. This is a good reflector, but

a bad diffuser of light, in that it does not send out the rays of light equally in all directions.

Reflectors are also made of albatrine, opal, porcelain, and enamelled steel, and the nearer they approach a milk-white colour the better the reflector. They may be used in houses or in shops to reflect the light down, or concentrate it on certain work or goods, which are then seen to better advantage. In shop windows especially, the best results can only be attained by keeping the lights high up, so that not only the lights but the reflecting shades are hidden as much as possible, in order that they may not be seen when viewing the objects or goods in the window. Best white paper will reflect about 70 per cent. of light, and in consequence is often found useful for refitting wire-frame shades. Nickel presents a good reflecting surface, but it needs at least weekly attention to keep it polished so that it shall retain its full power of reflection.

## CHAPTER XIX.

PRESSURE GAUGES, AERORHEOMETER AND INDICATORS  
FOR THE DETECTION OF GAS ESCAPES.

THE pressure gauge is a very simple instrument, no matter how complicated its construction. It is of the greatest service to the gas-fitter as it indicates in inches and 10ths-of-an-inch the pressure of gas supplied by the service or main. The simplest form of tube gauge is U-shaped, having a graduated scale fixed between the two limbs of glass tube. The scale is graduated into inches and 10ths throughout its length, but the zero line is in the centre, and every  $\frac{1}{2}$  in. above and below this line is numbered the same. The first  $\frac{1}{2}$  in. is numbered one, because when the tube is carefully charged with water to the zero line and sufficient pressure of gas is allowed to exert itself upon one column of water, the latter will be depressed equal to half the amount of that pressure while, at the same time, the water in the other limb, which is open to the atmosphere, will be raised to an equal extent. If it be assumed that just 1 in. of pressure is allowed to act upon the column of water, then the level of the water in each limb will be just  $\frac{1}{2}$  in. above and below the zero line, consequently, the points  $\frac{1}{2}$  in. about and below zero must be numbered 1 or 5, according as to whether the pressure is wanted in inches or 10ths of an inch. So in the illustration, the pressure would be 1 in. or 10-10ths. The term inches is most generally used on a gas-works, while on the district

the term 10ths is used when speaking of the amount of pressure for the first few inches.

Gauges constructed of glass tubes are not readily carried about from one place to another without a risk of breakage or spilling the liquid they contain, and besides these drawbacks, there is the trouble of keeping them free from leakage. Fig. 131 is a full size representation of a

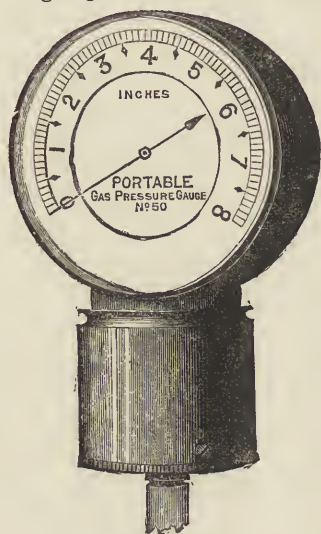

FIG. 131.

portable gas-pressure gauge, which, while having all the advantages of the glass gauge, has not its disadvantages, and will be found a most reliable instrument. As no liquid is used in its construction this inconvenience attending liquid gauges is obviated. It is the most portable gauge the author knows of, being neither bulky nor inconvenient, and, enclosed in its neat morocco case, there are no risks attending its conveyance in one's pocket from place to place. The circular graduated scale, showing the

equivalent pressure of inches of water and parts thereof, is made to revolve by turning the milled edge of the ring carrying the glass; by this arrangement any slight deviation of the index-hand from zero may be easily adjusted. The gauge should be held in an upright position and attached by a piece of rubber tubing to the supply-pipe under test. Gauges to indicate Exhaust as well as Pressure are made suitable for fixed positions. The makers are Messrs. Short and Mason, Hatton-garden, London, E.C.

The aërorheometer, or, as it is more generally called, the gas consumption indicator, is of the greatest value to the gas-fitter, since by its use the rate of gas consumed by any burner is readily ascertained. The principle on which it is made depends upon the size of an orifice being altered so that the quantity of gas passed in a given time will bear a comparative relation to the size of the orifice. Thorp's indicator is made in three sizes. The pocket Burner Tester and Pressure Gauge combined is invaluable, as it will show at a glance the hourly rate of gas in cubic feet passing any burner under test. The gas, after entering at the bottom, passes through the glass tube, within which is an indicating or floating disc caused to rise or fall proportionately by an actuating disc according to the quantity passing the burner. From the actuating disc, which works within a tapered metal tube placed above, is suspended the indicating disc by a glass rod. In order to test the consumption of any burner, the indicator is screwed on to the fitting instead of the burner, and the latter is then screwed into the top of the indicator. When the gas is turned on, the disc will be raised in the tube depending upon the specific gravity of the gas to a position corresponding with some figure on the scale at

the side, indicating the quantity of gas consumed per hour. Thereby a wasteful or inferior burner is soon detected. To use the instrument as a pressure gauge a cap (shown in the sectional view), provided for the purpose, must be screwed on instead of a burner, and the indications on the opposite scale are correct independent of the specific

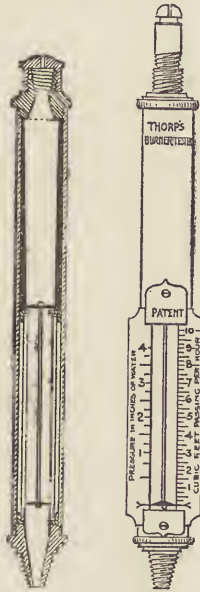

FIG. 132.

gravity of the gas. Fig. 132 illustrates the smallest or 0 to 10 ft. size. The author having tested the instrument found it sufficiently accurate for all practical purposes for testing burner consumptions, while, as a pressure gauge, it was not quite accurate over 4 inches, but perfectly so under  $3\frac{1}{2}$  inches. The consumption test was made by meter for every  $\frac{1}{4}$  foot from 1 to 10 cubic feet, and the error did not amount to more than 2-10ths of a foot.

It is very desirable to be able to determine the presence of coal gas, especially in the case of leakage from mains and services other than by the use of a naked flame for fear of an explosion. The great difficulty is to discover the actual source of leakage. The most economical and satisfactory method is to use Ansell's patent Gas Leak Indicator. The instrument is shown in Fig. 133. The dial is about 3 in. in diameter, and graduated from 0 to 35 per cent. The presence of 5 per cent. of coal gas in air produces a mixture which is explosive when lighted from

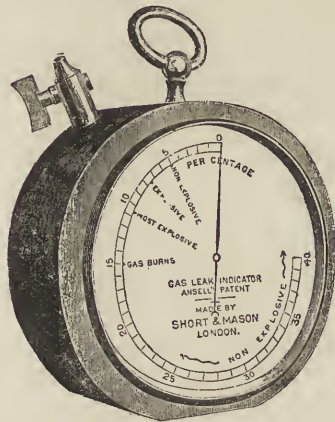

FIG. 133.

below, but if the flame is applied above the mixture, explosive firing does not occur until 9 per cent. is reached, and burns quietly when  $22\frac{1}{2}$  per cent. is present. These figures vary somewhat with the nature of the combustible gas mixed with air. The instrument is extremely sensitive in its action, and will indicate instantly the presence of gas, in any mixture of gas and air. Its simplicity, its portability, and the moderate sum at which it can be obtained, ought to place it in the hands of every responsible gas-fitter. Its

construction is based on the well-known law of diffusion of gases, viz, the velocity of diffusion of gases is inversely proportioned to the square roots of their densities—and its application is effected by the employment of an elastic metal chamber, the bottom being formed of a porous diaphragm through which a mixture of gas and air may percolate. For instance, one volume of hydrogen will pass through this porous tile in one quarter the time that it takes an equal volume of oxygen to pass. When the indicator is brought into an atmosphere charged with gas, the gaseous atoms diffuse through the diaphragm into the closed chamber with greater rapidity than the enclosed air passes out, thus causing pressure by increased volume upon the elastic surface of the chamber, and the motion thus given is imparted to clock-work, which causes the index-hand to move over the graduated dial. It takes about two minutes for the full effect of the gas to act, and this is indicated when the pointer ceases to move.

The method of procedure is to find the position of the main or service, then a searching rod, preferably hexagonal in section to facilitate its removal, is driven down to about the level of the underside of the main, a little sand or clay is placed round the top of the hole to secure a level surface. The rod is then withdrawn, and the tap of the indicator closed, after removing the brass cap which covers the diaphragm, the indicator is placed over the search-hole. If the pointer remains at zero there is no leakage of gas near that spot. Repeated trials are made at stated distances apart, and the search-holes made alternately on each side of the pipe, especially if a large one, greatly assist in determining the exact locality of a leakage in some grounds. After each trial the vent-tap must be opened, but as there is no inlet other than



through the porous tile, the instrument is apt to become less sensitive, a difficulty that has been experienced owing to a want of a free current of air to clear the instrument of gas. By having two taps instead of one, the additional one fixed at least halfway down the opposite side, the gas being lighter than air would readily be displaced by the easy incurrent of pure air entering by the lower tap. The sensitiveness of the instrument is then always good, and it will show the presence of very minute leakages and their amounts.

As regards the nature of the soil into which the search-rod is driven is a matter of importance. Some soils are very porous, as those containing ashes, and consequently any leakage from a main would readily percolate the soil. The only difficulty in this case is to keep the hole open after withdrawing the rod. On the other hand, clay soil is far from being porous, and a considerable leakage would not readily be detected until the spot was actually come upon, simply because the gas cannot find its way to travel. Other soils have the remarkable power of deodorising coal gas, and so its presence could not be detected by the senses. Under such circumstances, it is well that such an instrument as the indicator is at hand whereby a leakage of gas is discovered.

Where mains are laid in the footpaths that are paved with York stone or granolithic the search-rod is driven down at an angle through the joint, say, 3 ft. or 4 ft. Asphalte or wood paving is somewhat costly, and it does not do to take much of it up, and so the defect is spotted by trial. A clay ring is put round the mouth of the hole made by the rod, on which is placed the indicator; note the indication of the index and repeat the test at another point until the highest reading is found, which is generally

within a yard or two of the faulty pipe. The search-holes are easily repaired. The indicator is specially useful in towns where subways, sewers, electric-light conduits, or cellared buildings are contiguous to gas mains.

The Hydrogen Flame Test by Dr. Clowes is a trustworthy means of not only detecting the presence, but also the actual proportion of coal gas in admixture with the air. The presence of coal gas in air is indicated by the appearance of a pale flame or "cap" surmounting the hydrogen flame. The Ashworth-Hepplewhite-Gray

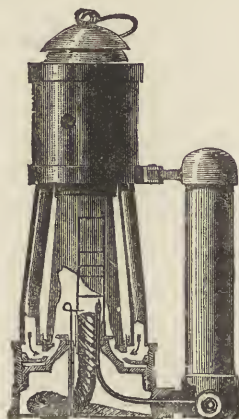

FIG. 134.

test-lamp, Fig. 134, is most generally used, as a test can be accurately made in a few seconds. The hydrogen attachment can, however, be fitted to any form of mining lamp provided the glass chimney is of sufficient length. Hydrogen gas burns, producing a flame having great heat, but emitting no light, and because of this it is specially suited for detecting small percentages of coal gas in air. The inflammable gas detector is suitable for testing the atmosphere underground, in street boxes, electric culverts

and in sewers. The hydrogen oil lamp serves for lighting and for gas-testing in the usual way, and may at any moment have a hydrogen flame in place of the oil flame without opening the lamp. The supply of

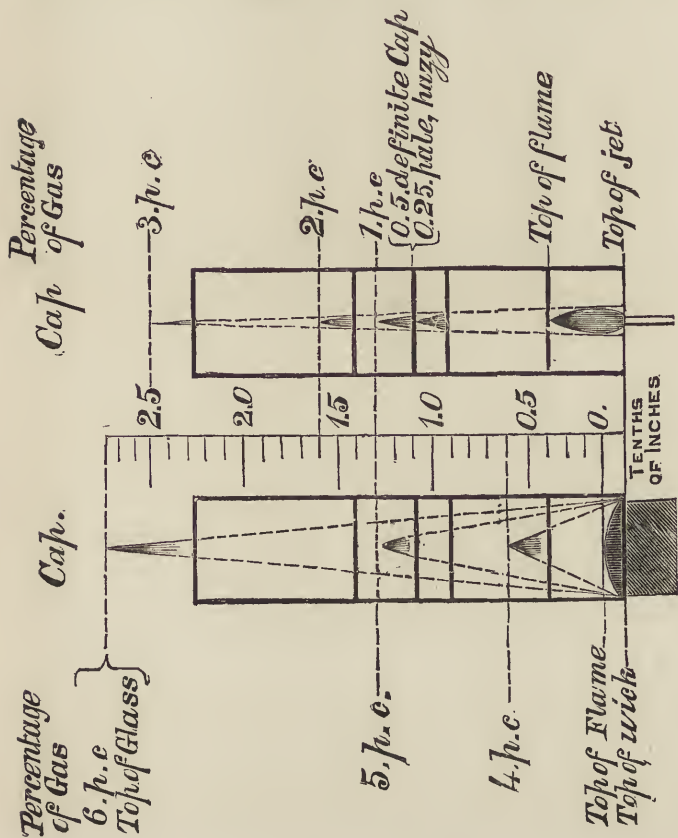

FIG. 135.

compressed hydrogen is contained in a small pocket cylinder, and is connected to the lamp by a simple attachment. The hydrogen passes from the cylinder through a copper tube, and is lighted by the oil flame,

which is then extinguished by the "pricker." The adjustment of the height of the standard hydrogen flame is of the greatest importance, because the flame-cap is constant in height for the same proportion of gas, if the test flame be always the same size. The cap height varies to a greater extent than the test flame itself does. With a test flame which is always set to an invariable height it is possible, not only to test for the presence of combustible gas, but also to determine the percentage of inflammable gas which is present, by simply measuring the height of the flame-cap. Since, also, the height of the flame-cap steadily rises with the proportion of gas in air, it is easy to supply a scale which gives for each height of the flame-cap the corresponding percentage of gas present in the air. By a simple device the standard flame can be adjusted to two different heights, and thus allow of coal-gas testing from 0.25 to 5 per cent.

Another convenient form of this detector is mounted on a tripod stand. The contaminated air is pumped direct from the space to be tested over the test flame by the use of a valved indiarubber ball, fitted with rubber tube to reach to the air space and to the apparatus. The rubber tube may be introduced into space where a man cannot enter with safety, and so the air of the place may be tested. The diagram illustrated by Fig. 135, shows the heights of the flame-caps, together with the percentage of coal gas up to 5 per cent. which each cap indicates.

The apparatus is only to be obtained of Messrs. W. J. Fraser and Co., Commercial-road, London, E.

The sense of smell for the detection of illuminating gas is unreliable, and the gas-fitter would find strips of paper impregnated with a solution of palladium, or the solution

itself, a far more reliable test. The solution is made by dissolving  $3\frac{3}{4}$  grammes of palladium chloride and  $1\frac{1}{4}$  grammes of gold chloride in a litre of distilled water. The paper is steeped in this solution and used in bore holes by inserting in a glass tube a strip of the paper. The degrees of blackening of the paper enables the operator to form some opinion of the amount and proximity of the leakage.

## CHAPTER XX.

## THE USE OF GAS AS AN AID TO VENTILATION.

THE conditions necessary, when applying gas as an auxiliary to ventilation, have not been thoroughly studied, but a few facts may be given which may at least lead to better ventilation. The subject of ventilation is a large one, and cannot be fully treated here.

First then, the amount of impurities added to the air by artificial lighting depends upon how well the gas has been purified and the method of consuming it. The chief products of complete combustion of coal gas are carbon dioxide and water, and when the gas is not too well purified a varying amount of sulphur dioxide. London gas never contains much sulphur, and when consumed yields a little over half its own volume of carbonic acid and more than its own volume of water vapour, independent of the lighting power of the gas, which, of course, depends upon the kind of gas and the class of burner employed. The kinds of burners have been discussed, and those which consume the least quantity of gas while emitting the most light, are the best from an hygienic point of view. Unless burners completely consume the gas the actual products of combustion will be carbonic acid, carbonic oxide, water vapour, with various compounds of ammonia and sulphur. Most of these products are injurious to health, and if no means of exit be provided the air of a room would become

rapidly fatal as evidenced by the three persons suffocated by the fumes of a gas fire at Oldham in the month of April, 1899. When gas is so purified that it only contains 10 grains of sulphur per 100 cubic feet the quantity of sulphur dioxide evolved by the combustion of such gas would be 0.017 of a cubic foot; but in the winter time gas often contains more sulphur compounds, as 20 grains of sulphur, then the harmful product would be 0.033 of a cubic foot. The presence of sulphurous acid in undue quantities in the air of a gaslit room is chiefly productive of injury to health—apart from the destructive action on metal and other materials—since it combines with the moisture and oxygen of the air, and so becomes converted into sulphuric acid. The whole of it would not be so converted, for it is seldom that the air of a room is at saturation point, a condition necessary for its conversion. In towns like London, where large quantities of coal are consumed in grates, the sulphurous and sulphuric acid may be twenty-five times as much as the quantity of carbonic acid in the outside air; this amount of contamination by sulphur of the inside air from the combustion of purified gas is next to impossible. One cubic foot of ordinary gas burned per hour vitiates nearly as much air as the respiration of the average individual, since the latter exhales 0.6 cubic foot of carbonic acid per hour, as against from 0.52 to 0.54 cubic foot of carbonic acid resulting from the combustion of 1 cubic foot of gas. The amount of vitiation of the atmosphere caused by one burner as compared with another in order to give an illumination equal to 48 candles is defined by the amount of oxygen removed from the air and the carbon dioxide and water vapour produced by the various illuminants.

The following table, which has been partly compiled

from figures given by Prof. Lewes, shows clearly the most hygienic method of lighting a room :—

Illuminant.	Oxygen removed from the air. Cubic feet.	Products of combustion.	
		Water Vapour. Cubic feet.	Carbonic acid. Cubic feet.
Sperm candles	28·9	19·7	32·0
Paraffin oil	18·7	10·5	29·1
London Gas	Flat-flame burners	19·5	22·0
	Argand „	17·2	19·2
	Regenerative „	8·0	6·3
	Incandescent „	3·0	4·4
Acetylene	3·8	1·5	3·0

The most hygienic light is the incandescent gas burner, if the electric incandescent lamp be left out of consideration.

The system of ventilation suited for a room lighted by incandescent gas burners would not be successful were a number of candles to give an equal illumination put in place of them. Contaminations by gas are diluted according to the amount of air entering a room, and according to doctors the human breath impurities require more fresh air dilution, and as each cubic foot of coal gas evolves at least 0·52 cubic foot of carbonic acid, about 450 cubic feet of fresh air should be supplied per hour apart altogether from the quantity required to dilute respiratory impurities and organic matter. Each person should have 3,000 cubic feet of fresh air hourly in order to keep the carbonic acid below 0·6 part per 1,000. In inhabited rooms, the organic matter and carbonic acid go together and bear a reasonable constant relative to each other, but



the organic matter or albuminoid ammonia in the air, although most injurious to life, is very difficult to estimate, there being no simple test. However, it is necessary to have ample cubic space, and sanitary authorities advocate 1,000 cubic feet per head, but this is greatly in excess of what most people can obtain in bedrooms or sleeping-rooms. The air of bedrooms is exceedingly liable to be overcharged with water vapour simply because many of them are never warmed with fires. An effort should be made to bring the atmosphere of the bedroom nearer in point of dryness and warmth to that of the atmosphere of the drawing-room, then will old persons or those with weak hearts or impaired lungs feel comfortable without that degree of suffocation so noticeable when the air is cold and damp in the rooms.

Ventilation is brought about by either *natural* or *artificial* methods. Of the first, this is really dependent upon the unequal densities of two columns of air in aiding diffusion, as chimney draughts; the other method is by means of fans, bellows, and other contrivances. Natural ventilation is best secured by unequal temperatures as between inside and outside, since diffusion alone is not sufficient as a ventilating power simply because all air impurities are not gaseous, some are molecular. If a column of air in a flue be heated it expands, and in doing so becomes lighter, therefore it ascends with a primary force producing air currents. This law of Charles applies to all gases, and depends upon three considerations:—

- (1) The difference between the temperature of the inside and outside airs.
- (2) The height of the chimney or tube containing warm air.
- (3) The area and other conditions of the opening

through which the heated air can flow out and the cooler air flow in.

Of all the methods of natural ventilation the simplest is that of open doors and windows, and even when shut in cold weather unpleasant draughts are apparent, but such means of ventilation is either productive of a cold and draughty room or a hot and close one that health becomes affected. Ventilating methods should aim at avoiding these results. A good method of ventilating as well as lighting a room is by means of a gas burner placed in a globe, as regenerative lamps, and entirely supplied with fresh air either from the room or outside, but the products of combustion conveyed directly outside. There are now many so-called ventilating gas lamps in which the products of combustion are carried off by a tube placed within a larger one. Owing to the inner tube becoming hot it acts as an extracting shaft, while the space between it and the outer one allows fresh air to enter, although it should be mentioned that very often both act as extracting shafts. In theatres and other large public buildings, this method is taken advantage of by using Sunlight burners, but this brings us to artificial ventilation. Two systems are in use, viz., ventilation by extraction and ventilation by propulsion. The chimney of an ordinary fireplace affords the simplest example of extraction. Again, gas jets placed under outlet tubes heat the polluted air and cause it to expand and escape up the tubes. In fish shops the nuisance of offensive smelling acrolein is easily abated if there be a proper "hood," fitted with a gas jet burning in it, for conducting away the fumes. Jebb's system of ventilation is one of extraction, as also the system in use in the Houses of Parliament.

In the case of ventilation by propulsion, the air is driven mechanically by fans or pumps, and has the

advantage of the certainty and ease with which any volume of air can be used, but it is expensive. Air so drawn or sucked in may be contaminated if care be not taken to ascertain the nature of the surroundings of the source of supply. The air, however, can be washed, filtered, and even warmed, and in the case of hospitals this is very desirable. The true principle of ventilation is to admit the fresh air at as low a point as possible, of so low a speed that a draught cannot be detected, and to let out the vitiated air at the highest point of the ceiling or roof into the open air. A number of modern contrivances completely overturn the fundamental principle of sound ventilation by admitting fresh air at a point near the ceiling. Now it is this hot air which ventilation should get rid of, for it is charged with the heated products of combustion and respiration, and the effect of letting cold air in upon it is to cool and condense the products and cause them to descend to be breathed over again. In rooms, halls, or churches, the vitiated air, whether arising from combustion or respiration, rises up to the ceiling and cannot escape unless proper channels are provided for its exit and due provision made for the entrance of fresh air below.

Mr. Thos. Fletcher, F.C.S., experimented some years ago on the use of gas for ventilation, and knowing that the available duty of a luminous and an atmospheric burner are precisely the same, he found that the quantity of gas required for any ventilating shaft was very small. It is simply one of convenience and suitability as to which is used in any particular place.

Experimenting with a flue 6 in. in diameter and 12 ft. high he obtained these results :—

Gas burnt per hour. Cubic feet.	Speed of current per minute.	Total air exhausted per hour.	Air exhausted per cubic foot of Gas burnt.	Temperature at outlet. Normal 62 degs. F
1	205	2460	2460	82 degs.
2	245	2940	1470	92 "
4	325	3900	975	110 "
8	415	4980	622	137 "

These experiments determined that the maximum speed of current which can be obtained with economy is about 200 ft. per minute, and this, with the consumption of 1 cubic foot of gas per hour; also, that the maximum consumption of gas in a ventilating flue should not exceed 5 cubic feet per hour for each circular foot area of section.

To double the speed of current eight times the quantity of gas must be burnt, while the effective duty per cubic foot is reduced to one-fourth.

With regard to heating and ventilation, Mr. Fletcher agrees with the architects' basis of calculation, *i.e.*, the cubic air-space enclosed, is perfectly correct for ventilation but not for warming, as it is not of the slightest use in calculating the heating power required. The heat absorbed by air is infinitesimal in quantity and so may be neglected, but the heat absorbed by the walls is very great. The results of numerous experiments on both a large and a small scale show that in an ordinary building without skylights, nearly one-half of a British thermal unit is absorbed by each square foot of wall surface per hour for every 1 deg. Fahr. rise over the normal temperature maintained after the first warming up is complete.

The rule was discovered that for every 1,200 square feet of wall surface a gas consumption of one cubic foot

per hour maintained a rise of 1 deg. Fahr. when the air in the room was changed every hour; if the air be entirely removed every 20 minutes,  $37\frac{1}{2}$  per cent., or a little over one-third was used in warming this air, and the gas consumption for the same result rose to  $1\frac{1}{4}$  cubic feet per hour for every 1 deg. rise *maintained*. If the temperature of a room has to be raised quickly the proportion of heat absorbed by the walls increases greatly, as does the gas consumption, but the fact remains that whatever the heat required to warm the walls, and lost in this way, the heating of the air required only 1 cubic foot per hour per 1,200 square feet of wall surface for every 3 degs. Fahr. rise of temperature, when all the air in the room was entirely renewed every 20 minutes, a fair average for ordinary living rooms. Under the heading of gas ranges will be found the heating value of coal gas in thermal units.

## CHAPTER XXI.

METHODS OF CALCULATING THE SIZE OF PIPES AND  
THEIR DELIVERING CAPACITIES IN CUBIC FEET  
PER HOUR.

WHAT size of pipe must be laid to supply a certain number of lights? is a question the gas-fitter is frequently called upon to solve. The chief factors that affect the solution are the distance to which the gas has to be conveyed, the pressure that is available for the transmission, and the number of lights or quantity of gas to be supplied. Most calculations make no allowance for obstruction by water or other deposit, apart from friction which tends to check the flow of gas through pipes. The kind or quality of gas influences the amount discharged.

Gas pipes, unlike most other pipes, are always running full capacity or bore independent of the diameter and length; but the friction of the gas against the internal surface varies in the different pipes according to their size. The smaller the pipe the greater the friction per unit of gas delivered in a given time. Therefore, when gas passes through pipes the velocity of its motion is consequently greater at the axis than it is at the periphery. It is usual to assume that the mean velocity of the flow of gas in a round pipe is the same as that at a point situated at a distance from the periphery equal to one-third of the radius. This, however, is only approximately correct, and Herr Jurisch has shown this to be so by a number of experiments. When a greater degree of accuracy is necessary in a determination of this kind, the velocities of flow at various distances from the side must be measured and the average

value deduced therefrom. One series of determinations may be cited where gases were allowed to pass through a leaden pipe of 10.75 in. radius. The velocities in feet per second were measured by a Fletcher's anemometer at different distances from the side. At 1 in., 4.038; at 2 in., 4.514; at 3 in., 4.945; at 4 in. 5.342; at 5 in., 5.710; at 7 in., 6.056; at 8 in., 6.056.

The retardation due to skin friction is here well shown. Now the mean velocity calculated over the whole cross-sectional area of the pipe is 4.97 feet per second, whereas at one-third of the radius the velocity is 5.10 feet per second, or 102.6 per cent. of the true value. The retardation in small pipes due to skin friction and length is very great, and is repeatedly neglected by gas-fitters.

The following tables clearly illustrate the great difference in the quantity of gas in cubic feet delivered per hour by pipes of various diameters.

Table showing the number of cubic feet that may be supplied from pipes of different diameters and lengths under 1 in. or 10-tenths pressure per hour. By dividing the cubic feet by the size of burner proposed to be used gives the number of such burners a particular size and length of pipe will supply :

Length of pipe in yards.	15	25	50	75	100
Diameter of pipe, inches.	Cubic feet.	Cubic feet.	Cubic feet.	Cubic feet.	Cubic feet.
$\frac{1}{8}$	44	40	37	32	27
$\frac{3}{4}$	114	108	95	78	67
$\frac{1}{2}$	223	212	187	152	128
$1\frac{1}{4}$	388	368	323	263	222
$1\frac{1}{2}$	613	590	507	413	345
2	1280	1225	1070	880	750
$2\frac{1}{2}$	2220	2115	1820	1520	1270
3	3497	3330	2880	2370	1975
4	7170	6800	5875	4820	4025

Also, the following table compiled from figures of A. H. Crump, compares favourably with the above, although the figures corresponding to pipes above 1 in. are greatly under the actual quantity that is delivered with 1 in. of pressure.

Length of pipe in yards.	25	50	75	100
Diameter of pipe, inches.	Cubic feet.	Cubic feet.	Cubic feet.	Cubic feet.
$\frac{1}{2}$	47	30	27	23
$\frac{3}{4}$	112	75	64	53
1	180	150	124	105
$1\frac{1}{4}$	346	248	203	173
$1\frac{1}{2}$	536	375	304	263
2	1068	741	606	522
$2\frac{1}{2}$	1762	1224	1041	864
3	2652	1908	1512	1310
4	5070	3524	2886	2496

In order that the figures may be of every-day use the gas-fitter should remember that the usual pressure on the supply varies from 1 in. to 4 in. of water, and therefore, when it exceeds 1 in. the carrying capacities of the pipes are increased directly as the square root of the pressure and inversely as the square root of the length. That is to say, with four times the pressure the quantity delivered is doubled, while with four times the length the quantity is approximately halved.

When, however, the quantity of gas delivered under a certain pressure is known and it is desired to know the volume that will be discharged under another pressure, the problem can be solved by rule of three.

Rule:—As the square root of the pressure : square root of altered pressure :: vol. : x.

Or again, when pressure and distance are given, to



know the quantity that will be delivered by a change of distance.

Rule :—Find the square root of the distances then by rule of three. It should be remembered that the greater the distance the less will be the quantity discharged.

The specific gravity of the gas has some effect on the quantity delivered since light gas travels faster than heavy gas, and therefore a smaller pipe is required for the former, in order to deliver the same volume in a given time. Illuminating gas of equal quality or candle-power may vary from 0.420 to 0.600, air being 1.000, consequently a larger pipe will be required to deliver an equal volume of the gas having a specific gravity of 0.600 than one to carry a volume of gas of specific gravity 0.420.

To find the quantity of gas delivered when the gas has a definite specific gravity to that delivered of a greater or less specific gravity.

Rule :—Multiply the vol. by the square root of its gravity and divide by the square root of the specific gravity in question.

According to these rules a 2-in. pipe has 5 to six times the carrying power of a 1 in. pipe.

Dr. Pole gives this formula :—

$$Q = 1350 D^2 \sqrt{\frac{P \times D}{G \times L}}$$

Where D=diameter of the pipes in inches.

G=specific gravity of the gas.

L=length of the pipe in yards.

P=the initial pressure in inches.

Q=quantity of gas in cubic feet per hour.

The formula by J. P. Gill, who has made allowance

for obstructions by water, &c., tending to check the flow of gas through the pipe is:—

$$Q = 1291 D^2 \sqrt{P D \div G (L + D)}$$

The last two rules involve a considerable amount of calculation, therefore, where certain service pipes and mains are known, it is often desirable to know what their relative size should be by a quicker method.

The rule is to find the square root of the sums of the squares of the diameters of the pipes, this giving the size

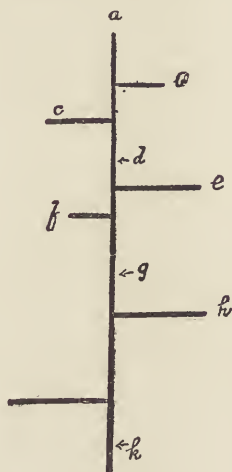

FIG. 136.

of the one required. No account is taken in these calculations of the friction of the gas in passing through the various pipes.

According to diagram 136—

$$A = 1\frac{1}{2} \text{ in.} \times 1\frac{1}{2} \text{ in.} = 2.25$$

$$B = 2 \text{ in.} \times 2 \text{ in.} = 4.0$$

$$C = 3 \text{ in.} \times 3 \text{ in.} = 9.0$$

$$\begin{array}{r} 4 \quad ) \quad 15.25 \\ \underline{\quad 16.00} \end{array} \left( 4 \text{ in. nearly diameter of pipe D.} \right.$$

Then  $15'25$

+ E = 4 in.  $\times$  4 in. = 16

+ F = 2 in.  $\times$  2 in. = 4

$\frac{6 \overline{) 35'25}}{36'00}$  ( 6 in. nearly diameter of pipe G.

Then  $35'25$

+ H = 2 in.  $\times$  2 in. = 4'0

+ I = 5 in.  $\times$  5 in. = 25'0

$\frac{8 \overline{) 64'25}}{64}$  ( 8 in. diameter of the pipe at K.  
          '2500

## CHAPTER XXII.

## FITTING UP GAS AND METER TESTING APPARATUS.

UNDER the provisions in schedule A of the Gas Works Clauses Act, 71, the apparatus for testing the illuminating power of gas shall consist of the improved form of Bunsen's photometer, known as Letheby's open 60 in. photometer, or Evans' enclosed 100 in. photometer, together with a proper meter, minute clock, governor, regulating tap and pressure gauge. The photometers used in the testing places at the present time are nearly all of the improved form of Bunsen photometer, having a bar or scale 60 in. in length, prescribed and certified by the Gas Referees.

The meter used for measuring the gas consumed in the photometer must be a wet one, having a capacity of 144 cubic inches, that is, the measuring drum on making a revolution passes one-twelfth of a cubic foot of gas. A hand is fastened directly to the axle of this drum and passes over a dial divided into one hundred equal divisions. Another form of experimental meter, having a combination index, minute clock and gas index working on one dial, the 5 ft. per hour rate of consumption and the time circle of one minute being coincident is especially convenient. Two small circles are also provided, the one on the right showing 1 ft. actual consumption and divided into 12 parts, the one on the left divided into 10 equal parts, each representing one minute. The meters are fitted with a metal water-line gauge with through sight, and a thermometer box on the side

communicating with the outlets for gas. The inlet and outlet of the meter are at the back, placed one above the other and fitted with unions. The boss of the union is to be attached to the meter or other apparatus and the cap and lining to the ends of the connecting pipes.

A delicate balance governor for maintaining uniformity of pressure at the outlet of meter is very essential. The valve is usually a long one of about 3 in. stroke, the tank and bell are made of incorrodible white metal. The inlet pipe, fitted with the valve seating, is in the centre of the tank and the outlet pipe a little to one side of it, both being fitted with a boss, the cap and lining soldered to 4 in. or 5 in. of piping, terminating with a  $\frac{3}{8}$  in. tap, to form a dripwell or syphon. Between each cap and lining and the  $\frac{3}{8}$  in. tap is inserted a tee-piece fitted with a  $\frac{3}{8}$  in. union boss.

The next piece of apparatus consisting of a micrometer or regulating tap, having a large well-fitting barrel and plug with a round or square hole in same, so that the exact or easy adjustment of the quantity of gas consumed by the standard burner may be made.

The last necessary instrument is a King's gauge, for indicating the pressure at the various points of the apparatus, having a semi-circular dial divided into 10ths and 100ths of an inch, and showing in all  $1\frac{1}{2}$  in. of pressure.

In connecting the different pieces of the apparatus together great care must be taken to avoid all sharp turns in the line of flow to the burner, although to achieve this end it may be mentioned that it really depends upon the position the instruments occupy on the photometer bench as to whether the standard burner is above, or near to the apparatus, or at the extreme end of

photometer away from them. The best piping to use for coupling the meter to the governor and governor to regulating tap is  $\frac{1}{2}$  in. tin or composition pipe, although  $\frac{3}{8}$  in. brass may be used throughout.

When brass tubing is used, the various fittings, especially the unions, should have as full a bore through them as possible. The pipe from outlet of meter to inlet of governor should have a cap and lining attached to each end. Fit on the meter cap and lining first, then carefully set the pipe—the bends being gracefully done and avoiding all kinks—with a gradual fall to the tee-piece on the inlet of governor. The pipe is here cut to suit, then the cap and lining attached. From the regulating tap to the outlet of the governor, likewise fit a pipe with a fall to the latter, having a branch pipe let in and taken to a 3-leg communicator, which latter is most conveniently situated behind the regulating tap and in communication with the pressure gauge. The communicator is formed of  $\frac{3}{8}$  in. brass pipe by bending it to the shape of an open inverted **U**. In the centre is brazed a short piece of pipe to which is screwed a  $\frac{3}{8}$  in. tap. This tap is used as a blow-off tap. At an equal distance each side of this take-off, but on the underside of the inverted **U**, a piece of pipe is let in and brazed and so forming four legs. One outside leg, usually the left hand one, is cut short and connected directly by means of an union to the pressure gauge; the other three are each fitted with a female tap at about 2 in. above the table in which  $\frac{3}{8}$  in. holes have been bored, through which short pieces of pipe pass, each then fitted under the table with a  $\frac{3}{8}$  in. union boss. A neater way to construct this communicator is to use a four-way or cross-piece and a tee. The cross-piece forming the centre, the blow-off at the top and at each side of it a

nically bent arm is screwed into the same, with a corresponding piece into the bottom-way. Into the right-hand side arm put the tee-piece with a further short piece screwed into the throughway, the centre-way of tee looking to the right. The distance between the three downward pipes being equal, screw on each a female union tap so that they are in a line with one another, and the cap and lining screwed on the pipes that come up through the holes in the table. The position on the bench for this communicator is behind the regulating tap, but so situated that the arm with the tee-piece is about an inch to the left and at right angles to the plane formed by the gas-way through regulating tap. The tee is connected with the pressure gauge by means of a piece of  $\frac{3}{8}$  in. brass pipe. The communicator and all piping including taps above the table must be burnished and lacquered. The holes bored in the bench should be the exact size of the outside measurement of the brass pipe, except, perhaps, when composition or tin piping is used, the holes for the inlet and outlet pipes of meter are best made of such size that they will allow the cap and lining of one end of connection to pass through.

The regulating tap is situated between the meter and pressure gauge. Two holes are bored in the bench when the burner is not above the apparatus, and especially when the tap is fitted with a pointer which passes over an arc graduated from zero, or position when the gas is shut off, to the opposite extremity when the gas is full on. The outlet of regulating tap is run to burner near to which insert a female tap, so that the gas may be shut off at the burner, yet be on the whole of the apparatus. This is essential in order to test the soundness of the apparatus and connections, which must be perfect before it can be used. At any

convenient point after regulating tap a tee-piece is let in and connection made therefrom to righthand leg of communicator. This pipe conveys the pressure of gas at "point of ignition" to the gauge where the amount is indicated. Likewise the branch from outlet of governor to inlet of regulating tap is connected with the centre leg and the lefthand leg in communication with the inlet of meter, so that if it be desired to know the pressure at "inlet of meter" or "outlet of governor" the tap open to "point of ignition" is shut off and the tap opened, say, in communication with the "inlet of meter" at once allows the inlet pressure to be recorded by the gauge which should fall between 12 and 14-tenths. This is the principal pressure, and must be controlled by a 3-light dry governor (mercurial) on the service-pipe in order to prevent excessive pressure at the inlet of the experimental meter. Too great a pressure not only renders a test for illuminating power inaccurate, but may blow the water out of the governor tank. To know the amount of pressure at the "outlet of meter" serves no practical purpose. Three brass plates engraved respectively "inlet of meter," "outlet of governor," and "point of ignition," should be screwed to the bench opposite the taps which put into communication with the gauge the respective pieces of apparatus.

With regard to the supply service, in all cases use  $\frac{3}{4}$  in. iron piping, as this size ensures a quick change of gas, even though the length of service may be unusually long. The service pipe should enter at least 4 in. into the main, and preferably about half-way, in order to get a fresh supply of unfrictionised gas. Where the supply is taken from the top or periphery of a main the gas which passes into the service has been subject to considerable friction, and so



impoverished to an extent ; besides skin-surface gas travels very much slower. These points should not be omitted when laying a service to supply gas for testing purposes. Endeavour, also, to give as great a fall to the service as possible by screwing on a T-piece close to the main. An upright pipe is continued from the tee to within a few inches of the surface of the ground terminating with a socket and plug. An iron road box is placed over this upright pipe to protect it from overhead traffic. The supply is continued from the centre of the tee to inside the testing-room, where provision is made for blowing the service by putting a tee with the centre-way looking up, and from this point the service should fall directly to the main. A main cock is screwed on, then to the dry governor already mentioned.

Where the photometer is supplied with the apparatus under one order, all necessary pipe fittings and connections are made up and marked to indicate their several places, rendering the work of putting together very easy ; but even then care must be taken that all the unions are not put together without a leather washer, and all threads painted with paint mixture, so that when completely fitted and subjected to inlet or 12-tenths pressure no gas may be found to pass the meter. No matter how slowly the meter may move, after due time has been allowed for the water in the governor to settle, there is leakage which must be absolutely stopped. Gas-fitting of this kind is generally under the supervision of an expert to guide the gas-fitter in the execution of his work.

In fitting up Harcourt's table photometer very little gas-fitting work is required, there being no pressure gauge, and what connections there are, they must all be made above the table. No holes are to be bored through the table.

## TESTING METERS.

Besides the Gas Referees' test there is the verification of consumer's meters which necessitates the use of a standard gas-holder of 10 cubic feet capacity, an overhead water cistern to supply water for wet meters, and a proving or level bench.

The Referees' 1 cubic foot measure required careful fixing, and when the tank of water is conveniently situated and the water of about 60 degs. Fahr, the test is very accurate and simple to perform. This measure is now abandoned for one having one-twelfth of a cubic foot

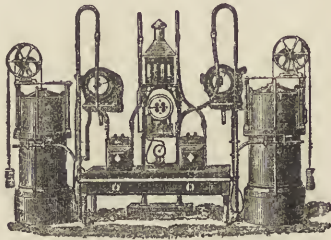

FIG. 137.

## APPARATUS FOR TESTING METERS.

capacity, requiring no special gas-fitting connections, since it consists of a blown-glass vessel having glass stop-cocks, and is to be used only for verifying experimental meters connected with illuminating power and sulphur tests. In testing these meters it is important that uniformity in the temperature of the air, gas and water exists, otherwise correction must be made. The temperatures should not vary more than 2 degs. between the water in the measure and that in the meter. Due to the dilatation of gas in contact with water at different temperatures the author

has found that where a difference exists, that for every 4 degs. variance, one way or the other, between measure and meter an error is caused equal to 1 per cent., therefore the Gas Referees only allow an error of  $\frac{1}{2}$  per cent.

In the gas meter testing stations the 10 ft. gasholders are the most elaborate piece of apparatus. Fig. 137 shows a double set of apparatus, but not strictly as is used at the present time, for instead of burning the gas as here shown, the gas is allowed to escape from a pipe through the roof into the air. Also, instead of testing small meters singly as illustrated, it is more usual to couple two or three together, noting each index separately. This saves a considerable amount of time and is quite as accurate, providing the temperatures are equal and there be no leakage in the coupling. The coupling or connection between one meter and another is not made by means of unions, but by a suitable length of composition pipe inserted into the outlet and inlet of the meters and made gas-tight with clay. This makes a perfect temporary join and is quickly and readily made. Before passing a quantity of gas through the meter, the joints are tested for soundness under 3 in. pressure by turning on the gas at the holder and closing the outlet on the last meter. Should the holder cease to fall, the meters and joints are perfect. The exact quantity of gas in the holder is noted, also that of the pointers on the meters. Now turn the gas on to the meters and pass one or more feet through them. The meter registrations are then compared with the quantity of gas passed through them, and if they correspond the meters are correct; but if they do not agree, the percentage of error is ascertained on reference to tables or calculated by rule of proportion. When a meter registers more than is sent through it, it is said to be *fast*, or when it fails to

register all the gas passed through it, then it is said to be *slow*.

By the Sales of Gas Act, a meter is held to be correct when not exceeding 2 per cent. fast or 3 per cent. slow, which latter is in favour of the gas consumer.

## CHAPTER XXIII.

## LIGHTING RAILWAY CARRIAGES AND SIGNALS.

IN recent years considerable attention has been paid to railway carriage lighting in order to do away with the old-fashioned rape-oil lamp, which is very dirty, besides requiring much attention to get but a poor light. Gas and electricity have to some extent been substituted in many of the carriages of the most important railway companies in England, and where gas has extensively been used it has proved to be far superior in every way. The North London Railway Company have lighted all their carriages by gas, the system giving every satisfaction not only to the company but to the passengers, who greatly appreciate the extra illumination, because it enables them to read with comfort even small print in any part of the compartment.

The gas used for lighting railway carriages is chiefly produced from oil by a number of systems of manufacture, of which the two principal methods in use are the Pintsch and the Pope. The oil gas produced by either of these plants is of high quality, having an illuminating power varying from 40 to 50 candles, calculated to a consumption of 5 cubic feet per hour. In each process the oil is gasified in retorts heated to about 1,800 degs. Fahr. The gas is purified in the usual manner by lime and oxide of iron, common to coal-gas manufacture. The purified oil gas is now stored in a gasholder, from which compressing pumps force it into cylindrical steel reservoirs usually put in connection with several distributing standards, from which, by suitable pressure hose, the gas can be supplied to the

portable or travelling cylinder fixed under one side of railway carriages. These receivers are of two shapes, one having recessed ends, and in all 5 ft. long; the other having domed ends and of about 6 ft. long. The former is usually fixed across the end of a composite vehicle, as a break van, with one or more compartments for passengers; the latter is placed lengthwise to the bottom of the carriage between the front and back wheels. The reason of the one being fixed across the van is to allow free play for the extra brake-gear.

By means of a pressure gauge usually graduated to indicate pressure in atmospheres and parts thereof up to 10 or 12 atmospheres, the quantity of gas forced in is indirectly known. Bourdon's patent indicator registers 12 atmospheres, while Pope's gauge represents the pressure in lbs. per square inch up to 150. It is not necessary to put so much gas in the cylinders as would force the pointer of the gauge to the maximum figure, besides the cylinders and connections might not sustain such a great pressure, and, therefore, to allow a margin of safety, the cylinders are only filled with gas to 7 atmospheres, or 105 lbs., per square inch. This allows a fair reserve. The figures that represent the maximum to be put in are coloured red, while the other figures on the dial are black. The carriage-lighting fittings comprise the cylinder to hold the gas, pressure gauge, reducing governor, connecting pipes, valved taps and lamps.

The inlet and outlet of the cylinders is by one  $\frac{1}{4}$  in. iron pipe, fitted with a  $\frac{1}{2}$  in. brass 4-way or cross-piece. The outlet of the cross, forming a through with the inlet of cylinder, is run to the governor or regulator, thence to the end of the carriage, where by the use of an elbow it is continued up a short way—about a foot—when a special

private tap is screwed on, so that the gas can be entirely turned off. The key of this tap is in the custody of the guard. From this point the service is generally reduced to  $\frac{3}{8}$  in. brass or  $\frac{1}{2}$  in. iron and continued for a further 3 ft. up the carriage, where a lever-tap is put on. Connected to this lever-tap is a bar or rod, having a handle at each end, extending to nearly the width of the carriage. When the gas is turned on by the private tap and the lamps lighted, the lever-tap can be easily manipulated from the platform, and it is by this means that the flames are adjusted to a suitable size.

Reverting to the fitting of the lamps. From the lever-tap continue with  $\frac{3}{8}$  in. brass pipe straight up to the top of the carriage, where it is "set" to the right under the ridge of the roof for a few inches before being bent over ridge and carried along the top of the carriage to the end lamp. Opposite to where each lamp comes, a tee piece is let in, and tap attached to a short piece of pipe before connecting with lamps. Very few connecting fittings, as elbows and bends, are used in turning angles or corners. The supply pipe must be carefully bent to neatly fit the recesses or projections of the carriage. The unions are generally of screwed box form, having ground-in joints with lead and rubber washers.

A pressure gauge is fitted to each side of the carriage and put in connection with the cylinder from one of the branch outlets of the 4 way. This service is reduced to  $\frac{1}{4}$  in. brass when the distance is short. The other branch of the 4-way is fitted with  $\frac{1}{4}$  in. iron pipe and run to the side of the carriage, when a special valve, provided with a union boss for connecting the hose to, is screwed on. The valve and boss may be enclosed in a tin case fixed to the carriage.

The lamps vary greatly in design, having either semi-horizontal, vertical, or circular flames. The "Coligny-Welch" lamp has many advantages over those at present used by some companies. Fig. 138 illustrates

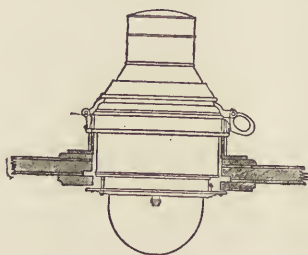

FIG. 138.

the lamp in position in part section of the roof of a carriage. Having a circular burner it is therefore shadowless, a decided advantage over those Pintsch lamps which have an arm—which obstructs light in one direction—hanging down in the bowl or combustion globe, to carry the burner or burners. It will not blow out when the train is running at a high speed, nor is the flame affected by boisterous weather. Fig. 139 represents the lamp when open for cleaning purposes. The reflector, also shown outside the lamp, simply drops into position, and so can easily be removed to clean the glass bowl. There is a hole through the casting, the lid of which (L) can be raised and a torch put through for lighting the gas. The lamp can also be opened inside the compartment if required.

The lamp is constructed on the regenerative principle, to burn  $\frac{3}{4}$  to 2 cubic feet of oil gas per hour. The lamp gives, at an angle of 67 degrees above the horizontal, an equal illumination in all directions, so that it does not matter what position in the carriage a passenger may be



sitting, the light will be free from shadows, since the burner is a circular one. The efficiency of the lamp is about 13

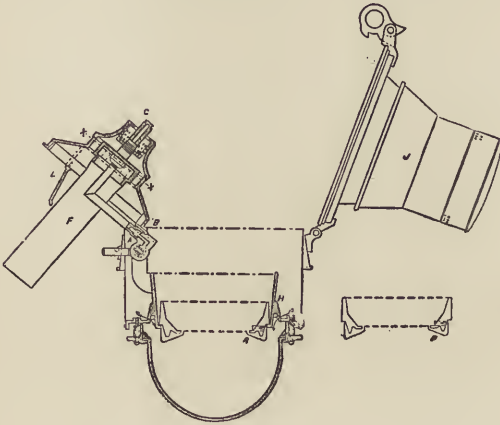

FIG. 139.

candles per foot of gas when consumed at the rate of 2 cubic feet per hour.

The most suitable flat-flame burners for Pintsch's oil gas, burning under a pressure of 5 to 6-10th of an inch, is a cased enamel burner, as Bray's, illustrated by Fig. 140. The size should be from No. 000 to 00, depending upon the quality and quantity of gas consumed. When 30 per



FIG. 140.

cent. of acetylene is mixed with the oil gas a smaller burner will be found more suitable for developing the illuminating power.

The amount of illumination for 3rd class compartments should not be less than eight candles value. For 1st class carriages, 12 candles ; but two burners placed in each Pope lamp is more satisfactory, although when circular burners are used 20 candles is more like what is provided.

The whole plant gives very little trouble, and is maintained at very small expense.

The lighting of railway signals, especially those constructed on the lattice-work principle, is best done by gas. This is generally effected by using  $\frac{1}{2}$  in. iron piping. The service is run from a convenient supply main to about 12 in. above the ground line at base of signal, then a socket and bend screwed on. A round elbow is now connected with the bend and continued up inside the lattice-work by a short piece of pipe, a tee, a further 3 in. piece, and then a cock. A plug is screwed into centre of tee, which latter is for the purpose of clearing the service, should it become blocked up. From the cock continue up with  $\frac{1}{2}$  in. barrel until the position of the lamp is reached, when screw on two bends by means of sockets, which will bring the supply immediately under the lamp. On the bend screw a lamp-cock, and burner, this completing the fitting, unless other lamps, for signals higher up, have to be supplied. These are supplied in a similar manner by inserting tee-pieces at suitable points in the rising pipe, into these screw short pieces of pipe, then a bend and finish as described. The rising pipe is secured to the lattice-work by copper wire.

Lamps for covered railway stations should be fitted with three batswing burners and fixed at intervals of not more than 36 ft. down the centre of the platform. If incandescent burners are used some form of anti-vibrating fitting should be used. The Great Central Railway is

lighted to some extent by the "intensified" incandescent gas lighting, employing three Somzée-Greyson burners in Sugg's Lambeth pattern lanterns, and giving great satisfaction.

# INDEX.



## A

- Abatement of smells, 213.
- Acetylene, 208, 245, 313.
  - „ combustion of, 246.
- Adjustable Bray burners, 111, 232, 238.
  - „ pedestal, 93.
- Advantages of coal gas as a fuel, 79, 206.
  - „ of coal gas flames, 262.
  - „ of cutting a hole in a main, 39.
- Advertising lamps for shops, 163.
- Aërorheometer, 277.
- Albo-carbon light, 244.
- Angles of orifices in burners, 229, 230.
- Angus Smith's method of coating pipes, 37.
- Ansell's gas leak indicator, 279.
- Antique work, to bronze, 74.
- Aqua-fortis, 73.
- Arc, graduated, 303.
- Architect's scheme developed, 178.
- Architecture, studying, 117.
- Argand burner, 148, 238, 265.
- Argillaceous soil, action on pipes, 36.
- Arrangement of gas-fittings, 2.
  - „ of pipes for theatre, 149.
- Art metal work fittings, 191.
- Asbestos fires, 82.
  - „ rope, 26.
- Asphalt paving, 29.
- Assembly rooms, lighting, 152.
- Atlantic gas tubing, 224.
- Atmosphere, to moisten the, 92.

- Atmospheric burner, 152.
- Auer-Bec (Welsbach) system of gas lighting, 120.
- Automatic check for burners, 220, 236.
- Average lifetime of iron services, 35.

## B

- Backnut, 41.
- Bad gas, 267.
  - „ odours from cooking stoves, 208.
  - „ smells in a house, 2.
- Badly made connections, 33.
- Balance governor, 301.
- Ball fuel, 87.
  - „ and socket joint, 70.
- Banssept burner, 254.
  - „ burner, drawback to, 256.
- Basement, meter-fixing in a, 47.
- Barff-Bower process for protecting pipes, 37.
- Batswing burners, 231.
- Beech sawdust, use of, 73.
- Beeswax, 74.
- Belt, clay and iron, 27.
- Benches, lighting, 101.
- Bend pipes, how to, 106.
- Billingsgate burner, 128.
- Blacksmith's shop, fitting up, 105.
- Bladders, 25, 28.
- Blocked services, 33, 42.
- Bloomsbury parish lamp, 129.
- Blow-pipe, 43.
  - „ making, 44.
- Board schools, 179.
- Bodkin, 136.

- Boilers of galvanized iron, 213.  
 ,, attached to gas cookers, 213.
- Boiling rings, 219.
- Borax, 53, 107.
- Border lights, to construct, 144.
- Borradaile's governor, 183.
- Bossed pipe, 65.
- Boston shade, 182.
- Bottle syphon, 41.
- Bourdon's pressure gauge, 310.
- Brace-drill, 103.
- Bracket columns, 117, 121.  
 ,, columns in St Luke's parish, 122.  
 ,, lamps, 122.
- Brackets, ordinary, 122.  
 ,, parallel, 104.  
 ,, position for, 62, 71, 195.  
 ,, suspension, 194.
- Bradawl, carpenter's, 136.
- Branching services, 110.  
 ,, tees, sizes of, 115, 143.
- Brass ferrule, 70.  
 ,, fittings, 72, 100.  
 ,, set screws, 103.  
 ,, panels, 91.
- Bray's burners, 173, 203, 232, 235, 238, 313.  
 ,, canopy globe, 273.
- Brazed joints, 107.
- Bridge wood for gasaliers, 63, 188.
- British thermal unit, 206.
- Brock's patent chain tongs, 14.
- Bronze solutions, 74.
- Bronze-tape tubing, 224.
- Buckets, coloured glass, 137.
- Bundle of rushes, 226.
- Bunsen principle, 207.
- Burners, 17, 135, 228, 236.  
 ,, adjustable, 203, 233.  
 ,, Argand, 238.  
 ,, Bansept, 254.  
 ,, batwing, 231.  
 ,, Billing's non-mantle, 241.  
 ,, circular, 312.  
 ,, cock, 102.  
 ,, Denayrouze, 120, 254.  
 ,, detecting inferior, 276.  
 ,, efficiency of gas, 174, 231, 247.  
 ,, elbow, 102.  
 ,, fail to act, 173.
- Burners, Falk, Stadelmann, & Co.'s., 246.  
 ,, fixed at certain angles, 172.  
 ,, flat-flame, 185, 228.  
 ,, for gas fires, 85.  
 ,, iron, 172, 229, 235.  
 ,, nozzles clogging up, 86.  
 ,, regenerative, 241, 312.  
 ,, tester and pressure gauge, 277.  
 ,, to clear slit, 173, 247.  
 ,, tripod, 195.  
 ,, sizes of, 231.  
 ,, special, 245.  
 ,, standard boiling, 220.  
 ,, supply for Sunlight, 150.
- Burnishing chain, 73.
- Bushing-piece, 151.
- Bye-pass cocks, 112, 114, 189.  
 ,, connections for meters, 56.
- Bye-passes, 196.

## C

- Calcic carbide, 246.
- Calculating number of lights, 183.  
 ,, size of pipes, 294.
- Calorific value of coal gas, 206.
- Candle power per cubic foot of gas, 205.
- Capacity of meters, 5.
- Carbon deposits on gas burners, 247.  
 ,, monoxide limit, 207.
- Carbonaceous deposit in pipes, 217.
- Carter's union valve, 52, 193, 196.
- Carrying capacities of pipes, 296.
- Cast-iron cocks, 144.  
 ,, pipes, particulars of, 35.  
 ,, services, 10.
- Caulking tool, 27, 34.
- Cause of high gas bills, 204.
- Causing a pipe to be laid without consent, 18.
- Ceiling plates, 170.
- Cellar, meter in, 31, 47.
- Centre punch, 107.
- Chain, burnishing, 73.
- Chancel stove, 218.
- Chapel lighting, 200.
- Chimney glasses, 265.
- Chimneys, combustion glass rod, 268.

- Chimneys, improved standard globe, 269.  
 ,, Jena bulb, 269.  
 ,, mica, 267.  
 ,, patent premier rod, 268.  
 ,, the use of glass, 239, 242, 265.  
 Choice of gas-fittings for sacred buildings, 191.  
 Church lighting, 191.  
 Churches, number of lights for, 202.  
 Circles, lighting theatre, 145.  
 Clay belt, 27.  
 Clips, to make, 102.  
 Cloak-rooms, lights for, 190.  
 Codac economizing burner, 234.  
 Co-efficients of expansion of lead and iron, 26.  
 Coils of lead pipe, 43.  
 Coligny-Welch lamp, 312.  
 Collodion, use of, 259.  
 Colour of light emitted by mantles, 262.  
 ,, of school-room walls, 180.  
 ,, of wall papers, 71.  
 Coloured chimneys, 148, 267.  
 ,, fires, 138.  
 Combination bracket and column, 121.  
 ,, coal and gas ranges, 210.  
 Combustion of gas, complete, 265.  
 ,, of gas, incomplete, 229.  
 ,, of gas, products resulting from, 179.  
 Common vice-drill, 32.  
 Comparative cost of lighting, 205.  
 Comparison in public lighting, 121.  
 Compo joints, 63, 160.  
 ,, pipes, 302.  
 ,, pipe, uses for, 159.  
 Composition pipe, 61, 155.  
 Concentric tubes, 209.  
 Concert rooms, lighting, 141.  
 Condensing stoves, 81.  
 Conditions of agreement and security for gas, 20.  
 Conical cap for stove flues, 209.  
 Connecting agencies, 38.  
 ,, iron service to main pipe, 33.  
 ,, lead service to main pipe, 42.  
 Connections badly made, 33.  
 ,, for gas fires, 96.  
 ,, push on, 225.  
 Connector and byc-pass, 114.  
 Construction of floors affecting gas-fitting, 198.  
 ,, of ring pendants, 105.  
 ,, of satisfactory flue for stoves, 208.  
 Consumption of gas by burners, 110.  
 ,, of gas by Welsbach burners, 205.  
 Convector heat, 79.  
 Conveying gas to portable burners, 222.  
 Cooking stoves, 58, 206.  
 ,, stoves, difficulty with, 207.  
 Copper-bit, joints made with, 51.  
 Copper heaters, 213.  
 Coral fuel, 87.  
 Corona lights, 192, 198.  
 Cosmos gas-fitting, 182.  
 Cost of gas lighting, 184.  
 ,, of laying service pipes, 31.  
 Counter jets, 152.  
 ,, pillars, to fix, 174.  
 Coupling up meters for testing, 307.  
 Crutch, burner, 147.  
 Cubic space per head in schools, 179.  
 Cup and ball joint, 102, 161, 167, 194.  
 Cutting grooves in joists, 63.  
 ,, holes in mains, 24, 39.  
 ,, out a piece of main pipe, 25.  
 ,, threads on pipes, 53.  
 ,, wheels, 61.
- ## D
- Daily practice of meter fixing, 49.  
 Damage to walls, 122.  
 Damaging centre-piece, 68.  
 Decorative lighting, 253.  
 Defects in wrought-iron tubes, 10.  
 Deflecting frets on stoves, 208.  
 Denayrouze burner, 120, 254.  
 Dents in lead pipe, 42.  
 Deposited carbon on burners, 246, 247.  
 Deposition of water in pipes, 47.  
 Depth of pipes underground, 28.  
 Detection of gas escapes, 279.

Devices, illumination, 134.  
 ,, ordinary letter, 134.  
 Diamond Jubilee illuminations, 133.  
 Diaphragm governors, 109.  
 Die stocks, 12.  
 Diffused light, 182, 270.  
 Dilatation of gas, 306.  
 Dimensions of dry meters, 57.  
 ,, of grates, 88.  
 Diminishing elbow, 193.  
 ,, tee-piece, 193.  
 Direct light, 181.  
 Discharge of gas through pipes, 94.  
 Distance of lamp columns apart, 121.  
 Distributing chamber, 143.  
 Distribution of gas, 11.  
 Distributor, 113, 115, 192.  
 Double arm brackets, 196.  
 ,, swing brackets, 100.  
 ,, swivel, 103.  
 Down draughts, 84, 150.  
 ,, rods of pendants in a line, 194.  
 Drains and water pipes, 30.  
 Draught in chimneys and stove flues, 208.  
 Draw furnace, 106.  
 Drawback to old form of incandescent lighting, 196.  
 Dressing-rooms, supply for, 146.  
 Dressing tool, 42, 45.  
 Drill, handy, 103.  
 Drilling holes in main pipes, 24, 38.  
 Drip well, 30.  
 Drop pipe, fixing, 69.  
 Dry meter fixing, 47.  
 ,, sliding pendants, 71.  
 Duty from luminous burners, 215, 247.

## E

Earth, effects on pipes, 35.  
 ,, kinds of, 35.  
 Economic combustion of gas, 265.  
 Economical gas cooker, 212.  
 Economy of gas as a fuel, 80.  
 Eddying winds affect chimneys, 209.  
 Edging, method of, 136.  
 Effective illuminating of shop and pavement, 167.  
 ,, lighting of room, 71.

Efficiency of gas burners, 174, 205, 231, 247.  
 ,, of rail lighting for shops, 173.  
 ,, of Sunlight mantles, 262.  
 ,, of Welsbach mantles, 247.  
 Efficient burners, 228.  
 Egress of gas from burners, 230.  
 Elbow, burner, 102.  
 Elbows, male and female, 148.  
 Electric sunlight, drawback to, 150.  
 Enamelled copper, 176.  
 Enamelling pipes, 211.  
 Enlarging tee-piece, 55.  
 Entering buildings, 18.  
 Escapes of gas, 10, 15, 38.  
 Euthermic stove, 83.  
 Everlasting burner, 221.  
 Exhaust gauge, 277.  
 Expansion of lead, 26.  
 Experimental meters, 300.  
 Experiments with Welsbach burners, 257.

Exposed pipes, 64.

Pipes, to fix, 200.

## F

Fall or inclination of services, 33.  
 Female tap, 196.  
 Fenders, curb, 92.  
 Fire-bars, straight or curved, 85.  
 Fire-bricks, 85.  
 Fires, coloured, 138.  
 ,, gas, 78.  
 Fitting-up a four-storey building, 110.  
 ,, refreshment bar, 152.  
 Fittings, brass, 72, 100.  
 ,, coloured, 72, 202.  
 ,, for carriage lighting, 310.  
 ,, to bronze, 74.  
 ,, to clean old, 72.  
 ,, workshop, 113.  
 Fixing gas fires, 93.  
 ,, gas ranges, 209.  
 ,, lamp columns, 119.  
 ,, lamp columns in Paris, 120.  
 ,, lamp tops, 168.  
 ,, lamp to fascia board, 163.  
 ,, meters in shops, 156.

Fixing public lamp meters, 129.  
 ,, rails in shops, 171.  
 ,, star-lights, 174.  
 Flambeaux with dates and motto,  
 134.  
 Flame-caps, 283.  
 Flame relight, pencils of, 136.  
 Flames above horizontal line, 106.  
 Flash-lights, 144.  
 Flat-flame burners, 151, 228.  
 ,, burners, apertures in, 229.  
 ,, burners, classes of, 230.  
 ,, burners, regulating air to,  
 229.  
 Fletcher's Connaught range, 210.  
 ,, gas governor, 177.  
 ,, laws, 220.  
 Flexible metallic tubing, 225.  
 ,, metallic tubing, connec-  
 tions for, 225.  
 ,, tubing, 145, 151, 223, 224.  
 Float governors, 227.  
 Floor area of schools per head, 180.  
 Floors affecting gas-fitting, 189.  
 ,, for stoves, 208, 215.  
 ,, test, 209.  
 Flues, convoluted, 83.  
 Fly-nuts, swivel with, 103.  
 Fog, its effect on light, 262.  
 Foot-lights, 147.  
 ,, screened, 148.  
 Foot stove, 217.  
 Force pump, 15.  
 Forms of agreement, 8.  
 Formula, 297.  
 Foulis' regenerative gas-fire, 92.  
 Four groups of schools, 178.  
 Four-light pendants, 102, 183.  
 Four types of gas fires, 80.  
 Fourway fittings, 104.  
 Frets, 210.  
 Friction in gas pipes, 294.  
 Frog head-irons, 124.  
 Front-door lights, 77.  
 Fullford regenerative lamp, 243.

## G

Gallery, brass clamping, 147.  
 Galvanic action, 118.  
 Galvanizing gas pipes, 37.

Gas as an aid to ventilation, 286.  
 ,, bills not less than 40s., 132.  
 ,, hills, to reduce, 174.  
 ,, burners, 228.  
 ,, consumption indicator, 277.  
 ,, cooking burners, portable, 218.  
 ,, delivered per hour, 295.  
 ,, distribution, 11.  
 ,, escapes, 10.  
 ,, escapes, detection of, 279.  
 ,, fires, 78.  
 ,, fittings in a large theatre, 142.  
 ,, fittings for schools, 178.  
 ,, fittings for shops, 155.  
 ,, fittings for workshops, 78.  
 ,, grill, 218.  
 ,, holders, 10 ft., 307.  
 ,, joint, patent, 223, 224.  
 ,, lighting, incandescent, 72, 248.  
 ,, ranges, 206.  
 ,, rate, 16.  
 ,, standard for rehearsals, 146.  
 ,, supply for dwelling houses, 58.  
 ,, supply for public lamps, 166.  
 ,, testing apparatus, 300.  
 ,, testing services, 304.  
 ,, tubing, Atlantic, 224.  
 ,, tubing of various colours, 224.  
 ,, tubing of various kinds, 223.  
 Gasaliers, position for, 70.  
 ,, styles and forms of, 72.  
 ,, supply for, 223.  
 ,, to fix, 62, 150.  
 Gaseous fuel, 80.  
 ,, fuel, advantages of, 206.  
 ,, fuel, stoves consuming, 82.  
 Gases, obnoxious, 81, 92, 215.  
 Gasworks Clauses Act, 1847-71, 16.  
 Gauge, pressure, 110, 301.  
 General distributor, 113.  
 Geyser, 215.  
 Glass buckets for illuminations, 137.  
 Globe-lamp, sectional, 129.  
 Globes, Blondel and Psarondatri's  
 Holophane, 270.  
 ,, Bray's canopy, 273.  
 ,, comet-fitting, 273.  
 ,, for lanterns, 167.  
 ,, glass, 269.  
 ,, opal squat, 272.  
 ,, prismatic, 271.  
 ,, reflecting, 182.  
 ,, wire, 146, 190.



Globular lamp, 128.  
 Glycerine for sliding pendants, 71.  
 „ governors, 109.  
 Gold powders, 75.  
 Governors, 94, 100, 177, 183, 236,  
 304.  
 „ burners, 109, 236.  
 Grates, dimensions of, 88.  
 „ interior and complete gas, 90.  
 „ ordinary, 89.  
 Grinding sulphur with chlorate of  
 potash, 140.  
 Grooved blocks for pipe bending,  
 106.  
 Ground floor workshops, fitting up,  
 104.  
 „ rows, 147.  
 Guarded lights, 146, 190.

## H

Halliday's Clapton gas lamp, 198.  
 Handy drill, 103.  
 Harcourt's table photometer fittings,  
 305.  
 „ 10-candle standard, 242.  
 Harmful gas in a room, 81.  
 Hawkins and Barton's governor  
 burner, 203, 237.  
 Head-irons, 124.  
 Heat absorbed by air, 292.  
 „ absorbed by walls, 292.  
 „ convected, 79.  
 „ radiant, 78.  
 „ unit, 206.  
 Heaters, copper, 213.  
 „ rapid water, 214, 216.  
 Heating large rooms, 79, 292.  
 „ surface for gas stoves, 81.  
 „ value of London gas, 206.  
 „ vessels, 208.  
 „ and ventilation, 292.  
 Height of outside shop lamps, 164.  
 „ of school-rooms, 179.  
 „ to fix gas brackets, 71, 195.  
 „ to fix gasaliers, 70.  
 Hemp, 115.  
 High class cookers, 213.  
 „ power lamps, 121.  
 „ pressure gas for incandescent  
 lighting, 252.  
 Holes in pipes, to punch, 136.

Holophane globes, 270.  
 Hooks to hold pipes, 63.  
 Hot-air stoves, 79.  
 House connection, 31, 41.  
 „ in skeleton condition, 58.  
 How to bend pipes, 106.  
 „ to make blow-pipe, 44.  
 Hydraulic joint, 147.  
 Hydrogen flame test, 282.  
 Hygienic light, 288.

## I

Illuminating burner efficiency, 228.  
 „ gas, to burn, 207, 266.  
 „ power of gas, 228, 266.  
 Illumination devices, 133.  
 „ for places of worship,  
 191.  
 Illuminations across roads, 138.  
 Impure gas, 2.  
 Impurities added to air by artificial  
 lighting, 286.  
 Incandescent bracket light, 196.  
 „ burners, 253-258.  
 „ fires, 82.  
 „ gas lighting, 72, 120,  
 183, 248.  
 „ gas light pendants,  
 186, 201.  
 „ light, solid-cone, 263.  
 Inclination of service pipe, 34.  
 Incomplete combustion, 81, 190, 286.  
 Increase of pressure, 94.  
 Indiarubber cloth bags, 24, 25.  
 „ tubing, unsatisfactory,  
 145.  
 Indicator, gas leak, 279.  
 Inflammable gas detector, 282.  
 Inside lighting of shop windows, 157.  
 Inspection pieces in floor, 63.  
 Inspector's report, 8.  
 Interchangeable lamp tops, 169.  
 Interior gas grates, complete, 90.  
 Internally heated smoothing iron,  
 221.  
 Iron band for main pipes, 27.  
 „ burners, 110, 172, 229, 235.  
 „ burnishing, 73.  
 „ pipes, where to use, 98.  
 Irregular curves in pipes, 42.  
 Issue of gas from burners, 229.

## J

- Jamb rail for shops, 169.
- Jeweller's shop lighting, 156.
- Joints, how to make lead, 27-34.
  - „ in composition pipe, 64.
  - „ tinned, 53.
- Joists, cutting grooves in, 63.
- Jumping lights, 48.

## K

- Keep burners out of sight, 162.
- Kensington lamp, 128.
- Kinds of soil, 35.
- King's gauge, 301.
- Kingston lamp, 127.
- Kinking of pipes, 51.
  - „ of pipes, to prevent, 106.

## L

- Labelling services, 152.
- Lacquer, bronze, 74.
  - „ green bronze, 74.
  - „ properties of good, 75.
  - „ to remove old, 72.
- Lacquers, various, 76.
- Lamp cradle, 124.
  - „ Colman street, 127.
  - „ column made of shaft and base, 119.
  - „ columns, 117.
  - „ for railway carriages, 312.
  - „ governor, 21.
  - „ high-power, 121.
  - „ Kingston, 127.
  - „ posts, 118.
  - „ posts, fixing, 119.
  - „ puttyless, 127.
- Landlord's permission to fix, 121.
- Large services, 22.
- Law affecting gas supply, 16.
  - „ of Charles, 289.
  - „ of diffusion of gases, 280.
- Lead jointing, plumbers', 43.
  - „ joints, 56.
  - „ joints, influence of temperature on, 26.

- Lead pipe, coil of, 43.
  - „ services, running, 42, 44, 52.
- Leakage of gas, 10, 19, 38, 40, 53.
- Leaky taps, 65.
- Leather diaphragm governors, 236.
  - „ hose, 145.
  - „ washers, use of, 44, 52, 54.
- Letters, ordinary block and Roman, 134.
- Levelling bench, 28.
- Lever board, 146, 182.
  - „ cocks, 125, 148, 194.
- Life of Welsbach mantle, 260.
- Light, direct, 157.
  - „ impedes the vision, 191.
  - „ per cubic foot of gas burned, 108.
  - „ reflected, 157.
- Lighting a cased-in window, 160.
  - „ of chapels, 200, 202.
  - „ of churches, 191.
  - „ a corn exchange, 120.
  - „ lathes, 101.
  - „ railway carriages, 309.
  - „ railway signals, 314.
  - „ retail shops, 155.
  - „ schools, 180, 186.
  - „ shop windows, 157.
- Lights in theatres, controlling, 142.
  - „ suitable for school or hall, 198.
- Limit to the supply, 132.
- Location of pulpit lights, 192, 197.
- Loop-service, 99.
- Loose oven, 219.
- Lop-sided threads, 67.
- Loss of light through fog, 262.
- Low estimate, 58.
  - „ pressure gas, 58.
- Luminosity of a gas flame, cause of, 244.

## M

- Machines, gas-fittings for, 102.
- Main cock, 41, 133.
  - „ pipe drilling apparatus, 23.
  - „ service pipes, 9.
  - „ thoroughfares, lighting, 121.
- Making lead joints, 34.
  - „ joints with old lead pipe, 45.
- Male brass knee burner sockets, 108.

Mantles, efficiency of Sunlight, 262.  
 ,, Jasper, 263.  
 ,, life of Welsbach, 260.  
 ,, Mr Justice Wills on, 261.  
 ,, Sunlight, 261.  
 ,, Voelker, 263.  
 ,, (Welsbach) preparation of, 258.  
 Materials of which to make burners, 229.  
 Meaning of word street, 16.  
 Mediæval glass, 149.  
 Mercurial governors, 109, 304.  
 Mesh-net, 149.  
 Metallic flexible tube, 224.  
 Meter fixed away from main building, 182.  
 ,, fixing, 47.  
 ,, fixing in churches, 192.  
 ,, pliers, 226.  
 ,, situation for, 31, 47.  
 ,, testing, 306.  
 ,, too small, 95.  
 ,, unions, 49.  
 Metered and un-metered lamps, 21.  
 Meters, bye-pass connection of, 56.  
 ,, fixed in brick rooms, 142.  
 ,, interchangeable, 50.  
 ,, in winter, 48.  
 Method of lighting interior of shops, 173.  
 Methods of protecting services, 36-38.  
 ,, of temporarily closing mains, 28.  
 Mica chimneys, 267.  
 Micrometer tap, 301.  
 Milk-white eye screens, 186.  
 Millard's portable vice, 130.  
 Millboard, 54, 142.  
 Miller's patent racket-die stock, 12.  
 Mixing gas and air, 207.  
 Mode of laying pipes, 19, 29.  
 Model gas range, 211.  
 ,, plan of running pipes, 201.  
 Moist atmosphere, 92.  
 Molten lead, how to pour, 27.  
 Monogram devices, 134.  
 Most light from gas consumed, 111.  
 Moths are dangerous, 156.  
 Movable lights, 151.  
 Multitubular rapid boiler, 213.  
 Music halls, 141, 153.

## N

Naphey or Dolan burner, 247.  
 Naphthalene deposits, 46, 126.  
 ,, troubles, 126.  
 Nasty smells from cooking stoves, 208.  
 Nickel gauze for gas burners, 220.  
 Nipple-piece, 222.  
 Non-condensing stoves, 82.  
 Non-luminous flame, 207, 229.  
 Non-uniformity of meter unions, 49.  
 Normal candle-power of a mantel, 204.  
 Notice, length of, prior to removing meter, 18.  
 Number of lights and fires to supply, 111.  
 ,, of lights for chapels, 202.

## O

Objections to pillar lights, 199.  
 Obnoxious gases, 92, 215.  
 Obstacles in the way of gas pipes, 122.  
 Ohren's lever cock, 126.  
 Oil gas, 309.  
 ,, gas burner, 312, 313.  
 Old pipe lead, 45.  
 One cubic foot measure, 306.  
 Opal squat globe, 272.  
 Open joint, 34.  
 ,, road, to guard, 17.  
 Orders of architecture, 117.  
 Ordinary fire grate, to close, 82.  
 ,, letter devices, 134.  
 Oudrey process of colouring columns, 117.  
 Outlet spout of water heaters, 216.  
 Outside lighting of shop windows, 158.  
 Oven, loose, 219.  
 Overhead lights, position of, 105.  
 ,, lights, shadows from, 105.

## P

Paint mixture for pipes, 4, 54, 67.  
 Paper templet, 89.  
 Parallel bracket, 104, 186.

- Particulars of cast-iron pipe, 35.  
 Pass meter, 152, 157, 211.  
 Patterns of columns, 116.  
 Pavements, lamp columns on, 117.  
 Peebles' governor burners, 203, 237.  
 Pendants, four-light, 102, 183.  
 „ ring, 105.  
 „ six-light, 105, 173.  
 „ swan-necked, 167.  
 „ to clean, 73.  
 „ to fix, 62, 71, 188.  
 Perfect combustion of coal gas, 215, 249.  
 Photometers, 300.  
 Pilot lights, 144, 214.  
 Pillar lights, 193, 200.  
 „ lights, objections to, 199.  
 Pillars fixed on pews, 192, 200.  
 Pin-hole jets, price per 100, 132.  
 Pintsch gas, 309.  
 Pipe, composition, 61.  
 „ cutter, 60.  
 Pipes, delivering capacity of, 294.  
 „ defects in, 66.  
 „ enamelled, 171.  
 „ filled with sand, 106.  
 „ for underground, 9.  
 „ furred up, 217.  
 „ in plaster, 61.  
 „ painted, 188.  
 „ sizes of, 6.  
 „ to test, 7, 66.  
 Pitching irons for lamp-posts, 124.  
 Plotting out work, 142.  
 Plugs for main pipes, iron or wood, 28.  
 Plumber's bent bolt, 65.  
 „ lead joint, 43.  
 Point of ignition, 304.  
 Polytechnics, 178.  
 Pope's pressure gauge, 310.  
 Porcelain enamelled boiling burner, 220, 221.  
 Portable gas cooking burners, 218, 221.  
 „ pressure gauge, 276.  
 „ rail for shops, 171.  
 „ tube vice, 59.  
 Position for gasaliers, 70.  
 „ for meter in a theatre, 142.  
 „ for overhead lights, 105.  
 „ for pendants, 62, 71.  
 „ for pendants in chapels, 204.  
 Position for pendants in churches, 194.  
 „ for shop rails, 170.  
 „ in which to fix meter, 47.  
 „ of convenience, 48.  
 „ of gas flames, 106.  
 „ of lights in schools, 183, 186.  
 „ of supply for gas fires, 95.  
 Powders, gold and bronze, 75.  
 Precaution when cutting trench, 29.  
 Prepayment meters, 57, 59.  
 Pressure at point of ignition, 108, 230, 233.  
 „ gauge, 110, 275, 301, 310.  
 „ gauge, portable, 276.  
 „ necessity for regular, 94, III.  
 „ of gas for lighting purposes, 58, 174, 230.  
 „ of gas for stoves, 58, 94.  
 Prevent gas escaping, 25.  
 Primary supply of air for stoves, 209.  
 Prismatic globes, 271.  
 Private illuminations, 131.  
 Producer gas, 207.  
 Products of combustion of gas, 179, 207, 215, 286.  
 Promenades, lamps for, 127.  
 Property-room, supply for, 146.  
 Proportioning pipes, 58.  
 Proscenium line, 146.  
 „ lights, 147.  
 Protection of pipes, 36-38.  
 Provisional increase in size of pipe, 22.  
 Public illuminations, 131.  
 „ lamp lever cocks, 125.  
 „ lamp service, 20, 32.  
 „ lamp, supply of gas to, 20.  
 „ street lighting, 116.  
 Puffs of down draught, 209.  
 Pulpit lighting, 192, 196.  
 Punch-holes in pipe, 136.  
 Purely incidental difficulties, 110.  
 Puttyless lamps, 127.
- Q
- Quantity of gas consumed, 18.  
 „ of gas delivered by pipes, 295-297.

## R

- Radiant heat, 78.  
 Radiating stoves, 83.  
 Rail brackets, curved, 170.  
   ,, cubic capacity of shop, 171.  
   ,, in shops, to fix, 170, 172.  
   ,, lights in shop windows, 170.  
   ,, supports, 170.  
 Railway carriage lighting, 309.  
   ,, signal lighting, 314.  
   ,, station lamps, 314.  
 Ranges, Connaught, 210.  
   ,, Holborn, 211.  
   ,, model, 211.  
 Rapid water heater, 214, 216.  
 Recipes for making coloured fires, 138.  
 Reducing tee-piece, 99.  
 Reflected light from walls, 180, 186.  
 Reflecting cluster, 161.  
   ,, globes, 182.  
   ,, pendants, 185.  
   ,, shop lamp, 163.  
 Reflector, circular opal, 159.  
   ,, porcelain, 149.  
   ,, pyramid showcase, 161.  
   ,, round and square glass, 159, 273.  
   ,, stores, 80.  
   ,, white paper, 274.  
 Reflectors, 273.  
 Refractory fuel stoves, 82.  
 Refuges, 128.  
 Regenerative burner, 241.  
   ,, gas fires, 92.  
   ,, gas lamps, 173.  
 Regulating burners, 235.  
   ,, pressure in large building, 111, 176.  
 Regulator, double check gas, 176.  
   ,, Slator and Watkins', 176.  
 Relative size of service pipes, 298.  
 Removable burners in cookers, 212, 213.  
   ,, lamps, 168.  
 Repairing stoves, 213.  
 Requirements of the Educational Department, 179.  
 Resin, 52.  
 Results of experiments in France, 256.  
 Results of experiments with solid-cone, 264.  
 Retardation of gas due to skin friction, 295.  
 Retarding the evaporation of water, 71.  
 Richmond's tap for gas fires, 96.  
 Rimer taps, 24, 103.  
 Ring pendant, to make, 105.  
 Rising main, 110.  
 Roof, light reflected from, 188.  
 Roofs, kind of, 186.  
 Rubber tubing, thick-walled, 217.  
 Rule for lighting churches, 203.  
   ,, for lighting schools, 180, 185.  
 Rules, 3, 8, 180, 296, 297.  
 Running a finished house with pipes, 58.  
   ,, lead services, 42.  
   ,, services from main to meter, 22, 41.

## S

- Saddle-socket, 23.  
 Safeguard against escape of gas, 28.  
 Safety Bunsen burners, 213.  
 Sales of Gas Act, 308.  
 Saline atmosphere, 37.  
 Saws, 226.  
 Schools, kind of, 178.  
 Screw-threads of pipes, 9, 53.  
 Sealing gas taps, 133.  
 Sectional lamp columns, 119.  
 Separate services from the main, 133.  
 Service cleanser, 15.  
   ,, pipe troubles in summer and winter, 47, 126.  
   ,, gas testing, 304.  
 Services, blocked or stopped, 33, 46, 48.  
   ,, gas supply for, 30.  
   ,, methods of protecting, 36.  
   ,, size of, 32, 95.  
 Setting in a pipe, 223.  
 Shades and eye screens, 202.  
 Shamrock and thistle, with dates, 133.  
 Shifting tongs, Clark's patent, 225.  
 Simmance's down-draught preventor, 85.  
 Six-light pendants, 105.

Six sets of wing lights, 147.  
 Size of supply pipe for stoves, 59.  
 Sizes of artistic gas grates, 91.  
 ,, of gas burners, 231.  
 ,, of meter connections, 5, 50.  
 ,, of meters, 5, 50, 57.  
 ,, of pipes, 6, 91.  
 Skeleton condition of a house, 58, 155.  
 Sky borders, 145.  
 Slag-wool or silicate, use of, 212.  
 Slit gas burners, 232, 235.  
 Slow combustion burners, 237.  
 Smoke consumers, 161.  
 Smoothing iron, internally heated, 221.  
 Soapstone, 36.  
 Soapy-water lubricant, 10.  
 Soldered joint, 51.  
 Solid-cone incandescent light, 263.  
 Somzee-Greyson apparatus, 252, 315.  
 Sparks, to prevent, 25.  
 Special tee-piece, 114.  
 Specific gravity of gas, 297.  
 Standard burner, 220, 232.  
 ,, lights, 198.  
 ,, lights, pattern of, 199.  
 Standpipe, 123, 130.  
 ,, galvanized iron, 124.  
 ,, lead, 123.  
 Star burners, 137, 153, 173.  
 ,, lights, 174, 203.  
 Station lights, 146.  
 Steatite burners, 235.  
 Steel burnisher, 73.  
 Stock and dies, small hand, 12, 226.  
 Stopped standpipe, 125.  
 Stoves, gas, 80, 217.  
 Straight-threaded tees, 114.  
 Street lighting, 116.  
 String coursing, 137.  
 Stuffing-box for pendants, 71.  
 Subsoils, the effect on pipes of, 36.  
 Sugg's diaphragm burners, 238.  
 ,, Winsor burner, 235.  
 Sunlight mantle, 248, 261.  
 Supply for public lamps, 20.  
 ,, for wall brackets, 198.  
 ,, pipe for gasaliers, 68.  
 Supplies, branch, 110.  
 ,, for boxes and sunlight burner, 149.

Supporting rails in shops, 170.  
 Suspension bracket, 194.  
 Swing joint, 222.  
 Switching gas on and off, 149.  
 Swivel cock, 102.  
 Swivels, 101, 168.  
 Syphon, bottle, 41, 99, 123.  
 ,, box, 30.  
 ,, pump, 99.  
 Systems of lighting schools, 181.

## T

Talc coronet for chimney, 161.  
 Tallow, uses for, 40, 50, 65.  
 Tan-pin, 43, 51, 226.  
 Tap, female, 196.  
 Tapping holes in mains, 24.  
 Taps for gas fires, 96.  
 Tarred yarn, 26, 34.  
 Tee-joint in compo, 63.  
 Tee-piece, main, 32.  
 Tee-piece, reducing, 193.  
 Tees, steam and hot-water branching, 115.  
 Telegraph post, vice fixed to, 130.  
 Telescopic tubes, 70.  
 Temperature of cellars, 47.  
 Tenant's fixtures, 210.  
 Test the efficiency of flues, 209.  
 Testing apparatus, 300.  
 ,, gas pipes, 7.  
 ,, meters, 56.  
 Tests, incandescent burner, 256, 257.  
 ,, of adjustable burners, 234.  
 ,, with chimneys, 258.  
 Theatres and places of entertainment, 141.  
 Theory of mantle lighting, 260.  
 Thoroughfares, corners of, 127.  
 ,, to light, 116, 121.  
 Three-wheel pipe cutter, 60.  
 Thumb-screw, 55.  
 Tie rods, 202.  
 Time to inspect meters and fittings, 18.  
 Tinning a joint, 53.  
 Tin pipe, 160.  
 To clean gasaliers, 73.  
 ,, clean old fittings, 72.

- To get efficient light cheaply, 112.  
 ,, give a supply of gas, 20.  
 ,, guard against lights, 57.  
 ,, reduce gas bills, 174.  
 ,, test a system of pipes, 66.  
 Tongs, gas, 13.  
 Tools and their uses, 9.  
 ,, for stove work, 225.  
 ,, required when fixing stoves,  
 235.  
 ,, required when laying pipes,  
 24.  
 Torch, lamplighter's, 127.  
 Town halls, lighting, 153.  
 Transformation scenes, 146.  
 Transparencies, illumination, 134.  
 Triple lever cock, 128.  
 Tripod burners, 195.  
 Trough for services, 37, 150.  
 Tubes, concentric, 209.  
 ,, conical, 213.  
 ,, speaking, 224.  
 Tubing, flexible, 135, 233.  
 ,, liable to kink, 224.  
 Two methods of lighting shops,  
 159.  
 Tye-joint, 45.  
 Types of boiling rings, 220.  
 ,, of gas fires, 84.

## U

- Underground pipes, 9.  
 Undertakers, meaning of the word,  
 16.  
 Unfrictionized gas, 304.  
 Uniformity of meter unions, 50.  
 Union-jet burners, 230-233.  
 Universal swivel, 103.  
 ,, swivel with fly-nuts, 103.  
 Upraight in range flues, 210.  
 Upright back with single swing,  
 161.  
 Use of large-sized pipes, 70.  
 ,, of mica coronet on glass chim-  
 ney, 161.  
 ,, of mirrored glass, 64.  
 Uses for tallow, 40, 50.  
 Usual church gas-fittings comprise,  
 192.

## V

- Valve, Carter's, 193.  
 Vaporizing pan, 79.  
 Vauxhall lamp, 128.  
 Velocity of gas in pipes, 294.  
 Ventilating light, 161, 290.  
 Ventilation, artificial, 290.  
 ,, natural, 289.  
 ,, of rooms, 288.  
 ,, of theatres, 150, 290.  
 ,, principles of, 291.  
 Ventilators, inlet, 209.  
 Veritas gas arc lantern, 167.  
 Vice, 226.  
 ,, drill, common, 32.  
 Victoria lamp, 128.  
 Vitiation of air of gas-lit rooms, 287,  
 291.  
 Volumes of air required to complete  
 combustion, 207.

## W

- Wall brackets, 121, 198.  
 ,, brackets are troublesome, 122.  
 ,, brackets, supply for, 198.  
 ,, papers, colour of, 71.  
 Walls, colour of school-room, 180.  
 ,, damage to, 122.  
 ,, to plug, 62.  
 Warming bedrooms, 91.  
 ,, large areas, 218.  
 Waste heat, to recover, 212.  
 Water heaters, 206, 214, 216.  
 ,, pipes, 30.  
 ,, slide pendants, 70.  
 Way to keep main alive with gas,  
 25.  
 Wellington street lighting, 120.  
 Welsbach burner experiments, 257.  
 ,, "C" burner, 250.  
 ,, gas lighting in churches,  
 192.  
 ,, Kern burner, 251.  
 ,, Kern burner, advantages  
 claimed, 252.  
 ,, light *v.* gas light in fog,  
 262.  
 ,, light *v.* Sunlight, 262.  
 ,, mantle, 248, 259.

- Wet meter fixing, 47.  
,, meter in winter, 48.  
Whereabouts of syphons, 153.  
Whistling burners, 233.  
White enamelled crown plate, 212.  
Whiting and tallow mixture, 145.  
Whitworth's standard threads, 50.  
Width of pavements, 117.  
Wind, gusts of, 209.  
Winds, eddying, 209.  
Wing, back, 100.  
,, joint, 100.  
,, lights, 147.  
Winsor gas burner, 235.  
Wiped joint, 45.  
Wire globes, 146.  
Wire templet, 106.  
Wood paving, 29.  
Wooden pattress, 99.  
,, taper plug, 28.  
Wool slag, 212.  
Workrooms, lighting, 156.  
Workshop fittings, 113.  
Workshops, fitting up, 98.  
Worst subsoils, 36.

## Y

- Yarn, tarred, 26, 34.  
,, white, 34.



# PRACTICAL BOOKS

FOR

ARCHITECTS, SURVEYORS, BUILDERS,  
ARCHITECTURAL STUDENTS, &c.

PUBLISHED AND SOLD BY

**B. T. BATSFORD, 94, High Holborn,  
LONDON.**

 Books in this List are offered at Net Cash Discount Prices, and will be sent POST FREE for remittance with order.

FIFTH EDITION (25TH THOUSAND), REVISED AND GREATLY ENLARGED.  
APPROVED BY THE SCIENCE AND ART DEPARTMENT.

## **BUILDING CONSTRUCTION AND DRAWING.**

A TEXT-BOOK ON THE PRINCIPLES AND PRACTICE OF CONSTRUCTION. Specially adapted for Students in Science and Technical Schools. FIRST STAGE, OR ELEMENTARY COURSE. By CHARLES F. MITCHELL, Lecturer on Building Construction at the Polytechnic Institute, London. 360 pp. of Text, with nearly 950 Illustrations, fully dimensioned. Crown 8vo, cloth. Price 3s., Net 2s. 6d.

"AN EXCELLENT AND TRUSTWORTHY LITTLE TREATISE, PREPARED AND ILLUSTRATED IN A VERY THOROUGH AND PRACTICAL SPIRIT."—*The Builder*.

"It seems to have most of the advantages of Vols. 1 and 2 of Rivington's 'Building Construction,' with the additional ones of cheapness and conciseness, and appears to be thoroughly practical."—*Mr. J. T. Hurst, Author of the "Surveyor's Handbook."*

"The book is a model of clearness and compression, well written and admirably illustrated, and ought to be in the hands of every student of building construction."—*The Builder* (Oct. 13th, 1900).

"As a compendium of the trades connected with building in their constructive aspect, Mr. Mitchell's book will be found of much service. . . . The illustrations are accurate and clear, every part having the dimensions figured."—*Building News*.

SECOND EDITION, REVISED AND ENLARGED (8TH THOUSAND).

**BUILDING CONSTRUCTION.** A TEXT-BOOK ON THE PRINCIPLES AND PRACTICE OF CONSTRUCTION. ADVANCED AND HONOURS COURSES. By CHARLES F. MITCHELL. For the use of Students preparing for the Examinations of the Science and Art Department, the Royal Institute of British Architects, the Surveyors' Institution, the City Guilds, &c., &c. Containing 552 pp. of Text, with over 350 Illustrations, fully dimensioned. Crown 8vo, cloth. Price 5s. 6d., Net 4s. 6d.

"Mr. Mitchell's two books form unquestionably the best guide to all the mechanical part of architecture which any student can obtain at the present moment. In fact, so far as it is possible for any one to compile a satisfactory treatise on building construction, Mr. Mitchell has performed the task as well as it can be performed."—*The Builder* (Feb. 4th, 1899).

**BUILDING SPECIFICATIONS**, FOR THE USE OF ARCHITECTS, SURVEYORS, BUILDERS, &c. Comprising the Complete Specification of a Large House, Stables, Conservatory, &c., consisting of 714 numbered clauses, and giving a large proportion of the items which every class of building requires, &c.; also numerous clauses relating to special Classes of Buildings, as Warehouses, Shop-Fronts, Public Baths, Schools, Churches, Public Houses, &c., &c., and Practical Notes on all Trades and Sections. Giving many small but practical points only acquired by experience. By JOHN LEANING, F.S.I., Author of "Quantity Surveying," &c. Containing upwards of 600 pages of Text, including some 150 Illustrations. Large 8vo, cloth. Price 18s. Net. *Just published.*

[*Full prospectus sent on application.*]

**ESTIMATING: A METHOD OF PRICING BUILDERS' QUANTITIES FOR COMPETITIVE WORK.** By GEORGE STEPHENSON. Showing how to price, *without the use of a Price Book*, the Estimates of the work to be done by the Excavator, Bricklayer, Mason, Slater, Carpenter, Joiner, Ironmonger, Smith, Bellhanger, Plasterer, Plumber, Painter, &c. Fourth Edition, the Prices carefully revised. Crown 8vo, cloth. Price 6s. 6d., Net 5s. 6d.

"The author, evidently a man who has had experience, enables everyone to enter, as it were, into a builder's office and see how schedules are made out. The novice will find a good many 'wrinkles' in the book."—*Architect.*

**REPAIRS: HOW TO MEASURE AND VALUE THEM.** A Handbook for the use of Builders, Decorators, &c. By the Author of "Estimating." Second Edition, revised. Crown 8vo, cloth. Price 3s. 6d., Net 3s.

"'Repairs' is a very serviceable handbook on the subject. A good specification for repairs is given by the author, and then he proceeds from the top floor downwards, to show how to value the items, by a method of framing the estimate in the measuring book. The modus operandi is simple and soon learnt."—*The Building News.*

**THE CONDUCT OF BUILDING WORKS AND THE DUTIES OF A CLERK OF WORKS.** A HANDY GUIDE TO THE SUPERINTENDENCE OF BUILDING OPERATIONS. By J. LEANING, Author of "Quantity Surveying," "Specifications," &c. Containing 140 pp. of Text. Small crown 8vo, cloth. Price 2s. 6d., Net 2s. 2d.

**WOOD: ITS USE AS A CONSTRUCTIVE MATERIAL.** By W. STEVENSON, Author of "The Trees of Commerce." Containing 50 Illustrations. Crown 8vo, cloth. Price 4s. 6d., Net 4s.

**DRY ROT IN TIMBER.** By W. H. BIDLAKE, A.R.I.B.A. With numerous Diagrams. 8vo, cloth. Price 1s. 6d., Net 1s. 3d.

"Mr. Bidlake's contribution to the subject is a thoroughly practical and useful one." *The British Architect.*

**STRESSES AND THRUSTS.** A Text-Book for Architectural Students. By G. A. T. MIDDLETON, A.R.I.B.A. Second edition, revised, containing new chapters on the Method of Designing a Steel Lattice Girder and of a Steel Segmental Roof. With 150 Illustrative Diagrams and Folding Plates. 8vo, cloth. Price 5s., Net 4s.

"The two systems of arriving at stresses in girders are explained together, and the graphic method is dealt with in the latter part of the book with great clearness, and makes it useful to Architects, Engineers, and Students."—*The Engineer*.

**DANGEROUS STRUCTURES.** A Handbook for Practical Men. By GEO. H. BLAGROVE, Author of "Shoring, and its Application." Crown 8vo, cloth. Price 3s., Net 2s. 6d.

CONTENTS. — Chapter I. Foundations; II. Walls and Piers; III. Roofs; IV. Arches; V. Lofty Structures; VI. Stone Lintels; VII. Timber Beams; VIII. Ties; IX. Struts; X. Theory of Shoring.

"We recommend this book to all young Architects and Students of Building."

*The Architect.*

**TREATISE ON SHORING AND UNDERPINNING,** and generally dealing with Dangerous Structures. By C. H. STOCK, Architect and Surveyor. With numerous Illustrations on 10 Lithographic Plates. Second Edit., revised by F. R. FARROW, F.R.I.B.A. Large 8vo, cloth. Price 4s. 6d. Net 3s. 9d.

"The treatise is a valuable addition to the practical library of the architect and builder. It will supply a useful guide to those requiring to pass the new examination of the R.I.B.A., and the author has, with this intention, made his compilation as comprehensive as possible. We heartily recommend it to all readers."—*Building News*.

**FORTY PLATES ON BUILDING CONSTRUCTION.**

—Including Brickwork, Masonry, Carpentry, Joinery, Plumbing, Constructional Ironwork, &c., &c. By C. F. MITCHELL. Revised by Technical Teachers at the Polytechnic Institute. The size of each Plate is 20 in. by 12 in. Price, in sheets, 5s. 0d. net; or bound in cloth, price 10s. 6d., Net 8s. 6d.

**ARCHITECT'S JOINERY AND ITS ORNAMENTATION.** By F. A. FAWKES. With 63 full-page Photographic Plates, exhibiting very numerous examples of plain and enriched Mouldings, Architraves, Doors, Over-Doors, Panelling, Mantels, Over-Mantels, &c. New and enlarged Edition. Large 4to, fancy boards. Price 5s. net.

**CONCRETE: ITS USE IN BUILDING.** By THOMAS POTTER. Second Edition, greatly enlarged. Containing 500 pp. of Text, and 100 Illustrations. 2 vols., crown 8vo, cloth. Price 7s. 6d., Net 6s. 3d.

This work deals with walls, paving, roofs, floors, and other details of Concrete Construction, and fully describes the latest methods for rendering buildings fire-proof.

"A very useful treatise on Concrete, and its practical application to building."

*The Building News.*

PROFESSOR BANISTER FLETCHER'S VALUABLE TEXT-BOOKS FOR  
ARCHITECTS AND SURVEYORS.

*Arranged in Tabulated Form and fully indexed for ready reference.*

**QUANTITIES.** A Text-Book for Surveyors in tabulated form. Explanatory of the best methods adopted in the measurement of builders' work, and containing many useful hints and much valuable information. Sixth Edition, thoroughly revised and enlarged, to which is added an example of the complete Taking-off, Abstracting, and Billing in all Trades of an Entrance Lodge, of which the Plans, Elevations, and Sections are given. With 16 Lithographic Plates and numerous Illustrations in the text. Cr. 8vo, cloth. Price 7s. 6d., Net 6s.

THE MOST COMPLETE, CONCISE, AND HANDY WORK ON THE SUBJECT.

"It is no doubt the best work on the subject extant."—*The Builder*.

"A safe, comprehensive, and concise text-book on an important technical subject. We imagine few Surveyors' or Architects' shelves will be without it."—*British Architect*.

"A good treatise by a competent master of his subject."—*The Building News*.

"Of the greatest practical value to carpenters and joiners, treating as it does of a subject by no means too well understood by practical hands."—*Carpenter and Builder*.

**DILAPIDATIONS.** Fifth Edition, to 1898, revised and enlarged, with all the most recent Legal Cases and Acts, the legal portion revised by E. UTTERMARE BULLEN, Esq., Barrister-at-Law. Crown 8vo, cloth. Price 6s. 6d., Net 5s. 6d.

"An excellent compendium on the Law and Practice of the subject."—*Builder*.

**LIGHT AND AIR.** With Methods of Estimating Injuries, Reports of most recent Cases, &c. Third Edition, revised and enlarged, with 26 Coloured Diagrams, &c. Crown 8vo, cloth. Price 6s. 6d., Net 5s. 6d.

"By far the most complete and practical text-book we have seen. In it will be found the cream of all the legal definitions and decisions."—*Building News*.

**VALUATIONS AND COMPENSATIONS.** With an Appendix giving Forms of Precedents and Valuation Tables. Crown 8vo, 5s. 6d. [*New Edition in preparation.*]

"Very useful to students preparing for the examination of the Surveyors' Institution."—*Surveyor*.

**ARBITRATIONS.** Second Edition, revised in accordance with the New Arbitration Act and giving the Act in full, with an Appendix, giving all the necessary Forms. Crown 8vo, cloth. Price 5s. 6d., Net 4s. 8d.

"Will be found especially useful to young surveyors as a compendium of the knowledge which professional experience gives in more concrete form, and with infinite variety of detail."—*The Surveyor*.

"'Arbitrations,' by Professor Banister Fletcher, is a second edition of another well-known and invaluable surveyors' text-book, and their republication will be hailed with satisfaction by a wide circle of readers."—*The Building News*.

PROFESSOR BANISTER FLETCHER'S VALUABLE TEXT-BOOKS FOR ARCHITECTS AND SURVEYORS.—*continued.*

**THE LONDON BUILDING ACTS, 1894-98.** Comprising the 1894 Act, printed in extenso, together with a full Abstract giving all the Sections of the Act which relate to building, set out in Tabular Form for easy reference, and an Introduction showing the leading alterations made by the Act, together with the various Sections of Acts unrepealed, and the Bye-Laws and Regulations remaining in force. **THIRD EDITION, REVISED TO DATE (1901).** With 23 Coloured Plates, showing the thickness of walls, plans of chimneys, &c. Crown 8vo, cloth. Price 6s. 6d., Net 5s. 6d. [*In the press.*]

"It is the Law of Building for London in one volume."—*Architect.*

"The Abstract of the portion of the Act relating to building is very useful as a finger-post to the Sections in which the detailed regulations in regard to various operations of building are to be looked for—an assistance the more desirable from the fact that the Act is by no means well or systematically arranged."—*The Builder.*

"Illustrated by a series of invaluable coloured plates, showing clearly the meaning of the various clauses as regards construction."—*The Surveyor.*

*The most Complete and Valuable Work ever issued on any Craft.*

**PLASTERING—PLAIN AND DECORATIVE.** A Practical Treatise on the Art and Craft of Plastering and Modelling. Including full descriptions of the various Tools, Materials, Processes and Appliances employed. With over 50 full-page Plates, and about 500 smaller Illustrations in the Text. By WILLIAM MILLAR. With an Introduction by G. T. ROBINSON, F.S.A. Second Edition revised. Thick 4to, cloth, containing 600 pages of Text. Price 18s. net.

"This new and in many senses remarkable treatise. . . . Unquestionably contains an immense amount of valuable *first-hand* information. . . . 'Millar on Plastering' may be expected to be the standard authority on the subject for many years to come. . . . A truly monumental work."—*The Builder.*

"So vast, it might be called an encyclopædia of plastering. . . . THE BOOK IS OF PHENOMENAL CHEAPNESS AND INTEREST, AND WE CORDIALLY RECOMMEND IT."—*The Architect.*

**THE PLUMBER AND SANITARY HOUSES.** A Practical Treatise on the Principles of Internal Plumbing Work ; or the best means for effectually excluding Noxious Gases from our Houses. With a Chapter on Cowl Testing. By S. STEVENS HELLYER. Sixth Edition (1900), revised and enlarged. Containing 30 lithographic Plates and 262 woodcut Illustrations. Thick royal 8vo, cloth. Price 12s. 6d., Net 10s. 6d.

"The Sixth Edition is an exhaustive treatise on the subject of House Sanitation, comprising all that relates to Drainage, Ventilation, and Water Supply within and appertaining to the house, not only pointing out what are the best methods and apparatus, but also showing what appliances should be avoided, and the reasons for and against."—*Journal of the Royal Institute of British Architects.*

"The best Treatise existing on Practical Plumbing."—*Builder.*

**PUMPS: THEIR PRINCIPLES AND CONSTRUCTION.** A Series of Lectures delivered at the Regent Street Polytechnic. By J. WRIGHT CLARKE. With 73 Illustrations. 8vo, cloth. Price 2s. 6d., Net 2s. 2d.

**HYDRAULIC RAMS: THEIR PRINCIPLES AND CONSTRUCTION.** By J. WRIGHT CLARKE. With an Account of some Experiments carried out by the Author at the Polytechnic and in various parts of the country. Illustrated by 36 Diagrams. 8vo, cloth. Price 2s., post free.

**HOUSE DRAINAGE.** A Handbook for Architects and Building Inspectors. By G. A. T. MIDDLETON, A.R.I.B.A., Author of "Stresses and Thrusts." Second Edition, revised. Illustrated by 22 Plates and Diagrams. Crown 8vo, cloth. Price 3s. 6d., Net 3s.

"In this little book Mr. Middleton enunciates the accepted principles of House Drainage. . . . The diagrams are drawn to a good scale."—*Building News*.

*A thoroughly comprehensive and up-to-date Treatise.*

**SANITARY ENGINEERING.** A Practical Treatise on the Collection, Removal and Final Disposal of Sewage, and the Design and Construction of Works of Drainage and Sewerage, with special chapters on the Disposal of House Refuse and Sewage Sludge, and numerous Hydraulic Tables, Formulæ and Memoranda, including an extensive Series of Tables of Velocity and Discharge of Pipes and Sewers. By Colonel E. C. S. MOORE, R.E., M.S.I., Author of "Sanitary Engineering Notes," &c. Second Edition thoroughly revised and greatly enlarged. Containing 830 pp. of Text, 140 Tables, 860 Illustrations, and 92 large Folding Plates. Large thick 8vo. Price 32s. net. [*Just published.*]

"It is a great book, involving infinite labour on the part of the author, and can be recommended as undoubtedly the standard work on the subject. . . . The illustrations are most clearly drawn and reproduced, and the folding plates models of what such plates ought to be."—*The Builder*.

". . . . The book is indeed a full and complete epitome of the latest practice in sanitary engineering, and no one interested in sanitation can afford to be without a copy of so comprehensive a manual. . . . AS A BOOK OF REFERENCE IT IS SIMPLY INDISPENSABLE."—*The Public Health Engineer*.

"A work of reference which must find its way into every sanitary engineer's library. . . . We know of no single volume which contains such a mass of well-arranged information. It is encyclopædic and should take its place as the standard book on the wide and important subject with which it deals."—*The Surveyor*.

**HOT WATER HEATING, on the Low Pressure System.** Comprising the Principles involved; an Explanation of the Apparatus and its Parts; also its application to Buildings of Various Kinds. By F. A. FAWKES. Author of "Horticultural Buildings." With 32 Illustrations. 12mo. 1s.

**WATERWORKS DISTRIBUTION.** A Practical Guide to the Laying Out of Systems of distributing Mains for the Supply of Water to Cities and Towns. By J. A. McPHERSON, A.M.Inst.C.E. Fully illustrated by 19 Diagrams and 103 other Illustrations, together with a Large Chart (29" x 20") of an Example District, showing the Details and general Outlines of Distribution. Large crown 8vo, cloth. Price 6s. net. *Just published.*

"Full of practical suggestions, and may be warmly recommended to all desirous of knowing the rudiments of correct distribution, as well as to more experienced practitioners. The whole book is interesting and useful."—*Mr. C. E. Gritton, A.M.I.C.E., in the British Architect.*

**THE PRINCIPLES OF ARCHITECTURAL PLANNING.** An Analytical Treatise for the Use of Architects and others. By PERCY L. MARKS, Architect. With Notes on the Requirements of Different Classes of Buildings, and on Aspect, Privacy, Roominess, &c. With 80 Plans (many full-page), mainly of Important Buildings by well-known modern architects. Large 8vo, cloth gilt. [*In the press.*]

**PRACTICAL GASFITTING.** A Handbook relating to the Distribution of Gas in Service Pipes, the Use of Coal Gas, and the best Means of Economizing Gas from Main to Burner. By WALTER GRAFTON, F.C.S., Chemist at the Beckton Works of the Gas Light and Coke Co. With 143 Illustrations. Large crown 8vo, 5s. net. [*In the press.*]

**COUNTRY HOMES.** A Series of Illustrations of Modern English Domestic Architecture, including Examples by E. J. May, Mervyn Macartney, Arnold Mitchell, Ernest Newton, C. F. A. Voysey, Halsey Ricardo, E. Guy Dawber, C. H. B. Quennell, Wimperis, and Arber, and other architects. Containing 50 Photo-lithographic and Ink-photo Plates. Small folio. 15s. net.

The above plates have been specially selected from the Professional Journals of the last few years, as illustrating typical examples of our English Country Houses, designed by leading architects.

**NEW COTTAGE HOMES AND DETAILS.** Containing nearly 250 designs, showing plans, elevations, perspective views, and details of low-priced, medium, and first-class Cottages, Villas, Town and Country Houses, Farmhouses, Buildings, &c. With 1,500 detail Drawings and descriptive Letterpress. By Messrs. PALLISER, Architects, U.S.A. Imp. 4to, bound. 15s.

The most recent American work of the kind, and probably the most useful.

**EARLY RENAISSANCE ARCHITECTURE IN ENGLAND.** An Historical and Descriptive Account of the Tudor, Elizabethan and Jacobean Periods, 1500—1625. By J. ALFRED GOTCH, F.S.A., Author of "The Architecture of the Renaissance in England," etc. Being an Analytical Review of the Development of Elizabethan and Jacobean Architecture, in which the progress of each feature is traced and illustrated by numerous examples. With 100 photographic and other Plates and 250 Illustrations in the Text from Drawings and Photographs. Medium 8vo, cloth. 21s. net. Illustrated Prospectus post free on application. *[In the press.]*

**THE ARCHITECTURE OF THE RENAISSANCE IN ITALY.** A General View for the Use of Students and Others. By WILLIAM J. ANDERSON, A.R.I.B.A. Containing 64 full-page Plates, mostly reproduced from Photographs, and 98 Illustrations in Text. Second Edition, revised and enlarged. Large 8vo, cloth. Price 12s. 6d. net.

"A delightful and scholarly book, which should prove a boon not only to architects and students, but also to clients of the profession."—*Journal R.I.B.A.*

**BUNGALOWS AND COUNTRY RESIDENCES.** A Series of Designs and Examples of Recently Executed Works. By R. A. BRIGGS, F.R.I.B.A. Fourth and Enlarged Edition, containing 45 Photo-lithographic Plates, with descriptions, including Prices. 4to, cloth. Price 12s. 6d., Net 10s.

"The views given embrace such a variety of style, and such charm of treatment, both internal and external, that he would be hard to please who could not find among them a design of a cottage or bungalow to suit both his pocket and his æsthetic tastes."

*St. James's Budget.*

**THE ORDERS OF ARCHITECTURE.** Greek, Roman and Italian. Selected from Normand's Parallels and other Authorities, with six Original Plates, specially prepared for this Work. Edited with Notes by R. PHENÉ SPIERS, F.S.A. Third Edition. Revised and Enlarged. Containing 26 Plates. Imperial 4to, cloth. Price 10s. 6d., Net 8s. 6d.

"A most useful work for architectural students."—*British Architect.*

**DICTIONARY OF TERMS USED IN ARCHITECTURAL DESIGN AND BUILDING CONSTRUCTION.** Giving Practical Descriptions, with Technical Details of the various subjects, and French and German equivalents for the various terms. By R. S. BURN, Architect, Containing 300 pp. of Text and 38 full-page Plates. Large 8vo, cloth. Price 5s., Net 4s.

"The author has brought a vast amount of diligence and research to bear upon the work, which dissects and explains all the constituent parts of buildings, from a cathedral at one end of the gamut to a coal-cellar at the other. . . . It is generally reliable and undoubtedly of great use."—*The Builder's Journal.*



**A HISTORY OF ARCHITECTURE.** FOR THE STUDENT, CRAFTSMAN, AND AMATEUR. Being a Comparative View of the Historical Styles from the Earliest Period. By Professor BANISTER FLETCHER, F.R.I.B.A., and B. F. FLETCHER, A.R.I.B.A. With 200 Plates, 100 of which are reproduced from Photographs and the remainder from specially prepared Drawings. Fourth Edition, revised and enlarged. Thick crown 8vo, cloth gilt. 14s. [In the press.

"Concise written and profusely illustrated by plates of all the typical buildings of each country and period. . . . It will fill a void in our literature."—*Building News*.  
 ". . . The architectural student in search of any particular fact will readily find it in this most methodical work. . . . AS COMPLETE AS IT WELL CAN BE."—*The Times*.

**FARM BUILDINGS:** Their Construction and Arrangement. By A. DUDLEY CLARKE, F.S.I. Third Edition, revised and much enlarged. With new chapters on Cottages, Homesteads for Small Holdings, Iron and Wood Roofs, Repairs and Materials, Notes on Sanitary Matters, &c. With 52 full-page and other Illustrations of plans, elevations, sections, details of construction, &c. Crown 8vo, cloth. Price 6s. net.

ADOPTED AS THE TEXT-BOOK BY THE SURVEYORS' INSTITUTION.

"A book written from a practical standpoint. . . . The plans are excellent."—*Builder*.  
 "Both for the construction of new and the modernising of old buildings the book may be consulted with the fullest confidence."—*Land Agents' Record*.

**STABLE BUILDING AND STABLE FITTING.** A Handbook for the Use of Architects, Builders, and Horse Owners. By BYNG GIRAUD, Architect. With 56 Plates and 72 Illustrations in the Text. Square crown 8vo, cloth. Price 7s. 6d., Net 6s.

CONTENTS.—I. General Remarks; II. Planning and Arrangement; III. Construction; IV. Drainage; V. Paving; VI. Ventilating; VII. Fittings and Details.

"Contains a great deal of varied and useful information on the subject stored up within a small compass. . . . Mr. Giraud has had a wide and varied experience, and he has given it out for the benefit of others in a way which cannot fail to make it most thoroughly useful to all practically interested in the matter."—*British Architect*.

**HORTICULTURAL BUILDINGS:** THEIR CONSTRUCTION, HEATING, INTERIOR FITTINGS, &c. By F. A. FAWKES. Containing 300 pages of text and 123 Illustrations. Crown 8vo, paper cover. Price 1s.

**LINEAR PERSPECTIVE.** By G. A. T. MIDDLETON, A.R.I.B.A., Author of "Stresses and Thrusts," &c. Containing 17 Illustrations. Crown 8vo, paper boards. Price 1s.

"The diagrams and examples are well selected, and there are some useful remarks on shadows and reflections."—*The Building News*.

"The author deals with his subject with a care and lucidity, invaluable in a book for students, which leaves nothing to be desired."—*Carpenter and Builder*.

**ALPHABETS OLD AND NEW.** Containing over 150 complete Alphabets, 30 series of Numerals, and numerous facsimiles of Ancient Dates, &c., for the use of Craftsmen, Designers, and all Art Workers, with an Introductory Essay on "Art in the Alphabet." By LEWIS F. DAY, Author of "Nature in Ornament," &c. Crown 8vo. 3s. 6d. net.

"It goes without saying that whatever Mr. Batsford publishes and Mr. Day has to do with is presented in a good artistic form, complete, and wherever that is possible, graceful."—*The Magazine of Art*.

**A HANDBOOK OF ORNAMENT.** With 300 Plates, containing about 3,000 Illustrations of the Elements and the application of Decoration to Objects. By F. S. MEYER, Professor at the School of Applied Art, Karlsruhe. Third English Edition, revised by HUGH STANNUS, Lecturer on Applied Art at the National Art Schools, South Kensington. Thick 8vo, cloth gilt. Price 12s. 6d., Net 10s.

"A Library, a Museum, an Encyclopædia, and an Art School in one. To rival it as a book of reference, one must fill a bookcase. . . . The work is practically an epitome of a hundred Works on Design."—*The Studio*.

**A HANDBOOK OF ART SMITHING.** For the use of Practical Smiths, Designers of Ironwork, Architects, and in Art and Technical Schools. By F. S. MEYER, Author of "A Handbook of Ornament." With an Introduction to the English Edition by J. STARKIE GARDNER. Containing 214 Illustrations. Demy 8vo, cloth. Price 6s., Net 5s.

"An excellent, clear, intelligent, and, so far as its size permits, complete account of the craft of working in iron for decorative purposes."—*The Athenæum*.

**THE HISTORIC STYLES OF ORNAMENT.** Containing 1,500 Examples of the Ornament of all Countries and Periods, exhibited in 100 Plates, mostly printed in gold and colours. With Historical and Descriptive Text (containing 136 Illustrations), translated from the German of H. DOLMETSCH. Small folio, cloth gilt. Price 25s. net.

A well-selected "Grammar of Ornament," which gives particular attention to the Art of the Renaissance.

**MANUAL OF HISTORIC ORNAMENT,** being an Account of the Evolution, Tradition, and Development of Architecture and the Applied Arts, for the use of Students and Craftsmen. By RICHARD GLAZIER, A.R.I.B.A., Headmaster of the Manchester School of Art. Containing 500 Illustrations. Royal 8vo, cloth. 5s. Net.

The object of this book is to furnish students with a concise account of Historic Ornament, in which the rise of each style is noted, and its characteristic features illustrated.

**B. T. BATSFORD, 94, HIGH HOLBORN, LONDON.**



