

# AMERICAN GAME FISHES

3 1761 01537605 6

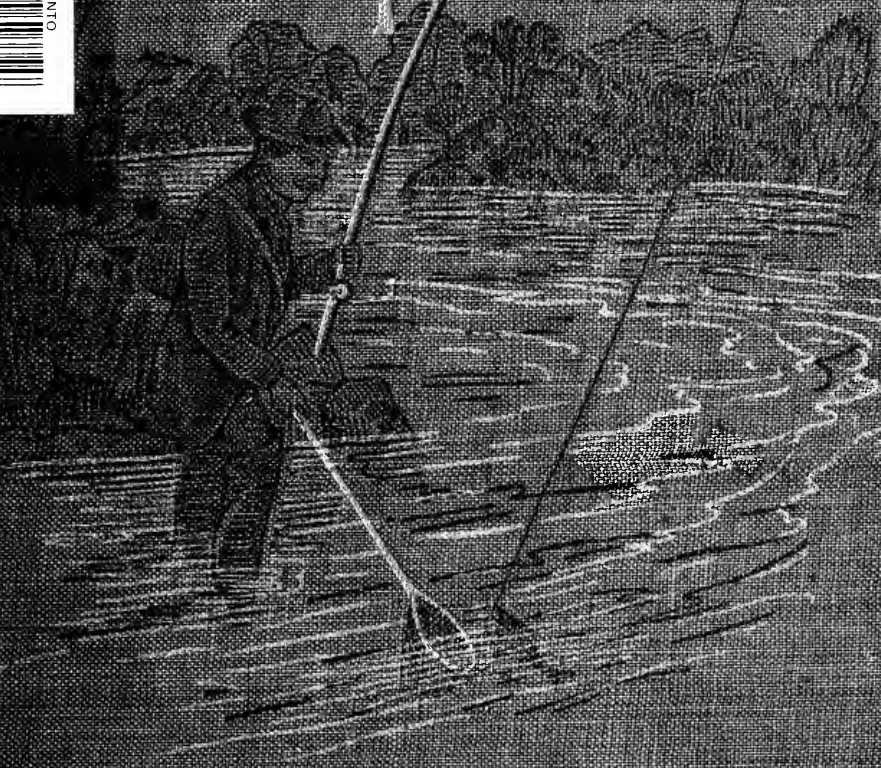

UNIVERSITY OF TORONTO



*Presented to the Faculty of Forestry*



LIBRARY

By *Frank S. Schulz MacDougall* A.D. 1969

12  
M. Complements

1914

S.B.

11/16/1914

17/1/14

1914

**LIBRARY**  
FACULTY OF FORESTRY  
UNIVERSITY OF TORONTO



Digitized by the Internet Archive  
in 2007 with funding from  
Microsoft Corporation



# AMERICAN GAME FISHES

THEIR HABITS, HABITAT,  
AND PECULIARITIES; HOW, WHEN, AND WHERE  
TO ANGLE FOR THEM.

BY

W. A. PERRY ("SILLALICUM"), A. A. MOSHER, W. H. H. MURRAY,  
W. D. TOMLIN, A. N. CHENEY, PROF. G. BROWN GOODE,  
W. N. HALDEMAN, FRANCIS ENDICOTT, FRED. MATHER,  
S. C. CLARKE, REV. LUTHER PARDEE, CHARLES HALLOCK,  
F. H. THURSTON ("KELPIE"), J. HARRINGTON KEENE,  
PROF. DAVID STARR JORDAN, WILLIAM C. HARRIS,  
B. C. MILAM, G. O. SHIELDS ("COQUINA"),  
J. G. A. CREIGHTON, DR. J. A. HENSHALL.

LIBRARY  
FACULTY OF FORESTRY  
UNIVERSITY OF TORONTO

CHICAGO AND NEW YORK:  
RAND, McNALLY & COMPANY, PUBLISHERS.

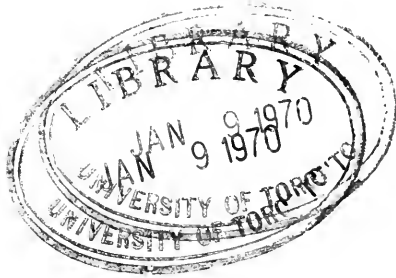

---

COPYRIGHT, 1892, BY RAND, McNALLY & Co.

---

Fish.

S. 4  
461  
A45



## P R E F A C E .

---

Some one has said that the easiest way to write a book is to get some one else to write it. I pondered over this remark for several days and then said to myself: "If it be well to get some *one* else to write it, would it not be better to get *several* others?" Surely.

And so I requested a number of my good friends, ardent anglers, careful students of Ichthyology, and men who wield the pen as gracefully as the fly-rod, to tell the world what they know of their favorites of the crystal waters. Hence this book.

It would be impossible for me to express my thanks to these gentlemen, in words, for their noble work, but every reader of this book will join me in praising their efforts and in wishing them long life and a full measure of that grand sport they have taught us to love.

One of my contributors, dear old Francis Endicott, has, since penning his charming paper on the Striped Bass, gone to his reward. Peace to his ashes! May an eternity of cool shades and sparkling waters be his portion.

THE EDITOR.



## CONTENTS.

	PAGE.
INTRODUCTION . . . . .	A. N. CHENEY. 11
THE SALMON . . . . .	CHARLES HALLOCK, 17
	Associate Editor <i>The American Angler</i> ; author of "The Sportsman's Gazetteer," etc.
THE PACIFIC SALMON . . . . .	W. A. PERRY ("Sillalicum"), 51
	Author of "Elk-Hunting in the Olympic Mountains," etc.
THE LAND-LOCKED SALMON . . . . .	J. G. A. CREIGHTON. 81
THE TARPON . . . . .	W. N. HALDEMAN, 111
	President The Louisville <i>Courier-Journal</i> Co.
THE STRIPED BASS . . . . .	FRANCIS ENDICOTT, 131
	President The National Rod and Reel Association.
THE BLACK BASS . . . . .	DR. J. A. HENSHALL, 140
	Author of "The Book of the Black Bass," "More About the Black Bass," etc.
THE BLUEFISH . . . . .	PROF. G. BROWN GOODE, 175
	Assistant Secretary The Smithsonian Institution, and author of "American Fishes," etc.
THE MASCALONGE . . . . .	DR. J. A. HENSHALL. 191
THE MASCALONGE IN WISCONSIN WATERS . . . . .	A. A. MOSHER, 199
	Ex-member of the Iowa Fish Commission.
THE BROOK TROUT . . . . .	F. H. THURSTON ("Kelpic"). 209
TROUTING ON THE NIPIGON . . . . .	W. H. H. MURRAY, 233
	Author of "Daylight Land," "Adirondack Tales," etc.

CONTENTS.

THE LAKE TROUT . . . . .	REV. LUTHER PARDEE.	237
THE ROCKY MOUNTAIN TROUT, G. O. SHIELDS ("Coquina").		267
SEA BASS, SEA TROUT, SPANISH MACKEREL, GROUPER, MANGROVE SNAPPER, SHEEPS- HEAD, AND OTHER SOUTHERN FISHES . . . . .	S. C. CLARKE,	287
	Author of "Fishes of the Atlantic Coast," etc.	
THE GRAYLING . . . . .	F. H. THURSTON.	345
THE PIKE . . . . .	W. D. TOMLIN,	367
	Secretary The Duluth Fisheries Association.	
THE WALL-EYED PIKE . . . . .	A. A. MOSHER.	381
THE PICKEREL . . . . .	W. D. TOMLIN.	387
THE WHITE PERCH . . . . .	FRED. MATHER,	397
	Late Angling Editor <i>Forest and Stream</i> , Assistant to the United States Fish Commission, and Superintendent of the New York State Fish Commission.	
THE YELLOW BASS, WHITE BASS, STRAWBERRY BASS, ROCK BASS, CRAPPIE, SUNFISH, YEL- LOW PERCH, AND MINOR PERCH AND SUN- FISHES . . . . .	PROF. DAVID STARR JORDAN,	407
	President The University of Indiana; author of "Synopsis of Fishes of North America," "Science Sketches," etc.	
THE SENSES OF FISHES . . . . .	WILLIAM C. HARRIS,	439
	Editor <i>The American Angler</i> .	
FISHING-TACKLE, AND HOW TO MAKE IT.		
	J. HARRINGTON KEENE,	445
	Author of "The Practical Fisherman," "Fishing-Tackle, Its Material and Manufacture," etc.	
REELS, THEIR USE AND ABUSE . . . . .	B. C. MILAM.	541
THE ANGLER'S CAMP OUTFIT . . . . .	G. O. SHIELDS.	549

## INTRODUCTION.

---

BY A. NELSON CHENEY.

---

THE wealth of fishes on the North American Continent known as game fishes—fishes taken for sport and for food with rod and line—is not equaled, nor is it even approached, by the fishes of any other of the grand divisions of the earth. Of Salmon and Trout alone—the chiefs of game fishes—there are, native and introduced, about thirty species, and that is but a beginning of the list of fishes which abound in the fresh and salt water of the United States and British Possessions. This grand array of fishes has been classified, and each has found its proper place in ichthyology. One or two men were equal to the task of accomplishing this scientific work, but no one or two men have attempted to give a thorough popular description of these fishes, their habits and habitat, and the manner of, and tools used in, taking them in a sportsmanlike way; nor are there one or two men on the whole continent qualified to do this work, and do it thoroughly. The country is too vast, and the waters too widely scattered, for any one man to have become on intimate terms with all of our fishes, and to have been brought into these intimate relations by actual and personal experience with them.

By mixing experience with the contents of text-books, a fair but superficial knowledge may be gathered together of the fishes of the Atlantic, Pacific, and Gulf States and coasts; but it cannot be a complete record of the life and habits of the fishes such as would be acquired by a score of anglers, widely separated, each treating of one or two fishes that he

has studied closely in all their relations, because they are his favorite fishes, and because such a study is necessary in order to be successful in their capture; for, be it understood, there are angling specialists, as well as other specialists.

Mr. Shields seems to have realized this fact in the preparation of his fine work, *AMERICAN GAME FISHES*, for in treating of a score and a half of our best fishes, and of the tools used in their capture, he has enlisted the co-operation of a score of the best writers upon the subject that are to be found in the land. They are men who are specialists as writers upon fishes, generally upon some particular fish, and their fame as such has spread wherever an interest is taken in angling or ichthyology.

The most comprehensive paper yet written concerning that fish about which there have been so many conflicting opinions, the Land-locked Salmon, or Winanishe, or Onianiche, is the one prepared by Mr. J. G. Aylwin Creighton for this volume. Its history, its distribution, its habits, and its peculiarities are treated by a master hand. The author quotes to some extent what others have said of the fish, but his own conclusions, drawn from an extended personal experience, are so clear and convincing that one accepts them unhesitatingly as authoritative, and the statement in the text that "the Winanishe and the Land-locked Salmon of Maine are identical, the only observable difference being a slight one in coloration," will be received by his readers as final. Anglers will read with regret that "any one who wants to study the Land-locked Salmon of Lake St. John and the Saguenay will have to hasten, for the opening of the region to fish-markets and to tourists, by a railway, threatens their speedy extinction."

Mr. Charles Hallock is one who years and years ago crossed the border with rod in hand to study the Salmon in its native Canadian rivers, and as he is one of the pioneer American writers about this kingly fish, his paper very appropriately opens the book.

Mr. F. H. Thurston's paper upon the fish favored of the gods—the Brook Trout—seems to sing an old, old song, with some new and delightful airs added, such as might be expected from so finished an angler and writer. He also tells us of the Grayling, another epicurean fish, which was only a short time ago apparently doomed to destruction, but which may once more become plentiful, as the woodsman and log-driver have done their worst in and about the streams where the "banner-bearer" makes its home, and must perforce permit them to return to something like their former solitude.

It is enough to say that Dr. Henshall writes of the Black Bass; it would be like gilding refined gold to say how he writes about the fish he has legally adopted and considers as his own offspring. His paper on the Mascalonge will be read with equal interest, because this is a theme upon which he has not often been heard. It will be found, however, that he has as thoroughly and carefully studied this fish as he has *Micropterus*.

Mr. Mather has selected the White Perch as his theme, a fish that is overlooked by too many anglers in summing up the game fishes, and the author has sung its praises so well that many will be tempted to seek this delicious little pan fish.

The Columbia River Salmon seems a far-away fish, and a fish in bad repute, because of the stories told of its ignoring the lure of silk and tinsel; but Mr. Perry brings the fish to our very doors, makes us better acquainted with it and increases our respect for it. He advises us that, though not æsthetic as is its Eastern cousin, it is equally robust and gamy, and that grand sport may be had in taking it on a trolling-spoon.

The Lake Trout is a fish that has had scant justice done it in the past, as a game fish, by very many anglers, and Mr. Pardee's scholarly paper is but a proper tribute to a most excellent fish on the rod and on the table. Let the angler put away heavy tackle, and seek the Lake Trout with such rod and line as one would use in fishing for Black Bass of two pounds weight, and when he fastens to a "Laker" of ten or fif-

teen pounds, he will have a very good opinion of the Mackinaw Trout. This fish has not been so much in fault as the angler and his tackle.

There is no better evidence that an angler is cosmopolitan in his fishing than to find such a confirmed Trout and Black Bass angler as Mr. Tomlin writing about the Pickerel; that this is not a fish after his own heart it is unnecessary to say, but he believes that justice should be meted out to all fish.

The Tarpon was comparatively unknown as an angler's fish half a dozen years ago; but Mr. Haldeman, from his familiarity with his subject, must have cultivated the Tarpon assiduously since it "came out."

As Mr. Mosher has had to do with bringing into the world and distributing Pike Perch, as well as many other fishes, he is an oracle upon them, and speaks by the book.

Mr. Harris has studied carefully the senses of fishes, and it is not surprising that he should be able to tell so well what they are and how they are exercised in detecting the wiles and lures of the angler.

There is a salty flavor about Mr. Endicott's chapter on Striped Bass, and it is generally supposed that it is the salt spray of the sea that has flecked his hair with white. When Mr. Shields was casting about for the man to write the best chapter that could be written about the "Salmon of the Surf," Mr. Endicott's name appeared to him something after the manner of the handwriting on the wall. I hope the ladies will read that portion of Mr. Endicott's chapter which tells of Miss Winans catching four Striped Bass weighing 177 pounds, and then try to emulate the score.

I presume every one that fishes with fine tackle has at least heard of the Kentucky reel, even if he does not possess one. Mr. Milam, who first made this reel, and who still makes them, for the first time gives, in this volume, the history of the reel, as well as an essay on reels in general. This chapter will be read with the keenest interest, and it is



worth the price of the book. Fishing-tackle is also exhaustively treated, and the angler's camp outfit as well.

I shall not attempt to particularize further, for it will be labor lost to tell how Mr. Shields writes of the Rocky Mountain Trout, that he has caught in most of the waters it inhabits; or how Prof. George Brown Goode, Dr. David Starr Jordan, and the veteran, B. C. Clarke, write of fish with which their names are associated the world over.

The book as a whole is unequaled in the history of angling literature, for the detail with which the various subjects are treated and grouped together, and no other volume presents to its readers so much valuable information by such a galaxy of star writers upon American Game Fishes.

Then, in addition to all this feast of intellectual pabulum, there is presented to the eye a rare treat in the way of accurate, truthful portraits of all the fishes treated in the volume, and besides these, there are many scenes that recall to the memory of the angler delightful dreams of days on lake, surf, or river, that will be green in his memory while reason holds her sway.



# AMERICAN GAME FISHES.

---

## THE SALMON.

---

BY CHARLES HALLOCK.

---

A CAREFUL review of the world's angling literature, from first to last, throughout its one thousand titles, more or less, in all texts and tongues, will be apt to beget the conviction that, after all that has been written, the gist of the subject was fairly covered by Dame Bernes, in her "Book of St. Albans," four centuries ago. Little in essence has been added which did not come within the scope of her speculative observation, whether it be technical, ethical, physical, metaphysical, logical, biological, or theological. If fish-lore has extended or developed since then in any direction, it has been more in the line of scientific essay than in homily, poetry, or mechanics—more in respect to distribution, nomenclature, and classification, than in the "disporte of fysshygne." It is quite probable that the Macedonians tossed the "hippurus" before the Christian era with the same "delicacy and accuracy" which experts exhibit at modern fly-casting tournaments, and that angling, pure and simple, took high rank with the artistic expression of that remote but classic age. The lesson was thoroughly inculcated then; its application and improvement came subsequently. These took shape in Walton's time, and have gradually developed into the latter-day perfection of angling literature and art—the long interim having been singularly punctured by alternate

periods of impulse and inertness. The most notable intellectual revivals occurred about the years 1486, 1590, 1676, 1750, 1800, and 1850, during which many good angling books were printed—not many of great specific worth, but all valuable as chronological landmarks to indicate what fishes existed at specified times, what have been extirpated or scattered and disseminated by economic vicissitudes and incidents of settlement, what were chiefly in request for sport or food, and what devices and methods were in vogue for their capture or protection.

During the whole of this long lapse of four centuries, less visible advance was made than in the two last decades alone. Genius and energy were long dormant. The adept had not developed. The commonplace angler at first preferred to loll on the bank and bob with worms. But art improves as the passion grows. Gradually still-fishing developed into trolling; trolling into spinning; spinning into dapping; and dapping into fishing with the fly. Silk-worm gut is first mentioned in books ("Saunder's Compleat Fisherman") in 1724, and two years later Salmon-fishing became a new experience in England. In 1746 the use of the artificial fly was introduced. It was a lost art restored. At that date the ancient *hippurus* emerges from its long obscurity, and behold! a marvelous revelation in angling is at once unfolded. Pursuit and quest were thereby stimulated and accelerated; and by and by they became ennobled!

Primitive ichthyology comprehended little more than a superficial knowledge of the habits and habitudes of a few fishes, and their general characteristics. Salmon and Trout were prominent among those which engaged early attention, for the Family *Salmonidæ* are among the oldest of post-tertiary fresh-water fish-forms, long antedating the glacial epoch; and of all its one hundred recognized species, the Salmon has held supremacy as chief from the beginning. Evolution of the ages seems not to have made him a braver,

or more comely, or more edible fish than he was in the days of Pliny and Oppian, both of whom tested his qualities and sung his praises away back in the second century, as well as others in the years before them. And his geographical range is as wide-spread as his fame. It extends around the entire Northern Hemisphere, from latitude 40 degrees up into the extreme Arctic region, belting the continents of Europe, Asia, and America, in all three of which it is indigenous and equally abundant. On the Pacific Ocean the belt dips down to the 30th parallel, and takes in the waters of Southern California on its eastern shore, and those of China and Japan on the west; but in all Atlantic waters the extreme southern limit is about 40 degrees. In Europe there is but one species (*Salar*), but in America there are several. These are divided specifically, as well as geographically, into two characteristic classes, of which one is known as *Salmo* (the leaper), and the other as *Oncorhynchus* (hook-nose). Of the latter there are five recognized species, which are enumerated as follows in Jordan & Gilbert's "Synopsis of Fishes" (1883):

SPECIES.	RANGE.
Dog Salmon ( <i>O. ketu</i> ) .....	Sacramento River to Bering Strait.
Humpback ( <i>O. gorbuscha</i> ).....	“ “ to Kotzebue Sound.
Silver Salmon ( <i>O. kisutch</i> ) .....	“ “ “ “
Blueback ( <i>O. nerka</i> ).....	Columbia River “ “
Quinnat ( <i>O. chonicha</i> ).....	Monterey to the Arctic Ocean.

The Quinnat, or King Salmon, is the most comely and valuable of the lot, and may justly be called the typical representative of the *Oncorhynchus* branch of the family. He is a much heavier fish than his congener of the Atlantic, and in the rivers of Western Alaska will average fifty pounds, individuals often running up to seventy and one hundred pounds in weight. His range is from Lower California up to Bach's Great Fish River, in the Arctic Ocean. Immense numbers ascend the large rivers of the Northern Pacific coast and Bering Sea in spring and summer, moving up a thousand miles and more, as in the Yukon, and crowding the shorter rivers when the tide is

at full flood, until every cubic foot of space is choked with fish, wedged tightly. In this helpless predicament they become an easy prey to bears and other animals, as well as men, and one can lift them out with his hands until he is tired. This rush continues until the spawning season is over, by which time most of those which have reached the distant upper waters perish from the combined exhaustion of the long journey and the labor of spawning. The passage of the river is a sickening spectacle; maimed and decaying fish in myriads offending sight and smell, and befouling the entire length of the water-courses from the sea to their sources.

Of course under such conditions the problem of fly-fishing, or any kind of rod-fishing, requires no solution. At tide-water there is always good fishing with bait and spoon, and in California and Oregon and Puget Sound these methods are much in vogue. Fish-roe incased in a double thickness of mosquito-netting is the popular bait. There are exceptional rivers, notably the Clackamas, in Oregon, where fly-fishing may be practiced at certain favorable times in special localities, the fluvial conditions being more like those of Atlantic rivers. The shorter the rivers, the greater the possibilities for sport. Fourteen Salmon are reported as having been taken from a Clackamas pool in one day by a single rod. The favorite fly is of a reddish cast, though black hackle, coachman, professor, red ibis, and a wine body with brown speckled wings, were all killing flies. June, July, and August were found to be the best months for fly-fishing.

All of these Pacific Coast fishes have their several peculiarities very strongly developed. The snout in the adult male, in summer and fall, is greatly distorted; the premaxillaries are prolonged, hooking over the lower jaw, which in turn is greatly elongated and somewhat hooked at tip; the teeth on these bones are greatly enlarged. The body becomes deep and compressed, a fleshy lump is developed in front of the dorsal fin, and the scales of the back become imbedded in the

flesh. The flesh, which is red and rich in the spring, becomes dry and poor then. They are in no respect like the shapely, symmetrical, clean, lithe, and beautiful fish which dominate the Atlantic streams.

Typically, *Salmo Quinnat* (*O. chonicha*), is described by Jordan & Gilbert as follows:

Color dusky above, often tinged with olivaceous or bluish; sides and below silvery; head dark slaty, usually darker than the body, and little spotted; back dorsal fin and tail usually profusely covered with round black spots—these are sometimes few, but very rarely altogether wanting; sides of head and caudal fin with a peculiar metallic tin-colored luster; male, about the spawning season (October), blackish, more or less tinged or blotched with dull red; head conic, rather pointed in the females and spring males. Maxillary rather slender, the small eye behind its middle. Teeth small, larger on sides of lower jaw than in front; vomerine teeth very few and weak, disappearing in the males. In the males, in late summer and fall, the jaws become elongated and distorted, and the anterior teeth much enlarged, as in the related species. The body then becomes deeper, more compressed, and arched at the shoulders, and the color nearly black. Preopercle and opercle strongly convex. Body comparatively robust, its depth greatest near its middle. Ventrals inserted behind middle of dorsal, ventral appendage half the length of the fin; caudal—unusual in this genus—strongly forked on a rather slender caudal peduncle. Flesh red and rich in spring, becoming paler in the fall as the spawning season approaches. Head 4; depth 4. B. 15–16 to 18–19, the number on the two sides always unlike; D. 11; A. 16. Gill-rakers usually 9x14—*i. e.*, 9 above the angle and 14 below. Pyloric coeca 140–185. Scales usually 27–146–29, the number in a longitudinal series varying from 140–155, and in California specimens as low as 135.

Very different is the Atlantic Salmon (*S. salar* Linnæus) to the scientific eye, when compared with the foregoing, and described by Jordan & Gilbert, to-wit:

Body moderately elongate, symmetrical, not generally compressed. Head rather low. Mouth moderate, the maxillary reaching just past the eye; its length  $2\frac{1}{2}$ –3 in head; in young specimens the maxillary is proportionately shorter. Preoperculum with a distinct lower limb, the angle rounded.

Scales comparatively large, rather largest posteriorly, silvery, and well-imbricated in the young, becoming imbedded in adult males. Coloration in the adult brownish above, the sides more or less silvery, with numerous black spots on sides of head, on body and on fins, and red patches along the sides in the males; young specimens (parrs) with about eleven dusky cross-bars, besides black spots and red patches, the color, as well as the form of the head and body, varying much with age, food, and condition; the black spots in the adult often x-shaped, or xx-shaped. Head 4; depth 4; Br. 11; D. 11; A. 9; scales 23-120 21; vertebræ 60; pyloric coeca about 65. Weight 15-40 pounds. North Atlantic, ascending all suitable rivers, and the region north of Cape Cod; sometimes permanently land-locked in lakes, where its habits and coloration (but no tangible specific characters) change somewhat, when it becomes, in America, var. *Sebago*.

The natural southern limit of the Atlantic Salmon, within historical time, was unquestionably the Hudson River. It was so when Hendrik Hudson discovered it, but subsequent geological changes must have occurred in its upper tributaries to bar the passage to suitable spawning-grounds. Its extreme northern limit has not been traced, but it has been found in a dozen of the rivers which empty into the Arctic Ocean, and its range from the Atlantic to the Pacific has been fully established. It is abundant along the entire Labrador coast, and up around Cape Chidley, its extreme northern point, in about latitude 62 degrees, and thence around the Koksok, Georges River, Whale River, and other rivers of the great Ungava Bay, on the north coast of Labrador, and thence to the western entrance of Hudson Strait, seems to be its limit in that direction.

The Arctic habitat of the Pacific Salmon begins about Wager Inlet, and the Melville Peninsula, and continues westward indefinitely. Between the Hudson Strait and Wager Inlet, the great Hudson Bay is projected southward in one tremendous indentation, and in its waters no Salmon are found—only Sea Trout. The Bay separates the family of *Salar* from the family *Oncorhynchus*, of which *Chonicha* is



ATLANTIC SALMON—*Salmo Salar*

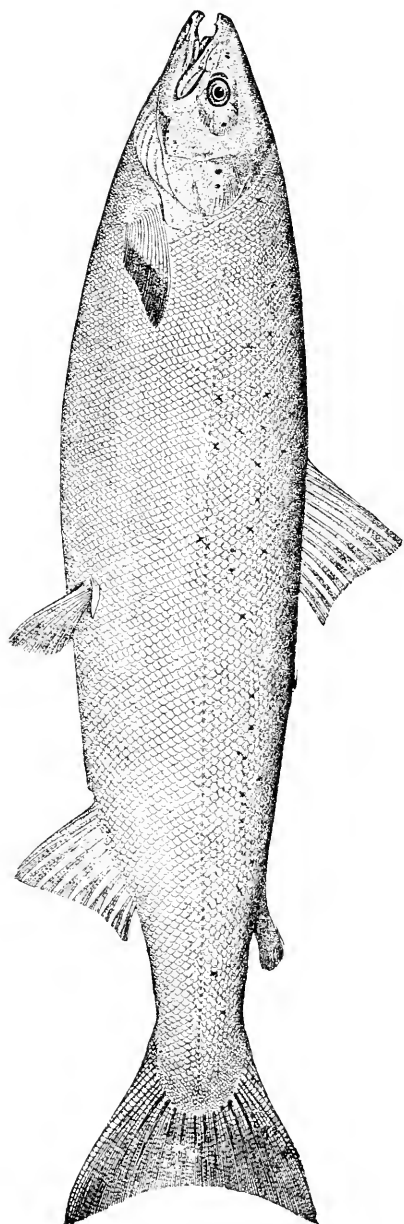

chief. Some of the Arctic rivers, like the Mackenzie, are barren of Salmon, as is true also of some Atlantic coast rivers. Doubtless there are abundant physical reasons to account for this as well as for the big break in the range of the Salmon made by the interposition of the great Hudson Bay; and when these are ascertained, scientists may be able to discover why the fish to the eastward of the Bay are of one species (*Salar*), and those to the westward of another (*Chonicha*).

In the physiology of the animal kingdom, naturalists have discovered that the quality of adaptation to environment plays an important part in bringing about and establishing those variations from original forms, which are called species. Constancy of a primitive type depends upon the constancy of external conditions. Now, it was long ago discovered that not only can many species of fish gradually accommodate themselves to either salt or fresh water, but some seem quite indifferent to rapid changes from one to the other. On this basis scientists are readily able to account for that fresh-water variety of Atlantic Salmon known as *S. Salar* var. *Sebago*, which in all respects, except the habit of anadromy, it so nearly resembles. So closely, indeed, are the generic traits maintained, that even the food materials of both the salt and fresh water species are analogous, one subsisting on caplins, and the other on its related species, the smelts, while the geographical ranges of the two are co-extensive and conterminous. Both the Atlantic and Pacific varieties are represented by fresh-water analogues: for the Land-locked Salmon are not only distributed throughout Quebec, Ontario, and the maritime provinces of Canada, as well as Maine, but they occur in the lakes of British Columbia and Idaho, and in tributary lakes of Lake Superior, where they "are called Red Trout by the natives, and grow to the size of forty pounds, and are not to be confounded with the common Lake Trout (*S. Namaycush*), whose flesh is white." (L. H. Smith, of Strathroy, Canada, in *London Field*.)

The Wananishe of the Upper Saguenay River, which were long believed to keep exclusively to fresh water, although they had direct access to the sea, have recently been ascertained to be simply a distinct class of the Sea Salmon, peculiar to its own waters, like all the others, and of precisely the same habits and idiosyncrasies; only the peculiar conformation of the Saguenay region and the extreme depth of the river have hitherto prevented such practical observations as were essential to establish the facts. In places the Saguenay is one thousand feet deep, with an extreme average depth for sixty miles from its mouth, and the Wananishe (*wa-na-nish*, in the Indian vernacular) are not seen until they reach the riffs of the chute, or Grande Discharge, which constitutes the outlet of Lake St. John. Like other Salmon enjoying the same fluvial condition, they spawn in the tributaries of the lake (in nearly all of which they occur), and pass the winters in the lake itself, where they subsist chiefly upon a species of Whitefish (*Coregonus*) called Wutouche, which is replaced by caplin, smelt, or other sub-species of *Salmonidæ* in waters elsewhere. They have a xx marking on their bodies, instead of the usual round spots; but there are Salmon in some of the other Laurentian rivers marked in precisely the same way.

Contrary to early notions, which made these land-locked fish an off-shoot of the Sea Salmon, naturalists now agree that the original habitat of the entire family *Salmonidæ* was in fresh water, and that it is the Sea Salmon which has become erratic—the disturbances of the glacial period having driven them out of their primitive inland possessions. But in obedience to the law of evolution which requires posterity to pass through the same biological changes as their progenitors did, all Salmon must be born and live for a time at least in fresh water; hence we find our Sea Salmon coming into the rivers and spending a large proportion of their time in fresh water, seeking there a change of diet and hygienic treatment against parasites and fungus. The spawning sea-

son of the Salmon is in autumn, and when they have fulfilled the requirements of nature they remain in the rivers for a greater or less period, according to the time of their arrival and impregnation, and drop back to the sea again in spring. Usually there is a spring run of Salmon which follow the sand-worms and herring-sile, and other shore food, into the estuaries and up into the rivers, often remaining until the water runs low and becomes too warm for comfort, when they drop back to the sea again. Later on come the Grilse, or Adolescent Salmon, some of them already in full sexual maturity, and after them the mid-summer and autumn runs of old fish.

The bulk of the Salmon run up in autumn for spawning purposes, only the earlier runs being for change of water and diet, and for sanitary purposes, as has already been stated. A flood or a "spate" always starts the fish up-stream, and then the fish take the fly or bait best. A great deal of bosh has been written in all the books of the Salmon, for four centuries past, about Salmon not eating, when ascending to their spawning-grounds, but that theory is now wholly exploded. They not only eat, but eat promiscuously and voraciously of a great variety of food, including young *Salmonidæ* and other salt and fresh water fish-fry, shrimps, prawns, sand-worms, crustaceans, cephalopods, and floating invertebrata. Another impression is, or was, that Salmon could only be taken with fly, whereas they readily take natural minnows, prawns, worms, artificial minnows, spoons, and a dozen other kinds of bait, as has been abundantly tested and proven. Indeed, it would not be difficult to demonstrate that fly-fishing is the recent revival of an antique art, and that baits only were at one time used by anglers of low degree. Hence their use becoming unpopular, the impression finally obtained that flies only would tempt a fish. Some of these baits, it may be observed, have been found to take best in spring, others in mid-summer, and others still in autumn. Some

take best when the water is clear, and others when it is roiled and discolored; some when the water is thin and low, and others on the surge of a mighty flood. There are no conditions or stages, it would seem, when the Salmon will not accept one or more of the above-named baits at some time or other in the course of twenty-four hours, as observers have ascertained. It is remarkable that this question should have remained open for so many centuries, and that none of the books have set the matter right.

Directly in this connection it may be mentioned that the annelids, or sand-worms, play an important part in influencing the spring movements of Salmon. At that season they swarm in from the ocean to breed on the beach flats, either swimming free like eels, in great masses, or housed in their burrows. Indeed they constitute a most important element in the economy of many kinds of fish not only of nomadic and littoral species, but of those which constantly root for them in their beds, like the Tautog, Haddock, etc. It is manifest that the pulpy bodies of these worms, as well as of much other delicate food which Salmon eat in the early spring, dissolve in their stomachs like glucose or starch. It is digested almost as soon as swallowed, and in the absence of visible sustenance superficial observers have decided that they did not eat at all.

As regards the spring run of Salmon, it would be impossible for them to sustain life for the five months intervening until autumn spawning season unless they fed, while in respect to the late autumn runs they but follow the instinct of all pregnant creatures on the eve of parturition, eating a little here and a little there, fastidious, whimsical, ravenous, and indisposed by turns. It would be inexplicable indeed if Salmon alone, of all creatures, were not required by nature to fortify and strengthen themselves for the supremest act of physical existence. Physiology will easily explain why the distended ovaries, pressing upon the stomach and intestines, will not

permit the introduction of food, except in very limited quantities, and Dr. Pancritius, of Germany, has very intelligently described the chemistry of digestion in fishes: so that these subjects are problems no more.

Possibly one reason why there has been such a wide divergence of opinion about the life-history of the Salmon is, that there is nothing constant about them, except their periodical visits to the sea and river, and these vary, not only with climatic conditions, and the extreme diversity in the length of rivers, but they are always liable to be disturbed by extraneous contributory causes, such as sudden meteorological changes, erratic movements of the small fish and fry on which they chiefly feed, raids of porpoises and seals, which split the schools up into fragments, or drive the whole body off temporarily. In the Arctic rivers there is only a mid-summer run of Salmon. There is no autumn run, for the rivers are frozen tight by the end of September. In many Laurentian rivers there are a spring, summer, and autumn run, because the rivers are kept in full supply of cold water from the reservoirs of melting snow at their sources. In rivers of extreme length, like the Columbia, Yukon, and others of the Pacific coast, the spring run of Salmon does not go back to the sea, for obvious reasons. If the fish have five hundred miles or more to ascend, they cannot afford to lose time by running in and out. High falls especially retard their progress. To surmount these they are obliged to climb their rugged abutments, which are full of pockets and crevices and projections, over which the lateral overflow is constantly spilling in greater or less quantity; and it is not altogether an impossible feat for a Salmon to mount a very high fall by these gradual steps, stopping betimes to rest his muscles and moisten his gills in the little basins which present themselves conveniently at hand. But they will not essay this side-passage until they have persistently attempted to leap the breast of the fall; hence, some careless observers have maintained against all

reason, common sense, and mathematical demonstration, that Salmon leap falls sixteen feet high and upwards! However, up the fish must go, impelled irresistibly by the instinct of procreation, which demands that they shall reach the upper waters. The time of spawning often varies in the same river, and is determined by the period at which impregnation has taken place. A portion of the run, therefore, being riper than the rest, spawn sooner, and, having fulfilled their mission, return at once to the sea, while their less fortunate belated kindred must continue their pilgrimage, perchance to headwaters; for so long as their great work remains unaccomplished, they will press on until stopped by insurmountable obstacles. Gravid fish must halt in whatever part of the river the crisis overtakes them. Such as are obliged to continue on to the upper spawning-beds arrive in sorry plight, mutilated, crushed, and almost shapeless. Fortunate are those which have vitality enough left to be able to return to the sea. Indeed, so great is the mortality, that it has been generally believed that they never return at all.

Speckled Trout are found in almost all eastern Salmon streams, and the angler who chances to try his luck in them will often pick out of the riffis fish of varying size which he looks at twice, being in doubt of their identity. Some of them are half-pound fish, with a row of six intense carmine spots on each side, and others are but finger-long, flanked with five dusky vertical bars. He thinks they are a new kind of trout, but they are really adolescent and baby Salmon, called Smolts and Parr. When the Smolt goes to sea, as he does his second year, he will gain a pound a month in the salt water, and after a luxurious absence will return to his birth-place in the blue and silver livery of a Grilse, and very much like an adult in appearance. As a Grilse he tarries in the upper pools till spring, and again returns to the sea a full-grown Salmon, grows fat and ponderous, and again ascends as a breeding fish of thirty to fifty pounds in weight. There

is no doubt of this wonderful growth. Marked fish have been known to treble their weight in a twelve-month.

Late spawning fish generally drop down the river with the "June rise" in a most emaciated and ravenous condition, and are often picked up by the angler, greatly to his disgust, for their stomachs have shrunk entirely away, their skin hangs in flabby folds, their scales have all sloughed off, and they seem to be nothing but back, head, and tail. Such objects are called "Kelts," and they play havoc with everything that has fins, destroying great quantities of small Salmon in their ravenous raids for food.

Very different is the first-run Salmon, just from the sea, with his plump and shapely form, broad shoulders, and glistening armature of blue and silver scales, leaping for joy at his escape from the dangers of the passage, and dallying with the pleasures and incidents of the way. To catch one of these magnificent fish, to have him on your line, for an hour at a time, to be *intimate* with him, as it were, is an experience which no one can appreciate who has not been through the ordeal: for an ordeal it is, of the most trying sort. In his "Pleasures of Angling," Mr. George Dawson describes his sensations on capturing his first Salmon, in a most realistic way. It seems he had raised his fish once, and looked him full in the face, as one glares at a ghost, as he came to the surface with great cavernous mouth wide open, and eyes which bulged far out into the air; and he had gone through all the feelings of faintness peculiar to similar occasions, with nerve twinges, electrical thrills, etc., when, having pulled himself together, he had a second rise. "I had marked the spot," he says, "where the fish had risen, had gathered up my line for another cast, had dropped the fly, like a snow-flake, just where I desired it to rest, when, like a flash, the same enormous head appeared, the same open jaws revealed themselves, a swirl and a leap and a strike followed, and my first Salmon was hooked with a thud! which told me, as plainly



as if the operation had transpired within the range of my vision, that if I lost him it would be my own fault. When thus assured, there was excitement, but no flurry. My nerves thrilled and every muscle assumed the tension of well-tempered steel, but I realized the full sublimity of the occasion, and a sort of majestic calmness took the place of the stupid inaction which followed the first apparition. My untested rod bent under the pressure in a graceful curve; my reel clicked out a livelier melody than ever emanated from harp or hautboy, as the astonished fish made his first dash; the tensioned line emitted Æolian music as it stretched and stiffened under the strain to which it was subjected; and for fifty minutes there was such giving and taking, such sulking and rushing, such leaping and tearing, such hoping and fearing, as would have 'injected life into the ribs of death,' made an anchorite dance in very ecstasy, and caused any true angler to believe that his heart was a kettle-drum, every sinew a Jew's-harp, and the whole frame-work of his excited nerves a full band of music. And during all this time my canoe-man rendered efficient service in keeping even pace with the eccentric movements of the struggling fish. 'Hold him head up, if possible,' was the counsel given me, and 'make him work for every inch of line.' Whether, therefore, he took fifty yards or a foot, I tried to make him pull for it, and then to regain whatever was taken as soon as possible. The result was an incessant clicking of the reel, either in paying out or in taking in, with an occasional flurry and leap which could have been no more prevented than the on-rushing of a locomotive. Any attempt to have suddenly checked him by making adequate resistance would have made leader, line, or rod a wreck in an instant. All that it was proper or safe to do was to give each just the amount of strain and pressure it could bear with safety—not an ounce more nor an ounce less—and I believe that I measured the pressure so exactly that the strain upon my rod did not vary half an

ounce from the first to the last of the struggle. Toward the close of the fight, when it was evident that the 'jig was up,' and I felt myself master of the situation, I took my stand upon a projecting point in the river, where the water was shallow and where the most favorable opportunity possible was afforded the gaffer to give the struggling fish the final death-thrust, and so end the battle. It was skillfully done. The first plunge of the gaff brought him to the greensward, and there lay out before me, in all his silver beauty and magnificent proportions, my first Salmon. He weighed thirty pounds, plump, measured nearly four feet in length, was killed in fifty minutes. It is said that when the good old Dr. Bethune landed *his* first Salmon, 'he caressed it as fondly as he ever caressed his first-born.' I could only stand over mine in speechless admiration and delight—panting with fatigue, trembling in very ecstasy.

"This victory was a surfeit for the morning. With other fish in full view, ready to give me a repetition of the grand sport I had already experienced, I made no other cast, and retired perfectly contented. The beautiful fish was laid down lovingly in the bottom of the canoe, and borne in triumph to the camp, where fish and fisher were given such a hearty welcome amid such hilarious enthusiasm as was befitting 'the cause and the occasion.' "

In America there is no winter Salmon fishing, as there is in some rivers in Scotland, for our Atlantic streams are all closed by ice. Once in a while, however, some tough old angler who has become inured to the vicissitudes of weather and hard knocks in general, and who "knows the ropes," will venture down to the Port Midway and other rivers of Nova Scotia in February, and capture some fine Salmon while the ice is running. The game, however, is hardly worth the candle. Most professional anglers make it a point to be on the Bay Chaleur streams by the first of June, and on the Lower St. Lawrence River about three weeks later. The

1

2

3

4

5

6

7

8

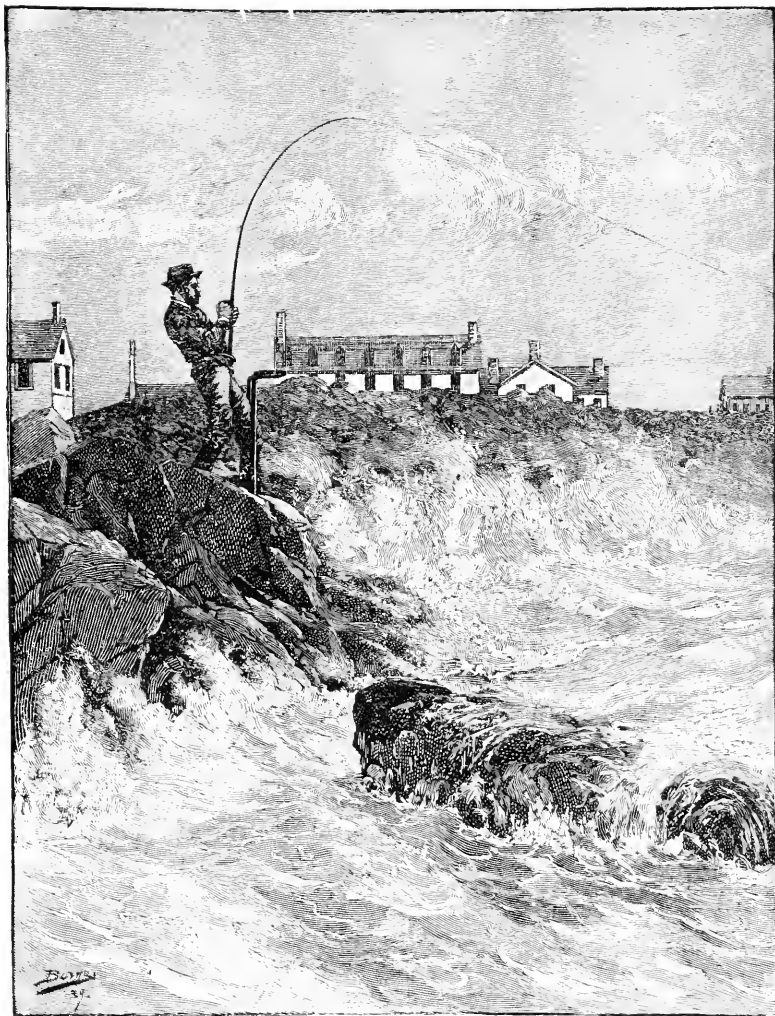

AN EXCITING MOMENT.

Land-locked Salmon waters are open in Maine and Canada about the middle of May, and there is good fishing for Wananishe in most of the numerous tributaries of Lake St. John, Province of Quebec, about the same time. A month later the fish are plenty on the riffs of the Grande Discharge, or outlet of the lake; for which I would advise the use of light Salmon tackle, such as professional Salmon anglers keep for a second outfit, as also for the Land-locked Salmon of Sebago, Toed's Pond, and other waters, which are apt to run up into the twenty-pound weights. For Salmon fishing, pure and simple—the old-fashioned Salmon fishing, where the rod has to stand a testful racket—I would choose a sixteen to eighteen foot rod. The advantages of length are obvious to any one of experience on the heavier Canadian streams, and one need not be talked out of his common sense by the current hue and cry about light rods. The man who talks "light rod" has never fished where heavy rods are needed, and is not competent to coach. He does not comprehend the first principles of the situation. A wooden rod is apt to be heavier than a split bamboo in proportion to its length; but all else being equal, the life of a wooden rod is the longest. Any rod whatever which is too heavy to wield without the aid of a waistband and thimble, should be discarded. These long, heavy rods are in request for heroic work in wicked waters, when the wind is stiff, and the fishing may be called taxing. Second rods are better adapted for switching where casting room is restricted, and for use in calm days and quiet pools. Whenever one can use this lighter rod, the climax of pleasure is reached. The reel should be heavy enough to balance the rod, made of nickel and rubber, with crank enclosed by a flange, so as not to catch the line, and the line should be as light as one can possibly make good casting with. One hundred yards of oiled silk are enough, unless your fish flops into a rapid, when you will want a thousand. A bulky line shows in the water; a line that is light for its

bulk is of small use in casting against a wind, and one that is hard and stiff is too long in running straight out into the water. A correct line is as essential as a correct rod. Let it be perfectly pliable, and yet have enough substance in it to make it feel quite solid. As to selection of flies, the most killing for mid-season are the Josh Scott, Silver Doctor, and Turkey Wing—the brightest later on. These are chief among six patterns selected by a composite jury of all the best anglers of Great Britain. Yellow Mohair and Golden Pheasant are the best for early rivers. In the evening, when the light goes off the water, large flies and brighter colors can be used with effect. A silver body does well, and jungle-cock feather shows up finely. As to size of flies, one universal proverb will always stand: Large flies for heavy and deep water; larger flies for waters which run rapid and rough than for those which run shallow and quiet; large flies for evening fishing, and large flies for early spring fishing. In these later years I have learned to use double snoods. Upon the whole, I find Salmon less capricious than Trout. The truth is, on a booming river, or when the Salmon are in a taking mood, they are not particular as to the kind of fly they take. There is a good deal of fresco work in the talk about killing-flies and favorites. Pedantry will often count for more than common sense, but it does not carry as far.

Fish rise best the moment when the river begins to come out. In some cases they will rise until the water becomes so dirty that they cannot see, but in general the spurt will not last over an hour. This, however, is not the time to fish. No use to waste time when the fish are turning flip-flaps all over the stream. Once, on a moonlight night, they made such a constant commotion in the river that I could not sleep; what a night that was! Not a cloud or a whiff of wind. The river was alive with them. The best time to fish is the moment when the fish become quiet and begin to choose their resting-places, and the river runs clear enough for them to see the fly.

In a colored river, the shallowest parts should be fished, because the fish can see better there than in deep water. An old angler, in one of the English sporting papers, observes that "many young anglers raise a great many fish and fail to hook them. Even some long-experienced anglers get into this habit, and never get out of it. The reason of this is, they cast too straight across the stream, and keep the point of their rod too high. The fly travels round too fast, and the fish make a dash at it and fail to catch it. The fly should go straight out, the cast should be made well down the river, the point of the rod kept nearly touching the water, and the fly allowed to sink well down. The rod should be worked slowly when the fly has nearly come over the cast."

This is the correct talk when feeling for a fish: keep the point of the rod *down*, but when a fish is on, keep it *up*. I am glad to quote here what Mr. E. M. Tod, an angler of world-wide reputation, has to say in the London *Fishing Gazette*, by way of instruction as to how to handle a Salmon when hooked. He says:

"First of all, hold your rod pointing upward, so as to bring the spring of it to bear with all its power on the fish; then 'hang on' to the fish, and do not let him have any more line than you can possibly help, as the less line there is between you and the fish, the better for you, and the worse for your quarry, as if there is much line out it may get foul of some obstacle, and the force of the current will put a heavy strain on. If the fish is determined to run, he will take line, and, should he take to somersaulting at each jump, the line must be quite loose, and the rod's point dipped; but in any other case it is best not to give a foot of line, provided the rod be kept upward, as no rod (or at any rate no ordinary rod) can put on more strain than three or four pounds; so there is little or no danger of a break. In this manner many a little fish of not more than six or seven pounds weight

may be speedily killed without allowing a great deal of water to be disturbed, and by keeping such a tight line fish may be landed into which the hook has not gone over the barb, whereas if they had not been held in tight, the hook would have dropped out. I need scarcely say that a fish, if small, must be kept; if large, coaxed away from any obstacle. Should he go to the bottom like a log, as large ones sometimes do, get *below* him if possible, and pull hard at him. If this does not start him, pelt him with stones. This will generally succeed, but sometimes more severe measures have to be taken, as on the Usk, last season. A Salmon weighing forty-two pounds, on being hooked, sank to the bottom, and was only moved by a gallant colonel, who was present, stripping and swimming in after it."

Speaking of this habit of sulking, here is what Parker Gilmore ("Ubique") has to say about it. I had rather quote these two old worthies than to quote myself. He says:

"Obtain the smallest hollow bangle procurable, having a hinge at the back, and closing with a snap on the opposite side. Have its inner surface perforated with numerous holes, the outer surface with a few only, each to be about the size of a No. 1 shot. Partly fill the interior of the bangle with snuff or cayenne pepper.

"Suppose, now, that the angler is fast in a fish which has sulked. Place the bangle above the reel, around the rod and line, pass it up till it goes over the tip of the top joint, when, by raising the rod, and placing the strain on the line, the bangle will at once descend to the hook. The action of the water upon the snuff or pepper will be more than the delicate mouth and nose of the Salmon can stand, so off he will go for other haunts. Stop the Salmon dare not now, for, whenever he stops, the pungent stuff makes itself felt. In fact, the only possible relief to be obtained is by going, and go he will, with the velocity of a greyhound with a kettle attached to his tail."



Verily, this is a wholesome way to hustle a Salmon that sulks! It holds over any scheme that I ever struck on this side of the Atlantic. But Parker Gilmore has been over a great deal—perhaps he happened on it here. This is all very well to start the fish, but the trouble would be to stop him. This hint about holding the rod up reminds me that a different practice is required for river Salmon than for land-locked fish. I am convinced that anglers who have tried for the latter without success have habitually cast too long a line. Following the approved mode in rapid-stream fishing and broken water, they have laid their lines straight out, and kept the point of the rod nearly touching the water. This is wrong. On dead water a short line is requisite; the rod should be kept almost perpendicular, so that the fly can trail on the very top surface; and the cast should be made straight out in front. Not more than six feet of the gut-length should touch the water at any time. Why? Because the water is so still, even when rippled by a flaw of wind, that the line laying its length along the water looks like a cable. The fish are so busy investigating the phenomenon of the line that they don't mind the fly. Perhaps they don't see it at all. To attract his attention the point of the rod should be pumped up and down. This will move the fly a foot or more at each motion. Sometimes it is well to draw the line through the rings with the left hand while working the point of the rod, which answers the like purpose. The whole process is exceedingly delicate. Experienced anglers will appreciate the difficulty of fastening to a rise with an almost perpendicular rod, while the liability of breaking the tip, in case of a strike, is very great. The only way is *not to strike* when a Salmon rises, but to let him pull the point of the rod down three or four feet, and then fix the hook in his jaw by a gentle lifting of the rod so as to bring the line taut. There is no method of fishing prettier than this, when one gets used to it. It beats skittering with a spoon all hollow.

It is obvious that this mode applies to tidal waters and still pools in rivers as well. It is much in vogue in Scottish lochs (lakes), and is just as suitable in our own. Small flies are the best, of course, and should never exceed one inch in length. I have patterns of Land-locked Salmon flies—with yellow bodies, turkey wings, and claret body with mallard wings—which I have always used with success wherever tried.

Trolling for Land-locked Salmon with live smelts, or phantoms, is a successful method in Weld and Sebago, and as a *dernier resort*, a buoy may be baited with chopped fish. Set the buoy in thirty to forty feet of water, and fish with the same bait as you chummed with, or with live minnows, and use just sinker enough to carry the line to the bottom. When a fish is felt, let him have a pull at the hook, and then raise the rod-tip gently and firmly. This will generally fasten him, and the subsequent proceedings will be interesting.

The number of expert Salmon anglers in this or any other country is small, possibly because their experience is often confined to a single river, or to rivers of the same temper.

Rivers are as different as horses. Some are wild, impetuous, and untamable; others restive as an Arabian courser. Some plod like a plow-horse, and others buck like a broncho or kick like a mule. Some dash to the sea in a straight-away course, with scarcely a break, and others wind with a sinuous and solemn monotony, like blind cobs in a tread-mill. Some are like circus horses, cavorting in many an eddy, and flying leap, and others tumble and plunge like colts at the hurdles. Some have breadth, and depth, and sweep, while others are pent-up, curbed, and narrow, churned into constant lather and foam. In some rivers the pools are frequent and spacious, open to the sunlight, and glinting with bright, pebbly bottoms; in others they are short, angry, and broken, filled with debris and boulders. Some are overhung by protruding branches and thickets, while others flow under the gloomy shadows of jutting cliffs. There

is no end to the composition and phases of rivers, and, consequently, no end to the artifices and methods of the angler. It is this complexity which makes the study and practice of Salmon angling a superlative art, and of all piscatorial accomplishments the most difficult to learn and master. As in human nature, it is difficult to diagnose or interpret one face, type, or character by another, so it is equally difficult to predicate the disposition of one river by the idiosyncrasies of another.

The methods of a hooked Salmon in a quiet pool of a placid river are so simple and so uniform, that the angler goes through the process of subduing his fish and bringing him to gaff, in about the same perfunctory way that Gleason or Rarey would quiet a horse that was skittish, but not vicious. The ambitious novice can learn them as easily as he can the fundamental rules in arithmetic. In what the Scotchmen call a "wicked" river, the task is more delicate and exacting, requiring much strategic ability, as well as physical endurance. There is a great deal of personal risk, too, where often a false step or a stumble when wading might cost the angler his life, by pitching him into a rapid as tumultuous as that of Niagara. On such a river one can never count on killing his fish until he has him on the bank, stiff.

Such rivers try the angler's mettle as well as his science. Tactics of the drill-master fail here. Instinct becomes a better prompter than a "rule of three." Expedients are suggested by emergencies, both to the Salmon and his captor, in marvelously rapid succession. The hooked fish, after his momentary fright on getting fast, collects his senses, and like the chased deer and fox, devises stratagems on the jump. You have no time to dally. Playing your fish becomes a desperate struggle, like a Spartan bout.

You must kill your fish on short line with rod bent double, or have him break away. You must drop your rod-tip when

he vaults clear of the water, and "slue" him off from dangerous places when he gathers headway. You summon the forces of the current to your aid in accelerating a favorable momentum, and you counteract them when the influence is adverse. If the Salmon once gets out of the pool into the raceway of the impetuous lower stream, there is nothing to do but follow him down the bank and over the slippery rocks, into the water and out of the water, shoe-deep or waist-deep, lifting your line over obstructing bowlders in the channel, watching out for projecting ledges or branches of trees, keeping your weather-eye always on the fish and looking ahead for the best footing, holding your rod up and never allowing slack, even though you stumble full length over the rocks; not minding thumps or bruises, but keeping your wind and saving your fish, no matter if you break your neck. And you keep this up an hour, perhaps, giving as little line as possible, until finally you are so limp and blown that you couldn't puff out a candle with your breath, and in bodily condition much like the Salmon, your opponent, which by this time has haply turned up his silvery side at the foot of the rapid, convenient for the clip of your exultant and admiring gaffer.

Your attendant is an almost indispensable factor. He must be mentor as well as assistant. In fact, he ought to be as intelligent and experienced as his master. He is not there merely to basket the fish and tote them. He should have sense when to advise his companion, and when to refrain; and above all things he should be cool and self-possessed. He is able to perceive from lateral points of observation what the man with the rod cannot see, and thus often to anticipate the intentions of the fish, and head them off. He is to clear away bushes which interpose, and rocks which impede the passage along the bank; he is to take the rod betimes into his own hands while the angler gains a better foothold or more advantageous position, to steady him by the shoulders in difficult places, to help him by the hand and *steer* him, as a

policeman guides a lady or a cripple through the intricacies of a thronging thoroughfare; and worse than an idiot would be the bumptious dolt who would spurn this timely counsel.

Furthermore: The gaffer should select the landing-place in advance, if the fish is to be gaffed from the shore, as is usually done, even when fishing from a boat, and wade well out, say to the depth of his knees, so that by any chance the fish may not flounder loose by striking the bottom in too shallow water. Then the man with the rod should lead his captive, as best he may, up to the gaffer, so that he can strike it. Never be in a hurry; a slip of the foot on the river bottom may cost another hour's hard work with the rod. Put the gaff into the water as quietly as possible, and unobserved of the fish, to the depth of fourteen inches or so, and make the clip upward and inward, endeavoring to fix the point abaft the shoulders, which is the center of gravity. If hooked elsewhere, the fish gets a big leverage with head or tail, and will make a ghastly rent in his body, if indeed he does not flop off the hook altogether. Never strike a fish in the belly. There is nothing more unsightly than a great gaping wound, especially if the entrails protrude. A gaff should not have its point reversed, or turned inward, as we find them at most of the tackle-shops. The point should be parallel with the shank, so that the line of draft at the point may be parallel with the line of draft on the shank and gaff handle. The hook need not exceed two and a half inches in the width of the bend between shank and point. A four-foot handle is the correct length. Jointed handles are convenient to carry, but are objectionable on account of a possibility of their telescoping or slipping at critical moments.

Unquestionably, in no part of the globe are there so many Salmon rivers as there are in the Dominion of Canada. There are far more than a hundred—in all perhaps a hundred and twenty—which might yield fair sport to the rod, counting only those of the Atlantic coast, and not including those of the

Arctic and Pacific. Dozens of them have never been fished with a fly. Some, perhaps, are virgin even to netters. Only the rude spear or clumsy hooks of Esquimaux have tested the quality of the most isolated.

First of all are the inimitable short rivers of Nova Scotia, numbering fifteen or twenty, which pour out from the limpid reservoirs on the height of land forming the watershed of the peninsula along nearly its entire longitudinal axis of one hundred and twenty miles. These are set like glistening gems in a sylvan crown, and the water which flows therefrom is as clear as crystal, and the Salmon which run up betimes from the sea have only a holiday journey to make to the sources, always blithesome and comely of form, and performing the taxing duties of life with the ease and comfort of the favored and high-born among men. They live in luxury, with no end of choice food in variety, the young of lobsters, and innumerable crustaceans, mollusks, and annelids, which hide on the beach and among the rocks, the herring-sile and small fry which come in from the sea, when its waters are tepid; the larvæ and fingerlings of the upper streams and lakes, and the endless variety which nature supplies from her largess of woods and waters, both salt and fresh. Here, likewise, the angler may enjoy the luxuries of civilization, without hardship of the camp, or the pest of brulards aúid black flies, or the taxing tedium of the wilderness canoe-voyage, or the protracted journey by sea *en route*. For comfort, pure and simple, with a modicum of fun, commend me to the rivers and hospitality of Nova Scotia. With McKinlay's excellent map, published at Halifax, one may soon learn the country like a book, and he need never get permanently lost in the woods, for this goodly strip of Bluenose Land is scarcely forty miles wide from the ocean to the Bay of Fundy, and if the uninitiated stranger would cross from shore to shore without a guide, he has only to follow some water-course up to its source on the ridge, and then down the other side to the sea,

The experience is far more pleasing than wandering through the monotonous pine forests of New Brunswick, where every turn in the far-reaching Miramiche or Nepissiguit looks like the last, and the inevitable porcupine is found rooting at the foot of every jack-pine where you camp.

Nevertheless, New Brunswick is a delectable land, traversed as it is by interminable water-courses, which interlace at their sources, and offer no end of canoe-routes, whereby one may travel for summer after summer without covering the same ground twice. And here again we have not only McMillan's old reliable map of the Province, but a brand-new map, recently published in Boston, prepared from the notes of an enthusiastic canoe-man, who gives all the routes, portages, and good fishing-places that are contained within a wide district. Here in this forest land is the noble Restigouche, famed among Salmon rivers all over the world, with its one hundred and forty miles of length, and sixty miles of good Salmon fishing. And here, too, are its four great branches, the Metapedia, Patapedia, Upsalquitch, and Tom Kedgewick, almost equally prolific and desirable, all of them leased and fished by the magnates of the Dominion and the nobility of England. In these rivers the Salmon run up to seventy pounds in weight, and the annual commercial catch is something fabulous. It is said that a million and a half of pounds of Canadian Salmon pass into the New York market every year, and of this amount the Restigouche system furnishes four-fifths! There are other rivers on the Boie des Chaleurs beside the Restigouche which furnish giant Salmon, and among them the grand Cascapedia is notable. I once saw five Salmon taken out of this river with fly by ex-President Arthur and Mr. R. G. Dun, which weighed fifty-five pounds each—all in one outing. Indeed, it may be said that all these rivers of the Bay, being long-visited and of great reputation, and quite accessible withal, are the grand fluvial prizes to be contended for at Quebec when the leases are up for

auction. Here, indeed, is the center and goal of every known angler's ambition; for not only do the nobility of England wet their lines in these choice waters, but here is the most aristocratic fishing-club in the world, whose shares are worth \$4,500 to own, and whose annual dues and expenses for the season bring up the cost of the fishing privilege to a figure which only the wealthy can reach; and to "knock the persimmon," the pole must be not only superlatively long, but socially gilded and mounted.

I could tell many stories of the Restigouche, reaching well back to ancient annals, some of which are absolutely ghostly. For instance, some twenty years ago there plied upon the river a wondrous craft, whose cognomen was "Great Cæsar's Ghost," fitted up with amplitude of cabin, kitchen, and promenade deck, and drawn by horses, which plashed and floundered up the long reaches of the river, alternately taking to the bed and the banks, as the straits and exigencies of the route required. Her owner, Mr. C. J. Bridges, whilom manager of the Grand Trunk Railway, took many a distinguished party with him on his annual excursions, but finally he betook himself to Manitoba for speculative purposes, and I am not aware that even a wreck of the ghost remains. However, in its life it was the most material ghost it has ever been my fortune to encounter.

I remember, too, another incident. It germinated in our atmosphere of royalty. Once we were apt to associate fish with billingsgate and bad smells. In the Old World we know that the chase alone enlisted the royal favor. From time immemorial hunting was regarded as a regal sport, and in some dominions it was the exclusive prerogative of kings. Doubtless, in ancient time, the royal retinue, with its gorgeous trappings and blare of trumpets, swept haughtily past the solitary angler by the quiet river-side, scarcely deigning him a thought, or even a sneer. Certainly enough, all the precepts of Bishop Sanderson, and the philosophy of Walton and



Wotton, could not command a decent respect from old Sam Johnson, or persuade Venator that angling and hunting had any right to be mentioned in the same breath. It is different now. There may be no precedents of recognition in the musty past, but the fruitful present utters no doubtful sound at least, so far as Salmon fishing is concerned. Salmon fishing has been ennobled as a sport by Her Royal Highness, the daughter of the Queen of England and Empress of India, and conjointly by her noble spouse, the Marquis of Lorne, late Governor-General of Canada. With her own royal hands the Princess Louise has captured a twenty-five pound Salmon on the river Restigouche, and sent it home to her Queen-mother, with the Jock Scott fly which caught it fixed in its jaws, as a trophy of her prowess, and affidavit that the feat was all her own!

No lukewarm sportsman is His Excellency, the Marquis. It was my good fortune once to be privately presented to him on the eve of an excursion down-river. It was at Quebec, on the occasion of his inaugurating the Dufferin Terrace, in 1879. I found the royal party on board the steamer *Druid*, inspecting cabin quarters which they were to occupy *en route* to the Restigouche, where they were going to fish. The *Druid* was a government vessel, commanded by Captain Marmion, with whom it had been my pleasure to make several voyages around the Gulf of St. Lawrence as many as fifteen years before. While I was pleasantly engaged in a friendly chat with the veteran mariner, my friend, J. U. Gregory, Esq., the Naval Agent at Quebec, came up the companion-way in company with Major De Winton, His Excellency's aide-de-camp, and having presented me, announced that the Marquis would be pleased to see me presently. I held one of Abbey & Grubrie's oreide Salmon reels in my hand, and literally "stood by the wheel," like a true helmsman, determined to shirk no duty. Accordingly, when I came to a front face and present, His Excellency took me graciously by the hand, and we occu-

ped common ground at once. We talked of fish and fishing-tackle, the natural history of the country, and kindred topics, and when we finally parted, I was quite at my ease, and felt more than ever the truth of the old adage, that "one touch of nature makes the whole world kin." Had we never fished, we had never met!

Earl Dufferin, his predecessor, was a most proficient angler, and so was the countess. Both were at one time guests of the Hon. Allan Gilmour, of Ottawa, who owns a princely preserve of 5,000 acres on the Godbout. They fished that river in 1876, staid two days, and are credited with a score of seven fish, aggregating seventy-one pounds in weight. Dufferin on one occasion had fought a fish manfully in one of the most difficult pools on the river, where the old Scotchman delights to test the mettle of his visitors. In an attempt to bring the fish to gaff, after a long struggle, he slipped on the rocks and plunged into the drink. He got a thorough wetting, but saved his fish and won a reputation. The laugh, however, does not come in here. The climax is reached when his lordship appears an hour afterward in a dry suit of Mr. Gilmour's habiliments, loaned *in extremis*, which were as much of a fit as one could expect where one man was only of fair average size, while the other stood six feet two in his socks, and weighed at least sixteen stone.

The Godbout River is several hundred miles below Quebec, and until recently was considered to be almost at the antipodes. At present date, however, nearly all of the rivers on the north shore of the St. Lawrence River, which do not belong to ancient seigniories, are up for lease, and it is every year becoming more and more interesting to see how the spirit of exploration and emulation is carrying our own people of the United States farther and farther into the remote portions of the Canadian Dominion. Within two years they have taken possession of a large part of the Lake St. John country, and the wilderness lying between it and Quebec,

registering a club membership of over one hundred, and numerous camps; and now the eye of the keen angler is directed to the rivers on the eastern coast of Labrador, which lie far beyond the line of popular ambition hitherto. It will not be long before the Salmon rivers of Byron's Bay and Sandwich Bay will be visited, while the Tomliscom, the Hamilton, and the Nor'west Rivers of the Great Esquimaux Bay, in latitude 55 degrees, which I described in "Harper's Magazine" thirty years ago, will become places of annual resort for anglers. These last named are fine Salmon rivers, and the presence of two very considerable Hudson Bay ports in the vicinity, within thirty miles of each other, relieves a sojourn on the Bay of an asperity of aspect which might otherwise seem hyperborean to a man who has never traveled in higher latitudes.

The Esquimaux who live on the Bay number perhaps fifty souls now, though once they were a community of seven hundred; and each season they salt and smoke a large quantity of Salmon for their own use and the consumption of the Hudson Bay employes at Rigolet and Nor'west River stations. These two stations are headquarters for the Southern District of Labrador. Fort Chimo, on Ungava Bay, is the headquarters of the Northern District, and there is a regular trail from one to the other over the great dividing ridge which separates the two. This ridge, or mountain range, extends southwesterly across the Labrador to the Saguenay River, touching it at or near Lake St. John. It is a most elevated plateau, diversified by peaks and knobs, among which Mount Nat Mokome (the Clerk) and an extensive range known as the Mealy Mountains, are conspicuous, nearly all bare of verdure, and snow-capped perpetually. I could write an entire chapter about the physical geography of this region, so little known, but this fishing paper is not a suitable place for it. However, it is pertinent to state that on this vast water-shed, which traverses a region containing 450,000 square

miles, are collected innumerable bodies of water, some of them immense, like Lake Mistassini, larger than Ontario, and others mere lakelets, out of which they discharge the melted accumulations of winter in turbulent streams, which usually plunge over lofty escarpments into the ocean and Gulf of St. Lawrence, in falls from one hundred and fifty to four hundred feet high. This feature is peculiar as well to the north shore of the St. Lawrence River, from its mouth nearly up to Quebec. The celebrated Montmorenci Falls afford a striking illustration thereof. Some of these falls impinge directly on the river, while others are set back from one to four miles. In many cases, however, the waters of the interior find their exit through great gorges and rifts in the rocks, and in all such cases become Salmon rivers, unless there are obstacles to obstruct their ascent. There are perhaps sixty of these rivers catalogued for lease at the Crown Lands Department in Quebec. The most notable of these are the LeVal, 180 miles below Quebec; Trinity, 276 miles; St. Margaret, 340; the Moisie, 364; the St. John du Nord, 454, constituting the boundary line between the Province of Quebec and Labrador; the Mingon, 465 miles; the Natashquan, 571 miles, and the Esquimaux, 720 miles from Quebec. Seven hundred and twenty miles are a good many to make for a few Salmon. The St. John du Nord used to be a favorite river of the Harriotts and the Havemeyers, of New York, and actor W. J. Florence used to fish the Natashquan. One summer, I think it was in 1879, he went down with E. A. Sothern (Lord Dundreary), the Duke of Beaufort, and Sir John Reid, and the party captured ninety-eight Salmon, weighing 1,328 pounds, in the course of about three weeks, though the actual fishing time was but fifty-eight and one-eighth hours. That bunch of Salmon must have cost the party about \$3.50 per pound. The steamer which they chartered to take them down from Quebec to the fishing-ground cost \$1,000, and the other expenses must have brought the bill up to \$6,000, for

to be comfortable under such circumstances requires the building of a commodious *cabonc* at the river; to have cooks, gaffers, and supernumeraries; to provide liberally with provisions and camp-furniture, as well as personal outfit. Even the item of fly-oil, some wag has suggested, must have been important of itself.

Reference to the many rivers of the Dominion to which anglers resort would not be complete without including the Margarie of Cape Breton, the Jupiter and Dauphine of Anticosti Island, and the Humber, Castor, Gauder, and Exploits, and a good dozen others, of Newfoundland. The Margarie and Newfoundland are easily reached by regular steamers from Halifax, while Anticosti is accessible by chaloupes which run frequently from Quebec to the island in the fishing season.

At the present time all available Salmon rivers lie below Quebec. But twenty years ago, and previously, the Jacques Cartier, above Quebec, was noted for its fish, and a hundred years ago many streams which empty into Lake Ontario contained Salmon. Perhaps some day all of them may be restored. In such event ambitious wielders of the ambidextrous rod will not be obliged to go to the Natashquan, nor pay from \$1,000 to \$6,000 for a brief period of sport. Nevertheless, there is nothing in life better worth the paying for; and any man who has tussled with a big Salmon and brought him to gaff may well feel himself a hero, and join with a venerable Godbout River poet, who is now far in the decline of life, after boating and grassing hundreds of goodly Salmon, in the epigram:

“At last the dubious fight is o'er!  
 The battle has been fairly won,  
 And the coveted prize lies safe on shore.  
 A beauty! a twenty-pounder good!  
 Hurrah! a prettier Salmon sure  
 Was ne'er seen beneath the sun.”

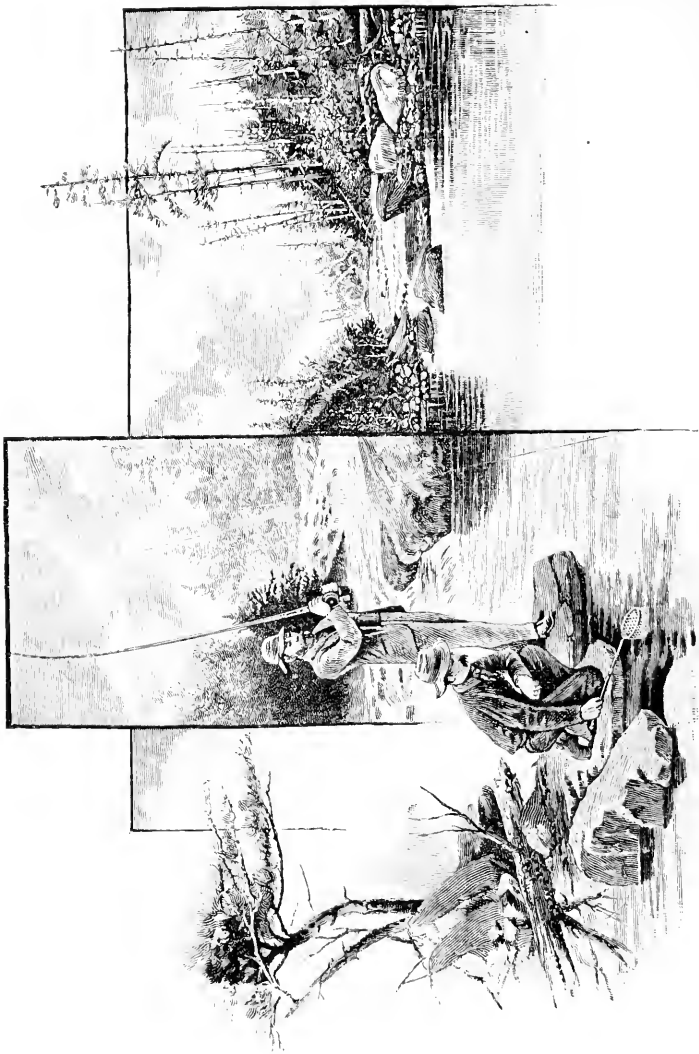

## THE PACIFIC SALMON.

---

BY W. A. PERRY ("SILALICUM").

---

ON the Pacific Coast there are found five species of Salmon, all of which, with the exception of one that is locally confined, entering one short, rapid river, range up the northwestern coast as far as the Arctic Circle, and even beyond to Bering Straits. These fishes occupy a very important position in regard to the welfare of the aboriginal population of the coast, and even of the interior, in furnishing them with their principal means of subsistence. The Salmon is, and was, of greater importance to the Siwash (this term includes all Indians speaking Chinook, and, in fact, all Indians between the Rocky Mountains and the Pacific, the northern line of California, and British Columbia) than the elk, mountain goat, moose, and deer combined. North of British Columbia it is the main staple. True, there is an abundance of the finest Halibut, Codfish, and Sturgeon, that the ocean can produce, to be found along the entire northern coast; but even these fishes, that supply the laboring people of the coasts of Europe with what to them are luxuries, are by the Indian and the Esquimau regarded with contempt, as being fit only to be eaten in times of threatened starvation, or when Salmon cannot be procured.

The species of Pacific Salmon are: the Quinнат, or Tyeे Salmon; the Kisutch, or Blue-back Salmon; the Nerka, or Saw-qui Salmon; the Keta, or Cultus Salmon; the Quil-layute, or Oolahan Salmon.

The Quinнат, or Tyeе Salmon, is the largest that occurs

on the Pacific, and often reaches a weight of one hundred pounds. It was formerly very abundant in the Sacramento and Columbia Rivers, but the vast numbers caught and canned yearly have reduced the great schools of these fishes to but a tithe of their former numbers. They are abundant yet in the Frazer River, and in the rivers farther north, and are also caught in Puget Sound, but in limited numbers. They are a beautiful fish, and a gamy one. They take the trolling-spoon in salt water, or a hook, baited with Salmon-roe, in fresh water.

The Kisutch, or Blue-back Salmon, is the dude among Salmon, and is, next to the Tyee, the most valuable. It has not the rich, firm flesh of the Tyee, but is a delicious fish, and the flesh is of a true Salmon color. It is also a gamy fish, and is even a greater favorite with anglers than the Tyee, as it takes the spoon freely and fights desperately. This fish is known also as Coho. It reaches a weight of over twenty pounds, and it is in great demand with the commercial fishermen and canners.

The Nerka is but a rare visitant on Puget Sound, while on the Frazer River it is the principal spring Salmon, sometimes coming with the last run of the Tyee.

Perhaps one-half of the Salmon exported to England from the canneries of the Frazer were Saw-qui when they sported in that muddy stream. This fish never exceeds twelve or fourteen pounds in weight, and is condemned by anglers. When hooked he makes but little resistance, and comes tamely in.

The Keta, or Cultus (meaning bad or worthless) Salmon, otherwise known as the Dog Salmon, extends over the entire northern Pacific coast. It is found in every river, every lake, brook and streamlet, slough and ditch, that connect with the rivers that afford water enough for it to swim in, and is even said to be sometimes found floundering overland looking for water. Its flesh is white and worthless, except to the Indians.



QUINNAT, OR CALIFORNIA SALMON—*Oncorhynchus Chonicha*.

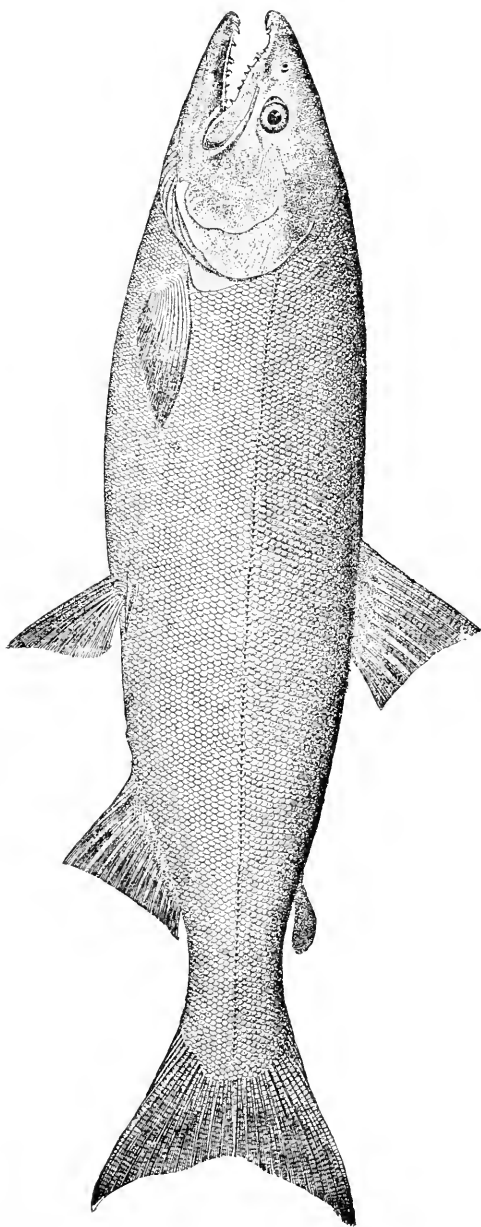

(Even crow is regarded as a delicacy with them.) The only thing to be admired about this fish is its determination. It has largely developed "get-there" qualities, and if it meets an obstacle in the stream that it can't leap over, it will try to climb over. Failing in this, it will ram against it with its nose until it kills itself.

When you open a can of Columbia River Salmon, if you find the meat white, insipid, and tasteless, you may safely conclude that some old martyr of this species furnished the contents. It grows to a weight of twelve pounds, takes the spoon, and makes a determined fight.

The Quillayute is the smallest of the Salmon. It is found only in the Quillayute River, Clallam County, Washington. It is a short, thick fish, weighing about six pounds. It has never been classified by naturalists. The flesh is well flavored and firm. It also takes the spoon, and affords good sport. On account of the richness of its flesh, the Indians have named it the Oolahan, or Eulachon, after the Candlefish, and no greater compliment could they have paid it, for in their estimation the Candlefish is the most delicious morsel that swims.

These species of Salmon are of great importance to the white people of the northwest coast. Next to lumbering, the handling of these fishes gives employment to the greatest number of people. A great many Chinese, Indians, and "dagos" are also employed in this industry. An "off-year" in the Salmon run means serious commercial depression in this region, for the failure of the Salmon to come means the locking up of millions of dollars that would otherwise be distributed among the people.

I shall not here go into minute descriptions of the various canneries, or of their methods of handling the fish. The only allusion I will make is to the method of taking them.

In the early morning, boat after boat leaves the cannery wharf. These boats are skiffs twenty feet long, and each is

manned by two men—the boatman and the net-handler. In the stern of the skiff a net of three-inch mesh, two hundred and fifty yards long, and six feet deep, is carefully coiled. To the brail-rope of this net empty five-gallon coal-oil cans are attached, one hundred feet apart. Arriving at the place selected for the day's work, the net-handler stands erect in the boat, and quickly pays out the net over the stern, the boatman meantime pulling for all he is worth. When the net is once launched in the river, it is allowed to drift with the current for half an hour, and then the skiff, which has drifted alongside, is rowed to the end of the net that was first placed in the river, and the process of drawing the net and killing the fish begins. If during the run of the Saw-qui, a fish will be found every few feet, caught in a mesh and held fast by the gills. The fish, in endeavoring to go up-stream, force their way in spite of every seeming obstruction, and when they meet the net try to force themselves through it. They succeed in forcing their heads through, but cannot put their bodies through the meshes of the net. In attempting to withdraw their heads, the twine becomes entangled in their gills, and the fate of poor Saw-qui is sealed. He is lifted into the boat and dispatched with a stout bludgeon. The net-tender then disentangles the fish from the net, and throws it into a crate, or on the bottom of the boat. Should there be more Salmon in the net than the skiff can carry, the nearest boat is signaled and comes to the aid of this crew, and the fish are taken at once to the cannery.

In 1879, while employed as an engineer on a tug belonging to a cannery, myself and a friend took a boat and a net one evening, and made a "drift." The result was four hundred and forty-three Saw-qui, that would average eight pounds. As the boatmen had concluded their labors for the day and had gone home, we were in a plight. Our skiff would not hold one-half the Salmon, and was soon loaded to the gunwale. We drifted down the river, and fortunately met

a small steam-launch that took us in tow, and brought us safely to the cannery wharf, where our Salmon were secured and counted. We received one cent each for them, and considered ourselves well paid; but the next day the net-tender put in a bill for twelve dollars damages, claiming that we had torn and almost ruined his net. We paid the bill, and ever since we have considered that we "lost money on de goods."

Various methods of taking the Pacific Salmon are by the fish-wheel, "of all diabolical inventions the most infernal," the net, the trap, the spoon, and the bait-hook. But I will only describe here the methods of catching Salmon by hand.

When the sultry June sun shines on the Cascade Mountains, the melting snow causes the river to rise rapidly. The Indians watch closely for this event, and the various tribes gather in the deep, narrow canyon where the river runs. The drying-sheds of these people have stood in the same places since the unknown ages, and every year the same families return to the same sheds. These sheds, or scaffolds, are crudely, yet strongly, built. No nails or pins are used. Posts are set firmly in the ground, to the tops of which beams are firmly lashed with ropes of bark, and strong poles laid from one rafter to another. Sometimes there will be a complete net-work of beams and rafters, the whole capable of sustaining many tons of Salmon. This skeleton building is then covered and sided up with bark, and noble Mr. Lo is ready for business.

When the morning sun warms the air he arises, gives himself a shake, and his toilet is made. Taking his dip-net from the side of the bark rancherie, where he has slept, he ambles down to the river, takes his position on a jutting rock, and begins to drag his net down the stream. The hoop of this net is usually thirty inches in diameter, and the net about four feet deep. It is attached to a handle about twelve feet long. The current of the Frazer is very swift, and in order

to fish successfully Mr. Lo has to exert himself in a manner not at all to his liking.

It is a picturesque sight to watch one of these Indians fishing—his brown, nude figure pictured against the dark basaltic rock throwing and withdrawing his net, and if successful, the blue and orange of the great Salmon struggling in the net which glitters in the sun like an interlacing of diamond cords. The fish is cast violently on the rock, and a war-whoop thrills the air. Almost instantly, a squaw, as nude as the fisherman on the rocks, appears and gets the Salmon. In a short time a fire is blazing in the rancherie. The Salmon is split in two, and on a hoop is roasting before the fire. By the time the Salmon is cooked, the fisherman may have a hundred lying on the rock. He then shoulders his net, and returns to the rancherie, having all the fish that can be cured that day. After disposing of the cooked Salmon, he curls himself up under the shade of some rock, and sleeps away the greater part of the day. When he dies, a great wooden Salmon is erected on a pole over the place where he sleeps in the Memaloose house. May he never be resurrected!

The squaw, when she finishes eating the fragments of Salmon that her lord has left, proceeds to the rock and carries the fish to the rancherie. She then cleans and splits them and hangs them on the rafters. The eggs are thrown into a hole in the corner of the rancherie. When they ripen to a peculiar degree of nastiness, they are bailed out and molded in a press into blocks, dried, and kept to be the food of Tyees, on occasions of great state. The Salmon are smoked on the rafters, then taken down, baled, and then hoisted up into Salmon-houses, that are built high up in the branches of trees. In former days, if any of these Indians offended an officer of the Bay Company, he would find out the location of their Salmon houses, and would send a missionary, armed with a pair of telegraph-climbers and some arsenic, who would investigate the contents of the bales. It is enough to

say that some rancheries were "to let" before the next spring; and there would be a demand for wooden Salmon in the Memaloose house.

A still easier method of taking the Salmon, practiced by these Indians, is by trapping them as they ascend the smaller rivers and creeks. A row of stakes, split from the red cedar, is driven across the stream. In the center of the stream the stakes take the form of a loop. Resting on the bottom of this loop, and inclining upward at an angle of twenty-five degrees, is a cradle about four feet wide and twenty-five feet long. The Salmon encounter the stakes in the stream, and follow the line until they enter the loop, and from there force themselves up the slanting incline until they drop into the cradle. This cradle, though lightly made, is strong, being wickered up with vine-maple. During the day-time some one is continually on the watch, and as soon as a Salmon is floundering on the inclined platform, it is at once removed by the watcher with a peculiar gaff-hook, which I will describe later.

Near the trap, on the bank, stands a bark-covered smoke-house, such as I have described as in use on the Frazer, with the same horrid smelling receptacle for eggs. In the morning the trap presents an interesting appearance. The cradle is full of struggling, writhing, flapping Salmon. The Kisutch, the Saw-qui, the Keta, and too often hundreds of beautiful Mountain Trout, are heaped together in the cradle. As soon as the Indians awake they rush out, and with shouts of glee toss the contents of the trap on the bank, perhaps to rot untouched, and the trap, always set, is ready for another multitude of victims.

The gaff-hook used by these Indians is a peculiarly ingenious affair. Procuring a shark-hook, they fasten a socket of wood to the shank; a hole is bored into the socket to receive a strong string. The handle of this gaff is a light pole that fits neatly, yet loosely, into the socket of the hook. About

four inches from the end a hole is bored to receive a string. The other end of the string is securely fastened to the socket on the hook. The string is about a foot long.

When an Indian goes fishing with one of these hooks, he rolls up his trousers, if he be the proud possessor of a pair, and, wading into the stream, watches closely until he sees a Salmon, when, placing the hook over the fish, he draws it sharply toward him. If he strike the Salmon, the handle draws out from the socket, and this prevents the handle from being broken by the struggles of the fish. He then wades ashore, kills the Salmon, extracts his hook, fits it on the handle, and is ready for another assault on the innocents.

The Salmon enter the Frazer River in the following order: The Tyee in June, the Saw-qui soon after, the Kisutch in August, the Keta in September or October.

It is not necessary to discuss at greater length the schools of these fishes that fill the streams from June to December. Vast they are in numbers beyond human conception. To attempt to describe the migration of the finny multitude would be doing something that some men have attempted, and have been ridiculed for their pains. I will therefore proceed with a description of how, on one occasion, we procured Salmon for the "potlatch" of Skool, and will then treat of the methods of trolling for the Salmon which are in vogue on the Pacific Coast.

*Potlatch* is a word that I presume cannot be found in other than a Chinook dictionary. The literal meaning of the term is "to give." Used in the Siwash sense, it means a great gathering of people, to whom some rich Siwash donates everything he possesses.

Certainly this wouldn't be a bad plan for Vanderbilt, Jay Gould, and other money magnates to adopt. Besides, to be a guest at such a potlatch as these gentlemen could give would be an agreeable experience for a man whose bank account cannot be seen without a powerful magnifying glass. The giver of

a potlatch prefaces the ceremony with a feast. It was to aid in providing Salmon for a feast of this kind that I volunteered, and the incidents of which I will relate.

I had just returned from a hunting-trip in the mountains, was busily engaged in reloading cartridges, when a shadow fell across my threshold. Looking up, I saw, intently watching me, Skool, chief of the Sumas, prince of the Nootsachs of the Lummies, and a man fitted by nature and disposition to be Major Domo of Hades. A dirty, sneaking scoundrel he is, and if he knew how to be worse than he is, Skool would certainly be worse.

I kept on with my work, paying no attention to him. For some minutes he stood motionless as a statue, and then, in a voice modulated to an almost womanly tenderness, he said, "Brother, Skool is here." Then I dropped my tools and asked him what he wanted.

"I have known my brother these many years," began the crafty Skool; "at times he is violent, and uses his hands on the heads and bodies of us, his red brothers. But for all the beatings he has given us, still we love him. True, we do not like to be beaten with sticks; neither do we like to be kicked. Should any other than our brother do these things, some night a knife would seek his heart; but to even be abused by the white hunter, who fears nothing, is an honor. Skool asks a favor of his brother. When I told Skaleel, he said, 'No; I, Skaleel, am old and wise—he will never grant even you, Skool, such a great favor.'"

"Well, what do you want?" I asked.

Then Skool assumed an amusing attitude, and, in a voice that would make the fortune of an actor, began:

"I, Skool, am brave, and wise, and rich. I have many canoes, many horses, many blankets. In the lodge of Skool are many bundles of dried Salmon, many bales of blankets. I have looked at this great wealth; I have thought, here is wealth that would make tribes happy, wealthy, and contented;



yet here I keep it locked up. A month ago I said to the old Prince Skaleel, who before me was the great Tyeec of the Sumas, 'Skool is unhappy, because he is rich.' Then Skaleel said: 'Let Skool give a great potlatch. Let him give away everything he owns. Let the wealth that troubles Skool be distributed among the Indians, from the Salt Chuck to the Father Hills,\* from the Skagit to the Yucon;' and I said, 'It is even as you wish it, O Father.' Then we sent messengers to many lands, far away, in canoes, to the green islands of the North. Horsemen rode through the passes of the White Mountains, and told our brothers, in the land of bunch-grass and bright skies, to come and meet their brothers of the North, at the potlatch of Skool. There the Hyda shall meet the Spokane, and the Snake will meet the Tinneah. O, great will be the gathering of the nations at the potlatch of Skool. But this morning the Skyu came unseen and entered into the breasts of the young men of the tribe, and in the darkness of the night they stole into the lodge of Skool and took from there all the fire-water that was to warm the hearts of the old chiefs of many nations. Now the fire-water has tied their brains and loosened their tongues, and has taken all the power from their legs. They are lying in the lodges like so many hogs. And to-morrow is the feast of Skool, and not a Salmon has he to feast a friend, not to speak of a multitude from many lands. So I said to Skaleel: 'Silalicum will never see disgrace rest on the name of Skool; he will think of the time when his sister, the bright-eyed star of the Sumas, who now is a queen in the happy hunting-grounds of the unknown, was the friend of Skool. Not only will he come, but he will bring his friend, he of the strong arm, with him, and together they will catch many Salmon.' And when the feast is spread, I will say to the envious Smohallah, the dreamer from the land of clear skies, 'Behold these great Salmon! They were caught by Silalicum for the potlatch of Skool, his friend.'"

---

\*Rocky Mountains.

The wily scoundrel carried his point, for in his speech he had revived the memories of one whom to remember was kind even of this reprobate. So, dismissing the Indian, I walked across the valley to the house of my friend Natrass, "he of the strong arm," and told him of the promise I had made to Skool.

"But how shall we catch them?" he asked.

"Oh, that's easy enough," said I; "we will take our 22-caliber Winchesters and shoot them."

"But what if some eastern sportsman would hear of this and go for us in the papers?—it's not sportsman-like."

Then I told him that if some eastern chap should give us a roasting, it would do no harm, for nothing would be easier than to explain that these were Keta, or Dog Salmon, who yearly follow up the migration of the Kisutch Salmon and destroy the spawn, and when that is accomplished, eat up all the Trout in the brooks for amusement; that the Dog Salmon, except for fattening hogs (for which purpose it is much used by the ranchers), and for food for Indians, was worthless.

The next morning, as soon as the sun had risen, we were on our way to the rancherie of Skool. The distance was only two miles, which we speedily passed over, and when we arrived near the rancherie we were greeted by a pandemonium of noises. The young bucks were evidently not sobering off. They peered at us from the openings in the tents, but made no remarks. Perhaps they had reason to remember that they had seen one of us before.

We found Skool and a band of squaws ready to accompany us. They were all armed with gaff-hooks such as I have described. Hearing some murmuring among them, I asked them why they did not want to go, and they told me that a great cultus bear (cinnamon) had chased them away from the fishing-grounds the day before, and that was why the young bucks would not fish—they were afraid of the bear. Just then Skool came back, having overheard the conversation,

and struck one of the squaws in the mouth with all his might. A moment later he was lying on his back with the blood flowing in a stream from his nose. Evidently the white men expected to receive no presents from Skool.

When we arrived at the falls we witnessed a sight almost beyond belief. The falls were more of a rapid than a fall, having a descent of ten feet in twenty-five. The stream was about eight feet wide and two feet deep, and was one living, writhing, struggling mass of Salmon. They were passing up in a continuous body. It was a continuous run of Salmon from the Frazer River, six miles away, to the mountain lake, three miles beyond. Natrass stood like one petrified, and gazed on the scene in astonishment. So much noise did they make that, combined with the roar of the mountain stream, we could scarcely hear each other speak.

I looked at Skool, who stood holding his swollen nose, and saw that he wished me to begin operations at once; so, taking my rifle, I fired the twenty-five shots that it contained into the struggling mass that was forcing its way up the rapid. Natrass did the same. Soon the living became entangled with the dead, and the whole mass came to a stand-still. Hastily reloading our magazines, we awaited the result. Soon the jam was broken; the living forcing themselves up the stream, and the dead ones floating back. Skool and the squaws, wading into the stream, caught the latter and threw them on the bank.

Again we emptied our magazines, with like results. The excitement became great, and the heap of Salmon on the bank became large. Again, again, and again were the magazines filled and emptied, until our supply of cartridges was exhausted; but that did not occur before there was at least a ton of Salmon lying on the bank. Then, at a word of command from Skool, each of the women, slinging fifteen of the fish on a bark rope (they would average about twelve pounds each), threw the bundle of fish over her shoulder and ambled off down the path to the rancherie.

Asking Skool why he did not use the gaff-hooks, he replied that the hard rocks that bordered the stream would ruin them, and that not more than one or two fish could be caught before the gaff would be broken. Asking him if he was satisfied with the number of Salmon caught, he replied that he was not. He said: "Many, many people; all the Salmon twelve women can carry not much." By this time some of the young bucks had partially sobered, and came staggering up the path. As soon as they arrived they began to strip themselves naked, and, taking the gaff-hooks, waded into the stream. They caught but few Salmon before either the hooks or the handles were broken. Then they began to search with their hands under the bowlders and shelving rocks for fish. When they felt one they would slip a hand in his gills, seize him by the tail, bend his body so he could not struggle, and then throw him far out on the bank.

The school of Salmon had (as always is the case in the middle of the day) ceased to run. So it was only stragglers that were now caught. Skool proposed walking over a low ridge and reaching the stream above. The stream is crooked, and by walking a few hundred yards we would reach it at a point where we would meet the great school of the morning. When we arrived at the place desired, we found the stream three times as wide as it was below, and but few inches in depth, with a white, sandy bottom. It was literally filled with Salmon. The Indians at once stripped themselves nude, and, entering the living mass, began throwing them on the bank. We walked along the bank, and, seizing a fish that ventured too near the bank, would throw it on the shore. But we were losing the great excitement the Indians were having, as they ran laughing and splashing in the water. Besides, every fish we caught would splash us from head to foot.

We could stand it no longer. I took my hunting-knife and cut two vine-maple clubs. "Back to the Stone Age!" I shouted. "Away with civilization!" and we were primeval

men once more. Stripping ourselves to the red flannel, we leaped in the brook, brandishing our clubs, and for half an hour waged a war on the poor old Dog Salmon that was never excelled by starving red men for ferocity or destructiveness. The clubs fell with a pendulum-like regularity on the heads of the Salmon. They butted their rough noses against us, and tried to force their heads beneath our feet. When we stooped they would leap over us. It was a scene of grandeur as well as of carnage. Above us frowned the eternal snow-capped mountains; below slept the flower-decked valley of the Sumas; beyond, the great Frazer, glittering in the light of the noonday sun, swept onward to the ocean. Around us were the nude red men, short of limb and long of body, whose bronze skins contrasted strangely with the small, broad-shouldered, slender-waisted white men. It took but a glance to remind one of the change that food, shelter, and civilization wrought in the white men. They were much the smaller, but in a battle without weapons there would have been a sure victory for the whites, even if they were but two to eight.

For half an hour the "Stone Age" war rolled on. All that time the living horde in its blue and crimson dress swept on its upward way to the mountain lake; and all that time had the nude men beaten and thumped the fish as they swept past.

At last the voice of Skool rang out, "Hy-yu! hy-yu!" (enough, enough). We turned and saw a wall of Salmon piled on the bank. Dropping our clubs and dressing ourselves, we returned to civilization, and Skool had plenty of Salmon for his potlatch, and yet none to spare.

It was nearly sunset when the steamer Premier left her wharf at Vancouver, steamed out into the inlet, and thence into the gulf. A smoky haze wrapped the distant mountains, and the waters of the Gulf of Georgia were unruffled by even the slightest breeze. The August sun beat fiercely down on the deck, and most of the passengers kept in the shade of the

saloon, for even in the far north the August sun is too warm for comfort.

Steadily to the south the steamer swiftly forced her way, leaving a long trail of smoke behind her that hung low over the water. Then there came a ripple on the water—a faint breath from the snow-clad mountains in the north—and the air grew strangely chill. The passengers sought their wraps, and soon the bow of the steamer was crowded, all intently admiring the beautiful scenery about them. And a fairer scene was never witnessed on the earth. On either side of the gulf rose a rugged line of snow-capped mountains. These seen in the light of the setting sun seemed to be vast piles of silver. In front rose from the water, like shadowy banks of clouds, San Juan Archipelago, and high above the land, with the Alpen glow shining on its bald top, rose Mount Constitution. As the steamer drew nearer, the islands assumed form, and the rough, craggy ledges of the shore could be distinctly seen, crowned with scattering trees of scraggy fir. The old tourist at the angler's side viewed them with astonishment, and said: "Nothing so grand on the coasts of Scotland or Norway!"

It cannot be that Captain De Wolf is going to ground his steamer? He is heading directly for a point on one of the islands. Then comes a jingle on the slow bell—the steamer moves slower; then a clang on the gong, and her wheels cease to move. Such is the depth of water among these islands that the prow of the great steamer almost touches the rocky shore. A boat is launched, and a lady and a little boy, accompanied by a miscellaneous assortment of camp dunnage, is set ashore. A moment later a splendid Hyda canoe is thrust out of the gang-way. The angler enters it, and with one stroke of his paddle is ashore. But he has forgotten something. "Throw the dogs overboard, Captain!" he shouts; but the captain evidently has ideas of his own, for he sends them on shore in the boat. As soon as the boat returns it is hoisted in the gang-

way; there comes a clang on the gong; the angler shouts his thanks to the kind-hearted, white-haired old captain on the bridge, and with a waving of handkerchiefs on the bow that is answered from the shore, the steamer glides swiftly away from the island.

The angler is evidently an old camper. Almost instantly the tent is raised; the camp-bed is set up, the various bundles are unpacked, and the tent assumes a home-like aspect. Soon a fire leaps into view at the tent door, and soon after the aroma of coffee is spread like balm on the atmosphere. The table is spread, a great can-like torch is lighted and hung on the branch of a tree some distance away, from whence it sends a bright, flickering light, making the surrounding objects look weird in its uncanny light, beyond the circle of its blaze. A pair of shining eyes are seen, and soon the hoot of the barred owl rises, tremulous in its sad cadence.

But the angler and his wife are used to such sounds; so the quivering, jarring voice of the owl has no unpleasant effect on their nerves. As soon as supper is ended, the angler lights a lantern, takes a spade, and walks along the rocky shore until he reaches a sandy cove. Here he sets his lantern down and begins to dig in the sand. At every spadeful he stops and throws a dark-looking object to one side. When he has secured a dozen of these objects he returns to the tent, first placing the objects in the canoe. Then from a box he takes his tackle and views it closely. It is common tackle, too— a long, thick cod-line, on one end of which is a broad copper spoon. This is of rude construction. At a glance an angler would see that it was home-made, being nothing but a piece of copper cut out of a sheet with a tinner's shears. This is attached to the line by a swivel. At the other end a hole is punched in the spoon. To this end, through the hole, a strong cod-hook is attached by a piece of cod-line an inch long. Two feet from the spoon, in a loop, a sinker weighing ten ounces is fastened.

As soon as his tackle is inspected, the angler makes preparations to retire. The dogs are chained up at the door of the tent; he takes his rifle out of its case and fills the magazine with cartridges, for sometimes the Indians of this locality are inclined to be thievish, and even murderous. Then the light is extinguished at the door, a bucket of water thrown on the camp-fire, and all is still, save that the dogs occasionally utter a low growl at some prowling raccoons.

At 3:30 o'clock in the morning a strange jarring, jingling noise is heard. It is the sound of the alarm-clock set to waken the angler at that hour. Before its whirring ceases he is up and dressed, and, with his tackle in hand and paddle under his arm, he seeks his canoe. But when he reaches the shore there arises a subdued sound of muttered disappointment, but so low that it cannot reach distant ears, for the Salmon will not take the spoon when the tide is low. Tossing his paddle and tackle into the canoe, he returns to the tent, unchains his dogs, and then, taking his axe, wanders down the beach to where there are some great logs of fir lying. Then he engages in some of the exercise that the great English liberator of Ireland loves—not that he admired, or even loved, the exercise—but wood must be procured for camp use. Then, after chopping a sufficient quantity, he began, Caliban-like, to carry great pieces of the log to camp. When this was done he again chained up his dogs and returned to the canoe. The tide had turned; but looking over the smooth channel, he could not see the splash of a fin or a silver body leaping in the air. He sat down on his canoe and waited.

Splash! splash! beat the waves on the shore. There was not a ruffle on the water, yet the waves beat gently on the shore. Strange are the mysteries of earth, but far stranger and deeper are the mysteries of the great ocean. Who has not listened to its strange and eerie moaning without a desire to learn the secret of its distress—why its waves beat constantly on the shore, and what causes its continual grieving.



The angler was soon aroused from his musings by a splash, and, looking up, he saw a great silvery form rise in the air; then another, and another. The canoe is launched with a run. Then the angler climbs over the stern, takes his seat in the bottom, and with a stroke of his paddle sends it swiftly darting over the water. On every side the silvery forms are now leaping. On every side circular rings on the water are widening. Taking his spoon he casts it in the wake of the canoe, and it begins to spin as he moves slowly away. Scarcely does the paddle strike the water three times—scarcely thirty feet of the line has been paid out—when, swish! the line is almost jerked out of his hand. He seizes it in his teeth, drops on his knees, and with a backward stroke of his paddle sends the canoe astern. There are a series of jerks that almost loosen his teeth. Dropping his paddle in the center of the canoe, he again takes the line in both hands, and draws it toward him. It does not come easily, for at the end of it is a twenty-pound Kisutch, battling for life and liberty. At last he is drawn up to the side of the canoe, not exhausted in the least. What a beauty he is, with his blue back, his sides adorned with white, and his under-garments crimson! He has rather an intelligent look in his bright eye. Look out! he is making an effort to be off. He rushes up to the surface, folds his tail under him, and is in the air in an instant. Poor Kisutch! That is just what the angler wanted. There is a quick jerk on the line, and the Salmon comes flying into the canoe. A strong club is drawn and falls heavily across the Salmon's head. There is a quiver, and then all is still.

The hook is hastily released from his jaw and is again spinning in the wake of the canoe. Foot after foot of line is paid out, until one hundred and sixty feet are out. Then the angler, taking the line in his teeth, paddles swiftly away, but does not go far before the line is jerked from his mouth with such violence that for the instant he imagines his neck is broken. Luckily, the line is fastened to the thwarts of the

canoe. Again the paddle is taken, and once more does the backward stroke send the canoe astern. The line is swerving through the water with great velocity. Taking it in both hands, the angler begins to haul it in, hand over hand. Then a great Shad-like body leaps out of the water, shaking its head in a vain endeavor to loosen the hook from its jaw; but it is firmly caught. Again and again it leaps, but to no purpose; every moment it is drawn nearer and nearer to the canoe. At last it is swimming alongside. What a magnificent fellow it is! But it is far too large to try to jerk into the canoe if it does not spring, and it evidently has no idea of springing. With a sudden wave of its tail it goes boring down. Foot after foot of taut line is given it. All at once the pressure on the line ceases, and the angler begins to look blue. Has the hook broken? No; not yet. Suddenly the line again swerves through the water with great speed. Hand over hand it is drawn in again. Then the great fish rushes to the top of the surface, and in a hurried succession of leaps throws himself in the air, as if dancing some aquatic jig. But a tight line is kept on him, and inch by inch he comes to the side of the canoe. At last he is drawn, helpless and gasping, within reach. A hand is inserted in his gills and he is thrown into the canoe, where a blow from the club ends his existence. He is a Tyee, and will weigh at least thirty-five pounds.

A faint gleam of light rests on the crown of Mount Constitution. Far across the gulf, the summits of the Olympics have caught the glow of the rising sun and gleam brightly in the early morning light. Afar off on the gulf are seen the sails of a ship, and trailing along the horizon is a long wreath of black smoke that indicates the course of an ocean steamer. Nearer at hand dark bodies are moving through the water; at frequent intervals a column of water rises high in the air. The dark objects are a school of whales at play. Around the canoe the air is filled with flashing and splashing creatures. The angler would not exaggerate if he should say that he saw

a thousand Salmon in the air at once. When he has rested for a few moments he again takes his paddle, and the bait is again sent spinning behind him, only to be seized in a short time by another Salmon.

This one, however, does not make the determined fight the others did. There is no singing of the line, no leaping in the air, no sounding beneath the canoe into the depths of the water. Hand over hand the sluggish fish is brought in, and with a jerk is launched in the canoe. It is a belated Nerka, who should have been with his unreturning brothers when they ascended the Frazer, months before. But if not a gamy fish, he is a palatable one, and the angler does not regret his delay. This specimen would weigh about ten pounds.

There are other fishermen abroad this morning. The angler hears the swish of a paddle, and, looking up, sees an Indian in a small canoe. He salutes the angler with a "Klahowa, tillicum." "Klahowa" is growled back at him. Then the Siwash paddles alongside the angler's canoe and introduces himself.

"I am Klumukus," he says; "I am a very good man. Do you see where that smoke curls over the spit? There the man who married my sister lives. He is also a good man; he is a white man—his name is Ben of Kalamazoo. We are very dry—so dry that I fear we will soon die if we do not taste the fire-water of my white brother. When we saw your canoe, Ben said: 'Do you see that beautiful canoe? See how grandly the man in it paddles. He is a great man—he is a Hyas Tyee. No doubt he has many bottles of fire-water, and will gladly spare his white brother, Ben of Kalamazoo, and his red brother, Klumukus, one.' Brother, I have spoken."

"Get out!" said the angler, and he turns his canoe abruptly from the tawny villain, who had kissed the Chinook blarney-stone, and is soon engaged in royal battle with a Kisutch. Nor does this fight last long, for the regal fish is soon gasping in the bottom of the canoe. This is repeated often

before the report of a rifle comes sharply over the water from the tent, summoning the angler to breakfast. Soon, with long, swinging strokes of his paddle, he reaches the beach near the tent, springs ashore, and draws his canoe up on the beach. The fish are unloaded and counted, and he finds he has caught eighteen Salmon that will average sixteen pounds each.

After breakfast he takes a hatchet and breaks up the dark-looking objects that he dug up in the sand the night before, which prove to be mussels, and scours the flesh white with sea-water and sand. Using these for a lure on his rude spoon, before noon he succeeds in catching twenty-four more Salmon. When the steamer calls for him the following evening, he has at least half a ton of Salmon carried on board.

Think of it! O ye anglers who pay an exorbitant license to fish in the mosquito-haunted rivers of Canada! Here one man in two days has caught more Salmon (and he does not consider himself an expert angler) than you could have caught in a Canadian river in a whole season. Then remember that directly west, where the Northern Pacific, or the Union Pacific, or the Canadian Pacific Railway may land you in four days, lies a region that for beauty of scenery, for mildness of climate, and for absence of insect plagues, the world can never equal. Leave the insect-haunted rivers for old fogies, and seek an outing in the summer-land of sunset, and you will always bless the day you did so, and the man who advised you thus.

You need not copy the rude methods of the man to whom I have introduced you. You may, if you will (but I do not advise it), bring with you your light, split-bamboo fly rod, your neatly turned Skinner or Buell spoon, your fifteen-thread Cuttyhunk line, and your Kentucky reel, and may enjoy the sport to your cultivated taste.

True, our Salmon do not take the fly, but they are as gamy when hooked as your Canadian Salmon; our waters are as clear as your Canadian waters; our skies as bright as your

STEEL HEAD—*Salmo Gairdneri*.

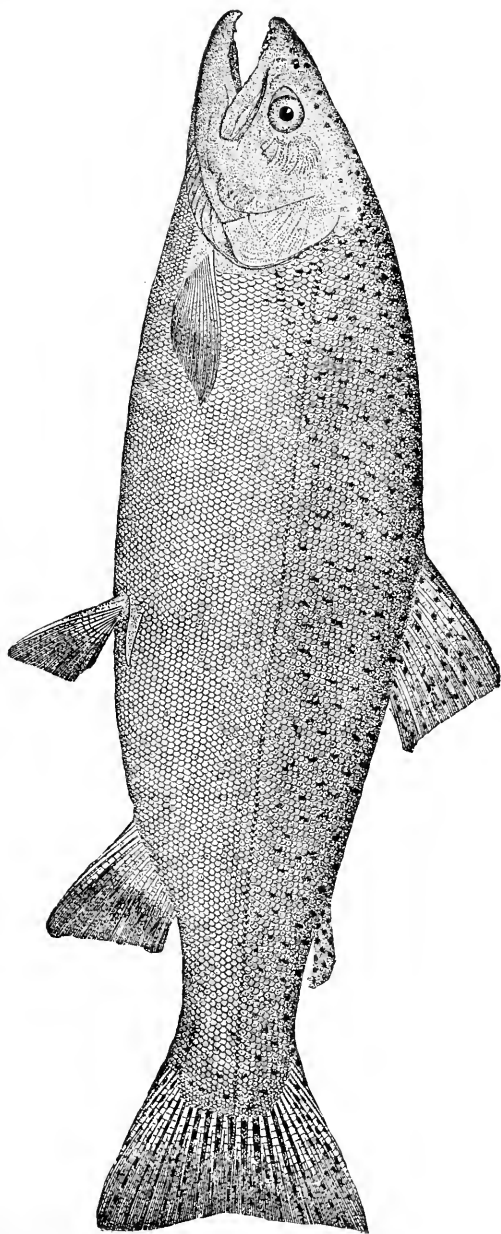

Canadian skies, and the labor of angling here is as nothing compared to that of climbing over logs and boulders, and tramping through jungles on your Canadian rivers.

For thirteen seasons has the engineer caught the lordly Salmon after the ancient and honorable manner of the Puyallups, the Dwuamishes, and the Lummies; which manner consists of attaching a chalk-line to a spoon cut out of a piece of tin, connected with a swivel. In connection with this outfit is a stout club with which the sportsman batters in the skulls of his victims. This is a very killing combination.

Some kind individual, with malice aforethought, on the publication of my Salmon-fishing sketch a year ago, sent me an anonymous present of a fishing-rod, with reel and line attached. It was a very pretty rod, and bore the name of a popular eastern manufacturer. I felt proud of it, and exhibited it to all my sportsmen friends. But alas! it is gone, and should any brother sportsman in Alaska or Norway catch a Tye Salmon with this rod in tow, he will confer a favor by returning it C. O. D. to Silalicum, Seattle, Washington, and he may keep the fish.

The engineer will now proceed to unfold the growing horror of his tale. He will unveil the dire accident that caused him to lose his beautiful rod, and made him an object of mirth and ridicule to some hundreds of cosmopolitans who witnessed his degradation, and giggled, screamed, and chattered at his shame.

The new-born day had dawned clear and fair. A breath of balm, wafted from fir and cedar forests, was in the air, and a low north wind bore with it the fresh salt scent of the sea. The stars were dying in the blue, and far across the snow-crowned mountains in the east smiled the crimson blush of morning. A dreamy stillness lay over the earth, sleep ruled everywhere, and the bustling city lay wrapped in a dream of calm.

With rod in hand the engineer sought the boat-house, and a short time later was gliding noiselessly over the water in his Hyda canoe. Under wharves, among a fleet of all kinds of smaller crafts, he pursued his noiseless way, until he reached the city front. Then, threading among ships and steamers, riding peacefully at anchor, he at last found himself alone on the bosom of the bay. When at sufficient distance from the shore he jointed his rod and attached a spoon of his own construction to the line. Reeling off one hundred and sixty feet of line, he knelt in the bottom of the canoe, holding the rod between his knees, and began to paddle swiftly across the bay.

The Hyda canoe is a craft peculiar to the northwest coast. Formed out of a log of cedar by slow and diligent chopping with a crude adze in the hands of an Indian it becomes a thing of shape, balance, and beauty, that a white man can never successfully imitate. Superstition ever being prominent in the savage mind, the prows of these canoes are always shaped into one of the totems by which the different families of their tribes are designated—either the bear, the raven, or the wolf. The canoe that carried the engineer this fateful morning was about fifteen feet long and twenty inches beam. It was gayly decorated at the prow with a wolf-head that possessed two large, glaring eyes of an exceedingly yellow color.

Evidently the Salmon were not hungry. The engineer paddled half-way across the bay, but the savage rush that tells that the Tyee is there was not telegraphed along the line. Other boats now joined him, and four great scows loaded with nets and Italians came creeping out from shore and anchored in the middle of the bay, about a quarter of a mile apart. Then the boats that had towed the scows out began to spread the nets, forming a half-circle around the scows, perhaps two hundred yards in extent. The foreign ruffians were evidently happy, for, as they spread their nets, they sang a song very much like this;

“ We catcha plenta da salmi;  
    We catcha him ebera day;  
We sella him to da mon  
    At da cannery ober da bay,  
Den we playa plenty da poka,  
    When da daylight fada away.”

Boats of all kinds covered the bosom of the bay. All nations on the earth were represented in that motley assemblage, from the tiny dot of an Indian girl in her little canoe, to the English “Me Laud” in his whale-boat with six men at the oars. It was a good-natured, jolly sort of a mob, too, even if it was a heterogeneous one. In crossing and recrossing so often, lines would become entangled, but such mishaps were taken as unavoidable, and a commendable Christian spirit was displayed on such accidents occurring.

The engineer, gazing down the bay, saw something flash in the air like the gleam of a silver scimeter. Hastily reeling in his line, he began to paddle strongly in that direction. The flashes then began to multiply by hundreds, and soon a great shining body leaped in the air at the very prow of the canoe, and fell with a heavy splash, leaving a widening ring on the hitherto unruffled mirror-like plain. A moment later the troll was spinning through the water, soon to be seized with a heavy twitch, and then the line began to hiss through the water and the reel to whirl.

Dropping his paddle in the bottom of the canoe, the engineer began “monkeying” with the Tyce at the other end of the string in the sportsman-like manner recommended by the dude sportsman of the effete East. A tight line was kept on him till at last his frantic leaps and rushes were ended, and he floated, gasping, at the side of the canoe. A boat containing a sickly-looking dude and two pretty girls fresh from cultured Boston now drifted alongside, and one of the ladies requested the privilege of landing the fish. The rod was passed to her, and after a little delay the victim was gaffed and lay floundering in his last struggle in the bottom of the skiff. From the



strike until he was landed was fully twenty minutes. In the ancient aboriginal manner he would have been "taken in and done for" in one minute. Nineteen minutes of useful time wasted just to be in the fashionable swim!

After presenting the young lady with the victim she had landed, the engineer paddled away, and soon joined the merry throng of anglers. A myriad of Salmon surrounded them, and but few of the two hundred or more boats that were in the fleet had failed to capture one or more Salmon. But in all that flotilla the engineer was the only one who attempted the scientific method. Striking a fish, he began to reel in or pay out his line, as the rushes of the fish required. Then the ridiculous appearance that he made became strongly apparent, when, after landing his quarry (a tiny fingerling of eight pounds), he became an object of ridicule and the subject of much chaffing. Ancient squaws derided him as "cultus" (exceedingly bad or worthless). A weather-beaten old tar with one leg called him a dude, and said he was sorry for him. Chinamen smiled that bland smile that means certain death to the one smiled upon, especially if the smiler is a member of the noble order of Highbinders, and happens to have his Malay Kriss about him. People of many other nations made equally flattering remarks to him. Then he became indignant, said he would seek better company, and began to paddle sarcastically in the direction where some sea-hogs, or porpoises, were rolling in the straits.

The course in which he was paddling brought him near one of the scows where the Italians were drawing a net. Four sturdy macaroni-fed Romans were pulling on each end of the net, while two Greek patriots beat the water with wide oars, that made a great splashing, on the opposite side of the scow, in order to frighten any Salmon who might attempt to escape back into the net. The engineer waited until the net was drawn and the fishes tossed into the scow. In this draw over three hundred Salmon and one small Shark were

captured. The latter, in endeavoring to escape, had torn the net, and many Salmon had escaped through the rent. When the poor sea-wolf was drawn upon the scow, the foreign gentlemen began to slash him savagely with their knives. After stabbing him in many places they cut off his fins, and then threw him overboard—a warning to all net-destroyers.

A short distance from the scene of this tragedy the engineer hooked a Salmon and landed him without difficulty. This Salmon was a Nerka, and was a tame fish indeed. Like Crockett's 'coon, he just come in. This spiritless disgrace to the Salmon tribe was bestowed upon a hapless Chinaman who was greatly out of luck and had not caught a fish all morning. Here the engineer was joined by the Boston dude and his fair companions, who had been unsuccessful, not even having had a nibble all morning. There is certainly no gallantry among Salmon. Even death by such fair hands must be sweet.

While the engineer was paddling slowly along, talking to the occupants of the skiff, he was aware of a strike—of a swift, sudden, determined strike. The rod was jerked until it bent in the arc of a circle, and the reel made a whirl like that made by the wings of a frightened grouse. His line went zig-zagging through the water with great velocity.

It may be easy enough to manage a fish in the dude style where the angler has plenty of sea-room, but it is no picnic to do so when one is in the center of two hundred or more boats. Still the engineer kept on playing his Salmon in true scientific style. When the line slackened he would speedily reel it in, and when the fish pulled strongly on the line he would allow the reel to run. He became the center of all curiosity. Every other boat suspended operations—the occupants vied one with the other in making uncharitable remarks. The low, guttural voices of the Indians could be heard as they muttered curses on the iconoclast who would upset old customs. At last the Tyee was brought, gasping, to the side of

the canoe, and the engineer, taking his gaff, reached carefully down, and was just in the act of hooking the fish, when, with a wave of its tail, it moved away to the leeward. The engineer leaned far over the side, and made a fearful sweep at it with his gaff, when his canoe glided from under him, and he saw the butt of his beautiful rod vanish in the water, as down, down he went. At last he returned to the surface, blew the water from his nostrils, and swam to his canoe.

His reappearance was greeted with a chorus of howls that made the echoes ring. The Boston dude rowed his boat alongside, and the engineer, with the help of a hand extended by one of the ladies, clambered into the boat.

The canoe was soon righted, and his paddle, that was floating on the water, secured. Then entering it, he paddled with downcast eyes and heavy heart through the flotilla of Salmon-fishers, and never stopped until he reached the boat-house. When he secured his canoe he went and danced a war-dance, sung a scalp-song, loud and wild, and since then no one has dared to ask him how he likes the dude way of catching Salmon. And around the Indian camp-fires the story is often told, how a cultus white man attempted to improve on the method of catching Salmon practiced by their fathers since by-gone ages, and how the spirit of the waters, angered at his conduct, dragged him from his canoe and almost drowned him.



## THE LAND-LOCKED SALMON, OR WANANISHE.

BY J. G. AYLWIN CREIGHTON.

SYNONYMS.—*Salmo Salar*, variety *Sebago*; Sebago Salmon; Sebago Trout; Schoodic Salmon; Land-locked Salmon; Silfverlax; *Salmo Argentus*; Winanische, Wananische, or Ouinaniche.

IT used to be an article of faith with naturalists and anglers that a Salmon—using the word in its every-day sense, not in the technical one of *Salmo*, which generic name includes many very different fish, some of them merely Trout—is a salt-water fish which comes into fresh-water rivers to spawn, and then returns to the sea, or, to use a convenient word, is anadromous. Hence the specific designation *Salar*. The older British writers on the *Salmonidæ* seem never to have heard of any exception to this rule, or else, in referring to the question whether Salmon can make their home in fresh water, answer it with a decided negative; in a few instances quoting cases of fish dying under the experiment.

Yet nothing in the range of observed facts relating to the *Salmonidæ*—as to which the great modern English ichthyologist, Gunther, observes that “The unusual attention which has been given to their study has revealed an almost greater amount of unexplained facts than of satisfactory solutions of the questions raised”—is better established now than the existence in certain parts of the United States, Canada, and Sweden of a Salmon which inhabits lakes, and is anatomically indistinguishable from the salt-water Salmon. The Land-locked Salmon of Maine have been well known for over fifty years. Mr. C. G. Atkins, superintendent of the Schoodic

Salmon-breeding establishment, on Grand Lake Stream, says that it occurs only in four limited districts, all in Maine—the systems of the Presumpscot, the Sebec, the Union, which is a tributary of the Penobscot, and the St. Croix Rivers. Lake Sebago in the Presumpscot system furnishes the largest specimens and has given the name by which this fish is known to scientists, *Salmo Salar*, variety *Sebago*. The Schoodic River, which is the west branch of the St. Croix, and into which Grand Lake discharges, is the origin of another and more popular name. Since the founding of the breeding establishment in 1875, the Schoodic Salmon have been widely distributed in the United States, with varying success. They have also been transported to Scotland and Germany, where they have done well.

The Winanishe, Wananishe, or Ouinaniche, of the Upper Saguenay and the Lake St. John river system, has also been well known since the settlement of that region of the Province of Quebec, about 1850, and was familiar to the Indians and Hudson Bay Company's voyageurs long before then. The etymology of the name is unsettled, but is probably derived from the Cree root "wan," to lose or mistake, applied either to the fish having lost itself or being taken for a Salmon. Though Charles Hallock fished the Upper Saguenay, or Grande Decharge, as it is locally named, and described the Wananishe fifteen years ago, only a few anglers seem to have known either the fish or its habitat until lately. Their re-discovery by fishing tourists and sporting journals and the marvelous accounts given in railway and hotel advertisements are amusing to those who have made for many years a special study of the fish and region, but it is to be feared that they mark the beginning of the end of a peculiarly interesting game fish.

The Wananishe and the Land-locked Salmon of Maine are identical, the only observable difference being a slight one in coloration. This is always an unimportant distinction, and

in this instance does not amount to so much as is often found in Brook Trout inhabiting the same waters, to say nothing of the wide differences in color and form between Trout of different localities.

The same fish occurs in several lakes in Nova Scotia, where it is erroneously called "Grayling," in Lock Lomond and other lakes in New Brunswick, and according to Mr. Hallock, in the lakes of Peterborough County, Ontario. It is possible that the Salmon, which within this generation's memory abounded in Lake Ontario, were also purely fresh-water fish. That at least is the opinion of Mr. Wilmot, the superintendent of the Canadian Government Fish Hatcheries, who has studied them all his life. The "Silfverlax," or Lake Salmon of Wenern and other Swedish lakes—the *Salmo Argenteus* of Swedish naturalists—corresponds very closely, both as to the descriptions of its appearance and the circumstances under which it is found, with the others above mentioned. In British Columbia, too, a lake Salmon is found, concerning which my information is at present too meager to enable me to say more than that it is highly probable that under similar circumstances some of the Pacific Salmon, admittedly quite distinct species from the *Salmo Salar* of the Atlantic, have acquired a fresh-water habitat. In some of the rivers of Labrador, which are all simply the connections between, and discharges of, extensive lake systems, I found and identified, in 1889, my well-known friend, the Wananishe. It will, therefore, be seen that the range of this fish, so far from being limited, is very extensive. The probability is that as opportunities for skilled investigation multiply, it will be found in many other places.

Three things are noteworthy about its distribution. It is always found at the head-waters of rivers to which Salmon actually resort now, or to which they are known to have resorted. Though in some places there are apparently insuperable obstacles in the way of its ascent from the sea,

there is nowhere, so far as I can learn, any positive evidence that it cannot descend if it would. In every case the rivers are the outflow of large lakes which seem to be what the sea is to the salt-water Salmon.

It is a vexed question whether or not the species was known in Maine before the erection of dams preventing the ascent of the Salmon, which once were so numerous in that State; there are no natural obstructions. In the Saguenay there are no high falls, none of them are perpendicular, and the rapids, though very strong, are by no means insuperable for Salmon, and, with intervals of quiet water, extend only some forty miles from tide-water. In New Brunswick the obstructions are artificial, and have been made within the memory of man. At Grand Lake, Nova Scotia, the communication with the sea is direct by the Shubenacadic River, in its lower reaches, a muddy, tidal stream. In other Nova Scotian localities, dams may have cut off the connection. In the Stony Lake Chain of Peterborough County, Ontario, there is rather a round-about, but, on the whole, an unobstructed connection with Lake Ontario, and thence directly with the sea by way of the St. Lawrence. The rapids between Kingston and Montreal could be run by without difficulty, but the journey from salt water is a long one, and it is many years since a Salmon is known to have been caught in the St. Lawrence or any of its tributaries further up than the Jacques Cartier River, a few miles above Quebec, and now the most westerly Salmon stream in the Province. In Sweden the Trolhattan Falls, five in number, with a total height of one hundred and twenty feet, in a narrow gorge, are admittedly impassable for Salmon. In British Columbia, the access to the Kootenai lakes is obstructed by a heavy fall which may have been surmountable at times; but Salmon may also have found their way into these lakes, at periods of extraordinarily high water, through the marshy belt, only two miles wide, which separates the Kootenai River above the lakes from the Upper Columbia.



In the Labrador rivers there are ranges of falls near the sea, to get over which the Salmon have to await suitable stages of water; in some instances these falls are almost insurmountable, but in most cases there are large, deep lakes above them abounding in fish-food, and connected by stretches of swift water, broken by falls and rocky rapids.

“Land-locked,” therefore, is rather a misnomer, if it is meant to imply any natural and involuntary restriction upon a return to the sea. But as all other designations are merely local names, and it is hard to find a satisfactory one, it may as well be retained.

It remains to be seen how far it is true that these so-called Land-locked Salmon would not go to the sea if they could. Mr. George F. Boardman, in a letter to Mr. Hallock, given in full in the *Sportsman's Gazetteer*, states that in his boyhood they were plentiful in most of the rivers of the Bay of Fundy, as well as along the State of Maine; that they were common to the tide-waters, and were taken as far down as there were fish-weirs. Mr. C. G. Atkins says:

“There is nothing at present to prevent any of these Salmon going out to sea from any of those waters where they are now found. There are no obstructions to their coming back if they once went to the sea; and these same obstructions would prevent the sea Salmon having access to the upper waters where the Land-locked Salmon now live.”

As Dr. Francis Day observes, it is certainly remarkable that among the Scandinavian land-locked races some are found in a number of lakes with broad outlets into the sea. This exactly corresponds with my own observations in Labrador, where I found the *Salmo Sebago* in tidal but fresh water, as well as at the outlet of the lakes, and in company with the true Salmon and Grilse, which gave an admirable opportunity of direct comparison of the two varieties. I was fortunate in having with me a Saguenay canoe-man, in whose company I had caught many a Wananishe. The first of the Labrador

specimens he recognized at once with great delight, as he had been entertaining his incredulous companions with stories of the fighting powers of the little Salmon of Lake St. John. The other men, natives of the coast, old Salmon fishermen, able to tell at sight fish from different rivers, were puzzled at the difference in color and general appearance of the fish, but never questioned its being a small Salmon. The external difference between it and the Grilse, a large run of which we were then having, was equally noticeable.

In the Upper Saguenay there is nothing whatever to prevent the descent of the fish to the sea; the way is direct, broad, and easy, as compared with some Salmon rivers. There is a tremendous rush of water in the rapids, but the strongest of them all, the Grande Chute, is the one by which the fish descend from Lake St. John. As a matter of fact, large numbers of Wananishe are to be seen in the brackish water of the tide-way at Chicoutimi every spring at the time of the heavy freshets, and may be caught at the head of the tide just below the first rapids from that time till the ice sets in; stray ones are found in the Salmon streams tributary to the Lower Saguenay, in the salt water at Tadoussac, and a couple were taken in the St. Lawrence just above the Saguenay.

Whether these Saguenay fish reascend from the tide-way is as yet undetermined. In 1883 and 1885 I marked several hundred, but have never heard of them again. The modes adopted—cutting a hole with a punch in the dorsal fin, and snipping off a portion of the adipose fin—are unreliable, for the fins of fish grow like one's finger-nails, and lacerations soon heal, but they were the only means available at the time. A systematic series of experiments by marking fish with numbered tags of platinum, attached to the dorsal fin by platinum wire, is much to be desired. The recapture of a very few fish thus identifiable would probably solve the whole problem of their movements, and shed much light on the questions as to the origin and permanency of the species.

The rivers which flow into Lake St. John all contain Wananishe, which, however, do not ascend them in any great number till the autumn. The ova are well developed at the end of September, and the fish are then on their way to the spawning-beds, which are, as in the case of the Salmon proper, gravelly shallows with a steady current over them. The spawning season is at the end of October. The spring movement of the fish from Lake St. John down into the Grande Decharge, and the autumn movement up into the rivers flowing into the lake, correspond with the spring and autumn migrations observed at Schoodic Lake by Mr. Atkins. A number of the fish, however, remain in the Grande Decharge and evidently breed there and in its small tributary streams, for the adults can be caught through the ice, and I have taken parr and smolts at almost every part of the Grande Decharge. These, however, may possibly have come down with the spring freshets. On the other hand, I have repeatedly taken adults there in September with milt and ova well developed; the change of coloration, hooked lower jaw, indifference to food, sluggish movements, and all the other characteristics of Salmon near spawning-time, were well marked in them.

The Wananishe reach their greatest size in that region in the large lakes connecting with the rivers that flow into the north side of Lake St. John after long courses over numerous and very high falls. In Lake Tshistagama or Sautagama, on the Peribonca River, the water is deep, cold, and abounds with small food-fish. The Wananishe will not rise to the fly in the lakes, but are readily caught with bait, a spoon, or the artificial minnow. Specimens from this lake, weighing from five to seven pounds, were found gorged with young Whitefish and another small fish, apparently a species of Smelt (*Osmerus*), but too much decomposed to be precisely identified. I observed a peculiar circumstance in connection with these Wananishe on the Peribonca River, in September, 1885, at the Chute au Diable, a fall of about eighty feet

in height, divided by an island into two branches, one of which is perpendicular, the other broken into steps. In a small deep hole half-way up the latter, I caught five Wananishe of from two and one-half to four and one-half pounds in weight, which were apparently spawning. The ova and milt exuded when the fish were handled; the noses of the fish were abraded as when they turn up gravel to form their beds, and the ovaries of one of the females were half emptied. It was earlier than the usual spawning-time, and on the most unlikely spawning-ground that could be imagined. I should not even have suspected the presence of any fish there.

We were returning from a long journey up the river, and had run out of provisions altogether. One of the men whom I had set to work to catch something, somehow, threw his bait into this hole casually, on his way down to the foot of the fall, and had a rise from a large fish. As anxious a day's fishing as I ever did succeeded this. A wary cast of a Jock Scott brought a fish to look at the fly, and turn back deliberately. After a half-hour interval he came again. Every fly in the book, and every dodge I knew, were pitted against the provoking indisposition of those Wananishe to be caught. At last it became a matter of personal pride as well as of hunger. Eventually artfulness and patience triumphed, and an interesting discovery, as well as a good supper, resulted; but it was hard to take measurements and notes of those fish before handing them to the cook.

The size of the Land-locked Salmon varies a good deal, in different waters, but is pretty uniform in each locality. According to Mr. Atkins, the Sebago and Union fish are larger than those of the Sebec and St. Croix. The Sebago fish average at spawning-time four or five pounds for the males, and a pound less for the females; but specimens running as high as twelve or fourteen pounds are not rare, and there is a record of one weighing seventeen and one-half pounds. The Union River fish are about the same size as those of Sebago.

The St. Croix fish vary in size at different parts of the water system in which they are found; those of the Schoodic River and Grand Lake Stream, where they are most numerous and where the hatchery is situated, average a little less than three pounds; specimens over six pounds are rare, and there is no record of anything over ten pounds. It appears that the average size in Grand Lake Stream increased to about four pounds between 1875 and 1884. These fish, however, were the ones specially taken for breeding purposes by Mr. Atkins, and therefore would probably be large; and owing to their protection for nine years, there would naturally be a greater number to select from.

The Lake Wenern Salmon of Sweden, like the larger of the Sebago examples, are equal to sea Salmon in size. Dr. Day gives the lengths of a couple examined by him as thirty-one and thirty-three inches, and other accounts show that they run from seven to twenty pounds.

The Nova Scotia and New Brunswick fish are small—the latter especially; a couple of pounds is a good weight for them, but the waters in which they occur are comparatively restricted in area, and they are much fished. Hallock states that he has seen specimens of the Salmon from the Stony Lake Chain, in Ontario, weighing twenty pounds. This—curiously enough, for it is the nearest to me—is the only one of the “Land-locked Salmon,” besides the Swedish variety, that I have not personally examined; but I have never been able to visit the region during the fishing season, and cannot succeed in getting a specimen. I sometimes think Mr. Hallock’s fish must have been the true Salmon of Lake Ontario, now all but extinct. In spite of efforts to preserve them, and to propagate them by artificial breeding, which promised for a time to be successful, the changed conditions of the streams, owing to the clearing and settlement of the country, have been fatal.

It is worth noting that, though game and game fishes can and do survive civilization in Europe, they soon disappear

on this continent, under conditions that seem more favorable. Trout and Salmon manage to exist in British streams bristling with nets, weirs, dams, and all manner of destructive engines, and polluted by sewage and the refuse of manufactories, but in America, once the country is cultivated, they vanish. The preservation of their spawning-grounds in the natural condition, if they can get there at all, is probably the reason in the former case. In England the change in rain-fall, due to the disappearance of forests, can never have been so great as it is in America.

The Lake St. John and Saguenay fish average a little over two and one-half pounds. Four-pound fish were numerous enough a few years ago, but anything over that size is large, and only occasionally will a six-pounder be found. Out of many thousands I have seen but one seven-pound fish; it was twenty-seven inches in length, and a very lank specimen. If properly filled out, it would have weighed nine or ten pounds. This solitary instance gives one some faith in the stories of the large size of the Wananishe when the region was first settled, forty years ago. Occasionally very large ones are seen feeding by themselves, but they are extremely wary, and there is no authentic record of one above seven pounds, though the late Senator David Price, of Chicoutimi, is said to have caught one of eleven pounds in weight.

I did not get enough of the Labrador fish to establish an average, but I imagine them to be large, because of the abundance of food, great area of the lakes, and freedom from disturbance. My specimens varied from a quarter of a pound to six and one-half pounds. The Indians said much larger fish were plentiful far up the rivers, but we all know how that is ourselves.

As my own observations have been chiefly of the Wananishe, I will confine myself to the appearance and dimensions of this variety, which agree very closely with those of the Schoodic

Salmon as described by Mr. Atkins. The Wananishe is a much longer fish, and altogether larger, in proportion to his weight, than is the Brook Trout, as the following figures show:

	BRANCHIOS- TEGALS.	PECTORAL.	DORSAL.	VENTRAL.	ANAL.
1. <i>Salmo Salar</i> —Jordan & Gilbert.....	11		11		9
2. <i>Salmo Sebago</i> —Hamlin.....	12	15	12	9	10
3. <i>Wananishe</i> —Lake St. John.....	11	14	12	9	10
4. <i>Wananishe</i> —Labrador.....	12		11		9
5. <i>Salvelinus Namaycush</i> —Jordan & Gilbert.....	11-12		11		11
6. <i>Salvelinus fontinalis</i> —Jordan & Gilbert.....			10		9

Specimens under a pound are rare, and are found in shallow water and small streams. It was a long time before I succeeded in getting a Wananishe parr, even in water which I knew to be just below favorite spawning-grounds. They are almost indistinguishable from Salmon parr, and are probably taken for small Trout, if ever observed at all. The four-ounce fish have already put on the silvery livery of the smolt, through which the transverse bands of the parr-marking show distinctly. In specimens of from a pound to a pound and one-quarter the silver scales rub off easily, and the parr-bands are to be seen even on fish up to two pounds in weight. Mr. Atkins states that the marks are distinct on the under side of the skin of adult fish of the Schoodic variety. This persistency of the parr marking is considered by him to be evidence of arrested development, and perhaps rightly so, when we connect with it the fact, established by the Howietoun experiments, that the parr and smolt of the sea Salmon, both male and female, when bred and raised entirely in fresh water, can reproduce their species, and that their progeny again are fertile.

As to shape, the Wananishe is a perfect Salmon, only a dwarf; and the highest ichthyological authorities on both sides of the ocean are agreed that there is no difference of anatomy between *Salmo Salar* and *Salmo Sebago*. I have myself dissected many specimens of sea Salmon and Wananishe, but can detect no permanent or tangible mark of difference between them.

The preoperculum, or small bone at the back of the gill cover, has the rounded corner characteristic of the Salmon. The system of dentition in the Wananishe is precisely that of *Salmo Salar*, but the teeth are larger and more numerous on the vomer and palatines. This is probably a case of specific adaptation, as the Wananishe lives much on small fish, and unlike the sea Salmon when the latter is in fresh water, is continually feeding. In some specimens I have found a few teeth on the hyoid bone, though Jordan & Gilbert ("Synopsis of the Fishes of North America," 1882, p. 311), following Gunther, give the absence of hyoid teeth as a characteristic of the genus *Salar*.

The number of spinal vertebræ is 59-60; of cæcal appendages, I have counted from 50-60 in different specimens.

There are 120 rows of scales along the lateral line, 11-12 in a line from the edge of the adipose fin to the lateral line, which, if continued, would pass just above the pupil of the eye, and is well marked.

The fins are proportionately much larger than in the sea Salmon, especially the tail, which is deeply forked in the young fish, but only slightly lunate in large adults. In a five-pound specimen it will have a spread of seven or eight inches; in a three-pound fish, six inches. The dorsal is high and broad, the pectorals long. The adipose fin is unusually large.

The number of branchiostegal and fin rays has long been abandoned as a specific criterion, but the following comparison shows the similarity in this respect between the various species:

LENGTH OVER ALL TO END OF TAIL.	GIRTH AT DORSAL. INCHES.	WEIGHT. LBS. OZ.
8¼	3¾	4
9½	4¾	6
12	6	10
15	7¾	1 0
18	9	2 2
22	10½	3 4
23½	11¼	4 2
25½	11½	4 8
25	12	5 4
26	13	6 0

The eye is remarkably large, about three-quarters of an



inch in diameter in the adult, with a pupil a quarter of an inch in diameter. These measurements are much greater than in the sea Salmon of fifteen to twenty pounds weight.

In the young fish the back is of a bluish olive when just out of water, turning into a silverish steely blue, which changes to silver below the medial line. The belly is pure white. The back is thickly maculated with black oval spots, not vermiculated as in Trout. On specimens under a half-pound, there are no X-marks on the sides, but seven small, round, bright scarlet spots evenly spaced along the medial line, with an additional one just above the pectoral fin. The dark blue parr-bandings are eight in number, and about three-eighths of an inch wide; the head is deep bluish green, inclining to black; the gill covers silver, with olive and green shading. Upon the operculum are two or three irregular, dusky olive, purple and green patches, and two or three deep black, perfectly circular spots of small size. The throat and branchiostegals are white, shaded with dusky gray, inclining to lead color. There are some blackish spots along the base of the dorsal, but none on the tail. The adipose fin is blackish blue.

In the fresh-run adult the color runs from deep black on the back, through bluish green on the sides, to silvery green at the medial line, and silvery white below that. When the fish is just out of the water the body-color is very iridescent, showing green and purple bronze with a tint of rose. The oval spots on the back are so black and run so closely together as to be hardly distinguishable when the fish has been a short time out of water, but in the living fish, observed under water in a good light, they show plainly upon the olive ground-color. The head is deep black on top. The ground-color of the gill covers is a deep-green bronze, with patches of dark purple and greenish and blackish bronze on the operculum, which has also three or four circular black spots of varying sizes, and generally one large irregular-shaped black spot on it. The lower jaw and throat, to the gills, are of a leaden gray in fine dots,

thickly spread on a white ground. Adults are all marked on the body with black spots, either irregular quadrilaterals or double X's, not the single X of the Atlantic Salmon. These spots do not come much below the medial line, and vary a great deal in number and size in individuals. They do not show on the gill covers, tail or dorsal fin, but the latter is usually thickly covered with circular black spots.

The coloring varies somewhat with locality, age, and season, but there is no marked difference of it in the sexes, except at breeding-time, when the male, as in other *Salmonidae*, is much the brighter hued. In neither sex, however, is the change so great as it is in *Salmo Salar*. The body color becomes yellow or reddish, the white dirty, and the spots turn to rusty purplish brown. The hooked lower jaw, loss of condition, poor quality of flesh, indisposition to feed, and sluggishness of temperament, that characterize the spawning Salmon, are well marked in the Wananishe.

The qualities of the Wananishe as a game fish will interest brother anglers more than his scientific relationship and peculiarities. After a long and varied acquaintance with Salmon and Trout in Canadian waters, from Prince Edward Island and Nova Scotia to the Pacific Slope, I say unhesitatingly that, though Wananishe-fishing has been absurdly exaggerated, it is unsurpassed either in charm of surroundings, its varied and exciting nature, the skill required, or the fighting powers of the fish itself. With a curious combination of the habits of both Salmon and Trout, he has ways of his own that require studying. As he lives in the strongest of water and has an omnivorous appetite, his fins and tail are greatly developed, so that by constant training he is an athlete even among the *Salmonidae*. A two-pounder will fight like a Grilse, and a four or five pounder, fresh run, gives as much sport as a ten-pound Salmon.

Although at most times, especially when they are lying in

large shoals in the eddies on the border of the main current of the great rapids of the Grande Decharge, Wananishe take the fly readily, they are as wary and capricious as any other of the genus, and as much affected by change of weather or character and amount of food.

In the early season, whether fishing from shore or from the canoe, the flies and the methods of casting and working them used in Salmon-fishing are the most successful, allowance being made for the peculiarity in feeding hereafter to be noticed. As a rule, small-sized Salmon flies are the best, say No. 4 and No. 6 O'Shaughnessy sizes on single hooks; but at high water, and even at other times, a large fly is often successful. The Jock Scott, Curtis or Black Dose, Black Fair, Popham, Silver Doctor, and Donkey are all good. The first-named is almost infallible; indeed, I sometimes think that with variations in size one needs no other fly for Salmon, Wananishe, and really large Trout like those of the Laurentian wilds of the Nepigon, and the sea Trout of some Canadian rivers, except a large brown hackle for the Trout, and this; not to be scorned as a Salmon fly, when the charms of golden pheasant crest and jungle-cock fail, though, oddly enough, it is not much good for Wananishe. Red is not a favorite color with them; yellow and black is the best combination, and gray with a yellowish body comes next. Among the larger Trout flies, Queen of the Water, the Professor, and the Grizzly King usually do good work.

Later in the season, when the fish are lying singly in deep water along the rocks, or in small pools among the rapids, all one's skill is required to entice them. If you understand the finery of dry fly-fishing, and can maneuver a tiny dun on a twelve or thirteen hook so as to look like the real article, you can also handle large fish on the fine tackle required, you will get good sport and the satisfaction which comes of catching fish as Reynolds mixed his colors—with brains. If not, you will have to fall back on live grasshoppers and

thickly spread on a white ground. Adults are all marked on the body with black spots, either irregular quadrilaterals or double X's, not the single X of the Atlantic Salmon. These spots do not come much below the medial line, and vary a great deal in number and size in individuals. They do not show on the gill covers, tail or dorsal fin, but the latter is usually thickly covered with circular black spots.

The coloring varies somewhat with locality, age, and season, but there is no marked difference of it in the sexes, except at breeding-time, when the male, as in other *Salmonidæ*, is much the brighter hued. In neither sex, however, is the change so great as it is in *Salmo Salar*. The body color becomes yellow or reddish, the white dirty, and the spots turn to rusty purplish brown. The hooked lower jaw, loss of condition, poor quality of flesh, indisposition to feed, and sluggishness of temperament, that characterize the spawning Salmon, are well marked in the Wananishe.

The qualities of the Wananishe as a game fish will interest brother anglers more than his scientific relationship and peculiarities. After a long and varied acquaintance with Salmon and Trout in Canadian waters, from Prince Edward Island and Nova Scotia to the Pacific Slope, I say unhesitatingly that, though Wananishe-fishing has been absurdly exaggerated, it is unsurpassed either in charm of surroundings, its varied and exciting nature, the skill required, or the fighting powers of the fish itself. With a curious combination of the habits of both Salmon and Trout, he has ways of his own that require studying. As he lives in the strongest of water and has an omniverous appetite, his fins and tail are greatly developed, so that by constant training he is an athlete even among the *Salmonidæ*. A two-pounder will fight like a Grilse, and a four or five pounder, fresh run, gives as much sport as a ten-pound Salmon.

Although at most times, especially when they are lying in

large schools in the eddies on the border of the main current of the great rapids of the Grande Decharge, Wananishe take the fly readily, they are as wary and capricious as any other of their genus, and as much affected by change of weather or character and amount of food.

In the early season, whether fishing from shore or from the canoe, the flies and the methods of casting and working them used in Salmon-fishing are the most successful, allowance being made for the peculiarity in feeding hereafter to be noticed. As a rule, small-sized Salmon flies are the best, say No. 4 and No. 6 O'Shaughnessy sizes on single hooks; but at high water, and even at other times, a large fly is often successful. The Jock Scott, Curtis or Black Dose, Black Fairy, Popham, Silver Doctor, and Donkey are all good. The first-named is almost infallible; indeed, I sometimes think that with variations in size one needs no other fly for Salmon, Wananishe, and really large Trout like those of the Laurentian wilds of the Nepigon, and the sea Trout of some Canadian rivers, except a large brown hackle for the Trout, and this is not to be scorned as a Salmon fly, when the charms of golden pheasant crest and jungle-cock fail, though, oddly enough, it is not much good for Wananishe. Red is not a favorite color with them; yellow and black is the best combination, and gray with a yellowish body comes next. Among the larger Trout flies, Queen of the Water, the Professor, and the Grizzly King usually do good work.

Later in the season, when the fish are lying singly in deep water along the rocks, or in small pools among the rapids, all one's skill is required to entice them. If you understand the fine art of dry fly-fishing, and can maneuver a tiny dun on a twelve or thirteen hook so as to look like the real article, and can also handle large fish on the fine tackle required, you will get good sport and the satisfaction which comes of catching fish as Reynold's mixed his colors—with brains. If not, you will have to fall back on live grasshoppers and

have seen a Wananishe rise from the bottom like a flash and take the fly before I could pull it away. Periodically during the day they move round the pools, going from one to another along the current lines and circling round all the eddies in each, to feed on the flies and other insects that are thick in the broad patches of foam which swirl along in the currents, and sometimes chasing schools of small fish. The number of flies that a Wananishe will thus collect in the course of a day is almost incredible. I have repeatedly seen nearly half a pint of them in the stomach and intestines of a four-pound fish.

The porpoise-like roll of the fish when thus on the tour is peculiar and characteristic; while their dorsal fins and broad tails, appearing and disappearing with clock-like regularity, make their presence visible at once. It requires a good deal of practice to determine the direction of their movements, still more to time and place the cast properly. All the while the canoe is moving also—perhaps just between the up and down current on the verge of a big rapid.

As the water gets lower, the largest fish move out to and lie in places to fish which it is necessary to depend on the nerve and skill of your canoe-men, and their quick judgment of the set of the varying currents, to keep the canoe there by the use of the paddles only. Very often this is the simplest part of the business, and the return journey means running along rapids or making a tough portage along the face of the rocks. The novice, or a person unaccustomed to the small bark canoes necessarily used in that region, should not attempt this sort of fishing; but it is to other angling what the pursuit of large game is to ordinary shooting. I am speaking here of parts of the Grande Decharge which the average tourist never sees, and is not likely to venture into if he does see them. Though lacking the element of danger, the ordinary fishing in the large *remous*—as the big eddies or pools are called, in the French patois of the region—will prove exciting enough.

A pleasant variety will be found in a clamber over the rocks along the rapids, at times high up above the water, and dropping the fly into some snug little corner where the constantly recurring tail in a circular patch of foam shows a Wananishe "at home;" at others standing on a ledge over which the waves roll knee-deep and break on the rocks with a roar like the surf on the sea-shore, which drowns your attendant's voice and reduces him to pantomimic expression of the size or number of the fish rising far out in some caldron-like whirl, where the down and up rush of the waters meet, while you do your best by the Spey or switch-cast to get the fly to them without smashing it on the rocks behind. The high-tossed spray from the crests of the waves, the seething whirlpools and the play of light and color on the ever-changing forms of water, on the varied foliage, and on the purple rocks, make a beautiful scene, to which the turmoil of the rapids adds its musical charm.

If you did not see them with your own eyes you would believe it impossible for any fish to remain in such a fury of water, far less to feed there; but hook one, and then see how much at his ease he is, and how he will stem the full rush of the Grande Chute, dragging thirty or forty yards of line after him.

It was while watching a Wananishe hooked at the head of Isle Maligne, round which the fiercest rapids in the Grande Decharge sweep, that I first fully realized their great strength and greater pluck. Standing thirty feet above the water, I could see him plainly in the clear, deep stretches between the white-crested rollers; and a beautiful sight it was to watch him mount a series of inclines with straight steps of three to four feet at the top of each, and then, after resting a while on the summit of the fall, dart off like a flash into the full strength of the down-current on the other side of the point, only to be steered into a little cove at the end of his run, and there fight till, all strength gone, he lay exhausted on the surface.

Then again, when eye and ear are weary of the incessant roar and flash of the rapids, there is a restful change in the picturesque stretches filled with islands, where you may or may not, according to luck and the state of the water, get some pretty fishing, either in the calm, smooth water out in the middle or along the channels between the islands, which will remind you of pleasant days spent on some favorite Trout lake, or wandering along the banks of a sequestered stream.

The worst of these broad expanses is that they are great breeding-places for Pike (*Esox Lucius*, Jordan & Gilbert), better known, but incorrectly, in the United States, as Pickerel. Though handsome enough in their own coarse way to be a good game fish in their proper place, they destroy the Wananishe terribly. They lurk in the still water of the bays into which the Wananishe wander in search of food, and even get out into quiet holes in the rapids. Many of the larger Wananishe bear marks of having slipped through these pirates' teeth.

I once saw a five and one-half pound fish swimming about in an odd and helpless manner, and found that his spine had been broken by a Pike so that he could not use his tail. In 1887 I was fishing off the rocks at the Grande Chute, and hooked a Wananishe which proved to weigh just less than a pound. Not particularly caring about such a small fish, I let him wander off while waiting for my canoe-man to bring the landing-net. On reeling in, the weight seemed to have increased in an extraordinary manner. I at first thought the fish had fouled something; but a rush like a Salmon's changed that idea into great curiosity. After an anxious twenty-five minutes, for the fish several times tried to bolt into the main current, and there were some awkward rock ledges close in, he turned out to be a Pike, and a good-sized one. Once within reach he was easily netted, and was found to weigh ten and one-half pounds. The Wananishe was in his gullet, but the hook had slipped out of the Wananishe's mouth and caught in the socket



of the Pike's eye inside. I have always wondered why the leader was not cut by his teeth, but suppose it got between them. These Pike run to great size in Lake St. John, and up the Peribonca.

The "Wall-eyed Pike" (*Lucioperca Americana*, Gunther; *Stizostedion Vitreum*, Jordan & Gilbert), called in Canada *Dore*, from his golden yellow sides, is also rather too abundant in these waters. Though the lakes in the Saguenay region and the upper parts of the rivers tributary to Lake St. John and the Saguenay abound with Trout, there are none in Lake St. John itself, nor in the lower portions of its tributaries and the Grande Decharge. In the latter there seems to be too much water for them in the rocky parts of the river, and in the calm reaches the bottom and banks are too clayey. Another reason for their absence is probably the high summer temperature of the water in Lake St. John, which is simply a vast evaporating-pan, being comparatively shallow in proportion to its area of about six hundred square miles, and with a bottom of sand and silt washed down by the dozen rivers, three of them very large and over two hundred miles long, which discharge into it.

That a true Salmon like the Wananishe inhabits such water, is another instance of its curious variation in habits, and a proof of adaptation to changed conditions. This is a subject which I should have liked to discuss here, especially in view of the growing idea I have, which is confirmed to some extent by the results of the accurate and instructive experiments in artificial breeding by Sir James Maitland, at the Howietoun establishment in Scotland, by the results at the Canadian Government's fish hatchery at Tadoussac, and by observation of Salmon rivers, that the Salmon may not be necessarily an anadromous fish, but is only so from choice, just as the Trout of Long Island and many other places are, and that, under certain circumstances of difficulty of descent, combined with abundance of food in large bodies of fresh water, it—

at all events its offspring—may prefer to remain in fresh water, the change in habits and in appearance taking place much more quickly than has hitherto been supposed, and the dwarfing in size not taking more than a generation or two.

The variation in the size of Trout bred, under different conditions, from the same batch of ova, and the well-known difference in the size of Salmon in different rivers, are other arguments for this view, which would dispose of the "land-locking" theory, already shown above as being quite contrary to the facts. This subject would, however, require a paper to itself. I will only add that Sir James Maitland has found that Salmon bred in lakes and not able to go to the sea, if there were no charr for them to feed upon, seldom exceeded four or five pounds in weight, and that Quinnot Salmon, from the Pacific Coast, bred by Mr. Samuel Wilmot at the Canadian hatcheries, when confined all their lives to the narrow limits of the breeding-tanks, have become mature Salmon and reproduced their species, though not attaining a greater length than eight or nine inches, while others more favorably situated have reached the ordinary size.

Any one who wants to study the Land-locked Salmon of Lake St. John and the Saguenay will have to hasten, for the opening of the region to fish-markets and to tourists, by a railway, threatens their speedy extinction, to which the careless greed of settlers and the apathy of the government of the Province of Quebec are contributing greatly. Already it is hard to get a day's sport in water which formerly teemed with them. From what I have said of their habits, it will be easily understood that the so-called "pools" were always very few in proportion to the actual extent of water in the forty miles length of the Grande Decharge. One consolation in this is, that, as all the best water is private property, it can be and is guarded carefully. But this does not preserve the spawning-grounds.

Only ten years ago there was no limit to the number of fish

one might get in a day. I have seen forty to fifty taken by a single rod. Nowadays it is rather amusing to see enthusiastic American anglers publish a score of ten or twelve as something surprising. The average size has also decreased notably, which shows that anglers are catching younger fish. In the times I speak of, four and five pounders were common enough, but now they are scarce in the best waters.

In 1883, twenty days' fishing gave a score of three hundred and seventeen fish to one rod; or, deducting Sundays, nineteen a day; and this was not fishing all day, by any means. Let me hasten to say that there was no desire to make a record; that there were some very small day's catches, owing to the enormous number of flies on the water, which gorged the fish; that a good deal of time was spent in work and loafing; and that all but the few needed for food were liberated either at once or after a few days' detention for observation in a pretty fish pond engineered among the rocks.

On one of these days fifty-three fish were taken by another angler in the same pools at the Grande Chute. The highest score I have ever made was forty-two, and I only mention it to put on record the abundance of fish then existing. But the solitude and the charm have now gone forever from the Upper Saguenay, together with the possibilities of those times.

I think I have said enough about the nature and ways of these little Salmon. Let me try to describe a typical but a real day's sport with them, and I hope you may, my reader, have just such an one with as good a companion and as true an angler as I had that June day in 1888, in our Saguenay Club waters.

We start with a "*Bonne chance, Messieurs,*" from the guardian's pretty wife, a black-eyed, olive-complexioned girl of sixteen.

Two of the canoe-men, putting their canoes on their heads almost as easily as their hats, have gone on; their mates wait

for the rods and traps. A fine quartet they are—French Canadians all, of the voyageur type, with all the skill of the Indian in wood-craft, and ten times his courage; brown and strong from trapping and lumbering all their lives, grave and serious-looking, but with a keen vein of humor; shrewd and hard-bargaining, but thoroughly honest; unable perhaps to write their names, but with a genuine polish of manner which compels respect by its dignified deference. One can make companions and friends of such men as these. Their costume is simple enough: home-made trousers of the home-woven gray woolen *ctoffe du pays*, tucked in the wrinkled legs of the long moccasins tied below the knee, which, in contradistinction from town-made *bottes francaises*, are known as *bottes sauvages*; a flannel shirt with a gay kerchief in a broad fold over the chest; a soft felt hat of Protean shapes and uses, with a cherished fly or two stuck in the crown—perhaps, if *la blonde* is near her *cavalier*, a feather or wild-flower in the band.

The volume of the rapids, the swiftness, complexity, and heavy swirls of the currents, make canoeing most exciting, and at times a little dangerous, on these waters. They are too deep for the use of setting-poles, and everything depends on strength and skill with the paddle. Mounting the Grande Decharge, when it is fifteen feet above summer level and running like a mill-race, is hard work, but, taking advantage of every eddy, gripping rocks with hand and paddle, handing along by the tops of the submerged alders, passing between branches of overhanging trees undermined by the current, by sheer dint of hard paddling we got up a mile and a half. Now for the *traverse*. The canoe sweeps down and across in a beautiful curve, head up-stream and the paddles flashing like lightning, except when a *tournoquet* catches her and spins her half round a circle, while Joseph, with a sidelong sweep, decapitates a wave which threatens to lop over the gunwale. "*Un animal d'un tournoquet*," he says, pointing



ISLE MALIQUE.



to the funnel-shaped whirl swiftly gyrating down-stream, the air-bubbles hissing through the yellow water like the bead in a glass of champagne. We are nearly half a mile down when the canoe swings, with a sharp shock, into the up-eddy on the opposite shore.

"*C'est la place de peche, Monsieur,*" says Narcisse, easing off the grip of his teeth on his pipe; and Joseph, having finished drinking out of the rim of his hat, remarks that "*on a coutume de prendre des grosses ici.*" Wananishe, like Trout, are of the fair sex in French, and are roughly classified into *petites, belles, and grosses.*

This is the famous *Remou de Caron*, or Caron's Eddy. The big white waves surging round the rocky island, which later on will become a point covered with bushes, are the tail of the Caron Rapid, a crooked and dangerous one, because of the height of its waves and the size of its *tournequets* or whirlpools, which suck down saw-logs as if they were chips, casting them up a couple of hundred yards farther down, to be caught in the eddies and swept again and again through the wild rush of water, until the ever-changing set of the current tosses them on the rocks or carries them off down-stream.

Pool, in the angler's usual understanding of the term, there is none; for the deep river, over a quarter of a mile wide, is totally unlike a Salmon or Trout stream. At first he is rather bewildered by the interlacing currents running in every direction, bearing along streaks of froth which gather in patches as dazzling as snow, that revolve slowly for a minute or two, then, suddenly dissolving, go dancing in long white lines over the short ripples.

"*Ca saute, Monsieur.*" No splash marks the rise, but a broad tail appears and disappears where a Wananishe is busy picking flies out of the foam; then another, and another still. They are making the tour round the whole system of minor eddies and currents, sometimes staying a minute in some large patch of froth where the flies are thick, sometimes swimming and

rising rapidly in a straight current line, and finally going out, on the tops of the long glassy rollers at the tail of the main eddy, into the white water of the main current, which carries them back again to the other end of the *remou*.

A patch of *brouc* comes swirling along with a fish in it. It requires a quick hand to put the fly where it will do the most good. To a novice it is much like fishing "on the wing," but practice shows where to expect the fish. The rod swings and out goes the fly, which is allowed to sink a few inches and is then drawn in with a succession of slow and short jerks, not trailed on the surface. The fish, however, is now five yards farther away, and on the other side of the canoe. This constant change in length and direction of cast is one of the main difficulties, as it is one of the excitements of Wananishe-angling.

But here come three together—"un beau gang," to use Joseph's anglicism. The fly falls at the end of a straight line; a momentary thrill follows a gentle pull; you strike with the orthodox turn of the wrist, and then blank reaction; the drift of the canoe or the inseting current has slackened the line, and the fish has been missed. "*C'est dommage, Monsieur, vous l'avez piqué.*" The fish evidently is piqued, in every sense of the term, and will have no more of your flies. Another such experience will make him a marked misanthropé all summer. When you strike, if you strike at all, it must be hard, for their mouths are hard; but, as in Salmon-fishing, no rule can be laid down beyond the golden one to keep a taut line. Though no fish are visible, you cast right and left. Presently, while quietly reeling in an excess of line, down goes the rod-tip with a smart jerk; there is a terribly long pause of about half a second, then the reel sings, and thirty yards away a silver bar flashes through the air three or four times in quick succession, for it is a fresh-run fish hooked in a tender spot. You recover a little line, then out it goes again with more pyrotechnics. At the end of ten or fifteen minutes he comes



THE LAND-LOCKED SALMON, OR WANANISHE.

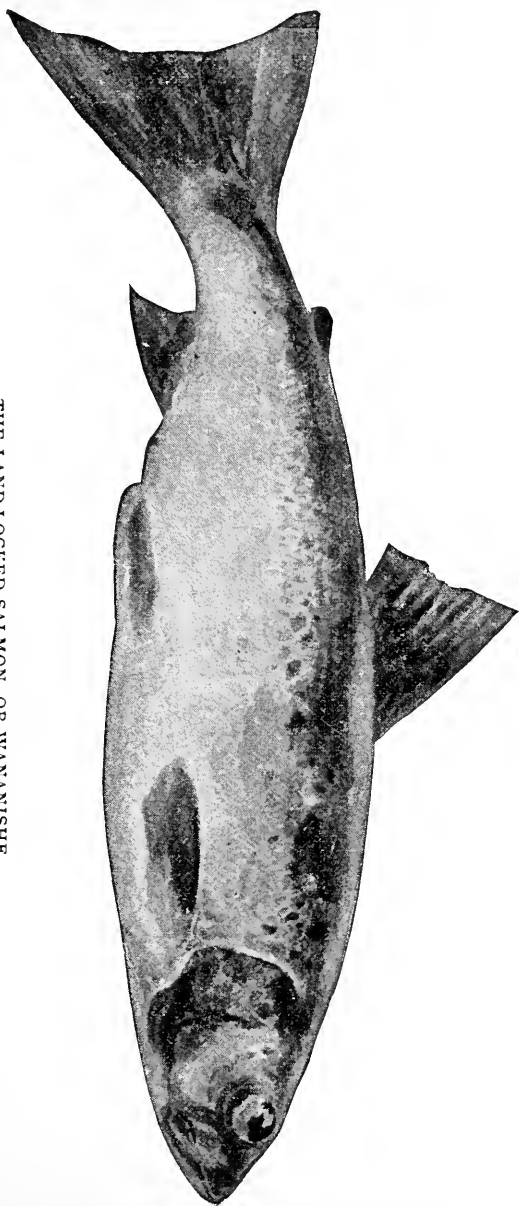

in meekly, with an occasional remonstrance, and you think it time for the net.

The leader shows above the water and the rod curves into a semicircle, but no strain you can put on raises the fish farther, which circles slowly around. A sudden dash under your feet drags the rod-tip under water, but is foiled by a quick turn of the canoe. Then a telegraphic circuit seems to have been established through your tired arms to your spine. The fish is standing on his head, worrying the fly like a bull-dog, and slapping at the leader with his tail. All at once the rod springs back and you are heavily splashed by a leap almost into your face. This occurs half a dozen times. He may jump into the canoe, perhaps over it; I have seen a Wananishe caught in the air in the landing-net after it had shaken the fly out of its mouth. He is far more likely, however, to smash rod and tackle, unless you lower the tip smartly.

Some more runs may follow, or a sulking fit. The more he is kept moving the sooner he will tire. It is well to keep him in hand with as heavy a strain as can be risked, for he fights to the last, and there is no knowing what he may do. Even when he comes to the surface and shows his white side, the sight of the landing-net nerves him to what the pugilists call a "game finish." Three-quarters of an hour have gone, when Narcisse slips the net under him with a quick but sure scoop, and kills him with a blow from the paddle. "*C'est sericusement grosse,*" he says, as he holds up a twenty-five-inch fish. Really the balance does seem wrong when it marks only five pounds.

After a couple of hours cruising about the eddy with more or less luck, we portage over the point, making our way with some difficulty through the tangle of rocks and trees, though the men, canoe on head and both hands full, skip along easily enough. There we find a little family party of Wananishe close under the bank, in a hole beneath some alder roots, which would exactly suit a Trout's idea of home. Farther up we get

some pretty casting from a steep, rocky beach past which a strong eddy runs. Later on, when the water has fallen and new eddies form immediately above the point, there will be good fishing, either off the rocks or in the canoe, which the men will hold in the very dividing-line between the main current over the fall and that which sets in-shore.

At luncheon, in a shady nook, a Wananishe *a la broche* gives us a chance to test the men's cookery. The fish, split down the back and opened out like a kite, is skewered with slips of red willow, well salted and peppered, inserted in a cleft stick fastened with spruce-root or a withe of alder, and then, stuck in the ground before a clear fire of drift-wood, is broiled without any basting but its own fat. If you prefer the flavor, you may skewer a piece of bacon to the upper part of the fish. The delicate pink flesh is intermediate in flavor between that of the Salmon and that of the Trout—richer than the latter, less cloying than the former. Planked Shad is not better. After luncheon the pipe and a chat, with a *boucane* to keep the flies off. The logs chafing and grinding against the shore suggest to the men some reminiscences of *la drive* and its perils. The artist gets a sketch for which William poses. For another mile above, the rapid foams white. That hill, covered with dark spruces, which divides it, is the point of Isle Maligne—well named, for, surrounded by heavy rapids pulsating in chutes through rocky gorges, it is rarely accessible, sometimes not for several successive years, and only one angler has ever cast a fly from its shores.

In the evening we fly down in ten minutes what it took us over an hour to mount. The roar of the Vache Cialle Rapid swells like the sound of an approaching train. The bowman stands up to look, says a word to his mate, then both settle low on their heels, and two bits of rapid are run like a flash, though the trees slipping past are the only sign of motion the passenger feels. With the current setting out straight over the fall, it is an ugly-looking place, but "*a terre, en masse,*"

and a bit of quick paddling brings the shore close. The men interchange a rapid glance.

*"Au large?"*

*"Pas trop."*

The canoe turns out from shore again, to the horror of any passenger making the run for the first time, but, before he can remonstrate, tilts over the pitch where a pyramidal rock backs up the water, swings end for end, and sidles into an eddy just its own length, which has scooped out a hollow in the bank within forty yards of the fall.

"It is quite possible to drown one's self here," remarks Pitre, as he takes his Monsieur's rod and coat for the walk home. It is a point of honor, however, with these men, never to risk a passenger's comfort, much less his safety. Any recklessness or bungling would meet sharp criticism over the camp-fire. They are cool and courageous in real danger, however, and among themselves the rivalry is keen. Nothing delights them more than to have a Monsieur who can appreciate their points, and, not minding a few bucketfuls of water, gives them once in a while a chance of display. After all, the passenger has the best of guarantees in the fact that very few of them can swim. I speak only of the professional canoe-men of the Decharge. Some of the Indians from Pointe Bleue, on Lake St. John, are good enough in the canoe; but since the railway has brought tourists along, many men seek employment who have no experience either in such waters or of the niceties of the fishing.

## THE TARPON, OR SILVER KING.

---

BY W. N. HALDEMAN.

---

THE Tarpon has been technically described as *Megalops Atlanticus* and *Megalops Thrissoides*, the latter being used in the excellent compilation known as "The Fisheries and Fishery Industries of the United States," issued by the United States Fish Commission. The Tarpon is therein called Tarpum, and classed under "families related to the *Clupeidae*." In this connection, it may be stated that comparatively little is known of the habits of the Tarpon. A search through the Encyclopedia Britannica, or other authorities, will make this fact patent. The authority above quoted is the best with which I am acquainted. It says: "An immense, herring-like fish, which occurs in the Western Atlantic and in the Gulf of Mexico, ranging north to Cape Cod and south at least to Western Brazil. It is somewhat abundant in the West Indies, and stragglers have been taken as far to the eastward as the Bermudas. The sailors' name for this fish, by which name it is also known at Key West, Bermuda, Brunswick, Georgia, and elsewhere, is "Tarpum," or "Tarpon." It is the "Silver Fish" of Pensacola, the "Grand Ecaille" (large scale fish), or "Grandykye," as it is pronounced and sometimes spelled, and the "Savanilla" of Texas.

Mr. Stearns contributes the following notes upon the fish as observed by him: "The Silver Fish, or Grande Ecaille, is common everywhere on the gulf coast. It is an immense and active fish, preying eagerly upon schools of young fry, or

any small fish that it is able to receive into its mouth, and in pursuit of which it ascends fresh-water rivers quite a long distance. During September, 1879, I saw large numbers of Silver Fish eight or ten miles up the Apalachicola River, and am told that that was not an unusual occurrence. They go up the Homosassa River in Florida, and several of the Texas rivers, so I have subsequently learned. The Tarpum will take a baited hook, but it is difficult to handle and is seldom landed. The Pensacola seine-fishermen dread it while dragging their seines, for they have known of persons having been killed or severely injured by its leaping against them from the seine in which it was inclosed. Even when it does not jump over the cork-line of a seine, it is quite likely to break through the netting before being landed. I have secured several specimens, the smallest of which weighed thirty pounds, and the largest about seventy-five pounds."

Since the publication of "The Fisheries and Fishery Industries of the United States," in 1884, much valuable literature in connection with the Tarpon has been furnished the periodical press of the country. Yet the ichthyology of the Tarpon is far from complete, and there remain many facts relative to his habits, habitat, etc., to be, and which it is hoped will be, in time, unfolded.

I consider Tarpon-fishing the grandest sport with the rod and reel to be had upon the globe; and the study, therefore, of the ways and peculiarities of the fish is an absorbing one. After taking a Tarpon on light tackle, other forms of angling become tame sport. His magnificent vaults into mid-air, wonderful spurts, and powerful dashes for liberty, allied to his remarkable beauty, quickly converts the tyro in this form of angling into an enthusiast. His weight varies, according to my observations, between fifteen or twenty pounds and one hundred and seventy-five, and in length they reach as much as seven feet and over. Their build indicates great power, and a generous and dainty fare. In shape they are very sym-

metrical; and in a large and powerful tail, and numerous fins of ample size and sweep, they possess most formidable weapons in a contest for liberty. They are covered with brilliant scales, whose exposed portions are almost one-fourth of the whole. When detached, the part of the scale which gives the fish its beautiful luster looks as though it had been dipped in molten silver. It is this remarkable brilliance which has won the

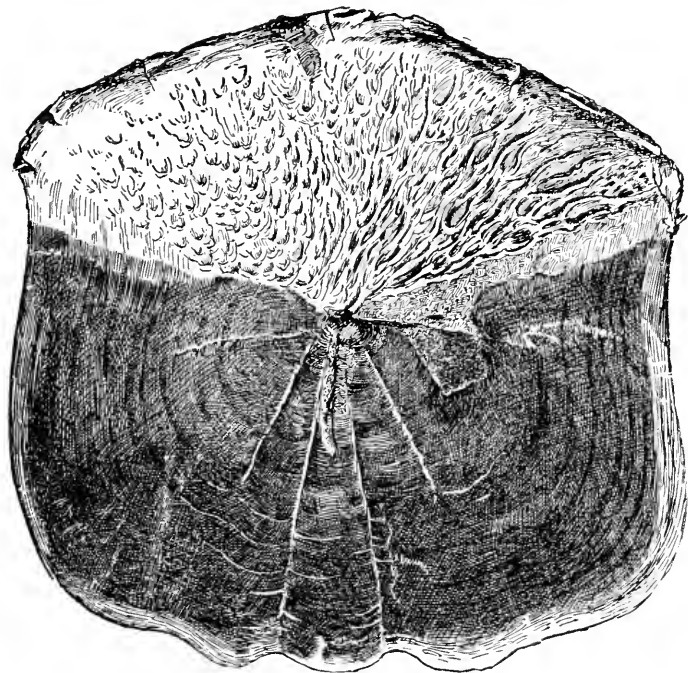

SCALE OF TARPON, ACTUAL SIZE.

Tarpon its designation of the "Silver King." The bronze and golden tints on the sides of the fish, noticeable only a few hours after being landed, add much to his beauty.

While the Tarpon may range in the latitude stated above, so far the sportsmen who have gone in pursuit of him with rod and reel have confined their efforts almost exclusively to

the waters of the southwestern gulf coast of Florida. There he is found in comparative abundance; and that coast is generally looked upon and conceded to be his annual feeding-grounds. To Mr. W. A. Wood, of New York City, is generally credited the taking of the first Tarpon of over one hundred pounds weight, with rod and reel. The capture took place in these waters, and occurred in March, 1885. The friends of Mr. Samuel H. Jones, of Philadelphia, however, claim for him priority, placing the first catch with the rod in Indian River Inlet, on the east coast of Florida, during the winter of 1880 and 1881. To whomsoever the honor belongs, the dates quoted will demonstrate how young the sport is. Yet these gentlemen have had numerous emulators; and each year the number of Tarpon taken is on the increase. Every season the ranks of the Tarpon enthusiasts are augmented, and the resorts of the South Florida coast grow correspondingly more popular.

A number of well-known Tarpon fishermen are steam-yacht owners, and these take in the entire coast, being pretty sure to find good sport at almost any of the numerous bays and inlets between the mouth of the Caloosahatchie and Cape Sable. San Carlos Bay, Estero Bay, the Bay of Naples, Marco, Caxambas, and Chokoliska Inlets are all known to be points where the Tarpon abounds. The colder the water, and the more severe the winter, the further south the best fishing is to be found; for the Tarpon is, without doubt, very sensitive to cold. The gentleman who has been in charge of the United States Coast Survey on the Florida coast for ten or fifteen years, told me that after the cold snap during the winter of 1886, which created such devastation throughout Florida, he saw hundreds of dead Tarpon washed upon the beach below Punta Rassa, where he was located at the time. During the past winter the weather has been mild, and Tarpon have been caught in goodly numbers farther north than is customary.



Some three or four years ago, owing to the severe and annoying colds which the great and sudden variations in temperature of our Kentucky winters subjected me to, I found it desirable to seek a more equable climate for several, at least, of the more disagreeable months of the cold season. I was attracted to the south gulf coast of Florida by the glowing descriptions given me by friends, of its balmy atmosphere and the splendid sport which awaited the angler there. Investigation showed that the reports I had received had not at all partaken of the extravagant. Charmed with the equableness of the climate, the superb fishing, and the winter surf-bathing, with its re-invigorating results, I constructed a snug winter home at Naples-on-the-Gulf, which, with my family, I have greatly enjoyed during the past two winters. Others, likewise delighted with the locality, the wonderful climate, and the sport, have built cottages there; a hotel has been erected, and Naples gives promise of becoming a popular winter resort. From Jacksonville the little village upon the open gulf is reached via the Jacksonville, Tampa & Key West, and Florida Southern Railroads, which convey you as far south as Punta Gorda, on Charlotte Harbor. From there it is a trip of ninety miles by steamer to Naples-on-the-Gulf, sixty of these down the harbor and Carlos Bay, and thirty out in the open gulf. A railroad to Naples, which is to be built in the near future, will bring it within two hours of Punta Gorda.

Naples is one hundred and twenty-five miles south of Tampa, and is about on the parallel of latitude which extends through Matamoras, on the Mexican side of the gulf, and through the Bahama group, to the southeast of Florida. The vegetation is tropical; and the seasons, in contradistinction to our own, are divided into "wet" and "dry." The latter corresponds to our winter, and the former to our summer. During the past winter (1890) rain has not fallen on more than three or four occasions, and during my previous sojourns the rule has been beautiful days, full of health-giving sunshine,

with rain not oftener, on an average, than once a month, and a health and life giving breeze from the gulf that makes the atmosphere delightful beyond description. Here the Tarpon abounds—here is the angler's paradise.

Prior to my first trip to Naples-on-the-Gulf, my fishing experiences had been confined principally to angling for Black Bass in Lake Erie, with an occasional visit to the rivers of Northern Michigan and Wisconsin in quest of Brook Trout. I had heard of the Tarpon, but had little conception of the real character of the sport afforded by the salt waters of South-western Florida. Many anglers have, as I had, the idea that the average fish of southern waters is sluggish in temperament and lacking in the spirit and fighting qualities which have made famous his kindred in the cooler waters of the North. This is, however, an error of large dimensions. The Tarpon is beyond all doubt the king—aye, the "Silver King"—of game fishes, as the lion is the king of beasts; and the smaller varieties of fish, with which the bays and inlets of Florida abound, furnish as lively sport for the devotee of rod and reel as can be had in the wide world. For one who does not care to battle with big fish, the combative Cavalli, Spanish Mackerel, Grouper, Kingfish, Mangrove Snapper, Jackfish, Pompano, Redfish, Sea Trout, Sea Bass, etc., furnish abundant sport of the highest order.

At Punta Gorda, at the head of Charlotte Harbor and at the mouth of Peace River, a locality up to this season never frequented by Tarpon fishermen, the sport is reported to have been excellent. Passing there on my return home, I saw half a dozen fine specimens which had been caught there, and mounted by Mr. Thomas Hartigan, a skillful taxidermist of that place. Thus it would seem that the Tarpon is whimsical in the choice of feeding-grounds, especially so far as concerns the northern places where he is caught. Natives of the gulf coast south of Naples have frequently told me that they had never been to the inlets of Caxambas and Chokoliska without

seeing Tarpon in large numbers. At Naples I have found Tarpon each season in great numbers, though there have been, apparently, fewer this season than in previous years. This I attribute to the unusually dry weather in the fall of 1889. As a rule the waters of the Bay of Naples and its tributary, Gordon's River, are brackish, but the drouth left them this season almost as salty as the gulf, and the Tarpon were later in making their appearance.

The Tarpon seek this brackish water for sport and food; and it is probably due to this fact that they were running as far north as the mouth of Peace River so early in the season this year. I have frequently noticed, in the early winter months, large numbers of Tarpon of all sizes sporting in the water at the mouth of Gordon's River, when they could not be tempted to take the hook. Mullet, at this season, are much more abundant than later, and this may explain their tardiness in taking the bait. At all events, as the season advances they bite more frequently, and in April I have had the best fishing. May and June, I am told, are even better months, the fish running in large numbers and becoming ravenous. By mid-summer the natives say the Tarpon becomes lean, losing much of his firm flesh and hearty appearance of the early winter. At this time, too, they are said to fight with less spirit, and are comparatively easily handled. As I have never fished later than April, however, I cannot vouch for these statements. Undoubtedly the spring is the superior season, though by far the majority of Tarpon anglers choose their outing when they may escape the rigors of a northern winter. This necessitates more time, and generally much tedious waiting, to secure the prize; but the delights and pleasures of a wonderful climate may be regarded as ample compensation.

The time necessary may be inferred from a statement I saw published in *Forest and Stream*, to the effect that up to the latter part of April, 1889, the total catch at one of the principal fishing-points on the Florida gulf coast was only

forty-two; and this with a score or more fishermen hard at it during the major portion of the season, commencing in January. At this same point, during the past season, I believe something in the neighborhood of seventy or eighty have been captured. Many sportsmen, loth to bestow so much of their time in quest of one variety, content themselves with an annual fish, devoting the rest of their spare moments to the smaller varieties.

As to the best tackle for Tarpon-fishing, were all that has been discussed—oftentimes in such heated debate—chronicled, it would fill tomes. I have used, in all of my fishing, a strong, pliable, split-bamboo rod, eight feet in length. With this I have taken Tarpon weighing from one hundred and five to one hundred and forty-four pounds, and it has served the purpose admirably. It is a one-jointed rod, with the single joint near the butt. Many anglers prefer a short, stiff rod, ranging from six and one-half to seven and one-half feet, claiming that with one of this description the casting of the heavy bait is easier. My reels are multiplying ones of the very best quality and of the finest workmanship, made to order for me by Mr. James Deally, of Louisville. They will easily hold six hundred feet of fifteen, eighteen, or twenty-one thread linen line. One has the customary click and check, with a leather drag attached to the cross-bar. This has proved serviceable, but I think the second from Mr. Deally's workshop an improvement. Upon the right side of this reel there are merely the click and handle. Upon the left, beneath the body of the reel, and extending out convenient to the thumb, is a drag, which may be pressed upon at the will of the angler, so as to produce a heavy or slight tension. During the first frantic struggles of the Tarpon, of course he must be allowed all the line possible, and it is my habit, at times during the conflict, to throw line out rapidly by seizing it between the reel and the first eyelet along the pole. A taut line is most to be feared in Tarpon-fishing.

I would say four out of five fish lost are traceable to this cause.

The line used varies from a fifteen to twenty-one linen thread. I use a fifteen-thread Cuttyhunk linen line, the fineness of which has inspired some of my friends, who pay very little attention to fishing, with serious doubts. I remember one young lady, who came in to inspect a mounted Tarpon in my office, remarked, with a great deal of *naivete*: "Well, Mr. Haldeman, I don't doubt you caught that fish; but really, you ought to change your line."

A most important and much debated portion of the Tarpon angler's outfit is the snood. A good snood is a safeguard against the scissor-like jaws of the Tarpon. The fish's teeth injure only by abrasion, but his jaws are massive and powerful enough to crush with ease the back of a hard-shell crab. Therefore, the snood should, obviously, be of a soft and pliable texture, rather than such as to offer any resistance. It should also be of ample length—at least three feet—for the Tarpon must be allowed to get the bait well into his gullet before he can be caught. When I began fishing, I used a snood made of piano-wire, and landed several Tarpon with it, which is contradictory to the statement of some authorities that the Tarpon will instantly detect the wire and spit it out. I abandoned its use for the reason that I found the cotton snood preferable and more economical, for where sharks capture so many of your hooks, the expense of wire snoods is by no means insignificant. For some time I have employed a treble braid of soft, yet strong, cotton line about the thickness of ordinary yarn. This cannot readily be frayed, and gives sufficiently to prevent being sawed or severed by the Tarpon's jaws. To prevent the fraying contingent upon playing a fish for an hour or two, some fishermen incase their snoods with rubber tubing. I am not aware how successful this has proved.

The other appurtenances to a complete outfit are plenty of

10.0 Limerick or O'Shaughnessy hooks and a gaff. I have used the O'Shaughnessy hooks, and I believe they are generally employed.

A gaff is considered indispensable. I regarded it so until the loss of a fine fish caused me to change my tactics. After a battle of over an hour, during which my finny opponent had gone through the usual process of sky-scraping, astonishing spurts beneath the water's surface and the like, I had succeeded in getting him under perfect control and was bringing him to the gaff. My boatman, as boatman so frequently do, became flurried and made his strike in too great haste. I was not prepared for the final move; and the stroke, coming unexpectedly, entangled my line and, much to my disgust, enabled the Tarpon, which must have weighed one hundred and fifty pounds, to get away. Since, I play my fish, as usual, until completely exhausted, when I bring him to the side of the boat, and make the boatman run his hand and arm up his gills, out through the Tarpon's capacious mouth, and lift him gently into the boat. My new method has proved efficacious in every instance in which I have tried it, and hereafter I will exhaust my fish thoroughly, and use the gaff only on urgent occasions. Many a victory has been won, only to be thrown away by the awkwardness and lack of skill of an excited boatman.

Mullet is the bait universally employed in fishing for Tarpon. Unquestionably, they prefer it to other small fish, though I have had them take small Catfish, and the variety termed "Virginia Mullet" by the coast fishermen. These latter are sometimes called "Rat-fish," the head resembling that of a rat. They seem to run with the Silver Mullet, and I have frequently seen them caught in the gill-nets with which schools of the latter were surrounded.

Some fishermen use an entire Mullet on their hooks, but more generally cut-bait is employed. There is much room for experiment in the matter of bait. I have heard experi-

enced boatmen, who have been engaged on the south gulf coast regularly for years, say that when hungry the Tarpon would bite at almost any kind of bait, provided it was fresh. One gentleman told me this past season that he had seen two Tarpon cut open, the stomachs of which were filled with hard-shell crabs. Another observer tells me he has seen Tarpon feeding, presumably, upon some sort of shrimp in a most peculiar manner. He says he has frequently observed them in shallow water, standing apparently on their heads. In reality, though, their mouths were buried in the sand extracting some kind of food. This odd position while feeding may be due to the peculiar location of the mouth. It is upon the upper side of the head. Some Tarpon anglers have expressed the belief that they take the bait in a similar manner.

In this connection it may be apropos to relate an incident which occurred below Naples last winter, and which will illustrate what the Tarpon will do when he is hungry, and at the same time shows his jumping proclivities. When the facts first reached my ears I scarcely credited them. Afterward they were substantiated by Doctor Green, a reputable gentleman and an excellent physician. Naples is situated on a narrow strip of land, washed on the west by the open gulf, and on the east by an inside passage which commences at the head of Gordon's River and widens into the Bay of Naples. This strip, which varies in width from one to two or three miles, extends twelve or fourteen miles, being broken at several points by inlets from the gulf. The Tarpon frequents the inside passage, which, being well protected from the storms and heavy winds of the gulf, always affords safe and accessible fishing-grounds. About eight miles down, last winter, on the mainland, there was an alligator-hunters' camp whose presiding genius was "Uncle" Charlie Cross. "Uncle" Charlie, it seems, was advanced in years, and looked after camp supplies, etc., rather than being engaged in the arduous and sometimes dangerous occupation of "'gatorin'." He

was in the habit of bringing his supplies from Marco in a small sailboat. One day in the latter part of last March "Uncle" Charlie was returning from Marco, after having disposed of a load of alligator-skins, and with the usual load of provisions on board. Fortunately, he happened to have a companion along. As "Uncle" Charlie turned from that part of Marco Inlet known as Collier's Bay, up into the inside passage in the direction of the camp, he steadied his boat before the wind and started to light his pipe. Placing his knee against the rudder he pulled a match from his vest-pocket and struck it on his coat. Holding his hands over the pipe to protect the blaze from the wind, he was in the midst of this interesting act when, suddenly, a Mullet leaped from the water to port, and darted clean across the stern of the boat, directly in front of him. He had not time to express his astonishment ere, in close pursuit of the Mullet, a large Tarpon rose, and came across the boat like a bolt from a catapult. The progress of the boat before the wind or the Tarpon's line of assault came near making a fatal difference to "Uncle" Charlie. The huge fish struck him full in the chest, and tumbled him like a log over the side of the boat. The shock of the collision threw the Tarpon into the bottom of the boat, and left "Uncle" Charlie struggling in the water. His companion brought the boat to, and pulled the injured man out in a sadly dilapidated condition. Doctor Green, who attended the injured man, says he was confined to his bed for three weeks, and doubts whether he will ever recover entirely from the effects of his wound. But for the assistance of his companion, "Uncle" Charlie would unquestionably have been drowned. The Tarpon, the doctor stated, weighed one hundred and sixty-four pounds.

To those who have never seen a Mullet and Tarpon jump, this incident may appear remarkable; yet, so far as the jumping is concerned, there is nothing whatever extraordinary about it. Every day, during certain seasons, in those waters



one can see the Bay Mullet making their customary three long skips, in any one of which they could easily clear a small boat. When chased by large fish, I have seen them make great leaps, darting out of the water with the rapidity of an arrow. Tarpon frequently leave the water while chasing Mullet, and when it comes to jumping, they are without an equal in the piscatorial world.

With the recital of a typical day's sport at Naples, I believe I will have told the reader about all that I know and that I consider worth relation in connection with this superb sport. I say "typical," but I mean that word only in a circumscribed sense. Possibly I should have said "typical good day's" sport; for many are the days when the Tarpon fisherman returns without anything to show for his efforts.

It was early in April, and the day was a bright and beautiful one. In company with my boatman, Ben, I started from the Hotel Naples at about nine o'clock in the morning. They do say that he who would catch a Tarpon must be up with the dawn; but, as I have almost invariably hooked my fish shortly before or after noon, I do not bother about an early start. The half-mile walk from the hotel back to the boat-house on the Bay of Naples is soon accomplished. The fishing-grounds are very accessible. A row of two miles up the bay, and we are at a favorite spot. The Bay of Naples is lined with Mangrove trees. These form a verdant border which blends happily with the dark waters, rendering the picture as lovely an one as human eye ever rested upon. Back of the Mangroves are the pine and hammock lands. Near our anchoring-point was a grove of tall palms, whose fans were rustling in the brisk southern breeze. Before casting anchor I drop my hook, baited with the tail-half of a Mullet, and direct Ben to row off twenty-five or thirty yards. The bait sinks to the bottom in five or six feet of water, near to the channel. Nothing to do now but await developments;

so, making myself as comfortable as possible, I picked up a newspaper and commenced reading. Hardly had I read half-way down the first column, when the noise of a large body emerging from the water opposite my boat attracted my attention. It was a Tarpon, weighing somewhere in the neighborhood of one hundred pounds. His rise, which was a straight, upward bolt, carrying his tail three or four feet clear of the water's surface, was the first intimation I had that anything was on my line. A superb spectacle he presented, as he glittered for a moment there in mid-air. With mouth wide open and gills expanded, he angrily shook his head to relieve himself from the hook, and his whole body appeared to be quaking with nervous force. Back he drops with a great splash, and up anchor and hurry with the oars is the order of the moment in the boat. Scarcely a moment does he remain below, when out again he comes in almost the same spot. This time his efforts to free himself are successful, for he ejects the baited hook with enough force to throw it ten or fifteen feet from him. Disappointed, but knowing it could not have been avoided, fresh bait is cast out, and we resume fishing only a few feet away from the locality first taken.

As a rule the click of the reel will give notice of the Tarpon's presence. In this instance, the fish must have taken the bait and advanced in the direction of my boat, thus preventing any warning. Some persons coil thirty or forty feet of line on the seat of the boat, after having made their cast, and watch closely for its disappearance. With a good, easy-running reel I consider this unnecessary.

It is a debatable question whether to "strike" a Tarpon after he has taken the bait. Many Tarpon experts are in the habit of doing so; many others do not. It is generally conceded by all that a Tarpon must be well hooked in the gullet before the chances are at all favorable for his capture. For this reason he is allowed to run with the line until it is supposed he has had time to swallow well the bait. When he

TARPON, OR GRANDE ÉCAILLE.—*Megalops Thrissoides.*

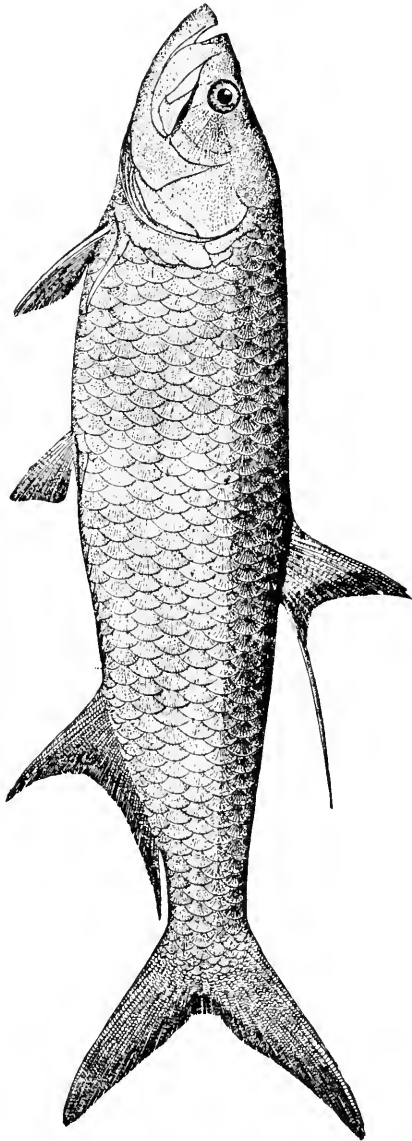

feels the hook he immediately comes to the surface. If he has not thoroughly swallowed the bait, he will eject it. If he does not swallow it, a strike will accomplish nothing, for the inside of the Tarpon's mouth is gristly and tough. It is only in rare instances that Tarpon have been caught when hooked in the mouth. Their tongue is hard, and its surface closely resembles a whetstone. It is long, being shaped like a calf's tongue, and with it they can eject, easily, anything within reach. This power with the tongue is one of the most astonishing characteristics of the Tarpon. When the bait is well swallowed, a "strike" is unnecessary, for the movements of the fish and the tension used when the fish is beneath the water will fasten the hook well in him. A "strike" would also prove disastrous if made, as it is likely to be, at the moment the Tarpon jumps from you.

Lunch-hour came and passed without incident, save the occasional replenishing of bait. The sun had crossed the meridian and started upon its western descent, and the flood-tide had reached the turn, ere Tarpon number two made his appearance. When I next reached for my pole, which I had rested upon the side of the boat, my attention being attracted by the whiz! whiz! of my reel, I took the precaution to look at my watch. It was just five minutes past one o'clock. My line ran out rapidly, but with that steady movement so characteristic of the Tarpon, and which so readily distinguishes him from a Shark, which runs like a frightened deer. Seventy-five—a hundred feet have disappeared! The excitement of the moment is pictured in the darky's eyes, whose whites appear to grow with the moments.

"Whe—w! he's a regulah whale," ejaculates Ben, as my Tarpon breaks through the water, disclosing his immense proportions in a mighty leap of ten feet aloft. Another! another! thrice more, and all in as many minutes, does Mr. Tarpon wend his way heavenward. A large fish he is, too, and a magnificent spectacle. In the meantime Ben has pulled in

the anchor and is at the oars, backing gently in the direction the Tarpon has taken. After his first outburst of rage and terrific endeavor to throw out the hook, the fish begins to take things a little more easily. With an occasional running, lengthwise jump, or skip, he makes up the bay, where the channel is narrower, and the proximity to the Mangroves dangerous. To head him off I directed Ben to row ahead of him to one side, meanwhile keeping the line taut, and reeling in as much as prudence permitted. This maneuver succeeded, and the Tarpon started back down stream, with a rush that carried out two hundred feet off my reel. I gave him as much of the weight of the boat as was discreet, throwing him line whenever he came out of water, which he did frequently. In this manner he towed us for a mile, to where the river widened out into a small bay. On the way I pass fellow-fishermen, who greet us with hurrahs, and such exclamations as "Ain't he a beauty!" "Don't he fight nobly!" "A hundred-and-sixty-pounder, at least!" etc., etc.

Every time I succeeded in getting him anywhere near the boat, he would make another spurt. Gradually these became feebler; and he finally took to circling round the little bay, all the time, however, some twenty or thirty feet distant from the boat. I kept him hard at work, never allowing him to get his second wind, and at last had the gratification of seeing him come to the top and turn upon his side, showing his complete state of exhaustion. It was plain sailing after that, and I soon had him within reach of the gaff, and when my boatman gently drew him over into the boat it was half-past two o'clock. He was a noble prisoner; and it had taken just one hour and twenty-five minutes to land him. He weighed one hundred and forty-four (144) pounds, and measured six feet eleven inches. I had him mounted, and presented him to the Polytechnic Society of Louisville, Kentucky.

This is the way one Tarpon was caught. Another might act differently. While there is a general similarity in their

actions, the Tarpon has a great deal of individuality, and each of the fish I have caught has acted, in some particulars, differently from the others. Sometimes, when they feel the hook, they come to the surface and skip about like a small Sardine chased by a Shark, in every direction, wild in their efforts to free themselves, and are the very picture of frenzy.

The natural history of the Tarpon is still in a very embryonic state. So little is known of its habits that I have never seen stated in print the season of their spawning. At certain seasons their coloring is more brilliant than at others, indicating that they have been in deep water. How long they remain there, or when or where their spawning occurs, seems to be yet undetermined. The fact that the scales on the back are rendered black by the rays of the sun would seem to indicate that they spend the most of their time in comparatively shoal water. Their backs are exposed to the sun as they sport about on the surface, as they are so fond of doing, or as they feed about on the oyster-shoals, or mud-shallows, after Mullet, much in the manner of a porpoise.

The natives of the gulf coast say that the Tarpon feeds, like the deer, when the moon is south. As the moon controls the tides, and the best time for fishing is known to be upon the flood or full tide, there may be some reason for their assertion. I have known, too, of Tarpon taking the bait of those fishing by moonlight.

Tarpon-fishing is still in its infancy, and there is room for a great deal of interesting matter upon a most interesting subject. There is no question it is the gamest fish in the world, fights furiously and until it is entirely exhausted, and could never be captured with a rod and reel but for its frantic movements and wonderful leaps from the water, the first ten minutes after it feels the hook. During these ten minutes all you have to do is to give the fish all the line he wants, and see that the reel runs free. After he is unable to make his leaps, he will raise his head out of the water and shake it

viciously. To completely exhaust him will require from one to three hours, according to the work you compel him to perform in towing your boat.

I should not forget to mention one remarkable characteristic of the Tarpon. Comparatively few of the smaller ones are caught with rod and line. The young fish seem, contrary to the general rule, to be more wise and wary than the older ones. In my experience, ten fish weighing more than seventy-five pounds are caught to one weighing less.

9

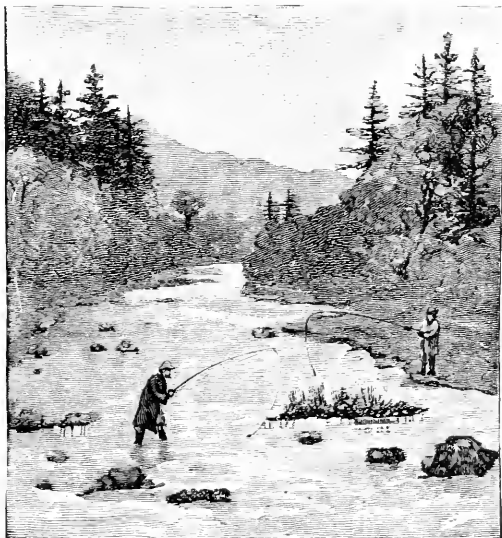

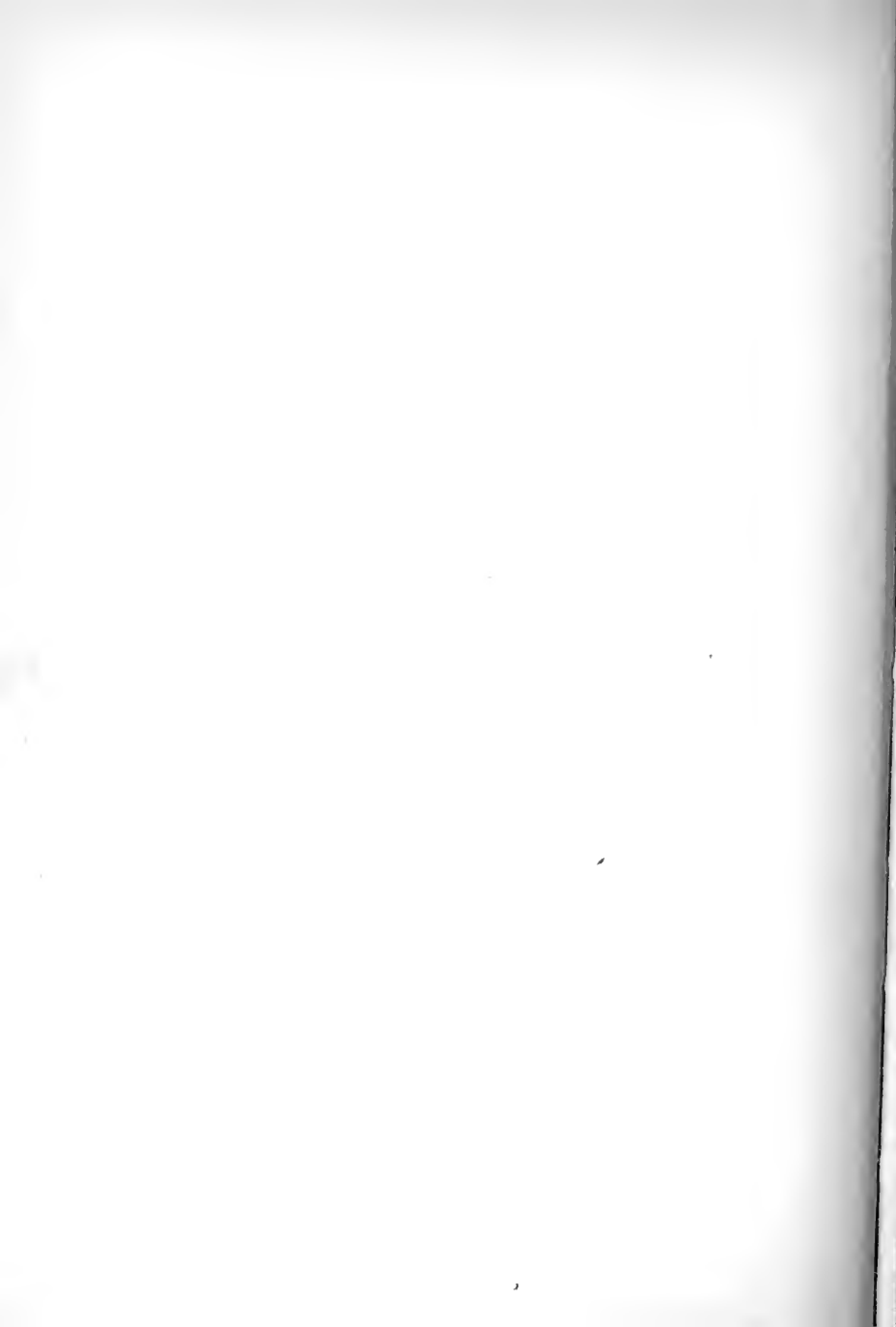



## THE STRIPED BASS.

BY FRANCIS ENDICOTT.

OF the many game fishes which swim the salt or brackish waters of the eastern coast of the United States, the Striped Bass seems to have claimed more of the attention of the angler than any other.

Many clubs have been formed, and thousands of dollars spent in fitting them up; islands have been bought outright, and rocky points utilized, by building out jetties on solid iron stanchions, for the purpose of affording angling sites for this silver-sided racer. In fact, he has given his name to most of the tackle used by anglers on the coast. If in northern waters we are fishing for the Sheepshead, the Bluefish, the Weakfish, or the Kingfish, or in Florida waters for the Redfish or the enormous Tarpon, we use the Bass-rod, the Bass-reel, the fine cable-laid linen thread line known as the Bass-line, and the hooks commonly known as Bass-hooks.

There is a most interesting uncertainty in angling which constitutes its great charm; you know not whether your cast will attract a minnow or a whale, and this is perhaps better exhibited in angling for the Striped Bass than for any other fish, for in many of his haunts you cannot know whether you will strike a fish of half a pound or one of sixty pounds. As an instance, on a visit to the Cuttyhunk Club, on one of the Elizabeth islands of that name, having a reputation, as all the islands have, for the large size of the Bass caught on their rocky shores, I saw on the records that one of the members had caught an unprecedentedly small Bass

weighing two pounds. This gentleman evidently had a knowledge of some wicked game of which we know nothing whatever, for opposite the record he had written "Low."

If I remember rightly, the largest fish caught that day weighed some forty-odd pounds, and the two-pounder is still good for "Low"—whatever that may mean.

Storer, in his "Synopsis of Fishes of North America," describes the Bass as follows:

Cylindrical, tapering; the upper part of the body of a silvery-brown color, the lower part of the sides and abdomen of a beautiful clear silver color; eight or more longitudinal black bands on each side, commencing just back of the opercula, the upper bands running the whole length of the fish, the lower ones terminating just above the anal fin.

I will add to this that on large specimens the stripes are of a beautiful purplish blue, when fresh from the water, fading to a slate-color on exposure to the air, and later, as the scales become dry, to a light brown.

His scientific names are many. DeKay remarks, in a tone of mild sarcasm: "This species, it will be noticed, has had the fortune to receive many names." Dr. Mitchill, who was unacquainted with the labors of his predecessors, imposed upon this species, with characteristic simplicity, his own name.

The Hon. Robert B. Roosevelt, a sound writer on all matters pertaining to the rod and gun, in speaking of the Babel-like confusion which exists in the popular names of birds and fishes, remarks: "To make matters worse, the scientific gentlemen have stepped in, and after indulging in plenty of bad Latin, have added fresh English appellations more unmeaning and less appropriate, if possible, than the common ones."

The following list of scientific names of the Striped Bass requires no comment:

*Perca Lineata.*

*Perca Septentrionalis.*

*Roccus Striatus.*

*Roccus Lineatus.*

*Perca Saxatilis.**Sciæna Lineata.**Perca Mitchelli.**Centropome Raye.**Perca Mitchelli interrupta.**Le Bar Raye.**Labrax Lineatus.*

There are but two common names by which this fish is known throughout the extended region where he is found—they are: Striped Bass, north of Philadelphia, and Rockfish, frequently abbreviated to Rock, at and south of that city. And even these two names sometimes give rise to confusion. A friend who was about to visit Admiral ——, in Maryland, he packing his dress-coat and other “duds,” and I lazily smoking and watching his proceedings—asked whether it was worth while to take his rod and reel with him. I replied, “Do so by all means; you will have time to go fishing in the interval of your social engagements, and will find plenty of Striped Bass and Bluefish.” On his return he told me that he was informed that “there were no fish to be caught there but ‘Rock’ and ‘Taylors,’ and only the *niggers* fished for them;” whereupon he fired off some choice explosives in ancient Sanscrit, or Phœnician, or Volapuk, directed at me. On the day that he left for home he discovered accidentally that the “Rock” was his favorite, the Striped Bass, and the “Taylor” the Bluefish. Then, poetically speaking, he danced in his wrath, and tore his hair, and gnashed his teeth, and wept bitterly.

“A Key into the Language of America, or an Help to the Language of the Natives in that part of America called New England, London, 1643, by Roger Williams,” gives the Indian name of the fish, “Missuckeke”—Bass—and says: “The Indians (and the English too) make a dainty dish of the head of this, and well they may, the brains and fat of it being very much, and sweet as marrow ”

It is unnecessary to say that there is little probability of this name becoming common, though it is quite as descriptive as some of the scientific appellations.

Of the two popular names, Striped Bass seems the more appropriate, as it is descriptive of the fish, and not of the bottom on which they are sometimes, but not always, found; and by this name they are best known in the region where they are pursued most successfully, as well as most artistically, by the angler.

Although the habitat of the Striped Bass is extended, they are found in greater numbers between Chesapeake Bay and Cape Cod than in any other part of their geographical range. Along the coast of this favored region, and in the numerous bays and inlets by which it is indented, they are caught in immense numbers by the seine fishermen, and sent to the New York and other markets. Even the sandy beaches of Long Island and New Jersey are made to furnish their quota of the fish-food required to provision the great cities.

In the fall of the year, crews of hardy surfmen may be seen, on any favorable day, coasting along in their bank skiffs, just beyond the breakers, with one of their number stationed in the bow as a lookout, and as they near the sandspits, where the break of the sea lashes the water into suds, the fish will be seen scudding away, frightened at the approaching craft. I have seen them present a particularly lively appearance in the night-time, darting through the phosphorescent water like bolts of living fire. The séines are short, not comparing with the enormous ones used in North Carolina, and are paid out in the usual manner, from the stern of the boat. I have known five thousand pounds of Bass to be caught in one haul on the coast of New Jersey.

As this king of the surf is indigenous to American waters so the implements used in his capture are peculiar to this country. Salmon and Trout rods and reels are sometimes imported, but all fine Bass tackle, with the exception of the hook, is the result of American ingenuity, and is made by our own artisans.

The methods of angling for him in the early Puritan days,

STRIPED BASS.—*Morone Lincolni*.

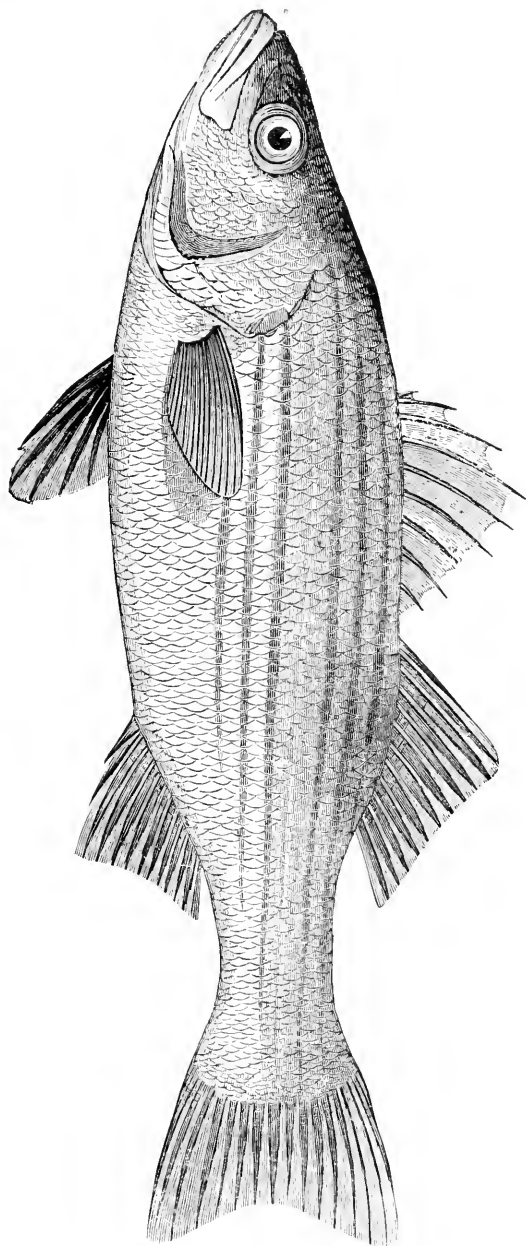

and the implements used, were somewhat primitive. William Wood published a tract in 1634, entitled "Nevv England's Prospect—A true, lively, and experimental description of that part of America called Nevv England,"—in which the manner of catching these fish by our ancestors is thus set forth: "Of these fishes (the Basse) some be three and some foure feet long, some bigger some lesser. At some tides a man may catch a dozen or twenty of these in three houres; the way to catch them is with hooke and line. The fisherman taking a great Cod-line, to which he fasteneth a piece of Lobster and throwes it into the Sea; the fish biting at it, he pulls her to him and knocks her on the head with a sticke."

A recent English novelist, noted for his powers of minute description, gives the following account of Bass-fishing in the last century. The fish spoken of is not our Striped Bass, but his English patronymic, the *Perca Labrax* of Linnaeus, *Labrax lupus* of Cuvier. Old Davy tells the story in "The Maid of Sker:" "Up I roused and rigged my pole for a good bout at the Bass. At the butt of the ash was a bar of square oak, fitted in with a screw-bolt, and woven round this was my line of good hemp, twisted evenly, so that if any fish came who could master me, and pull me off the rocks almost, I could indulge him with some slack by unreeving a fathom of line. At the end of the pole was a strong loop-knot, through which ran the line bearing two large hooks with the eyes of their shanks lashed tightly with cobbler's ends upon whip-cord. The points of the hooks were fetched up with a file and the barbs well blackened, and the whole dressed over with whale-oil. Then upon one hook I fixed a soft crab, and on the other a cuttle-fish."

Can any thing be more quaint than these accounts of fishing in the olden time?

The late Mr. Conroy, an octogenarian whose name was a tower of strength in the fishing-tackle trade for more than half a century, gave me some interesting reminiscences of the

early history of Bass-fishing in the vicinity of New York. He said that the reels were single-acting, awkward affairs at best; that the multiplier, the balance-handle, the guides, reel-band, and tip of the rod, and various other minor details in both rod and reel which go to make up their present perfection, are the result of improvements made from time to time, suggested by the experience of anglers, or by the ingenuity of the makers themselves. As to the material of which the rod should be made, there is much diversity of opinion; in fact, there are so many kinds of wood that are excellent for the purpose, that it becomes a matter of caprice or fancy on the part of the individual. Some prefer the jointed rod of ash and lance-wood; others the Calcutta, and others still the Japan bamboo; while a few, who have the means and believe that this royal fish should be hunted in regal style, use a rod consisting of a short butt of ash, to which the reel is attached, while the long, tapering second joint is made of the choicest bamboo splints glued together and bound with parti-colored silks, with guides and tips of agate or cornelian. This is the rod "*de luxe*"—lovely, costly, delightful to handle, but I fear not over-reliable in wet weather, by reason of the glue used in its construction. Calcutta or Japan bamboo, in their natural state, possess qualities which fit them admirably for heavy sea-fishing; the slender, tapering stems formed of masses of tough, stringy fibers, which spread out sparsely through the pithy inner wood where strength is not required, and crowd so closely as almost to touch each other as they approach the flinty covering—the case-hardening as it were, which envelop the whole—seem to be especially adapted to the purpose.

With such a rod you may cast all day without tiring. It is springy, and strikes a fish sharply and at once, and has an elastic force which will enable you to tire out a seventy-pounder if you have the good fortune to try conclusions with one of that weight. It requires at least as much skill to

make a cast with it as it does to cast a Salmon-fly. The bait must go to its destination at once, or the line has to be reeled in and a fresh cast made; there can be no retrieving the shortcomings of the first attempt, as can be done with the Salmon or Trout rod. When the bait is started on its flight through the air, the reel, if a fine one, pays out the line much faster than the weight of the bait can carry it off, and if not checked by the thumb, the line overruns and forms a disagreeable snarl on the barrel of the reel—the great art being to know just how much pressure of the thumb is requisite to have the line render only as fast as the bait will carry it.

The graceful ease with which the old Bass angler makes his cast is misleading to the tyro. His rod is thrown back with about two and one-half feet of line for play; a rather slow movement of the tip, not a sudden jerk, forward, and the bait, describing a graceful curve, drops noiselessly in the water, within a few inches of where he intended it should. This is done so easily and with so little apparent exertion of strength or skill, that the tyro seizes his rod with confidence and essays to do the like; the result is usually disastrous.

The longest cast on record is that of Mr. W. H. Wood, made at the tournament of the National Rod and Reel Association at Central Park, where, with a two and one-half ounce sinker, the average weight of a Menhaden or Lobster-tail bait, he cast two hundred and sixty and one-tenth feet. This has never been approached. I was present as an officer of the Association and saw the cast measured.

The reel used in Bass-fishing is a multiplier—that is, the barrel revolves twice for every turn of the crank—and is made of German-silver or brass, though the finest reels have the caps and sides of hard rubber, thus avoiding the weight of solid metal which is the great objection to large reels. The size varies with the locality. In the creeks and estuaries of



the coast, where the fish seldom weigh over five pounds, a reel that will carry a hundred yards of linen line is amply large, but for surf-fishing it should be large enough to carry from two hundred to three hundred yards. The barrel should in all cases run on steel pivots, and be so accurate in its workmanship that the lightest fillip on the crank may be sufficient to set it running for some time. This motion should be perfectly noiseless in whatever position the rod is held—no grating of the gearing or friction of the barrel; in short, it should be as near as possible to perpetual motion, and as perfect in its mechanism as the movement of a fine watch.

About six miles from the New York City Hall, as the crowd flies, where the Harlem joins its waters with the East River, lies that pesky, turbulent region of seething currents, eddies, and whirlpools, appropriately called Hell Gate. At slack tide the water will be as placid as a mill-pond, with scarce a ripple to betoken its treacherous character. Sloops and schooners passing through the gate will rest quietly on its bosom, with every detail of sail and spar and cordage accurately mirrored from its glassy surface. Presently little eddies will begin to form, indications of a change of tide; currents will begin to set in contrary directions, and in an incredibly short time the whole scene of placid beauty will change into a brawling, foaming conflict of waters, exceedingly dangerous, as many an unskillful navigator can attest. This was a favorite spot with Washington Irving. To him the whole neighborhood was a region of fable and romance which he delighted to people with ghostly pirates and more substantial old Dutch burghers and their broad-beamed wives and daughters. Many of the localities hereabouts are rendered classic by the glamour of his magic pen. In the whirlpool called "The Pot," a famous lurking-place for large Bass, the gallant tub of the mighty Van Kortlandt came to grief; on one of these rocks the great Ten Broeck peeled himself like

an onion and dried his multifold breeches; on yonder island Black Sam, the negro fisherman, watched Captain Kidd and his men as they buried their ill-gotten treasures by the dim light of the ship's lantern. The place is still called Nigger Point, and is notable for the fine Bass caught there. I have heard of no one who has been made suddenly wealthy by the discovery of Kidd's treasure, but many places in sight can be pointed out where the rise in value of land has been so sudden as to verify the legend of Wolfert Webber and his cabbage plot. For instance, below us, its dark outlines broken by many a spire and ambitious factory chimney, lies the great city whose site was the subject of the famous bargain driven with the Indians by Oloffe the Dreamer.

In the eddies forming about the reefs by these turbulent waters, fine fishing can be had, occasionally, for Bass weighing from two to fifty pounds, though many stories are told of monsters of much larger growth having been caught or which have disappointed the angler by breaking loose just at the moment when they were about to be gaffed. It is well not to place too much reliance on these fishermen's yarns, for many of them doubtless have their origin in the atmosphere of romance which appears to pervade this neighborhood, or in that habit—shall we call it exaggeration?—which seems to be an amiable weakness of the gentle craft. Still the fact remains that more large fish are caught in this locality than at any other place within fifty miles of the city.

Hell Gate is particularly worthy of note, as it is undoubtedly the school from which all of our large Bass anglers have graduated—not intending, however, to say that all who at present fish for large Bass are Hell Gate fishermen, for there are now many excellent anglers from all parts of the Union, members of the great fishing clubs, who have no further knowledge of its intricacies than that obtained from the deck of a Sound steamer; but that the art of fishing for heavy fish with light tackle was first practiced in these waters, and that

the tackle used at present for all heavy sea-fishing is substantially the same as that invented for or suggested by the veterans, founders of the great Bass fishing clubs—Cuttyhunk, Pasque, West Island, and Squibnocke—who had served their apprenticeship and acquired their skill amid the boiling waters around Pot Rock. There are many honored names in the fraternity. Frank Forester, Genio Scott, Peter Balen, Robert B. Roosevelt, Ed. Phalon, Phenix Ingraham, William Woodhull, James Vallotton, and S. M. Blatchford—the designer of the jetties now used on the ocean beaches of New Jersey, for Bass fishing, with great success—all were graduates from Hell Gate.

There is an uncanniness about night-fishing in this locality which never fails to produce a profound effect on the mind. The dark, swirling waters, of unknown depth, as they sweep past the stern of the boat, are suggestive of mysterious thoughts which no amount of philosophical reasoning can dispel. On one occasion an angler, while fishing in Hell Gate, had come to anchor off Mill Rock, and having met with considerable success, had prolonged his stay, notwithstanding that the night had grown dark and that thick clouds had gathered overhead, threatening a storm. A cast was made toward the eddies which form about the rock, and as the baited hook disappeared in the darkness he felt it strike and catch in some object which the tide was bearing rapidly away. For a moment the line paid out with great velocity, but checking it gradually, he felt it slacken its speed and come to a stop, though the pressure of the tide still kept a severe strain on the rod. He tried to loosen the hold of the hook by alternately easing and jerking the line, but without success, and finding that the object yielded to a steady pull, commenced reeling it in slowly.

What was it? It was evidently inanimate and floating. He peered out into the darkness, straining every visual nerve, but he might as well have attempted to see through

the darkness of Egypt as that which now encircled him. He became nervous—almost frightened. There passed through his mind thoughts of the river's dead—of ghastly, sheeted forms which he had seen on the cold slabs of the morgue; of the horrible semblance of humanity which he had once seen floating in a ferry-slip, the features decomposed and half eaten by fishes, while the rayless eyes seemed to look up to his horrified gaze in mute appeal, that they might be laid away far from the sight of man under the sod. He felt for his bait-knife to cut the thing loose, but a feeling of pride came to his assistance, and he laid it down again. Finally summoning all his manhood, he turned the handle of the reel slowly until he knew by the position of the line that *it* was almost within his reach. Here was a moment of suspense. He did not wish to touch it in the darkness, neither did he wish to use the gaff-hook. He felt in his pocket for a match, scratched it a number of times on the gunwale of the boat, and waiting for the sulphur to burn off, held it over the stern, and in the dim, flickering light which it afforded, beheld—an empty pork-barrel dancing and courtesying to him on the waves. He burst into a laugh which had nothing of mirth in it, but pulled up his anchor—and then I went home, and have never fished in Hell Gate at night since.

There is a large class of anglers in the city of New York and its vicinity, among them many experts, who can rarely leave their business cares for more than a day at a time, and whose trips are limited to such localities as can be reached in an hour or two, so as to admit of their returning on the same day. To these there is a charm about the very name of Bass which is irresistible, and in the October days, when the cheering word comes from any of the estuaries of New York Bay, or Spuyten Duyvil, or Coney Island Creek, or at Kingsbridge, or some of the upper docks of the city itself, these anglers of a day may be seen at the fish-markets in the early hours of the morning, with rods and weather-beaten

fish-baskets laying in their stock of shedder crabs, shrimp, and sand-worms, not forgetting a string or two of soft clams, for Bass are capricious in their taste, and will sometimes take the plebeian clam in preference to the aristocratic and high-priced shedder. At this season of the year the waters of Newark Bay, Staten Island Sound, and the Kill von Kull will fairly teem with small Bass, rarely reaching five pounds—oftener ranging from three-fourths to one and one-half pounds each—and will be dotted with the small boats of anglers eager in the pursuit of the gamy little fish.

A day at one of these favored spots with a genial companion, or, if alone, spent in those delicious musings and self-communings into which one easily falls from pure idle enjoyment, broken occasionally by the tug of some prying unfortunate who attempts to purloin the bait and comes to grief on the treacherous barb, is one to be treasured in the memory and marked with a white stone forever.

As our boat swings lazily with the current, we note the wondrous witch-work which the frosts have wrought upon the foliage of the neighboring hills, the russet browns, and vermilions, and yellows mingling boldly with the dark green of the cedars, while the soft haze of the Indian summer mellows and blends the brilliant dyes into a mass of harmonious coloring, giving them an indistinctness which makes it hard to realize that we are not in dream-land. Emerson asks, "Who can guess how much firmness the sea-beaten rock has taught the fisherman? How much tranquillity has been reflected to man from the azure sky?" We give it up; we feel in no mood to answer such questions; we know only that the hours glide by with a fleetness unusual, and that every moment brings with it its measure of pure and unalloyed content.

What matters it if our catch does not rise above the dignity of pan-fish, or even if the proverbial "fisherman's luck" should fall to our lot? we have a day spent in the glorious

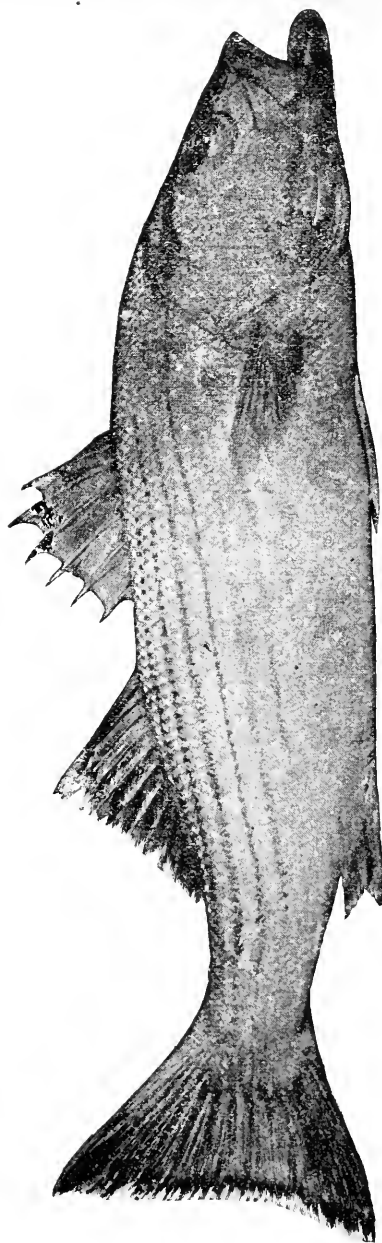

STRIPED BASS.—From a Photograph.

autumn weather, breathing the balmy air of the Indian summer, tempered and softened as it comes over the salt water, until we feel an exhilaration which will show itself for many days after in a renewed activity of mind and body.

When the tide rises or the fish cease biting, we try other grounds, never rowing over the spot which we propose to fish, but approaching it with the utmost caution, particularly if the water be shallow, for your Bass is a shy fish, and grows in wariness as he increases in size. He is as keen of eye as a Trout, and will take alarm at the near approach of a boat or at any unusual disturbance of the water. So we drop our anchor noiselessly, far enough from the feeding-ground to have our boat swing within easy casting distance. The more quietly these operations are conducted, the greater the probability of taking large fish.

I have many times fished with an old friend—that thorough angler and excellent writer, Genio C. Scott—on the south side of Long Island for Trout, at Rockaway Inlet for Sheepshead; but the one day that we had, off Staten Island, fishing for Striped Bass, when I sat, as it were, at the feet of Gamaliel, gathering in heaps of fish-lore and occasional fishes, will ever have a place in my memory as one of perfect enjoyment. Peace to his ashes.

We caught, that day, thirty Bass, averaging one and three-quarter pounds, in two hours' fishing.

The baits used in fishing for Bass, are, as Mr. Venus puts it, in "Our Mutual Friend," "various," depending entirely on the location. On the Susquehanna the Bass are trolled for with the eel tail, and they take it readily. At the falls of the Potomac, and also on the Passaic and Raritan rivers, they take the fly. No doubt they would rise to the fly in other waters if properly invited, but these are small Bass. At West Island, No Man's Land, Block Island, and the fishing stands of the Vineyard Islands, the Menhaden bait and Lobster tail are used with great success. At Hell Gate, and other

places in the vicinity of New York, shrimp, shedder crabs, soft clams, squid and sand-worms are the favorite baits, either in trolling or still fishing—the white sand-worm, or blood-worm, as it is sometimes called, from the reddish fluid that it gives out when pierced by the hook, being by far the most killing of all. They cost about two dollars a hundred, while, when fishing at Gay Head, Martha's Vineyard, I paid but one dollar and fifty cents per hundred for young Lobsters. Mr. Tillinghast, of New Bedford, stood by me where I was fishing, and kept me supplied with bait. The tail was cut off and the shell peeled from it—that made one bait; the rest of the lobster he cut up fine and threw into the water as "chum," to attract the fish. After a time he became tired, and although he declared that the water looked more "Bassy" than he had seen it in the several days that he had been trying for them, left me, saying jokingly, "All the Bass you catch to-day I will put in my eye." In less than an hour I had two, one of twenty-five pounds and one of fifteen pounds. I shall always remember the pleasure that I took in thinking of the unmerciful test that at his own suggestion he would have to sustain on my return to the light-house.

Neither will I soon forget the idyl of that day, when a bevy of laughing beauties—school-girls—picnicking from New Bedford, accompanied by a staid, elderly matron, came trooping along the shore, gathering up the Irish moss, pebbles, and shells or fossils washed from the cliffs overhead, giving a scream of delight at each new find. One of them, incited by that spirit of mischief inherited from her grandmother Eve—miled, no doubt, by the roughness of my costume, the weather-beaten shirt and hat, tattered trousers, and my swarthy, sun-burned complexion—mounted on the rock by my side, and, in the most demure manner possible, commenced to ply me with all sorts of embarrassing questions—whether I was married, or engaged, or had a sweetheart; and was this a cold place to live in in winter, and other quizzing of like nature,



tending to great discomfiture and unrestrained merriment on the part of her more bashful companions; for, although some of the questions drew heavily on the imagination for a reply, I had not the heart to mar their innocent fun by appearing in true character as one of the wicked denizens of the great metropolis, but kept up the rustic simplicity to the end, when, tired of their chaffing, or seeking more fun, they glided away along the beach, leaving in my memory, never to be forgotten, the echo of their merry ripples of laughter.

Some of the greatest catches known, of large Bass, were made from the iron piers built for the purpose by the late Thomas Winans, at Newport, Rhode Island. In three months of one year—July, August, and September—he and his nephew, Thomas Whistler, caught one hundred and twenty-four Bass, weighing two thousand, nine hundred and twenty-one pounds, an average of over twenty-three pounds, the largest being one of sixty pounds. There were but nineteen minnows taken in the season, that weighed six pounds or under. This sounds like a fish yarn, but I have the highest authority (documentary) for the statement. Noteworthy days were those when, on the 20th of September, their two rods brought to gaff twelve fish, weighing four hundred and seventy-seven pounds, or on the 9th of the same month, when they landed two hundred and five pounds, and when, on the same day, Miss Celeste Winans caught four, weighing respectively, forty-eight, fifty-five, thirty-five, and thirty-nine pounds. There are but few Bass anglers who would not be proud of this record made by a delicately nurtured woman. Mr. Winans was an invalid, and fished but a few days in the season; otherwise the catch would have been much larger.

Is there more royal fishing than this?—expensive, but still royal. I have no doubt but that, taking in the cost of the two iron structures and the many other incidentals, every pound of Bass caught cost him five dollars. He, Mr. Winans, would buy his two hundred-yard twelve-thread linen

lines by the hundred, costing two dollars and fifty cents apiece, and would never use one a second time, fearing that they might have been frayed by the rocks, and thus lose him a heavy fish. This thorough sportsman died a few years ago, leaving some millions to his heirs—he was poor, but otherwise respectable.

But it is time to stop. Here we are giving away what little we know about fishing—contrary to the precepts of the late Wynkyn de Worde (A. D. 1491) who, in his introduction to the famous "Treatyse on Fysshynge," holds forth in this manner:

"And for by cause that the present treatyse sholde not come to ye hondys of eche ydle persone whyche wolde desire it yf it were emprynted allone by itself put in a lytyll plaunflet, therefore I have compylyd it in a grete volume of dyverse bokys concernynge to gentyll and noble men to the extent that the forsayd persones whyche sholde have but lytyll mesure in the sayd dysport of fysshynge sholde not by this meane utterly destroye it."

## THE BLACK BASS.

BY DR. JAMES A. HENSHALL.

SIXTEEN years ago I penned the following prediction in regard to the Black Bass: "That it will eventually become the leading game-fish of America is my oft-expressed opinion and firm belief." Also: "That by the use of suitable tackle it would not suffer by a comparison with other game fishes."

That my opinion was correct and my belief well-founded is proved by the complete verification of this prediction; for at the present day no fish is more constantly and more eagerly sought for by bait-fisher and fly-fisher than the Black Bass. And if further proof were necessary to establish the claim that the Black Bass is now the leading game fish of America, it is only necessary to refer to the fact that follows:

When the above prediction was made there was not a single tool or article of tackle made expressly for Black Bass fishing, and advertised as such, except the trolling-spoon. True, the "Kentucky reel" had been manufactured by Meek and Milam for a number of years, but it had never been advertised, and was comparatively unknown, except to a few western anglers.

How is it now? Every manufacturer of fishing-tackle is making articles especially for Black Bass fishing—rods, reels, lines, flies, leaders, etc.—and it is only necessary to refer to the advertising columns of our sportsmen's journals to make this fact apparent.

Of course, the deplorable scarcity of Brook Trout fishing, and the continual and inevitable decrease of that noble game fish in our dwindling and polluted Trout streams, have a great deal to do with the manifest interest and pronounced favor with which the Black Bass is at present regarded by the angling fraternity; but, in my opinion, the greatest reason for this marked appreciation of this grand game-fish is the introduction of proper and suitable tools and tackle for its capture.

Regarding the game qualities of the Black Bass I also, years ago, hazarded this apparently heretical sentiment: "I consider him, *inch for inch* and *pound for pound*, the gamest fish that swims." The lapse of years, and a more extended experience in angling, from the lordly Salmon of Canadian streams to the legion of finny acrobats of Floridian waters, only confirm in my own mind this seemingly broad and sweeping assertion.

As to a comparison of game qualities as between the Small-mouthed Bass and the Large-mouthed Bass, I still hold that, all things being equal, and where the two species inhabit the same waters, there is no difference in game qualities; for while the Small-mouth is probably more active in its movements, the Large-mouth Bass is more powerful, and no angler can tell from its manner of "fighting" whether he is fast to a Large-mouth or a Small-mouth Bass until he has the ocular evidence.

As there is but little difference in habits, and still less in game qualities as between the species, and as the methods of angling for both are the same, my remarks in this paper will apply to either species under the generic name of "Black Bass," unless otherwise distinctly stated.

#### ANGLING AUTHORS ON THE BLACK BASS.

Prior to the establishment of our now popular journals and periodicals of out-door sports, there was very little informa-

tion concerning the Black Bass in books devoted to angling. Both species of Black Bass being originally absent from the waters of the Atlantic Slope of the New England and Middle States, and our early angling authors residing in eastern cities, they either knew very little or absolutely nothing of this now well-known game-fish.

John J. Brown ("American Angler's Guide," 1849), says of the Black Bass:

"It has a thick *oval* head; large mouth, with *rows* of small teeth; a wide dorsal fin near the center of the body, *another* toward the tail, with *corresponding* pectoral and anal fins. The body is quite thick near the head, and tapers regularly, terminating in a *swallow tail*."

The italics are mine; but could any description be more misleading?

Again, being misled by the name "Trout," as applied in the Southern States to the Black Bass, he classifies it under the head of "Brook Trout," and innocently states:

"They grow to a much larger size than northern Trout, varying in length from six to twenty-four inches; they are of a darker color, and do not possess that beauty of appearance when out of the water, or that delicious flavor when upon the table; neither do they contribute so much to the angler's sport, as those of northern latitudes."

However, he gives, in other portions of his book, brief notes from several western and southern anglers containing rather fair descriptions of the appearance and habits of both species of Black Bass.

Henry W. Herbert ("Frank Forester's Fish and Fishing," 1850) knew no more of the Black Bass than Mr Brown. He compiled the description of the species from De Kay and Agassiz, and quotes the same western correspondent of Buffalo, New York, as Mr. Brown in reference to Black Bass fishing, saying, wisely: "I prefer quoting him to writing of this fish myself; as, although not unacquainted with his hab-

its, I have never yet myself enjoyed the pleasure of catching him either with the fly, the spoon, or the shiner."

Robert B. Roosevelt ("Game Fish of the North," 1862) writes more intelligently of Black Bass and Black Bass fishing than any of his contemporaries, because he wrote in the light of considerable personal experience in fishing for this magnificent game-fish in the St. Lawrence basin.

Thad Norris ("American Angler's Book," 1864), although having no personal experience in Black Bass fishing, is, as usual, quite correct, for his day, in his description of the species, for he described them carefully from actual specimens and the best authorities (Holbrook, Agassiz), but beyond very fair descriptions he gives very little information.

Genio C. Scott ("Fishing in American Waters," 1869), although the latest angling writer of the period under consideration, has less to say, and apparently knew less of the Black Bass than any of his predecessors.

#### NOMENCLATURE.

There are but *two* species of Black Bass, the correct names of which are the Small-mouthed Black Bass (*Micropterus dolomieu*, Lac) and the Large-mouthed Black Bass (*Micropterus salmoides*, [Lac.], Henshall). The numerous local or vernacular names bestowed upon these two species in various parts of the country have been the cause of great confusion, and have often caused the truth-seeking angler to doubt whether there were one or a dozen species. Thus in Southern Virginia the Large-mouthed Bass is known as "Chub," as in North Carolina it is called "White Salmon," "Welchman," or "Trout-Perch," while throughout the entire South and Southwest both species are generally known as "Trout." In Eastern Kentucky the Small-mouthed Bass is "Jumping Perch." In the North and West both species are known as "Bass," with the addition of various adjectives expressive of gameness, coloration, or habitat, as "Tiger

Bass," "Bull Bass," "Buck Bass;" Black, Green, or Yellow Bass; Lake, River, Cove, Moss, Slough, or Marsh Bass, or Oswego Bass. These names, or others, are applied indiscriminately in different localities to either species of Black Bass. Throughout the Northwest the Small-mouthed Bass is usually known as "Black Bass," and the Large-mouthed Bass as "Green Bass," or "Oswego Bass," though the last name is in other sections sometimes applied to the Small-mouthed Bass. In Oswego River the Large-mouthed Bass is rarely or never taken. Then again Black Bass species are sometimes confounded with the Rock Bass (*Ambloplites rupestris*), the Calico Bass, or Straw Bass (*Pomoxys sparoides*), or the White Bass (*Roccus chrysops*), which are entirely different fishes, with but a very slight family resemblance to the Black Bass.

From the foregoing it will be readily seen that local names for so widely distributed a fish as the Black Bass are a delusion and a snare. The only safe rule for anglers to follow is to use the name "Black Bass," for the *genus*, and the names "Small-mouthed Black Bass," or "Large-mouthed Black Bass" for the species.

#### DESCRIPTION.

At this late day it is unnecessary to enter into a detailed description of the two species of Black Bass. The specific differences are now apparent to most anglers, who readily distinguish one from the other. The most striking and most easily recognized structural differences are in the comparative size of the mouth, and of the scales, as will be seen at once in the subjoined illustrations.

It will be observed that the angle of the mouth in the Small-mouthed Bass reaches only to, or below, the eye; while in the Large-mouthed Bass it extends considerably beyond, or behind it.

The scales on the cheeks of the former are quite small as compared with those on its body; while in the latter the

cheek scales are relatively much larger, nearly as large as its body scales.

Also, there will be found ten or eleven rows of scales between the lateral line and the dorsal or back fin of the Small-mouthed Bass; while there will be found but eight rows in the Large-mouthed Bass, owing to their larger size.

These differences might be epigrammatically expressed thus: Small mouth and small scales; large mouth and large scales. The angler who remembers this will never be at a loss to identify the Black Bass species.

#### COLORATION.

The coloration of both species of Black Bass varies greatly in different waters, and often in the same waters. It may run from dark, bronze-green, brownish or almost black, to bright green or even a yellowish-green. Usually, however, the Small-mouthed Bass is darker than the Large-mouthed Bass, the prevailing color in both being olive-green. The color is always darkest on the back, becoming lighter on the sides, and fading out to white on the belly.

There are usually various darker markings on the cheeks and body. In the Large-mouth the body marks are usually faint, longitudinal, clouded streaks; while in the Small-mouthed Bass they are transverse or vertical indistinct bars.

In a day's fishing the angler may take Bass of a dozen different shades; but if they are kept on the same string, or in the same basket, he will find at the close of the day that all of the same species are of the same color.

#### BREEDING.

It is also well known that the Black Bass is a spring or summer-spawning fish, according to climate, this function being greatly influenced by the temperature of the water, occurring as early as April in the extreme South, and as late as July in the deep, cool waters of the extreme North.



The male and female pair and form a circular, shallow nest in coarse sand or gravel, where the eggs and milt are deposited, and hatch in about two weeks. A female Black Bass will deposit between ten and twenty thousand eggs. The young fry are about three-eighths of an inch long when hatched, and remain on the nests several days or a week. The parent fish watches and protects the eggs, and afterward the young fry. The young Bass grow rapidly, reaching a length of three or four inches when a year old, and eight or ten inches when two years old. They mature about the age of three years.

#### FOOD AND GROWTH.

The food of the young fry, at first, consists of minute crustacea and other animalcules; afterward, almost entirely of insects until a year old; the second year they begin feeding on crawfish and small minnows, always preferring the former; the prevalent opinion that Black Bass feed almost exclusively on other fishes is incorrect and untrue.

The maximum weight of the Small-mouthed Bass is five pounds, the Large-mouthed Bass growing a pound or two heavier, though in Florida the latter reaches fifteen pounds; of course there are individual exceptions where both species have attained a greater weight.

#### DISTRIBUTION.

The Black Bass now inhabits every State of the Union east of the Rocky Mountains, and portions of California on the Western Slope. It has been successfully transplanted in England, Scotland, Germany, and the Netherlands; in time it will become cosmopolitan. In the Northern States it undergoes a more or less complete hibernation, according to the climate, and in the extreme South, during the hottest portion of summer, undergoes the analogous condition of aestivation.

## OLD-TIME BASS FISHING.

If the descriptions of the appearance and habits of the Black Bass by the authors of the angling-books before mentioned are so brief or inexact, what do they say as to the methods of angling for this grand game-fish?

Brown says: "He is angled for in the usual way, and with the same arrangement of tackle as the Striped Bass or Salmon; and with some enthusiastic western sportsmen is thought to give more amusement than either. But the most active and exciting mode of pursuit is with the trolling-rod and boat." His Buffalo correspondent treats briefly and vaguely of still-fishing with minnows and crawfish.

Another one states that: "The most beautiful mode of angling for them known, is trolling either with live bait or an artificial fly of large size and gay appearance," and gives the formula for the "fly," as follows: "Body of a peacock feather, wings of bright scarlet kerseymere and white pigeon feathers; or, the feather stripped from a white goose-quill, and wound round like the hackle, and surmounted with thin strips of scarlet for wings." Shades of Cotton!

In a later edition of Brown's book, a Detroit correspondent says: "The modes of taking this delicious fish are by trolling, and still-fishing with the rod and reel," and gives very good, but short descriptions of these methods of fishing, as then practiced.

Herbert throws no additional light on the subject, but after quoting the same correspondents as Brown, states in addition: "A friend of my own has killed many of this fine Bass with a large red hackle, with a gold tinsel body, and also with a green-tailed grannam."

Roosevelt, as before stated, is the only author mentioned who writes intelligently of Black-Bass fishing. He says: "They will take minnows, shiners, grasshoppers, frogs, worms, or almost anything else that can be called a bait. \*

\* \* They may be captured by casting the fly as for Salmon or Trout, and this is by far the most sportsman-like way, but the most destructive and usually resorted to is trolling." But, unfortunately, the only personal description of Black Bass fishing he gives is by trolling with large flies.

The only experience related by Norris is this: "I have taken this Bass in the vicinity of St. Louis, on a moonshiny night, by skittering a light spoon over the surface of the water, while standing on the shore."

Scott devotes just three lines to Black Bass fishing: "This fish is taken by casting the artificial fly, or by trolling with the feathered spoon, with a minnow impaled on a gang of hooks, and forming spinning tackle."

In the light of the present literature of the Black Bass, these antiquated ideas are quite amusing, while in the matter of tools and tackle they seem very crude when contrasted with our present light and comely bait-rods and fly-rods, to say nothing of improved reels, lines, and hooks.

But while these Nestors of the gentle art were recommending Salmon rods, and Striped Bass rods and heavy trolling-rods for a fish they knew nothing or very little about, practically, the true Black Bass fishers of the then West and Southwest were using light cane rods, Kentucky reels, and the smallest sea-grass lines. They knew nothing of Salmon, Striped Bass, or trolling rods, and had no use for them had they known them.

More than thirty years ago I saw anglers in Kentucky and Southern Ohio using natural cane rods, ten feet long and weighing but a few ounces (much lighter, in fact, than any trout fly-rod then in vogue), with Frankfort reels affixed by grooved metal reel-seats to these native cane rods. This gave me my first idea of short and light bait-rods for Black Bass fishing.

Until a few months before this, as a boy in Baltimore, I had used similar jointed cane rods, of my own construction, for White Perch and small Striped Bass in the Patapsco

River, and for Brook Trout in the mountain streams of Pennsylvania, Maryland, and Virginia. From this idea was gradually evolved, some ten years later, the "Henshall" Black Bass rod, eight and a quarter feet long, and eight ounces in weight. Up to this time there were no jointed rods to be had of less than twelve feet in length, (except the heavy Striped Bass rods), or weighing less than fifteen ounces.

Lighter rods suggested and demanded lighter and smaller lines and improved reels, so that at the present day we have implements and tackle for Black-Bass fishing as light and comely, as elegant and suitable as those for Brook Trout fishing; and it is in the use of such tools that the full enjoyment of Black-Bass fishing is realized.

#### MODERN BASS FISHING.

Owing to the remarkably wide distribution of the Black Bass species, and the great variety in the character of the waters they inhabit, it would seem that the methods of angling for them, and the character of the tackle employed in their capture, would be subject to considerable variation or modification. But this is true to a very limited extent only, and there is no good or valid reason for any great difference in the weight and strength of tools and tackle for Black-Bass fishing in any waters. For instance, the standard "Henshall" bait and fly-rods, as described in my "Book of the Black Bass" \* and in my later book, "More about the Black Bass," † will be found sufficient and suitable, in the hands of a tolerably expert angler, for Black-Bass fishing in any local-

---

\***BOOK OF THE BLACK BASS:** Comprising its Complete Scientific and Life History, together with a Practical Treatise on Angling and Fly-Fishing, with a Full Account of Tools, Implements, and Tackle. By Dr. James A. Henshall. Illustrated. 12mo. 464 pp. 1881. Robert Clarke & Co., Cincinnati, O.

†**MORE ABOUT THE BLACK BASS:** Comprising additional matter on the subject of each chapter of the original work, arranged in the same order, containing the latest developments in the Scientific and Life History of this best of the American Game Fishes, the latest wrinkles in Angling and Fly-Fishing, and the most recent improvements in Tools, Tackle, and Implements. With a new Portrait and numerous Illustrations. 12 mo. 204 pages. 1889. Robert Clark & Co., Cincinnati, O.

ity, and for either the Small-mouthed or Large-mouthed species of Black Bass.

There are many men, however, who, though good and successful anglers—who possess great love for the sport, and who have acquired a good knowledge of the haunts and habits of the Black Bass—yet are not expert or skillful in the use of light tackle, and require or employ heavier and stiffer rods than those just mentioned. These anglers are mostly bait-fishers, and are like another class of sportsmen, who, though only ordinary shots, make the best bags on account of their superior knowledge of the habits of the game they seek.

For the sake of convenience, Black-Bass fishing may be considered under two heads—"stream-fishing," and "lake-fishing"—either with the artificial fly or with natural bait; accordingly, I will adopt that plan, for the purpose of showing where a heavier or lighter rod than the standard rod of eight ounces may be used.

#### STREAM-FISHING.

By stream-fishing I mean either bait or fly-fishing from the bank or by wading the stream. This is my usual and favorite way of angling, and I think surpasses lake or pond fishing beyond the bounds of comparison. Light rods and tackle can be employed, for the Bass in rocky, swift streams are usually the small-mouthed species, and do not grow so heavy as the big-mouthed Bass of lakes and ponds; and especially is this true of fly-fishing, because the largest fish, as a rule, do not take the artificial fly. Fly-rods, then, may be used weighing from seven to seven and one-half ounces, and bait-rods from seven and one-half to eight ounces for stream-fishing.

Boat-fishing on lakes, ponds, and broad, quiet streams is unendurable without a companion, and the angler always has at least his boatman for company; but in stream-fishing he has the birds and flowers, the whispering leaves, the laugh-

ing water—old and genial friends of whom he never tires, whose fellowship is never wearisome, whose company is never dull. There are no harsh or discordant sounds on the stream—nothing to offend the eye or ear. Even the kingfisher's rattle, the caw of the crow, the tinkle of the cow-bell, the bark of the squirrel are softened and subdued and harmonized by the ripple of the stream and the rustle of the overhanging trees. All is joy and gladness, peace and contentment, by the merry shallows and quiet pools of the flowing, rushing stream. The swish of the rod, the hum of the reel, the cutting of the line through the water, the leap of the Bass, seem somehow to blend with the voices of the stream and the trees on its banks, and to speak to the angler in louder, though sweeter, tones than on open waters; such sounds seem to be more intensified or heightened in their effect by some mysterious acoustic property of the stream and its surroundings. And the occasional "pipe of peace" in some shady nook or sequestered spot, where, stretched at full length, the angler idly watches the nicotian incense assuming all manner of weird shapes as it ascends toward the tree-tops, while he indulges in fanciful day-dreams, with the cool breeze fanning his heated brow—the soft ferns resting his tired limbs! Yea, verily, this is the fishing beyond compare.

#### LAKE-FISHING.

Lake-fishing will include, arbitrarily, the Great Lakes, the larger inland lakelets of Canada, Minnesota, Wisconsin, Michigan, and other States, and the lakes, lagoons, and broad streams of the Gulf States. Presumably, a boat is always used in this kind of fishing, either with fly or bait, in which the angler is

—"Cabin'd, cribb'd, confined, bound in  
To saucy doubts and fears."

As the Bass grow larger, on an average, and are mostly

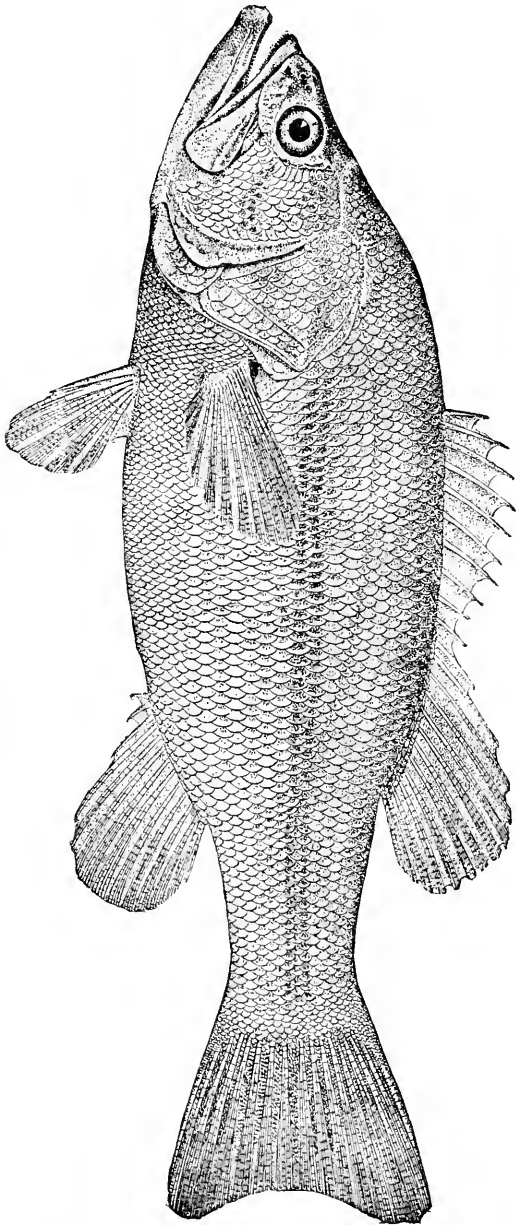

SMALL MOUTHED BLACK BASS.—*Micropterus Dolomieu*.

the large-mouthed species in all of these comparatively still waters, and very much larger in Florida and the Gulf States, a heavier rod may be employed than in stream-fishing. The "Henshall rods" alluded to above, when of the maximum weight of nine or ten ounces, are certainly heavy enough to meet the requirements of any one, and for the Large-mouthed Bass of Florida (running up to twelve or fifteen pounds or more), such a rod is not too heavy, and is powerful enough withal to kill fishes of other species of twenty or thirty pounds weight. I am now speaking particularly of bait-rods, though a fly-rod need be no heavier and will be found just as effective.

There is a method of lake-fishing, however, that differs from ordinary Black Bass angling, and requires a somewhat different rod. I allude to the fishing about the Bass Islands in the western part of Lake Erie. The Small-mouthed Bass of this locality hibernate under the numerous ledges and cavernous, limestone reefs projecting from and lying between these islands; and when the Bass are coming out of their winter-quarters, in April and May, and just before going into them, in September and October, the fishing is very good about these reefs and ledges; but the Bass disappear from them during the summer months, being then absent on their spawning and feeding grounds in other portions of the lake, or up the streams.

There are a great many anglers who frequent Pelee, Kelley's, and the Bass Islands, about Put-in-Bay, every spring and fall, for this reef-fishing. Some of them are veterans in the sport, having made these semi-annual pilgrimages for twenty-five or thirty years.

As a rule, Lake Erie anglers use a very short, heavy, and stiff natural cane rod, and for this reason: The Bass lie close to the reefs and under the ledges, in water from ten to twenty feet or more in depth, and in order to get the bait (minnow) down to the reef as quickly as possible, and to



keep it there, it is the custom to use very heavy sinkers, weighing from two to eight ounces, at the end of the line, the snelled hook being placed a foot or two above it, after the manner of the "dipsey" lead on the east coast. One or two artificial flies are often added to the line above the baited hook. The heavy sinker is often made to pound or strike on the rocks, ostensibly to attract the attention of the Bass. Of course it is possible to catch Bass on these reefs in the usual way—with light rods and tackle and the smallest sized sinkers and swivels, and it is the method I employ; but it is also certain that those who use the heavy sinkers catch the most fish, and for this reason it is fair to presume that this will always be the favorite method with Lake Erie anglers.

In order to induce this large class of anglers to discard the unsightly and insufficient natural cane rods of large caliber and great weight, as usually employed, I have devised a modification of the "Henshall rod" for this special fishing, which requires a short, stiffish, and springy rod, of medium weight, in order to manipulate so heavy a sinker. It will be fully described a few pages later in this article.

#### FLY-FISHING.

RODS.—For fly-fishing on streams a lighter rod can be employed than on lakes, for reasons heretofore given. This should be ten feet and three inches in length and seven and one-half ounces in weight, with a somewhat stiffer back than a Trout fly-rod of the same length and weight. The rod may vary a little in its dimensions from this standard; it may be slightly longer or shorter, or a little lighter or heavier, to suit particular tastes or waters; but in no case should it vary more than three inches in length or one half-ounce in weight in either direction.

Of course, a Trout rod of about these dimensions will answer very well for Black-Bass fishing, but as the flies to be used are usually larger than Trout flies, and as the Bass is

generally a much heavier fish than the Brook Trout, the rod will require a little more "back-bone" than is usually found in Trout rods. At the same time it must be almost as pliant or flexible, but more resilient, and these conditions are attained by a stiffish back—*i. e.*, the lower third of the rod. And to obtain the necessary spring, snap or resiliency required in a Black Bass fly-rod, much consideration must be given to the material of which it is to be constructed.

In my opinion there is no material that combines so many good and essential qualities as split bamboo. It is strong, flexible, light, and the most resilient material used in rod making, approaching steel more nearly in this characteristic than any other wood. Ash, lance-wood, greenheart, bethabara, and some other woods, when carefully selected, make excellent rods, if properly constructed, but the best are inferior to a *good* split bamboo rod. I will add, however, that most of the *cheap* split bamboo rods now in the market are inferior in every way to a good wooden rod, and they cost much less to manufacture.

REELS.—The best reel is, of course, the narrow, single-action click reel, made expressly and only for fly-fishing. Most of the fine multiplying reels, however, are now made with an adjustable click, to permit of their being used for both bait and fly-fishing; and while they are heavier, and the spool wider (requiring care in reeling the line evenly), they answer very well for fly-fishing where the angler owns but one reel. My advice is, nevertheless, to use the click reel for fly-fishing, as the cost of a good one is inconsiderable.

LINES.—The best line, by all odds, is the enameled, braided silk fly-line, tapered or not, the former being better adapted for long casting. Some are metal-centered—that is, having a very fine wire running through the center, and while they may be as good, I do not see that they are any better than the well-known enameled line; they are slightly heavier, which is some advantage in windy weather. The

two smallest sizes, "F" and "G," should be used, the last being preferable for stream-fishing.

**LEADERS.**—The leader should be five or six feet long, and formed of the best single silkworm gut that can be obtained. The gut lengths should be carefully selected, and be entirely free from all flaws or imperfections. None but clear, round, strong and sound lengths should be put into a leader for Black-Bass fishing, and then only after testing their strength up to a strain of two pounds dead weight. The caliber of the gut should not be much greater, if any, than that used for Trout-fishing. The leader should taper, somewhat, from the reel-end to the fly-end. The lengths may be tied by the old-fashioned water-knot; but the best knot, and the one now most generally used, has no name that I am aware of. It is simply a "half-hitch," except that it is tied in a double instead of a single cord. The ends of the two gut lengths to be tied (having been previously softened by soaking in warm water) are passed by each other, or lapped about two inches; and tied by a single knot, or half-hitch, drawing the knot as tight, firm, and smooth as possible, and cutting off the ends closely.

Leaders may be stained or not, according to the fancy of the angler—it will make no difference whatever to the fish. Leaders should be carried in flat, round, or oval metal boxes, between two layers of damp felt, to save time in straightening them by soaking or rubbing with gutta-percha.

**FLIES.**—The best "general" flies for any or all waters are the brown, red, and black hackles, to which might be added gray and ginger hackles. The best winged flies, according to my own experience, may be selected from the following list: Montreal, Polka, Abbey, Golden Dustman, King of the Water, Professor, Oriole, Oconomowoc, Silver Doctor, Grizzly King, Henshall, Queen of the Water, Red Ibis, Coachman, White Miller, and Academy.

Bass-flies are generally made too large, and tied on hooks

of too great a size. Those Trout-flies known as "lake-flies" are large enough for Black Bass, and hooks should never be larger than No. 2, even for lake-fishing, and may be as small as No. 6 for stream-fishing. Sproat and O'Shaughnessy hooks are the best. The fly should be tied with a small, twisted gut, or a gimp loop, instead of being tied on a gut-snell several inches long.

MISCELLANEOUS ARTICLES.—The other accessories for fly-fishing are the landing-net, creel, or fish-basket, fly-book, and leader-box, to which may be added hip-boots or wading-stockings for stream work.

#### HINTS AND POINTERS.

TIME.—The best season for fly-fishing in the Central and Northern states is in May and June, also September and October, and in the Gulf States during autumn and winter.

The best hours of the day are from eight to eleven in the morning, and from six to eight in the evening—the late afternoon hours, even until dark being usually the very best.

WADING.—In fishing a stream, the best plan is to wade and fish with the current, or down stream. The angler should proceed slowly and cautiously, with as little noise as possible, and should be very careful not to disturb the loose bowlders on the bottom, or stir up the sand, mud, or gravel. The more careful he is in this the more successful he will be.

CASTING.—He should cast in all directions to the sides and in front of him before moving onward. His cast need not exceed forty feet, unless the water is very shallow and clear, when it should extend to fifty or sixty feet. He should cast as straight a line as possible, letting his flies alight without splashing, and should rove them to the right and left by jerky, tremulous movements, often allowing them to sink several inches below the surface at likely spots, such as the edge of weed-patches, in the deeper water under projecting

banks or rocks, in the eddies of rocks and bowlders, in the pools above and below riffles, etc.

**STRIKING.**—He should strike upon sight or touch; that is, the moment he sees the swirl of a Bass near his fly, or feels the slightest tug, he should endeavor to hook the fish by a slight but quick drawing away of the rod, either to one side, or upward with a stiffish rod, or downward with a very supple one. This “striking” is not in any sense a sweeping jerk, or a vigorous “yank,” but is accomplished by a simple, quick turning of the rod-hand toward the angler, so as to move the fly but a foot or two along the surface should it fail to hook the fish. The slightest twitch is sufficient, with a sharp hook (and the angler should use no other), to fasten it to the jaw of a fish, aided, as it will be, by the fish itself in its resistance; and in eight times out of ten the Bass will hook himself (if the line is taut) unaided by the angler; from this it follows that the angler should always endeavor to have a straight, taut line.

**PLAYING.**—The moment the fish is hooked the rod should be elevated to an angle of forty-five degrees, and the thumb placed on the spool of the reel, so that the fish will have to contend with the full spring and power of the rod. The angler should never give an inch of line unless it is taken from under his thumb by the fish, and even then it should be given grudgingly; and it should be reeled in again whenever possible, and the fish held as before, on the spring of the rod, until it can be reeled in to close quarters, and kept as near the surface as possible.

The angler should slip the landing-net under the fish as soon as it can be done without endangering his tackle. The fight should be between the rod and the fish, rather than between the fish and the reel, for it is the spring of the rod that conquers him. When the Bass leaps above the surface of the water, let the rod straighten as he falls back, but the moment he again touches the water elevate the rod as before.

**BOAT-FISHING.**—The above directions for fly-fishing by wading a stream will answer in the main for casting from a boat on lakes or broad, deep rivers, so far as casting, striking and playing are concerned. The boat should be kept in deep water and the casts made inshore, along the edges of weed-patches, rushes, projecting banks, etc., also toward shoals, bars, etc., between the deep and shallow water.

**TACKLE.**—A somewhat heavier rod should be employed in boat-fishing, for reasons heretofore given, though in no instance should it exceed eight ounces in weight in northern waters; in Florida and the Gulf States it may be an ounce or two heavier, for the bass of that section run up to twelve or fifteen pounds or even more.

For lake-fishing the "F" fly-line is more suitable than the "G" line; and the flies may be a little larger in size, and gayer in color, especially for rough water.

#### MINNOW-CASTING.

Casting the minnow on streams or lakes is a mode of angling that is second only to fly-fishing when suitable tools and tackle are employed. For this style of fishing I devised, some twenty years ago, the rod known as the "Henshall rod," which having been extensively manufactured for fifteen years, is now so well known that it is only necessary to allude to it by name. Previous to this, long and heavy rods and coarse tackle were employed, as mentioned under the caption of "Old-Time Bass-Fishing." Casting the minnow is now, I might say, the most popular method of bass-fishing among expert anglers, for it is, unfortunately, only the minority of the angling fraternity that practice the more artistic and preferable mode of fly-fishing for the Black Bass.

**RODS.**—The rod for minnow-casting should be short, light and flexible. Many anglers use a short, natural cane rod of small caliber, but it is too stiff and inelastic for playing a fish properly, though it answers very well for casting, which,

however, is not the most important function to be considered in a rod—a long cast could be made with a billiard-cue.

I think the Henshall rod fulfills every condition and meets all the requirements for minnow-casting. For stream-fishing, either from the bank or by wading, a lighter rod may be used than for lake-fishing, though the standard rod of eight ounces and eight and a quarter feet will answer well in either place.

For the peculiar style of Bass-fishing on the reefs about the Bass Islands of Lake Erie, where a sinker of from two to eight ounces is used (as mentioned on a preceding page), I have devised a rod which is styled the "Little Giant" rod, and its specifications are as follows: The rod is made in but two pieces (of equal length) with one joint, the latter being non-doweled with cylindrical ferrules. It can be constructed of split bamboo throughout, or with ash butt and lancewood or greenheart top. The entire length of the rod is seven and one-half feet, and the weight about eight ounces, depending somewhat on the material of construction:

Extreme length.....	7 feet 6 inches.
Male ferrule of joint.....	11 $\frac{3}{4}$ inches diameter.
Extreme tip.....	$\frac{1}{8}$ inch diameter.
Length of grip (below reel).....	8 inches.
Length of reel seat.....	4 inches.

Mr. Thos. H. Chubb, of Post Mills, Vermont, made me several rods, of different kinds of wood, and split bamboo, in accordance with the above specifications (which are for an ash and lancewood rod), and they all fulfilled the conditions sought for, exactly. Mr. Chubb put this rod on the market during the past season, and I hope to see it displace the rude and uncouth and insufficient rods heretofore employed by most of the Lake Erie anglers. It is stiff and powerful enough to manipulate the heavy sinker, and springy and pliable enough to kill the fish, without being of any greater weight than the standard Henshall rod. It will also be found effective for light Striped Bass fishing on the east coast, or

wherever a heavy sinker or bait is required to be cast from a free-running, multiplying reel.

**REELS.**—Only the multiplying reel should be used in minnow-casting, and it should be the best that can be purchased for satisfactory work. There are now at least half a dozen different styles of reels made for this special fishing, which are marvels of skill, workmanship, and ingenuity. The price runs from ten to twenty dollars, and the angler cannot go far wrong whichever he may choose, but he should always remember that the best is the cheapest.

**LINES.**—The braided raw silk line is best, and the braided linen line next. Twisted lines cannot be used for casting the minnow owing to their kinking. For stream and ordinary lake-fishing, the "H" line, or, as it is styled by some manufacturers, the "Henshall" line, is the best size to use. It is smaller and more closely braided than the old "G" line, although as strong. Very long casts can be made with it, and its introduction, a few years ago, was indeed a boon for bait-fishers.

For Lake Erie fishing, where very heavy sinkers are used, the "G," or, still better, the "F" line is more suitable. Fly-lines of enameled or water-proofed silk should never be used in bait-fishing where long casts are made, owing to their stiffness and large caliber.

**HOOKS.**—The Sproat hook stands at the head of its class, with the O'Shaughnessy a good second. Most anglers employ hooks too large for Black-Bass fishing, from 2-0 to 5-0—but smaller hooks, sizes 1 and 2, are much to be preferred; they are amply strong enough, and the smaller size of the wire is not so apt to kill or injure the minnow. The fact of the small hooks of the artificial flies so frequently taking and holding the Bass, should convince even the Lake Erie anglers that they are large enough for bait-hooks as well.

Many anglers, either through prejudice, ignorance or habit, still use the cheap Kirby bend (that is, side or crooked bend)



LARGE MOUTHED BLACK BASS.—*Micropterus Salmoides*.

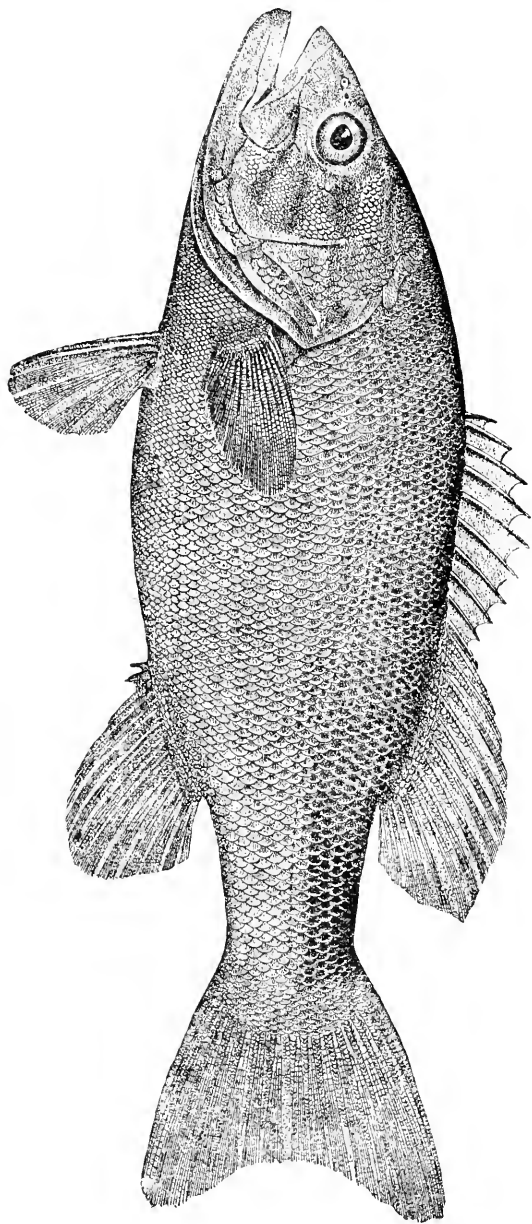

hooks, notwithstanding their inefficiency and poor quality.

The best hooks are always black or japanned—those of an inferior quality are always blued or bright.

The hook should be tied on a gut-snell for stream or lake fishing, but a gimp-snell may be used wherever Pike or Pickerel abound, as a matter of economy only.

CASTING.—The angler, then, being rigged with rod, reel and line, affixes a small brass swivel to the end of the line, and to the other end of the swivel loops on a snelled Sproat hook, which he passes through the lips of a lively “shiner,” and is ready for business or pleasure.

To make a cast he reels up the line until the minnow hangs but a foot or two below the tip of the rod; then, with his thumb on the spool of the reel, he makes a quartering cast, toward his right or left front, keeping a gentle pressure of his thumb on the rapidly revolving spool (to prevent over-running), and as the minnow reaches the water, twenty or even forty yards away, he stops the reel by a stronger pressure of the thumb.

Then, after permitting the minnow to swim about at its own sweet will for a few seconds, he reels it slowly toward him, and prepares for another cast in the same, or another, direction. The casts are to be made toward the same grounds or locations as mentioned in fly-fishing, though the minnow can be cast farther than the fly, and the chances for fish are, consequently, greater. The artificial minnow, or a small spoon, may be cast in the same manner in swift, broken water, especially about riffles and below mill-dams, with good results.

PLAYING.—When the Bass takes the minnow, the angler should keep his thumb on the reel and allow the fish to run a few seconds with the bait, and then stop the reel by a firmer pressure of the thumb, when, if the fish gives a few short tugs or jerks, he should be permitted to take a little more line, and the reel again stopped; then, if the Bass pulls

steadily and strongly, without jerking, he should be hooked by a turn of the wrist (as mentioned under fly-fishing). Very often the fish pulls steadily from the time of seizing the minnow, and goes off with a rush, when he is to be hooked at once; and, again, he often hooks himself in his wicked grab at the minnow.

The manner of playing the Bass in bait-fishing is to all intents and purposes the same as in fly-fishing.

#### STILL-FISHING.

Still-fishing is bait-fishing with minnow, crawfish, helgramite, frog, etc., from a boat or from the bank of a stream.

Almost any kind of rod or reel will answer for still-fishing, as there is, usually, no attempt at long casts. The rig varies from a cane pole or sapling without a reel, to the finest rods and reels made. The same is true of lines, for all kinds are used, twisted and braided, and of all sizes. And the array of hooks, sinkers and floats is also subject to the same variation.

The best outfit, however, for still-fishing, should be a light rod, say eight ounces, of reasonable length, a multiplying reel, a "G" or "H" braided line, a six-foot leader, and a Sproat hook, No. 1 or 2, on gut-snell. If the bottom is weedy or mossy, or if crawfish or helgramite or worms are used for bait, a small float should be employed to keep the bait from the bottom; otherwise a float is not necessary.

The angler, after casting his bait, if it is a minnow, should leave it to its own devices and allow it to swim about undisturbed, and should keep himself as "still" as possible for a few minutes, when he may move his bait to a new position or withdraw it for a new cast; but the less the minnow is pulled about, the longer it will live, and the better will be the still-fisher's chances for a bite—he can exercise his virtue of patience to the fullest extent in this mode of angling.

#### TROLLING.

Trolling is practiced from a moving boat, either with hand-

line and spoon, or with rod and reel, with minnow, small spoon, or artificial flies. Trolling with the hand-line can hardly be reckoned within the pale of legitimate angling; sometimes, as in camping, it is practiced as a matter of necessity rather than as a phase of sportmanship.

Trolling with light and suitable rod and tackle, and a small spoon, a minnow, or artificial flies of large size, is a higher grade of angling than still-fishing, and is productive of the keenest enjoyment and pleasure. Many anglers prefer it to all other methods, as there is the variety of the slowly moving boat, the ever-changing scene, and the fierce rush of the Bass when he seizes the moving lure—for he always hooks himself (if hooked at all) in this style of fishing.

Trolling with the rod is usually more successful than still-fishing, on lakes and large ponds, as the angler covers more ground, and the bait is in constant motion, and moves in a more natural manner. The angler also has opportunities to indulge more in hope and anticipation than in still-fishing, and requires less patience and perseverance and pertinacity.

But in all the methods of angling, from fly-fishing to still-fishing (excepting always the murderous hand-line and spoon) perhaps comparisons are indeed odious; for all methods have their votaries, each as enthusiastic as the other, and each, no doubt, getting as much pleasure and enjoyment out of his own method as the other in his; and, moreover, all are alike members of the universal angling guild, and however different their modes and methods, one and all can say of "angling," as did Sir Henry Wotton (who died in 1601, aged ninety-five years), that it was "a rest to his mind, a cheerer of his spirits, a diverter of sadness, a calmer of unquiet thoughts, a moderator of passions, a procurer of contentedness;" that "it beget habits of peace and patience in those that professed and practiced it."

## THE BLUE-FISH.

BY G. BROWN GOODE.

THIS fish, which on the coast of New England and the Middle States is called the Blue-fish, is also known in Rhode Island as the "Horse Mackerel;" south of Cape Hatteras as the "Skipjack;" in North Carolina, Virginia and Maryland it is sometimes known as the "Green-fish." Young Blue-fish are in some parts of New England called "Snapping Mackerel," or "Snappers;" about New Bedford "Blue Snappers;" to distinguish them from the Sea Bass, they are sometimes spoken of as the "Blue-fish." About New York they are called "Skip Mackerel," and higher up the Hudson River "White-fish." In the Gulf of Mexico the name "Blue-fish" is in general use.

*Pomatomus Saltatrix* is widely distributed in the Malay Archipelago, Australia, at the Cape of Good Hope, at Natal and about Madagascar; in the Mediterranean, where it is a well-known and highly-prized food-fish in the markets of Algiers, though rare on the Italian side. It has been seen at Malta, at Alexandria, along the coast of Syria, and about the Canaries. It has never been seen on the Atlantic coast of Europe, and, strangely enough, never in the waters of the Bermudas or any of the Western Islands. On our coast it ranges from Central Brazil and the Guianas through the Gulf of Mexico and north to Nova Scotia, though never seen in the Bay of Fundy.

From Cape Florida to Penobscot Bay, Blue-fish are abundant at all seasons when the temperature of the water is propitious. It is not yet known what limits of temperature are

the most favorable to their welfare, but it would appear, from the studies of the dates of their appearance during a period of years in connection with the ocean temperature, that they prefer to avoid water that is much colder than forty. It is possible that the presence of their favorite food, the Menhaden, has as much influence upon their movements as water temperature. Certain it is, that few Blue-fish are found on our Middle and Southern coast when the Menhaden are absent; on the other hand, the Blue-fish do not venture in great numbers into the Gulf of Maine at the time when Menhaden are schooling and are at their greatest abundance. Their favorite summer haunts are in the partially protected waters of the Middle States from May to October, with an average temperature of sixty degrees to seventy-five degrees. The Menhaden, or certain schools of them, affect a cooler climate and thrive in the waters of Western and Central Maine in the months when the harbor temperatures are little above fifty and fifty-five, and that of the ocean considerably lower.

Since Prof. Baird wrote in 1871, there has been no great change in the abundance of the Blue-fish. They are quite sufficient in number to supply the demand for them and to make great inroads upon the other fishes, some of which, like the Menhaden or Mackerel, would perhaps, if undisturbed by the Blue-fish, be more valuable than they are at present. They have now been with us for fifty years. Their numbers are subject to periodical variations, of the causes of which we are ignorant. It is to be regretted that there are no records of it in the South Atlantic States. If such existed we might, perhaps, learn from them that the Blue-fish remained in those waters while absent from the northern coasts. Only one statement is to be found which covers this period, although Lawson, in his "History of North Carolina," published in 1709, and Catesby, in his "Natural History of the Carolinas," published in 1743, refer to its presence. In "Bertram's Travels," published in 1791, the "Skipjack" is men-

tioned as one of the most abundant fish at the mouth of the St. John's River. When Blue-fish again became abundant, their presence was first noticed at the South, and they seem to have made their inroads from that direction. The Blue-fish was unknown to Schoepf, if we may judge from his work on the "Fishes of New York," published in 1787. Dr. Mitchell recorded their frequent capture about New York in 1814, though before 1810 they are said to have been unknown there. In 1825 they were very abundant, and in 1841 immense numbers were captured in the Vineyard Sound, while about Nantucket they were on the increase from 1820 to 1830. It is certain that they had not reappeared in 1822 in Narragansett Bay, for in "Dwight's Travels," it is stated that, though formerly abundant, they had not been seen in that region since the time of the Revolution. The first one which was noticed north of Cape Cod was captured in October 1837, though we have no record of their reappearance about Cape Ann before 1847.

The Blue-fish is a carnivorous animal of the most pronounced type, feeding solely upon other fish. Prof. Baird remarks:

"There is no parallel in point of destructiveness to the Blue-fish among the marine species on our coast, whatever may be the case among some of the carnivorous fish of the South American waters. The Blue-fish has been well likened to an animated chopping machine, the business of which is to cut to pieces and otherwise destroy as many fish as possible in a given space of time. All writers are unanimous in regard to the destructiveness of the Blue-fish. Going in large schools, in pursuit of fish not much inferior to themselves in size, they move along like a pack of hungry wolves destroying everything before them. Their trail is marked by fragments of fish and by the stain of blood in the sea, as, where the fish is too large to be swallowed entire, the hinder portion will be bitten off and the anterior part allowed to float

away or sink. It is even maintained, with great earnestness, that such is the gluttony of the fish, that when the stomach becomes full, the contents are disgorged and then again filled. It is certain that it kills many more fish than it requires for its own support.

"The youngest fish, equally with the older, perform this function of destruction, and although they occasionally devour crabs, worms, etc., the bulk of their sustenance throughout the greater part of the year is derived from other fish. Nothing is more common than to find a small Blue-fish of six or eight inches in length under a school of minnows making continual dashes and captures among them. The stomachs of the Blue-fish of all sizes, with rare exceptions, are found loaded with the other fish, sometimes to the number of thirty or forty, either entire or in fragments.

"As already referred to, it must also be borne in mind that it is not merely the small fry that are thus devoured, and which it is expected will fall a prey to other animals, but that the food of the Blue-fish consists very largely of individuals which have already passed a large percentage of the chances against their attaining maturity, many of them indeed having arrived at the period of spawning. To make the case more clear, let us realize for a moment the number of Blue-fish that exist on our coast in the summer season. As far as I can ascertain by the statistics obtained at the fishing stations on the New England coast as also from the records of the New York markets, kindly furnished by Middleton and Carman of the Fulton Market, the capture of Blue-fish, from New Jersey to Monomoy, during the season, amounts to not less than one million individuals, averaging five or six pounds each. Those, however, who have seen the Blue-fish in his native waters, and realized the immense number there existing, will be quite willing to admit that probably not one fish in a thousand is ever taken by man.

"If, therefore, we have an actual capture of one million, we



may allow one thousand millions as occurring in the extent of our coasts referred to, even neglecting the smaller ones, which, perhaps, should also be taken into the account.

“An allowance of ten fish per day to each Blue-fish is not excessive, according to the testimony elicited from the fishermen and substantiated by the stomachs of those examined; this gives ten thousand millions of fish destroyed per day. And as the period of the stay of the Blue-fish on the New England coast is at least one hundred and twenty days, we have in round numbers twelve hundred million millions fish devoured in the course of a season. Again, if each Blue-fish, averaging five pounds, devours or destroys even half its own weight of other fish per day (and I am not sure that the estimate of some witnesses of twice this weight is not more nearly correct), we will have, during the same period, a daily loss of twenty-five hundred million pounds, equal to three hundred thousand millions for the season.

“This estimate applies to three or four year old fish, of at least three to five pounds weight. We must however, allow for those of smaller size, and a hundred-fold or more in number, all engaged simultaneously in the butchery referred to.

“We can scarcely conceive of a number so vast; and however much we may diminish, within reason, the estimate of the number of Blue-fish and the average of their captures, there still remains an appalling aggregate of destruction. While the smallest Blue-fish feed upon the diminutive fry, those of which we have taken account capture fish of large size, many of them if not capable of reproduction, being within at least one or two years of that period.

“It is estimated by very good authority that of the spawn deposited by any fish at a given time not more than thirty per cent. are hatched, and that less than ten per cent. attain an age when they are able to take care of themselves. As their age increases, the chances of reaching maturity becomes greater and greater. It is among the small residuum of this

class that the agency of the Blue-fish is exercised, and whatever reasonable deduction may be made in our estimate, we cannot doubt that they exert a material influence.

“The rate of growth of the Blue-fish is also an evidence of the immense amount of food they must consume. The young fish which appear along the shores of Vineyard Sound, about the middle of August, are about five inches in length. By the beginning of September, however, they have reached six or seven inches, and on their reappearance in the second year they measure about twelve or fifteen inches. After this they increase in a still more rapid ratio. A fish which passes eastward from Vineyard Sound in the spring, weighing five pounds, is represented, according to the general impression, by the ten to fifteen pound fish of the autumn. If this be the fact, the fish of three or four pounds which pass along the coast of North Carolina in March return to it in October weighing ten to fifteen pounds.

“As already explained, the relationship of these fish to the other inhabitants of the sea is that of an unmitigated butcher; and it is able to contend successfully with any other species not superior to itself in size. It is not known whether an entire school ever unite in an attack upon a particular object of prey, as is said to be the case with the ferocious fishes of the South American rivers; should they do so, no animal, however large, could withstand their onslaught.

“They appear to eat anything that swims of suitable size—fish of all kinds, but perhaps more especially the Menhaden, which they seem to follow along the coast, and which they attack with such ferocity as to drive them on the shore, where they are sometimes piled up in windrows to the depth of a foot or more.

“The amount of food they destroy, even if the whole of it be not actually consumed, is almost incredible. Mr. Westgate and others estimate it at twice the weight of the fish in a day, and this is perhaps quite reasonable. Capt. Spindle goes so

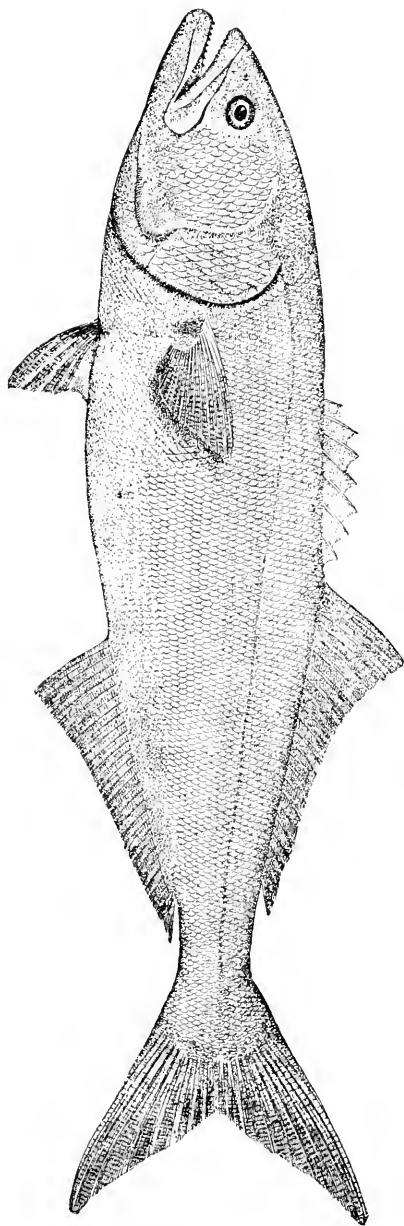

BLUE-FISH.—*Pomatomus Saltatrix.*

far as to say that it will destroy a thousand fish in a day. This gentleman is also of the opinion that they do much more harm to the fishes of the coast than is caused by the pounds. They will generally swallow a fish of a very large size in proportion to their own, sometimes taking it down bodily; at others, only the posterior half. The peculiar armor of certain fish prevents their being taken entire; and it is not uncommon to find the head of a sculpin, or other fish, whose body has evidently been cut off by the Blue-fish. In the summer time the young are quite apt to establish themselves singly in a favorite locality, and, indeed, to accompany the fry of other fishes usually playing below them, and every now and then darting upward and capturing an unlucky individual, while the rest dash away in every direction. In this manner they attend upon the young Mullet, Atherinas, etc. They are very fond of squid, which may very frequently be detected in their stomachs. In August, 1870, about Fire Island, Mr. S. I. Smith found their stomachs filled with marine worms, a species of *Heteronereis*, which, though usually burrowing in the mud, at that season swims freely toward the surface in connection with the operation of reproduction. This, like the squid, is a favorite bait for the Blue-fish; and they appear to care for little else when these are to be had. This fact probably explains the reason why, at certain seasons, no matter how abundant the fish may be, they cannot be taken with the drail or squid boat."

The Blue-fish are believed to have had a very important influence upon the abundance of other species on some parts of the coast. This has been noticed especially on the north side of Cape Cod. South of Cape Cod the small fish occur in such enormous abundance that even the voracity of millions of Blue-fish could hardly produce any effect upon them. Capt. Atwood has recorded his belief that the advent of the Blue-fish drove away the Plaice or large Flounder from those waters, not so much by their direct attacks upon

them as by destroying the squid upon which the latter formerly subsisted.

He is also of the opinion that the Mackerel, once, for a time, were affected by them. The Mackerel have since returned to those waters in their wonted numbers, but the Blue-fish are not now sufficiently plenty north of Cape Cod to interfere with them. The flight of the Mackerel is not an unmitigated evil, however, since, as Capt. Atwood pointed out, the number of lobsters for a time was very considerably increased. The Mackerel fed upon their eggs, and when they were driven away by the Blue-fish the lobsters had a better chance to multiply.

The Blue-fish sometimes make their way up the rivers to a considerable distance, the adults, however, apparently never entering the perfectly fresh water. They are found in the Potomac as far north as Acquia Creek, and also far up the Hudson; indeed, the young of the year are taken as high as Sing Sing on the Hudson and in other tidal rivers, where the water is entirely fresh.

Summing up all the evidence in regard to the periodical appearance of the Blue-fish, we find notice of its occurrence in 1672, or even 1659, and up to 1764. How long it existed in the waters prior to that date cannot now be determined. The oral testimony of Mr. Parker refers to its occurrence at Wood's Holl in 1780 or 1790; and it is mentioned by Mr. Smith as being at New York in 1800, and at Edgartown, Mass., about the same time, by Capt. Pease. Mitchell testifies to its occurrence in New York, of very small size, in 1810; and it is recorded as existing again in Nantucket in 1820, and about Wood's Holl and Buzzard's Bay in 1830 to 1831, and a little later at Hyannis. In 1830 it had become abundant about Nantucket, and in the fall of 1837 it was first noticed in Massachusetts Bay, and then year by year it became more and more numerous, until now it is very abundant. Several

accounts agree in reference to the very large size (even to forty or fifty pounds) of those taken in the last century.

Further research into ancient records may tend to throw more light on the early history of the Blue-fish, and even materially to change the conclusions already reached. It will be observed that the references to its occurrence, from 1770 to 1800, are on the testimony of aged persons who have heard their fathers speak of it, although I find no printed records anywhere in reference to it between 1764 and 1810. The rate of progression to the north of Cape Cod I have at present no means of indicating, although they probably gradually ranged further and further north, and very possibly occurred much further east than we have any mention of at present.

During the present century the maximum of abundance of these fish off the middle coast of the United States appears to have been reached from 1850 to 1860. The testimony elicited from various observers, as well as from printed records, indicates a decrease since that period, much greater in some localities than others. About New York they are said to have been unusually plenty in the summer of 1871, but farther east the diminution which had been observed in previous years appeared to continue.

Diligent research by numerous inquiries during a period of sixteen years has added little to what Prof. Baird has stated, and it may be regarded as almost certain that Blue-fish do not spawn in our inshore waters. The only important contribution to our knowledge on this subject is found in the notes of Mr. Silas Stearns, who believes that he has abundant evidence of their spawning in the Gulf of Mexico. His remarks are quoted in full below. The Hon. Robert B. Roosevelt records that he observed the Blue-fish fry less than an inch in length in the inlet of Far Rockaway, N. Y., on the 10th of July.

Little is known of their reproduction. Dr. Yarrow does

not give any facts in regard to this subject, at Fort Macon, except that spawn was seen to run out of a small female caught July 14. Dr. Holbrook is also silent on this head. Mr. Genio C. Scott says the spawning beds are visited by the parent in June, and consist of quiet nooks or bays. Mr. R. B. Roosevelt states that very diminutive young occur in immense numbers along the coast at the end of September or beginning of October ("Game Fish of America," 1862, 1859.) Prof. Baird found the young fish at Beesley's Point, N. J., in July, 1854, two or three inches in length, and more compressed than the adult; but farther east, on Vineyard Sound, although diligent search was conducted, between the middle of June and the 1st of October, with most efficient apparatus in the way of fine-meshed nets, I met with nothing excepting fish that made their appearance all at once along the edge of the bay and harbor.

According to Capt. Edwards, of Wood's Holl, a very accurate observer, they have no spawn in them when in Vineyard Sound. This statement is corroborated by Capt. Hunckley; and Capt. Hallett of Hyannis, "does not know where they spawn." The only positive evidence on this subject is that of Capt. Pease, who states it as the general impression about Edgartown that they spawn about the last of July or the 1st of August. He has seen them when he thought they were spawning on the sand, having caught them a short time before, full of spawn, and finding them afterward for a time thin and weak. He thinks their spawning ground is on the white, sandy bottom to the eastward of Martha's Vineyard, toward Muskeget.

While not discrediting the statement of Mr. Pease, it seems a little remarkable that so few persons on the eastern coast have noticed the spawning in summer of the Blue-fish; and, although there may be exceptions to the fact, it is not impossible that the spawning ground is in very early spring, or even in winter, off New Jersey and Long Island, or farther

south. It is not impossible that, at a suitable period after spawning, the young, in obedience to their migratory instinct, may move northward along the coast, growing rapidly as they proceed. This explains the almost sudden appearance of fish of five inches about Wood's Holl.

We have the statement of Dr. Yarrow that vast schools of small Blue-fish were met within Beaufort harbor during the last week in December, 1871. These were in company with small schools of young Menhaden and Yellow Tailed Shad, and were apparently working their way toward the sea by the route of the inlet. When observed, they were coming from the southward through the sound, moving very slowly, at times nearly leaving it, and then returning. The largest were about four inches in length, and others were much smaller; and as many as twenty schools were observed from the wharf at Fort Macon, each of them occupying an area of from sixty to eighty feet square, and apparently from four to six feet in depth. I would not be much surprised if these fish should prove to have been spawned late in the year, off the southern coast.

The size of the Blue-fish varies with the season and the locality, those spending the summer on the southern coast, according to good authority, rarely exceeding two or three pounds in weight, and being generally considerably less. The largest summer specimens are those found farther to the eastward, where they are not infrequently met with weighing from ten to fifteen pounds, although this latter weight is quite unusual. Mr. Snow, of Nantucket, mentions having seen one of twenty-two pounds, and others give as their maximum from fourteen to twenty. The average size of the schools in Vineyard Sound, during the early season, is from five to seven pounds. The schools, however, that make their appearance in October embrace many individuals of from ten to fifteen pounds. It is, therefore, not improbable that the difference between the first mentioned average and the last represents



the increase by their summer feeding. As already remarked, Blue-fish in the last century sometimes attained a weight of forty or fifty pounds in Vineyard Sound; according to Zacheus Macy, thirty of them will fill a barrel.

*Forest and Stream*, June 25, 1874, stated that L. Hathaway, Esq., a veteran fisherman, while fishing from the bridge at Cohasset Narrows, Mass., with rod and reel, captured a Blue-fish weighing twenty-five pounds. The largest previously caught weighed seventeen pounds. On getting back to the Carolina coast in the early part of November, according to Dr. Yarrow's statement, they are from three to five feet in length and weigh from ten to twenty pounds. What becomes of these large fish, that so few of them are seen in the early spring, it is impossible to say. If it be really true that they are much scarcer than in the fall, we may infer that their increased size makes them a more ready prey to the larger fish and cetaceans, or that they have accomplished their ordinary period of life; possibly that they have broken up into smaller parties, less conspicuous to observation, or that they have materially changed their locality. The average length of the fish that appear in the spring off the coast of Virginia and the southern part of New Jersey, according to Dr. Coues, Dr. Yarrow and Prof. Baird, is about one foot, being probably about one year old. As a general rule, those of the smaller size keep close to the shore, and can always be met with, while the larger ones go in schools and remain farther outside.

Prof. Baird obtained no very young fish at Wood's Holl in 1871; the smallest found making their appearance quite suddenly along the coast, especially in the little bays, about the middle of August, and then measuring about five inches by one and one-fifth inches. By the end of September, however, these had reached a length of seven or eight inches, and at the age of about a year they probably constitute the twelve or fourteen inch fish referred to as occurring along the southern

coast. The fish of the third year, or those two years old, are possibly the three-pound fish, while the five to seven pound fish may be considered a year older still. Accurate observations are wanting, however, to determine these facts; as also whether they require two years or three or more to attain sufficient maturity for breeding. As far as I know, there is no appreciable difference between the sexes in their rate of growth or weight, excepting that the female is likely to be a little deeper in the body.

A Blue-fish weighing one pound measures about fourteen inches; two pounds, seventeen inches; three pounds, twenty-six inches; six pounds, twenty-six to twenty-seven inches, and eight pounds, twenty-nine inches.

The Blue-fish is one of our most important of sea-fishes, and surpassed in public estimation only by the Spanish Mackerel and the Pompano. It may be said to furnish a large part of the supply to the Middle and Northern States. It is a standard fish in New York, Boston and other seaports and is carried in great numbers into the interior. Its flesh is very sweet and savory, but it does not keep very well. In the Vineyard Sound the fishermen are in the habit of crimping their fish, or killing them, by cutting their throats in such a manner that they bleed freely. Every one who has opportunities for observing admits that fish thus treated are far superior to any others. Great quantities of Blue-fish are frozen in New York for winter consumption. They are still considered unfit for food on our southern coast, and even in the markets of Washington, D. C., I have frequently been stopped by fish-dealers who asked me to assure their customers that Blue-fish were eatable. They are growing in favor everywhere, however, just as they did in Boston. Capt. Atwood tells me that in 1865 but very few were sold in Boston, and that the demand has been increasing ever since. When he first went to Boston with a load of Blue-fish he got two cents a pound for them; the second year they were scarcer

and he got two and one-half cents, and the year afterward three cents.

Within a few years the reputation of the Blue-fish among anglers has decidedly improved. Norris wrote, in 1865, that the Blue-fish was seldom angled for, and that it was not esteemed as food; in 1879, Hallock declares that the Blue-fish and the Striped Bass are the game fish par excellence of the brine, just as the Salmon and Black Bass are of fresh water.

The favorite mode of capture is by trolling or squidding—a process already described. This amusement is participated in every summer by thousands of unskilled, but none the less enthusiastic, amateur fishermen, who in their sail-boats, trail the tide-rips from Cape May to Cape Cod. Many professional fishermen also follow this pursuit, especially in the Vineyard Sound, about Nantucket and along the south shore of Cape Cod, a region famous for its swift cat-boats and fat Blue-fish.

Another mode which is growing in favor is that of heaving and hauling in the surf, which has been already described in writing of the Striped Bass. No rod is used, but the angler, standing on the beach or in the breakers, whirls his heavy jig about his head and casts it far into the sea, and having hooked his fish puts his shoulder to the line, and walks up the beach, dragging his prize after him to the shore. This is practiced everywhere on the exposed sandy beaches, such as are found at Montauk, Monomoy, Newport, and Barnegat.

Other anglers prefer to use a light rod and an artificial minnow from a stationary skiff near where Blue-fish are breaking, or to fish with shrimp bait from the wharves in quiet bays where the young "snappers" six to ten inches in length, abound. I have seen this kind of fishing at various points, from the mouth of the Florida St. John's to Nantucket.

The Blue-fish has also an important rank among the commercial species. The wholesale dealers of New York handle

nearly 4,000,000 pounds annually. The yearly consumption of Blue-fish probably does not fall much below 8,000,000 pounds, valued at \$500,000. The markets are supplied, for the most part, from three sources. Large quantities are taken in the weirs, forty or more in number, planted on the northern and southern shores of Cape Cod, in Buzzard's Bay, Martha's Vineyard, Narragansett Bay, Peconic Bay, and at Block Island. The yield of these is estimated at 1,300,000 pounds. Gill-nets on the southern New England coast are supposed to take about 3,000,000. Enormous quantities are also obtained by line fishermen about Hyannis, Edgartown, Nantucket, and Eastham, and on the shores of Long Island and New Jersey.

On the 19th of August, 1874, I saw 12,000 taken from the long pound on the west shore of Block Island.

The line-fishery is probably not less productive than the gill-netting. In 1875, we were cruising about Martha's Vineyard in the Fish Commission yacht "Mollie." Off Cape Pogue we noticed at least thirty cat-boats drailing for Blue-fish. These boats were about twenty feet in length, square-sterned and well housed over. Each carried three lines, one at the stern and two at the end of long rods projecting over each quarter. When we anchored at dusk in Edgartown harbor, these boats were coming in, dropping alongside of a New York market boat, which lay at the wharf. The bright lantern under the deck awning, the black forms of the fishermen, the busy changing of the little sails, the eager voices of bargaining, gave an impression of brisk trade. The same scene is repeated day after day, from July to October, in scores of New England seaport towns.

## THE MASCALONGE.

BY DR. JAMES A. HENSHALL.

*Author of "Book of the Black Bass," "More About the Black Bass," etc.*

**I** ADOPT the name of *Mascalonge* for the largest and best member of the Pike family as it seems to be the accepted one with the majority of angling authors and anglers.

The derivation of the name is involved in much obscurity and is ascribed to both Indian and French origin. It has been variously called Mascalonge, Muscalonge, Muskellunge, Muskallonge, Maskinonje, Maskinonge, Masquinongy, etc., etc. On the statutes of Canada it is spelled "Maskinonge," and there is a county, and I believe a village, of that name in the Dominion. Mr. Fred Mather has investigated the origin and etymology of the word to a greater extent than any one else, and he favors the Chippewa derivation of the name; "Maskinonje," as opposed to the French derivation of "Masque allonge," and its variations. But common consent and custom has decreed among the majority of anglers, as I said before, that it is "Mascalonge," and Mascalonge it will be for generations to come.

And lately there have been changes made in its scientific name, both generic and specific. For many years the Mascalonge has been known to naturalists and anglers as *Esox nobilior*—and a very good name by the way—but owing to the inflexible law of priority, *nobilior* must stand aside for *masquinongy*, a name supposed to have been given by Dr. Mitchill—but his original description cannot be found, though

it is partly quoted by DeKay in his "Fishes of New York." On better evidence, perhaps, the generic name *Esox* is now displaced by the more suitable one of *Lucius*, so that our Mascalonge must now be called *Lucius masquinongy* instead of *Esox nobilior*.

However confusing and unnecessary, as many anglers are inclined to think is this matter of changes in fish nomenclature, they are not made without good and sufficient, and in most cases imperative, reasons. It is unfortunate when an old and characteristic name is displaced by a new and, it may be, an incongruous one, but it cannot be helped in the effort to arrive at a more perfect and permanent classification and nomenclature of our fishes. In connection with this recent change in the scientific names of the Mascalonge I might mention, as a curious instance of the irony of fate, that its scientific specific name is derived from the Chippewa, and its common name from the French.

The Mascalonge, or Muskellunge as it is usually pronounced, is a magnificent fish, truly the noblest of the pike family, being the largest game-fish of fresh waters, and the only member of the family fit for the table, though it has been much overrated in both respects. Its maximum weight is forty pounds, though it has been taken weighing fifty or sixty, and Dr. E. Sterling, of Cleveland, Ohio, states that he speared one in 1844 weighing eighty pounds!

As there has always existed among anglers more or less confusion in reference to the identification of the Mascalonge *Lucius masquinongy* and the true Pike or great northern Pickerel (*Lucius lucius*), it may not be out of place, here, to say that the different species can always be readily determined by observing the scaling of the cheeks and gill-covers, and the number of branchiostegal rays, without reference to the coloration or markings of the body of the fishes.

The lower margin of the gill-cover, in most fishes, is provided with a membrane which extends under the throat, where

it meets its fellow of the opposite side in the median line. This membrane assists in closing the gill-openings; and in order that it can be open and shut readily, it is provided with a number of parallel bony rays called branchiostegals, which vary in number in different fishes. In the Mascalonge there are from 17 to 19 on each side, while in the true Pike or great northern Pickerel there are but 14 to 16, and in the eastern Pickerel (*Lucius reticulatus*) and western or Grass Pickerel (*Lucius vermiculatus*) 12 or 13.

Just back of and below the eye is the cheek (*pre-opercle*), and behind this is the gill-cover (*opercle*). In the Mascalonge the lower half of both cheek and gill-cover is entirely naked, while the upper half of both is more or less covered with scales. In the Pike the scaling of the gill-cover is similar to that of the Mascalonge, but the whole of the cheek is covered with scales, while in the eastern Pickerel and the little western or Grass Pickerel, both gill-cover and cheek are entirely clothed with scales.

I have examined specimens of the Mascalonge from the St. Lawrence; Lake Erie; Indian River, New York; the Upper Mississippi; Eagle Waters of Wisconsin; Conneaut Lake, of Western Pennsylvania; Chatauqua Lake, of Western New York; and the heads of six specimens from the tributaries of the Ohio River (one from Tennessee River), and find that there are no important structural differences; they all agree so well in regard to the number of branchiostegals, and in the squamation of the cheeks and gill-covers, and in measurements, that they must be considered as one and the same species, with a geographical variation in coloration only.

In the Mascalonge of the St. Lawrence basin the sides are covered with roundish, dark gray or blackish spots, more or less distinct, on a lighter colored, greenish or grayish ground. These spots are more pronounced in the young, being then quite dark and distinct, but in the adult they become more

diffused and of a grayish hue, though always more distinct toward the tail.

A few years ago it was thought that the habitat of the Mascalonge was confined to the Great Lakes and the St. Lawrence River and its tributaries, and that it occurred nowhere outside of these limits. As shown above, however, it is now known that its range is much more extensive. It was also supposed that in all cases the Mascalonge was always dark-spotted on a lighter-colored ground; but as already stated, while the young are always thus marked, these dark spots become more or less obscure or obsolete with age, and the largest specimens will exhibit a uniform grayish coloration, with brownish or greenish reflections. I have seen large examples from the St. Lawrence basin that were apparently identical in color with others from Eagle Waters and the Upper Mississippi of similar size and weight.

In the Pike or northern Pickerel, the sides of old and young are always covered with oval whitish or yellowish spots, always lighter than the ground color, which is usually grayish or olivaceous.

In 1820, Rafinesque mentioned two Pikes as existing in the Ohio and Mississippi basins (*Esox vittatus* and *Esox salmoneus*), growing to a length of from three to five feet, and though his descriptions are very imperfect, almost worthless in fact, I am confident that he had in mind the Mascalonge, which was more plentiful there at that time than now.

The Mascalonge, like all of the Pike family, is a typically piscivorous fish, its large mouth, jaws and tongue being armed with a terrible array of long, sharp and conical teeth of various sizes, forming veritable *chevaux-de-frise* from which there is no escape for the unlucky fish that is so unfortunate as to be seized by the cruel and relentless jaws.

Like all animals of prey, the Mascalonge is solitary in its habits, lying concealed among the water-plants and bull-rushes at the edges of the streams or channels, or along the



MASCALONGE.—*Lucius Mascalongae*.

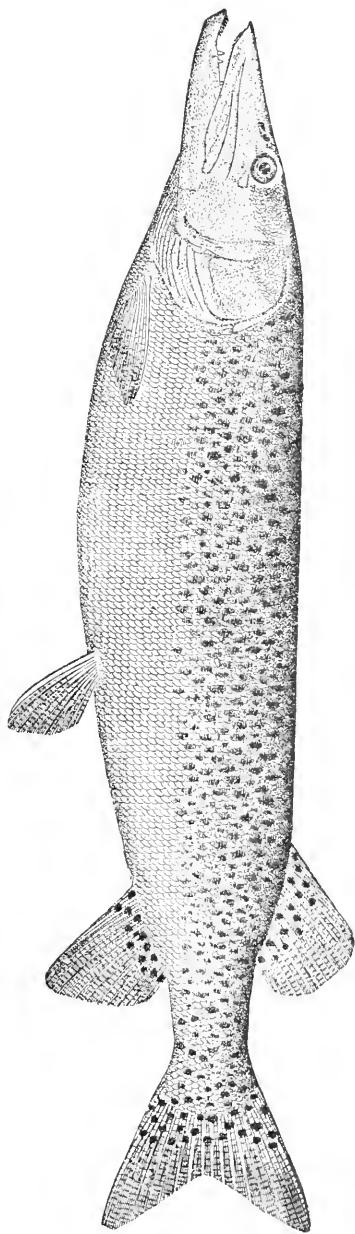

shores; and woe to the luckless fish that passes within sight of the fierce marauder, for its doom is sealed when this fresh-water shark rushes open-mouthed upon its victim with a speed and force as though hurled from a catapult.

The number of fishes destroyed by a Mascalonge during a summer is almost incredible; and they are not small fry and young fishes, such as are devoured by other predacious fishes, but those that have escaped the many dangers and vicissitudes of adolescence, and have arrived at an age when they are capable of reproducing their kind.

It is indeed fortunate for the rest of the finny tribe that the Mascalonge is comparatively a rare fish. The Mascalonge, like others of the pike family, breeds in the spring, later however than the Pike or Pickerel. All of the pike species resort to overflowed marshes and shallow, grassy streams to spawn—the Pickerel during March and the Mascalonge in May.

The Pickerel thus has a start of about two months, and no doubt the young Pickerel devour most of the Mascalonge that hatch, for the spawn in May, in such shallow water, is exposed to the ravages of turtles, frogs, ducks and coots, and most of it is doubtless destroyed. This seems to be a wise provision of nature, for as the Mascalonge spawns from 100,000 to 300,000 eggs, according to size, the result can be imagined were the same proportion of eggs to hatch and reach maturity as in the case of most other fishes.

In comparison with the rest of its family the Mascalonge is a valuable food-fish, though, as already intimated, it is much overrated, and is inferior to the White-fish, Lake Trout, Black Bass or Brook Trout for the table. It is, however, readily disposed of in the markets, and while possessing no special or characteristic flavor, its flesh is firm and flaky, and is much admired by many, but—*chacun a son gout*.

Likewise as a game-fish the Mascalonge is far superior to the rest of its family, and when upward of ten pounds its

great vitality, weight and power give it an endurance that is highly extolled by some, but it can hardly be compared to the Salmon, Black Bass, or Brook Trout for pure gameness, *per se*; that is, it does not exhibit the *finesse* and *elan* of those superb game-fishes.

A large fish may swim with a hook in its mouth for a week, but that is merely an evidence of endurance, not of gameness. And as a large Mascalonge is frequently hooked by an angler on a light rod, and the angler, being awed by the weight of the fish and its fierce rushes, is afraid to give it the full spring and power of the rod but gives line instead, and consequently plays it in a timid, half-hearted manner for an hour, or maybe two or three hours, until finally after both fish and man are exhausted, the one is gaffed and the other has just breath enough to exclaim that the Mascalonge is the "king of game-fishes."

As a matter of fact, with suitable tackle, any fish should be brought to gaff or net in a minute to the pound—that is, a five-pound fish within five minutes, a ten-pound fish within ten minutes, or a thirty-pound fish within a half-hour.

I once killed a St. Lawrence Mascalonge of thirty-two pounds in twenty minutes with an eight-ounce Henshall Black-Bass rod, and gaffed it fairly. A very expert and accomplished lady angler, the charming wife of the late Surgeon General Baxter, killed several fresh-run Salmon, on the Restigouche during the summer of 1886 (I was there the same season), that weighed from twenty-five to thirty-five pounds each, and brought each fish to gaff in from twenty to thirty minutes. And, really, ten minutes is a long time to play a fish—to many it seems an hour. •

Most Mascalonge, however, are taken with hand-line and trolling-spoon, and hauled in hand-over-hand. With a taut line and moving boat the Mascalonge sometimes leaps above the water, because it cannot get very far beneath the surface; as a rule, however, and when on the rod, it does not

leave the water, and will not leap unless forced to do so, but will endeavor to keep near the bottom, or to reach the cover of weeds or rushes.

With proper tackle the Mascalonge affords good sport, for being a powerful fish it requires much skill and judgment on the part of the angler to keep it away from the moss and grass of the bottom, or from the weeds and *algæ* of the shore, and to successfully bring it to gaff within a reasonable time.

The rod should be a good one of split-bamboo, or of ash and lance-wood, and should weigh not more than ten, or at the most twelve ounces, and should not exceed nine feet in length. A first-class multiplying reel is indispensable, with seventy-five yards of plaited silk line, No. 3, or letter E. The hook should be a Sproat or an O'Shaughnessy, No. 3-0 to 5-0, and tied on a gimp snell. The best bait is a large live minnow, or frog, either for casting or trolling, though for the latter mode of fishing a large trolling-spoon with a *single* hook may be used.

Rowing slowly and cautiously along some twenty or thirty yards outside of the weed-patches, the bait should be cast to the edge of the weeds, reeling it in again very slowly, or if the bait is alive it may be permitted to swim, just outside of the weeds, for several seconds or a half-minute before reeling. By moving along and making frequent casts the angler's chances are much better than in still-fishing; or the bait, or a spoon may be trolled along the edges of the water-plants from a moving boat. The Mascalonge bites very savagely, and should be hooked at once, before he has time to take to his lair among the weeds.

\*When a fish is hooked the boatman should pull at once for deep water, that is, away from the weeds, and he should be ready at all times to favor the angler in playing the fish by careful and judicious management of the boat. When the fish is brought alongside, the gaff should be passed under the fish, slowly and deliberately, avoiding all sudden and ener-

getic movements, and then by a quick upward and drawing motion the fish should be gaffed in the throat or breast, taken into the boat, and killed by a smart stroke on the head.

These instructions apply to the Mascalonge of northern waters, where it resorts to weedy lakes and streams; but in the Ohio and its tributaries the Mascalonge is found in the summer and autumn in the deepest holes of the streams, and they are then taken by still-fishing, the bait being usually suckers of a half-pound or more in weight. After taking the bait, the fish is given time to gorge it before striking or hooking.

It is now, however, a rare occurrence to take a "Pike," as it is called, in these waters; and the fact is talked of long afterward, and the head preserved as a trophy, while the fish itself, being esteemed a great delicacy on account of its great size and rarity, is made the *pièce de resistance* of a formal dinner, instead of being preserved for a *pièce justificative*. For five years I have endeavored to procure a specimen of this rare fish in the Ohio basin, but, beyond the head, my efforts have so far failed. No one who is so fortunate as to capture a "Pike" seems willing to part with it for love of science or coin of the realm.

---

## THE MASCALONGE IN WISCONSIN WATERS.

BY A. A. MOSHER.

The "Great Pike" of the Mississippi system of waters, like its great congener of the St. Lawrence waters, is one of the largest of our fresh-water game-fishes. It, the first named, has its equal in regard to size and game qualities in the "Barred Mascalonge" which, so far as the writer knows, has not been classified, and he would respectfully suggest

that the cognomen of this fish be "Esox Major." There is still another, locally called "Spotted Mascalonge," which is equal in size to the others above mentioned and as gamy as they are. The three great fishes belonging to the Mississippi waters will, in this article, be treated separately, to a certain extent.

"Esox Nobilior," called also "Esox Estor," will not be considered carefully, but will be referred to occasionally. "Esox Immaculatus" is found in many of the waters of the Mississippi basin but not in all. It is found in the deep holes of some of the tributaries, and especially in the waters flowing into the Wisconsin River, and in the many lakes whose outlets lead into the last named stream. And it is to those fishes that the reader's attention will be especially directed herein. In nearly *all* of the lakes in northern Wisconsin, which have outlets into the Wisconsin River, the "Esox Immaculatus," the Barred and the Spotted Mascalonge, are found in abundance—the three appearing to be inseparable or nearly so. The "Barred 'Lunge" is a large fish, and the most plentiful, generally speaking.

On the 10th of February, 1890, I measured one which in proportion was a fair specimen of the three kinds. Its length was 46 inches; weight 26 pounds; end of tail to anus, 3 inches; anal fin to root of tail, 4 inches; dorsal fin to root of tail, 5 inches; breadth of tail, 10 inches; end of nose to pectoral fin, 9 inches; between pectoral fins and lower belly fins, 13 inches; end of nose to end of gills, 12 inches; eye to end of upper jaw, 5 inches; depth widest part, 9 inches; back of head to eyes, 3 inches; spread of jaws, 6 inches; width of head, top, 4 inches. This was a fair specimen, fresh from the water. It was a female, full of eggs, which accounts for its great depth.

On the Barred "'Lunge" the bars are transverse, and commence near the back and extend to the edge of the belly, that is to say some of them do, while others go only part way,

being quite irregular all over the sides, without any apparent system; the dorsal fin is marked the same.

In the spotted variety the spots are also irregularly placed and the intervening space partially filled by transverse bars, the dorsal fin marked with distinctive round black spots, exactly the same as in the common Gar.

The "Esox Immaculatus" has no distinctive marks, the back being dark green, which color extends down the sides, fading, as it extends downward, into a greenish yellow where it blends with the white on the belly. These distinctive marks are on the barred and spotted specimens when very small, not over two or three inches long, which shows that they are different in marking, at least, from the moment of leaving the egg or nearly so. These three varieties are found together, and in fishing for them one is as likely to catch one kind as another. In size and proportions there is no perceptible difference in the three, and in the spring while they are spawning, they are found together at the same time and place, which would go to show that they are really of one family, for the spotted male is as likely to be found with a barred female as with a spotted one, or with an "Esox Immaculatus," so called. Nature is not to be disputed, and whatever she does she does correctly.

Admitting then that there are these three varieties of fish in these waters, it would go to show that, while apparently separated species, they are all of the same family. It may be that away back in the past during some very high waters, some of the St. Lawrence variety got over into the Mississippi waters and mating with *Esox Immaculatus* produced a hybrid in the Spotted and Barred Mascalonge, and that nature, for some inscrutable reason, has kept up these markings in different individuals.

Pisciculture is comparatively (in my humble opinion) in its infancy, and no doubt these facts will eventually be accounted for. We already know that fish can, and have been hybri-

dized, the offspring being fertile and partaking of the characteristics of both parents. There are undoubtedly places where the Lake Superior waters rise in some large marsh, the marsh extending for miles, the north part emptying into Superior, the south part into Mississippi waters. There is now, within a couple of miles of where this is being written, (in Northern Wisconsin) a small marsh, but a few acres in extent, the waters of which pass out of the north end, emptying into Lac Vieux Desert, the south end emptying, by a similar stream, into the Wisconsin River. Now if this happens here, it may elsewhere. While this would not, of course, be proof positive that these fish had gotten together in this way and crossed, yet it furnishes what would appear a plausible explanation of the occurrence of these several varieties of Mascalonge, and the subject is certainly worthy of investigation.

That these three kinds of Mascalonge are here and marked as above stated cannot be denied; on the other hand it can be substantiated by hundreds of good men who have caught them in numbers. I am aware that the above statement is and has been questioned by men who pretend to know, and who claim to be authorities; but facts are stubborn things, and the truth is sure to prevail in the end.

These fine fish are to be found, as soon as the ice goes out, near the shores, among the rushes and grasses, seeking a proper place to deposit their spawn. This spawn is not very glutinous (as in some kinds of fishes, the Pike, Perch or Wall-eyed Pike, for instance), but are just enough so to cause them to fasten to some weed or grass, in shoal water, where the sun's rays can warm the water and thus hatch out the fry. Mascalonge delight to lurk among weeds or in old tree tops that have fallen in the water; there they will lie, for hours, perfectly motionless. I have trolled past one, lying in a tree-top, the spoon passing within a few feet of him repeatedly, he taking no notice of it whatever until, finally, he would slip away.



When lying in this way, basking in the sun, they rarely take bait unless it be unusually attractive, but when lurking in the weeds or rushes, waiting for some living victim, they will take artificial bait voraciously

They do not seem to be so voracious however as their smaller cousin, the Pickerel, and there are times when for days together, no amount of coaxing will induce them to take bait of any kind.

When they do take it, then look out, for they strike with such tremendous force as to astonish the novice, and if he happens to have the line too loose or in any way snarled, away goes his fish, and all he has to show for it is a good scare. They are very powerful and quick, and it is no child's play to handle a large one. Even the experienced angler will have his hands full, and will be called upon to exert all his skill to save the monster, and even after he has apparently given up, lies on his side or back, is hauled alongside for the gaff to finish the work, he frequently gives a tremendous surge and away he goes for a final run that will test the tackle to its utmost.

This noble fish is well entitled to the name of the "Tarpon of the North," and will in time be so called. He is a grand fighter, and never gives up until he is actually dead.

Talk about Black Bass, or any other kind of fresh-water fish! There are none that can compare with this leviathan of our inland waters, for pluck and gaminess.

West of the Mississippi those fish do not seem to be so common, though I have been told that in Elbow Lake, in the Lake Park region of Minnesota, they are numerous and grow to a great size. How true this is I cannot say, but that there are large fish in that lake, similar to the Mascalonge, I have no doubt.

These grand fish are found in Northern Wisconsin in the following waters: Pelican Lake, Tomahawk and adjoining lakes, Arbor Vitæ, St. Germain lakes, Trout Lake, the Eagle

Waters, a chain of lakes through which Eagle River passes, Three Lakes and others connected therewith; Buckatarbon Lake Lac Vieux Desert,\* Big and Little Twin Lakes, Long Lake, Sand Lake, and various others, many of which have not yet been explored or named. In nearly all these lakes the three specimens are found.

To the angler this region is a paradise. Abounding as it does with beautiful scenery, ever-changing and always wild, it will for years to come be a favorite resort for lovers of nature.

During the year of 1889 some 400 Mascalonge were taken from Lac Vieux Desert, of sizes ranging from three pounds to forty-two and one-half pounds, and there seems to be no diminution in their numbers. This lake is about five miles long and from one to three miles wide. In early spring the best place to seek these fish is very close to the shore, so close in fact that one can use but little line and where the guide can push along with the paddle, by resting it on the bottom.

My experience in trolling teaches me that a long line out is unnecessary. From fifteen to twenty feet is enough, in fact. I have caught large ones within six feet of the boat. A good way is to go out where the weeds or lily-pads are thick, and cast with a spoon or large shiner. Lac Vieux Desert is quite a shallow lake, being only twelve feet déep in the deepest place, and is very weedy. It is the head of the Wisconsin River. In some of the other lakes where the water is clear and deep, these fish seem to be just as numerous as in Vieux Desert, so it seems they are equally at home in widely different waters.

These fish ought to be protected, and why some of our enterprising Fish Commissions have not taken steps to propagate them, artificially, is not known.

My experience and observation lead me to believe that it

---

\* Pronounced "View Desare."

would be an easy matter to propagate them, and it is to be hoped that it may be tried at an early day.

In June, 1888, I was at Big Twin lake, where I had caught several large Mascalonge, and being informed that Lac Vieux Desert was a good lake for these fish, I took Fred French of Three Lakes and went over to investigate.

We got there too late for much fishing that day, so we waited till morning. We started out before breakfast and trolled along the west shore, just outside of the rushes, for about two miles, catching an occasional Bass, Pike or Pickerel, and when we got near what is locally known as "Lunge Point," all at once there was a fearful rush and commotion, and we knew we had a big one.

Down he went, taking line rapidly, until he must have found the bottom in forty feet of water. Then up he came clear out of water, his glistening sides sparkling in the rays of the rising sun, shaking his ponderous jaws in a mighty effort to get rid of the cruel barb. He was kept well in hand and not allowed a foot of slack line. Three times he vaulted clear out of the water, and fought like a tiger while in his element. The struggle was a long and determined one, but he finally gave up, when Fred gaffed him and lifted him into the boat. There he lay in all his beauty, his magnificent sides rising and falling as he sought to breathe in the lighter element. He had an ugly look in his eyes, that warned us to keep clear of his rugged fangs. After admiring him some minutes I told Fred this was glory enough for an early morning, and we bent our oars for camp. At the house our prize tipped the beam at thirty-three pounds, good, honest weight. After breakfast we started out again and before ten o'clock returned with six Mascalonge, weighing seventy-two pounds, one Pickerel of twelve pounds, one Large-mouth Bass, six pounds, one Wall-eyed Pike of nine and a quarter pounds, besides various other smaller fish, making a total weight of one hundred and twenty pounds. I was tired out and said to the guide that I had had sport enough for one day.

The rig used for this work was an eight-ounce Goodridge combination rod, a "G" linen line, to a common multiplying reel, and a number eight Skinner spoon. The line was a new one, but it was so frayed when we quit work that it was taken off and is still in my tackle box, kept as a memento of one of the grandest pieces of sport I ever enjoyed.

On the fifth of August, 1887, Mr. L. Thomas came to me and said, "Don't you want to go out and catch a 'Lunge," and I said that was just what I did want, and we were soon on the water with his son Louis as the third member of the party. It was about four P. M. when we threw out our lines. Mr. Thomas had a hand-line, a number 4 Hill gold bait, a double gang of hooks number 8, and a large chub minnow hooked to the upper gang. I had my old rod, a small line, a double Skinner spoon, one number 7, the other number 8, with a double gang of number 8 hooks and a large chub on upper gang.

We had proceeded but a short distance when Mr. Thomas had a strike, and after the usual course of maneuvering we took his victim in, started on again and soon it came my turn. I had a lusty strike, and after playing after my fish some time and the weeds being thick we went ashore and slid him out on the stones very nicely. Mr. Thomas now changed with his son and took the oars. In a short time Louis had a strike, and as his fish proved to be a large one we went ashore again, at the same place, and landed this specimen without trouble. This last one weighed thirty-eight pounds, and his stuffed skin is now on exhibition in the city ticket office of the M. L. S. & W. Ry. at Chicago. We started again and soon I got another large one, but he got into the weeds, in spite of all I could do, and I lost him.

We then started for home, and just before we got to the rushes, Mr. Thomas, who had the line again, had a heavy strike but he missed. He said to his son, "Turn right around; we'll go over that ground again and get that fellow

yet." After passing over the spot twice and getting no strike I proposed giving him up, but Mr. Thomas who had had more experience than I, said, "No; we'll try him once more," and as we passed over the spot a third time the old Esox took my spoon with a terrific splash.

"There you have him," said Thomas. I at once realized that, and I had him sure enough. After a long and hotly contested fight we took him in and went ashore. The four fish weighed, respectively, thirty-eight, thirty and one-half, twenty-nine and one-half, and thirty-three pounds, and a prettier sight I never saw—those noble fellows lying side by side. To say we were proud would illy express our feelings.



## THE BROOK TROUT.

BY F. H. THURSTON.

THE Spotted Brook Trout, *Salvelinus fontinalis*, is one of the most beautiful fishes in existence. It belongs to the division of the Salmon family known to the English as "Chars," a group confined for the most part to fresh-water brooks and streams, and, according to Professor Goode, distinguished from the true Salmons by a peculiar arrangement of teeth on the vomer, and also by their very small scales, and usually by numerous crimson or orange-colored spots, which are especially conspicuous in the breeding season. Its home is between latitudes  $32\frac{1}{2}$  degrees and 55 degrees, in the lakes and streams of the Atlantic water-shed, near the sources of a few rivers flowing into the Mississippi and the Gulf of Mexico, and in some of the southern affluents of Hudson Bay. Its range is limited by the southern foothills of the Alleghanies, and nowhere extends more than three hundred miles from the coast, except about the Great Lakes, in the northern tributaries of which Trout abound. At the south it inhabits the head-waters of the Chattahoochee, in the southern spurs of the Georgia Alleghanies, and tributaries of the Catawba in North Carolina. It also occurs in the Great Islands in the Gulf of St. Lawrence—Anticosti, Prince Edward, Cape Breton and Newfoundland.

The shape, size and coloration of the Speckled Trout vary much according to the conditions of food and water under which it exists. There are waters in which it is so nearly black

as often, except upon close examination, to be mistaken for the chub, or other fish. In some waters, as for example those of the tributaries of Torch Lake, in Michigan, the Trout which were planted some years ago, still retain to some extent their distinctive characteristics of shape and color, and may often be distinguished from the native Trout. The following extracts are from "Goode's American fishes."

"When Trout have no access to the sea, they still contrive to avoid a change of temperature with the seasons. In mid-summer they lie in the bottoms of the lakes cooled by springs, in the channels of streams, or in deep pools, lurking behind rocks and among roots. In spring and early summer they feed industriously among the rapids. At the approach of cold weather in the autumn they hasten to the clear shallow water near the heads of the streamlets. It is at this time that they deposit their eggs in little nests in the gravel, which the mother-fish have shaped with careful industry, fanning out the finer particles with their tails, and carrying the large ones in their mouths. After the eggs are laid, the parent fish covers them with gravel, and proceeds to excavate another nest. The same nests are said to be revisited by the schools year after year.

"The spawning season begins in New England in October, continuing from three to six months, and during this period the fish should be protected by stringent laws. Mr. Livingston Stone observed that in his ponds at Charleston, N. H., spawning began October 12th, and ended early in December; at Seth Green's establishment near Rochester, N. Y., it began on the same day and continued until March. At the former station spring water, with a uniform temperature of 47 degrees, was in use, while at Caledonia the eggs were kept in brook water, which is colder in mid-winter, retarding development."

There seems to be some uncertainty regarding the duration of the spawning season. In Northern Michigan I have taken



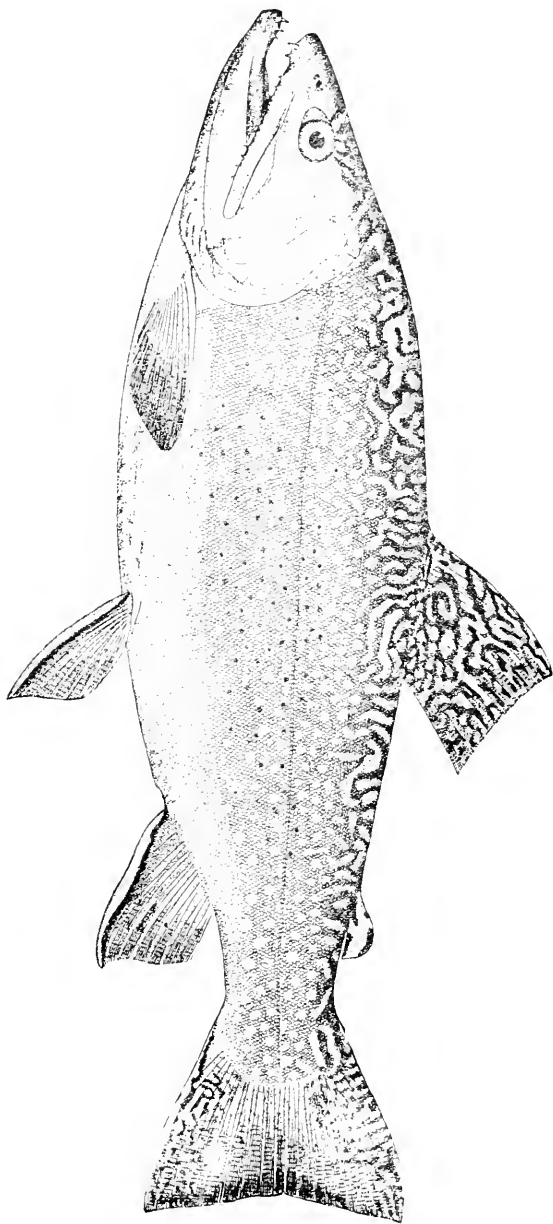

BROOK TROUT.—*Salvelinus fontinalis*.

Trout containing well developed spawn, in each of the summer months. Such cases are not infrequent, and I believe that similar observations have elsewhere been made.

Trout are cold water fishes, and according to Green, cannot thrive in water warmer than 68 degrees Fahr. They are at their best at the approach of winter. They rarely exceed two or three pounds in weight, except in a few favored localities. I remember long ago an offer of P. T. Barnum of a prize for a four-pound Spotted Trout, but none was forthcoming. In the Rangeley Lakes they have been taken weighing eleven pounds or more. One taken in 1867, in Rangeley Lake, weighed ten pounds after three days captivity, and was thought by experts to have lost a pound and a half in transit from Maine to New Jersey, where it died. Its length was thirty inches, and its circumference eighteen.

"The Nipigon River claims still heavier fish. Hallock mentions one said to have weighed seventeen pounds."

According to Agassiz, these large Trout may have reached the age of one or two hundred years. "The rate of growth is determined by the amount of food consumed. Some two-year-old fish weigh a pound, some half an ounce, as Mr. Stone's experience shows."

Endless are the dissertations which have been written in praise of the Speckled Trout and its pursuit "with the angle," but no one has as yet succeeded in so portraying this sport and its objects as fully to equal the remembrances which live ever in the memory of an old and successful Trout-fisher. For him there is no sport like Trout-fishing, and though seduced perhaps from time to time by the lordly Salmon, the silvery Tarpon, or other of our notable game-fishes north or south, he ever returns with renewed zest to the pine-shadowed lake or brawling mountain stream—the scenes of earlier triumphs; and as he sees the bright hues of a ten-inch Trout gleaming through the meshes of his landing net, he once more says, as often in the past: "Well, there's nothing like Trout-fishing after all."

Should any doubt that the Speckled Trout is fully entitled to distinction as emphatically a gentleman among fishes, the following quotation from Mr. James W. Miller should forever set the question at rest:

"His whole wooing is the most polite attention and the gentlest of persuasions. He moves continually to and fro before his mate, parading his bright colors, while she rests quietly, with her head up stream, vibrating her fins just sufficiently to keep her from floating down. At Waterville, Wisconsin, I had the opportunity of watching their habits.

"A pair of large Trout had selected a spot near the bank of the stream, where the water was about ten inches deep. The female had fanned the gravel with her tail and anal fin until it was clean and white, and had succeeded in excavating a cavity. They were frightened away as I came to the edge of the bank. Concealing myself behind a willow bush, I watched their movements. The male returned first, reconnoitering the vicinity, and satisfying himself that the coast was clear, spent a half-hour in endeavoring to coax the female to enter the nest. She, resting half-concealed in the weeds, a few feet away, seemed unwilling to be convinced that the danger was gone; and he, in his full, bright colors, sailed backward and forward from the nest to his mate, rubbing himself against her, and swimming off again in a wide circle close along the bank, as if to show her how far he could venture without finding danger. She finally entered the nest."

Trout are also pugnacious at times, and have been known to engage in desperate conflicts with each other, sometimes resulting in the death of one or both of the combatants.

Many and various are the haunts of the Spotted Trout; from the pebbly shallows of the crystal lake, or the tranquil reaches and foamy pools of the tumbling river, where it is a joy to cast the fly, to the cold spring brooks far up on the mountain side, hidden by rocks and brushwood, and sometimes flowing unseen for many a rood, through subterraneous

channels. Again the home of the Trout is in a rushing river, sometimes many yards in width, and bridged throughout by a tangled wilderness of cedar trees, some standing, but many of their trunks lying at every possible angle, and in all stages of decay. Through this series of obstructions the patient angler works his way, sometimes losing sight of the stream while he hears it gurgling beneath the mossy log on which he finds his footing, then, a few feet further on, he sees below a black pool of icy water, perhaps not three feet across, but of unknown depth. Here, as in the rare glimpses of running water on the semi-subterranean mountain streams, the fly is useless.

Some think that the skilled fly-fisher never uses bait. He does, an' he be wise. Few are older or reckoned better anglers than Dr. William C. Prime, who says:

"The true angler is not confined to fly-fishing, as many imagine. When the fly can be used, it always should be used, but where the fly is impracticable, or when fish will not rise to it, he is a very foolish angler who declines to use bait."

Many good and sportsman-like Trout-fishers there are, who when circumstances render such effort feasible, will use nothing but the fly, but who from the nature of the streams among which they are compelled to seek their pastime, find it often advisable to resort to bait.

Bait-fishing, in the words of Genio C. Scott, "is of all field sports the parent of more patience and eager perseverance than any other;" and Thomas Tod. Stoddart, writing of summer fishing in Scotland, offers to prove "that worm-fishing for Trout, when the waters are clear and low, the skies bright and warm," "requires essentially more address and experience, as well as better knowledge of the habits and instincts of the fish, than fly-fishing."

True is the saying: "It is not all of fishing to fish," and while there is a mild pleasure in casting a fly over the roof

of a sixteen-story flat, and a deep satisfaction in making the longest cast at an angling tournament, there is yet no feeling which can take the place of that in the mind of the tired and muddy angler, who as he wends his way homeward in the gloaming, is reminded by the weight of his creel, of the various incidents of weather, stream, rock, tree, flower, bird, animal, insect and fish which together have combined to make up his successful day's fishing.

The Brook Trout! How the memories of early and later days throng upon the mind of a "down-east" angler at the name. I remember as it were yesterday, when, a little boy, and listening wide-eyed to the converse of my elders, I heard such stories of great strings of beautiful Trout brought home from the brooks as set my blood on fire to emulate these achievements. Would I never be big enough to go Trout-fishing?

There was upon my father's farm a meadow through which ran a sparkling brook with pebbly bottom. As I one day approached this little stream, I saw a fish dart under a log which lay buried in the water. It must be a Trout, and here at last was my opportunity. I had a small silken line and several hooks, which had been given me by my big brother in Boston; and rapidly as possible, I hastened home, cut a stout apple-tree wand, and rigged my tackle. Placing upon the hook a worm, I hurried to the haunt of the Trout. I had heard enough of the *modus operandi* of the sport to keep out of sight; and carefully—*very* carefully, I approached the brook. My heart thumped loudly against my ribs as slowly the bait settled upon the water—I couldn't do it better to-day, though nearly fifty years have passed since; like a gleam of light, the Trout darted across the pool, and straight there was a thrilling tug upon the line. The lithe sprout bent double to the weight of the fish, for it was a good half-pounder; and when at last he lay quivering among the clover-blossoms, there was in all the northern land no prouder boy than I.

In those days we used hickory rods—poles we called them; and one merit at least they had—they never broke. The line or hook might fail at sorest need, but for the pole, you could surge and strain your best, and never fear consequences. It was with one of these machines, wire-ringed and copper-ferruled, that I first cast a fly. The rod weighed several pounds, and casting was no boy's play; so that I soon wearied of the fruitless labor, and seating myself upon a stone, allowed the fly—I remember that it was small and red—to drift upon the surface of the current while I sought in my pocket for my luncheon. As I lazily watched the fly descending into a foamy pool just below my seat, there was a gleam and a mighty surge. I grasped the rod—too late, the fish had detected the imposition and vanished. No further thought of luncheon. I fished that pool for hours, but no rise rewarded my efforts. Next morning I was again upon the spot, having meanwhile obtained another fly—a black hackle. This I added to my cast, and very carefully dropped it upon the surface of the brook. There was no rise, but as I was retrieving the line, and before I knew what had happened, a large Trout was fast to the hook. How I managed to save him I can hardly say, but save him I did, and ran exultant home. I caught no Trout as large as this in many after years.

When I was young, an old friend and experienced fly-fisher once told me that the talk about the importance of having the flies fall like thistledown upon the water was all moonshine. Said he: "If you get the fly on the water at all, and the Trout wants it, he'll take it."

I cannot tell among what sort of Trout my friend had gained this experience; but in my own I find that the more lightly my flies descend upon the surface of the stream, the more likelihood is there of a rise.

There is no such mighty mystery in fly-fishing, more than in rifle-shooting; and while superior skill in either is confined

to the few, the main principles of each may be learned [not mastered] in a few minutes.

In my judgment, the most important point in Trout-fishing is gained by him who has acquired the correct method of giving what is termed the "strike." It should be prompt, yet delicate—prompt because the fraction of a second of lost time may mean the loss of your fish, and one has to see but once the suddenness with which any distasteful morsel is ejected some inches from the mouth of the Trout, to realize the importance of promptitude in responding with the turn of the wrist to the first gleam that denotes a rise.

It is well to have the knack of making long casts, but they are seldom requisite to success, particularly in stream-fishing. With a short line you are more fully master of the situation, and the most of the Trout are taken within thirty feet. A long cast however, sometimes enables one to reach points otherwise unattainable, but in practice nobody casts a fly eighty or one hundred feet. That is casting, not fishing.

When fishing for Trout, keep your eye on the stream. If you see a rise, mark the spot, but be not in haste to reach it. A master of the angle is seldom in haste. When near enough, cast your fly a little short of the point you have noted.

Then, if necessary, cast a little further, and if your cast is well chosen and well made, the fish will probably show itself.

If you are wading, you cannot be too deliberate or cautious in your movements, and by observing such a course, you may sometimes even pass through a school of Trout without sensibly alarming them.

Study the insects along the stream, and make up your cast accordingly, if practicable. Mr. H. Cholmondeley Pennell advocates the use of three typical flies for Trout, to the exclusion of all those now in use. Never having tried them, I cannot say as to their efficiency, though I had hoped to test them during the present season, but a malady of the eyes has prevented

my giving them a trial. They are green, brown and yellow, and have certainly a most attractive look, as tied by Mr. Charles F. Orvis from whom I obtained some specimens.

A good assortment of flies is desirable, especially while on a journey; but the fly-book of an expert is more notable for the selection of the flies which it contains than for their numbers, and seldom will he wet more than a half-dozen in a day's fishing.

It is well to take a few lessons from an accomplished fly-tyer, and to carry materials for extemporizing a cast which, though not scientifically tied, may yet prove attractive to the denizens of the brook.

In casting across a stream, which, where practicable, is the better way, do not hurry, but draw the flies slowly toward you, lest the Trout be alarmed. And when the fish is hooked, especially if he be large, do not seek to land him hastily, unless compelled by the surroundings to do so, lest haply he break away. The most that escape are lost through undue haste.

When Trout have become "educated," and sometimes where they have not, the smallest flies on number 12 to 18 hooks, with gossamer gut, will prove more attractive than most others, and such are extensively used upon the much fished streams of England, as also upon those of New York and others of our states which have for years been resorts for anglers. The gossamer gut, however, deteriorates in quality in a short time, and is not ordinarily requisite in the capture of our American Brook Trout. The drawn gut is best preserved by being kept wrapped in oiled paper.

The rods now in favor are very much lighter, though more effective, than those formerly in use. A click reel—not a multiplier—and thirty yards of water-proof line (the tapered lines are best) will be found most effective. And it is well that the line should fit the rod. As truly said by Mr. Orvis: "A heavy line on a very light rod would be bad; a very light



line on a heavy rod would be worse. I find many are inclined to use too light a line, supposing the lighter it is, the less trouble there will be in casting it. This, I think, is an error. It is impossible to cast well against or across the wind with a very light line; and very light lines do not 'lay out' as accurately as do the heavier ones."

I think that the lighter rods are growing in favor. Good work has been done with three to five ounce switches in waters adapted to their use, but for swift streams they seem to me to be unsuitable, at least for the larger fish. For "brushy" streams, a stiff rod is best.

Many Trout which would otherwise be lost may be saved by the use of a landing-net. If the fish is lifted from the water by the hook, and the tackle be fine, it is liable to be broken.

Neither a low barometer nor an electric storm are conducive to success in fishing. In choosing the day, as in selecting and proving the tackle, experience is the road to success. A change of weather is often the prelude to good luck in fishing. A thorough angler will seldom use a leader that has not been tested, and it is stated by an eminent authority, Mr. Henry P. Wells, that "a leader which will endure five pounds steady strain with a spring balance, will, when backed by the elasticity of a fair rod, resist the utmost effort of the largest Trout that swims the Rangeley Lakes."

Test, therefore, the gut you use, and never bend it when dry, or allow it to be stepped upon at any time.

I shall not attempt to offer many suggestions as to the proper flies to be used for Trout. Their name is legion, and each has its advocate. There are some, such as the coachmen and professors, that have a place in every fly-book. For the Rangeley, I suppose that no single fly will take as many Trout as the Parmacheene Belle, though as it was not invented when I fished those waters, I cannot say from experience.

It is always safe to have plenty of hackles of different colors—the red is a favorite with many anglers—and of small,

plain colored flies with light wings. These will, in the New Hampshire streams, in those of Northern Michigan and in many other localities, often serve better purpose than larger and gaudier flies.

Trout may be taken after dark by the use of the white miller and some other light colored lure. In some waters they will rise at gaudy flies during the night, and it is stated that even the black hackle has proven attractive in certain localities.

The scarlet Ibis, though very taking in some waters of the Eastern and Middle States, seems less attractive in the North and West. It is well to carry a few flies with more or less blue in their make-up. If your flies are sufficiently attractive, the Trout will rise to them, even in mid-winter. Make the best selection in your power, and be not in too great haste to change your cast. If after a fair trial, you find that the fish will not rise to the fly, fear not to use bait; remembering that there are few indeed of our most accomplished anglers, who do not thus when other methods fail. The more attractive baits include minnows, minnows' tails, red worms, white grubs, the various larvæ to be found in decaying wood, grasshoppers and the throat or belly fin of the Trout itself. Fly-fishing is not commonly successful until the spring is well advanced. Never think that you know a brook until you have fished it thoroughly, as the best Trout are sometimes taken in the most unlikely spots.

One September day, more than thirty years ago, I found myself at old Dan Quimby's, on Rangeley Lake. Few anglers were at that time in the habit of visiting those waters.

In fact, I myself was there more for the purpose of hunting than fishing. Large game, however, was scarce, much more so than at the present time, and I consequently gave the more attention to the Trout.

My first essay was at the mouth of a cove, where my guide had a boat in readiness. On our way, he had looked care-

fully to the right and left, to find, as he said, "some-thin' fer bait. I want ter find a potridge, ef I kin, though a red squir'l 'll dew."

As he spoke, a fine cock grouse rose near us and settled on a branch, to be the next instant beheaded by the rifle of my companion.

"I'd a goo' deal ruther hev a potridge 'n a squir'l or a meat-hawk," he said as, cutting from the leg of the luckless bird a liberal portion, he proceeded to impale it upon the point of a number 6 Limerick. Next he drew from beneath some bushes a seasoned juniper pole, some seventeen feet in length, attached thereto a "C" size line, spat on the bait, unmoored the boat, and was ready for business.

We pushed off a few yards and anchored. It was late in the afternoon, a southerly breeze just rippled the water, while the dull, gray sky, and the mournful sighing of the wind among the pines bore token of a coming storm.

Aleck dropped his bait into the water, while I cast my jay-fly and gray hackle toward the mouth of the brook, drawing them slowly across the ripples, but at first without success.

"Hello!" said Aleck, "I've got the fust one."

His fish was a large Trout, but broke away as he attempted to raise it from the water; and almost at the same instant, three or four Trout seemed to rise at once at the jay. One was fast, and another seized the hackle instanter. Aleck dropped his pole and looked on with much interest as they dashed from side to side, I playing them, and they often playing each other; for when one sounded, the other was pretty sure to shoot upward.

"Well," said the guide, after a long pause; "I never see a pole buckle like that 'n afore."

This was an English rod of ash and lancewood, which I had bought since leaving home, in a tackle store in Boston. It was a very light, and for those days, a very expensive one, the best the vendor had. It weighed thirteen ounces, and

cost nearly five dollars. Please remember that this was almost thirty years ago. That rod was well worth its price, and money wouldn't buy it, for I have it still. It is good even yet, although the butt, after many years of faithful service, took such a "set" that I replaced it with another; thereby reducing the weight of the rod some three ounces. I seldom use it, but the many memories which attach to this old rod are such as I can associate with none other in my collection.

The Trout were soon tired out, and duly transferred to our basket, where, lying on a bed of fern, they furnished food for pleasurable anticipations for the remainder of the trip. They weighed respectively one, and one and a quarter pounds, and were much the same with a score of others taken that evening on my rod. I am, however, obliged to confess that Aleck beat me, not in numbers but in weight. I had, however, returned to the water several half-pounders, while Aleck kept all his fish. His catch aggregated thirteen in number, one of which weighed over four pounds.

The wind arose as we left the lake, and a drizzling rain set in, which with occasional intermissions continued throughout my stay.

During an interval of sunshine, I rode over to the mill-dam, where I found a native, equipped with a small rifle and a "jigger." He had shot a "spruce grouse," the plumage of which was nearly black; and had captured a Trout weighing some three pounds. He looked with disfavor upon my flies, and said that they were well enough to play with, but wouldn't fetch the Trout.

I cast my flies upon the surface of the foaming current, when they floated downward to the edge of a little eddy, and disappeared from view. There was a savage strike, and a great Trout dashed half-way across the stream and sprang into the air. He was fast to the jay-fly, and I at once renewed a resolution I had previously formed, but neglected to carry out—

to use but one fly on my cast where the big fellows were known to exist.

The largest Trout I had ever hooked was fast—fast and furious. I did not time the struggle, but it was long, and my rod was tried to its utmost capacity. When at last the Trout found a hiding-place behind a rock near the shore, and sulked at the bottom, the native, who had looked with much interest upon the contest, approached and offered to “jigger” the fish; which courtesy I curtly declined, not liking the look of his weapon.

The Trout again roused himself for the fray, but he was wearied, and before many minutes I succeeded in bringing him to the net. His weight was about three pounds, and he was the largest fish which I took at any time upon the Rangeley lakes.

I heard talk there as elsewhere, of the extraordinary size of the Speckled Trout there taken, but at that time no competent guides were to be had, and I did not then know, what has since proved to be the fact, that those large fish are not surface-feeders, and it is believed that they do not rise to the natural fly.

The Parmacheene Belle, which is one of the most taking flies for that region, was, I understand, suggested by the appearance of the belly-fin of a Trout—a bait much in use with many fishers. The Grizzly king, Montreal, Silver Doctor, and other gaudy flies, are taking at different times. Large hackles, gray and brown, are often attractive, but in my own experience, the jay-fly has proved the best. When a fly is taken by the larger of these Trout, it is always when below the surface of the water. Cast a straight line, let the fly sink a foot or two, then draw it toward you with short pauses, finally retrieving quietly to make another cast.

When the ice goes out of the Rangeleys, the Trout are not commonly taken until the temperature of the water and that of the morning air are nearly the same. In hot weather,

the fishing is at the mouths of streams and in swift water. Trolling is common, earlier, with a six-inch chub—a deadly, though objectionable method. The employment of more than one hook is prohibited by law. As the water grows warmer in June, the Trout seek the shallower points near shore, there feeding upon the various insects. Good sport may then be had, but in the heats of summer they again resort to the cooler depths of the lakes, and not until September do they again take to the pools.

The known points where the best fishing occurs are uncertain and variable, and the stranger must trust to his guide for these, as for other elements of success. Attempt to guide him and he will serve you well, but let him see that you acknowledge his superiority in his calling, and you will have your reward. He will tell you to be on hand early, for the first rays of the sun are often death to your success.

It is my belief that the Trout caught in those waters run as large, and probably larger, than those of years ago, and at present, nearly one-eighth of the catch is land-locked Salmon, which have been planted in the lake, and the sport is the greater for the very uncertainty whether the next fish to rise will be Trout or Salmon.

My fishing on the Rangeleys was prosecuted under serious discouragements, from the continual storms, and I soon left the lakes for that season.

The next September found me in Piscataquis County, on my way to the Moosehead region, but chancing to meet a young fellow whose knowledge of the country and its sports seemed nearly exhaustive, I changed my plans, and we hunted and fished together that fall. He was something of a character, being the son of a wealthy man, of literary tastes, who had brought his library into these forests years before; but losing his property through investments in unprofitable lands, had died, and of his fortune, little but the library was left. The son had read it all, and his tenacious memory was

stored with the oddest literary jumble I had ever known. He was continually breaking out in quotations, mostly from the poets; so that he was commonly known as "Old Poetry."

Old Poetry and I started out one fine morning for the woods. He had told me of a stream flowing from a spring high up on the mountain side, which he had crossed in winter, when in pursuit of a moose, and pointed out far to the northward, the gleam of the cataract, almost hidden in a dense spruce forest.

"I always thought," said he, "that I'd go there again, and catch some fur. There's some little ponds there, and Trout till you can't rest, and where you find Trout a-plenty, there's always mink, sure. But it's a mighty hard road, and I never got to trap there yet."

This spot was our objective point, and heavily laden as we were, with provisions, et cetera, we made but slow progress. Indeed, had I known beforehand of the nature of the country we must traverse, I should hardly have undertaken the trip.

Pausing at a brook, Poetry detached from his belt a silver cup, and gave me to drink. The elegant form and chasing of the vessel attracted my attention, and he told me that it was a parting gift from a New York gentleman with whom he had often hunted in the past. "And ah," said he looking fondly at the battered treasure,

"My eyes grow moist and dim, to think of all the vanished joys that danced around its brim."

'Twere long to tell of the weary two days tramp which brought us at length to the verge of a rocky cliff, where we threw off our packs and looked down into a clear pool of water, many feet below, and some fifty yards in length, which filled the rocky chasm, and fairly swarmed with Trout.

Verily, it was well worth the weary journey we had made, but to see the schools of fish. The afternoon sun lighted

up the rift, and the brilliant colors of the fishes shone out in full display, as back and forth beneath our stance they flashed and glided past. I had not then, nor have I since, seen such a magnificent fish preserve, albeit scarce noted by eye of angler till we reached the spot.

Taking his axe, Old Poetry proceeded to build a camp, while I made up a cast of hackles, gray, brown and red, and sent them downward from the rocky shelf on which I sat. They were instantaneously seized by as many Trout, and I found that the fish were larger than I had thought. To land them was the difficulty, and this was at last accomplished with the loss of one, but the school had departed.

They were not of large size—few being over a pound in weight, but their numbers seemed endless.

I went to the head of the pool where a fall of three or four feet poured in, and taking off two of my flies, secured a Trout at nearly every cast, until a halt was called, my assistance being required in arranging the roof of our bark camp. I hung my string of Trout upon a stub, some five or six feet from the ground and obeyed the summons. Returning in a quarter of an hour, I found to my surprise that the most of my fish had disappeared, while those remaining were all more or less mutilated. Calling the hunter in my turn, his practiced eye took in the situation at a glance.

"The spoiler hath been here," he said, and "it's a cussed mink. I'll set a 'kilheeg' (log trap) for him after supper."

This was done, and thoroughly wearied with our long tramp we lay down on our beds of fir boughs before the fire, and soon slept the sleep of the weary.

At daybreak Poetry was up, and inspecting his trap, in which he found a half-grown mink. "'Twasn't you, you little cuss," he said, "'twas your mother, and I'll have her 'fore night;" and sure enough he did.

It was still too early in the season to find the furs in prime condition, and the hunter passed the most of his time in



making a thorough exploration of the surrounding country, with a view to future operations. We remained three days at this delightful spot, and but for the Trout, our provisions would have been exhausted before the end of our stay. It is interesting to note that while at first the Trout would take readily any fly in my book; before we had left, they had become notably suspicious, and on the morning of our departure, would rise to nothing but black and brown hackles.

The Rangeleys have perhaps held their own as well or better than any other of our waters long famous for Trout. Of the many lakes or streams of the forests of Northern New York, there are few, indeed, which now yield to the angler the same returns as in former years. This is also true of Pennsylvanian waters. The most of the streams of New England, where unpolluted by the refuse from factories, are favorable to the breeding of Trout, and there is still opportunity to make fair creels in many of them, as for example in New Hampshire, the tributaries of the Pemigewasset all furnish Trout, though seldom of large size.

East of the Mississippi no better Trout-fishing can be found than in the streams emptying into the northern portion of Lake Michigan and in the tributaries of Lake Superior, among which the Nepigon, for the size of its Trout, justly claims the precedence. To fish that stream, however, it is necessary to obtain the permission of the Government authorities. For the rest, the experienced angler has learned not to expect too much, whatever the name or reputation of the waters he may fish, and should he return only fairly successful, from an angling tour in the vicinity of Lake George, the Saranacs, or others, long favorites of the tourist, the beauties of the scenery everywhere presented to his gaze, will, if he be a genuine lover of nature, go far to compensate him for his lack of sport. If it is but the Trout he seeks, this paper was not penned for him.

On a fine August day, some years ago, a party of three,

consisting of two young collegians and myself, started from a small saw-mill, situated on a large brook which rippled and flashed down a mountain side in one of the forests of New Hampshire. We were in quest of a lake from which flowed the stream above mentioned, having been told that there the Speckled Trout did much abound. Our informant, however, a young farmer of the neighborhood, cared but little apparently for the Trout, but was extreme in his laudation of the size and quality of the "Bull-pouts" which likewise inhabited Pennyroyal Pond, for so this lake was named. The miller had shown us one end of a trail which he said would lead to the pond by a more direct route than we could have by tracing the course of the stream. We however learned to our sorrow that several logging roads and other trails branched from or intersected the one we desired to follow, so that we missed the proper course and were at last only enabled to find the object of our search by climbing a tree, and, by compass, taking the bearings of a granite peak at the foot of which I knew the lake to be situated. At last, near sunset, we reached the shore, and seating ourselves upon the most comfortable log we could find, gazed out upon this little mountain tarn.

It was situated in a bowl-shaped depression among the hills, and a dark spruce forest rose from shore to summit in smooth and regular sweep. To our right was the gray granite peak which had been our guide, reflected from the clear waters of the lake, which here and there were dimpled by rising fish or the trail of the summer duck. It was a beautiful scene, and my companions, who had stood the tramp pretty well, were enthusiastic in its praise. Never before had they been so completely isolated from civilization, and to them nearly everything we saw was a novelty. Having rested, two of us set to work to prepare a camp, while the other, after jointing his rod, walked down to the lake in order to catch some Trout for supper.

By the time we had roofed the camp and had the fire well under way, the angler returned. "Look here," said he. "I thought you said those were Trout out there rising in the lake."

"So I did," said I.

"Well, they are nothing but Bull-pouts."

I am afraid that I did not succeed in repressing the smile which rose to my lips as I replied: "Bull-pouts don't rise in that way. How many did you catch?"

"Seven."

"Did you keep them?"

"No. I thought we were going to have Trout for supper. Think you, we left the classic hills of Harvard to initiate our first camp amid these granite solitudes by a banquet on Bull-pouts? Perish the thought!"

"Perhaps it would have been safer to keep the Bull-pouts, as we are all rather hungry, but we will see what can be done."

Preparing my tackle I walked along the shore near the foot of the granite cliff where the water was deep, and a tree had fallen into the lake. Standing alongside a large boulder I cast my hackles toward the tree-top, and the first cast fastened an eight-inch Trout. I continued my fishing for half an hour, by which time enough had been secured for present needs, and we returned to the camp-fire.

During our meal, Rob, who had watched my fishing with interest, inquired the reason why he had only caught Bull-pouts, instead of Trout as he had expected; to which I replied that he had selected for his fishing a little muddy cove which was the natural home of the Bull-pout, and added that fishing as he did with bait, he would do better to seek for Trout among the ledges. My advice was followed, and before night closed in, we had taken several more Trout—the two young fellows with bait, and I with white miller. We walled in with loose stones a little pool in which to keep our fish alive, and at last, thoroughly wearied with the toils of the

day, we replenished the fire, for the nights were chilly in those mountains, turned in and slept soundly.

At dawn we were astir, our breakfast was soon dispatched, and rods in hand, we sallied forth in quest of new achievements. The weather was wild, windy, and unfavorable for fly-fishing, and when at noon we assembled for dinner, it was found that the catch of the bait rods had the advantage in both numbers and weight, whereat my friends rejoiced. And while dinner was in progress I noted occasional innuendos concerning the inferiority of flies as compared with bait. None of the Trout thus far taken, were more than a pound in weight, but my friends were very desirous that some of the big fellows of which they had heard might fall victims to their skill. I remarked that we had already corraled five times as many Trout as we could use, and that most anglers would be well satisfied with such a catch, whether size or numbers were considered. But the big Trout still formed the burden of their conversation.

After an hour's rest we walked along the shore in the direction of an old catamaran or raft formed of two logs about twenty feet long, which had been placed side by side, and rudely connected by cross-bars and withes. Some discussion was held about the propriety of putting out into the lake upon this raft, but the gusts which swept the surface seemed to render such a voyage inexpedient. During the conversation I had advanced to the end of the catamaran which lay off shore, and was casting my fly toward the center of the lake, while Joe, with an improvised handspike inserted beneath the raft, essayed to move it from its resting place. Much to his surprise the crazy fastenings of the logs gave way, and the outermost one on which I was standing, intent upon my cast, aided by an inopportune puff of wind, swung outward and away from shore. I did not realize my situation until a warning shout caused me to turn my head—too late.

"Holy Moses!" shouted Joe. "What'll we do now?"

The log began to roll, and in order to maintain my upright position, I was obliged to seat myself astride upon it with my legs in the water. And thus I slowly drifted out into the lake. The consternation of my friends for my mishap soon gave way to mirth, as they saw me comparatively master of the situation, and those irreverent youngsters opened a fire of remarks more or less nautical and tantalizing in their character.

"Ship ahoy." "Where are you bound?" "Hard a-lee."



"Hard down your helm." "Give her the sheet and let 'er howl," etc.

I made no response, but continued casting to the right and left, as I drifted onward. The talk of large Trout had induced me after dinner to change the red hackle I had used as a stretcher fly for a large blue-jay. I had no expectation of a rise so far from shore, but to my surprise, when almost in the middle of the lake, the jay was taken and by a very large Trout. It was a battle royal which followed, but by the

time the log had drifted ashore the fish was conquered, and when at last we grounded, and disembarking from my uncomfortable craft I waded to dry land, I led the fish into a shallow pool of water where he was safe. I was soon rejoined by my companions who had hurried around to meet me, meanwhile watching the contest with much interest.

"Ah," said Joe, as, panting and breathless he gazed upon the magnificent fish, "Isn't that a *haut credo?*"

The fish weighed upward of three pounds, and was by far the largest taken during our stay. For still another day we whipped the waters of the little lake, and before our departure on the following morning, we opened our corrals, and gave liberty to nearly two hundred of our bright-hued captives. Our tramp homeward was without incident, and we parted next day at the railway station. Since that trip we never meet without some allusion to the big Trout of Pennyroyal Pond.

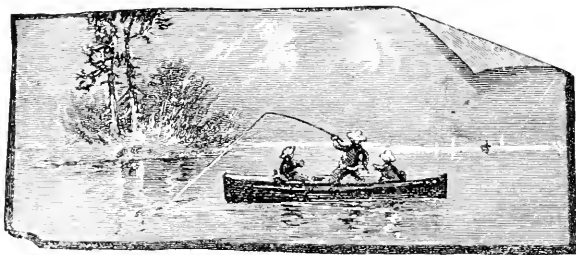

## TROUTING ON THE NEPIGON.

BY W. H. H. MURRAY.

"HELLO!" I exclaimed, as I glanced at the time-table, which, in the form of an illustrated itinerary, lay on the table. "We must be nearing the Nepigon."

"The Nepigon!" exclaimed the judge, with the ardor of a sportsman. "More monstrous Trout have been caught in the Nepigon than in any other river on the continent. I have friends who firmly believe that it is one of the four sacred rivers that flow out of paradise."

"I think I would agree with them," I laughingly returned, "if they would make their paradise include not only the river, but the lake in which it heads. For if Lake Nepigon was not in paradise it was a great loss for paradise." And as I spoke, the train struck the bridge which stretches across the noble and noted river, and as it was gliding smoothly on it slowed, and suddenly stopped.

"Oh, oh, oh!"

"See, Tom, look!"

"Jones, where are you?"

"Fo' de Lawd, Mars' Judge," exclaimed the waiter, "you two gemmen git to de hind end ob de kyar, ef you wants ter see what's gwine on down dar in dat ribber."

The excitement was contagious, for the car was full of shouts, cheers, and exclamations. The judge rushed down the aisle to the rear of the car.

"Great heavens!" he exclaimed, as he reached the platform. "Look at that!"

A hundred feet below us flowed the noble current, a deep, wide, strong-moving mass of water. Here and there an eddy marked it with its huge circumference. But in the main it moved downward toward the great lake, shining in full view, as a river flows between widened banks and with plenty of room. In the middle of the river, nearly under us, was a canoe with an Indian at either end, and a man in a velveteen jacket standing in the center. In his hands was a rod, and the tip of the rod was doubled backward nigh to the reel, the ringing whirl of which filled the air. His pose was that of an angler who had struck a fish—a big fish—a fish that is fighting him gamely and stubbornly, and which he is resisting with the cool, determined skill of a veteran of the rod.

“What a picture,” exclaimed the judge “Gad! what a picture.”

Well might he exclaim, “What a picture!” The wide river; the island-studded lake, into which it emptied; the lofty banks; the great dome of blue sky above; high over the stream, as if hung in mid-air, the long train, every window filled with heads, every platform crowded with forms, the engineer, an angler himself, hanging out of the cab, swinging his hat; below, the canoe, the ochred Indians, the bent body of the angler, the swaying, quivering, doubled-up rod—what a picture.

Suddenly, we, who were looking, saw the rod straighten. Some of us knew what it meant. The judge clinched my arm, and in an instant out of the water came the Trout, mouth open, fins extended, tail spread.

“Jerusalem!” screamed the judge. “He’s a twenty-pounder!”

Dear old judge, thou hast the true angler’s eye—that eye which enlarges and multiplies by a happy trick of vision, not merely the size of the fish, but the enjoyment of the soul. Ay, ay, it was a twenty-pounder to both of us old sports for the instant, and if the envious scales did shrink the noble



form to shorter and thinner proportions, it could not rob us of the ecstasy of our first estimate, thank heavens!

And the fight that followed—what words may set it forth? O anglers, shut your eyes, and see and hear it from behind your closed lids. Call memory to your aid—the memory of the sternest fight you ever fought, of the swiftest torrent, of the wildest pool, of that favorite rod smashed to splinters, of paddle broken, of the “biggest fish that ever swam,” lost or won. Stop, I say, and from behind closed lids see all this, and you will see what we saw under the great bridge over the Nepigon on that bright June day.

Whoever the man in the velveteen jacket might be, he was of the right sort—an angler of whom anglers need never be ashamed; for as he fought that fish he gave us such an exhibition of angler's fence as ranked him one of the best that ever fingered reel. An eight-ounce rod against an eight-pound fish, a strong, deep current, and a Nepigon canoe. Grant anglers such conditions, and how many shall make a winning fight?

Twice the huge fish broke water, and twice the long train cheered him to the echo. The judge was wild. Each time the fish broke the surface, he fairly jumped! He leaned far over the rail. He swung his hat, and when the monstrous Trout broke the surface the second time, he yelled:

“Save him, save him, and I'll nominate you for the Presidency.”

Once the great fish for an instant burst through his opponent's guard. Once, I must confess, my heart sank within me, as a stone sinks to the bottom of a well. When he was a hundred feet from the canoe, the rod nearly tip and butt, and the silk line stretched through the air like a wire, the fish doubled and lanced backward like a flash. We saw his wake—that sharpened wedge of water which anglers dread—and as he went under the canoe, and, in the stillness, that had come to us, we heard the line rattle on the bark, a groan

escaped the judge. He rolled his eyes upward, and roared as if stricken with pain: "Great Scott! he's lost him!"

But the fish was not lost. The angler recovered his advantage, and fought the fight to the end, skillfully and coolly.

The fish was deftly gaffed by one of the Indians, and quickly lay on the bottom of the canoe. The Indians seized their paddles, and the light craft glanced toward the western bank, the man unjointing his rod as the boat shot along, and in a moment they came panting up the embankment with a huge hamper in their hands, in which, amid flowers and grasses, lay six other Trout, nearly as large as the one we had seen captured.

Seldom is such a reception granted to a mortal as was given to the man in the velveteen jacket. The engineer cheered and swung his hat; the fireman, sooted and begrimed, capered and danced on the coal-box like an electrified imp; the passengers yelled; the ladies fluttered their handkerchiefs; while we anglers of the party fairly took him in our arms and lifted him onto the platform, where the judge enfolded him in an embrace which the stranger will never forget—a hug such as an old angler gives a younger one to whom he is indebted for an exhibition of skill which has brought back to his memory all his own former victories, and proved to his anxious soul that the gentle art is not being neglected.

Never fear, never fear, dear old judge, that the art of all arts will be lost, or the skill of trained finger and eye be forgotten. We shall pass; but still the streams will flow on, the pools will go round, and the Trout love the coolness of springs and the rush of swift waters. The boys will grow up like their sires, loving water and sun, loving forest and rapids. With brown faces and hands, and with eyes keen as ours, they will stand where we stood, they will boat where we boated, they will camp where we camped, and the dead ashes of fires that we kindled they will kindle to new life again. The gentle art will live on, while nature is nature and mankind is man.

## THE LAKE TROUT.

BY LUTHER PARDEE.

THE Lake Trout, or *Salvelinus namaycush* as he is more accurately described in the language of the scientist, is, according to Professor Goode, of the Smithsonian Institute, "a non-migratory species, inhabiting the chain of Great Lakes, from Superior to Ontario, as well as Lake Champlain, and many other smaller lakes of the United States and British America. \* \* \* The usual type to be found in the Great Lakes is brown or gray, dappled with lighter shades of the same general tints. \* \* \* Every lake of Northern New York and New England has its own variety, which the local angler stoutly maintains to be a different species from that found in the next township. Some are as black as a tautog, some brown with crimson spots, some gray, with delicate reticulations like those of a Pickerel. The usual type is brown or gray, dappled with lighter shades of the same general tints. Naturalists have been sadly mistaken by their protean modifications. The '*Namaycush*,' of the North, the 'togue' or 'tuladi' of Maine and New Brunswick, \* \* \* the Trout of Winnipiseogee and that of the Adirondack lakes, have each been honored with a distinct binominal. The angling authorities still refuse to admit that the Lake Trout of the east is identical with the Mackinaw Trout or *Namaycush*, supporting their views by accounts of their different habits. A careful study of the dead fish is sufficient, however, to convince a trained observer that there are no structural characters by which these different forms may be separated into species.

"The *Namaycush* reaches its greatest perfection in the northern parts of Lakes Huron and Michigan, and in Lake Superior, where it is quite generally known as the Mackinaw Trout. In New York lakes the same species occurs, being known by the names of Lake Salmon, Lake Trout, and Salmon Trout." This by no means, however, exhausts the list of names with which he is enriched, for in Canada and Maine he is known as "tuladi," "longe" or "lunge," in Vermont as "togue," and he will respond, if you call him Red Trout, Gray Trout, Forked-tail Trout, Great-lake Trout, or Lesser-lake Trout.

The scientific description of this fish is given as follows, by Professor David Starr Jordan, of the Indiana State University:

"*Salvelinus namaycush*"—(Walbaum)—Goode—Mackinaw Trout, or Great-lake Trout, also locally known as "longe," "togue," "Salmon Trout," etc. (the latter name to be discouraged, as it is applied in England and elsewhere to very different species, as *Salmo fario*, etc.)

"(A). Characters shared with other Chars, but not with the species *Salmo*:

"Vomer boat-shaped, the shaft much depressed; no teeth inserted on the shaft; scales very small, and somewhat imbedded, about 200, in a longitudinal series; fins moderate, the anal rather short, 9 to 11 developed rays; the caudal forked in the young, becoming nearly truncate with age. Branchiostegals, 11 or 12; gill rakers, 16 to 20; pyloric cæca rather few and large. Sexual peculiarities not strongly marked; the breeding males with the premaxillaries lengthened, and with a fleshy projection at the tip of the lower jaw. Coloration dark, without black spots; sides with round spots of reddish or grayish; the head, back, dorsal and caudal fins usually marked with wavy lines.

"(B). Characters distinguishing *S. Namaycush* from other Chars:

“Vomer with a raised crest, armed with strong teeth extending backward from the chevron, but free from the shaft; a band of strong teeth on hyoid bone (base of tongue). Head very long, somewhat flattened above, its length averaging nearly one-fourth the total (exclusive of caudal); body rather slender (varying much with food, etc.), its greatest depth averaging little more than length of head. Space between eyes about one-fourth length of head. Mouth very large, the length of its cleft averaging about half of head, the maxillary extending much beyond eye. Teeth very strong. Adipose fin small. Caudal fin always more or less concave or forked.

“General color dark gray—more or less olive-tinged in life, the color varying with circumstances from very pale to almost black. Upper parts, especially top of head, with vermiculations of darker olive or gray. Dorsal and anal fins reticulate. Sides with round pale spots, usually light gray or somewhat yellowish, said to be sometimes tinged with reddish. Lower fins less ornate than in the brook Trout; usually nearly plain.”

The Lake Trout is essentially a deep-water fish, and as soon as the temperature of the water changes in the spring, he leaves the surface where he has been for a short time, and seeks the more congenial “deep sea.” It is doubtless largely owing to this fact that so little is known of him as a game fish, since, in order to catch him in the deep waters where he is usually found, such a clumsy form of tackle has ordinarily to be used as almost deprives the process of any pleasure or sport. Yet, while it is eminently true that he lacks the verve and dash of the Trout or the Bass, he has a manifest and dogged determination all his own, that marks him as being very different from the sluggish Pickerel.

In our western cities, especially those bordering on the Great Lakes, his form is very well known, being seen in every fish-stall, and being highly esteemed for its toothsome quali-

ties; but the method of his advent there is one that concerns us not, connected as it is with the vulgar and mercantile gill and pound nets. Our acquaintance with him is to be rather that which rises from first having ceremoniously "dropped him a line," and receiving his reply in *forma propria*, before we proceed to seek his more intimate acquaintance. But let me tell you, brother angler, an' you know it not already, that if you will have true sport with him, and win his profound gratitude for being so handsomely "taken in," you will always see to it that your tackle shall be as light and delicate as the spider's gossamer, and that the barbarous "trolling-line"—the hand-line of commerce—shall have no place in your well chosen stores. Listen to what "Timon Tyde," who, as is well known, "wait(s) for no man," says of the practice:

"Did it ever strike you that trolling with a hand-line wasn't real sport? It is a good deal like towing on a canal, with a strong team of mules and a heavy line; the boat hain't got no chance. Neither has a fish, with two hands going one over the other, taking in string like a revolving drum. I used to do it, but I got ashamed of it. You don't get the sport out of a fish on a hand-line that you do with a light rod. A man doesn't get the credit for being a great fisherman because he brings home a boat-load of fish. Ask the boatman who pulls him around for his opinion of his man. It's either, 'he's a daisy,' or, 'he wanted all the fish in the lake.'"

Be generous with your opponent! let it be give and take; give him at least an equal chance with you; let him test to the full the spring of your slender rod, the strength of your delicate line, and the glittering vanity of the whirling spoon; and then, when you come forth proudly victor, as in sooth you will, if you are a true disciple of the gentle craft, there will be no tinge of regret in your rejoicings, nor suspicion of sordid motive attaching to your doughty deeds. And then, too, you will know, as then only you can know, how much of genuine sport there is in angling for this hardy prince of

LAKE TROUT.—*Salvelinus Namaycush.*

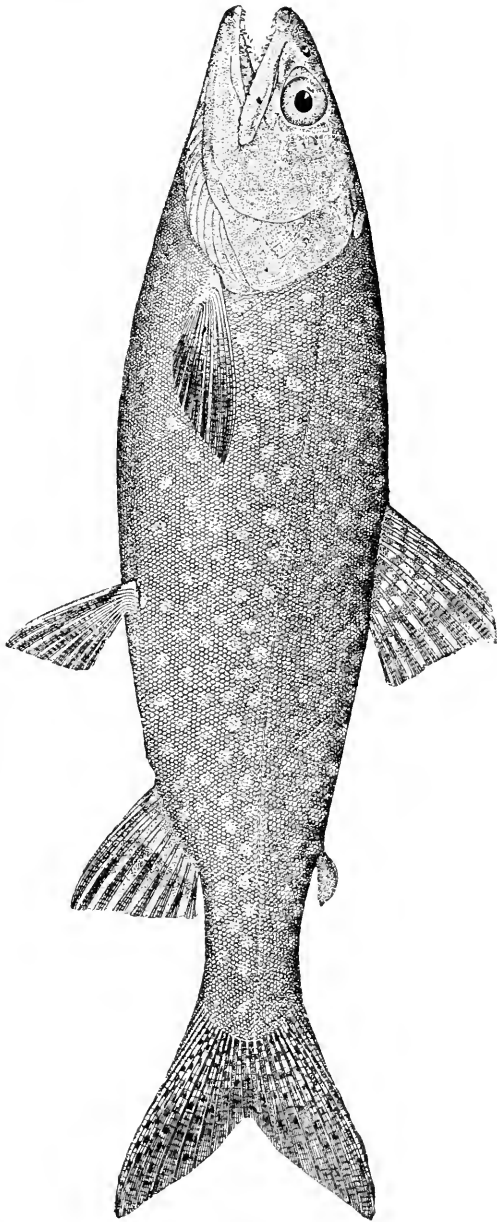

the hidden realms of Neptune. But I am not yet through with the prosaic part of my tale, and must fain detain you longer, oh patient follower of these lines, while I sketch for you, *currente calamo*, some facts 'tis well to know, before we go a-fishing. And first, to quote from kindly Seth Green, of fragrant memory:

“There are no fish which require a more uniform temperature of weather, and when they cannot have access in the warm summer months to the deep water—where the temperature is the same the year around, where it is not affected by any of the changes of the atmosphere in either winter or summer, death will ensue from suffocation.

“Many times in fishing for Salmon Trout in summer, when I have hooked a Trout in the deep water, he would come for a distance without much struggling, but as he neared the surface where the temperature began to affect him, he began to suffocate, and his struggling greatly increased.”

Cheney says: “The Lake Trout inhabits only lakes containing deep, cold, clear water, and they are the first of all the Salmons to succumb in waters of high temperature. Seth Green made an experiment to determine this question, using California and Kennebec Salmon, California Trout, Grayling, Brook Trout, and Lake Trout. The Lake Trout died first, and before the mercury reached seventy-four degrees; the Brook Trout next, and then death ensued in the following order: the Grayling, the California Trout, the Kennebec Salmon, and, last, the California Salmon.”

This characteristic of the Lake Trout will account for the fact that in all save the Great Lakes, fishing for him is either confined to a limited time in spring and fall, when the surface water is very cold, or else the tackle that is used must be such as will take him at a depth of from forty to eighty feet, whereby the element of sport is largely eliminated from the act of fishing.

The time of spawning of the Lake Trout is in the middle



fall, when they leave the deep recesses of the lakes, to seek the shoals for this purpose. The proportion of spawn deposited is said to be about 2,000 ova for every pound in weight of the female. The same uncertain chance attends the hatching of the eggs as is seen in the cases of so many other fish. If they escape the eyes of other spawners, it is only to fall a prey in large numbers to the hungry and greedy prowlers that are always on the lookout for just such delicious *bonnes bouches*. Once past this fateful time, however, the *Namaycush* grows lusty and strong, and increases so mightily in size and weight as almost surpasses belief, although his average weight is only about six pounds. In the Great Lakes, the captains and mates of the schooners that trade from port to port give startling records of catches made from the decks of their vessels, and prove them by the fish. Thus Mr. Cheney reports that in 1882 his brother saw on the deck of a schooner at Muskegon, Michigan, nine Lake Trout, the smallest of which weighed eighteen pounds. (I thank thee, O Cheney, for leaving to the glorious uncertainty of conjecture the weights of the other eight!) The same writer is authority for the statement that Dr. E. Sterling of Cleveland, Ohio, saw a Lake Trout taken at Thunder Bay, Lake Huron, that weighed seventy pounds. My own companion of the yachting trip, described later in this paper, "the captain," on one of his trips caught a monster, *horresco referens*, so great as to defy description! I can only report that he encased him tenderly in icy bands of swathing, and sent him to the steward of his club here in Chicago, with a preceding note of explanation that he sent him "a fish" for the club; whereat the lordly steward tossed high his head, and curled his patrician nose in scorn at thought of "a fish" supplying even for a single day the gastronomic wants of his many guests. Yet tradition has it that there was enough and to spare, so that perchance even the minions had taste of this wondrous fish. The record of the smaller lakes also shows numerous well authenticated

cases of fish caught that weighed from twenty-five to forty pounds.

The food of our Mackinaw friend is varied. He is not over-scrupulous, yet he has a leaning to nice, juicy, tender young White-fish, while not despising the grosser *pabulum* that frisks from time to time invitingly before him. He is withal a good hearty eater, which is much to his credit, and in our favor. It is not uncommon for a Trout to swallow a fish nearly as large as himself.

As regards the *game*ness of our subject, much has been said on both sides. He has been persistently vilified by some, and as earnestly championed by others. I am glad to see that Mr. A. N. Cheney, than whom I know of no more practical expert, in all matters pertaining to this fish, classes him as distinctly a *game* fish. I cannot do better than to quote his own words:

“There is not such a vast difference between the play on the hook of the Lake Trout and the Speckled Trout. The latter at the time of taking a fly will jump above the surface of the water, which the former will not do in taking a bait, or subsequently, and the Speckled Trout swims near the surface when hooked, while the Lake Trout bores downward, but there is not sufficient difference in their tactics when hooked to cause the *Fontinalis* to stand with the elect, and the *Namaycush* to herd with the goats.

“Lake Trout fishing is becoming more and more each year a favorite mode of angling, particularly for the invalid, the indolent, and those whose heads are whitened with the frost of many winters. The latter, seated in an arm-chair in the stern of a broad, safe boat, can be rowed over the trolling ground and all fatigue avoided, except that bravely encountered by the boatman for three dollars per day. Often the tug of a ‘laker,’ (out of courtesy we call it a ‘strike’) arouses the veteran in his easy-chair from a dream of wading mountain brooks—before his joints became so stiffened, and his

steps so feeble—and casting his fly for a smaller and more beautiful fish. Good anglers may dread a worse fate than becoming confirmed 'boat fishermen' for Lake Trout."

Personally, I must say that I had a leetle rather fish for Bass or Trout, but I would respond just as readily to a well-backed invitation to go again to "Kitchi-gummi" after lakers, as I would to one that took me among the black flies and "no-see-'ems," and mosquitoes, and underbrush, that are the well-nigh inseparable attendants of the Speckled-sides and Bronzebackers. *Namaycush* is a good, sturdy, persistent fighter. What if he does lack the vim and *abandon* of the others? What if, instead of going off in a hundred unexpected, bewildering dashes, he fights it out on one line, however long or short the summer. It is a question of degrees and kind of gameness only. Let the Tarpon fisher assert that there is but one game-fish in the world and that—his fish! We refuse to believe him; nor will we allow those who have not tasted the steadfast joys of Lake Trout fishing to underrate those qualities that make him dear to us.

The methods of taking the Lake Trout differ so materially, and are so much more varied in the smaller lakes, that for the purpose of this paper it will be necessary to give them somewhat in detail. Here, also, I am indebted very largely to the freely granted courtesy of Mr. A. N. Cheney, and to the results of Seth Green's labors. The latter used for deep-water trolling, which is decidedly the most sportsmanlike method, a gang of hooks, which he describes as follows:



SETH GREEN'S GANG.

"There are several methods of trolling for Salmon Trout, both with trolling-spoon and gang. Nearly all trollers of

experience have their own peculiar ways of arranging their tackle, and handling, and while they all differ more or less in minor details, they are practically the same. I will describe the tackle with which I have met with the best success.

“The angler may use a hand-line or a rod, but the latter is the better, because its spring helps in playing the fish when struck. The rod line used is a hawser-laid Striped Bass linen line, size No. 9. These lines usually come in 600-foot lengths, but it is rare that more than 300 feet are used or required. Before using a new line, the stretch should be taken out of it as much as possible, else it is very difficult to strike a fish. In fishing, the line should be paid out slowly in order to prevent fouling, which the position of the sinker might otherwise cause. The leader, nine feet in length, is of single gut, one size finer than salmon gut. It is tied in two sections, with a swivel three feet from the lower end, and with another swivel on the gang of hooks. A six-ounce sinker is tied on the end of the line, and the leader is fastened to the line four feet above the sinker. It is also advisable to place another swivel on the end of the leader, to be attached to the line, and this swivel should play on a round glass bead, which is kept in place by a knot on the under side. The object of the bead is, in case the sinker should strike a hill, and roll, it will do so without tangling the leader.

“The hooks are flatted O'Shaughnessy's No. 8. These are the only hooks that I have found which will stand the strain. There are two sets of three each, and a single lip hook in a gang; and they are tied on, back to back, in the shape of a grapnel. For a minnow five inches long, the middle set of hooks is placed three inches from the upper hook, while the former in turn is two inches from the lower set. If the minnow is longer or shorter, the gang must be correspondingly proportioned, care being taken always to place the hooks in the same relative distances as above noted. The middle set

is placed below the center of the gang, because Salmon Trout strike the bait well toward the tail. If, therefore, the minnow is not hooked below the middle, the Trout is quite likely to get away with the lower end of the bait. Before the minnow is placed on the hook, it is stunned by pinching its head. The upper or lip hook is then run through both jaws, fastening them together, while one of the lower hooks is inserted near the tail, and one of the middle set in the side. The minnow should have a slight curve when on the hooks, which will give it a rotary motion resembling a crippled minnow. It should not be curved so as to revolve rapidly. In fishing the lines should go down at an angle of about forty-five degrees. As the tackle described is fine, a fish must be played cautiously until its strength is exhausted. So long as the line is kept taut, the Trout is not likely to escape. In trolling in July, August and September, fish in from fifty to eighty feet of water, and keep the bait within a foot of the bottom. The angler can make sure of this, only by allowing the sinker to touch the bottom occasionally. In the months above named, the Trout bite very early in the morning, and in the evening. During May and June Salmon Trout are found near the surface, and no sinker is then required on the line."

The following are the dimensions of the "Seth Green Gang," as illustrated in the cut. The hooks are number 8, forged O'Shaughnessy. From the bend of the lower treble hook, A, to the bend of the treble hook B, one and one-quarter inches; from the bend of the treble hook B, to the bend of the double hook, C, two inches. The double hook is made of a number 8 and a number 6, the latter for putting through the head of the bait. From the double hook, C, to the swivel, D, two and a quarter inches; swivel, one-half inch, making a total of six inches. The hooks are whipped on with waxed silk, and the gut is double between the double hook and the swivel.

Mr. Cheney's method is as follows:

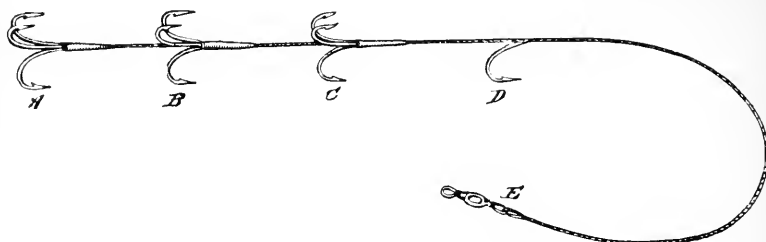

A. N. CHENEY'S GANG FOR TROLLING.

"The tackle for deep trolling consists of a stiff rod about ten feet long, in three joints, with double standing guides on second joint and tip, so that as the rod becomes bent from the heavy strain, the upper joints can be turned to present the opposite side to the pressure. A multiplying reel to hold 150 yards of number 4 or 5 braided silk or linen line; single leaders of best silk-worm gut, from nine to twelve feet long, with two swivels tied midway in them. (I use what I call a swivel line, made of five box-swivels, number eight, fastened together by bits of fish-line nicely whipped with waxed silk, and this I use to connect the reel or hand-line with the leader.) The swivels will be found very necessary to keep your rod-line from twisting. A drop of porpoise oil will increase their freedom of action. Lead sinkers from two to sixteen ounces in weight are needed for deep-water trolling.

"For surface trolling, or when a very light sinker is used, any light bait rod will answer the purpose.

"The last of the tackle to mention is what is fastened to the end of the line—the minnow gang. The treble hooks for the gangs are made by soldering three first quality O'Shaughnessy hooks together, back to back.

"The gang, as illustrated above, is such as I make and use for my own fishing. I make them of different sizes, *i. e.*, of different distances between the hooks, and of different

sized hooks, from number 10 up to number 5. I do this to be provided for different sized bait-fish. I use the whole gut length, of round, smooth, cream-colored gut, with the superfluous ends cut off, and the measurements of the one in the cut are as follows:

“A to B, one and one-eighth inches; B to C, one and one-quarter inches; C to D, a single lip-hook, one and three-eighths inches; D to E, five and one-half inches. The treble hooks are number 8, and the lip-hook number 6, all round-wire O'Shaughnessy's.

“An excellent lip-hook for the latter gang is made so that it will move on the gut, thus enabling the angler to fit minnows of various sizes to one gang. The hook is fashioned by soldering two small loops of brass wire to the back of the shank of the lip hook, one at the extreme end, the other where the hook begins to bend sharply. Or, what is better, make the loops by whipping on to the hook's shank a piece of doubled gut, the two ends of the gut coming together under the whipping. Before the swivel is fastened on, put the end of the gang gut through the lower loop, then around the shank of the hook, and then through the other loop. The lip-hook will move up and down on the gut. Always soak the gut before moving the hook.

“The bait is fastened on by first killing the minnow, or golden shiner, and putting the lip-hook through both lips of the minnow; then bend the bait and put one of the treble hooks into the back of the fish near the dorsal, and another near the caudal. A Trout almost always strikes a fish toward the tail. The baited gang should revolve slowly, with a motion as though the minnows were crippled. Practice will teach one the proper bend to produce the proper motion.

“The bait most generally used, and considered the best, is the golden shiner, or bream, particularly for deep trolling, as its burnished scales can be seen for a great distance in clear water. For surface trolling, suckers, chubs, dace, and

anything that comes to your net in the shape of minnows, will answer for baiting the gang. Where bait is scarce, it is well to bind the minnow to the gang, with a few turns of strong white or lead-colored linen or cotton thread.

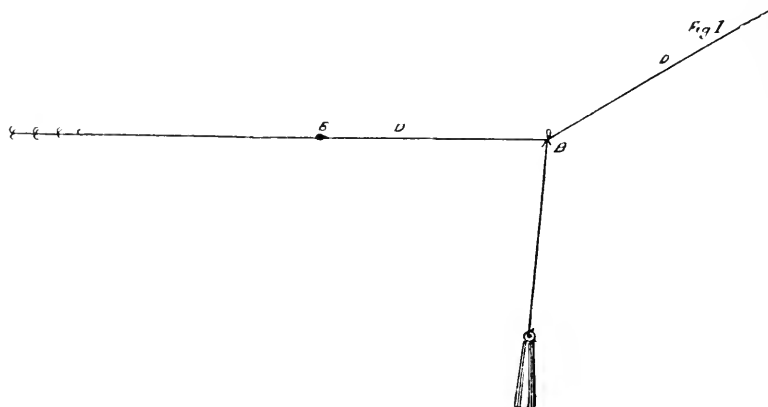

GEAR FOR DEEP TROLLING.

“Figure 1 shows the lower end of a rod or hand-line, as it is supposed to be in the water. The gang A is fastened to the leader at C; at E the leader is attached to the reel, or hand-line, D D; at B a cone-shaped sinker is fastened to the

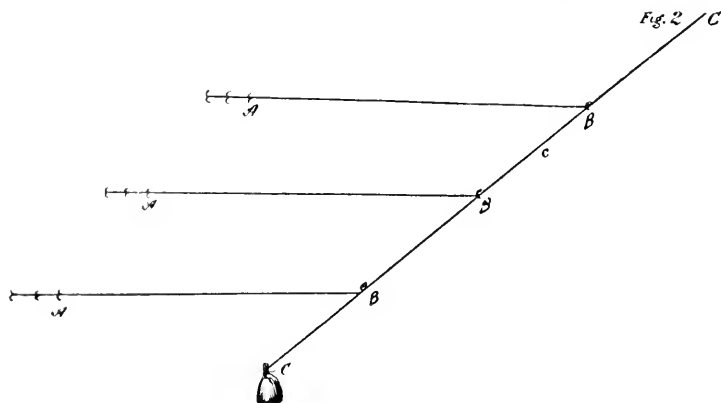



reel or hand-line by a half hitch of the sinker-line, which is about three feet long, and of weaker material than the reel-line. So, if the sinker gets fast, and something must be broken, you will lose only the sinker. From A to B there should be a distance of about twenty-five feet. If the swivel-line is used, it should connect the leader and reel-line.

"Figure 2 shows Seth Green's hand-line, sinker, and three gangs. The sinker is fastened to the end of the hand-line, C C. The line, as I remember it, is about the size of a hard braided linen line, number 0. The gangs and leaders, A B, twelve feet long, are fastened to the hand-line one above the other. To use Seth Green's own words:

"The first leader is usually about three feet from the sinker, and the others vary from eight to twelve feet apart, according to where the fish are. If I do not catch them fishing low, I raise the leaders, that is the two upper ones, but leave the lower one the same.'

"The line with the single gang has the sinker fastened with a half-hitch, so it can easily be taken off, for it is not desirable to take the sinker into the boat when it is fast to the line, as a run on the part of the fish might find the angler unprepared to put the sinker overboard at the right moment. In the spring, when the Trout are at or near the surface, little or no sinker is required.

"Let your line run slowly off the reel, checking occasionally, and, as it were, *feeling* for the bottom with your sinker, until it strikes; try and check your line at the moment of contact, and reel in a few feet. As the boat moves on, repeat this manœuver until you have out the proper length of line, and this depends much upon your sinker; a heavy sinker means a short line, while a lighter one takes a longer line. The idea is to keep your sinker as near the bottom as possible; you will touch once in a while, to make sure, but do it lightly, and beware of rocks!

"Spoon baits are also used in deep trolling, and in the

absence of live minnows you may be compelled to resort to the artificial. You make no change in your tackle except the bait. (The gang is also a favorite bait in shore or surface trolling for Bass and Pickerel. It is more deadly than the spoon.)

"A Bass-spoon may be much improved by tying a hook, with a length of gut, so that the hook falls two inches below the burr of the spoon. You will be surprised to find how many Bass miss the treble hook and catch the single one. The larger fish are caught in the deeper water, as a rule. Always see that your hooks are sharp before you put out your bait, and examine well your gang after catching a fish.

"If any one imagines that deep trolling is very simple, affording little sport, I only ask him to defer judgment until he has tried it."

Buoy fishing is now practiced very little, having made way for what is far better—trolling. It is so unsportsman-like a method, that I will do no more than mention it here, adopting Seth Green's description as sufficient comment:

"Anchor a buoy out in deep water, and cut fish in pieces varying in size from a hickory nut to a butternut, scattering the pieces around the buoy for some days; then anchor your boat to the buoy, using a piece of the same-kind of bait on your hook that you had been in the habit of scattering around your buoy; fish near the bottom, and give it a little motion by giving your line short jerks. The buoy should not be baited the day you go fishing."

Still another method adopted is that of the ardent sportsman, who cannot wait until the spring, but cuts a bell-shaped hole in the ice of the lake in midwinter, puts his little three-sided shanty to windward, and with a hand-line keeps his baited gang in motion, until rewarded with a strike—or a frost-bite! The process resultant to the strike is surprisingly simple. The line is thrown over the shoulder, and the stiff-limbed fisherman runs or hobbles off, till the poor defense-

less fish is flung up and out through the hole, and left to freeze on the ice, while the hook is baited for fresh slaughter. I recall one instance where a clerical friend of mine bought some fish caught in this way, and gave them to the cook with instructions to put them in a pan of water to thaw out before cooking. She, poor soul, was horrified, in the course of a quarter or half an hour, to find them vigorously and indubitably alive. It was merely a case of suspended animation. But I cannot recommend this ice-box method, either for comfort, or for sport.

The Lake Trout is occasionally taken with the fly, though the cases are so exceptional as almost to verify the contrary as the rule. Mr. H. H. Vail, of Cincinnati, states in "Fishing with the Fly," that "at several points on the Nepigon river, particularly in the wild water at the foot of falls, the Mackinaw Trout (*Salvelinus namaycush*) was abundant, and took the fly with as much vigor as any *Salvelinus fontinalis*. We could not tell which we had struck, except from a flirt of the caudal fin. The 'well-forked' caudal fin of the Mackinaw Trout was frequently distinguished by our guides at a great distance. They do not play toward the surface so much as the Brook Trout. They were fat and lazy, two or three long runs generally wearying them so that they led peacefully into the net."

Another writer, unknown to me by name, says:

"I have just returned from a three weeks trip to Moosehead Lake, Maine, and my experience this season is a repetition of the past five or six years at the same place. I took with the fly at least one half-dozen Lake Trout, weighing from one and a half to three pounds each, and I have taken them weighing four pounds, but they are rarely taken above that weight with fly. The time when the fly is most successful with them is from 4 to 7 P. M., though I have occasionally taken them in casting, even at high noon.

"It is difficult to tell their 'swirl,' or rise, from the true

*Salmo fontinalis*, but their tactics after being hooked reveal their true family quickly, as they set out at once on a grand exploration of the bottom.

“I have also taken this fish with fly at the Sysladobsis and Grand lakes, Maine.”

Thus far we have been considering the characteristics of the fish, and the methods of his capture that are used in the smaller lakes during the summer months. But in the Great Lakes no such preparations are necessary. In them the water is so cold that he is not confined to the deeper portions, but is found very near the surface, certainly in the northern parts of Lakes Michigan and Huron, and in Lake Superior. In these waters, from early spring until late fall, our friend *Namaycush* may be caught, with trolling line or rod, from sailing vessel, yacht, or boat, in waters that range during the whole summer from 55 degrees in the neighborhood of the Manitow or Thunder Bay, to 38 or 40 degrees in the waters of Lake Superior. No wonder that under such bracing circumstances the Trout is lusty and frolicsome, and ready to take his chances at any time in an encounter with the fascinating and mysterious spoon.

I have a dream, which sometime I hope to realize. Others have proved its worth and pleasures, but for me it is still in the vague “to be.” It is to take a Mackinac boat and a couple of trusty Indians from the Sault, and coast north along the shore of Lake Superior, with not more than two or three friends for company, putting in at night, or during stormy weather, into one of the numerous shelters that the guides know very well, and fishing during the day, either from the boat or the rocks; enjoying meanwhile the balm-laden air, and the glorious scenery that belong inseparably to this lake. Even the prosaic cyclopædia enters into the realm of the romantic in describing this wildly picturesque region:

“The rivers of the North Shore of Lake Superior flow

through a rough, granitic country, and are interrupted by numerous falls, many of which are highly picturesque.

“The coast is for the most part rocky, and the north shore is much indented by deep bays surrounded with high rocky cliffs. Countless islands are scattered along this coast, many of them rising precipitously to great heights directly from the deep water. Some present castellated walls of basalt, and some rise in granitic peaks to various elevations, up to 1,300 feet above the level of the lake. Nowhere upon our inland waters is the scenery so bold and grand as on the north shore of Lake Superior. The irregularities of the coast, with the general depth of water, afford numerous good harbors.” (*American Cyclopaedia, article “Superior.”*)

But if I dream thus of future joys of angling, and of nature's beauties, it is because I have already had a taste of them in the past.

My first memorable experience of this sort was as far back as in 1884, when I was one of a party of four who, in a well-manned and well-provisioned yacht, set forth to spend the month of July cruising in Lake Superior. We talked bravely on leaving Chicago of the Nepigon River as our objective point, and really did cherish some hopes, I think, of seeing its wild beauty, and letting our lines fall in its pleasant places for the sportive and toothsome creature, that is known to all honest and simple-minded anglers as *Salvelinus fontinalis*. But “the best laid plans of mice and men” don't always run our way, as we full soon found out. The early part of our trip was decorated by those highly-colored events that are always happening in books. We almost capsized during a sudden squall, when the green hands were on deck and the seasoned hands (I wonder if that is why they are called “old Salts”?) were below. We had numerous encounters with wild storms and ferocious and persistent winds, sufficient almost to supply Clark Russell with material

for a new marine tale. Through it all, however, we passed safely, and managed, during one of the pleasant days, when we were making what our captain liked to call "a famous run," to catch, by trolling, a Mackinaw Trout of eight or ten pounds, this being in the neighborhood of the Manitou Islands, in Lake Michigan. This, mark you, good reader, was on the 7th or 8th of July—mighty close to the dog-days—when of all fish the "lakers" are supposed to be farthest removed from all proximity to anything but the most heavily leaded "leaders." But then that is water as is water, that is to be found from the Manitou northward—cold, clear, pure—fit home for such a fish. In it he can frolic, with no fears of fevers and kindred ills that sap his strength in warmer floods.

Once in Lake Superior, we headed to the north'ard with stout hearts and fond anticipations. We fed a long time on anticipations. A stiff head-wind made it too rough for any change to fish diet, and the only thing that was at all suggestive of such a change was an impertinent little island named "Leach," on the map, which tantalizingly stuck to us for the greater part of the day, while we vainly endeavored to shake it off, and go our way. By sundown we realized the actual discomfort and possible danger to our little craft of spending the night in such a "nahsty" sea, and choosing discretion for our companion, we took the advice of Louis, our half-breed pilot (what a land-lubber of a pilot he was, even if he did know the shore!), and putting about, ran before the wind for Gargantua harbor, a haven of rest and perfect security—the most charming spot on all the north shore, I verily believe. How great our delight and ease of sailing was, none can tell, save they who have been in like good fortune with ourselves. We fled lightly before the pursuing wind and sea, and rapidly approached a shore that showed no outward sign of welcoming us in peace, but rose in majestic fir-crowned glory, where every point seemed

inhospitable, and everywhere the dashing surf beat itself out in long lines of snowy rage. Yet, even as we were ready to question the knowledge and the honesty of our dusky pilot, and trembled before a seeming danger, his course was justified, and there opened before us a narrow passage between two points of rock, beyond which lay a calm expanse of water, on which a navy might have ridden securely. Meantime our anglers had not been idle, but as we neared the land, had been guarding the trolling line, to try their luck with "lakers." Just as we made fast to our "wharfing privilege"—the virgin shore on one side the yacht, and four fathoms of water on the other—preparatory to that prosaic but very necessary conclusion of a day's labors, the supper, the last man at the line brought in a two-pound Brook Trout, a *rara avis*, indeed. We fell to wondering whether this was to be the custom of the land, but it was so unusual as to be unique; we caught no more of that kind of Trout in that kind of way.

But we did have some royal sport with the "lakers." Our captain, even, was roused from his daily "bath," and dreams of "magnificent runs" for our trim little craft; and, sallying forth amid the dews of the early morning, with "Louis" to paddle his canoe (or mine, for my birch-bark was common property through all our cruise), came home with a job-lot of fish, the biggest of which was "way up"—a good, clean "high hook," with  $13\frac{1}{2}$  pounds of "too, too solid flesh" to his credit. I, fortunately, was not far behind; "fortunately," I say, for thus the unkind and unhandsome feelings of envy or of jealousy were not aroused. It was a pleasure so Protean in form that no one joy eclipsed the others, to ride in the tiny birchen shell, that responded as surely to the lightest touch of Louis' deftly handled blade, as the clean-cut racer of the ocean to the pilot's will. In the early morning sunlight the blue waters reflected the clearer blue above, as they quivered beneath the kiss of the wooing breeze, and the frail craft traced its dainty way in and out among a thousand rock-

built islets that gemmed the waters, some barely breaking the placid surface of the lake, others towering precipitously to dizzy heights above us. It was a very primal hour, and savagedom most fitted it. The rude canoe, the dusky guide, the wild scene, drew vague curtains of immeasurable distance between civilization and me, and I was well content. It would have been an ever-new pleasure only to have floated thus, and dreamed; but as action is ever better than mere contemplation, except it be on the mysteries of divine love, it was fitting that our dreams should be often interrupted by the leap of the whirling spoon, and the sudden arch and spring of the rod, that tell of an unwilling captive, struggling to be set free. And then the contest—how it waged from side to side, now here, now yonder, never in doubt, thanks to the consummate skill of Indian-born Louis, and the trusty fibers that linked the angler to his prey, yet always attended with such delightful uncertainty as made its attractions only more piquant and fascinating. Mystery surrounded the captive's every movement. No glimpse of him was seen; only the tense line, and the swaying boat, and the springing rod, showed how and where the fight was being waged, until at last, one by one, the beautiful cold Trout were brought to gaff and the *ultima thule* of all good fish, the angler's "string," by the combined efforts of Louis and myself. The results were not stupendous, since the largest fish weighed only nine or ten pounds, but what need had we of more? Our wants were fully met, and we had had a witching day. Its fragrant memory lingers yet with me, and I joy in recalling its incidents. Five long years have passed since then, and other scenes of action far more varied have followed; yet still my heart goes back with strong desire to those countless islands of the deep, and lofty, verdure-topped heights of inaccessible rock, and I would fain be there again, to float and dream, and dream and float, and lead the lotus-eater's life of ease.



One of the most famous spots for Lake Trout fishing that is at present known to anglers is Stannard's Rock in Lake Superior, forty-four and a half miles north-by-east from Marquette. It is a deadly reef, rising only in a few points, and to the height of a few inches, above the surface of the lake. Undistinguishable in calm weather, its presence would only be made known to the mariner in storms by the seething foam that marked its resistance to the angry waves. It was, fortunately, discovered and definitely located a number of years ago, by a vessel captain whose name it bears. The government has built upon its northern end a massive lighthouse, whose flashing white light, a hundred feet above the surface of the lake, gives warning to sailors eighteen miles away of the dangers that surround it. Thus it is robbed of its terrors, and becomes instead of a constant menace to navigators, a guide to the venturesome angler who seeks excitement and his fill of sport. Southwest from the light, distant perhaps a quarter of a mile, there is a submerged plateau, lying north and south, and covered by eighteen or twenty feet of water. This is where the Trout are to be found in seemingly countless numbers. The lighthouse-keepers must find the place for you, and you must scale the outside of the lighthouse-tower to find the keepers. Genial men they are when found, and trusty, leading a life of solitude that would be unbearable were it not for the constant duties that engross their time. If you go to see them, reader, take with you fresh meat and vegetables—not as a bribe—they do not need it—but to vary the monotony of the salt pork and canned goods diet to which they are necessarily so much restricted. I wish I could give the names of the men who greeted our party with so much courtesy, and showed us such kindly attention; but alas, the log of the *Argo* is deficient in this regard. It matters not whether they are still there, or have been transferred to other fields of usefulness, the lighthouse-keepers will gladly go and buoy the spot, and set you fishing.

Hither, in the middle summer of 1887, a party of four, of which I had the privilege of being one, hastened in the schooner yacht *Argo*, anxious to make trial of the sport. After enduring the customary trials of the yachtman's life, including the unavoidable "splicing of the main brace," which seemed for some unexplained reason to be in a very unstable condition, and to require unusual care, we reached at last one afternoon our destination. Everything was favorable. The sky promised a quiet night, a gentle breeze just ruffled the water, and served to render visible the grizzly terrors of the reef. We visited the lighthouse, of course. In fact that was the first thing we did, "going ashore" up the side of the lighthouse foundation, a good fifty feet above the water. It almost took our land-lubber's breath away, and if we had reckoned on the return, some of us would certainly have stayed at home on board our little vessel. With the utmost courtesy the keeper and his assistants showed us over the house, which was as bright as a new pin, and as clean as if an army of housekeepers had just put it in order. They promised on the morrow to come off early and "stake off our claim" for us, a thing which it would have been quite impossible for us to do. They also promised us a quiet night, and the prospect of a good day. But, "landy!", as I heard a good angler vociferate the other day, do you suppose we were content to wait until "to-morrow," when opportunity still waited on to-day? Nay, verily, as soon as politeness let us leave the tower, we set to work, and when darkness and hunger both warned us to quit the sport, we had already a fair store of sightly fish to grace our vessel's "counter." We had the quiet night that was promised us, and shortly after sun-up our friends came off, and planted can-buoys at each end of the fishing ground and let us set to work. Every boat we could command was impressed into the service, and every hand that was not engaged in pulling an oar, or tending the wheel, was yanking and pulling here and there with the con-

stant excitement of the chase. Back and forth, "down the middle and back again," we "chassez-ed" and "allez-ed," the yacht meantime becoming infected with the spirit of the chase, and fishing across our tracks, the cook, even, having "rigged a cast" of a big hook adorned with a bit of red flannel, which proved quite sufficiently "taking." The others were disposed at first to laugh at my eight-ounce rod and light line, and to assert that they would have "more fun" than I; but after they had seen the process of "playing" a fish, and bringing him to gaff, they concluded that although I might not catch quite so many, I was having my full share of sport. The "midshipmite" was most successful in *quantity*, but as afterward in our hours of ease, he was heard slangily to asseverate that "there were no flies on" the Marquette girls, we concluded that his taking ways proved him a "spoon" of the first water. In the matter of *quality* I felt myself abundantly satisfied. The biggest fish of the trip fell to my rod—a rousing 18-pounder, which met me with the veritable "laker" tactics, sounding at once, and playing low as long as he had any fight in him. I should think that it took me about fifteen minutes to bring him to gaff, up to which he was led without trouble. My other noteworthy fish scaled eleven, thirteen and one-half, fifteen and sixteen pounds, and there were a number that ranged in weight from nine down to two and one-half pounds. Our total catch for the evening and the morning was 151 fish, weighing in all 550 pounds. We quit the sport at 11 o'clock so as to make sail and reach Marquette if possible before night-fall. I may remark in passing that the uncertainty of a yachtsman's life was shown in that unfulfilled expectation. The wind died away, the threatening clouds came up, and we sailed ignominiously into the harbor the next morning in the midst of a dense and driving mist—forty-five miles in twenty hours! It might have been worse, but for that invaluable "main brace" and its exacting condition.

The characteristics of the Mackinac Trout were fully shown during this outing at Stannard's Rock. Not a single fish broke water after being struck, nor did we see them at all until just as they were being brought to gaff. They showed no tricky ways, and only ordinary caution was necessary in boating them. But they were very active in the water; again and again as one fish was being reeled in, he would be followed by others, apparently out of wanton curiosity, who would come close to the boat, and then, with a saucy flirt of the tail, turn away, only, perhaps, themselves made captive, to be followed in turn a minute later by their still untrammelled brethren.

Lake Gogebic furnished wonderful fishing when its waters were still new to the angler—so did the Eagle Waters—so have many other newly opened-up lakes and streams which now have lost their pristine glory; but here is an apparently inexhaustible source of fish sport, if only commerce, with its insatiable greed, does not deplete it. It is so far removed from land, and the fishing is attended with so much of uncertainty and danger on account of the elements, that it must be always an open question whether the sportsman-angler will meet with the fulfilment of his plans. We were exceptionally fortunate; the weather could not have been better if it had been "made to order;" even a few days earlier or later, in our own case, and rough weather would have made it necessary for us to forego our pleasure.

Other yachting parties have visited this rock and carried away immense catches. A well-known Chicago club-man is said to have caught over 2,000 pounds of fish in one day's fishing over these grounds, and our captain of my first yachting trip herein mentioned caught over 1,000 pounds in a similar length of time. This seems very "hoggish," as one looks at the total, but in our own case the fish were given to the crew, and salted down by them for the market as soon as we reached Marquette, thereby furnishing a material addition to

their wages. I presume the same was done in the other cases I have mentioned, thereby, I hope, removing these particular instances from the charge of being either mercenary or excessive.

I have heard and read many "fish stories"—some of which had "a very ancient and fish-like smell"—but the wildest of them could hardly outdo the reality that confronted us at this famous spot.

My pleasant task is well-nigh ended, my reader, yet I fain would add one parting word of most prosaic sort. The old adage hath it that the hare must first be caught before he's cooked. Our Trout are caught; how shall we serve them in toothsome form to the friends who gather to hear the story of their capture? The flesh of the Lake Trout is firm and hard, and has more or less of that "dryness," like the Brook Trout and the Salmon of the waters, and the quail on land, that makes it pall soon upon the appetite. It tastes very well at first—is rich and toothsome—but after a time even the most ardent advocate of "brain food" will admit that he would relish a change. Hence the importance of variety in the ways of serving this fish. Availing myself again of the kind permission of Mr. Cheney, I quote him, premising it by saying that, for myself, I never saw a fish spoiled by being delicately and carefully broiled, and served with plenty of sweet, butter-gravy.

"There may be a better way to cook Lake Trout, but I do not know it. A fish would have to be a leviathan that I would boil or bake, and as for broiling, I leave that for salt mackerel.

"Of course, when fishing I select the smaller fish to cook, as they are more easily and quickly cooked and the larger ones are better to send to one's friends—the happy fate of most of the Trout we take in Lake George.

"Clean, and split your Trout open on the back; if then too large for a frying-pan, divide again vertically; if still too large,

cut into pieces four or five inches wide; roll the halves or sections in Indian meal or cracker crumbs—some prefer to dip their fish in egg, white and yolk beaten together. Fry some clear fat pork in a frying pan over a *hot* fire, and when the fat is fried out, put in your fish, flesh side down; finish cooking with the skin side down. Cook quickly and serve hot, with pepper and salt. When the crust which frying makes is broken, you have [the delicious, white, moist meat, with all the richness which a fat Trout affords, making a dish fit for a hungry angler.]”

It is always pleasant to quote oneself against oneself, so I quote Mr. C. again, suggesting merely that this last recipe is the result of four or five years added experience:

“Occasionally there is caught in Lake George a Trout shorter and deeper than his fellows of equal weight, with real salmon-colored flesh and with creamy curds between the flesh flakes. Such a fish has devoted his whole mind to his diet, and good living has changed his appearance; simply this and nothing more.

“One year I cut my fishing short to return home to an entertainment under the old roof-tree. I had scarcely got my traps into the house, when my grandmother told me that she must have a Salmon for the lunch the next day. I showed that it was impossible to telegraph to New York and get a Salmon at the hour it was required, and disappointment reigned. Among the fish that I had brought home was one of these specially fed Trout of 10½ pounds. I asked for the list of the expected guests, and when I had read it I announced that I had a Salmon that I had until that moment overlooked, and I advised that it be boiled and served cold, covered with mayonnaise and garnished with parsley, and placed before me to serve. Considering the occasion, I was only shaky about one of the men, for I knew he had eaten Salmon from the Columbia River to New Brunswick, and he might be critical even in a friend’s house. The only one who ever

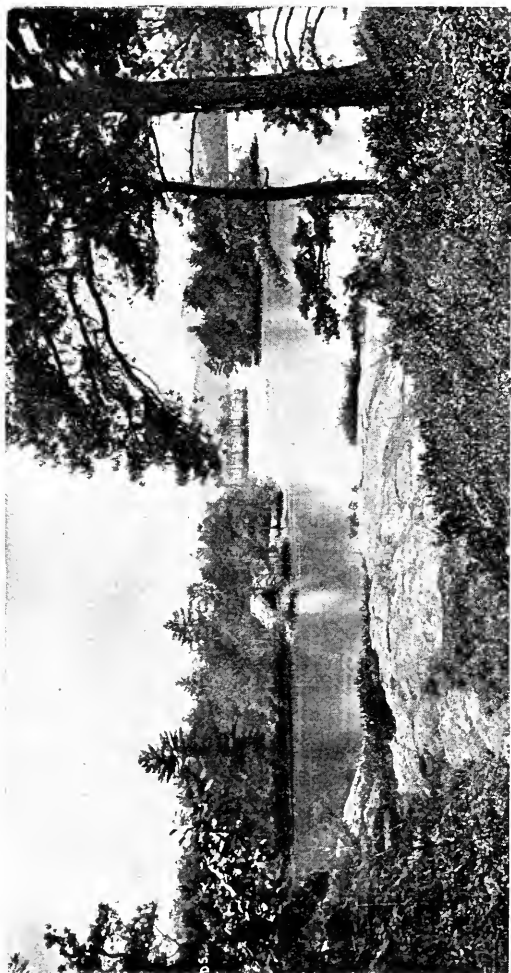

WHERE THE TROUT THRIVE.





spoke of that fish to me was that very man, and it was when we were at table together and actually eating Salmon, that he compared the real with the bogus, and the bogus won by a throat-latch."

Here is the Bisby-Club cook's way, and they do say that she has no equals and few superiors in the art that goes so far toward solving the question, "Is life worth living?"—I do not know to whom I am indebted for it:

"Our party caught several small Lake Trout, which, dressed, beheaded and deprived of all their fins, were plumped into the bubbling water on top of the potatoes a few minutes before the latter were cooked through, and transferred to our platters piping hot, so that the butter would instantly melt and permeate the flesh. The method was new to some of us, and every man acknowledged that he had never tasted Lake Trout at its best before. We had eleven members at the table yesterday, and the verdict was unanimously in favor of boiling the Lake Trout. As between broiling and frying there was a variance of opinion, but a majority put down the latter method as the third best."

The Bisby Club will please excuse the liberty I have taken.

In gaffing the fish, if the angler can handle the gaff himself it will be well, both because one is loth to scold himself in case of failure, and also because he can then use the gaff in the most satisfactory way, striking up from below, and drawing the fish toward him with the same motion. When there is time for deliberation it is well to place the gaff as near the throat of the fish as possible to avoid unsightly disfiguring. Then, when you have your fish, be merciful, and deal him the *coup de grace* quickly, by striking him sharply on the head with a small club, or the end of the gaff-handle. After you have practiced on a few of them, you will know just how to hold the fish so as to avoid hitting your fingers as the "thumping stick" slides off the slippery head. Perhaps it

will be just as well to begin by holding just back of the gills and hitting *across* the head.

A fish should never touch the ice when being prepared for keeping or transportation. Without washing him, after you have drawn him, "wipe him dry as possible with a bit of old muslin, and wrap him up in a piece of the same, and pack in straw, dried leaves or grass, that have also been placed in the ice-house. A fish is firmer and better and will keep longer under this treatment. Never wash a fish you wish to send away."

## THE ROCKY MOUNTAIN TROUT.

BY G. O. SHIELDS (*Coquina*).

It is popularly supposed that there are many species of Trout in our western mountain streams and lakes, but, in fact, all the Trout found in waters west of the Missouri River may be referred to three species. These are (a) the Rocky Mountain Trout, *Salmo purpuratus*, also variously known as the Salmon Trout, the Yellowstone Trout, the Lake Trout; (b) the California Brook Trout, *Salmo iridens*, otherwise known as the Rainbow Trout, the Sierra Nevada Trout, the Lake Tahoe Trout, etc., and (c) the Rio Grande Trout, *Salmo spilurus*.

It is not strange that even close observers, who are not experts in ichthyology, should be misled in judging of these fishes, for individuals of any given species vary so under varying conditions as at times to require the most careful scrutiny of the expert to place them in their proper class. For instance, a fish-dealer in Tacoma—an intelligent, well-informed man by the way—told me that there were five distinct species of Trout in the waters thereabouts, and proceeded to select one of each from his stock and explain its peculiarities. He called them the Salmon Trout, the Sea Trout, both of which he said were caught in Puget Sound; the Puyallup Trout, taken only from the lower Puyallup River; the Bull Trout, found in all the streams flowing into the sound, and the Glacier Trout, that he said was found only in the head-waters of streams flowing out of the Mount Tacoma glaciers.

When one of each was ranged on the board, the variety of

colors and shapes was indeed enough to puzzle the most learned ichthyologist in the land. The Salmon Trout was mildly colored and deep in proportion to his length; the Sea Trout was brighter and was long and slender—a veritable greyhound in build; the Puyallup Trout was heavier in proportion to his length than either of the others; his spots were black and well accentuated, and his whole contour showed that he was lazy and well-fed. The Glacier Trout was smaller than any of the others, and the dealer said he never grew to weigh more than a pound. He was of a dull, milky hue—like the water he inhabited—was lank, lean and looked as if there had been a famine in his neighborhood.

The Bull Trout was king of the group. He hailed from the Green River and wore such a suit of clothes as could only preserve the resplendent colors in its icy crystalline embraces. He was large and lusty, fat and pugnacious-looking, with a head like his namesake and a belly that showed he had been living on the fat of the land. His pectoral fins and throat were a fiery, cardinal red; his belly and sides, silvery; his back, a dark somber green, and his round black spots appeared to stand out like the heads of hobnails. His whole aspect showed him to be an aggressive, intrepid navigator, a fish that would stem the wildest cataract on the river and that, if hooked, would make sad havoc of any but the best of tackle, and of even that, unless managed by an expert angler.

Nearly every stream and every lake of any note, in our great western mountain district, has a Trout that neighboring ranchmen, if there are any, deem a distinct species peculiar to that water. In other waters you will find Trout bearing other local names, as the Flathead Lake Trout, the Yellowstone Trout, the Green River Trout, the Geyser Trout, and many others, for which their sponsors claim characteristics not to be found in any other Trout. But these characteristics may usually be traced to certain conditions of water, food,

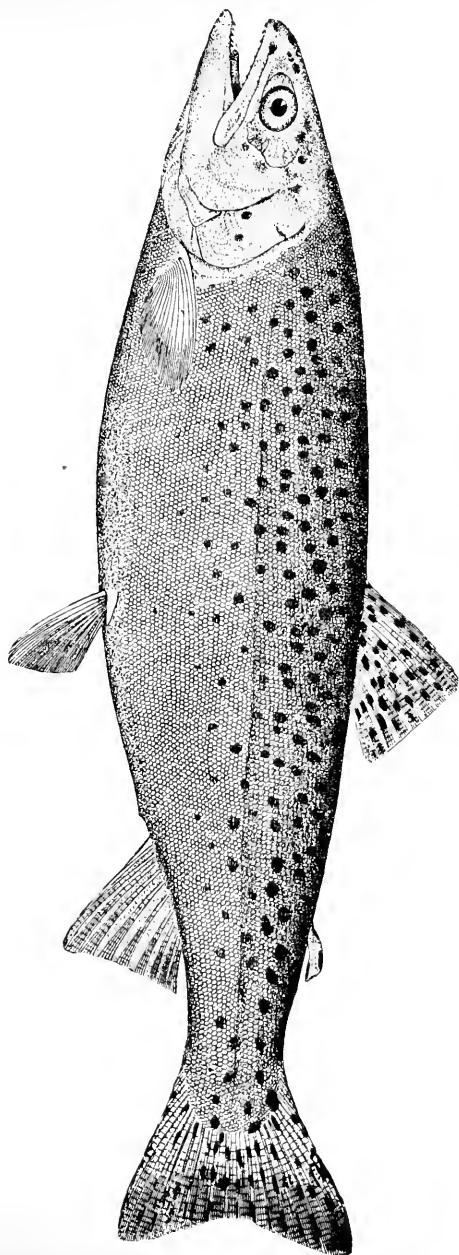

BLACK-SPOTTED OR MOUNTAIN TROUT.—*Salmo Porphyrus*.

color and character of rocks, or other matter, composing the bed of the stream or lake in question, and the fact should never be lost sight of, that if a Trout be taken from any one of these waters, transported and placed alive in any other water inhabited by Trout, he will in a few hours, or days at most, be substantially like his new neighbors, not only in color but in other respects.

There are Trout in the Bitter Root River that grow to weigh ten to fifteen pounds—light-colored, long-waisted fellows—which the natives call Cannibal Trout, because they can only be caught with a live minnow. The ranchmen on that stream will tell you that Cannibal Trout are not found in any other water in the territory.

And when all these supposed species of Trout come to be critically examined by a skilled ichthyologist they prove to vary from the type of their species only on account of certain conditions under which they have lived. Salt water, brackish water, fresh water of slow current and only partially clear; the milky, lime-charged water of the glaciers; the clear, cold water that foams over rapids in the typical mountain streams; scant or abundant food, and its quality as well as quantity; sex, old age or youth, are all important factors in coloring and shaping Trout. If one of the Sea Trout were taken from Puget Sound and placed in the icy currents at the foot of the Tacoma glaciers, and one of the Glacier Trout taken from his home and turned loose in the sound, they would change color, and, to some extent, other characteristics, soon after changing places.

All these Tacoma Trout, as well as the Cannibal Trout—and in fact as well as nearly all Trout to be found in any mountain water west of the Missouri and north of the fortieth parallel of north latitude—belong to the species that forms the subject of this paper—i.e., the Rocky Mountain Trout, *Salmo purpuratus*. This species is described by Professor David S. Jordan and Charles H. Gilbert in

## CONTRIBUTIONS TO NORTH AMERICAN ICHTHYOLOGY.

*Salmo purpuratus*—Pallas. *Salmon Trout of the Columbia; Yellowstone Trout; Rocky Mountain Brook Trout; Lake Trout.*

Body moderate elongate, compressed. Head rather short, mouth moderate, the maxillary not reaching far beyond the eyes. Vomerine teeth as usual, set in an irregular zigzag series; teeth on the hyoid bone normally present, but often obsolete, especially in old examples. Dorsal fin rather low; caudal fin slightly forked, less so than in *iridens* [This is the *California Brook Trout* or *Rainbow Trout*], more than in *spilurus* [Rio Grande Trout], the caudal more forked in young individuals than in the adult, as in all Trout. Scales moderate, varying to rather small. Back and caudal peduncle profusely covered with rounded black spots of varying size; dorsal, caudal and adipose fin covered with small black spots about as large as the nostril; a few spots on the head; belly rarely spotted; inner edge of the mandibles below with a red blotch; sea-run specimens are nearly uniform silvery; males with a broad lateral band and patches of light red; extremely variable in color and form. Head 4; depth 4. D. 10 A. 10.; Cæca 43. Scales variable in size, 33—150—30 to 39—170—30. The common Trout of the Rocky Mountains and Cascade region, abounding in all the streams of Alaska, Oregon and Washington, where it descends to salt water, and reaches a weight of twenty pounds (Columbia River, Charles J. Smith); also in the Yellowstone Region, the Upper Missouri, the Upper Rio Grande, Colorado, and the lakes of the Great Basin of Utah, being very abundant in Utah Lake. Not common south of Mount Shasta in California. This species is apparently the parent stock, from which our other Black-spotted Trout have scarcely yet become differentiated. Considerable local variations occur, especially in size, coloration, and size of scales. The red blotches on the lower jaw between the dentary bones and the membrane joining them is very constant and characteristic. [Synonymy.]

(*Salmo purpuratus*, Pallas, Zool. Ross. Asiat. iii, 374, 1811—31; *Salmo clarki*, Rich. Fauna Bor.—Amer. iii, 224, 1836; *Fario stellatus*, Girard, Proc. Acad., Nat. Sci. Phila. 219, 1856; *Salmo brevicauda* Suckley, Am. Lyc. Nat. Hist. N. Y. vii, 308, 1861; *Salmo steliratus, gibbsi*, 3 and *brevicauda*, Gunther, vi. 117—120; *Salmo clarki*, Jordan, Proc. U. S. Nat. Mus. i, 77; *Salmo tsuppitch*, Jordan, Proc. U. S. Nat. Mus. i, 72; *Fario aurora*, Girard,

Proc. Acad. Nat. Sci., Phila. viii, 218, 1856; *Salar lewisi*, Grd. Proc. Acad. Nat. Sci., Phila. 219, 1856; *Salar virginalis*, Girard, l. c. 220; *Salmo carinatus*, Cope, Hayden's Geol. Surv. Mont. 1871, 471—472; *Salmo Utah*, Luckley, Monogr. Salmo, 136; *Salmo aurora*, *lewisi*, and *virginalis*, Gunther, vi, 119—123.)

In "The Fishery Industries of the United States," issued under the auspices of the Smithsonian Institution, the following observations are made on this fish:

#### BLACK-SPOTTED TROUT—SALMO PURPURATUS.

This fish is known as the "Trout," "Mountain Trout," "Spotted Trout," "Black Trout," "Silver Trout," etc., in the mountains, but when in the ocean, full grown, as "Salmon Trout," or "Steel Head." The Indian name, "Preestl," is also ascribed to it on the Upper Columbia. It reaches a weight of thirty pounds under the most favorable circumstances, but may be found in any stream or lake, of any length from two inches up to two or three feet. Unlike *S. Gardineri*, the young are very common, and it probably begins breeding in mountain streams, at a length of less than a foot. It is universally distributed through the Rocky Mountain region, chiefly east of the Sierra southward, but reaching the sea from Mount Shasta northward. It occurs in every lake of New Mexico, Utah, Western Colorado, Wyoming, Montana, Idaho, Oregon, and Washington. Every stream throughout the most of this region abounds in them; in Puget Sound the young of every size occur in the salt waters in abundance. Individuals are occasionally taken along the California Coast.

Local variations occur in abundance. Specimens from Seattle have the scales notably larger than those from Victoria and Astoria, which agree with Utah Lake specimens in this respect. Those that live in the depths of shady lakes are almost black, while others are pale. Those in the sea are silvery, and only faintly spotted. Only in Lake Tahoe,



do the variations assume any marked importance (*var Henshawii*.) Individuals intermediate between this species and *S. Gardineri* are not rare, and there is no doubt that the latter is simply an offshoot from this general stock, as are *S. iridens* and *S. stomias*. It feeds on any living thing it finds near it. In the mountain lakes it spawns in the spring, running into the rivers for that purpose. Its great enemies, at that season, are the various species of Suckers and Chubs, which feed, the former upon its eggs, the latter upon the young Trout. So very destructive are the former in many Trout lakes, as Utah Lake, that the destruction or diminution of the Suckers ought to be accomplished by law. A parasitic tapeworm, *Dibothrium corticeps*, Leidy, is said to frequently infest this species so as to render its flesh uneatable in the summer, in the Yellowstone Lakes. (Yarrow.)

As a food fish this Trout is excellent. Large numbers of the variety *Henshawii* are shipped to the market of San Francisco. Attempts have been made to cultivate it in ports of California, with success. A small hatchery has been established at Tahoe City for the purpose of keeping stocked a small branch of the lake in which summer visitors may fish. In the opinion of the writer this species is likely to prove much more valuable for introduction into eastern waters than the Rainbow Trout. It is more active, more gamy, reaches a larger size and thrives in a greater variety of waters.

The habits as well as color and shape of the Rocky Mountain Trout vary in different waters, but in all cases are widely different from those of the eastern Brook Trout. The latter loves to hide under a log, a drift, or a rock, while the former seeks an open riffle or rapid for his feeding or lounging ground and when alarmed takes refuge in some deep open pool, but rarely or never under a rock or log. *Fountainalis* is a lover of dark, shady nooks, while *Purpuratus* always prefers the sunniest parts of the lake or stream. The eastern Trout feeds till well into the night, many a basket being filled with him,

after the shades of night have drawn over the water; while his mountain cousin usually suspends operations promptly at sunset.

As to game qualities, the western Trout is every inch the peer of his eastern congener; and some anglers have claimed that his first rushes were even more vicious, and that he was a wickeder tackle-smasher than the civilized Trout. It is difficult to judge accurately on this point, certain individuals of either species possessing more of the wild-cat impulsiveness than the average of their fellows; but there can be no doubt in the minds of those anglers who have thoroughly studied both species under all the varying conditions of season, character of water, weather, etc., that the Rocky Mountain Trout is not excelled in game qualities by any species of this noble family.

Generally speaking, the same tackle is required for the average Mountain Trout as for Brook Trout. If, however, one is to fish some of the larger creeks and rivers that have not been "fished out," so that a lusty five or ten pounder is liable to be encountered, then Salmon tackle should be employed. These very large ones rarely take a fly, however; but when they do, the best double-gut leader, the best number 6 braided silk line and a ten or twelve ounce split-bamboo rod will be taxed to their utmost to land him. Several cases are on record wherein a six or eight inch Trout has been taken on the fly, and while being reeled in has been swallowed by one of these ten-pounders. Where very light tackle was being used, the big Trout of course took it, and walked off with his tail over his back; but in other cases the implements and the skill of the man at the other end of them were sufficient to stay with him, and then a fight has ensued that can only be compared to that of a wild grizzly that has been roped by an intrepid cowboy.

As to flies, I have usually found a brown hackle and a white moth the most killing for Mountain Trout—the former

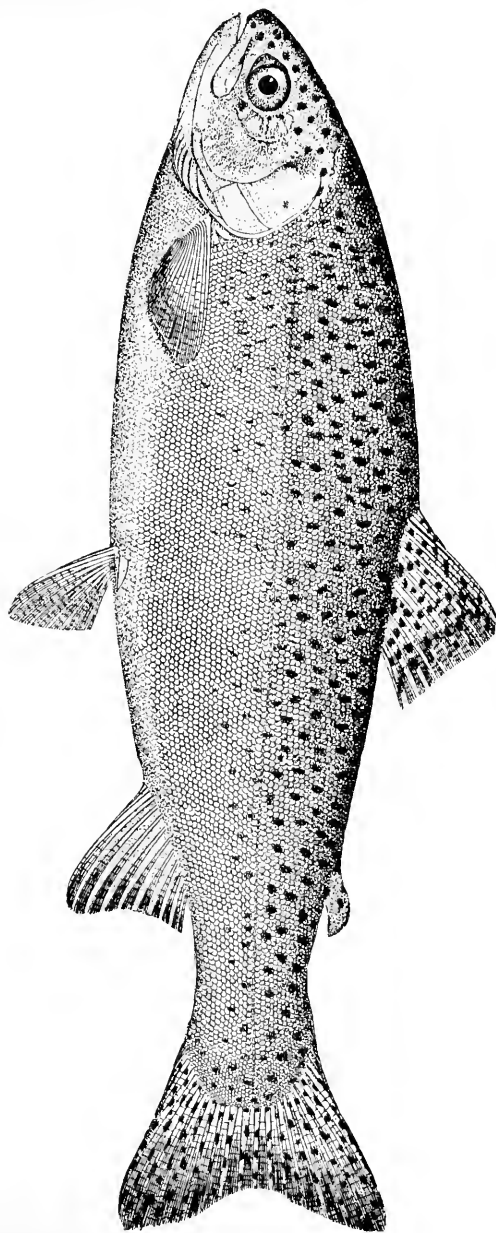

THE RAINBOW TROUT.—*Salmo Iridentis*.

for sunshiny weather, and the latter for cloudy weather or for morning and evening. Both should be of large size—such as are made for Bass and Salmon—and should be tied on 3-0 Sproat or Limerick hooks, and these mounted on the best double and twisted gut snells.

Generally speaking, it is not sportsman-like or esthetic to use bait in taking Trout, but there are times when no fly in the book will lure the Mountain Trout; and at such times the angler is justifiable in resorting to more substantial diet, especially if he have traveled a long distance and incurred a heavy expense to reach the mountains. At such a time he need not seek farther than the plebeian grasshopper. For all-around work, every day in the week, it is the most killing bait extant. There is not one Trout in a hundred but will pounce upon a good fat 'hopper, like a hungry dog on a piece of raw liver, and if you are on a stream that has Trout in it, if you have good tackle, a tomato-can full of 'hoppers and then don't fill your creel it's your own fault. The only Mountain Trout that ever turns his tail to a grasshopper is the big old fellow—the ten-pounder—the “Cannibal Trout” of the Bitter Root; and almost the only bait that will raise him out is a minnow or a baby Trout.

If you ever fish a large mountain stream, a river that has large deep pools that you can't see the bottom of, go up one of the little brooks that flow into it, to where you can catch some finger-long Trout; put them in a pail, keep them alive, and go back to the river. Put on a 3-0 hook, pass the point into the mouth of one of the small Trout and out at his gill, so as not to hurt him; cast into the deepest part of the pool, let him run and you are liable to get into trouble. Understand, I don't advise this method as a steady occupation, but only as a last resort; and to take one of the big Trout in this way—one that is so blamed smart he won't look at a fly, or even a 'hopper—is, I claim, legitimate sport.

I have never resorted to this means myself, for I have

always been able to catch plenty of two and three pounders with a fly or with grasshoppers, and they were good enough; but I have known others to do so, and if ever I get left on the fair-sized ones I am liable to go after one of the big ones in this way. I speak of using small Trout for bait, only because chubs or other minnows are rarely found in mountain streams.

Worms need scarcely to be mentioned here, for they are not indigenous to the mountain soil, and so the Trout there are not educated to them. They occasionally take them, when offered, but not with the eagerness of the Brook Trout.

Of all angling known to lovers of angling, that wherein the Mountain Trout is the object of pursuit is surely the grandest, the most fascinating. That this statement will be challenged by the Salmon angler, and the more modern Tarpon angler, I am well aware; and though I grant the advocates of each of these, all the glory and all the sport there is in their kinds of fishing, yet I am prepared to stand by my assertion; and if only the devotee of either of the big fishes will but come with me into the mountains for a week, I will convince him that I am right.

The joys of Mountain Trouting are largely owing to the surroundings. The character of the streams and lakes, the grand mountain ranges that overshadow them, the rare, exhilarating atmosphere that fills the sportsman's lungs and buoys up his spirits, are conditions that are not enjoyed in any other class of fishing, unless it be that for Salmon, and not usually even this. Then the fact that the Trout rise greedily at almost every cast, and that frequently a dozen or more of them will rush for the flies at once, while in Salmon-fishing a rise is a thing usually to be long and eagerly worked for before being obtained, places Mountain Trouting far in advance of it, in the opinion of most men who have enjoyed both, notwithstanding the difference in size of the two fishes.

A better idea of the sport under consideration may per-

haps be conveyed by a narration of a day's experience in it, than in any other way, and this I will venture to give.

On a bright morning in May, 1888, I left Tacoma, Washington, on an east-bound Northern Pacific train, and after riding some distance up the Puyallup Valley I left it, crossed through some heavily-timbered foot-hills and emerged on Green river, a good-sized stream that rolls down out of the Cascade Mountains. At the first station on this stream, I went forward and got on the engine in order to get a better view of it. I had been over this part of the road before, but in the night, and had not seen this stream. I inquired of the engineer and fireman concerning the fishing, and they said it was good; that several large catches had been made within the past two weeks, and that one Trout weighing seven pounds had been taken a few miles above where we then were.

The fever began to come on me at once, and as we thundered round the short curves and sped along rocky walls, ten or twenty feet above the stream, as we rolled over the numerous bridges whence I looked into the sparkling, eddying pools and saw great dark-backed Trout, darting hither and thither in flight from the rumbling monster above them, I became more and more nervous. Great mountains rose from the bed of the river, and here and there the stream hewed its way through imposing ledges of granite. Occasionally the engineer would call my attention to a dissolving view of old Mount Tacoma, now but a few miles away, as we sped by an opening in the foot-hills. Then he would point out a rugged mountain side, whereon some hunter of his acquaintance had slain a bear, or a dark canyon wherein someone else had killed a cougar, or a clump of pines in which a big elk had fallen a prey to still another sportsman. Then he would tell of the sheep and goats on the peaks farther back, of the trail to Tacoma and of the coal mines back in the hills. But though all these things would have been full of interest to me at

another time or in another place, I heard little of them now. I was too busy watching the rapidly changing panorama of that grand torrent beneath our wheels. Not a stroke of the piston rod or an exhaust of the cylinder, as the great engine climbed the steep grade, and rounded the ever-recurring curves, but revealed new beauties, and inspired fresh admiration.

I inquired the distance to the point where we should leave the stream, and learning that it was yet some miles ahead, I rushed back to the coach, found the conductor and besought him to give me a stop-over check, and have my baggage unloaded. He complied, and a fellow-passenger who had been watching the stream, and had heard our conversation, made a similar request. So we were both unloaded at the mouth of a wild gorge where there was a small, new board building, that served for the station, and a few log-cabins occupied by the section men.

The sun was now well toward the zenith, and by the time we exchanged our good clothes for our fishing suits, and got out our tackle, the dinner-horn blew. We went into one of the cabins, elbowed our way among the section men, and wrestled with corned beef, salt pork, potatoes and sour bread until we felt equal to a big afternoon's work. In the course of our conversation, I learned that my fellow-traveler was a Congregational minister, from a thriving city in Pennsylvania, and that he was on his first journey west of the Mississippi; so that this wild country was especially wild and fascinating to him.

Dinner over, we walked up the track about two miles to where there was a good place to get down to the stream, waded into it, and the trouble began at once. We entered at the head of a boiling rapid, and both cast at about the same time. I missed my first rise, but my companion hooked a big one that, after making two frantic leaps, turned and went down the stream like a bolt of lightning, taking the lead, fly, and a foot of leader with him. He appeared to be

about eighteen inches long, and would probably have weighed three pounds or more. I had meantime secured a couple of small ones, that fought gamily, but came to the net without serious difficulty. Meantime my neighbor had repaired the damage to his tackle, and at the next cast secured three—two of about a pound each, and one of half a pound. They gave him a lively tussle for perhaps ten minutes, when he netted and creeled them safely. I had meantime fished on down to the foot of the rapid without getting another rise. We whipped the big pool at the foot of the rapid, from opposite sides, without success, and then started down the next reach of swift water. At the second cast I made in this, a two-pounder took my first dropper—a brown tackle—and began a series of leaps and rushes that made me shudder. He finally headed down the stream. I gave him line, and when he had taken out perhaps fifty feet of it I felt a fearful surge on my rod, that told me plainly my foe had received reinforcements. An instant later a Trout fully twenty inches long leaped full out of the water, turned a complete somersault, shook his jaws savagely and returned to the foaming element, with a splash that threw sparkling drops high on the shore. The big fellow now headed up the stream with such vigor and determination as to tow his mate bodily through the current for some twenty feet, though the junior captive plunged and bucked like a wild cayuse in his efforts to resist. I trembled for my tackle, but, releasing the spring of the automatic reel, every inch of slack came in as fast as it was given.

The big Trout soon tired of his load; turning square about, he made a dive for the pool at the foot of the rapid, and his running mate seconded the motion. Again I pressed the spring, and the reel sung a lively song as the line went out. Meantime, I followed as fast as I could, but my footing was insecure, the rocks slippery, and I was in constant fear lest an unlucky slip should land me on my back in the icy water.



DOLLY VARDEN TROUT — *Salvelinus Malin.*

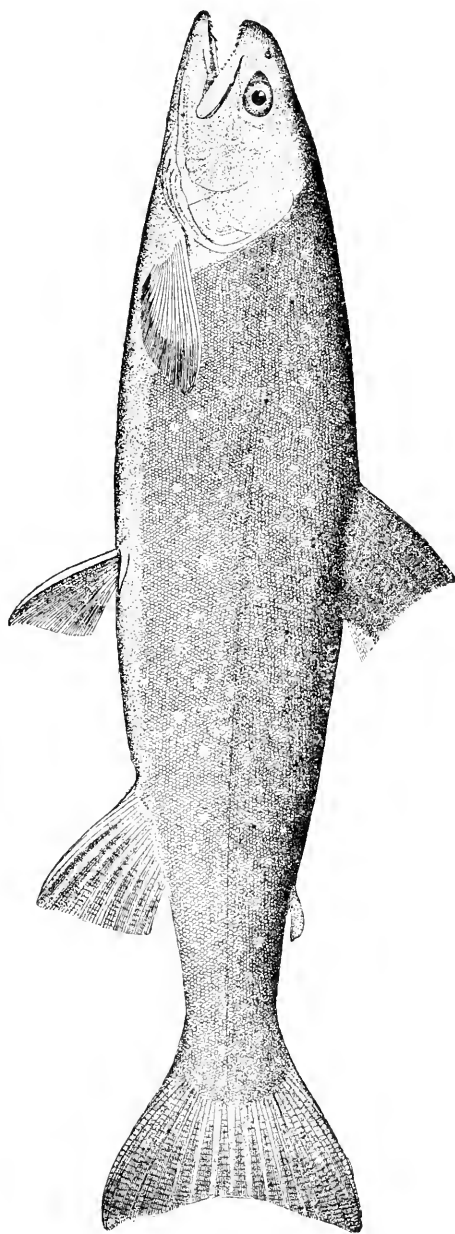

When the pair of racers reached the deep water, they were nearly a hundred feet ahead of me, and I wished I could have had a telegraph wire on them, instead of the little frail silken line that was singing through the water and vibrating in the air ahead of me.

I held it taut, rushed down the river as rapidly as possible, taking up all the line I could get as I went. When I reached the head of the pool and got a footing on a bed of gravel at the water's edge, my hopes returned, but I was still sorely harassed by fears, for my Trout were now cutting, darting and leaping hither and thither at such a rate that it seemed impossible that the delicate tackle could stand the strain much longer.

Presently the smaller of the two began to tire of the uneven contest, and gradually yielded to being towed about by his powerful companion—sometimes on his side and sometimes on his back.

I now took a firm control of the big one, and commenced to haul in on him. He still resisted and fought obstinately, but time and his heavy load at last began to tell on him too. His rushes became less vigorous than at first, and he yielded more and more to the strain of the rod. He had now not more than twenty feet of line out, and occasionally showed a disposition to stop and rest, but this I did not allow. I stirred him up and kept him moving. Gradually he submitted to tension. I got the landing-net ready, and waded out till the water came near the tops of my rubber boots. I made one more recovery of line, passed the rod well back over my shoulder with my right hand, and as the two racers came floating helplessly toward me I slipped the net under them, raised them partially out of the water, staggered to the shore, and sank on the gravel almost exhausted, but as proud a man as ever drew the breath of life.

The parson, who had long since quit fishing, came down to the pool and stood watching the fight; but I didn't know it until he spoke.

"Great Cæsar!" he said, as he saw the fish safely enveloped in the net; "that sight is worth all my trip has cost from Pennsylvania out here. If I could catch such a fish as that big one, I don't think I should sleep a wink for a week."

"Well, I hope you'll get a larger one before night, though I don't want you to lose any sleep over it, if you do."

I lifted the two fish from the net, laid them tenderly on the gravelly beach, and we sat down to admire them; and if God ever made anything more beautiful than they were, it has not yet been my good fortune to see it. Their symmetrical shape, the dark green of their backs, the iridescent, silvery whiteness of their sides and under parts, all sprinkled with tiny black dots; the scarlet covering of their throats and the delicate tinting of their fins—all combined to make up an ensemble of loveliness that could scarcely be excelled, if all the elements of beauty in nature were merged into a single object.

The larger of the two Trout measured twenty and three-fourths inches in length and twelve and one-fourth in girth; the smaller fifteen and one-half in length and six and one-half in girth. We regretted that we had not a scale with us, but estimated the weight of the larger fish at something over four, and of the smaller at two pounds.

After resting a few minutes I began to dismount my rod.

"Why!" said the parson, "what on the earth are you doing that for?"

"I'm through," I said. "I've caught all the fish and had all the glory I want to-day."

"But you surely are not going to quit fishing while you are in the presence of such lovely water and such glorious sport as this?"

"That's just it. I have had enough of it, and I could not think of breaking the charm cast upon my fancies, by killing that pair, with catching even one smaller and less noble Trout. I will go with you the rest of the afternoon, enjoy

seeing you fish, and help you, if you need my services in any way, but for myself, I have had enough."

I had a good deal of difficulty in getting the big Trout into my creel, but by carefully curving him around, I succeeded. The parson had resumed operations, and just as I finished stowing away my reel and flies, he struck a large one, in the big pool, with which he had grand sport for some fifteen minutes. He finally succeeded in landing it, and when the tape-line was applied to it, it scored seventeen and one-half inches. Then we followed down over a succession of rapids for probably half a mile, to a point where the river made an abrupt turn and had cut a deep hole in the opposite bank. A shelving ledge of limestone projected out over this, and beneath it the water whirled and effervesced, flecked here and there with little balls of foam that came dancing down in a never-ending procession, from the foot of the rapid.

"Look out for a big one there, parson."

"It does look promising, don't it?" and he made a skillful cast, his flies falling gently on the whirling water, well over toward the shelving rock. Instantly there was a commotion on the surface, and the form of a mighty Trout was seen to whirl upward and dart back under the rock. The parson struck at the proper instant, and settling the butt of his rod well forward, checked the rush of the fish slightly, when it turned and made a dash up toward the head of the pool. The parson gave him line, and he sailed through the water, with the speed of a carrier-pigeon through the air, until he reached the very foot of the rapid. Then he turned and made another dash for the hole under the rock. The angler reeled in his line as rapidly as possible; but the fish was too quick for him, and darted under the rock, leaving several feet of slack hanging loosely in the water. I shuddered lest it should foul on some projecting rock; but when it came taut again, it seemed to be clear. The Trout sulked for a moment, but the parson urged it; when it felt the twang of the steel in

its jaw it came out again like an arrow, and this time went down stream. It took out the line rapidly, and before it could be safely checked was leaping and cavorting in the lower rapid, threatening destruction to the tackle.

I shouted to my companion to give him line and run down stream. The parson obeyed, but it took him some time to get over the rocks and logs that environed the pool, and when he did reach the foot of it the fish was seventy or eighty feet below him on the shoal, and still fighting like a wild cat. The parson plunged into the water and started down stream on a run, knowing that the only hope of saving his fish lay in getting him into more quiet water. But he had only taken a few steps, when his foot slipped off a treacherous boulder; he staggered, and tried to regain his footing, but the more he struggled the more his feet became entangled in the rocks; and at last he lost control of his movements entirely, and went down full length in two feet of icy water. I rushed to his assistance, but before I could reach him he had regained his footing and stood, half-strangled, gasping for breath, with the water running off him in torrents, but bravely hanging on to his rod, though his hat was being whirled away on the angry flood toward Puget Sound. I ran down-stream, waded in and intercepted it, and the plucky parson came staggering along with his fish still under fair control. As soon as it reached the next deep water, it began to circle, which enabled the parson to take up line as he came on down. He got a firm footing near the foot of the fall, and from that time on the fight was one-sided. The fish soon began to yield visibly to the pressure of the rod.

The parson handled him with rare skill, and soon had him completely exhausted. I was on hand with my landing-net, but my neighbor courteously declined my services, declaring that he must reserve that pleasure for himself. A few minutes later he deftly passed his own net under the now almost lifeless Trout and carried him ashore.

He was the very counterpart of mine, and not until we measured him could we determine any difference in size; then we learned that the parson's fish was a quarter of an inch longer than mine. The killing of this Trout had occupied, as nearly as I could judge, about twenty minutes, but the parson thought it must have been an hour.

He now took off his rubber boots, poured the water out of them, wrung his coat and vest, and as the sun was already behind the mountain we decided to go to the station.

The parson insisted that the memory of that day's sport should ever be one of the fondest of his life; and as for me, I have had few days that I recall with feelings of more genuine pleasure.



## SEA-BASS AND OTHER FISHES.

BY S. C. CLARKE.

THE CHANNEL BASS OR RED-FISH—*Sciæna ocellata*, (Gunther.)

MUCH has been written on the Striped Bass, more of the Black Bass, and their allies, the White, Green, and Speckled Basses, but few writers have treated of the above species, which is a fish of great merit in many ways. It is known to school-men as *Perca ocellata*, Linn; *Corvina ocellata*, Cuv. and Val; *C. ocellata*, Holbrook; *Sciæna ocellata*, Goode and Jordan.

With names in the vernacular, it is still more liberally supplied. Channel Bass, Red-fish, Red-drum, Red-horse, Spot, Sea-Bass, Branded-drum, and Bass, pure and simple these according to locality, from Barnegat Inlet to Texas. As Professor Goode remarks, "this species is very much in need of a characteristic name, as all the above names belong to other species," and he suggests "The Southern Red-fish" as most suitable. An objection to this is that the fish is not always red, the young being not at all so, and the adult fish as often of golden hue as red, and to change the popular name of fish or bird is perhaps impossible.

Our Bass is a stout, thick-set fish, in color reddish-brown on the back, red or golden on the sides, according as the fish is found in fresh or salt water—white beneath, with one or more black spots on the base of the tail. Hence the specific name, *ocellata*, signifying "eye-shaded spots." It is well

supplied with large fins, and covered with big scales, which in large specimens are removed with a hoe. Head and mouth large, with fine teeth in the jaws, and paved teeth in the throat. The lips are tough, holding a hook securely, when lodged. In size from one pound to fifty, averaging, says Prof. Goode, ten pounds; but in the experience of the present writer, somewhat less—perhaps seven. The smaller ones run in companies, and go by the name of "School Bass." The large ones go in pairs, or singly, and are called "Channel Bass." It is not a shy fish, like the Striped Bass, requiring delicate tackle and long casts for its capture, but is a bold biter, always hungry, and ready to play his part—and he plays it well, fighting hard and long on the hook in open water—disdaining such tricks as running into holes, and taking the line round roots and snags, or sulking at the bottom like the lordly Salmon, or biting off the line like the Shark or the Pike. By his deeds, if not by his words, the Red Bass tells the angler that it is to be a fair fight and trial of skill and strength between the combatants; and I have seen a large Channel Bass break a heavy cod-line, in the hands of a too impatient fisherman who tried to force the fighting. Be it remembered that the native fisherman on the southern coast uses the hand-line.

From its size, abundance, game and edible qualities, the Channel Bass may be considered the most valuable sporting fish of the southern coast. In its habits it somewhat resembles the Striped Bass of northern waters, and many of those, who have taken both species on a rod, consider the southern fish as equal to the other in game quality; and the pursuit of our fish has this advantage: that the angler may rely, three days out of four, in making a catch; whereas the rule is reversed in the case of the Striped Bass. If you can kill a good-sized Striped Bass, one day in four, you do better than the average—as far as my experience goes. How many days I have sat on the rocks at Newport or Narragan-



RED FISH—*Sicaria oculata*.

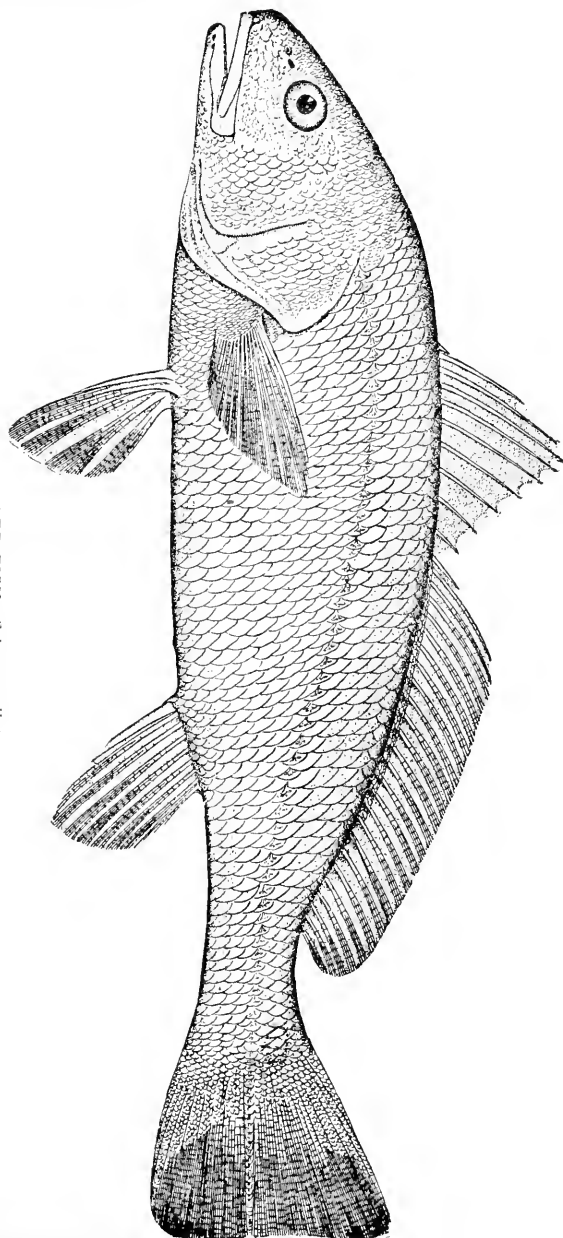

sett, with a crowd of patient anglers, waiting for the strike of a Bass—which came not.

This species roams widely. In summer it is taken as far north as Barnegat, and of very large size. At all seasons it is found on the Atlantic and gulf coasts of Florida, and on the coasts of Georgia, the Carolinas, and Virginia. In winter it is confined to Florida waters, running well up into fresh water, but disappears when a norther brings cold weather. Seldom have I seen a Bass at these times; but as soon as a change of wind brings warm weather we find the Bass on hand, ready for business. Good fishing-grounds are at the mouth of the St. John's river, and this fish has been taken as far up as Magnolia, some fifty miles from the sea. I have also taken them in the fresh water of Spruce Creek, while trolling for Black Bass. Bass are taken on the beach near St. Augustine; at the Halifax River Inlet is also a good fishing-ground. New Smyrna, on the Hillsboro' River, and the Indian River Inlet, where the writer, in 1870, found the fish too abundant and eager to be caught—but perhaps this objection has been removed by the large number of anglers who have frequented that region of late years.

In summer the Bass is found along the beach in immense numbers. As the fishermen say, "the surf is red with them," and great sport may be had with rod or hand-line, by casting into the surf, as the fish seem to fight harder in open water than in the rivers. The water being quite warm, say seventy degrees, wading is agreeable, and to capture a ten-pound fish while indulging in a warm bath is a novel experience to most anglers. Sharks are found sometimes in the surf, but do not come into the sloughs, or depressions of the beach, where the Bass come to feed.

Bands of roving hogs frequent the beach, and were ready to steal my fish if exposed; and once I found a couple of marsh ponies devouring my Bass; in this region man, beast and bird all live on the fruit of the sea, and there is enough

for all—those destructive engines, the pound-net and the mile-long seine, not having as yet been introduced. Twenty-five or thirty Red Bass have been taken by one rod, in the Halifax, in a day, weighing some two hundred to two hundred and fifty pounds. The largest one ever taken by the writer weighed thirty-seven pounds, and the struggle lasted about forty minutes. It was taken on a rod, from a boat, and the fish towed us at least one hundred yards before it was gaffed. Its mate, weighing twenty-five pounds, was soon after taken by my boatman, with a hand-line. My next in size weighed thirty pounds, and while playing it, my companion hooked its mate, weighing twenty-eight pounds, at the other end of the boat. Both were saved in about thirty minutes time. The same tackle that is used for the Striped Bass is suitable for his southern cousin, except that a sinker of one or two ounce weight is used in casting from the reel, and it is unnecessary here to use gut or delicate tackle, which is apt to be cut by the oyster shells that cover the bottom of the best feeding-grounds of the Bass. Use a two-pieced bamboo rod—what is called a chum-rod—eight feet long; one hundred yards of Cuttyhunk line, and fifteen thread, with multiplying reel, with drag. In the matter of hooks, anglers have their different fancies, and I have never been able to find exactly the hook for Red Bass. It should be sharp and penetrating, and at the same time heavy in the wire—the hollow-point Limerick, seven-o, does pretty well, but I have seen a hook known as Abby & Imbries Whiting hook three-o, which I prefer—I use them ringed, as more easy to tie to the snood, for which I use a cotton line rather heavier than the reel line, as a fine line is apt to be frayed off by the teeth of the Bass. We lose many hooks from the oyster shells, and some anglers use a fine wire next the hook. Perhaps the best pattern of hook is the Sproat, but they do not come ringed or flatted. Add to this equipment a stout long-handled gaff, and a pair of knit

thumb-stalls and you are ready for the fray. The Bass come in from the sea with the tide, and are found at different stages of it, either near the Inlet, on the sand banks, in the creeks, or along the edge of the marsh; and a stranger needs a guide to find the fish. For bait, cut-mullet, or small ones used whole; the half of a crab is a good bait also. We usually fish on the bottom, but Bass will take at mid-water, or on the surface, and often near the boat. This fish spawns in August or September, in the inlets and bays, as I am informed by Florida fishermen, and deposits many eggs, making it a prolific species—perhaps the most abundant on the southern coast. Specimens of ten or twelve pounds are the best for the table; the large ones are coarser, and the young fish have less flavor. They may be boiled, baked, or fried, and make a firm, well flavored and succulent dish.

The following description is from Jordan and Gilbert's Synopsis of the Fishes of North America:

*Sciæna ocellata*—Gthr. Channel Bass—Red Bass: Grayish silvery, iridescent; scales with dark spots forming faint irregular undulating stripes; upper part of base of caudal with an oval black spot as large as the eye, bordered by white or orange; this spot is often duplicated. Body rather elongate, not much elevated, compressed behind, an almost even curve from snout to base of dorsal; preopercle distinctly serrate; eye large; one and a half in. snout; five and a half in. head; gill-rakers short and thick; mouth large; maxillary nearly reaching the posterior margin of the orbit; caudal truncate; second anal spine rather strong, two thirds as long as first ray; pectoral fins very short, not reaching half way to lower; pharyngeals narrow, with conical teeth. Head  $3\frac{1}{3}$ ; depth  $3\frac{1}{2}$  D. X.—I. 25; A. II. 8; Lat. I. 50. Cape Cod to Mexico, common southward; known at sight by the peculiar caudal spot.

#### BASS-FISHING IN WINTER.

“The noble bass, with scales intensely dyed,  
At bay and inlet drift in with the tide;  
A roving fish, deep channels it explores,  
Mud-flats, and oyster-beds, and shelly shores.”

—*McLellan's Poems of the "Rod and Gun."*

In the month of February, 188-, leaving the frosts and

snows of New York, with the mercury near zero, my young companion and I, after three days of easy travel, found ourselves under the sunny skies of Volusia County, East Florida, at a point known on the maps as Mosquito Inlet, and at the pleasant cottage of B. C. Pacetti, sometimes called "the count"—perhaps because one of nature's noblemen—at any rate the head fisherman of the coast. The house stands on the bank of the Halifax River, which enters the ocean a mile below, in a fine orange grove, at the time of our visit full of delicious fruit, of which we took many samples the first day.

My companion I will call "the major," because he was a minor, young, and ambitious of killing the big fish of which I had told him—his former experiences having been confined to Black Bass and Trout. In this narrative, I shall be known as "the judge" as everybody in the south is expected to have a title, and this one suits a man of ancient if not venerable aspect.

Having filled ourselves with the golden fruit, and drank by way of contrast of the powerfully flavored sulphur water that flows from a fountain in the grove, we unpacked our tackle and made ready for the morrow. It dawned bright and propitious, with the south wind, loved by anglers, even from the time of Father Walton. We started at eight o'clock after a breakfast of sheeps-head and oysters, cooked by our good hostess in a style the result of many years experience.

P. had a roomy and comfortable flat-bottomed boat ready for us, and with him at the oars, we went up the river, with the tide about one-quarter flood. "Where will you take us to-day?" I asked. "I think I will go up Spruce Creek; the tide will serve both ways." The Halifax River, so called, is one of those long, narrow bays or sounds, which are found along the Atlantic coast from the Delaware Bay to Florida; this one is about thirty miles long, running north and south; and from half a mile to a mile in width, shut off from the

ocean by a narrow peninsula of sand hills, and navigable for small craft in its whole length. Another river or bay, coming from the south, enters the ocean at the same inlet; this is called the Hillsboro' River, and is some twenty-five miles long, being connected at its southern end with the Indian River by a canal. On the Hillsboro', is the town of New Smyrna, one of the oldest in Florida, having been founded during the English occupation in 1769. Its interesting and painful history may be found in a work called "Old St. Augustine," published in New York in 1885, by Chas. B. Reynolds. It was destroyed during the Seminole war, and afterward in the War of Secession, and has but lately begun to grow to the position which its situation and rich lands will ultimately give it.

Our host comes of the Minorcan race, which settled New Smyrna, one hundred and twenty years ago, and is a fine, vigorous looking man of fifty years.

We cross the Halifax River to the mouth of Spruce Creek, about one hundred yards wide, flowing through a labyrinth of islands and creeks reaching many miles south and west. Here P. stops at a sandy shoal to catch mullets for bait. This is done with a cast-net, in the use of which Florida fishermen are expert. A circular net, about ten feet in diameter, loaded at the edges with lead, and so arranged as to draw up into a bag, with pockets at the sides to retain the fish. P. takes the net in both hands, with the drawing cord in his mouth; he wades along the shoal, looking for Mullet; with a circular sweep the net falls on the water, and sinks to the bottom. He hauls it in slowly, and we see the glittering Mullet within the meshes. He comes to the boat with half a dozen fish, eight or ten inches long, bright and silvery. In the course of a few casts he gets twenty more, which will suffice for a day's fishing. The cast-net is absolutely necessary to the Florida fisherman, as the Mullet is used for bait for all the best fishes, except Drum and Sheeps-head. Besides

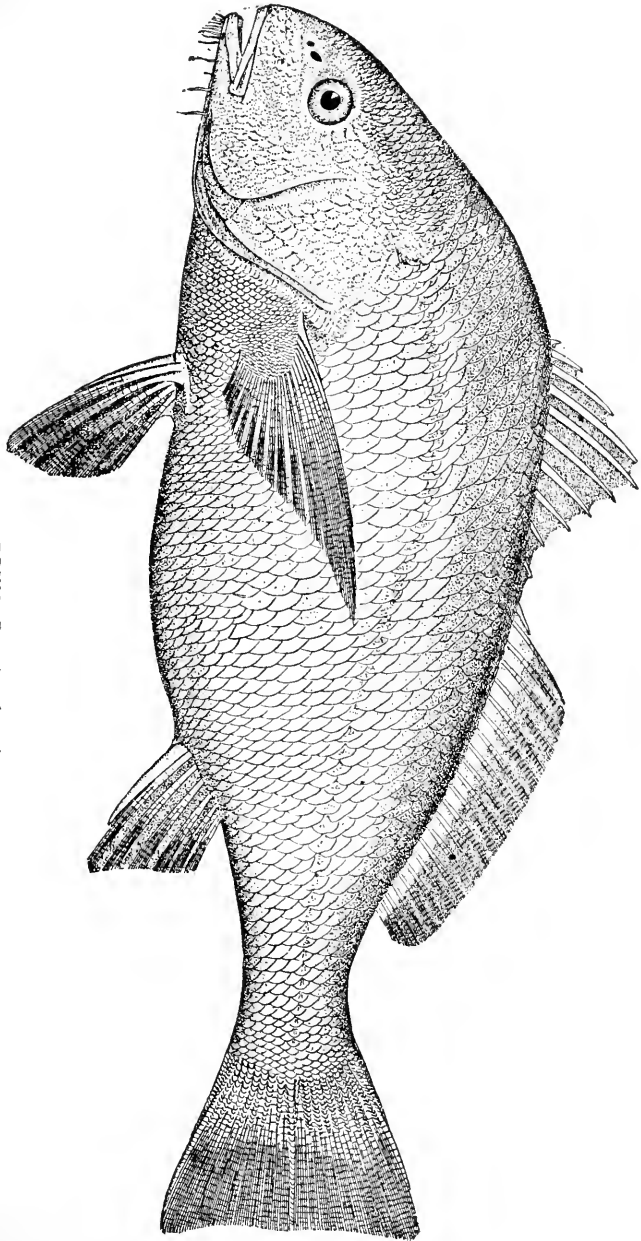

DRUM—*Pogonias cromis*.

which, the Mullet is, in summer, considered the best table-fish on the coast. The use of the cast-net looks easy, but it really requires considerable practice and some strength of arm to deliver it properly; and the beginner must be careful to have no buttons on his dress to catch in the net, otherwise it may pull him down, as has often happened to ambitious novices.

We then proceeded up the creek, the banks of which are low and covered with salt grass, and bordered with mangrove trees; the trees which, as we learn from scientists, have built up the peninsula of Florida, assisting the subaqueous work of the coral insect. We anchor in a deep channel about half a mile above the mouth of the creek, and near the bank; the beat swings to the tide. I take the stern, the major amidship, and P. at the Low. We then cut up a few Mulletts into chunks of two inches square, and baited our hooks.

We each had a bamboo rod, eight feet long, with reels holding one hundred yards of line, with 7-0 Limerick hooks, and one ounce running sinkers. I made a cast about twenty five feet astern, and P., taking the major's rod, cast the bait into midstream fifty feet away. "Now," said he, "let the bait lie on the bottom; if there is any Bass around they'll find it." He baited his own hook, on a heavy hand-line, with half a Mullet, and swinging it around his head, cast it one hundred feet astern.

We were in a wilderness of wood and water, with no traces of human occupation. A flock of blackbirds circling above the marsh, a white heron sitting on a mangrove tree, a fish-hawk occasionally stooping for a fish, and a few turkey-buzzards wheeling aloft in graceful flight, were all the animal life in view.

"How far does the tide make up here?" said I.

"Three or four miles generally, but in rainy weather the creek is fresh clear to the mouth, so that the Black Bass are caught where we are now."





PACETTIS' POINT.



"What?" said the major. "Black Bass here?"

"Plenty of them up the creek, and big ones at that," said Pacetti.

"How large?"

"Well, I've seen them caught weighing ten or twelve pounds and I've heard of some as heavy as fifteen to eighteen pounds."

"What!" cried the major. "Bass weighing twelve to eighteen pounds! I never heard of such a thing; six or seven pounds is as large as they grow at the North."

"Well, they grow bigger in Florida, I reckon," said P.—"but I've got a Bass," and he began to haul in, hand over hand, and soon we saw the red sides of a big fish, darting here and there, at the end of his line. It was a Channel Bass of about ten pounds—a fine fat fish.

"That's the kind for you to hook, young man," said P. "Do you expect to hold one on that rod?"

"I would like to try, anyhow," said the major, and just then he had a strike; his line began to run out rapidly, and he tried to stop the fish.

"Better let him run," said I, "and put on the drag." This he did, and the fish showed itself on the surface, a five-pound Bass, which, after a few minutes play, was brought along-side, and gaffed.

"Well," said the major, "that's the biggest fish I ever caught on a rod."

"You will get some twice as big, before you leave the Halifax," said P.

My bait had been lying for some time quietly on the bottom, and raising my rod, I found the hook fast to something; as I gave a pull, my line began to move slowly away, but, with great force so that I could not check it.

"I think, P.," said I, "that I have hooked what our old friend from Rhode Island used to call a barn-door."

"Well," said he, "what will you do—cut it loose, or play it?"

"It is not a very large one," said I. "I will try to kill it, and show the major some sport." The Sting-ray ran out some twenty-five yards of line, and then went to the bottom, when it stuck fast. P. took up the killick, the lines were taken in, and the boat was placed over the fish, and P. punched it with a pole till it started on another run of twenty yards, then it stopped and was again punched and followed. Then the ray started off again, towing the boat, but this exhausted its strength, and I reeled it up alongside. P. turned it over, belly up, with his long-handled gaff, against the side of the boat, so that it could not use its tail; then with a big knife he gave it several stabs in the throat and breast. The blood gushed out freely, and the strength of the ray was soon exhausted. Then the tail, with its formidable weapon, was cut off, looking like a long black wagon whip. The fish was about three feet across, and with the tail, five feet long, weighed perhaps fifty pounds.

"There, major," said P., "you can dry this tail and take it home with you for a riding-whip." Then he let loose the ray, and let it drift down the tide. "The Sharks will soon find it; there's no better bait for a Shark than a chunk off a Stingaree."

Sure enough, the carcass had not floated a hundred yards, before we saw and heard a great commotion in the water, as of big fish struggling. "There," said P., "they have got it; but we had better move away a little; those Sharks will scare away the Bass."

We went round a bend in the creek, and found a wide pool of rather shallow water with a small island in the middle.

"Here is a good place for Bass; but the bottom is all oyster shells, and may cut your fine lines, but we'll give it a try." He anchored in the middle of the pool, the water being five feet deep on an oyster-shell bank. We threw out, and in about a minute I had a strike, and found myself fast

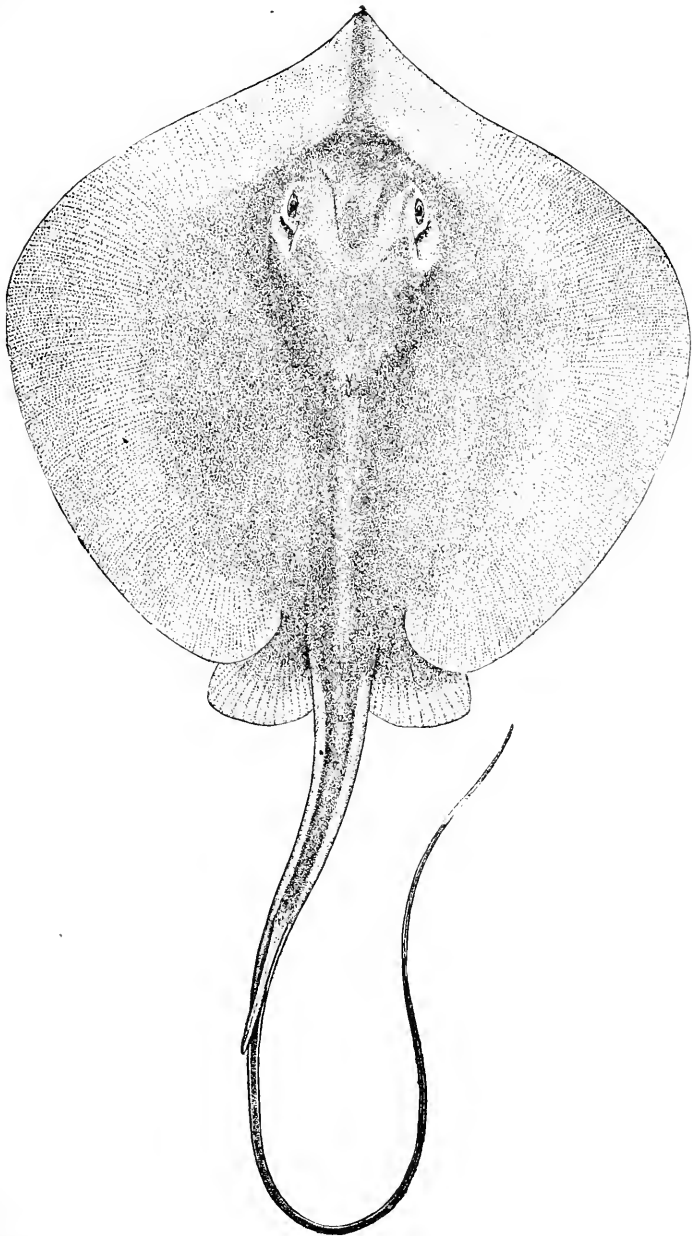

STING-RAY—*Trygon sabinæ*.

to a good fish which took across the tide. After five minutes play I had it in the boat—a very red Bass of six pounds. “This is really a Red Bass,” said I.

“They grow red up in the fresh water,” P. replied.

Now the major was fast to another; but his line came home without hook, cut off by the shells; then P. hauled in a five-pounder, and I got one of four pounds. But in my next cast my hook was cut off. We got three more School Bass here, when they stopped biting, and we moved up the creek half a mile to a large pool with a high hamak on the south side, covered with wild orange trees and magnolias.

(The above word is usually written “hammock,” or “hummock,” but I write “hamak,” as instructed by Floridians. The late Capt. Douglas Dummet, of South Florida, an educated man, long resident on the Indian River, told me that the word belonged to the Seminole tongue, and was neither hammock nor hummock. This is also the spelling adopted by Mr. C. B. Reynolds, one of the editors of “Forest and Stream,” himself a native of Florida.)

“Now, here,” said P., “we are apt to get big fish, Bass, and sometimes a Grouper.” He anchored the boat on the north side of the pool, in a deep hole where the tide ran strongly.

We with rods fished near the boat; P. sent his bait far out in the pool; the major had the first fish—a Black-fish of about a pound, which species is found smaller in these waters than further north. Then I hooked a Bass, seemingly of great size; it ran clear across the pool to the opposite bank, fifty or sixty yards away, then turning, came back at full speed, and ran wildly round the pool. After ten minutes of this work, I brought him to gaff, when it proved to be a six-pound Bass hooked in the vent, which attack in the rear had so alarmed the fish, that it became frantic and fought hard enough for a twelve-pounder. After the commotion in the pool had subsided, the major took a Bass of five pounds, and P. hooked a very large one, which, however

after five minutes play, broke his hook and then escaped.

"That's a mean hook," said he; "I ought to have saved that Bass."

"Perhaps you did not play him long enough; it was a heavy fish," said I.

"I don't believe in fooling with them. I just haul them in and give 'em no quarters," said he.

"Well, here is a hook for you that ought to stand," giving him one of my best Cuttyhunks.

Presently my line went off steadily and swiftly, and I could not check it. After sixty yards had run out and the fish still went on, I said: "He has got most of my line; I think P., that you must raise the anchor and let him tow the boat." He did so, and paddled after the fish, so that I was able to recover most of my line, but the Bass towed us some twenty yards before it gave up, and rested on the surface. As we approached, it made one more run, and then turned over, exhausted—a fine, fat, copper-red fish, which weighed, after we landed, twenty-four pounds. The contest lasted twenty minutes.

We then returned to our former station, and it being past noon we opened the lunch-basket, where we found slices of corned beef, bread and butter, and doughnuts, also a dozen oranges fresh from the trees—which always taste better to me on the water than ashore.

"How many Bass have we?" said the major.

"Eight or ten Bass and a Trout; but we will get more yet," said P. "They bite well to-day; we have not lost a fish, except the one that broke my hook. Take another orange, judge."

"I will; they are the best oranges I ever ate."

"That's what most people say—the oranges that grow on these shell mounds are much finer than the St. John's River fruit."

"Do you ever send them to market?" I asked.

"I tried it once, some years ago; I sent a few boxes to Jacksonville and when the merchant sent my account of sales, he brought me in debt seventy-five cents. Since then I find it better to eat them."

"I see," said I, "the weeds are beat down along the bank; are there any cattle on these marshes?"

"That's done by alligators—there's a big one lives about here, and I've tried to shoot him, for he eat up one of my best dogs, but the cunning brute hides away when he hears or sees a boat."

Just then the major, who had left his line in the water, saw it running off, and found a heavy fish hooked, which did not run like a Bass but fought near the bottom and seemed hard to move.

"That is a Rock Grouper," said P.; "we often find them in this hole." After about five minutes hard pulling, which tried the rod severely, the fish was brought to the surface and gaffed—a thick-set fish, brown with light-colored spots, and small scales—weighing six or seven pounds. "Just as I thought, a Rock Grouper; a good fish it is; I have taken them in summer weighing twenty-five pounds."

As the tide had turned, we concluded to drop down with it, homeward; when we reached the shallow pool at the island, the major let out a spoon with thirty yards of line.

"You might catch a Bass or Trout that way," said P., "but you are likely to hook a Shark, and lose your spoon." As we left the pool through a narrow channel with a swift current, the major had a strike, and reeled in a handsome spotted fish of two pounds or so, which P. told him was a Trout.

"It certainly looks like the Lake Trout of the Adirondacks," said the major; "but how does he come in the salt-water?"

"The fish is not a Trout," said I, "but a cousin of the northern Weak-fish, and not related to the Salmon; you see,



it has no adipose fin. It is a good fish to eat, Salmon or not."

Now the major had another strike from a large fish which took a turn, and the line came in without the spoon. "That was a small Shark. I saw him when he bit off your spoon," said P.

"Do they always do that?"

"No, we sometimes save them—that is, if the hook is so fixed that they can't get hold with their teeth; but I have no use for Sharks, and am glad to let them go—except when we go a Sharking, and then I take a big hook with a chain, with a strong rope."

When we reached the main river, P. stopped on the west bank. "Perhaps you might pick up a Bass or two here, judge."

The tide was running out strongly, and we anchored about fifty feet from the marsh, and cast toward it. The major got the first fish—a five-pound Bass; and I soon got hold of a strong fish, which proved to be a five-pound Trout, which I boated after a few minutes play.

"Isn't that a beauty," said P., as he held it up admiringly. Next, the major caught a three-pound Cat-fish—a nasty slimy creature.

"Come, major," said I; "it's time to quit, if you are going to catch Cat-fish—and in the words of Father Isaac, 'We have had a most pleasant day for fishing and talking, and are returned home both weary and hungry, and now meat and rest will be pleasant.'"

#### THE SHEEP'S-HEAD.

*Sargus Ovis*, CUVIER. *Archosargus Probatoccephalus*, GILL; *Diplodus Probatoccephalus*, GOODE.

This popular fish is, it will be perceived, well equipped with scientific names; all, however, significant of its sheep-like profile and teeth. The name given by Cuvier, *Sargus*,

says Prof. Goode, indicates its size and value; and *Diplodus*, used by others, meaning "double-toothed." The Sheep's-head is one of the few species which goes by the same name, wherever known, from Jamaica Bay to Cape Florida. The Florida people, however, omit the *s*, calling it the "Sheep-head." The ancients had a *Sargus*, to which Walton alludes, quoting his favorite Du Bartus, in a curious legend which attributes to the fish certain disreputable habits, unknown to our quiet Sheep's-head. This species is supposed to be hatched and bred in southern waters, mainly on both coasts of Florida, where the spawn is deposited at the mouth of rivers and inlets, in March and April, in the shallow water near the shore, where both sexes may be seen sporting on the sand-bars. At this time they become thin and unfit for food, and will take a Mullet bait, which, when in condition for the table, they reject. In summer they make a northern migration, as far as New York, and grow large and fat upon the mollusks and crustacea, being taken up to fifteen pounds weight, and are considered a great luxury, bringing high prices.

In 1814, Dr. Mitchell wrote that "the Sheep's-head continued about New York from June to September, and was then abundant, so that hundreds have been taken at one haul of the seine in Jamaica Bay and Fire Island. They were highly colored, and the capture of one with a hook and line was considered the most desirable combination of luck and skill. He knew an ancient fisherman who used to record in a book the time, place, and circumstances of every Sheep's-head he caught." This high estimate continues, but the record of captures in New York waters would require few pages now. The farther south you go the more abundant the Sheep's-head become, though they nowhere take the hook freely till air and water are warm. In the St. John's River in Florida they will be found all the year, though during the prevalence of a "norther" few can be taken, as they run at these times into deep water.

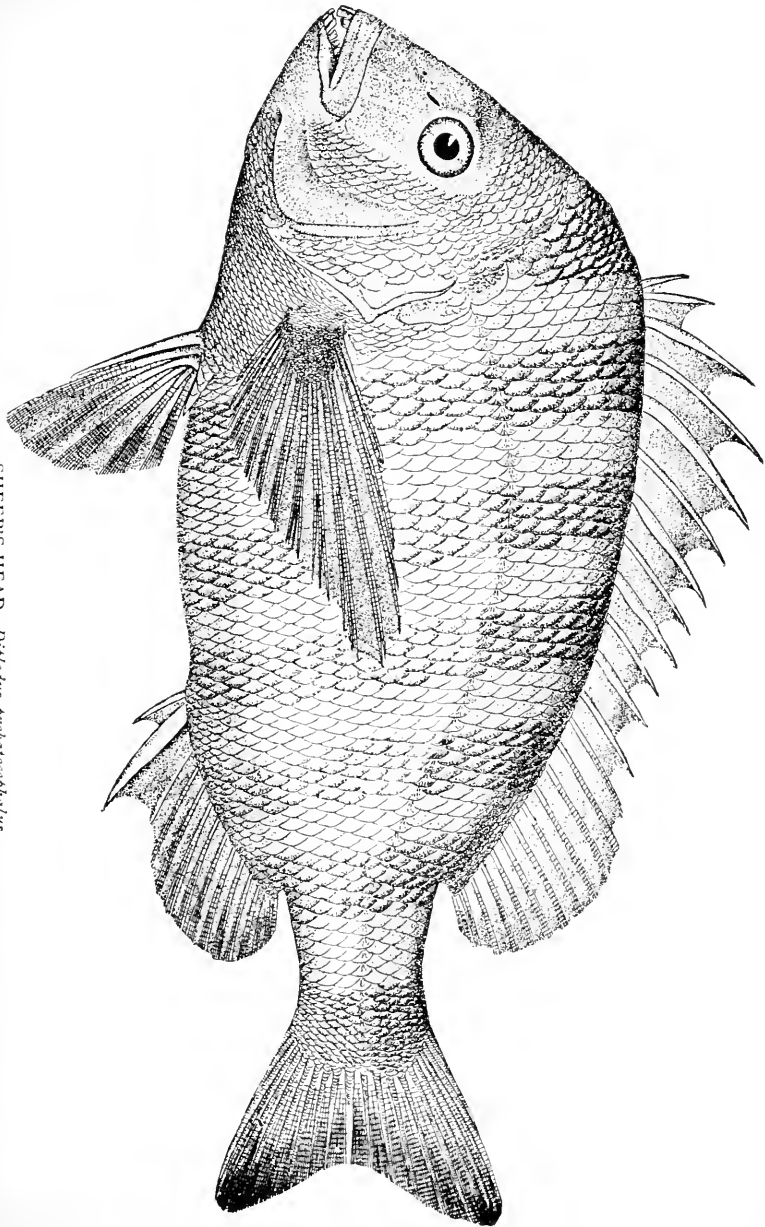

SHEEP'S-HEAD—*Diplodus prokatocephalus*.

On the coasts of Florida, this is so abundant a species as to be rather undervalued. Anglers when they first arrive, engage in the pursuit of Sheep's-head with great eagerness, but after a time it becomes monotonous to catch them at the rate of forty or fifty in a tide, averaging three pounds each. Many go to five and six pounds. My heaviest weighed seven pounds, from many hundreds; and I have heard of one of ten pounds; many are taken of four to eight ounces, which are returned to the water, fish being so abundant in Florida that the "fish hog" seldom appears.

I knew a man who caught Sheep's-head for market, and with a hand-line, and the barb filed off the hook. He could supply a smack with one hundred a day at five cents apiece. But the fish died in the well of the smack, and the enterprise was a failure. Although some Sheep's-head migrate, and some run up the rivers into fresh water, yet it is usually a stationary species, living in deep channels and tide-ways along the shores of the bays and inlets, among rocks and the roots of mangroves, and other trees that have fallen into the water, as these are soon covered with barnacles, upon which these fish feed, as well as upon crabs, clams, and oysters. Especially the small crab called the fiddler, which is a favorite bait, but it is easily taken off the hook by the projecting teeth of this fish. In places where much fishing is done, the Sheep's-head become very expert in stealing bait, and if you secure one out of four baits you do well. Where little disturbed, they seize the hook eagerly, and are easily taken by a stroke vigorous enough to penetrate the hard pavement of teeth which they carry. Their jaws are strong, and the hook must be equally so, and if large, it is necessary to give your fish line, till it is somewhat exhausted. When it is brought to the surface, it makes a violent rush to the bottom, and if too suddenly checked, hook, line, or rod is apt to be broken. It makes no long runs, like a Bass, but fights up and down, with heavy surges. A good-sized landing-net will

prevent the loss of many fish, in boating them, and the novice had better beware of the sharp and strong fin-rays, and let his boatman unhook the fish.

As to its table qualities, it is among the best of sea-fishes, firm, rich, and well flavored; either boiled, if large, or fried if small. It lives upon crabs and mollusks, which is the food of our choicest fishes—like the Pompano of the salt-water, and the White-fish of the Great Lakes. During the spawning season, the Sheep's-head becomes unfit for food; this is in the spring months, when it is usually taken by northern anglers, who at once declare the southern fish to be inferior to those of the North. When taken in the fall or winter, there is little difference in quality. The Sheep's-head is also known to feed upon salt grass, and other vegetable matter along the flats. The natives usually fish with a hand-line, and drag in the fish by main strength; more can be taken in this way in a given time, but the only sporting method is with rod and reel.

The bottom being generally foul, many hooks and sinkers are lost, so that a good supply should be taken along. A taut line should be kept, for the bite of this fish is usually very light, and you will find the bait often gone without notice given; so raise the hooks often, and you catch the fish in the act of robbing you.

If feeding at all, the Sheep's-head will take a fiddler; next in value is a large crab, cut in pieces; then the hard-shell clam, like those in northern waters, but larger. At half-tide, either flood or ebb, these fish bite most freely; at slack water they often stop feeding.

It must not be supposed that even in Florida waters Sheep's-head can be taken abundantly every day. In cold raw weather, better smoke the pipe of peace by the fireside. On such days if mine host of Ponce Park wants a mess of fish, he goes with his cast-net to some deep hole in the river, and with one throw he gets a back load. At the Hal-

ifax River Inlet, at New Smyrna, and at the Indian River Inlet, the angler will usually find all the Sheep's-head he wants; doubtless in other places also, but these can be recommended.

In Jordan and Gilbert's Synopsis, the following description is given:

SHEEP'S-HEAD—DIPLodus PROBATOCEPHALUS (WALT.)

Grayish, with about eight vertical black bands, which are about as broad as the interspaces; dorsal dusky. Body robust, becoming very deep with age; the back compressed and elevated; axis of the body below the middle of the depth; snout entirely below axis of body; profile very steep; preorbital broad. Mouth low, horizontal; incisors broad, serrated in the young, then becoming emarginate and finally entire. Cheeks with six rows of scales; scales on breast very small, crowded. Dorsal spines very strong, higher than the soft rays, the last considerably shortened, so that the outline of the fin is emarginate; second anal spine very strong, nearly as long as the snout and eye; pectoral very long, reaching past the front of the anal; ventrals reaching vent. Head  $3\frac{1}{4}$ ; depth  $1\frac{2}{3}$ . D XII, 12; A. III, 10; Scales 7—45—16. L. 30 inches. Cape Cod to Texas; abundant.

The same rig that is used for Channel Bass—a two-piece bamboo rod, eight feet long, multiplying reel with drag, and one hundred yards of Cuttyhunk line, 15-thread. In Florida-fishing, the unexpected often happens, and while looking for a four-pound Sheep's-head, you may hook a twenty-five pound Bass or other runaway fish. Some anglers put the sinker at the end of the line, and tie the hooks eight or ten inches above. Others use round perforated sinkers, with the hooks below; the sinker, from one to two ounces in weight, lies on the bottom.

Only the best Virginia hooks can be trusted to resist the jaws of the Sheep's-head (No. 4 or 5) and these sometimes fail. A piece of hemp or cotton line rather thicker than the reel-line makes the best snood; no gut, however strong or doubled, will resist the teeth of the Sheep's-head. With two

BLACK GROUPE—*Trisopterus minutops*.

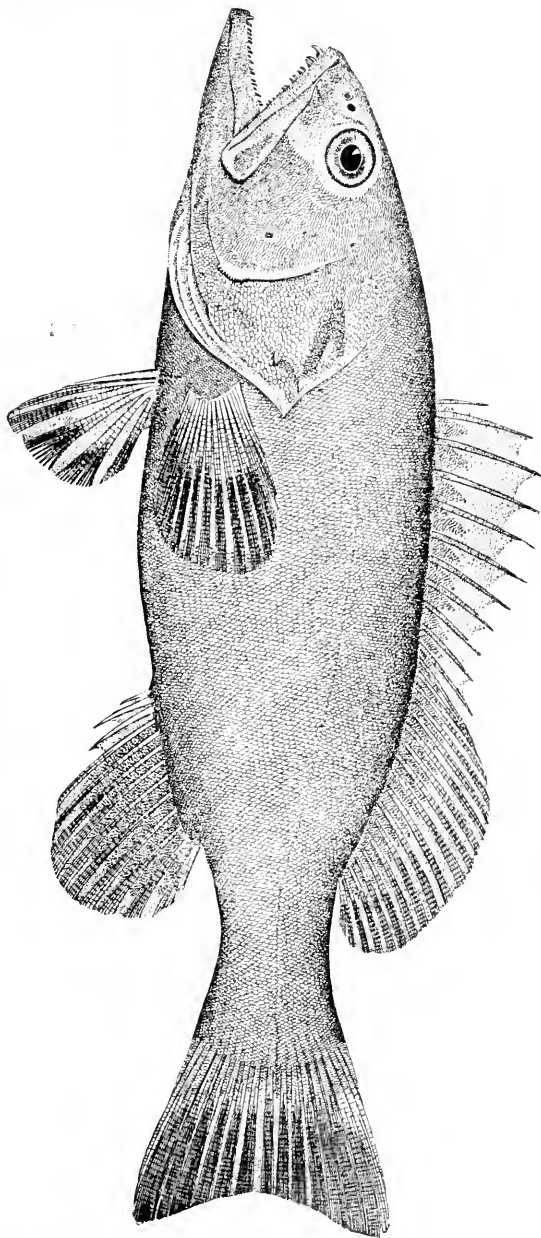

hooks, about eight or ten inches apart, the angler may often hang a pair, when, in the words of Dame Berners, "surely thenne is there noo man merrier than he is in his spyryte."

THE GROUPER—EPINEPHELUS MORIO (CUV., GILL).

I give to this well-known and valuable food-fish of the Florida coast, the name affixed to it by scientists, as I suppose, though the synonymy of the genus is much confused, and the name, to be adopted, uncertain. The description given by Jordan and Gilbert, of *E. morio*, seems more like the common Grouper than any other which they describe. Holbrook, in his "Fishes of S. Carolina," describes what I take to be the same species, under the name of *Serranus erythrogaster*. The name Grouper is found in Roman's list of the fishes of the East Florida coast. How far north it occurs I do not know, but it is abundant and large in the West Indies, as I am informed. It is a thick-set, robust fish, of the Perch family, with hard spines in the dorsal fin; large head and mouth, with sharp teeth. Color, light olive, mottled with darker lines, like tortoise shell. Fins tipped with blue; inside of mouth red.

The Grouper is found near the bottom, in deep holes and channels, near the roots of mangrove trees, under which it makes its stronghold. It is never found far from this fortress, to which it retreats when hooked or alarmed. The bait is Mullet, either cut or whole, the latter attracting the larger specimens. In size it is taken from half a pound to fifteen pounds, seldom with the net. It is voracious, but shy and easily alarmed; and after one has escaped from the hook, or after the capture of two or three, the others seem to take fright, and will seldom take a bait in that place for some days. When hooked, it makes straight for its hole, and can only by main force be kept from it; so that only those of moderate size are taken with rod and reel—say up to five or six pounds weight. The larger ones can only be



RED GROUPE.—*Epinephelus morio*.

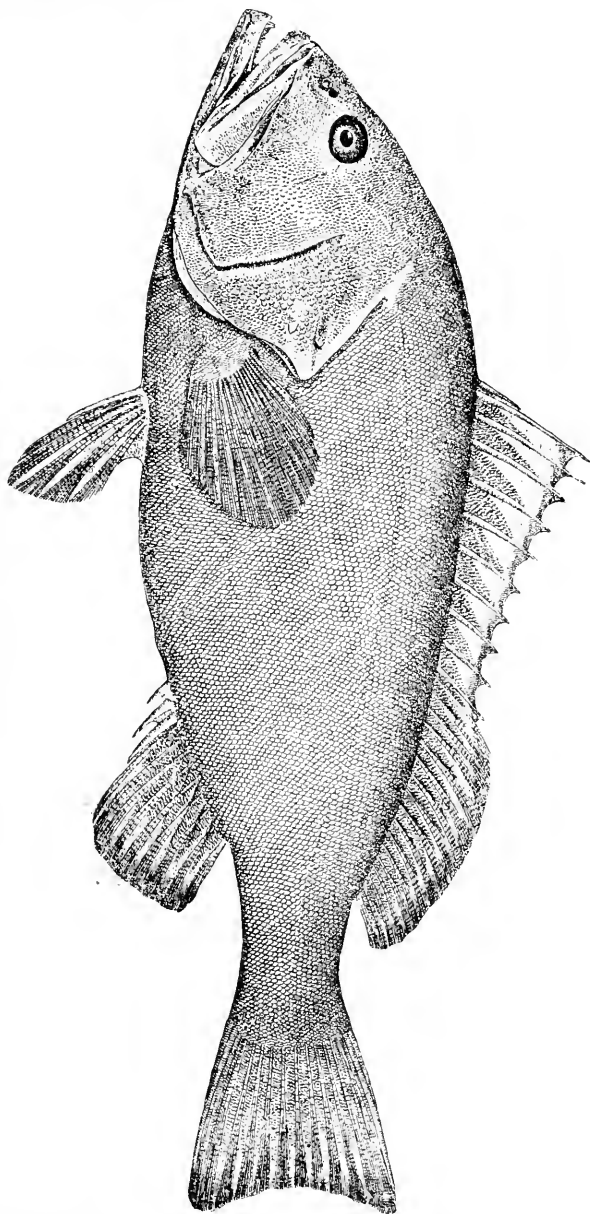

landed with a hand-line. It is a trial of strength between the man and his tackle and the fish—the latter, if of large size, often breaking loose, or gaining its hole under the roots from whence it cannot easily be dislodged, the result being the loss of tackle and patience. The rod-fisher loses more than half the Groupers he hooks. I have never been able to kill, on a rod, a Grouper over five pounds. Other rod-fishers have perhaps been more fortunate or skillful. As is well known to anglers, the first rush of a strong and heavy fish cannot safely be resisted, and the Grouper makes only one. If he would fight in open water, like the Bass, he could be tired out; but he takes all the advantage, and one seldom gets more than two or three in a day.

The flesh of the Grouper is rich and well-flavored, and is highly prized, perhaps partly on account of the scarcity of the fish, and difficulty of its capture. To my taste it much resembles that of the Red Bass, when in good condition.

#### JORDAN AND GILBERT'S DESCRIPTION.

RED GROUPE—*Epinephelus morio* (Cuv., Gill), brownish, marbled with ash; Salmon-color below; soft parts of the vertical fins margined with blue. Body oval, compressed above; profile oblique, gently curved; mouth terminal, large, somewhat oblique; maxillary reaching beyond eye; eye about as long as snout. Head  $2\frac{1}{2}$ ; depth 3. D. XI, 17; A. III, 9; Lat. I 106; cæca 28. Atlantic Coast, chiefly southward.

THE MANGROVE SNAPPER—*LUTJANUS AURORUBENS* (CUV., GILL).

Professor Jordan's description suits our South Florida fish, except as to canine, in which respect our fish resembles *L. caxis*, which has canines in the upper jaw. The generic name, according to Jordan and Gilbert, comes from "Lutjany," the Japanese name of some of the species which are numerous in tropical seas. I find the name "Mangrove Snapper" in Roman's list, and it is significant, as this species lives in holes among the roots of that tree. Jordan places it in the same genus with the Red

MANGROVE SNAPPER—*Rombolytes australiensis*.

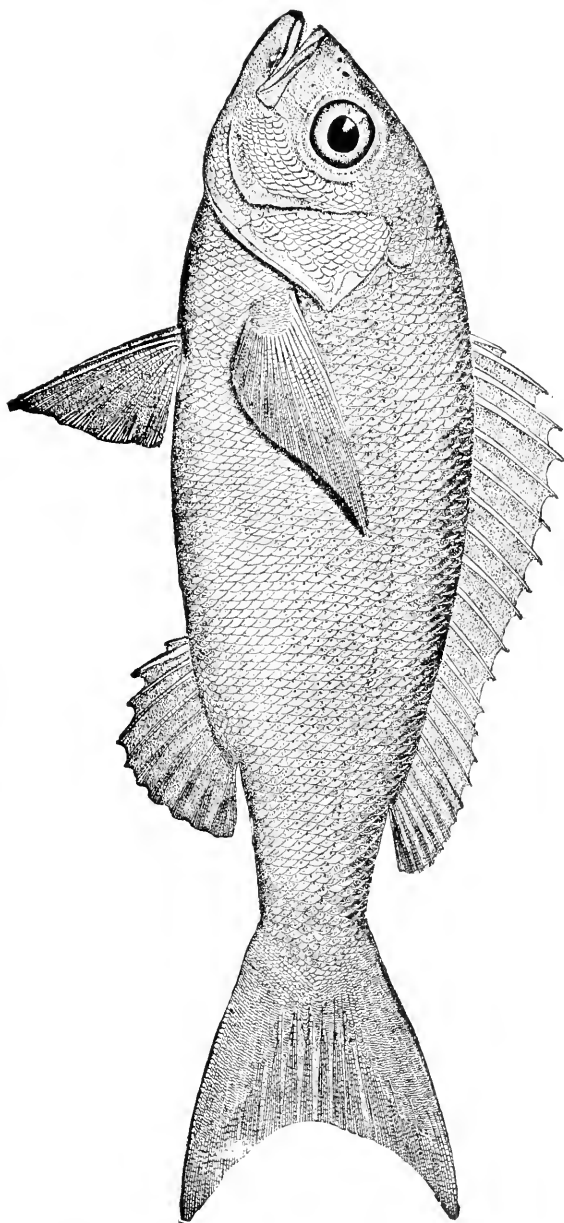

Snapper, *L. blackfordi*, which is an ocean species of quite different habits. Like the Grouper, the Mangrove Snapper is stationary, seldom found far from its hole, in which it takes refuge when alarmed. It is one of the most shy and cunning fishes of the coast, and long casts from the boat are necessary to beguile it. It makes for the roots as soon as hooked, after the manner of the Grouper, and is a more active fighter, though perhaps not stronger, than that fish. Probably fine tackle would be more successful than the coarse hand-lines generally used, but the Snapper has very sharp teeth, and silk-worm gut would stand no chance. Cut Mullet is the bait commonly used, cast as far as possible from the boat into the deep channels near the mangroves. Let the bait rest quietly on the bottom for five or ten minutes, and as soon as the bite is felt get the fish away from the bank, or he will be lost. In form the Mangrove Snapper resembles the Small-mouthed Black Bass. Color, a reddish brown, with golden reflections. Canines long, with which it snaps savagely when captured. Eye very large and bright, with golden-colored iris. Head small, with wide mouth, well filled with teeth. Half of dorsal fin with hard spines; scales large. The large eyes seem to indicate nocturnal habits, confirmed by the fact, that the Snapper feeds more freely at night, and on dark days. The fishermen say that when placed in a car with other fish, the Snapper will mangle and devour them. The young, say of a pound weight, are often in considerable numbers in deep holes, and are taken with the cast-net. Size, in Halifax River, from half a pound to five pounds. In the Indian River they have been taken of ten pounds weight. A fish of good quality on the table, and keeps well.

JORDAN AND GILBERT'S DESCRIPTION.

*Lutjanus aurorubens* (Cuv. & Val.). *Centropistes aurorubens* (Storer). *Rhomboplites aurorubens* (Goode and Bean).

"Vermilion red above, rosy below; sides with oblong irreg-

ular yellow spots; dorsal and pectoral fins red; ventrals and anal lighter. Body oblong elliptical, moderately compressed, not elevated. Mouth moderate, without distinct canines. Tongue with a large oval patch of teeth, besides which are five or six smaller patches. Nostrils round, near together. Preopercle finely serrate, its notch obsolete. Gill-rakers very long and slender. Dorsal spines rather slender; second anal spine a little longer than the third; caudal fin lunate, its lobes not attenuate. Head  $3\frac{1}{2}$ ; depth 3. D. XII, 11; A. III; Lat. I, 54. L. one foot. West Indies, north to Florida and S. Carolina."

SHEEP'S-HEADS, GROUPERS, AND MANGROVE SNAPPERS.

"There where the affluent current pours  
The deepest o'er its muddy floors,  
The greedy sheep's-head hidden lie,  
To seize whatever may float by."

—*Isaac McLellan*, "Poems of the Rod and Gun."

At breakfast the next morning we met with a new-comer, Dr. Williams, a professor in a Western College, a tall slender man of some thirty years old, with dark complexion, hair, and eyes. He had come to Florida for health and sport, and also to make collections in natural history. "What fish are these?" he inquired of our host.

"That is Channel Bass you have on your plate. The judge, here, caught it yesterday, a fine, fat fish."

Judge: "Let me recommend a squeeze of this lemon on the fish, doctor; the fish and the sauce are both natives."

Professor: "An improvement, certainly. How large was this fish?"

Host: "Twenty-five pounds, or so."

Professor: "Did you catch it with the rod I saw on the piazza, judge?"

"The same."

Professor: "Well, I want to try this fishing that I hear so much about, but I fear that my tackle will not answer; my rod never killed a fish over two pounds."

Host: "Perhaps you had better begin with a hand-line; I can fit you out."

Professor: "All right, I will do so. Do these oysters grow in this river?"

Host: "Yes, sir; we get them close by the house; but better ones grow in the other river."

Professor: "What river is that?"

Host: "The Hillsboro'—across the Inlet, about two miles south of here."

Judge: "Mr. Pacetti, as our friend here would like to go out to-day, perhaps he had better go with us, and the major can go in another boat with one of your sons."

Host: "Yes, that will do. Burt has another boat. I want to take you toward the Inlet to-day; we will fish on this shore till the tide slacks, and then cross to the mouth of the big creek, where there is a plenty of good fish."

Professor: "What kind of fish?"

Host: "Sheep's-head, Grouper, Snapper and Bass, perhaps."

Burt: "Sharks, too, father, and Stingarees."

Host: "No doubt; but these gentlemen from the North all want big fish, you know."

Major: "Me too; I want to catch a Shark."

Host: "Perhaps the Shark may catch you."

Major: "All right; I hear a great deal about Sharks, and I want to see one."

So, as arranged, we went down the river against the tide in two boats. Two hundred yards below the house we anchored near the bank in some fifteen feet of water; the bank was about ten feet high, and covered with live oaks and palmettos. One big tree was lying in the water, and near this we anchored. We had a few fiddlers for bait, this being a Sheep's-head ground. The professor's hooks were first baited by P., who threw them into the channel.

"Draw your line taut after the lead touches bottom, and watch for a nibble," said he.

I cast thirty feet astern. The tide was strong and took

BASKING SHARK, or BONE SHARK.—*Glorionus maximus*

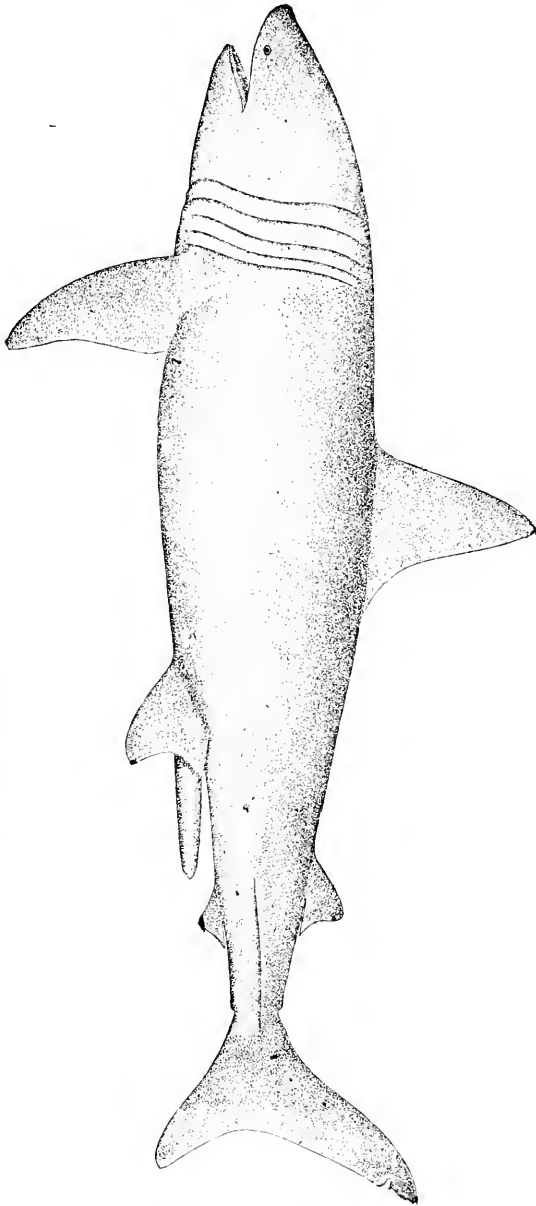

my bait some distance before it reached the bottom. As I raised my sinker, I felt a nibble, and hooked the fish, which was a good one, and made several short runs and surges before I got him near the boat, then he went for the bottom so strongly that six inches of my rod tip went under. When I got him alongside so that the net was put under him, he was found to be a four-pounder in good condition.

As P. unhooked the Sheep's-head, he said: "I reckon, professor, they have got your bait." And so it proved.

"Why, I felt nothing," said he.

"The fish in this channel are well posted," said P.; "they know how to steal bait."

Again and again the professor put out his line, and again his bait was taken. In the meantime I boated another of three pounds, and lost another by the breaking of a hook. Presently the professor managed to save a two-pound Sheep's-head, and then another. We got ten here, when our bait gave out and we went down the river. A hundred yards below where we fished, the high bank drops to a low sandy flat, which extends south half a mile to the Inlet; this flat shore extends a quarter of a mile east, to the ocean. We left this shore and struck across the river west through a mile of shallows and sand-bars, with narrow channels between them. On these sand-banks were flocks of wading birds, willets, plover, yellow-legs, oyster-catchers, and gulls, and on the bank of the Inlet sat a great flock of brown pelicans, apparently asleep, their great bills and pouches resting on the sand.

"I must come here with my gun," said the professor; "I want some of those birds for our museum."

The other boat was following us, and hailed: "How many fish, judge?"

"About a dozen—and you?"

"Only three Sheep's-head."

As we approached the west shore, we found it to be a low



region, with many creeks and islands, some of them wooded with pines and palmettos—others low, and covered with mangroves. A perfect solitude prevailed everywhere. We headed for the largest creek, which was about a hundred yards wide at the mouth, part very shallow, with a deep channel on the south side, in which we anchored near the mouth of the creek.

“I will go ashore and get some fiddlers.” said the skipper.

We both landed with him, and passing through a belt of mangroves we came to a low sandy flat thinly covered with marsh grass, where hundreds of these little crabs which go by the name of fiddlers, called by the learned, *Gelasimus pugilator*, were running to and fro. They scampered for their holes as we approached, but we soon picked up a quart or two of them, not without some pinches from the big claw which they brandished at us. Then we returned to the boat and began to fish for Sheep's-head. We found that here they were larger and bit more eagerly than at the other bank—probably because they were not much fished for here. The fun was fast and furious for half an hour, in which time we had taken twenty, averaging four pounds; then at slack water, they stopped biting. The other boat was near us, and had good sport also.

“Try a Mullet bait, judge,” said the skipper; “you might get a Grouper.”

I baited with Mullet, and cast up the channel as far as possible, and near the bank. Then the professor put on a pair of small hooks with Mullet bait to try for some small fish. Soon he had specimens of “Sailor's choice,” Whiting, Black-fish, Pig-fish, and a young Blue-fish, about six inches long. “These I want for specimens for my museum,” said he, “and here is another odd fish”—as he pulled up a vicious-looking creature.

“That is a Toad-fish,” said the skipper; “look out for his teeth!” My bait had been out ten minutes or so, when I

had a vigorous snatch at it, and hooked a stout and active fish, which made for its hole. By main strength I got it into open water, and after five minutes play, I had it alongside, when P. put the landing-net under it—a four-pound Mangrove-snapper.

“I want the scientific name of this fish, if you can give it to me, professor,” said I.

“When we get home I will examine it with the help of Jordan’s book.”

“Oh! professor, do you see that fish-hawk? He has just caught a Mullet; now there is an eagle on the dead pine on yonder island that’s watching the hawk, and you will see the rascal rob the poor hawk directly.”

The osprey caught his fish, and was flying away with it, when the eagle sailed from his perch in pursuit. When the osprey found itself overtaken, it uttered a scream and dropped the fish, and the eagle stooped and caught it before it struck the water. The osprey went off to look for another Mullet.

“There,” said the professor, “is what the books have been telling us from the time of Doctor Franklin, but eagles are scarce at the north and we seldom see that robbery; here it can be seen every day.”

“Do the eagles themselves ever dive for fish?”

P.: “Not often; they make the fish-hawks do that work; though when I catch Mullet in the fall for salting, and have a big pile of them on the beach, the eagles will come and steal them.”

Judge: “How did this eagle get its common name of bald eagle? its head is as well covered as yours, professor, though much whiter.”

Professor: “I suppose that some early observer seeing the white head from afar, took it for a bald head, and so reported it. An error, once started, has great vitality, and the newspaper writers, many of whom perhaps never saw an eagle, kept on calling it bald. Naturalists however, have named it



CANOE FISHING. ST. JOHNS RIVER

W. B. B. B. B.

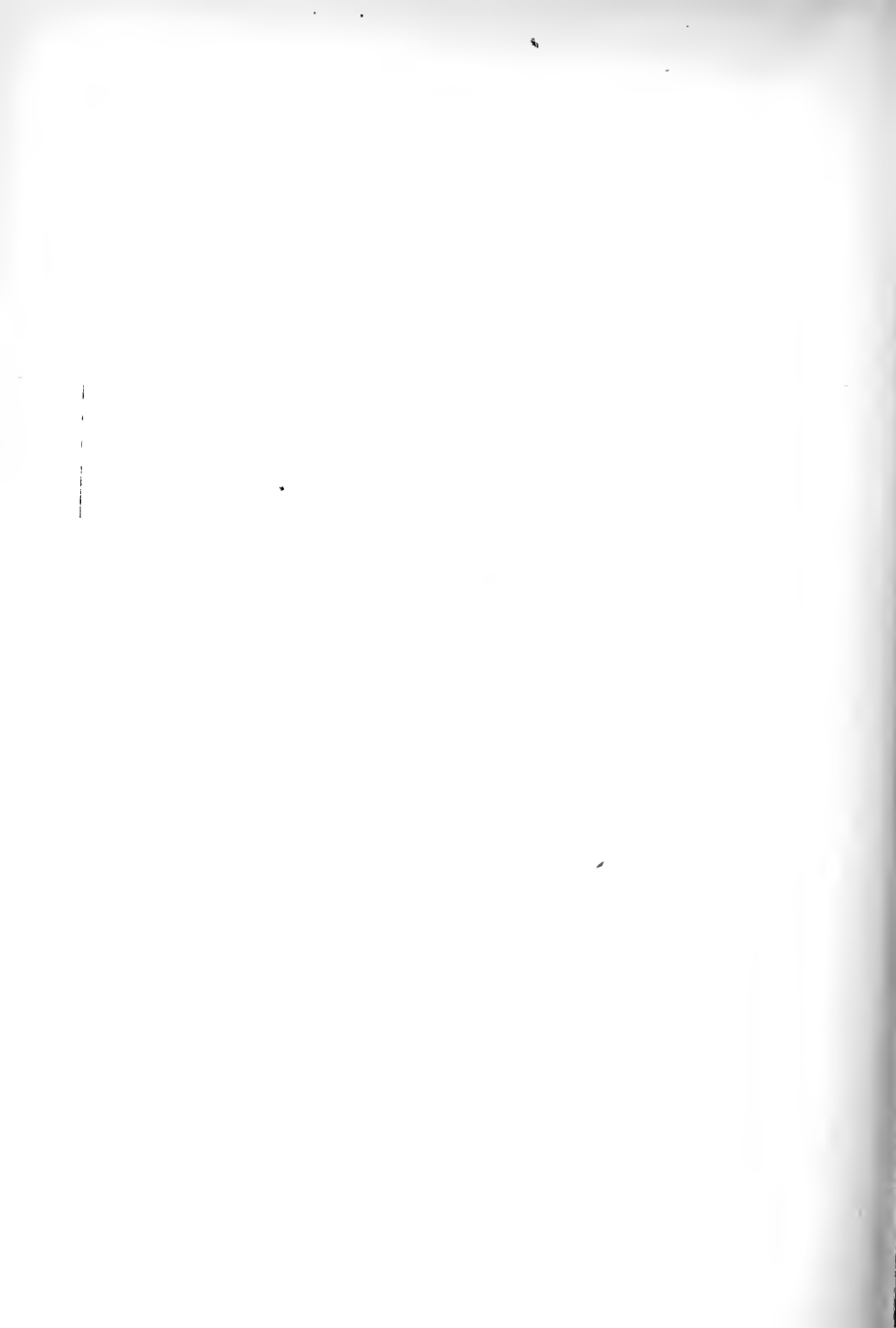

properly, calling this species the white-headed eagle—*Halictus leucocephalus*.”

Judge: “The fish have stopped biting, Pacetti.”

P.: “Some Shark or other big fish around the boat, I reckon.”

Professor: “My hook seems to be fastened to the bottom; please try to loose it for me.”

P.: “You are fast to a big fish; I can't move it. Now it starts—it's powerful strong. I know what it is—a Nurse-Shark,” and with much difficulty he began to drag it up. It was a heavy pull of a dead weight, but he got it up so that with a gaff hook it was got alongside. A thick-set, light brown fish, about seven feet long and a foot through, came slowly up. It resembled a Shark in outline but did not fight like a Shark.

“I will have to cut off the hook; it's too far inside to meddle with,” said Pacetti, “the teeth are small, but it could cut my hand off.”

Professor: “I would like to save that fish, and take his skin home with me.”

P.: “Then I will kill it, and we will leave it here on the bank till we go home.”

So we hauled it ashore and killed it by blows on the head with a club.

“Now we had better take lunch,” said P., “it's nearly noon. Ham, bread and butter, pie, and oranges; take hold, judge. Here is something I want you to try, gentlemen—Mullet roe, smoked; I put it up every year for my own use.”

Judge: “And a very good relish it is—the Mullet must be larger than those you catch for bait.”

P.: “In the fall we get them to weigh three or four pounds.”

While we lunched, my line had been in the water, and now I saw it moving; before I could get hold of the rod, the fish, probably a Grouper, had reached its stronghold under

the snags, and as I could not get it out, I was obliged to break my line, losing hook and sinker. I put on another hook, and put the bait near the same place, and in a few minutes I hooked another Grouper of over four pounds, which with some difficulty I boated. The tide having now turned, we dropped down with it, and crossed the sand flats, then anchored near the channel which led to the Inlet.

“What sail boat is that coming across the Inlet?”

“One of the Smyrna boats bound up to Daytona,” said P.

We were anchored in about six feet of water and cast our baits into the channel. Soon I had a strike, and the line ran out thirty yards, and a good-sized Bass showed himself on the surface. As I was playing it, suddenly the pull became very heavy, and a big surge appeared on the water. “A Shark has got your Bass,” cried Pacetti, and my line came in with half of a good sized Bass on the hook. “Bit it off, as if cut with an ax,” said P. “now I will have satisfaction out of that Shark,” and he took a heavy line with a big hook and chain, from a locker, and baited with the head and shoulders of the Bass, which he cast out in the channel. There was a bare sand-bank near by, and there we landed and drove a stout stake into the sand, and made the line fast to it. In about ten minutes P. began to haul in the line; as the bait came in sight we saw a large Shark following it, and when it came within ten feet of the bank, it was seized and taken away. Then P. gave a smart pull. “He is hooked! lay hold, boys—and rouse him out on the bank.” Easier said than done, for the Shark, turning, dragged the three of us to the water’s edge, and we had to trust to the stake, which, however, held, and after some heavy drags at it, we again laid hold and succeeded in hauling the Shark ashore. “Look out for his tail,” said Pacetti, as he pounded the head of the fish. It was eight or nine feet long, and showed a fearful set of teeth.

“Can I take this one too?” asked the professor,

P.: "I can catch one for you at the landing, most any time, and save the trouble of carrying it home."

"All right."

Judge: "I noticed when that Shark followed the bait, that he took hold like any other fish. Now I often read about a Shark being obliged to turn over on his back before he can take hold. How is that, Pacetti?"

P.: "Well, as far as I know, they take hold like other fish, and I have caught hundreds of them."

Judge: "Probably this is another of those popular errors, copied by one ignorant writer from another of the same kind, like the bald-eagle business, professor."

Professor: "I am glad to have seen, myself, how a Shark takes a bait."

We fished again in the channel, and got, in the course of half an hour, four Bass, weighing eight, six, five, and five pounds, and then left for home. As we went up the river, P., whose eyes were good, espied a rattlesnake swimming across to the peninsula, and started to cut it off. The snake swam strongly, with head well out of water, and when it found its retreat cut off, it turned and made for the boat. "Why," said the professor, "it is coming on board, I believe." As it came near, looking warlike and formidable, P. caught it a heavy blow with the oar, which disabled it, and it sank. "I never let one pass," said he; "they have killed too many of my dogs."

"I did not know that a rattlesnake could swim across a wide river like this," said the professor.

P.: "Oh yes, they do it; they used to be very plenty in this country, but it is settling up too fast now for them to increase much. Last summer a big one, seven feet long, was killed in my door-yard by a gopher-snake."

Judge: "What kind of a snake is that?"

P.: "It's a big black snake, seven or eight feet long, that makes war on rattlesnakes and moccasins—kills them every

time, and eats them—but he always bites off the head where the 'pizen' is; he never eats that. A rattlesnake is mighty afraid of a gopher-snake, so I use to encourage them to stay about my place; and they are great rat-killers too. But after a while they got to eating up our chickens, so I had to drive them away—but I never kill one."

The steamer that plies between the two rivers now came in sight, bringing passengers from Daytona and Ormond. She stopped at the light-house wharf, just below our house, to land passengers.

"There's more fishermen for our place," said P.; "Daytona men, I reckon. Well, we have got fish enough to feed them, anyway."

SALT-WATER TROUT OR SOUTHERN WEAK-FISH—CYNOSCION  
CAROLINENSIS (GILL).

This species is allied to the Weak-fish or Squeteague of the northern coast, but is a handsomer and better fish. Color, silvery sides, darker above, with rows of black spots above the lateral line. Body silvery. Head small, mouth large, and well supplied with sharp teeth; in form and color much resembling the Lake-trout of Northern New York, but wanting the adipose fin. Predacious in habits, takes Mullet-bait eagerly, fights hard on the hook, and gives good sport with rod and reel, though rather less enduring than the Red Bass. This fish does not well bear keeping, but eaten fresh from the water is sweet and well-flavored. It is largest and most abundant in warm weather, when it may be heard on a still night snapping along the shore in pursuit of small fish. I have taken them from two pounds to six in weight, at Halifax Inlet, in winter. Very large specimens are taken in Musquito Lagoon, south of New Smyrna, weighing, it is said, as much as twenty pounds.

It takes bait on the bottom, at mid-water, and on the surface, and I have killed them in fresh water, while trolling



SPOTTED SQUETEAGUE—*Gynoscion maculatum*.

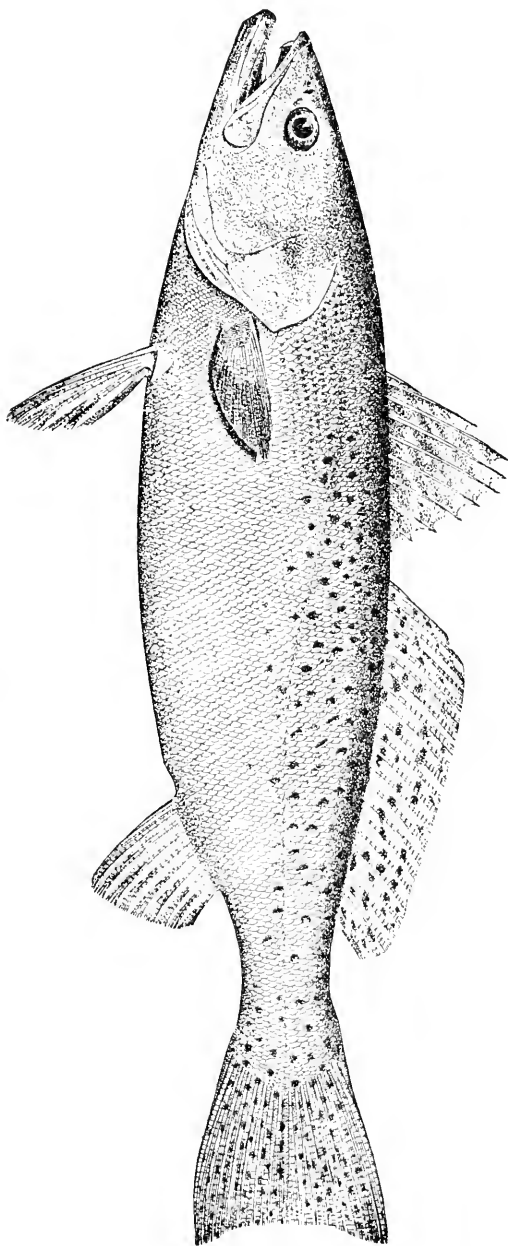

for Black Bass in Spruce Brook, a tributary of the Halifax. These were of small size, about two pounds, and were taken with a spoon; and it is said that they can be taken with a fly. It is a roving fish, and is taken on the same grounds as the Bass, preferring, however, tide-ways and rapid currents; the same tackle will serve that is made for Bass. In the Halifax River it is not abundant. One seldom takes more than four or five in a day's fishing. On the Gulf coast it would seem to be plenty, as "Al Fresco" writes of taking 383 pounds of them in one forenoon. Cut-Mullet is the usual bait, though no doubt live minnows would prove more attractive—probably also to Sharks, which abound in these waters, and take away the angler's tackle, and his fish also. One great pleasure in angling in these waters is the variety of fishes encountered; you never can tell whether your next fish will weigh one pound or twenty.

JORDAN AND GILBERT'S DESCRIPTION.

SPOTTED SEA-TROUT.—*Cynoscion maculatum* (Mitchell, Gill). Bright silvery, darker above; back posteriorly with numerous rounded black spots as large as the pupil; both dorsal and caudal fins marked with similar somewhat smaller spots, much as in a Trout and dusky maxillary reaching to posterior edge of eye; canines moderate. Longest dorsal spine not quite half the length of the head; pectorals short, not reaching tips of ventrals, not half length of head; caudal lunate. Head  $3\frac{1}{2}$ , depth 5, eye large, about six-inch head. D. X. L., 25; A, I, 10; Lat. I, about 90. Virginia to Mexico, very abundant southward."

THE CAVALLI OR CREVALLE—*CARANX HIPPIUS* (GUNTHER).

I am unable to decide to which of the species of *Caranx* that frequent our Southern coast the Cavalli belongs, but probably it is *C. hippus*. It is a fish which affords good sport to the angler, but is of only moderate quality on the table, the flesh being somewhat oily, with black streaks, like that of the Mackerel.

In form the Cavalli is deep and compressed, with a long

COMMON SQUEETEAGUE—*Gynoscion regalis*.

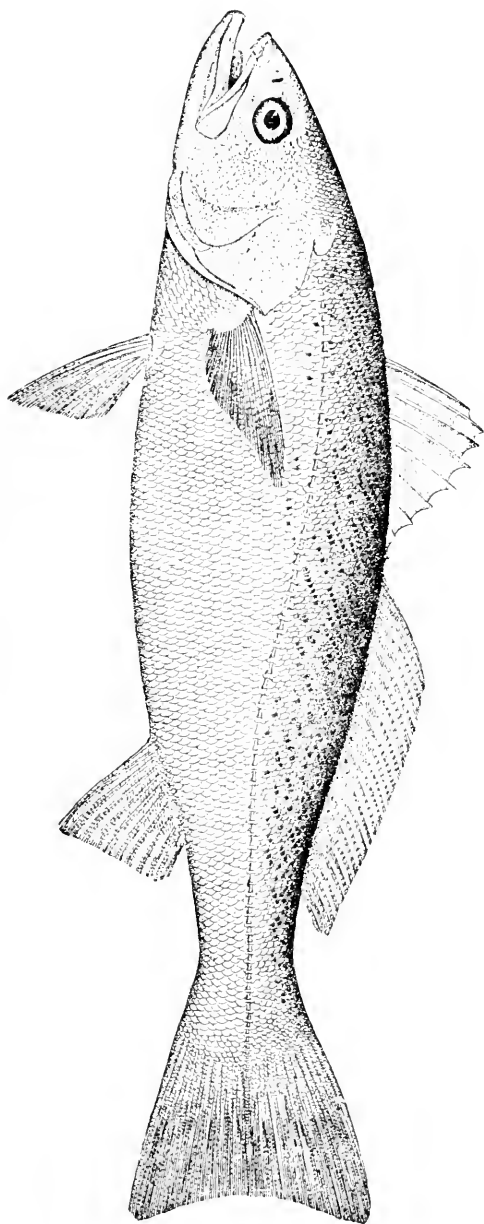

double dorsal fin extending to the tail, which is deeply forked. The colors change rapidly after the fish is taken from the water, green, yellow, and silvery, predominating. Eyes large, mouth ditto, with sharp conical teeth. Grows to the weight of twelve or fifteen pounds, averaging perhaps three in the spring run. It is very strong and active, fighting to the last on the hook, and dying as soon as taken. Very voracious, taking all sorts of bait, on the bottom, at midwater, or on the surface—cut-Mullet being commonly used. I have taken it with a trolling spoon, and others have taken it with a fly. A Cavalli of four or five pounds must be carefully handled on a rod, as its movements are rapid and unexpected—leaping out of the water, running under the boat, and conducting itself in the gamest fashion, so that many escape.

The Cavalli usually appears at Mosquito Inlet in April, or earlier if the water is warm, in large schools, and is discovered by the commotion which it causes among the small fry, especially Mullet, which it hunts and devours incessantly, often driving them on shore. In the Indian River it is found all winter. Spawns in May, in the ocean.

Says Professor Goode: "The name of this fish is usually written and printed, 'Crevalli,' but the form in common use among the fishermen of the south, 'Cavally,' is nearer to the Spanish and Portuguese names, *Caballa* and *Cavalla*, meaning 'horse.' It should be remembered that in South Carolina the name Crevalli is most generally applied to quite another fish—the Pompano."

#### JORDAN AND GILBERT'S DESCRIPTION.

CREVALLI, HORSE CREVALLI—*Caranx hippos* (Gunther). Olivaceous above; sides and below, silvery golden; a distinct black blotch on opercle, and one on lower rays of pectorals, the latter sometimes wanting; axil of pectoral dusky; anterior edge of dorsals black; upper edge of caudal peduncle dusky. Body oblong, the anterior profile very strongly arched. Head large and deep. Mouth large, low, and nearly horizontal below axis of body; lower jaw included maxillary extending

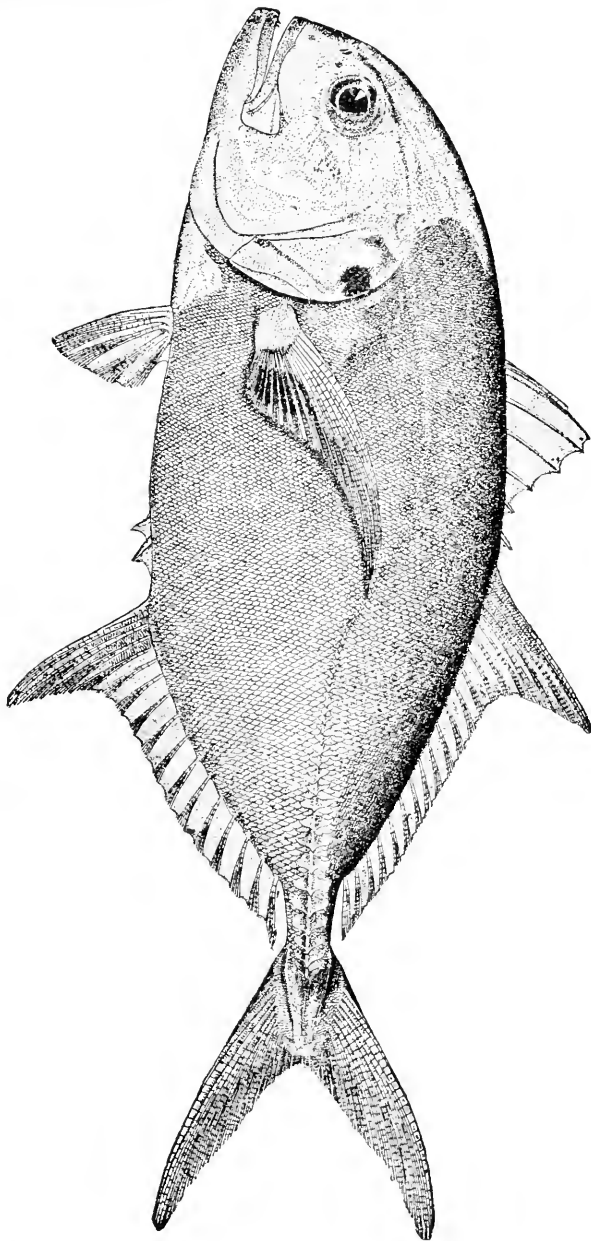

CAVALLI or CREVALLE—*Caranx hippos*.

to nearly opposite posterior border of eye. Teeth in upper jaw in a broad villiform band; an outer series of large, wide-set conical teeth. Teeth of lower jaw in one row, a distinct canine on each side of symphysis; villiform teeth on vomer; palatines and tongue. Lateral line with a wide arch, its length three-fourths that of straight part; plates not covering all of straight part. Dorsal spines short, rather stout; procumbent spine obsolete. Gill-rakers stout, not very long, 15 below angle. Occipital keel sharp. Eye not very large, longer than snout; 4-in. head.

THE LADY-FISH OR BONE FISH—*ALBULA VULPES* (GOODE),  
*ALBULA CONORYHNCHUS* (GUNTHER).

Pectoral falcate, longer than head. Breast naked, with a small patch of scales in front of ventrals only. Caudal lobes equal. Head  $3\frac{1}{2}$ ; depth  $2\frac{1}{2}$ ; Lat. I. (scutes) about 30. D. VIII—I, 20; A. II—I, 17. "Cape Cod to West Indies, common southward."

But a single species known, according to Jordan and Gilbert, and found in all warm seas, and very extensively distributed—in the West Indies, the coasts of North and South America, the Indian Ocean, the Red Sea, and on the coast of Japan, according to Professor Goode.

In the Bermudas it is considered good eating, but on the Florida coast it seems to be a mass of bones and fat. To the angler, however, the Ladyfish affords more sport than any other species on the southern coast.

No sooner is it hooked, than it begins to throw itself from the water in successive and lofty leaps, then darting round and round the boat, under it and over it, till exhausted, or until it escapes by casting out the hook, or cutting the line with its sharp labials. The mouth being tender, the hook does not take a firm hold, and one-half of the number hooked usually escape. I know of no fish which equals it in activity; even the Grilse, or the Land-locked Salmon make fewer leaps and are less active in play. Like the Cavalli, it makes its appearance with the first warm weather, in schools, feed-

LADY-FISH or BONE-FISH—*Ambly cingulus*.

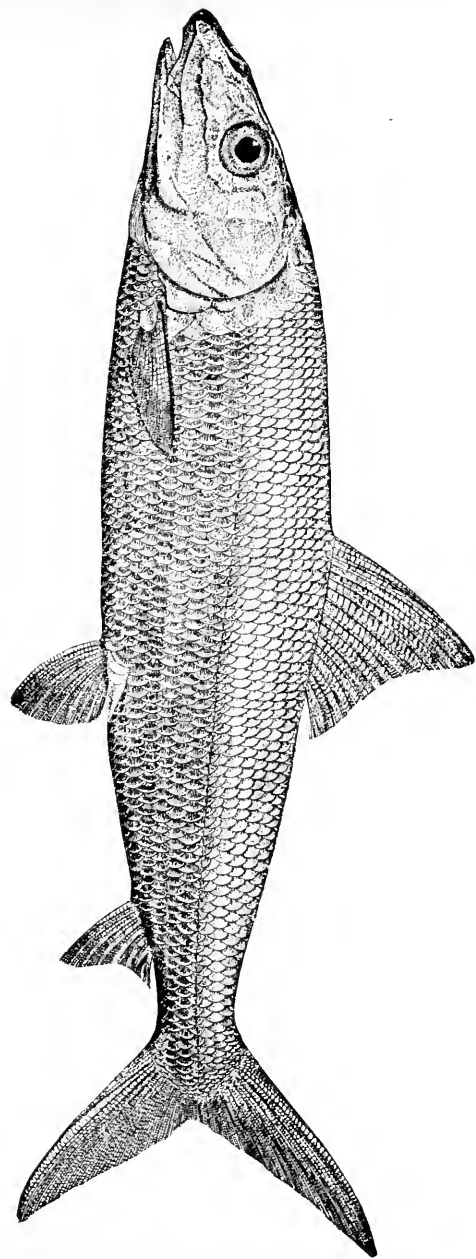

ing both at the bottom and on the surface and readily takes fly or spoon. It preys voraciously on Mullet, Menhaden and other small fishes, often driving them on shore. It is a slender and handsomely formed fish, built for speed, with a high dorsal fin, and deeply forked tail. Weight from two to four pounds, but pulls like a six-pounder.

DESCRIPTION OF LADY-FISH—*Albula Vulpes* (Goode),—[from a freshly-caught specimen.] Body slender and cylindrical. Head one-fifth the whole length. Eyes very large, fins yellow. Mouth large, teeth small; labials long and large, with fine teeth on edges. Scales small. Fins all soft-rayed, dorsal high, in middle of back; 18; pectoral 16; anal 10; tail deeply forked. Color of head greenish, back dark blue, sides and belly silvery. Length one to three feet.

#### FLY-FISHING IN SALT-WATER.

“The pleasant'st angling is to see the fish  
Cut with their golden oars the silver stream,  
And greedily devour the treacherous bait.”

—*Shakespeare.*

Which seems to mean fly-fishing, and as the poet lived near the “Soft-flowing Avon,” he probably was an angler. In fact there are many passages in his plays to show his familiarity with the art.

But to return to Mosquito Inlet. As the season advanced the weather grew warmer, and some of the southern fishes were seen feeding upon the Mullet. The Cavalli and Lady-fish, and near the Inlet, the Tarpum showed his vast and brilliant form on the surface, leaping and rolling in the tide-ways.

So one morning the major and I, with our host, started to look after these new-comers. We dropped down with the tide, then about three-quarters ebb, and crossed the river to the mouth of a large creek about half a mile from the house. In the middle, the water was shallow, but on the north side the channel was eight or ten feet deep and ran strongly, near the bank. Having procured a dozen Mulletts with the cast-net, we anchored in mid-channel, the tide beginning to set



up the creek. I had brought with me a twelve-ounce fly-rod, made of greenheart by Scribner, of St. John, with which I had killed many heavy Trout in New Brunswick. It was a spliced rod about eleven feet long, and carried a click reel with fifty yards of silk line, a six-foot leader, and a large red-and-white Bass-fly. The major was using one of my chum rods, and dropped his hook over the stern. P. sent his big hook and half a Mullet well out into the stream, and I cast about thirty feet astern, sinking the fly six inches in the water, and then drawing it up—this for some time without result. Now the major hooks what he supposes to be a Bass, but it proves to be one of those active sea Cat-fishes, sometimes called from its high dorsal fin, "The Gaff-topsail"—a clean-built, handsome fish, blue and white in color, and fighting long and hard on the hook. Like all the Cats, it is covered with a nasty slime, which adheres to hands and tackle; and it is also armed with sharp and poisonous serrated bones in the pectoral fins, which inflict painful wounds on the incautious.

"When these Cats appear, it is a sign of warm weather," said P., as he unhooked the fish; then he slashed it open with his knife, bringing out a bunch of eggs, in form and color like golden grapes; "I always kill them, so that they can't bite again," said he.

Judge: "Is it good eating?"

"Well, we don't eat them, we have so many better fish; out the meat looks white and nice enough."

Presently I have a rise, and hook a Salt-water Trout of three pounds, which gave very good play for five minutes, bending my pliant rod till P. declared it must break; but the fish was brought safely to the net. At the next cast I got a four-pounder; while playing it, the major was engaged in combat with a good Bass, which he boated—a six-pounder. "That's the kind I want; no more Cat-fish for me," said he. My fish was saved also.

The tide was now in full flow, and with it came a school of Cavalli, snapping and leaping after a school of Menhaden. P. hooked one of about three pounds, and hauled it in quickly, after the manner of hand-line fishermen.

"That's the first Cavalli I have caught this year, judge; there's plenty more; you've got one."

And so I had; it sprang up into the air, ran out twenty yards of line, circled round the boat, and cut up many capers for a few minutes, but when boated was dead. We got three more of about the same size, and the major lost one, before the school went by. We could see them for a long distance, chasing the Menhaden, and driving them ashore, where they were picked up by a flock of gulls, ospreys and pelicans. Next came along a school of Lady-fish, also hunting the poor Menhaden and Mulletts. The first that took my fly came out of the water four feet, and three times at that; then darted under the boat, and up in the air again, shaking out the hook. Both P. and the major were engaged in like manner with two silvery harlequins, which seemed to stay in the air half the time. As long as the school of fish remained near us, we had fine sport and got five or six of them, averaging two pounds in weight; but they soon went off up the creek in pursuit of their prey.

P.: "What do you think of Lady-fish, major?"

"I should call them flying-fish, myself."

Judge: "It is the greatest jumper I ever saw, and I have caught some pretty active fish in my time; how is it for eating, Pacetti?"

"Not good for much—mostly bones."

Here he found himself fast to a big Sting-ray, from which he cut his line loose; and next the major struck a large Bass, which proved too much for him, and broke away after a few minutes.

"I saw him, judge," said he; "he was a big one."

P.: "The one that gets away is always the big one."

SAW FISH (side view) — *Pristis A. thurus*.

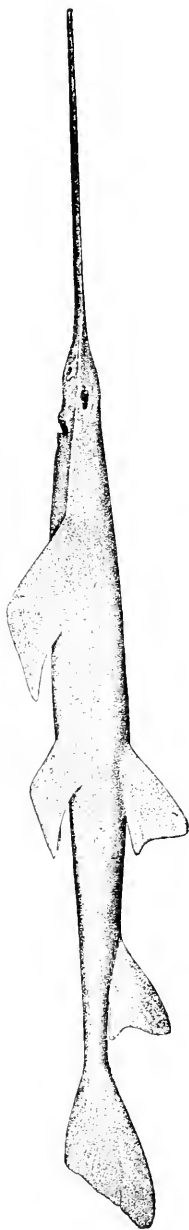

Major: "To be sure it is; the little ones can't break the line."

I now had a twitch at my fly, under water, and struck something heavy, and gave it thirty yards of line before it stopped—then it returned toward the boat, showing itself on the surface. So we had it, back and forth, for about ten minutes, giving and taking line, till the Bass showed his red sides on the water, and it was reeled in within reach of the gaff—a ten-pounder.

"Pretty well, that, for a fly-rod; I never did think it could be done," said Pacetti. "Hullo! there's a turtle," and he made a dash over the side of the boat with the landing-net, and secured a small green turtle of about six pounds weight. "That will make a nice stew; we haven't had one since you came, judge." My next fish was a Sea-Cat, which made a sturdy fight, worthy of a Bass or a Trout. Then the major got a Salt-water Trout of three pounds.

"What kind of a fish is this," said P. as he tugged laboriously at his line, when presently appeared a formidable weapon like a saw, two feet long, striking right and left. "This is the worst fish of all to handle; I do despise a Saw-fish," said he, and he cut the line, and the huge fish, some six or seven feet long, swam away. "They are worse than Sharks or Stingarees, and ruin my nets."

Judge: "Did you ever get struck by one?"

"I have had them hit my boat, and cut big splinters out of it. You see they lie on the bottom, in shoal water, and the boat is apt to run on them; if you do, then look out for that saw."

Major: "Could a Saw-fish kill a Shark?"

"I don't know as to that, but I know that Sharks often eat Saw-fish. We find the small saws on the beach, when the balance of the fish has been eaten up by something—no doubt Sharks—and a piece of Saw-fish is a good bait for a Shark."

JEW-FISH OF "WARSAW."—*Promitrops kuzaki*.

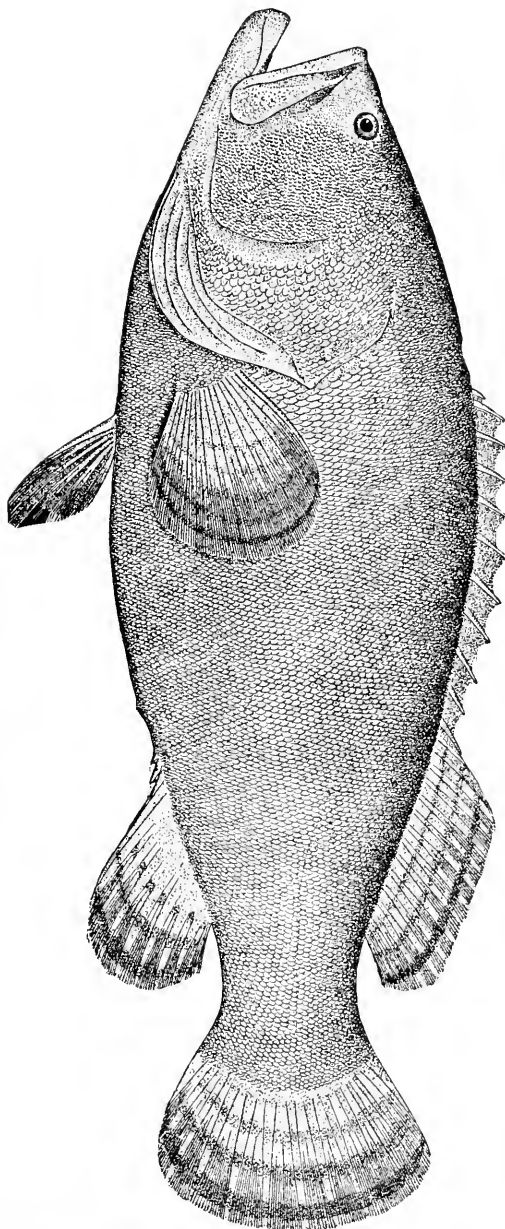

We got another Bass, and then took lunch, after which P. raised the anchor, and we went up the creek with the tide.

"I will go home," said he, "by the inside passage, so we will have the tide with us." A few hundred yards, and we came to a creek running north and south which intersected the one we were in. At the point of junction the water flowed very deep around a high bank, with some large tree-tops above the surface.

"Now, here is a deep hole where the biggest fish live—Groupers and Snappers and Bass," said P. "I often lose hooks and lines here— shall we try them?"

We anchored, and the major and P. both dropped their baits into the hole; while I made a cast into mid-stream, where the tide ran quickly over an oyster-bed.

"Hold him fast!" shouted P., as the major's line ran off—"I can't hold him—there—he has got me fast to the bottom."

Judge: "Let the hook lie for a while; perhaps the fish will loose it."

Now P. had a heavy bite, and by main force he hauled out a Grouper of some five or six pounds.

"This is the kind of line for Groupers; yours is too light, major." And after waiting for some time the major was obliged to break his line, the hook being in some hole in the rocky bottom. Presently P. hooked another and larger fish, too heavy for even his line, for it parted at the hook.

"I reckon they have got the best of us, major; we might as well quit." That must have been a Jew-fish that I got hold of; I have caught a twenty-pound Grouper with this line."

Just then I hooked a two-pound Trout on my fly; and after boating it, we left the deep hole, and went northward with the tide through many winding ways, among islands so intricate, that without a good pilot, one would soon be lost. This we had, for P. traced his devious course without hesitation.

Major: "These creeks and islands all look alike; how do you find your way?"

"Well, I've been doing it this thirty years, day and night, and ought to know the road by this time."

Judge: "Are we near that Rock House that you told me about?"

P.: "It's not far, and I will stop there if you like."

After several more turns, we came to a shell-bank landing, with a high hamak covered with live oaks and cabbage palms. A hundred feet from the creek stood a house—or the four walls of one, for roof and doors were gone—the walls were of coquina rock, some fifteen feet high, and about twenty by thirty feet on the ground. On one side it was shaded by a huge live oak, and on the other grew a large fig tree.

Judge: "So, this is the Rock House—who built it, and when?"

P.: "That is more than I know. Old people who lived here forty years ago said that it was here when they were born. Captain Dummitt, who came to this country from the West Indies fifty years ago, and who lived hereabouts many years, used to say that the house was built by some of Turnbull's colony, and there was formerly quite a large plantation here. This big tree is one of the Turnbull people's trees. Anyway, the house was built by a Catholic, for you can see the recess in the wall, where the crucifix stood."

"And has no one lived in it all this time?"

"Oh, yes, a number of families have tried to live here. One or two repaired the house, and put furniture in it, but they could not stay. I don't know why. There's many queer stories about the house. There was a young fellow here, just after the war, from Chicago, or somewhere out West, who used to hunt and fish about here. Well, one night, he got caught in a storm in these creeks, and went to the house for shelter—but he soon took to the woods and lay

out all night. I was in Smyrna the next day when he came in—and badly scared he looked. He wouldn't say what scared him, but he said he would not go to that house again, for all Florida."

Judge: "You mean to say that the house is haunted?"

"So some people say. I don't, for I never saw anything strange, myself."

"Who owns the place, now?"

"There's two or three men claim it. One man from the West—St. Louis, I think—was here two years ago, and got me to bring him to see it. He said that he bought it with about 200 acres of land, of some person in New York, for a trifle, but he thought it might be valuable some day; the land is very good."

Judge: "And it is a fine situation for a house, with deep water in front, and a fine landing place."

P.: "Yes, the man that picked it out knew what he was doing—and the old Kings road from St. Augustine to Smyrna runs through the hamak."

Judge: "Now, major, here is a chance for you if you want to sleep in the haunted house?"

Major: "Much obliged, but I have no curiosity, and prefer Mrs. P.'s good beds."

Judge: "How is it that the Indians did not destroy this house, when they ravaged all this country, and burned up everything?"

P.: "That I don't understand; there was nothing to hinder; and they ruined every building on this coast except this one, and this they did not touch. Well, gentlemen, if you have seen all you want, we will be going."

The route homeward was through the same wilderness of islands and marshes, with no trace of mankind. Many birds were flying about, or perched among the mangroves—egrets, white herons, blue herons, pelicans, ospreys—while along the shores great numbers of the noisy clapper-rail ran in and out



among the bushes—and coots and shelldrakes sported in the water. In these solitudes the birds remained safe from the murderous cockney gunner from the North, who is always wanting to kill something, and has driven away from the great frequented routes of travel much of the bird-life formerly so abundant.

## SURF-FISHING FOR RED BASS.

“Off where the slender light-house lifts  
 Like sheeted ghost, above the surge,  
 Casting its warning flames at night  
 Far to the dim horizon’s verge;  
 There anchored, when the tides are low,  
 And first the young flood bubbling flows,  
 The fisher far the spinning line  
 Deep down with trustful ardor throws.”

—*McLellan*, “*Poems of Rod and Gun*.”

February twenty-fifth, the weather being warm, and the tide serving this morning, we went down the river for a few hours fishing in the surf. Leaving our boat where the high bank joined the beach, we crossed a wide expanse of sand, bounded on the north by dunes fifteen or twenty feet high, on the south by the Inlet, and on the east by the ocean beach, level, solid, and about 100 yards wide at low water. Above this gently-sloping beach the sandy flat was nearly a quarter of a mile wide, scattered with sea shells of various kinds, cast up by the waves—clams, mussels, conchs, scallops, with egg-cases of Sharks, and other sea-fruit; a fleet of the Portuguese man of war, *Physalia*, stranded on the beach and drying in the sun. Here and there, the burrow of a sand crab, its owner peeping out; vestiges of wrecks, in the shape of water-worn spars and broken planks; sea-beans which have floated from West India shores, and occasionally the delicate shell of the paper nautilus, or Argonaut—usually more or less damaged. One of these shells was once found here containing its living inhabitant, which is very rare, as

the creature is not attached to the shell, but uses it as a sort of nest, for incubating the eggs, as we learn from late observers. Closet naturalists declare that the old account, given by poets and others, as to the sailing habits of the nautilus, is a fable, but the present writer, having repeatedly seen, on the calm surface of tropical seas this navigation in progress, believes they were correct, and man might

“Learn of the little nautilus to sail.”

We put up many sea birds from their nests, slight depressions in the sand, the eggs so concealed by their color as to be almost invisible. There were gulls, terns, shearwaters, petrels, and the like. In front was the ocean deeply and beautifully blue, with a line of breakers outside the long narrow slough or gully which lay just outside low water-mark. It was in this slough that we were to fish, and our guide looked carefully along for the Bass. Presently he said he could see them, and wading in till the water reached his waist he swung the baited hook and the lead around his head, and cast it away into the surf. The major followed with a hand-line, and I having also waded into the slough cast from the reel as far as possible—the water I found to be pleasantly warm; the sun was hot and the wind southerly. It was young flood, and the tide rolled the baited line ashore, making frequent casts necessary. Our guide, whose casts were longer than ours, got the first Bass—a six-pounder—then another before we either of us had a strike. “We must make longer casts, major; as far as the line of surf.” This being done, both of us soon had a fish hooked and in full play. I found that the Bass here in open water make a longer and fiercer struggle than those in the river, but assisted by the incoming waves, we were able to handle them. There was quite a large school in the slough, and we got seven of them, from four to six pounds in weight.

“There,” said P., “I think we have as many as we want to tote across the beach.”

I was playing a good Bass at the time, and had got it nearly to the shore, when a six-foot Shark followed and seized it. I pulled and the Shark pulled, thus bringing itself further in, when a big wave caught it, and rolled it ashore almost high and dry. P. and the major each seized a club from the drift-wood and beat the Shark over the head; in spite of its furious struggles and vicious blows with the tail, they killed it—but my Bass was cut in two.

A few hundred yards from where we were fishing was the wreck of a steamer half-buried in the sand at low water-mark, the stump of a mast and part of her smoke-stack above the waves. To the wreck we went, and climbed on board. Her hold was full of water, washing in and out, and we could see large fish swimming about inside.

Judge: "This looks like an old wreck; when did she come ashore?"

P.: "I think it was just after the surrender. She brought down a load of nigger soldiers to settle at the Inlet. They built some houses and a steam saw-mill, about a mile above my house."

Judge: "The same old mill that we see there now in ruins?"

P. "Yes; the boiler bursted and killed two or three of the people, and the colony soon broke up, after the Yankee colonel that brought them here went away. Come, major, we had better shoulder our fish, and start for the boat."

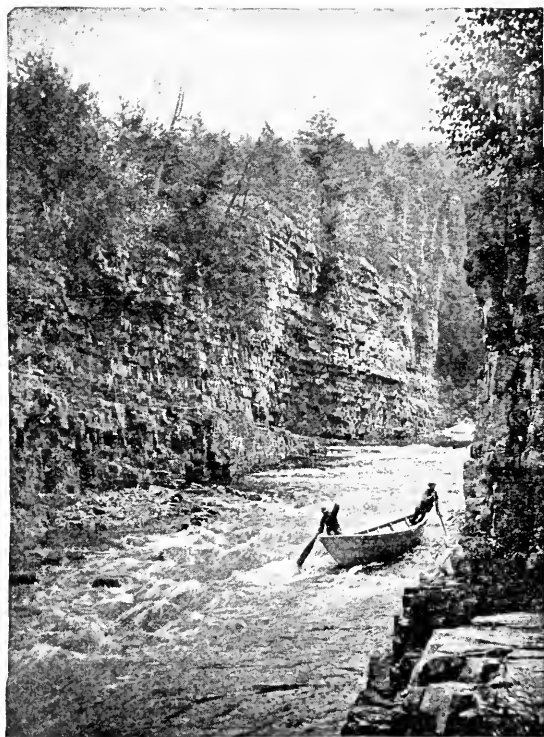

AU SABLE CHASM. RUNNING THE RAPIDS.

## THE AMERICAN GRAYLING.

BY F. H. THURSTON ("KELPIE").

"The graylynge, by a nother name callyd ombre, is a delycyous fyffhe to manys mouthe. And ye maye take hym lyke as ye doo the troughte \* \* \* And yf ye fe ony tyme of the daye the troughte or graylynge lepe, angle to hym wyth a dubbe\* acordlynge to the fame moneth."—*Dame Juliana Berners.*

THE very peculiar history of "The rise and fall of the Grayling," as it has not inaptly been termed by Mr. W. David Tomlin, has already been written by so many famous anglers and facile pens, that it seems to me almost a work of supererogation to attempt a new one in my own words.

For much of the technical and historical portions of this paper, I have freely drawn upon the writings of others—scientists and anglers. Where practicable, I have given the proper credit, but I may here say that I am largely indebted to the works of Professor G. Brown Goode, to the "Forest and Stream," and to the "American Angler."

The following technical description is taken from Goode's "American Fishes."

"Two species of the genus *Thymallus* occur in North America, one, the Arctic Grayling, *T. signifer*, the other the Michigan Grayling, *T. tricolor*, the diagnostic characters of which are thus defined by Bean:

### SPECIES OF GRAYLING.

A. Gill-rakers 22, pyloric cœca 19, maxilla one-third head; mandible equal to anal base; eye nearly equal to interorbital

\* Fly

space; dorsal when laid back not reaching adipose fin. T. TRICOLOR.

Aa. Gill-rakers 18; pyloric cœca 18; 3-10 head; mandible much shorter than anal base; eye much less than interorbital space; dorsal when laid back reaching end of adipose fin. T. SIGNIFER.

To the anglers and ichthyologists of the United States the Grayling is comparatively a new fish. The Arctic species was described in 1819, by Sir John Richardson, of the Franklin expedition, and called *Thymallus signifer* (standard-bearer); *Thymallus* having reference to the odor resembling that of thyme or cucumbers, which causes it in England to be known as "the flower of fishes"; but which appears to be peculiar to the Grayling of Europe.

The Esquimaux of the Mackenzie River give this fish the name of Hewluk-powak, or *the fish with the wing-like fin*. The Grayling is of the family Salmonidæ, and is distinguished from the Trout by its smaller mouth and teeth, and by the greater size of the dorsal fin. The scales are also much larger.

This fish is more elegantly formed than the Trout; it is of a beautiful silvery gray, the fins olive brown, the pectorals shading into blue near the ends. Its magnificent dorsal is dotted with purple or reddish spots, surrounded in life by greenish tints, and is about one-fourth the length of the fish. It rises with a gracefully curving outline to a height of two or more inches in a Grayling weighing a pound, and its apparent use is to enable the fish to rise and descend rapidly.

In Michigan waters the weight of the fish seldom exceeds a pound and a half, and they are not often taken above fifteen inches in length.

The Jordan, the Boyne and the Boardman were once noted as Grayling streams, but, as far as can be learned, the Trout were then new-comers, having as is believed migrated within forty years from the streams of the upper peninsula, where

GRAYLING—*Tymnotus triolator*.

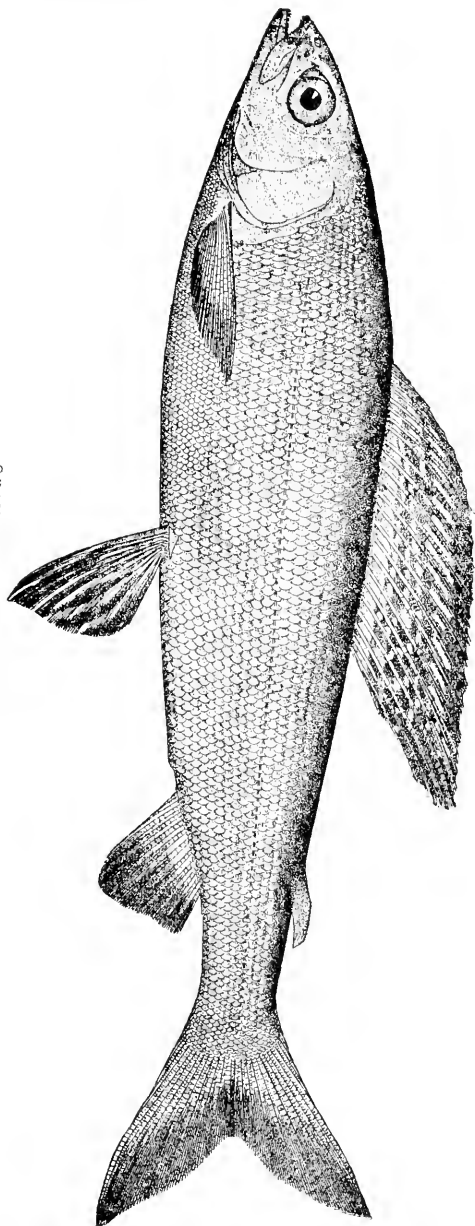

they have always been numerous, to those of the lower, where they are said to have been previously unknown.

I first saw the Grayling caught near the mouth of the Cedar, in the Intermediate River, where now stands the village of Bellaire.

Ten years ago they were fairly numerous in Cedar River, but none of the streams I have mentioned now contains more than an occasional Grayling.

It is said that Mr. Fred Mather hatched the first Grayling, in 1874; and since that time many attempts have been made to propagate this fish, notably those of the Michigan Fish Commission, which, I regret to say, have proved a failure. I cannot learn that others have been more successful. In many countries of Europe, the Trout and Grayling are found side by side, and the same is true in the streams forming the head-waters of the Missouri. In Michigan, however, it has been observed that wherever the Trout have found their way into a Grayling stream there has ensued a serious diminution in the numbers of the latter fish. The favorite theory has been that the Trout devour the spawn and the young of the Grayling; but some accurate observers hold to the opinion that the latter, being in its habits a local fish, and not given to migration, like the Trout, has simply been "caught out" by anglers. In the words of Mr. J. B. Battelle, "it is the fishermen and not the fish, who are responsible for the disappearance of the Grayling."

In 1854 or 1855, Mr. Wright L. Coffinberry, a surveyor in the employ of the General Government, found Grayling abundant in the Muskegon and neighboring streams, and called the attention of Michigan scientists to the fact. It is said that the fish were at that time so numerous that they were taken in wagon loads by the settlers, and salted as provisions. They were locally known as "Michigan Trout." Soon after, Dr. Parker, of Grand Rapids, succeeded in procuring an imperfectly preserved specimen, and pronounced it a true



*Thymallus*, a decision confirmed in 1865 by Professor Cope, and later by Agassiz, to whom specimens had been sent by Mr. Charles Hallock.

Slowly the Grayling worked its way to public notice. Genio C. Scott, writing in 1869, devotes less than seven lines of his book to this fish, though he gives it a good character.

Later, Fred Mather writes: "There is no species sought for by anglers that surpasses the Grayling in beauty. They are more elegantly formed and more graceful than the Trout, and their great dorsal fin is a superb mark of loveliness. The sun's rays lighting up the delicate olive-brown tints of the back and sides, the bluish-white of the abdomen, and the mingling of tints of rose, pale blue, and purplish-pink on the fins, display a combination of colors equaled by no fish outside of the tropics.

It should, however, be stated that the peculiar coloration which has gained for the Michigan Grayling its specific name of Tricolor, is not always apparent. Its hues vary under different conditions, and are sometimes mainly confined to the silvery-gray and olive brown.

Much discussion has been held among anglers concerning the merits of the Grayling as a game fish, and also as to its excellence as an article of food; and opinions widely differing on both these points have been advanced by men whose views are entitled to consideration. I am inclined to the opinion that these differences are largely due to the particular months in which the fish were taken.

In the Au Sable, the Grayling spawns in April, and I think earlier in some other streams. The proper months for taking this fish in Michigan are September, October, and November; but a recent act of the Legislature of that State has fixed the close time from the first of September to the succeeding May. It is to be hoped that at a future session the law may be so amended that the open season shall be from

July to December first; or if this be thought too long a period, let them cut off the summer season, but in the name of all that is sensible and fitting, let us have the first two months of autumn.

The following extract from a work on fly-fishing, by Edward Hamilton, M. D., is here given place as having a peculiar appropriateness in this connection:

“There is something, however, in fly-fishing for Grayling, and it has its own peculiar charms. First the time of year when Grayling are in season—the sultry days of summer are past; the autumn colors predominate; all the senses are quickened; the breeze is fresh and balmy—just enough to send your fly farther over to the other bank; the temperature pleasant; the water not too cold for wading—in fact, everything combines to make this fishing very fascinating. I like Grayling fishing also for the fish itself. A Grayling, in season, is worth catching. I call in season, September, October and November; then the fish is as different as possible from the same in June, July, and August, both in beauty and in courage; no dead-heartedness then; and look at his color—he is indeed a glorious combination of purple, gray and gold. I like him also for his boldness and daring, rising again and again at the fly—

“Unabashed, will dare,

Balked e'er so oft the disappointed snare

Simple and bold.

“I say the Grayling is a bold and daring riser, and why is this? He lies low in the river when watching for his prey, and therefore is not so easily disturbed; and if you remain quite still when he has risen and missed the fly and gone down to his lair, he will surely, after a short time, rise again. He rises, too, differently from a Trout. A Trout lies close to the surface when he is feeding, and takes without effort the flies floating over him, and also is easily scared. A Grayling, from lying deep in the water, almost close to the bottom, comes

up with great rapidity and never takes the fly till it has passed him, and, should he miss it, disappears so quickly that he may well be compared to a shadow. Should he, however, take the hook, mark then what happens: up goes his great back fin, and down goes his head in his determination to get to his hiding-place, and then comes the struggle. For a time he is always boring with his head up stream to get below, and it depends on his size and gameness, as well as on the skill of his captor, whether he succeeds or not. I say the great dorsal fin is raised to its utmost in the fish's endeavor to go down. Now as this fin is a great characteristic specialty in the Grayling, let us consider for a moment what is its use, and why it should be of such a size.

"It appears evident that its purpose is to enable the fish to descend with great rapidity. I believe the large air-bladder is, with the fin, the chief cause of its rapid rise to the surface, and I think it also probable, that in raising the large fin in descending, the fish is thereby able to compress the air-bladder more effectively, and thus increase the facility of descent. This is a question of extreme interest, and I hope soon to have further evidence on this point. All who watch the Grayling after he is hooked will observe with what tenacity he endeavors to get to the bottom of the river, and how large the dorsal fin appears during the fight.

"It has been remarked by some writers that the Grayling when hooked keeps his head up stream, but still downward toward the bottom. So he does for a certain time; but finding himself baffled he takes to running down-stream (always boring his head downward, particularly the large fish), and I have known a big Grayling run down from above the luncheon-hut to the sheep-bridge on the Houghton water before he could be landed—and then to call him a dead-hearted fish!"

The Grayling streams of Michigan are the Hersey, the lower Pine, the Manistee and its many feeders. The Musca-

gon, undoubtedly, at some time was a Grayling stream. The Pigeon River, the Sturgeon, the Au Sable, the Maple, the Black, and other streams flowing into the "Inland Chain" of lakes and rivers, are, however, still fairly stocked with this fish.

It has been said by some anglers that the flesh of the Grayling is preferable to that of the Trout. It is assuredly most palatable, and has this in its favor: that "one can eat it every day during a long outing, and the last meal is as hearty as the first."

There appears to be a difference in the structure and habits of the Grayling in different waters. Those found in the streams emptying on the western shore of Michigan are smaller than those of its eastern waters; and it has been said that "the fish of the Manistee is a jumper, while that of the Au Sable is a low, deep, hard puller, with slightly different tactics to free himself than the Manistee Grayling."

With regard to the Montana Grayling, I can hardly do better than introduce an article from the pen of William C. Harris, editor of the "American Angler:"

"Within a short distance (soon walked) from the hotel, the three rivers above named—Gallatin, Madison and Jefferson—flow close together and are indiscriminately fished by the resident anglers. In all the rivers the Grayling, the Rocky Mountain Trout (*Salvelinus purpuratus*) and White-fish (*Coregonus williamsonii*) can be found, but the Gallatin is the fish river of my dreams. In its waters the three fish, just named, veritably 'swarm.'

"We fished the Gallatin at a point about four miles from the town, and as I descended the bank to reach the stream, the surface of the pool before me was mottled with jumping and feeding fish. Here a Grayling, there a Trout, and in between, a White-fish. It seemed a sacrilege to the memory of Brother Izaak to place a lure before them. Stifling our qualms (easily done) we walked above the pool and cast our

two flies at the lower end of the incoming rapid. Two fish, of course—one a Grayling, the other a Whitefish; the first on a brown hackle, the latter on a coachman. Again a cast, again two fish, and so on for a half-hour, alternating in species between the Trout, the Grayling, and the Whitefish.

“I did not move more than ten yards from my first position during the half-hour, at the end of which I became sated and started up-stream to fish the unlikely places, recalling to mind a similar experience on my first visit to the Gogebic Bass, when, to the surprise of my guide, I told him to take me to some place where the fish were not so plentiful. This satiated cry—‘enough,’ ‘enough’—is doubtless a personal experience with many of my readers and it is the sign manual that distinguishes the angler from the pot-fisher.

“The Grayling of Montana, to catch which I had traveled more than 2,000 miles, did not disappoint my angling expectations. It is, I think, a stronger fish, with sturdier fighting qualities, than its congener of Michigan waters. It has a thicker, broader body, and a somewhat longer head, but is much less beautiful in contour and coloration. The Eastern fish is more clipper-built, leaping frequently from the water when hooked; in fact reminding me, measurably of course, of the Skip-jack or Lady-fish of Florida, which is almost constantly out of the water ‘dancing on its tail,’ when you are bringing it to creel. The leap of the Montana Grayling is not frequent, as the fish is disposed to fight deep, making longer and stronger surges under the restraint of the tackle, than those of Michigan waters. The coloration of the two fish differs: the violet bloom of the body, seemingly translucent, is of a more delicate tint in the Eastern fish and more generally diffused. The dorsal fin, from which the Graylings derive their specific name—*signifer*, ‘the standard bearer’—is not so high or so resplendently colored as those of the Michigan fish.

“Two striking differences exist between the habits and habi-

tat of the Montana and Michigan Graylings. The latter lives and thrives only in rivers, spring-fed, with sandy bottoms, and of a temperature seldom exceeding fifty-two degrees. Our recollection of the Manistee in Michigan, upon which we spent several days among the Grayling two years ago, is that we did not see even a pebble upon the bottom, except, here and there, a small cluster of stones not much larger than hen-eggs, which were exposed on the rapids by the rapid rush of the stream, and these stony rifts were of small dimensions, and often a mile or two distant from each other. The rest of the stream consisted of shallow, sandy reaches and pools, at the bottom of which the sand was mottled with patches of white and yellow with dark blotches here and there, formed by a deposit of drift. In the Gallatin the conditions are reversed. The temperature often reaches sixty degrees, and the bed of the river is for the most part rocky, at least, covered with stones, the smallest of which may be represented by the cobble-stones of street pavements. In truth, the pool above referred to, in which I caught most of my Grayling, was rough-strewn with rocks, many of which sized up to that of a bushel measure; a sandy reach was not seen along the two miles of the stream fished by our party.

“Again—It is an established fact that the Michigan Grayling cannot live and increase in any stream in which trout or other fish have established themselves. They seem to diminish very rapidly under such conditions, and, strange to say, the reverse is the fact in English waters, where Thymallus holds its own against the brown Trout. In the Gallatin, the Trout, the Grayling and the Whitefish live in harmonious brotherhood. On one occasion, using three flies as an experiment, I caught one of each of these three fish, at the same cast, showing that they feed and range together.

“The ordinary Trout-flies used in the East will, under favorable conditions, lure the Grayling, the Trout and the White-

fish, of Montana waters. The hackles, black, brown and gray, should always be in stock, and of the winged flies, the Professor, Lord Baltimore, Abbey, Yellow Sally, Montreal, etc., are useful."

The number of anglers at the Gallatin increases rapidly, and a very few years may serve to throw light upon the question whether the Trout or the fishermen are to be held responsible for the dearth of Grayling in their former favorite haunts.

The proper tackle for Grayling is the same as that used for Trout: a light rod, click-reel, and twenty-five or thirty yards of water-proofed line. The weight of the rod may depend upon the swiftness of the current to be fished. If this is not too rapid, a rod of four to six ounces will land the largest Grayling in Michigan or Montana waters.

Generally speaking, however, an eight-ounce rod is not too heavy, and will be found more satisfactory for all waters. The Grayling can fight hard when he chooses. I have seen a pretty good rod broken at the handle by a bait-fisher, in trying to throw out a large Grayling by main strength. Nevertheless, in fishing for the Grayling, do not forget, particularly if you are a Trout-fisher, that it has a very tender mouth, much more so than the Trout, and must be dealt with accordingly.

It is well to have a good assortment of flies, the same you would choose for Trout. The Grayling is naturally a surface feeder, and not being as easily scared as the Trout, will often rise again and again at the same fly. Not unfrequently the stomach has been found to contain cedar leaves, etc., which the fish had swallowed, thinking them insects.

It should, however, be stated that there is evidence showing that the Grayling is to some extent a vegetable feeder, and the leaves or similar substances may have been intentionally swallowed.

The different hackles, black, gray, brown and red, are

good at all seasons. In the early summer months the small brown or gray gnats are taking. The Grayling shows a slight preference for a fly with some white in its make-up—the coachman and the Beaverkill wrapped with silver tinsel are killing.

Among the favorites are the grasshoppers, yellow and green, the Bee, grizzly king, royal coachman, jungle cock, Montreal, Lord Baltimore, Professor, Abbey, yellow Sally, etc. I have seen the Grayling rise freely to the blue dragon-fly, but only on one occasion. I have since tried it with very unsatisfactory results.

I am not opposed to bait-fishing at times, and I once fished for Grayling with a piece of pork. There was nothing else to bait with, and I caught no fish. My companion, using the same lure, was more successful, and managed to secure enough for our dinner. I remember one day sitting in a boat on the Manistee, in a heavy rain, and ineffectually casting my flies; while the man opposite, using angle-worms, caught, in half an hour, nearly a score of fine fish. He was a skilful Trout-fisher, and it was interesting to note the difference between the methods of the Grayling and those of the Trout in taking a bait. The latter comes with a rush, and a snap; while the former moves so carefully that it is often only by the motion of the line that the angler can tell if the bait has been taken.

Some of the best Grayling streams of Michigan remain such because they are difficult of access and little known; and it was toward one of these, not many years ago, on a calm, still September afternoon, that the writer bent his way in company with a friend who shall be called John. It was our first visit to that locality, and on the way we interviewed a native who professed to know something of the river.

“Wa-al,” said he, biting at the end of a piece of “navy plug,” “the’s fish enough, but yeou want ter gi’daown tew three mild ’fore yeou’ll find many on ’em. The river’s



full o'rapids, 'n I do' know haow yeou'll git along."

We informed him that we had a boat.

"Ya-as—so I see. The most o' them 'at's ben daown in a boat gin'ly ties a piece o' railroad iron to the hind eend o' ther skift, so's ter gi'daown ther rapids kind o' stiddy like."

John and I looked at each other and grinned. Fixing the moss-back with my eagle eye, to him then thus in substance I replied:

"My cautious friend, to us it skills not that every boatman hereabout should tardily tow a railroad in his rear, what time he runneth rapids. Life is all too short for that sort of foolery. For two-score years and more, as opportunity occurred, have I cruised the rushing rivers of our fatherland, yet have I never tied to the tail of my craft any such contraption as this you advocate; and further I may add, the Nine gods helping me, I never will."

"Wa-al, mabbe yeou know best, yeou're the doctor, 's the sayin' is, but it's most darnation aowly on them there rapids, naow I tell ye, 'n I'll be gosh darned ef I'd put intew that there river 'ithaout suthin' ter stiddy ther bwut daown apast them there rocks. It's a kinder temptin' o' Providence."

"We can tell better after we get through."

"W'y, yeou don't 'xpect ter go clean threw, dew ye?"

"That's the plan. There'll be no cordeliering on this trip."

"Wa'al, yeou'll hev ter dew it, I s'pose, 'f yeou say so, 'n 'ta'nt no bisness o' mine. But yer baound ter git 'n trouble. Ther rapids isn't all, by a darned sight. The's rocks, 'n logs, 'n daown timber, 'n jam-piles, 'n telerguf poles, 'n cedar ties, 'n every other dum thing yeou c'n think on. Yeou do'no what yer a comin' tew, no time."

"That is just what brought us here, my friend," said John. "We want to see what sort of a river it is, and what's in it; and if we knew just what we were going to find there, we would change our plans and choose another."

The sun was sinking toward the western horizon when we

reached the last house on our road; a small log-cabin, before which a huge woman sat knitting, and smoking a cob pipe. She courteously answered our inquiries concerning the proper route, and as several logging roads branched from the track, she called her son—a boy of about twelve years—and told him to guide us to the river. The little fellow ran into the house, and soon reappeared, carrying an immense army musket.

We could not repress a smile when, shouldering the preposterous weapon, the boy took his place in front of the team, and prepared to lead the way.

The mother laughed good-humoredly. "It *is* a pretty big gun, but Jock knows how to use it. Git us somethin' for supper, Jock, 'fore ye come back."

A mile of rough travel brought us to the edge of a small marsh, beyond which we saw the gleam of the river. Here it was necessary to leave the wagon, the ground being impracticable for horses.

Lifting the boat, we passed the marsh, the boy in advance holding his musket at a ready, and as we neared the stream, a pair of ruffed grouse rose near our feet and sped across the river; but before they had gone thirty yards, the old gun spouted forth its flame, and the leading bird dropped into the bushes on the other side of the stream.

"Whew!" said John. "Who taught you to shoot grouse that way?"

"Dad," replied the boy. "They a'n't grouse, they're pat'ges."

"You're a promising specimen of Young America, I must say. We'll buy that bird of you for supper."

"I don't want ter sell 'im. Marm likes 'em."

Just at this stage of the colloquy, we noticed that the fish were rising at the feathers which had settled on the water.

"Brown hackles, eh, John?"

"Of course—see 'em jump; but we can't fish now, we

must have a better camp-ground than this, and it's growing late."

The boy was rewarded and sent home; the driver instructed to meet us three days later with the team at a given point some thirty miles below; the boat was launched and stowed, and soon we were gliding down the swift, shallow river, bending our gaze to the right and left, in search of a camping-place. Rounding a bend, the current became swifter, and soon we were rushing toward a gleam of foam which seemed to stretch clear across the river.

"Which way now?"

"Right through that little slick patch ahead, and then dodge to the right."

Straight for the "little slick patch" we sped, and were through it in an instant, just missing the ledges to port, while the spray flashed over the bow, as short to the right we turned, and dodging the bowlders that lay in wait, the powerful sweeps of the paddles sent the good boat round the rough point of a threatening reef, and away we went in the whirling waves, down a slope of feathery foam.

"Pretty good for an introduction that."

"Yes. Wonder where we are going to camp?" said John. "I want a Grayling for supper."

"Can't tell yet," I replied; as, standing in the stern, I griped more firmly my long Canadian paddle, and kept my eyes on the channel straight before. Old Joe Le Clair had made that paddle, and a better piece of timber never graced the hand of a steersman.

Swifter and swifter grew the current; the drooping branches which brushed its surface were swept downward by its force, and, laden with tufts of moss and leaves, splashed in and out of the stream with a queer, jerky motion, as we hurried past, while now and then, with splash and scream, a water-fowl arose from the pools along the margin, and flashed away through the sunlit leaves.

And now arose on either hand dark limestone cliffs, rifted and seamed, and hung with ferns and clematis vines, and the blue bells of the campanula. Below us was the "Devil's Elbow," so called by the raftsmen who plied their adventurous trade along the stream, and as this gorge of ominous name now opened on our view, I thought that despite the coarseness of the appellation, it was hardly inappropriate.

Down the steep slope we sped, straight where the swollen river flung its force against a wall of rock, beneath the frowning front of a precipice, and, wheeling sharp to the left with a foaming swirl, was lost to view in the depths below.

"By Jove," said John, "there is a singular example of stratification."

"No talking to the man at the helm. Stand by to fend off." Our prow was cutting the wall of foam at the base of the cliff, but swerved to the powerful sweep of the paddles, and the reeling boat shot down the gorge, past rock and reef, that showed their teeth to weather and lee, through the gleam of the plunging foam.

The river widened, and in five minutes more we were floating upon a swift but tranquil current. The sun had set, and the evening twilight rested on the forest, when we moored our boat to a projecting root, and made our camp in a grove of great canoe-birches.

The shades of night were falling fast before our tent was pitched, but in no long time were for us dispelled by the flames of a glorious camp-fire whose huge logs glowed in the fervent heat, while eddying sparks and volumed smoke whirled upward through the birchen boughs, and stirred their whispering leaves.

Mind that this fire was builded for its own dear sake. We were no greenhorns, to try to cook our supper by a volcano. Our culinary department was situated in the background, and though comparatively inconspicuous, proved thoroughly effective, as was made manifest by the savory steams which hung on the still night-air.

During our meal, the conversation naturally drifted toward the objects of our cruise, and when we had finished, John arose, took up his rod, and attaching a white miller to his leader, stated his intention of trying a cast by moonlight. This he accordingly did, but unsuccessfully; and after one or two changes of flies, he gave up the experiment, returned to the fire and lighted his pipe.

The air was frosty. Fresh logs were heaped upon the fire, and, disposing ourselves upon the blankets, we leaned our backs against the birches that towered aloft against the starry sky, their white bark gleaming in the ruddy blaze.

Said John, reflectively: "The best day I ever had was on the Jordan, long ago. Jim S. and I caught one hundred and forty-two Grayling in one day, besides those we returned to the water. We took home nothing under a pound, and many were nearly twice that weight. There are none such to be had now. It was in July, and we used nothing but gnats and gray hackles.

"Jim got excited once, when he had three big fellows on at one time, and broke the second joint of his rod. Then we dropped the hand-fly, and at last used only one gnat apiece. The last time I fished that river, I caught fifty-six Trout, but not a Grayling rose to the fly.

"In Maple River they are still plentiful, and (so I hear) in Portage Lake.

"On the Au Sable, the best fishing-grounds are forty miles further down than they used to be.

"I have had good success on the Buttermilk and Cannon creeks, but you have to go pretty well down the streams for the best fish. Cannon Creek seems to be full of little fellows. On the Little Manistee the Grayling is still plentiful, but I fear not for long, at the rate they are being taken.

"I believe that the way to insure the preservation of this fish is to pass an act prohibiting, under a heavy penalty, the catching of Grayling at any time except during the

month of September. They are in season then, if ever."

The last tale was told, the last pipe smoked. Fresh logs were heaped upon the fire; we spread our blankets in the tent, above our fragrant couch of hemlock tips, and soon the hush of the forest rested on the camp, while

"Through it, and round it, and over it all,  
Sounded incessant the waterfall."

I was astir soon after daybreak, but truth compels me to say that this state of things was consequent upon the advent of John at the door of the tent, with his four-ounce rod in one hand and a pair of resplendent Graylings in the other.

"I wanted fish for breakfast," he explained, "and thought it wasn't worth while to waken you. So I just cast a brown and a gray hackle outside the little cove, just below the camp, and in two seconds I had 'em."

The fish were soon in the pan, and breakfast dispatched in "short order;" the tent struck, and we once more were on the water. The Grayling should, if possible, be eaten soon after it is caught, as it will become unfit for use much sooner than the Trout. Wishing, however, to take home a reasonable number, we had provided salt, and a small tub; and it was agreed that only the finer specimens of our catch should be saved.

We anchored near the spot where John had taken his fish, and soon perceived a school of Grayling, some of which disappeared in the grass and weeds at our approach, while others remained in sight. I was still busy with the anchor line when John, waving the delicate rod around his head, sent his flies some thirty feet down the stream, and just at the edge of the weeds. A noble Grayling broke water, and was fast to the stretcher on the instant. "See his fin," shouted my companion, his eyes glistening with excitement as the fish leaped clear of the water in his efforts to free himself, the great dorsal flashing like jewels in the rays of the rising sun.

“What’s the matter with you now?” I replied, hastily raising my own rod from the thwarts. “Seems to me that a man who could coolly comment upon the formation of the rocks, while running the ‘Devil’s Elbow,’ needn’t make such a beastly row about a pound Grayling.”

“He’s nigher two pounds than one—look at him now—he ain’t either;” for another leap of the fish showed that it was hooked back of the gills, and my friend more coolly than at first, proceeded to draw his prize nearer the boat, and within reach of the landing-net.

“Not as big as I thought, but isn’t he a beauty? Somehow, the first one always excites me—I can’t help it.”

Meanwhile, I had cast a pair of hackles, red and gray, and soon had hooked a fish, while John was playing a pair of them upon the other side of the boat. In a few minutes we had secured half a dozen, ranging from half a pound to a pound in weight. We could clearly see the fish against the bottom of yellow sand, and decided that there were none larger in the school.

We therefore raised the anchor, and taking up the paddles, floated down the stream. So clear was the water that we could see nearly every object which it contained, and now and then, as we passed a pool, a school of Grayling would scurry away to seek better cover.

The current grew more rapid, and as we alternately made casts, one fishing while the other steered, we found that John’s four-ounce rod was rather too light for this rapid stream. I was using a ten-ounce rod, of English make—an old favorite—and had less difficulty in bringing my fish to the net.

Near the head of a short rapid, John, who had changed his flies for a coachman and a professor, hooked a big fellow, and I held the boat with a setting-pole, while the fish made a determined effort to get to the bottom. Unsuccessful in this piece of strategy, he made one or two leaps, the great

back fin raised to its fullest extent, the gold and purple shining in the sun; then after another effort to sound, he changed his course; and away he went, down the rapid, John keeping a steady strain upon the fish, while I dropped the pole and grasped my paddle, and down we went in the wake of the Grayling.

There were some ugly bowlders strewn along our course, and the angler was compelled to put forth his best skill to prevent the Grayling from snapping the line around some of them; but we passed the rapid in safety, the fish still fast to the hook, and by this time pretty well wearied, so that, rounding to in an eddy, I managed to hold the boat while the net was put in requisition, and the fish boated. He weighed nearly two pounds, and was the largest taken during the trip.

Here we moored the boat, and had good sport, casting our flies from the reefs which projected from the shore; and returning to the water two fish out of every three that we caught.

We dined at this place, and once more proceeded on our cruise, feeling rather jolly, as we erroneously supposed that we had passed the worst of the obstructions in the stream. We had left behind a forest of spruce, and were passing through a swampy region, when I became aware of a large doe, standing upon a shallow, and looking down the river. She made a beautiful picture, her glossy form in full relief against the swaying clematis vines, and dark green alder leaves; and not until we were within thirty yards did she turn her head, when, taking a short but steady look at us, she leisurely hopped into the bushes. We saw several others on the trip, but such a picture as this one presented lives long in the memory of a sportsman.

We soon encountered more rocks and rapids, and as we swung around a curve, John lifted his voice and energetically said: "A jam-pile, by thunder!" True enough, the river



below was effectually blocked by a jam of telegraph poles, which were piled to a height of many feet, in the bed of the rushing stream.

Here was our first "carry," and it took us nearly two hours to make it; but at last the work was accomplished, and, well wearied, we made an early camp and fished the rapids, but with small success. This, however, did not distress us, as we had enough; and we devoted ourselves to salting the fish that we had saved. There were about sixty, all of large size. Had we retained all we caught, we should have more than trebled this number.

Our rest that night was peaceful, and before sunrise we were on our way. We judged that we were within five miles of the bridge where we expected to find our team, and we hoped to be able to take home a few freshly caught Grayling.

In this we were not disappointed. It seemed rather late in the season for gnats, but John attached a red and a brown for his first cast, and did not again change the flies, which were well suited to his light rod.

Mine was heavier, and I did not try the gnats, but held to the hackles, brown, red and black; steering and casting alternately with my companion, and each meeting with good success.

Too soon the bridge and the driver hove in sight; we each made one more cast "for luck" and reeled in. The driver waved his hat and cheered, as the last resplendent fish was drawn from the water and held up to view; and we pushed ashore, with forty fine fellows for our morning's catch.

In ten more minutes we had left behind the river, all save its delightful memories, and were swiftly rattling over the road in the direction of civilization.



SNAGGED.

## THE PIKE.

*Esox Lucius--Esocidæ.*

---

BY W. DAVID TOMLIN.

---

“The Pike belongs to the family of the Esocidæ. Body elongated, sub-cylindrical, with small scales, margin of upper jaw formed by intermaxillaries and maxillaries laterally; mouth very large, jaws elongate, depressed; teeth strong, hooked, unequal on intermaxillaries, vomer and palatines; dorsal short, opposite anal; gill-openings wide; air bladder present; voracious fish of the fresh waters of the northern regions. Genus one; species, six or seven.”—*Jordan*.

THE Pike family are familiar objects to any person whose habits lead him to frequent the banks of sharp-running rivers or cold clear lakes, but especially to the boy who goes a-fishing. To distinguish between the branches of the family, however, the boy must either lay them side by side, or if he be taking object-lessons in free-hand drawing, let him sketch a Pike, and then continue his studies; there will remain an impress on his brain that years of business cares will not efface. Whenever in after years the strong, prominent features of a northern Pike are introduced to him he recognizes the friend of his boyhood days. The Pike to him remains a Pike forever.

What is a Pike?

Ichthyological: A fish of the genus *Esox*, named for its length, and shape or form of its snout. It is distinguished by its projecting lower jaw and its full, prominent eyes.

Its head and back are a dark green, shading nearly to black—graduating to a pearly white on the belly; the belly fins, four of them, are green, tinging to pinkish hue around

the edges, the dorsal and anal fins being large, of bony, sinewy structure, giving the fish enormous power in the water. These two, with the caudal fin, are dark green in color. Its sides are marked by bars or blotches of dusky white streaks running from the back down toward the white of the belly. Its caudal fin attracts the attention of any one examining the fish; it is not truncate, but just enough bifurcated to give it its almost lightning speed in turning, or holding its own in a sharp current.

The prominent features in the Pike are his large operculum, or cheek-bone, his strong jaws, and his general build. He is designed for speed, and for fighting.

Where does he live?

His home is in the large lakes and rivers of the North-west, especially from the St. Lawrence throughout the chain of lakes connecting therewith; the lakes and rivers of Ohio, Indiana, Michigan, Wisconsin, Minnesota and the water-shed of Canada, connecting with large lakes leading to the St. Lawrence water-shed. You may find him in the bays connecting with these lakes wherever the long wiry rushes grow, or where the yellow lily-pad shows. It grows to a length of three feet—sometimes more—and weighs up to about eighteen or twenty pounds. Specimens have been taken in Michigan, and along the bays connecting with the north shores of Lake Superior, weighing up to twenty-five pounds.

It is a powerful fish, and is no coward; it will fight as viciously as a terrier. We have seen smaller Pike with jaws locked and lashing the water around them like a boiling cauldron. Occasionally letting go and backing out, they would again rush at each other with open jaws, and keep up the fight until one is beaten and driven away, or until both are exhausted.

Some years ago I found two dead, with both jaws fast set, so that they could not be pulled open. Both of them were handsome male fish, and must have fought fiercely,

PIKE—*Esox lucius*



for their bodies were cut all along the sides and bellies.

The Pike is not particular as to the quality of his food. Anything that is alive or can be digested is eaten and enjoyed. I can remember in my boyhood days, a smart spaniel pup that would go anywhere his young boss told him to go. I sent him across the large fish-pond, in the grounds at the rear of the old home. While swimming across he began yelping most pitifully, and put on a spurt to the bank of the pond where I was standing; I was on my knees ready to lift him out; a big Pike was following him. I caught the dog by the neck, pulled him out and took him to the house. Mother dressed a badly lacerated hind leg. Boy-like, I was fond of that pond, and after getting several duckings that closely approached drowning, and thrashings almost without number, and after a sheep had been drowned in the pond, it was decided that it must be drained and filled up. The big Pike that snapped at the spaniel was there, but not a sign of a turtle of any kind. There were fish in abundance, but by far the largest and handsomest was the pup's enemy, which, when dressed, weighed twelve pounds.

My home was near a large paper-mill, having an abundance of cold spring-water draining a valley twenty miles long. Two rivers and several creeks fed the large streams. It was a splendid feeding and breeding ground for the Esocidæ. Trout were also found in the smaller streams, but in the two rivers the Esocidæ could be found anywhere. Abundance of flags and rushes lined the banks of one stream; these were the home of the hell-diver family—and of the mud hen. Many times have I laid watching the antics of the young of both species. As they grew larger the mother bird would take them into the larger stream. One day, while I was watching the diving and preening of the family, one of them suddenly disappeared under the water. The hen-bird began to gather the little ones around her with such a squawking and clucking that I, too, grew interested and

excited. She hustled the young birds up to the bank of the stream, but too late! Before she could get them all out, the wicked eyes and prominent snout of a big Pike came to the surface and sucked down another little birdling of the flock. I rose in the brush that hid me, and saw the cunning face of the Pike. And if ever a fish laughed, he did! The mother bird saw me too, and hustled the remainder of her family into the rushes.

We were raising some young ducks at the time; a fancy breed; but they had been hatched by a hen. I predicted they would be Pike-food before they were a week old. The old hen strutted around, proud of her family, but one day she led them into the meadow through which the tail-race of the mill ran—a stream of water five feet deep—and the home of the Pike and the Pickerel.

Hearing the cackling of the hen, I ran out and found the ducklings in the water, and jumping into the boat, drove them out, after a long chase. Once or twice I saw the sharp dash of one of the *Esocidæ* after them, but I got them in safely. Mother promised me something handsome, if I could keep them out of the water for a few days, until they got big enough to go with the old ducks. Coming out of the mill the next day, I saw the ducklings paddling around in the rushes, and the old ducks near them, quacking and calling as if something were wrong.

I dashed through the hall of the house, catching up my sixteen-gauge single gun as I went, banging doors behind me and all the time vowing dire vengeance on any specimen of the *Esocidæ* that might show his long face.

Just as I jumped into the boat, after counting them, I heard the minature, peeping "qu-a-a"—of a duckling, but it was never finished! It disappeared under the water, and I saw the broad tail of a big Pike as he swung out into deeper water. Of eleven ducklings five went this way; the others we saved until they could take care of themselves.

Is it any wonder I exercised all the cunning of a boys' nature—all the budding ingenuity of a mechanical taste, just developing, to circumvent these "varmint?"

Another brood of ducks was being raised at this time. A dead bunch of yellow down was brought out one morning, causing a shout that rung through the house. "Mr. Pikee, I am going to get you now!" I cunningly cut it open, inserted a cork in the small duck, fixed my double hook inside, bent the snood on my line, and was ready for business. Jumping on a raft that I used for fishing, I drifted down-stream, letting my line and the duckling float ahead of me. I dropped my stone anchor and prepared for a surprise—pulling off my shoes to be ready for a swim, if need be. Almost 100 feet of line had run out with the current when—a plunge! and quick as a flash my duckling had gone. I let him go for some time without offering any resistance, for I wanted to be dead sure of the long-snouted poacher. I allowed him all the time he wanted to taste his duckling, but at the first move he made to run down-stream, I struck. I had a full hand! A mad fish—especially a powerful Pike—is no light task for a boy to handle. For some minutes he rushed up-stream, down-stream, across—every way, to find a friendly stump. "Aha! my long-nosed beauty! your duck-hunting days are over!" I knew every hole in the tail-race, almost every yard of the water, as well as the Pike, and had swam the whole length of that tail-race too many times for any *Esox* to fool me. Managing somehow to pull up the stone-anchor, and take a turn of the anchor-line around one of the big spikes in the raft, I drifted, yelling and shouting as any boy would under similar circumstances. Some of the men employed in the mill, seeing my Indian dance, had run down the river banks, and were giving me plenty of advice. Gradually drawing in the fish until close to the raft, I saw that I had him played out, and taking the line into my fingers, I dropped my rod, and quick as thought, plumped flat onto my stomach, slipped



my forefinger into the fish's gills and hauled him on the raft. Then jumping for my pushing-pole I gave him a crack over his big eyes that paralyzed him. Lifting the pole to give him number two, the weapon hung fire. My line had, in some way, coiled around the pole, and instead of the blow coming on the head of the Pike, it came across my bare toes! In a flash I was bottom-side-up under the water, fussing and spluttering as a boy always does when anything hurts him. I fairly howled with pain, until I saw that the squirming Pike was getting too near the edge of my raft, when, towing it to the bank, I transferred my rod, line and fish, to dry ground, and then "whoop-e-e-d" over my first big Pike! It was only about thirty inches long, but it was the fish that had taken such a fancy to our downy ducks; and my victory over him, won, as it was, at the expense of a wound and an involuntary bath, was a most glorious achievement.

The hiding-place of the Pike is under a channel bank where rushes grow to the edge of the channel; or, in the vicinity of tree-stumps and submerged logs, especially if the old roots project out into the running streams, he can often be found in the deep water, a little above the mouth of a channel, between two lakes, or in the pool at the foot of such channel.

How am I to catch him?

A few years ago English methods were described in reprints of English books, or written by Englishmen who had become Americanized, yet who taught that the "Thames style," or "Nottingham fishing-tackle" were the proper methods by which to catch Pike, or other "coarse fish," as they called them, to distinguish them from the gamy Trout. But with the improvements introduced in late years by American tackle-makers, the English methods are relegated to the shades of the past, by American anglers. I will refer to one or two points in the manner of casting, that experience has

led me to adopt when fishing for Pike in our wide rivers, or bays on the great lakes.

The Pike is a sharp-eyed, shy fish; you must reach him "a ways off"; you cannot expect to stand on a big rock, drop down in the water beneath you, and get hooked to a great northern Pike. "He aint nobody's fool, and don't you believe it!"

Take a trolling or spinning hook, baited with a piece of fat pork, cut in shape like a fish, have a boat pulled alongside the rushes I have spoken of; let out twenty yards of line, and then have your oarsman pull a long slow stroke, and if the Pike family are receiving visitors, you will soon know it. Trolling with a long line and three sets of hooks is a most barbarous way of fishing for the Pike. I care not if this family are the Sharks of fresh water, they are entitled to fair play. His Satanic Majesty is never as black as he is painted, so the *Esox lucius* is cousin german to the *Nobilor vulgate Mascalonge*, and partakes of his noble nature. He is a foe-man worthy the steel of the most ardent angler. Some anglers call the family "snakes." I pity them! Go where Pike can be found, fish for them with legitimate tackle, and give them a fair chance, and they will give just as much pleasure as any royal Small-mouth Bass that ever swam.

#### FISHING TACKLE.

A lance-wood or bethabara-wood rod, of about nine feet long, a "Milam," "Chubb's," "Henshall," "Van Antwerp," "Abbey & Imbrie, Steel-pivot Multiplier," or an "Automatic reel"—a strong but not heavy line, silver gimp snoods of about two feet long, then with a heavy sneck-bend hook with a small lip-hook whipped into the gimp snood to fasten the bait to, and a good gaff-hook, and the angler is equipped. With a silver chub or shiner for bait, run out about five feet of line from the tip of your rod, casting sideways out from

the body into the stream, or from the boat. You will find the weight of your bait will run out twenty or thirty feet of line; draw in the tip of your rod sideways about two feet, then allow the bait to sink a little, giving it a moment's rest, then gently jerk the tip sideways two or three feet; and keep on in this way until the bait is almost under your rod. Practice soon renders angling for Pike almost perfect in casting, when one has good fishing tackle. The angler should never be satisfied until he can lay out seventy to one hundred feet of line, with no other sinker than a common buckshot, and a silver shiner (*L. selene*).

But to young anglers whose purse is often slender, and to whom a Milam reel is a luxury, the art of casting for Pike can be attained with a little diligence. My earlier experience in Pike-fishing has never been forgotten; my pole was a strip of white pine cut from a clear board twelve feet long, tapered into shape, the standing guides whipped into it; my reel a primitive one made by myself, and with no multiplier. My practice was to gather up the line in folds in left-hand, holding the rod along the right side and extending under the forearm to the elbow. This steadied the rod and gave good casting power.

By gathering up the line in the left hand in folds or plaits you can readily loop up fifty feet of line, and casting out as described before, drop your bait almost within a foot of any desired point, without a snarl or kink in the line. By closing the fingers over the line you can hold all you need for casting. I often do this now, though possessing better tackle than anglers dreamed of in earlier days.

An old Englishman named George put some wrinkles of this kind into my head, and they have stayed by me. He was a genuine cockney, and in spite of his continual assertions that "They do things better at 'ome," George did know how to lay out a line "fine and far off," as the Thames fishermen called it.

I have seen him drop a line 100 feet from the point where he was standing, without any exertion. I soon "caught on," and since that time have laid out a line in a way that even old George admired.

Fishing up in Michigan with a party of Indiana friends, I had in the same boat a friend who used an Orvis combination rod and a Milam reel—a successful fisherman and an enthusiast. The waters had been fished a great deal that summer, so our hopes for fish depended on the skill displayed in casting. My reel was an Abbey & Imbrie click and drag. My friend was casting overhead, a style adopted from Dr. Henshall's methods in fishing for Black Bass. He caught some small Bass and Pickerel, but no large fish; yet we were in waters famous for the Northern Pike.

My rod was a bethabara-wood, heavy for its size, but which would spring almost like steel. Putting on a large shiner for bait, and drawing out about fifty feet of line, I coiled it in my left hand as described; bringing my rod round to the right with a sharp swing, my bait was spinning in the air just a little above the water. The line uncoiling from my hand just as I wanted it, it dropped sixty feet away from me, taking up all my slack; my friend's bait dropped about the same distance from him, his Milam reel giving him all the advantage. Not getting any strike, I again gathered up the line until almost close to the boat; elevating the tip and swinging the bait higher, slipping the drag off the reel, my line ran out and the bait dropped out about ninety feet, without any plashing. The first jerk I gave, the bait was seized; something left a big swirl on the surface of the water; the line ran out about ten feet and stopped. I let it go, gave the fish a chance to swallow the bait, and then struck sharp enough to set the hook. The fish resented this treatment, and went off on a tear. The reel buzzed, my line steamed as it tore through the standing guides; the weeds through which the fish passed were cut and floated to the top of the

water. Throwing on the drag, and getting the pressure of my thumb on the plate of the reel, I snubbed him, and he bucked like a Broncho. He twisted and shook himself, and finally went to the bottom and sulked. My line was taut, but "nary a move" could I get out of him; the quivering, ringing sensation that comes from a taut line telegraphed that the fish was either trying to smash my hook, or worrying at the gimp snood.

"Something's got to be did!" came from my Indiana friend. "How big is he?"

"I think a small Pike, from the way he's fighting."

I pulled—he tugged! I reel'd up—he backed out. Expecting every moment my line would part, I resorted to an artifice to scare him; slipping on a clearing ring on the taut line, I elevated my tip and down went the ring.

"Look out! T——; he's going like a racer!"

The ring was too much for him; to the right, then to left, and then up to the surface, a handsome Pike thirty inches if an inch; my friend began shouting:

"He's a fine one! handle him carefully!"

One more spurt, but my rod controlled him, and in a few moments he lay beside the boat, "played out." My friend lifted him, a finely marked Pike, a male fish, just a trifle over thirty inches long.

In the vicinity of Edmore, Michigan, there is a chain of lakes that have an abundance of northern Pike in them, but you cannot get any sport fishing with fine tackle. The fish are "foolish." A pole, a clothes-line, a big triple hook, any kind of bait, a big jerk, a yank, and you could drop your pole, haul in your clothes-line, and pull on the raft a Pike weighing from ten to thirty pounds. Put on a minnow, frog, mouse, piece of fat pork, or any kind of spoon, and you could get another big fish in a few moments.

What fun is there in fishing, when three men can catch two hundred pounds of fish in three hours? and then cannot

give them away! I want none of it! It's barbaric butchery! In fishing with a single hook, you must insert the hook through the gills, out of the mouth, and leave the gimp snood to run along the side. A simple rubber band or piece of silk will fasten the snood and fish, so that you can use the bait for casting; but the best system is to use a lip-hook on your snood, and then slip a rubber band over the tail of the minnow, or to put the hook through the mouth and gills then hook the fish through the back just behind the dorsal fin, so that when a Pike seizes the minnow you can readily hook him.

While fishing in Pike Lake, near to Duluth, with a strong line and a New York spring-steel hook, and fishing with green frog bait, a big fish took my frog. His strike and rush were so sharp—so surprising, that the spring of the rod in the recoil drove the steel into his lower jaw. The break was so quickly made that the reel gave one long scream; the fish threw himself clean out of the water, within twenty feet of us—a handsome fish almost three feet long. He gave a lash and a plunge as soon as he struck water, and away he went, the hook coming back to us in the boat almost straightened out. We were fishing for Bass, and had just dropped anchor in a bunch of yellow lilies; I got in my bait first; my friend sat dumb and amazed; we did not dream we should find a big Pike in these yellow lilies.

Within a few days a northern Pike weighing eighteen pounds was killed in this lake, whose jaws bore the marks and scars of several hooks that he had broken from. He had lived to be a noble-looking fish, but died an ignominious death. Some moss-back speared him!

A few miles back of Traverse City, Michigan, lies a chain of lakes, famous amongst anglers as the home of the *Esox*. The nobilior and lucius have been caught there in such sizes and weight that seemed almost beyond belief. I saw a dead one that bore marks of having been speared; his length was

over two lengths of a two-foot rule, but he smelt so strong, that even by holding the nose we could only just slip the rule on him twice and then run for dear life! The stench was too much to investigate any further.

Fishing in this same river one evening, we had caught some nice fish, when my boatmen said, "See that!" I looked, saw the circles extending outward until the ripples touched the boat; a new minnow was put on and fixed; the boat stopped and I cast out up-stream, a few feet above the center of the ripples. My minnow dropped splendidly; it scarcely touched the water before *Esox* had it, and ran. The river was full of roots and submerged logs. I had to strike or let him go. I struck sharply.

"Let the boat go, Charley!" The boat drifted, and by sheer force I reversed my rod and hauled the fish into the channel; then began the fun! The moment I gave him a slack line he plunged for the bottom, but I stopped him; then he made a rush for the banks, across and across the river for some minutes. I never handled a crazier, or so mad a fish; my rod bent so that I dare not count on the fish; he was full of fight, and kept it up until I had him close to the boat. Charley, my boatman, gave him a crack on the head across the eyes, with the butt of a paddle. This stunned him. In a second he was at my feet, and a knife into his spinal column back of his head—a splendid fish, weighing about twelve pounds.

Many anglers use a Salmon-gaff for handling Pike. They are splendid things in a boat where only two men who know how to use them are fishing. In the hands of many ordinary men you lose more fish by mis-strikes than you can catch with them.

*Esox lucius* is diminishing in numbers, and especially in size. Better fishing appliances, and the pushing in of railroads into unfrequented lake countries, have opened up regions to the angler little dreamed of twenty years ago. The

ambition of lady anglers to join their husbands and to get the biggest Pike or Mascalonge in the camp, have all told against the genus lucius. Any angler, man or woman, who has ever fought a ten-pound lucius, and landed him, is proud of the record. Such anglers don't call them snakes.

It was not my intention to say anything about the cooking of the Pike, but my wife, who is by far my best camping companion in many a fishing trip, and who, woman-like, "knocks the biggest persimmons" when we are fishing, says: "You take the jacket off that long-face and I will give you a treat." We get the treat—baked Pike—the concomitants being some water, some butter, some pepper, and salt, and a dash of vinegar at some stage of the cooking. Yum! it's a dish fit for the gods!





## THE WALL-EYED PIKE.

---

BY A. A. MOSHER.

---

THE Wall-eyed Pike or Pike-Perch, so-called, belongs to the Acanthopherous species bearing, as the name signifies, spines. These fish have various names, in various localities. In the North-west, and along the Ohio and Tennessee rivers, they are, for some unknown reason, called Salmon, and many of those who thus misname them will insist, most tenaciously, that they are Salmon, and no amount of argument will convince them to the contrary. This reminds me of the "Trout" in the Southern states that are, as every well-informed angler knows, Black Bass.

The Wall-eyed Pike is gregarious, nearly always running together, in schools of greater or less numbers, and when fishing for them, if you get one Wall-eye you will generally get more.

They are found in most Northern waters, and in some are very numerous; are eager biters, and not particular as to bait, taking almost anything that is offered. They spawn in spring on the cobble-stones or pebbles that line the shores of the lakes or streams.

They appear in large schools at this time, the bottom frequently being covered by them. Their eggs are very glutinous—stick fast to anything they touch, and do not become detached (unless by violence) till hatched out. There are, in some of our lakes and rivers, some large specimens

of this fish, weighing as high as thirty pounds; these usually are found in deep holes where they can secrete themselves under sunken logs or the banks. These big fellows are generally of a rusty color; the edges of their scales are sharp and rough. There is a good deal of difference in the color of these fish in different waters; in some lakes, especially in the "Lake Park" region of Minnesota, where they are found in great numbers—some of them (and in some lakes most of them) are dark russet on the back, this color gradually fading down the sides till it blends with the white on the belly.

The difference in color in different individuals is so marked that one is often tempted to believe them to be of different species. They all have however that distinctive mark belonging to this fish, the *white tip* at the lower caudal extremity; this is always found in the true Pike-Perch, or Wall-eyed Pike. There is another member of the same family called the "Rock Pike." I have never seen it in the West, but in eastern waters, especially in Lake Champlain, they are quite numerous.

This fish is darker, rounder and smaller than the common Wall-eye. They are frequently found on the rocks lying perfectly still.

The flesh of the fish is firm, white and of fine flavor. It is not often they take a hook; we used to spear them at night.

The common Wall-eye may occasionally, in time of high water, be found ascending small creeks, that empty into lakes, and they will then crowd up through grass till their backs are out of the water; they only do this in the spring freshets, and then only when the water is uncommonly high, which leads me to believe that they are seeking other waters as these creeks when they are thus found have their source in some large slough. The fish are often found in such sloughs, after these creeks are dry.

These fish, in still water, are not good game, as a general thing, though I once caught one in "Big Twin Lake," in Wis-

WALL-EYED PIKE, or DORN—*Stizostedion vitreum*.

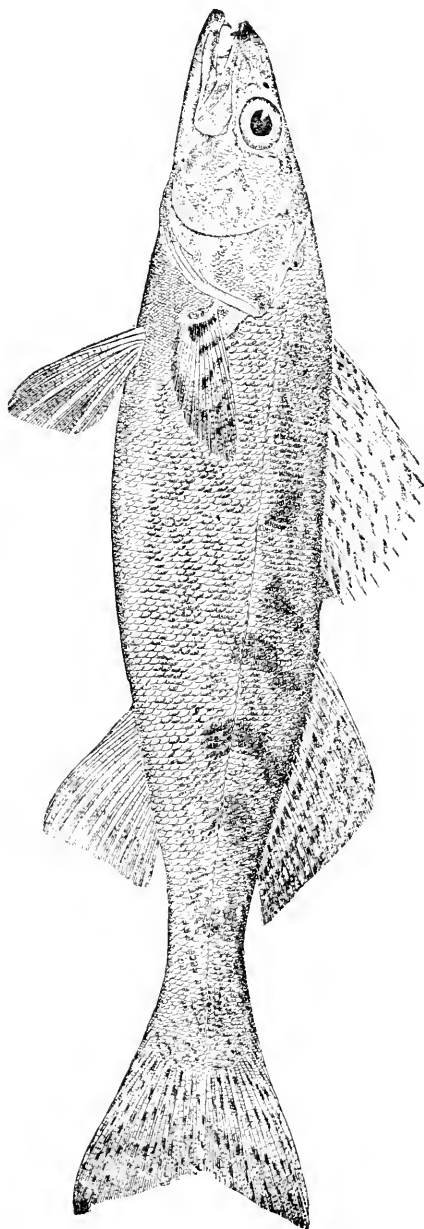

consin, that was game enough for anyone. I was trolling for Mascalonge, and had caught a twenty-nine and one-half-pounder with which I had a fight of an hour and a-half before I got him in the boat, when I had a tremendous strike. Down went the fish into deep water, and there he staid. I told my guide I did not know how big he was, but was satisfied he was larger than the one we had caught yesterday. We pulled for shoal water, about half a mile away, but the fish kept down in spite of my efforts to bring him to the surface.

We finally stopped and reeled in. It was slow and difficult work, but he finally showed up and it was only a six and one-half-pound Wall-eye! How a fish of that size could offer so much resistance was, and is yet, a mystery.

Take these fish in swift water and they are as full of vim, and fight, as any fish, except the Brook Trout.

As an edible fish the Wall-eye may be classed A No 1. The flesh is white, firm and flaky. Steamed, baked, broiled or fried in butter, they are hard to beat.

There is no place in the United States, to my knowledge, where the Wall-eye is more plentiful than in the lake region of Northern Wisconsin, along the line of the Milwaukee, Lake Shore and Western Ry.

This road, runs clear around and incloses hundreds of lakes, where not only the Wall-eye is plentiful, but Mascalonge, Bass, Pickerel and Trout are found in great numbers.

In 1868, in company with the Hon. D. O. Finch, of Des Moines, Iowa, and a gentleman by the name of Deaver, I went to a small inlet on the west side of Spirit Lake, in Dickinson County, Iowa, to fish for Wall-eyes and Pickerel. We had poles, cut from iron-wood, near the lake, coarse lines, and big hooks. We had no boat, so we rolled up our trousers and waded out to the edge of deep water, where the little inlet purred over the shelving pebbles into the lake. We had a fin or two to commence with, but ere long we had all the fins we wanted.

Sport? Yes, we had it, and plenty of it. No sooner would the hook strike the water than with a whirl and a splash a Pike or Pickerel would take it; then the fun would commence. Now this way and now that he would go, making the tough iron-wood bend nearly to the butt; and away we would go for the shore.

Various gyrations of Mr. Pike, or Mr. Pickerel, as the case might be, would detain us more or less on the way, but in the end we slid him out on the pebbly shore.

Finch nearly went crazy. When he had hooked one, he would stand, legs wide apart, eyes sticking out, both arms apparently all elbows, and let it play awhile. Then he would start for the shore, with his pole over his shoulders, dragging his fish, and finally sliding him out on the shore. He would square himself in front of his victim and deliver a lecture—quotations from Latin, Greek, French, Demosthenes and Cicero and other ancient heroes. The classics were reviewed as he fired ancient history at the poor fish; then he would extract the hook, fix his bait and go in again.

The fish run large, several of the Pickerel tipping the beam at ten to twelve pounds each, and the Pike averaging some four pounds. We returned a good many of them to the water for we had all we could use within a few minutes after we commenced fishing.

We fished some three hours and took home seventy-five Pike only. That afternoon will long be remembered by all of us—as one of the most enjoyable of our lives.



## THE PICKEREL.

---

BY W. DAVID TOMLIN.

---

WHEN sunny youth or lovely girlhood takes to fishing; when woman, "spurred with a vaulting ambition," desires even to eclipse her husband—when the soul that looks out of the windows is growing dim! when the grinders cease because they are few; when the ambitions of earth wane, and the days slip almost unconsciously by, and of the loves of former years that remain—the love of boyhood; the strong love of a strong manhood; the declining love of well-spent life—the desire comes once again to go-a-fishing—and the slippered feet are once again guided gently to a boat and made comfortable, and—and to fishing the old sire goes.

All the memories of boyhood's days return again, and the cunning of his hand comes to him once more; he recounts incidents of many years fishing lore, but it is of Pickerel fishing.

To the boy just beginning his piscatorial career, the Pickerel is the fish of all fish. The "Beauty that draws us with a single hair," does not at first attempt to inveigle the wary trout; but the Pickerel is fair game—and many a bout does fair womanhood have with *reticulatus* before she attempts to fling a line for either Bass or Trout.

But what is a pickerel?

"English as she's spoken," says Pickerel or Jack is a young Pike. This idea was fostered by some transplanted Anglo-

Americans who thus tried to engraft English names on the fauna of the American waters; but Cope, Gill, Thompson LeSeur, Kirtland, and Jordan have taught even boys better; they know more than their fathers did—the difference between the members of the *Esox* family.

*E. reticulatus* (LeSeur). Common Eastern Pickerel; Green Pike. The snout much prolonged; front of eye about midway in head; eye more than three times in snout; coloration, green; sides with a net work of brown streaks.

Streams of Atlantic States abundant, but not found far in the interior.

*E. cypho* (Cope). Vulgate Humpbacked Pickerel, probably best known by the elevated back and broad swollen ante-dorsal region. Colors usually plain (olive green) or somewhat reticulate. Western States.

*E. Americanus* (Gmelin). Banded Pickerel; Trout Pickerel. The snout much shorter than in the preceding; eye much nearer snout than opercular margin. Color: dark green; sides with about twenty blackish curved bars; scarcely reticulated. Length, rarely a foot long. Home, Atlantic Streams.

*E. Salmoncus* (Rafinesque). Little Pickerel; Western Trout Pickerel. Size and general form of preceding, (about a foot long,) or more slender. Color, olivaceous green above, tinting to a white below; sides with many reticulations and curved streaks, instead of bars; a black streak in front of eye as well as below. Western streams—abundant. Resembles *reticulatus* more than *Americanus*. — *Jordan*.

Comparing the *reticulatus* and *lucius*, anyone can readily distinguish the points of difference defined in the descriptions of Rafinesque, Cope, and LeSeur; and the Pickerel once out of the water, his relations with the Pike family are established.

The Pickerel are spring-spawners hence boys see them just as soon as the ice has cleared out, the snow-water gone and the warm days come. They are found in shoal water amongst weeds, or where the branches of trees are projecting from the shore into the water. Here they are found in pairs, gently swimming backward and forward in the stream,



WESTERN BROOK PICKEREL — *Esox amphirostris*

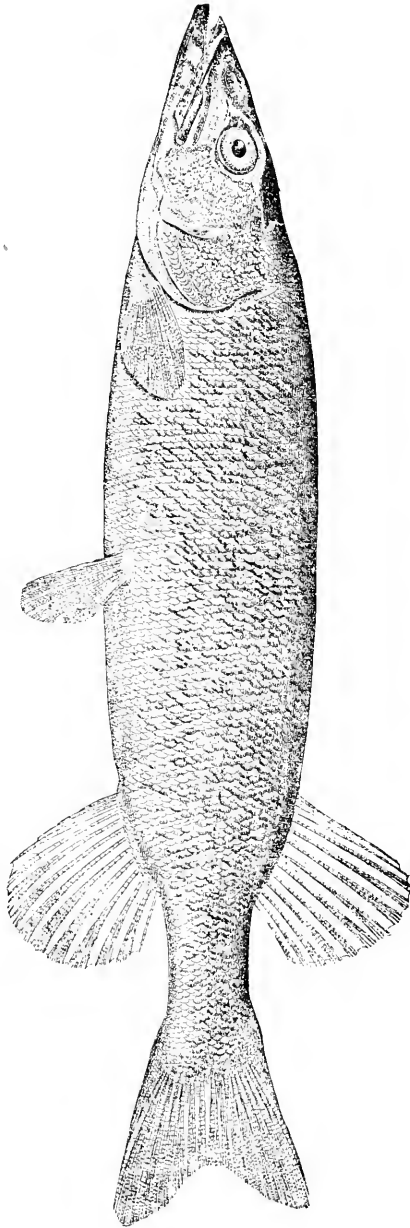

rubbing side by side until the female is ready to spawn. They are careless fish—leaving the spawn to take care of itself until the gentle undulations of the stream and the warmth of the sun's rays produce the young fry.

As soon as these are able to take care of themselves, they show the family likeness, and begin their bold predacious attacks on the fry of the silver chub and shiner family. They are greedy feeders, and from the time they are the length of the little finger, the Pickerel are looking for something nice to eat.

Years ago, ere the appliances for fishing had improved to their present stage, I was fishing with a crude, jointed rod, home-made—the rod a simple home-spun affair—and was enjoying the sharp vicious strikes of Pickerel that were abundant in the local waters, forgetting that my ancient enemy, a pugnacious and well-developed ram, was in the pasture lots. His butting propensities had caused a declaration of war between us; boy like, I enjoyed many a bout with him, but always had to cut and run, for he would chase and butt at me until my wind was exhausted. Being fleet of foot I could outrun him every time.

I was quietly casting across stream into some dog-tail weeds, where we could always find Pickerel, when hearing the familiar b-a-a-h-h! behind me, I turned, and there was my enemy, head up and “sniffing the battle afar off.” I had just been congratulating myself that I was safe, shaking my fist and laughing at him, because another stream ran between him and myself, about forty feet wide

A Pickerel took my bait and was running down stream. I was fishing just then: the ram did not trouble me any. After playing this fish a few minutes I landed him, and put on another minnow, had cast out a few yards down stream, and struck another fish; he was gamy and gave me plenty of fight.

Absorbed with my fish I forgot my surroundings. The

PICKEREL or FEDERATION PIKE—*Esox reticulatus*

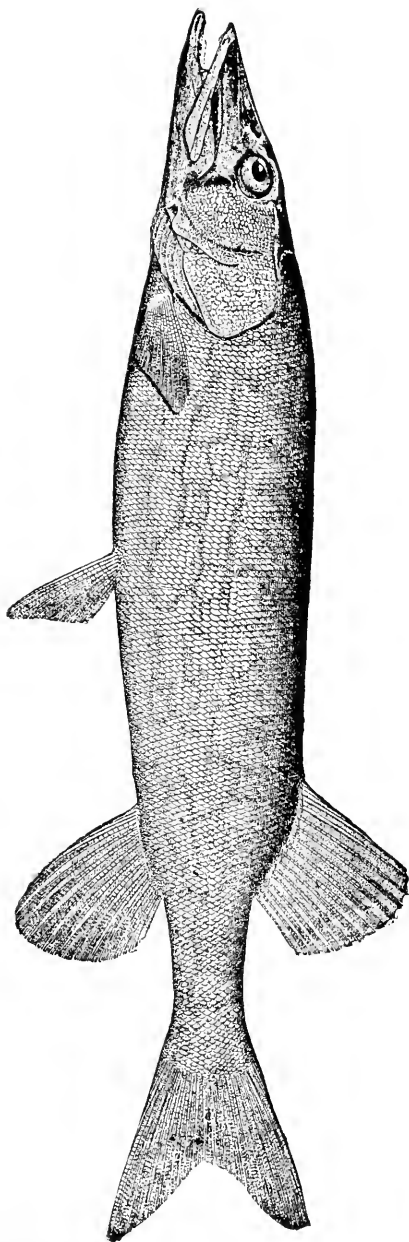

Pickerel was fighting to get my line round some of the roots that run out into the stream. The hook held good but my fish was too cunning for me; a quick movement and my line was in a tangle. I stooped to disentangle the line, my head well over the river, when a fearful butt, a plunge, a splash, a yell, a sputter, and a half-choking boy came to the surface. The moment he got his breath, there was a string of threats and vows of death and vengeance against the old ram. Hatred and scorn could not wipe out this bitter insult. If it must be a fight, let us have it out now; but the ram was rampant; never an inch would he yield, not even to let the boy get out of the water. Hadn't he put in some good licks and run up the pasture, and jumped at the end of the stream to come at me? Hadn't he come to accept the challenge? Hadn't he took me at my word and downed me? and I was all this time swimming. Yes he had got the best of me; but I must get out or drown! Making for the bank, I seized the butt of my rod, detached it, and as Mr. Ram charged, I gave him a crack across his nose that halted him.

I was out on the bank in a second, and ready for the second charge—in rebuttal. I cracked him one over the head, and then began a picnic!

I was cold and shivering when I came out of that mill-stream, but in a few minutes my clothes were steaming from the violence of my exertion. He had ram'd me once, and tried many times to again butt me into the river. I could swim like a duck, but was opposed to being driven into the water like a musk-rat. Both of us were tired out, and my only hope of victory was in hanging on the horns of the brute—and getting in whacks, when I could, on his head and sides.

I let go and lifted my club; but he turned tail, and ran. I loosed my fish line and fortunately the Pickerel was still there. I took him in, rod and line, but the butt was a total wreck. Taking my two fish I made my way to the house, where mother, meeting me at the door, with wondering eyes exclaimed—"You'll be drowned yet!"

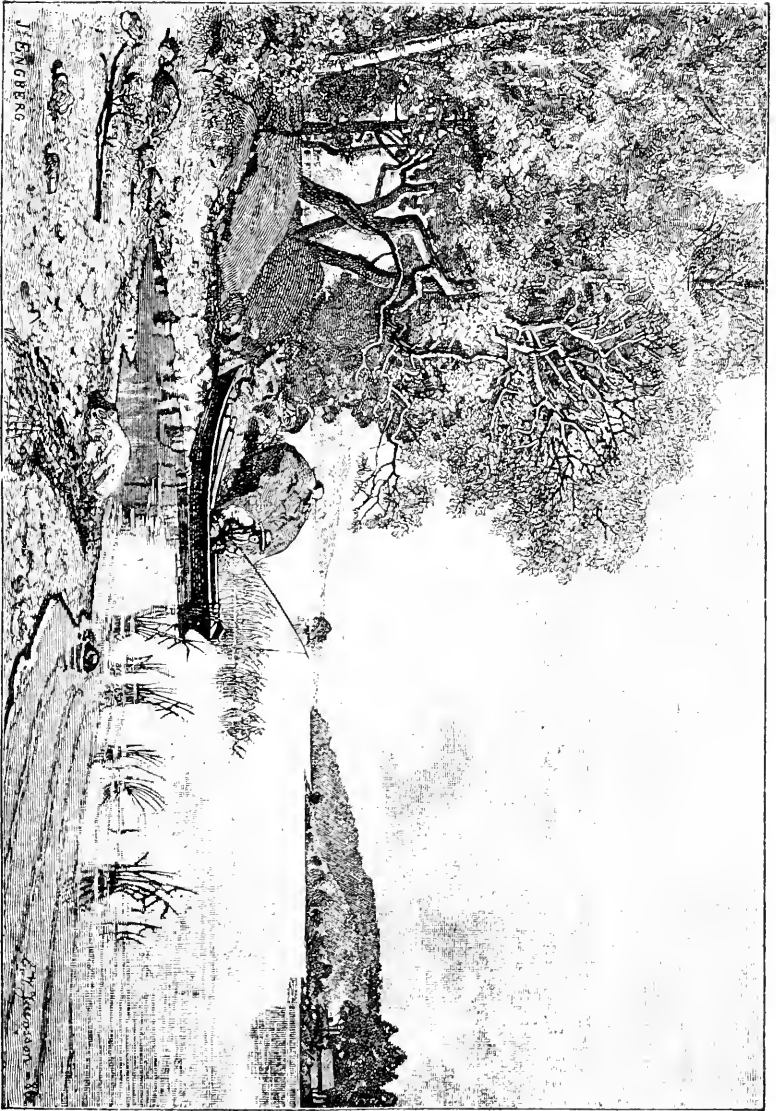

"THE LAST THROW."



No wonder! nose bleeding, hands torn and scratched, pants split into ribbons—but I had my fish, and kept a close mouth. The ram was a valuable animal, of choice breed, and I knew that in case he died there was a choice licking in store for me. "Silence is golden," sometimes, and I kept mum. For years my old enemy and I understood each other thoroughly.

Rams seldom die, unless killed. I could always thereafter fish that stream again unmolested; but let me go out of the pasture gate without a stick, and the ram was rampant.

#### HOW CAN I CATCH PICKEREL?

With anything—a walking-stick, and a string with a spoon-hook on it—or with a long stick cut beside the stream, a tow line as large as your little finger, and a big hook impaling a mouse, a frog, a piece of fat pork; a slice of bacon, with the outer skin left on and cut about two inches long, shaping the bait like a minnow. The Pickerel is a fool fish when hungry, and I am inclined to think will jump at even bare hooks, if only they spin. But there is as much concentrated essence of fun in fishing for Pickerel, with fine tackles, as you can get out of the mailed warrior, boasting the grand lineage of a *Micropterus Dolomieu*; and the former fish completely puts in shade the *Stizostethium vitreum*, for fighting to the last gasp.

With a Bethabara wood rod, whose tips would slip into a barley straw, a fine Trout line, a rubber click-reel, and a single Sproat or Sneck-bend hook, impaling a Storer's minnow, or silver shiner through the back, I have hooked and landed Pickerel, after fighting them for several minutes. No Trout ever gave more fun than Pickerel will, when they do take a notion to rise to a fly. Large gaudy flies, allowed to sink beneath the surface, are attractive lure for any of the *reticulatus* family.

Where cold, clear streams abound, the Pickerel give an

amount of pleasure equal to that obtained in angling for the Pike. The savage seizing of a minnow bait; the rush, for fifty or sixty feet; the strike, and the sharp struggle that ensues, all engage an angler's attention, and give him a most delightful occupation for the time.

My own system of fishing for the Pickerel is similar to that of Pike-fishing—laying out as long a line as possible, gathering the line in the hand in the same manner, covering all of one hundred feet with the line, and fishing up-stream. While fishing in waters peculiarly the home of the Pickerel, I have anchored a boat, cast out a line fifty or sixty feet, kept the bait off the bottom, and moving all the time; and could have filled the boat with fish if I had been so disposed.

While fishing in a Minnesota Lake one summer evening, at the mouth of a small but quick-running stream, I found a school of Trout-Pickerel—common in this lake, and a handsome, clean fish.

I was fishing for Wall-eyed-Pike at the time—a fish often caught in this lake, weighing five to eight pounds—and used a pair of Bass flies, the “Oriole” and “Black-and-Gold”.

At the first cast I made the fish came to the surface by the half dozen. I saw they were “Banded and spotted,” but could not for the moment place them. I knew they were not Wall-eyes, but could not for the moment determine what they were.

My second cast was made, and away went my fish. In a few moments I saw that I had hooked a second fish, and they began pulling two ways at once. Though not large fish, I had all I could do to save my rod. Gradually bringing them to the boat, I found one hooked safely and the fly outside of its mouth; the other was hooked just above its tail—foul-hooked, but I managed to save both. For an hour I had all the fun I wanted, and could have caught fifty Pickerel during the time, all with big Bass flies. I could not eat so many; there was no one near to give them to; so we moved



away from the stream, found a bank where the Wall-eyes were feeding, and put in the balance of the evening, until nearly ten o'clock, fishing for these with flies and grasshoppers.

Fishing in Douglass County, Minnesota, during June, 1888, I found a stream running into a lake, and some boys having "dead loads of fun," as they expressed it, fishing for Bass and Pickerel. I secured a boat, pulled out from shore until I found the channel-bank, a shelving ledge, that dropped from about four feet deep down to about twelve feet; dropped my anchor in the four feet of water, and then run out until I could fish in the deeper part. I had minnows for bait, but wanted to try for Bass with flies, as they took the bait gamily and seemed inclined to rise for it. Putting on a Cheney and Black-and-Gold, I cast out a few times and found the spot where Pickerel were lying. I hooked two fish and played them carefully. When getting them to the boat I found a Pickerel and a Wall-eye on the hooks. I spent an hour at that spot, and caught thirty pounds of fish, distributing them amongst the boys who were fishing on the bridge crossing the stream and who had not caught anything. Then lifting my anchor I drifted out into deeper water, but the Pickerel seemed to follow me, for at every cast a Pickerel rose to my flies. I would skitter the flies along the surface of the water, when flip! swish! would come several fish at the same time.

I had to pull up my anchor and get!—the only time in a life-time when Pickerel were too many for me. But what was the use of catching them? the hotels were full of fish: the farmers caught all they wanted; even the boys cried "enough!"

Shortly before pulling up anchor I hooked, on a dark brown fly, a Pickerel weighing about one and a half pounds. While fighting him, my gut leader somehow caught another fish; it pulled and tugged, squirmed and twisted, until I expected to lose flies and leader, but by handling them gently

I brought them to the boat, when I found the leader had caught into the gill and the dropper had twisted around the gill. I dropped the unhooked fish into the water again, and pulled for my hotel, having been surfeited, for once in my life, with Pickerel-fishing.

## THE WHITE PERCH.

BY FRED MATHER.

**T**O-NIGHT my banjo is attuned in a minor key to sing of a minor fish, which, in some lands, would take higher rank than it does on our Atlantic coast where it is native. All fishes which take the fly deserve to be classed above those that can be lured only with bait.

A man in the audience here suggests that the banjo is not properly strung, and intimates that the White Perch, which he calls *Roccus Americanus*, would, under this ruling, be classed as superior game to its big brother, the Striped Bass, or Rockfish, which it pleaseth him to speak of as *Roccus lineatus*. This interruption cannot be noticed now, for one cannot improvise without having some hours wherein to do it, and, had he been a friend, he would have warned me some days in advance that he had a plan to bring down the house with my answering verse. As it is, the head usher gets the sign that I do not know the person, and he is ejected for disorderly conduct. The dignity of the profession must be maintained at all hazards, and my course is based on what Iago says of Roderigo:

“For I mine own gained knowledge should profane,  
If I would time expend with such a snipe.”

This is a favorite gag that I always get off on a snipe-shooting companion when I miss a bird, but have not sprung

it on the fishermen before. I learned it from Edwin Booth; he has made it a chestnut to his audiences, but I might work it in as original in the dime museums until the fat man takes to applying it to the living skeleton; that would paralyze it for future use.

Once in a while I get a sore-headed fit but it passes like a thunder storm, leaving a better atmosphere behind it. Such a fit comes on when I hear, or read of, a good fish being denounced as a "vulgarian" because it is not "first-class." In Europe it is said that only princes and Americans ride first class, and I have seen the time that a cattle-car would have been welcomed as a means of abolishing space, while "counting railroad ties" was the only alternative between walking when "the ghost did not walk" and paying railroad fares. Therefore I do not rage with the heathen, but accept the best that is to be had. Years ago, when living in New York City, I have gone to Italian opera, on off-nights when there was no sparring at Harry Hill's or dog fight at Harry Jennings, and really enjoyed it as a change, on the same principle as the old European Professor who rode in the third-class coach because there was no fourth.

After reading the above there appears to be a digression, but foot-paths are always more attractive than highways; and if I can't digress, then, to use the simile of the beginning, I had best let down the banjo bridge and "uncork." The point that was intended to be made is this: It is the fashion in this country to decry certain fishes, that are so far above many of those that both ancient and modern British anglers fish for that it has become necessary to defend some of the New World forms which have made the heart of Izaak Walton rejoice. First in this class is the Big-mouthed Black Bass, which a few still persist in calling "Oswego" Bass (how I hate that name!) It is a grand game fish, and is more certain to rise to the fly than the Small-mouth, to which its detractors always compare it. Where is the other duffer in the audi-

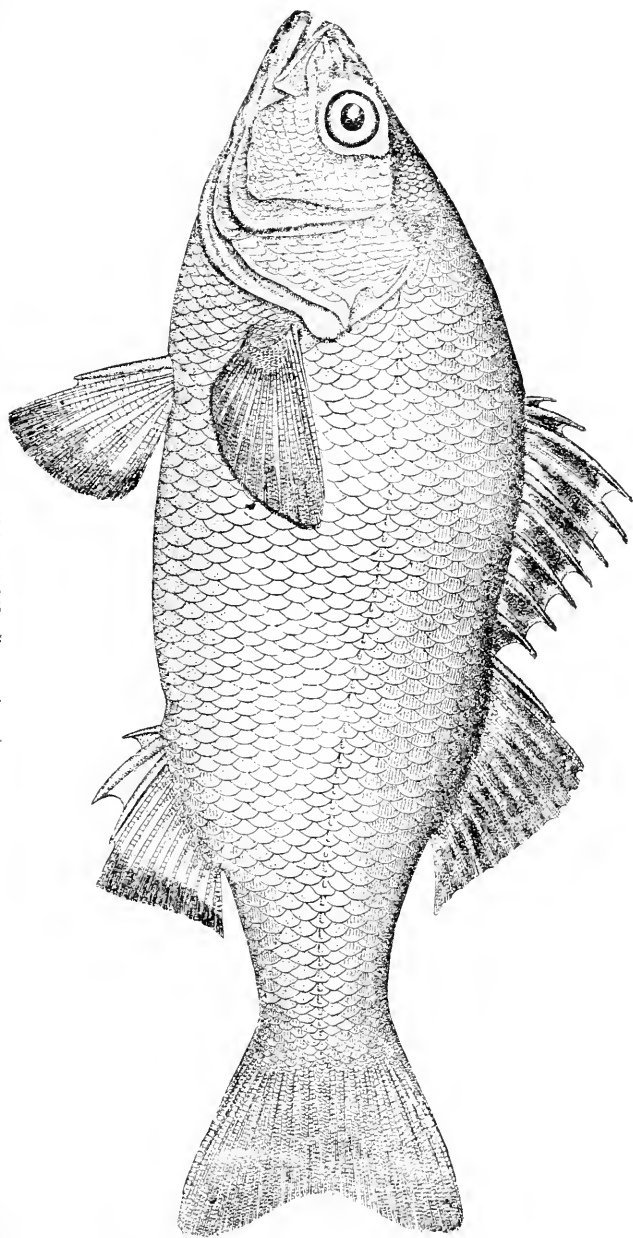

WHITE PERCH—*Morone americana*.

ence now who insists that the banjo never was in tune? If he interrupts I will refer him to Dr. Henshall, and if he can find anything that the apostle of the Black Bass has said that will sustain his position, or controvert mine, then we confess judgment and invoke mercy from the court.

There was no digression in the last paragraph, although one was attempted. The fact is that some American fishes have not received their proper rank as game, and the Big-mouthed Black Bass was instanced as a most glaring case in which a noble fish has been actually abused and reviled. In the subject of my song, the White Perch, no such claim is made; it has simply been neglected. I get some fair sport out of it when the Trout streams are far off, railroad fares high, and time, which was not made only for slaves and setting-hens, is limited. The White Perch was one of the things that I pursued in childhood, and in advancing years it still finds favor. Like a poor man it fails to receive justice.

“Here’s a fish hangs in the net like a poor man’s right in the law; ’twill hardly come out.”—*Pericles, Act ii., Sc. 1.*

“The imperious seas breed monsters; for the dish, poor tributary rivers as sweet fish.”—*Cymbeline, Act iv., Sc. 2.*

Often while playing my favorite part of a truant school-boy—a *role* which pleased a few chums but never met favor from parental authority—has a small White Perch shown its silvery sides and bristling spines between the surface of the water and the deck of some craft at dock on the upper Hudson. We boys fished on general principles, in those days. There were no rods, lines or hooks for special fishes; we went to the village grocery and bought a few knots of the cheapest line, half a dozen hooks—two for a cent, pounded out a piece of lead for a sinker, and there we were, equipped for several days fishing for ten cents!

Floats and poles we despised, because as our oracle, John Atwood, said: “They aint no use, ’cause when you got a pole you just yank ’em out so quick you don’t have any fun;

but when you haul 'em in lively on a hand-line you've got time to feel 'em wiggle, and to wonder what you've got."

This, then, became our fishing law, for John had laid it down, and we wanted to "feel 'em wiggle," whether Chub, Sun-fish, White Perch, Spawn-eater, Bull-head or Eel; for, as before said, we fished on general principles for anything that had an appetite for worms. How our blood stirred when a half-pound Eel made us think we had a monster Perch or perhaps a Bass! Ah me! what fun we all had when boys. "Fun" was the word then; as we get older it becomes "sport."

The Perch of those days—we will drop distinctive names now—seldom grew above six inches in length in the Hudson, about Albany, and was like burnished silver, a brilliancy that it loses in brackish water, where it breeds and grows to its limit. Then we did not know that learned men would dispute about its name, whether it should be *Morone* or *Roccus Americanus*; and it is possible that our interest would not have been thoroughly aroused to the important fact if we had. We would probably have asked John Atwood about it. John was at least a dozen years old, and if any person knew more about fish than John, we did not know who he was. He could make a bob for Eels, snare Suckers, and could tell whether a nibble was made by a Sun-fish or a Perch; and as for names of fish, bless you! he knew them all.

In later years the books tell me that this Perch is found in brackish waters along the Atlantic Coast of North America, from Cape Cod to Florida, and I have learned that its common name is shared with a worthless fish which dwells in the Great Lakes, and with some other fishes either inland or on the Pacific Coast; but my song is not of them.

The White Perch had passed away into the realm of boyhood recollections by reason of years of wandering inland, where it is unknown, and the fly-rod had displaced the hand-line which John Atwood had taught was the highest form of

sportsmanship, when suddenly this Perch appeared as a fish that readily took the fly, and was therefore elevated from the realm of boyish fun to "legitimate sport." And this is the way it happened: An invitation to fish for Black Bass, in a private pond on Long Island, had been accepted, and several flies were cast, one evening toward the close of July, without reward. Flies were changed and position was shifted several times, until the combination was a clear spot in some weeds and a red ibis and gray drake on the leader. Then a rise; my boatman irreverently said: "arise my soul, arise!" The reel sang as the morning stars never did, and a silver-sided fish leaped into the air. It was not a Bass, but something strange; the spring of the rod soon checked the stranger, and the reel began to draw us into closer relationship. As we were approaching each other a second fish seized the other fly, and then the real contest began. My ordinary practice is to fish with one fly if the fish will take it, and to put on a second one only when they seem indifferent to what is offered. Two fish on a single gut do not represent two souls with but a single thought, although they may have two mouths which jerk as one, and they often part company when their desires to separate are synchronal; hence the experienced angler seldom cares to risk his leader in a contest with a double, and, if it is repeated, will remove one fly and content himself with one at a time. A school had been struck—for this perch is gregarious, and is usually present in numbers or is entirely absent; and soon a fine fish was struck that leaped into the air three times before it was brought to hand—a habit not mentioned, to my knowledge, by angling authors, none of whom mention fly-fishing for it.

Norris says: "Frank Forester, in his book on angling, dismisses it (the Perch), after a slight notice, as 'not sufficiently important to merit more particular notice.' The latter gentleman missed much, by not becoming acquainted with our little friend *Pallidus*." But even Norris, the Nestor of



American anglers in his day, only mentions our fish as inhabiting the estuaries and fresh waters that run into the sea, and does not speak of its capture with the fly. Scott, who was not much of a fly-fisher, if at all, says: "This fish is peculiarly adapted for the sport of juveniles," and after recommending its capture with light Bass tackle, further says: "A White Perch which weighs but a pound affords sport with light tackle, and, when weighing three pounds, it plays very vigorously." No doubt! I never took one that would weigh two pounds, and have had good sport with them. Do you ask about tackle? A Trout rig, I use that for everything, a ten and one-half foot split-bamboo rod of ten ozs., a water-proof silk line (heavy "D," I think,) and an eight-foot gut leader, with either a red ibis, gray drake, Parmacheene-belle, royal coachman or other bright fly, dressed on a No. 5 or 6 Sproat hook. My rod is heavy enough to cast a small frog, if I condescended to use bait, or to handle a larger Black Bass than ever struck it; and with that rig I would like to strike a ten-pound Salmon. True, it might be a bad day for the "rig," but if the fly had done its full duty and neither man nor age had impaired the strength of the leader, it would delight me to see a ten-pound fish, of any species, smash the rod or break the line. This rod has stood the severest strain that a rod can get, and that is in tournament casting, and the necessary preliminary practice; and it has won prizes, in other hands. But all this is a digression, provoked by an inviting foot-path across the untrodden fields of fly-fishing for White Perch, and just how to get back into the forsaken highway is a problem. My evil genius suggests that I give a technical description of the White Perch; beginning with its systematic name, or names, and after giving all the synonyms, and a map of its fin-rays, to enumerate its scales in both lateral and vertical rows, ending with its dental and digestive apparatus, which all readers will acknowledge to be the product of a learned man but will not read. A better

adviser, *me judicc*, says that if it is certain that the reader will skip all that, then I had better do so. I ask my good angel what to substitute, and intimate that I have already said all that is necessary on the subject of fishing with the fly for White Perch; but my mentor says that so far the fishing has been in mill-ponds, where they are rarely found, and has not touched upon the taking of them in the brackish waters where they most abound; and suggests that something be said of that. Now there is nothing more to be said on the subject; you can take the fish wherever you find it, with either fly or bait, and it is no part of my purpose to tell about taking them with worms, pieces of fish, crickets, or other gross lures which appeal to their baser appetites. With Dr. Bethune, "I have long since washed my hands of the dirty things," and will only say, do not put a water-proof silk line into salt water, because it will soften and ruin it; use linen or other material.

If after reading "this bald unjointed chat" there is a desire for a serious consideration of the merits of the fish, take down Goode's "American Fishes," and read his last paragraph, p. 38; it gives the White Perch a high grade, and recommends it to "the easy-going British Angler of the Waltonian type, to whom the pleasure of the rural scenery and quiet outing is of more moment than the strength and voracity of the fishes," etc. Goode and Norris are the only writers that I recall who have given this game fish a fairly decent notice. But this yarn has been spun too long and I am reminded of Edgar's remark (King Lear, Act ii., Sc. 4): "Fratерetto calls me, and tells me, Nero is an angler in the lake of darkness." And thereby hangs a tale! "To this complexion may we come at last." How many of us can plead not guilty to Cæsar's charge against Antony:

"He fishes, drinks, and wastes the lamps of night in revel?"

If there is any moral to be drawn from what has been

written I would much like to know it, for I assure you that none was intended; believing, with the servant in *Romeo and Juliet* (Act i., Sc. 2), "that the shoemaker should meddle with his yard, and the tailor with his last, the fisher with his pencil, and the painter with his nets," I will put the banjo in its case and no longer mar the harmony of the night, lest some one say with *Hotspur*:

"I had rather hear a brazen can'stick turned,  
Or a dry wheel grate on the axle-tree."

The ditty has been hoarsely sung, the curtain rung down; the lights are out—Good Night!



THE YELLOW BASS, WHITE BASS, ROCK BASS,  
CALICO BASS, CRAPPIE, YELLOW PERCH  
AND OTHER "BOYS' FISHES."

---

BY DAVID STARR JORDAN.

---

THE SAUGER—*Stizostedion canadense* (C. H. Smith).

*Description.*—Body elongate, more terete than in the Wall-eye, with the back broad and scarcely compressed; depth of the body four and one-half to five times in length; head quite pointed, about three and one-half in length, slope of the profile greater than in the Wall-eye; eye smaller, five to five and one-half times in the head; mouth rather smaller, the lower jaw included; maxillary reaching to opposite posterior margin of eye; opercle with a sharp, flat spine, usually a smaller one below it, and an obscure one above; sometimes two or three smaller ones below, often none; the position and number of these spines extremely variable; specimens preopercle strongly serrate, the lower spines hooked forward; cheeks usually scaled—the hinder third, or less, sometimes naked; median furrow on top of head closely scaled. Coloration paler and more translucent, the shades less blended than in the Wall-eye; olive gray above, sides considerably brassy or pale orange, with much black mottling; the black gathered into several definite dark areas, the most distinct of these being opposite the second dorsal; two others fainter, at each extremity of the spinous dorsal, and one at base of caudal; these blotches are irregular and diffuse, but very characteristic; young specimens are pale orange, with broad black shades; spinous dorsal, with two or three rows of round black spots, one of each row on the membrane between each pair of spines; indistinct blotch on posterior part of the fin; a large black blotch at base of pectorals; second dorsal with about three rows of irregular dark spots; caudal yellowish and dusky, almost

barred. Fin-rays: dorsal XII, 1-17, varying to XIII, 1-18; anal II, 12; lateral line with ninety-two-ninety-eight scales; pyloric cæca four to seven, four of them larger than the rest, of different lengths, all small and shorter than the stomach; the usual number is six, but the two small ones are sometimes one or both absent, sometimes duplicated. Length of adult 10 to 15 inches.

EVERYWHERE to the North, from Quebec to the Ohio River and on north-westward to Montana, wherever the great Wall-eye goes, there is found its little brother, the Sauger. Like the Wall-eye, it is a long, slim, swift, pirate-rigged fish, with a mouth well armed with the sharpest of teeth. It is a fish of finer texture than the Wall-eye, richly shaded with yellow, and translucent when held up to the light. The Sauger ranks as a food fish lower than the Wall-eye, and is usually classed by the lake fishermen as a "soft fish," while the Wall-eye is unquestionably a hard one. But the difference may come solely from the fact that the Sauger grows to a small size, seldom or never more than eighteen inches in length, and oftener not more than a foot. It is a fish of lakes and quiet rivers, often found on sandy bottoms, hence its name of "Sand Pike," heard in many localities. It is however not a Pike, and the name Sauger which belongs to no other fish is the best name that anglers can use for it. The very worst name for either species is the name "Salmon." In fact, for an angler to call any spiny-rayed fish a "Salmon," is an acknowledgment on his part that he is no angler at all, but simply a fish hunter to whom all fishes are so much meat, and who has no care for niceties in language, or for nicety in his work. The fact that the uneducated people of various Southern States who have never seen a Salmon, suppose the Pike-perch to be such, is not a justification for those who know better.

So far as the game-qualities of the Sauger are concerned, I know nothing which will distinguish him from the Wall-eye or the Perch. He is a carnivorous and voracious fish, not likely to let anything escape which seems to him good to eat.

SAUGER or SAND PIKE—*Stizostedion canadense*.

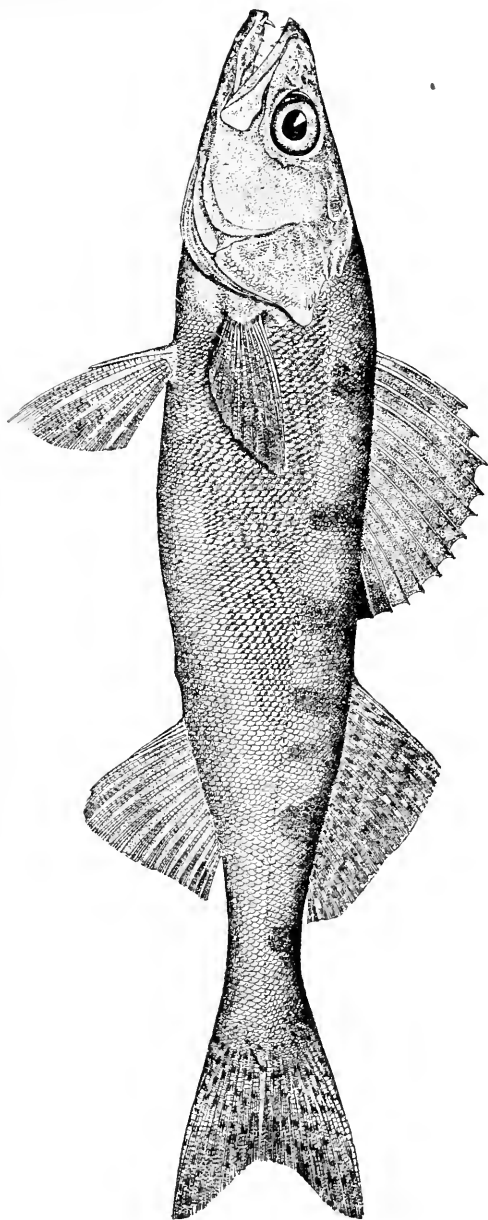

THE SUN-FISHES—*Centrarchidæ*.

Every boy east of the Rocky Mountains begins his career as a real angler with the Sun-fish. He may have caught Horned Dace or Shiners with an angle-worm on a crooked pin, but to catch such fishes even the smallest boy knows is not angling. He feels his first real angler's enthusiasm when, seated on the projecting roots of the big sycamore tree, at the "old swimming-hole," he sees this little strutting fish, round as a dollar and resplendent in orange and green, trying to keep off intruders from its nest of gravel and sand. He throws his bait in the direction of the nest. The little fish sees a new enemy and makes a quick rush at the bait. The cork bobs excitedly. Excitement seizes the boy, and the little fish is the first prize of the young angler.

If he lives in the East or the North, the Sun-fish he takes will be the old-fashioned Sunny or Pumpkin-seed, *Lepomis gibbosus*, the brightest and most active of them all, although not the largest. Should he live in the South-west, some of the other species will fall to his lot; but all the genuine Sun-fishes stand in the same relation to their friend, the boy. Let me quote from Professor Goode's admirable account of the Youthful Fisherman:

"The 'Pumpkin seed' and the Perch are the first trophies of the boy-angler. Many are the memories of truant days dreamed away by pond or brook-side, with twine, pole and pin-hook, and of the slow homeward trudge, doubtful what his reception will be at home; pole gone, line broken, hook lost, the only remnant of the morning's glory a score of lean, sun-dried Perches and Sunnies, and, mayhap, a few Eels and Bull-heads, ignominiously strung through the gills upon a willow withe, and trailing, sometimes dropping from weary hands, in the roadside dust.

"Then in later youth came the excursion to some distant pond; the early start, long before sunrise, the cane-rods trailing over the tail-board of the wagon, the long drive between



fresh forests and dewy meadows, the interested faces at the wayside windows. Then at the pond the casting of the seine for minnow-bait, the embarkation in the boat, the careful adjustment of sinker and float, and the long, delightful, lazy day, floating over jungles of Eel-grass and meadows of lily pads; now pulling in by the score the Shiners, Pumpkin-seeds and Perch; now passing hour after hour without a bite.

“Just as the nightingale and the lark, though eminent among the lesser song-birds of Europe, would, if native to America, be eclipsed by the feathered musicians of our groves and meadows, the Perch and Sun-fish yielded to the superior claims of a dozen or more game fishes. The Sun-fish and the Perch must not be snubbed, however, for they are prime favorites with tens of thousands of anglers who cannot leave home in quest of sport. They will thrive and multiply, almost beyond belief, in ponds and streams too small for Bass, and too warm for Trout and Land-locked Salmon; and I prophesy that they will yet be introduced in all suitable waters throughout the continent, which they do not now inhabit.”

Besides the real Sun-fishes, which the books call *Lepomis*, there are other fishes more like them and of the same family, which form a regular gradation in size and gameness, from the Pumpkin-seed to the king of our western and southern rivers, the Black Bass. And the boy recognizes this series. He knows that to catch a Red-eye is to place himself on the grade of promotion; above the Red-eye comes the Crappie, and above the Crappie the Calico Bass. One step more to the Black Bass. Could there be a more natural gradation? Yet that these species are only Sun-fish of a larger growth goes without discussion.

THE COMMON SUN-FISH, PUMPKIN-SEED OR SUNNY—*Lepomis gibbosus* (Linnæus).

*Description.*—Body deep, very gibbous, both dorsal and ventral outlines strongly curved; depth in adult, a little more than half its length without caudal; the head a little more

than a third; eye large; 8 to 4 1-2-in. head, about equal to the opercular flap; mouth small, the maxillary scarcely reaching to orbit; profile usually forming an angle above eye; fins well developed, the spines of the dorsal rather high; the spines as long as from snout to past pupil; pectoral fins long, reaching to anal; opercular flap moderate, broad and short, bluntly rounded, black except a broad edge on the lower posterior part, which in life is always bright scarlet and always a striking feature; fin-rays: dorsal X, 10; anal III, 10; lateral line with 36 to 45 scales; coloration very variable, according to the surroundings of the fish; back greenish-olive, usually dark; sides profusely spotted with orange; belly orange-yellow; lower fins orange, the upper olivaceous, with the membranes closely spotted with orange and olive, with clear blue wavy streaks. Length 6 to 8 or 10 inches.

The common Sun-fish is found throughout the Great Lake Region, in the Upper Mississippi, eastward to the rivers of Maine, and thence southward as far as Georgia in the streams east of the Alleghanies. Its geographical range, singularly enough, exactly coincides with that of the Yellow Perch, but no other fish whatever shows the same eccentricity of going southward on the east side of the mountains, while avoiding the middle and lower Mississippi.

As already stated, the Sun-fish is pre-eminently a boy's fish. It is active, handsome and voracious. Any bait small enough for it to swallow, it will take with an energy worthy of a fish ten times its size.

The following account of its nest-building habits is given by Dr. Holbrook. I suppose that other Sun-fishes share these habits, but no other species has been so carefully observed.

"This fish prefers still and clear waters. In the spring, the female prepares herself a circular nest, by removing all reeds or other dead aquatic plants from a chosen spot of a foot or more in diameter, so as to leave bare the clean gravel or sand; this she excavates to the depth of three or four inches, and then deposits her spawn, which she watches with the greatest vigilance; and it is curious to see how carefully she guards this nest against all intruders; in every fish, even those of her

COMMON SUNFISH—*Lepomis gibbosus*.

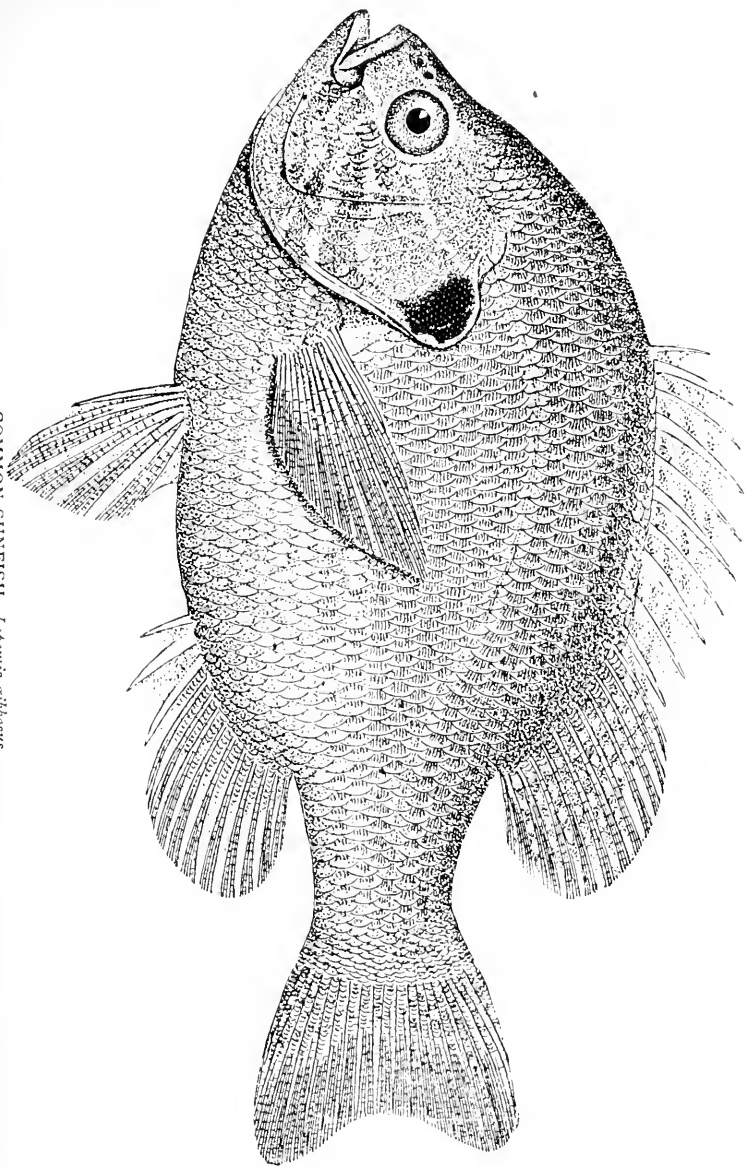

own species, she sees only an enemy, and is restless and uneasy till she has driven it away from her nursery. We often find groups of the nests placed near each other along the margin of the pond or river that the fish inhabits, but always in very shallow water; hence they are liable to be left dry in seasons of great drought. These curious nests are frequently encircled by aquatic plants, forming a curtain around them, but a large space is invariably left open for the admission of light."

Thoreau ("Week on Concord and Merrimack") thus spoke of this fish:

"It is the most common of all, and seen on every urchin's string, a simple and inoffensive fish, whose nests are visible all along the shore, hollowed in the sand, over which it is steadily poised through the summer hours on waving fin. Sometimes there are twenty to thirty nests in the space of a few rods, two feet wide by half a foot in depth and made with no little labor, the weeds being removed, and the sands shoved up on the sides like a bowl. Here it may be seen early in the summer assiduously brooding, and driving away minnows and larger fishes, even its own species, which would disturb its ova, pursuing them a few feet, and circling around swiftly to its nest again; the minnows, like young sharks, instantly entering the empty nests, meanwhile, and swallowing the spawn, which is attached to the weeds and to the bottom on the sunny side. The spawn is exposed to so many dangers that a very small proportion can ever become fishes, for besides being the constant prey of birds and fishes, a great many nests are made so near the shore, in shallow water, that they are left dry in a few days, as the river goes down. These and the Lampreys are the only fishes' nests that I have observed, though the ova of some species may be seen floating on the surface. The breams are so careful of their charge that you may stand close by them in the water and examine them at your leisure. I have thus stood

over them half an hour at a time and stroked them familiarly without frightening them, suffering them to nibble at my finger harmlessly, and seen them erect their dorsal fins in anger when my hand approached their ova, and have even taken them gently out of the water with my hand; though this cannot be accomplished by any sudden movement, however dexterous, for instant warning is conveyed to them through their denser element, but only by letting the fingers gradually close about them as they are poised over the palm and with the utmost gentleness raising them slowly to the surface.

“Though stationary, they keep up a constant sculling or waving motion with their fins, which is exceedingly graceful, and expressive of their humble happiness, for unlike ours, the element in which they live is a stream which must be constantly resisted. From time to time they nibble at the weeds at the bottom or overhanging their nests, or dart after a fly or worm. The dorsal fin, besides answering the purpose of a keel, with the anal, serves to keep the fish upright, for in shallow water where this is not covered, they fall on their sides.

“As you stand thus, stooping over the bream in its nest, the edges of the dorsal and caudal fins have a singular dusty golden reflection, and its eyes, which stand out from the head, are transparent and colorless. Seen in its native element, it is a very beautiful and compact fish, perfect in all its parts, and looks like a brilliant coin fresh from the mint. It is a perfect jewel of the river, the green, red, coppery, and golden reflections of its mottled sides being the concentrations of such rays as struggle through the floating pads and flowers to the sandy bottom, and in harmony with the sunlit brown and yellow pebbles. Behind its watery shield it dwells, far from many accidents inevitable to human life.”

Dr. Goode quotes from Mr. W. C. Harris: “I confess to a fondness for catching the ‘Pumpkin seed’ upon the lightest of light fly rods with leader and line of a spider-web consist-

ency. I have caught them, averaging a half pound in weight, by the dozen, with black and brown hackles, and when they reach that size they are so sprightly in their play, when hooked on Trout tackle, that we cannot deny them a niche in the gallery of game fishes."

THE LONG-EARED SUN-FISH—*Lepomis megalotis* (Rafinesque).

*Description.*—Body deep and rather short, the profile high and strongly curved; dorsal outline convex; depth more than half the length; head with flap a little less; dorsal spines low, lower than in most of the other species, in adults shorter than from snout to middle of eye; pectorals not reaching vent; gill-rakers very short and soft; opercular flap very long in adult, always with broad pale edge which is pinkish behind and bluish in front; in young specimens the flap exhibits every stage of development, no two individuals being alike in this respect. Colors very brilliant, more so than in any other of our Sun-fishes, but fading rapidly after death. The general color of an adult specimen is brilliant blue and orange, the black chiefly blue, the belly entirely orange, the orange forming irregular longitudinal rows of spots, the blue in wavy vertical lines along the series of scales; vertical fins with the soft rays blue and the membranes orange, sometimes fiery red; ventral and anal, dusky blue; lips blue; cheeks with blue and orange stripes; top of head and neck black; iris bright red; fins unspotted; young specimens with the ear-flap small, and the coloration variously dull; D. X, 10; A. III, 10; lat. I. 40.

Throughout the Mississippi valley, and on south-westward to the Rio Grande, this gorgeous little fish is abundant. It is also occasionally taken in the streams of the North-west, it may be found on every urchin's string in Indiana and Illinois. It is smaller than the common Sun-fish, and less active, although in coloration it is one of the gayest fishes that swim.

THE YELLOW-BELLY OR "BREAM."—*Lepomis auritus*  
(Linnaeus).

*Description.*—Body elongate, not much elevated. Snout moderately prominent. Mouth rather large oblique, the maxillary reaching past front of eye. Cheeks with rather small scales,

in about 7 rows. Scales of breast small. Palatine teeth few, rather large. Gill-rakers quite short, but stiff and rough; wide apart. Opercular flap very long (longer in the adult than on any other of the Sun-fishes except *Lepomis megalotis*), narrow, not usually wider than the eye. In the young the flap is variously shorter, but always narrow; lower margin of flap usually pale. Dorsal spines rather low. Color olive; belly largely orange red; scales on the sides with reddish spots on a bluish ground; vertical fins chiefly orange or yellowish; head with bluish stripes, especially in front of eye; no dusky blotch on last rays of dorsal and anal. Head (with out flap) 3-in. length; depth 2 1-8. D. X, 11; A. III, 9; Lat. 1. 47. L. 8 inches.

This handsome Sun-fish is found in all ponds and streams east of the Alleghanies from Maine to Florida. It reaches a length of eight to ten inches, and is a pan-fish and a game-fish not to be despised. In Virginia and the Carolinas, it is the most abundant of the Sun-fish, and thrives wonderfully in millponds.

THE BLUE-GILL OR DOLLARDEE—*Lepomis pallidus* (Mitchill).

*Description.*—Body deep and compressed, rather elongate, with slender caudal peduncle when young; short, deep and almost orbicular in very old specimens; head moderate, about one-third the length, with short snout, large eye, and steep profile; depth of body about half the length, in old specimens somewhat more; mouth quite small, the maxillary not reaching eye; opercular flap large, entirely black, with narrow margin at base, nearly as broad as long in adults; in young specimens the flap is usually quite small, and broader than long; fins large; dorsal spines very high, often higher than soft rays in young, their length about equal to the distance from snout to posterior margin of eye; pectoral fins very long and falcate, reaching beyond beginning of anal; scales moderate; those on cheeks in about six rows; lateral line with 45 to 48. Coloration, adults dark olive or bluish green; belly and lower parts more or less coppery; no blue stripes on the cheek; a large dusky or "inky" spot on the last rays of dorsal and anal; young specimens show several undulating or chain-like transverse olive bars, and a bright purplish luster in life. Length 6 to 10 or 12 inches.

This species is the most widely diffused of all our Sun-

fishes, and westward it is everywhere the most abundant. Like *Lepomis megalotis* it is subject to very great variations in form, coloration, and general appearance, yet it is usually, of all Sun-fishes, the species most readily recognized.

This fish, called the Blue Gill, in Michigan, is abundant in all waters from New York to Dakota, and thence southward to Florida and the Rio Grande. It reaches a larger size in the North, and in the vicinity of Lake Michigan it is the most important of the tribe. In large lakes it grows large, but in small streams it adapts its body to what it can find to eat—an arrangement not unknown elsewhere in the class of fishes.

THE GREEN SUN-FISH—*Lepomis cyanellus* (Rafinesque).

*Description.*—Body oblong, or elongate, the depth usually about 2 1-2-in. length; the head about 3; mouth pretty wide, the maxillary reaching nearly to middle of eye; lower jaw rather longest; fins rather small, the dorsal spines very low, the longest scarcely longer than snout; scales always small, about 46 in the course of the lateral line; opercular flap short and small, less than eye, broadly margined with pinkish, the black confined to the bony part of the flap. Colors extremely variable, the prevailing shade usually green, with a strong brassy luster on sides, becoming usually yellow below; often nearly all deep green, often with the blue predominating, sometimes in northern specimens nearly black; each scale usually with a sky-blue spot, and more or less of gilt-edging, which gives an appearance of pale lines along the sides; besides the blue spots, some specimens, usually young or half-grown ones, are crossed by vertical bars of a brassy olive, or sometimes almost black color; many adults are further marked by sprinklings of black dots; vertical fins marked with green and blue, the anal almost edged in front with pale orange; ventrals usually yellowish; iris red; cheeks with narrow wavy stripes of bright blue; usually a round black spot on last rays of dorsal and anal behind—the latter, and sometimes both, obsolete. A species extremely variable both in form and coloration, yet easily recognizable at sight.

This is a small but active and voracious sun-fish that generally makes his presence felt whenever an angle-worm is dropped in his vicinity. It is found in all waters between the



Rocky Mountains and the Alleghanies, and from Michigan to Texas. Wherever it is found it is abundant.

The other species of *Lepomis* are either scarce or small, or else wholly confined to the lowland waters of the South, and it may not be necessary to refer to them farther.

Closely related to these are some small species of other genera of Sun-fishes, found only in the lowland waters of the Eastern States from Massachusetts to Florida. These are the Banded Sun-fish, *Mesogonistias chaetodon* (Baird), straw-color, with jet-black cross-stripes, too small for a food fish, but too handsome to be overlooked by any angler. It is common only in the lowlands of the Delaware River.

*Enneacanthus obesus* and *gloriosus*, with shining spots of brown and blue, have a wider range, but reach no larger size, while *Acantharchus promotis*, the Mud Sun-fish, dark green, with darker stripes, much resembles the Red-Eye or Rock Bass.

THE WAR-MOUTH—*Chenobryttus gulosus* (Cuv. and Val).

*Description.*—Body heavy, deep and thick, depth 2 1-8 in. length; head about 2 2-3; mouth large, its maxillary reaching nearly to posterior margin of eye—the supplemental bone strong; scales on the cheeks in 7 to 9 rows; mucous pores about head very large; spines very stout, the longest as long as from snout to middle of eye. Color very dark green, sometimes almost black; three oblique bands across the cheeks, and a black opercular spot, pale-margined below, as large as the eye; young specimens are profusely mottled, like young Rock Bass; very old specimens from the lakes are dark olive green above, sides greenish and brassy, with blotches of pale blue and bright coppery red, the red predominating; belly bright brassy yellow, profusely mottled with bright red; lower jaw chiefly yellow; iris bright red; opercular spot short, as large as eye, black, bordered below with copper-color; 3 or 4 wide dark red bands radiating backward from across cheeks and opercles; separated by narrow pale blue interspaces; upper fins barred with black, orange and blue, the former color predominating. Length 8 to 12 inches.

A big, hearty, voracious fellow, the War-mouth lives in

the deep pools under the logs, and is the terror of the minnows and chubs. The species is common in all the lowland streams from North Carolina to Texas, and then northward into the Great Lakes, but it reaches its greatest abundance in the South. In size, color and habits, he is the duplicate of his cousin the Red-Eye or Rock Bass, and as a game-fish, is equally interesting.

THE ROCK BASS, RED-EYE OR GOGGLE-EYE—*Ambloplites rupestris*, (Rafinesque).

*Description.*—Body oblong, the depth about 2 1-2 in length; head 3 in length; profile convex, eye very large, about equal to snout, 3 1-2 to 3 3-4-in. head; cheeks with about eight rows of scales and a naked area; preopercle very weakly serrate, dorsal spines stout, rather low; D. XI, 11; A. VI, 10; lateral line with about 40 scales. General color, brassy olive-green, with much dark mottling, the young irregularly blotched with black, the adult more uniformly colored, each scale with a squarish dusky blotch, these forming more or less distinct longitudinal stripes; fine dark olive, the soft rays more or less barred; iris red. This species reaches the length of about a foot.

This well-known fish marks the transition from Sun-fish to Bass, and for its angler-lovers, the transition from youth to manhood. It is a fish of ponds, lakes and sluggish waters. You can catch them in the canals, or in any place where a fish of meditative habits can maintain itself. It is abundant throughout the Great Lake region, and thence south-westward in every stream as far as Texas. East of the mountains, I have seen it only in the Roanoke. It is most plentiful in the North, as it is not fond of warm water or of mud. Besides its name "Rock Bass," a good name of long standing, and embalmed in the specific name "*rupestris*," it has some other names equally good and appropriate, as "Red-Eye," and "Goggle-Eye," and by any of these names the anglers will know it anywhere. It is a pity to waste three good names on one fish, when so many other reputable fishes have no dis-

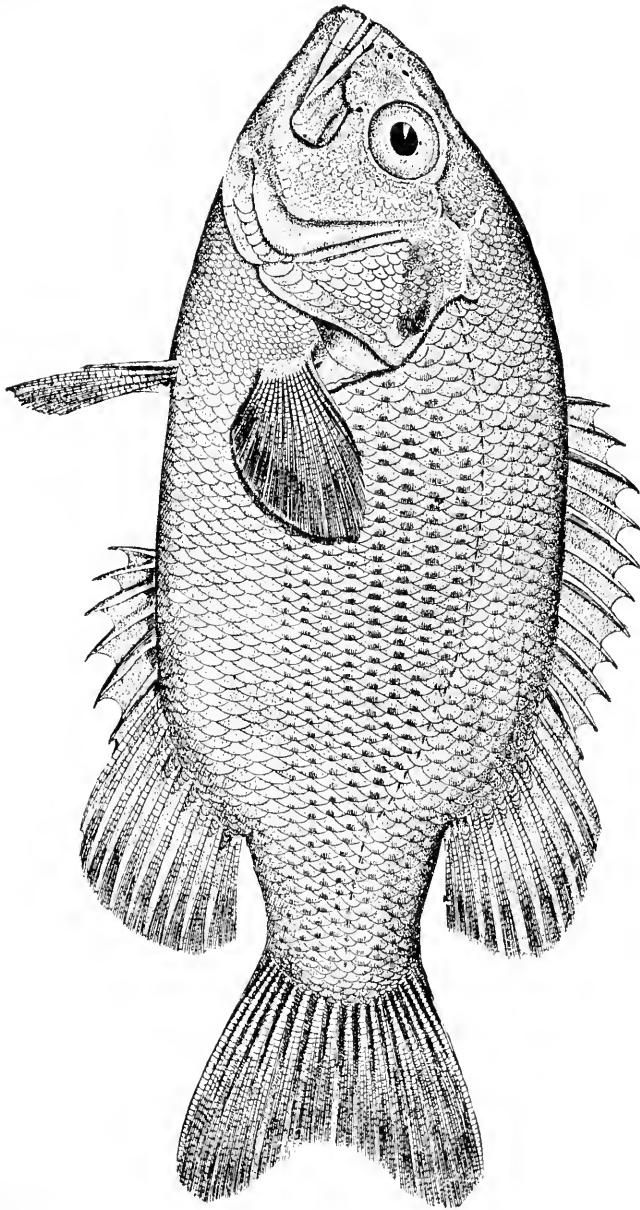

ROCK-BASS or RED EYE—*Ambloplites rupestris*.

tinctive name at all, but are compelled to wear the cast-off or made over names of other fishes.

THE SACRAMENTO RED-EYE—*Archoplites interruptus* (Girard).

*Description.*—Body oblong-ovate, compressed, the back considerably elevated anteriorly, depressed over the eye, the snout projecting at an angle. Mouth terminal, very large, the maxillary very broad, extending beyond pupil. Eye very large, 4 to 5-in. head. Scales on cheek in about eight series. Preopercle decidedly serrate. Dorsal spines rather low, strong. Pectoral short, barely reaching anal. Color blackish above, sides silvery, with about seven vertical blackish bars, irregular in form and position and more or less interrupted; a black opercular spot; fins nearly plain. Head 2 2-3; depth 2 1-2. D. XIII, 10; scales about 7—51—14. L. 12 inches. Sacramento and San Joaquin Rivers; abundant; the only fresh-water percoid west of the Rocky Mountains.

This fine fish is the double of the Rock Bass, which it resembles very closely, in size, color and habits. It is found only in the sloughs of the Sacramento and the San Joaquin Rivers, and it is the only fresh-water fish of the Perch or Bass kind which is found west of the Rocky Mountains. It seems to be a lineal descendant of our Rock Bass, and how it came to California is one of the standing puzzles in the geographical distribution of fishes.

There is in the Sacramento another fish, likewise wrongly called a "Perch," a viviparous "Surf-fish" or Embiotocoid, *Hysterocharpus traski*. This species is of little importance as food or as game, but it is very interesting to naturalists from the fact that it brings forth its young alive. It gives birth to some eight or ten young, each about an inch in length, and quite ready at birth to take care of themselves.

THE ROUND BASS—*Centrarchus macropterus* (Lacepede).

*Description.*—Body very short, suborbicular, the snout projecting; back and belly closely compressed; the greatest thickness of the body being through the opercular region; top of head broad and flattish, the interorbital space being about equal to eye; mouth small, very oblique, the maxillary scarcely reaching middle of eye; eye very large, about 3-in.

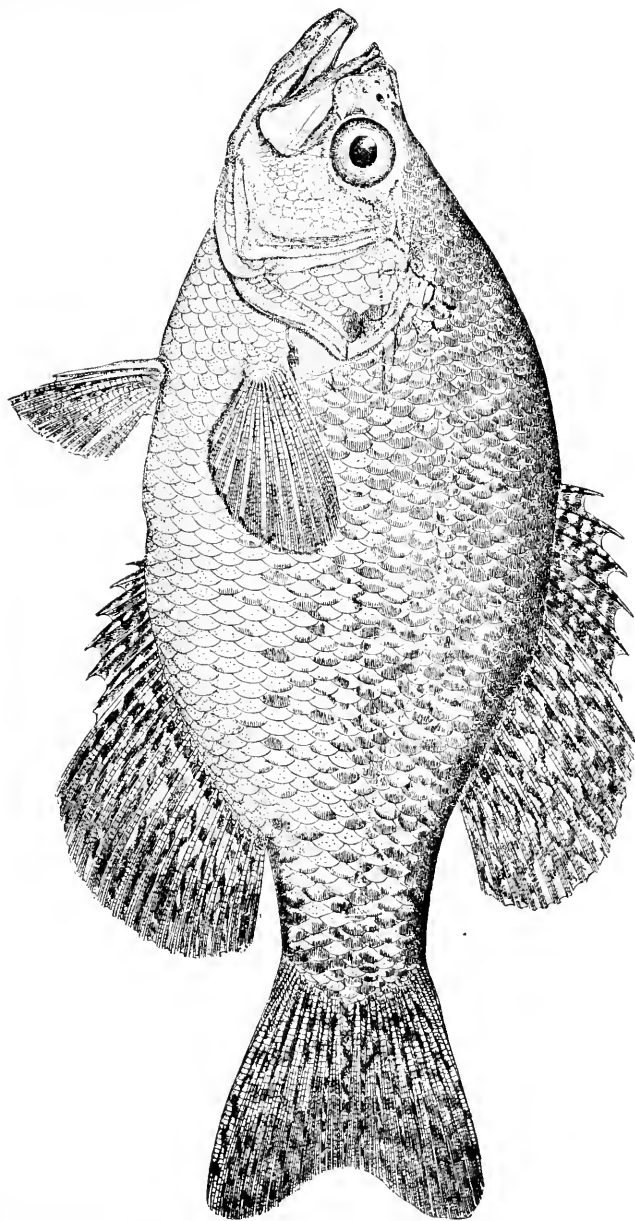

CRAPLE—*Pomoxys annularis*.

head; head 3 in length of body; greatest depth 2; dorsal XI to XIII, 12 or 13; anal VIII, 13 or 14, lateral line with 37 to 43 scales. Color silvery green, with about 20 horizontal dark stripes along the rows of scales: a black spot on last rays of dorsal: a blackish bar below eye. Length 4 to 6 inches.

An elegant little fish, very abundant in the lowland streams of the South, and coming as far north as Virginia and Southern Illinois. It is a good food-fish, but it rarely weighs half a pound. It especially abounds in the clear dark waters among the cypress-knees.

THE CRAPPIE—*Pomoxis annularis* (Rafinesque).

*Description.*—Body elongate, the depth usually about 2 1-2-in. length of body, the profile more or less strongly S-shaped, owing to the projecting snout, depressed occipital region and strongly prominent, thickened ante-dorsal area; head long, about 3-in. length; the mouth very wide, the mandible being about as long as the pectorals; eye large, about 4-in. head; fin-rays, dorsal VI, 15, the spines varying from V to VII; anal VI, 18, the spines frequently but 5 in number, the number of spines is subject to considerable variation, but the normal number both in dorsal and in anal is six; the proportions of the spines also vary somewhat; lateral line with about 42 scales (36 to 48); color, clear silvery olive, mottled with dark olive green, the green being chiefly on the upper part of the body and having a tendency to form narrow vertical bars; dorsal and caudal mottled with green; anal pale, scarcely marked at all; soft rays of dorsal and anal very high but still lower than in the Calico Bass. This species reaches the height of about a foot. The form varies much with age, large specimens having the body much deeper and more compressed than is the case with young fishes.

The Crappie is one of our best pan-fishes, greedy and voracious as a black Bass, but less active, and giving up the fight at once when the hook is in his jaws. It reaches usually a length of ten or twelve inches, and a pound weight, but there are records of Crappies weighing three pounds.

The home of the Crappie is in the Mississippi valley, especially from St. Louis southward, although it ranges northward to Minnesota. It thrives best in sluggish waters, and is not

averse to warm water or even mud. Young Crappies run by thousands into the muddy bayous, and when these ponds and sloughs dry up in the summer, multitudes of these little fishes, with the young of the Large-mouthed Black Bass and others, are left to die.

The Crappie is known by a variety of other names, at different localities within its range. In the Ohio River it is "Bachelor," and sometimes "New Light," or "Campbellite," its advent in certain rivers of Kentucky being reputed to be coincident with the preaching of Alexander Campbell. "Bride Perch" and "Chinquapin Perch" are meaningless names heard on the Mississippi River. Tin-mouth is another name with some shade of appropriateness, while about New Orleans is heard the inexplicable appellation of "Sac-a-lait," also freely applied to the larger Killi-fishes. Of these names Crappie is to be preferred, because it is most widely used, and because it belongs to no other fish.

The Crappie feeds on small fishes and crustaceans. It takes very kindly to life in ponds and with the Calico Bass and the Rock-Bass, it is one of the species best adapted for the stocking of ponds.

Professor Goode quotes from "St. Louis," in the American Angler, the following account of Crappie-fishing near St. Louis:

"Our 'Crappie,' the greatest pan-fish of the West, is highly esteemed by us for the table. We have seen a monster Crappie this spring, weighing over three pounds, taken at Murdock Club Lake, near St. Louis, on the Illinois side. We consider one of one-and-a-half to two pounds a large one. They are taken about logs and tree-tops, on the water's edge in our rivers and sloughs. They are greedy fellows, but as soon as hooked, step right into the boat without a struggle for liberty.

"A gentleman of this place, a member of one of our old French families, who turned the scale at about three-hundred

pounds, was noted for his success in Crappie-fishing. He would have his large flat towed to a tree; when, tied to a limb, he would settle himself for the day on a pillow placed in a large split-bottom chair. Hauling his live-box and minnow-pail alongside, he would bait two hooks attached to a strong line, using a weak snell, so that in case the hook should foul, he could break it loose. He used a float and short, stout bamboo rod, and, shaking the bushes a little, 'to stir up the fish,' would select an opening and carefully drop on the minnow, two feet below the surface, pass the end of the rods through rings in the side of the boat, light his pipe, and wait for something to happen. It was not long; and after the fun began, it was the same monotonous lifting out of fish, and dropping them into the live-box all the day long, and was continued on the next, until he had brought to creel over three hundred.

"I have always associated in my mind the Crappie, and the love of ease and quiet of our old French inhabitants. Nothing could more truly represent contentment and ease than the picture of this simple-minded old gentleman on his annual Crappie fish at King's Lake."

THE YELLOW PERCH—*Perca flavescens* (Mitchill).

*Description.*—Body oblong, compressed, mouth moderate, the maxillary not quite reaching to orbit; lower jaw a little the longest; eye moderate, 4 1-2 to 5-in. head; top of head naked, the bones rough behind; cheeks with rather large scales, well imbricated; opercle naked and with radiating striæ, of which the uppermost forms a long, flat spine, below which seven or eight striæ end in sharp teeth; preopercle strongly serrate, the lower serræ hooked forward, gill-rakers comparatively short, in length about equal to the diameter of the pupil; pseudobranchiæ very small; scales rather small, 55 to 62 in the lateral line; first dorsal spine inserted above base of pectorals; head 3 1-2 in. length, depth 3 3-4; fin-rays D. XIII 1, 13; A. II, 8. Color dark-olive above; sides more or less brassy-yellow; belly white; about six irregular, dark olive bars on sides; lower fins clear, orange, sometimes red; second dorsal and caudal yellowish olive, somewhat dusky tinged; first



YELLOW PERCH—*Perca Americana*.

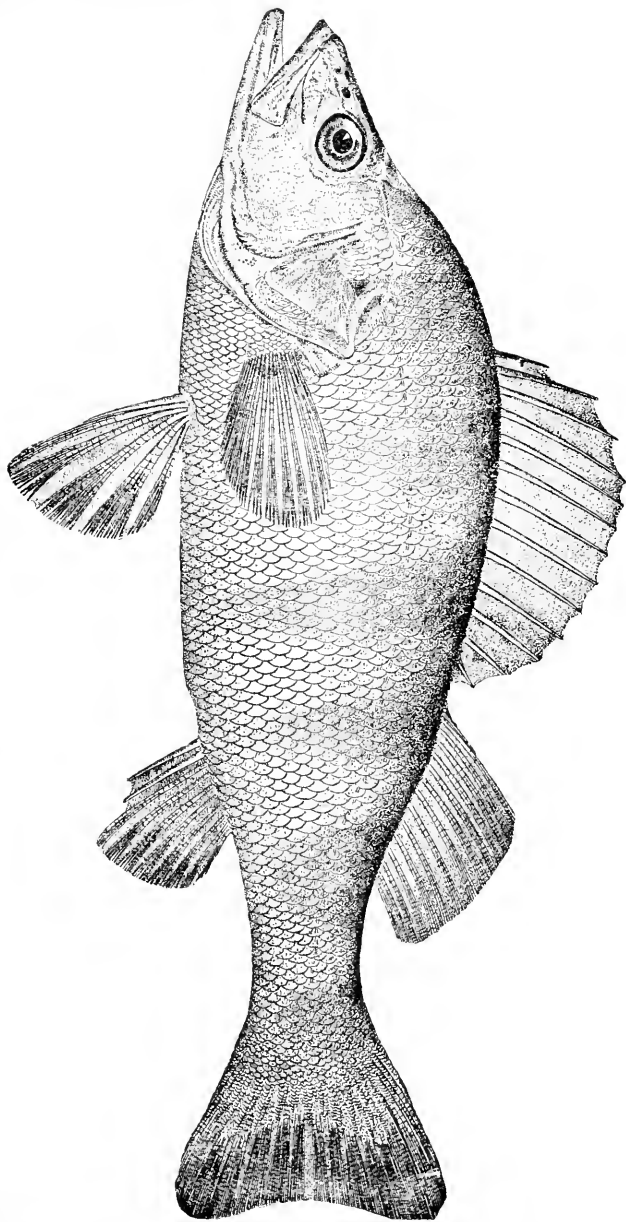

dusky yellow at base, a black blotch on posterior part of the fin; lower jaw, etc., translucent reddish. The coloration varies much with circumstances, individuals living in weedy streams being much darker and more spotted than the average lake specimens are. Length of adult 8 to 12 inches.

The yellow Perch is a fish which has been on good terms with the angler ever since the first angle-worm was wet in American waters. He is generally ready to bite, always ready to be hooked when he has bitten, and may always be counted in as a notable part of the day's result when he is in the basket.

The Yellow Perch is found throughout the Great Lake Region, and in some parts of the Upper Mississippi. Its range extends thence eastward, including all the rivers of New England except the very coldest. Thence it extends southward in the lowland streams as far as Georgia. Why Perch should be found in the rivers of the Carolinas, and not at all in the streams of Kentucky, Missouri and Southern Illinois, is one of the things which are hard to explain. Nor is this fact made any simpler when we remember that one other fish, and only one, the old-fashioned "Sunny," (*Lepomis fibbosus*) shares this peculiar range with him.

The American Perch is a handsome fish in color. His back is green, his belly, and across his sides are four or five broad black bands. There is a big black spot on the spinous dorsal fin, while the lower fins are bright orange or even cherry red. From the black stripes the fish has received the names of Ringed Perch and Raccoon Perch. The name Yellow Perch is more commonly heard, and this appropriate title was long ago put into Latin by Professor Mitchill to form his scientific name, *Perca flavescens*, the Yellow Perch.

*Perca fluviatilis*, the River Perch, is almost the duplicate of our species, and it is as common in the waters of Europe as is ours in the rivers of the Eastern States. The American species, *flavescens*, is the handsomer fish, however, with his coat of cloud and sunshine, while the duller olive and gray of the European fish suits the hazy sky of an English summer.

The Perch abounds in quiet, deep places in the river and in ponds and lakes. It feeds mainly upon minnows and worms, having a constant though not voracious appetite. It reaches a length of about eighteen inches and a weight of a pound or two. As a food fish it is respectable, though falling far short of the best.

I once spoke rather lightly of the Perch as food, and was taken sharply to task by a New York angler devoted to the Perch. I sent immediately to the market, bought some Perch and had them properly fried, but I found them even poorer and drier than I had thought. But these were market Perch, tired, and crushed beneath a mass of ice. The flavor is said to be best during the spawning season, after which, according to Dr. Goode, the flesh is soft and watery. Taken at its best, the Perch is a good pan-fish—and every fish has the right to be taken at its best.

The best bait for a Perch, so far as my experience goes—and I hasten to say that it does not go very far—is an angle-worm. This, with a stout hook, a float and a sinker, serves the essential purpose, and a rod of alder does as well as the finest bamboo. According to Dr. Goode, this form of tackle is effective when Perch are numerous and hungry, and thus I have generally found them.

Thoreau says of the Perch:

“The common Perch, *Perca flavescens*, which name describes well the gleaming, golden reflections of its scales, as it is drawn out of the water, its red gills standing out in vain in the thin element, is one of the handsomest of our fishes, and at such a moment as this reminds us of the fish in the picture which wished to be restored to its native element until it had grown larger.

“The Perch is a tough and heedless fish, biting from impulse, without nibbling, and from impulse refraining to bite, and sculling indifferently past. It is a true fish, such as the angler loves to put into his basket or hang on the top

of his willow twig, on shady afternoons, along the banks of the streams. So many unquestionable fish he counts, and so many shiners which he counts, and then throws away."

I have spent a good many hours in the company of the Perch, but my most successful day at Perch-fishing was in June of 1874, on the Little Suamico River, in North-eastern Wisconsin.

I had gone up there on a hunting and fishing trip and had taken with me a bright young student, a Scotch boy from a Wisconsin farm, afterward well-known to naturalists as Charles Leslie McKay, and who later was lost on the shores of Alaska, while in the service of the Smithsonian Institution.

Two years before, the fires had raged through the pine woods of Oconto County, burning the trees and carving great ponds in the dried muck. The dark trunks rose like skeletons of the living things they had been, but the bird-life was as full among them as ever, and all about us the white-throated sparrow whistled and the rose-breasted grosbeak kept up his querulous questionings. The yellow-breasted chat made the bare condition of the trees a subject for his best jokes, and we found one compensating advantage amid the dismal scenery in the fact that we could hear the birds so well. But we came this time for fish, not birds, and all I need say is, that Perch, near the mouth of the little river, were as plenty as the shiners, and of the shiners we caught more than we cared to count or keep, or even to throw away.

#### THE DARTERS—*Etheostoma*.

But more interesting than the real Perch was a little fish in blue and crimson which we found lying in the bottom of the river, insensible to any bait we were able to offer it. It was not more than two inches long, and as slender as a shingle nail. We rigged up an impromptu dip-net and succeeded in taking some of them. We had never seen them before, and that is not strange, for they were then new to

YELLOW BASS—*Accius microphthalmus*.

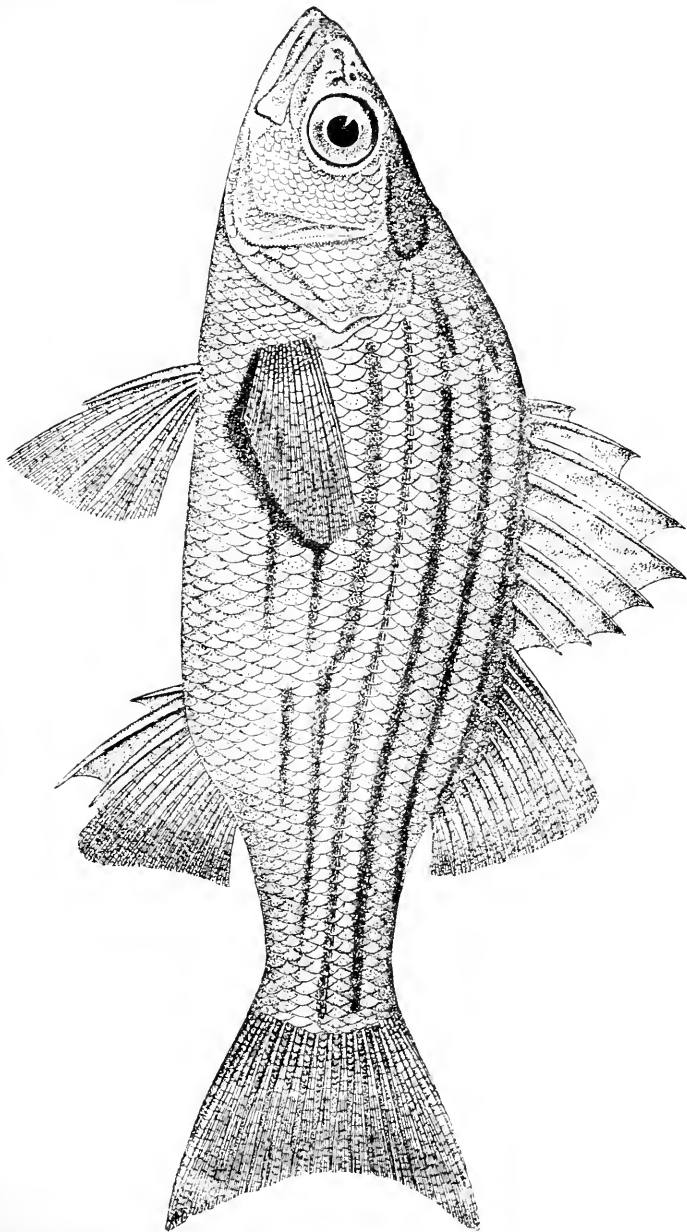

science. Later they received their name of *Etheostoma cos*, the Darter of the Sunrise.

When we found these little fishes, we cared no longer for the Perch, great, gaudy yellow fellows, fit only to be fried, while these were as beautiful as the dawn for which we named them, (*Etheostoma cos*) and as delicate as they were beautiful.

Still, these little "Darters" are the children of the Perch, if the tales of the evolutionist can be trusted, and the Perch is chiefly interesting to me on account of its singular progeny.

There are some seventy kinds of Darters, all dwarf or diminutive Perches, and swarming on the bottoms of every clear stream from Quebec around to Rio Grande and beyond. The largest of them is not more than eight inches long, and the smallest less than two, yet in spite of their littleness they are not so much dwarfed as concentrated fishes, each one as perfect in form as the Perch, and as delicate in color as though it had been separately hand-painted.

These diminutive creatures are Perch in all their essentials, and seem to have arisen in the first place from the adaptation of young Perch to smaller and smaller streams and scantier sources of food supply.

But the story of the Darter is a long story, much longer than the story of the Perch, and few anglers will listen to it, for though Rafinesque says "They are good to eat, fried," each one has about as much meat as a beech-nut, and one would as soon think of filling his pan with wood-warblers as his creel with the "Darter-perches."

#### THE YELLOW BASS—*Morone interrupta* (Gill).

*Description.*—Brassy, tinged with olivaceous above; sides with 7 distinct longitudinal black bands, those below the lateral line interrupted posteriorly, the posterior part alternating with the anterior; body oblong-ovate, with the dorsal outline much arched; head depressed, somewhat pointed, its profile concave; eyes large, their diameter equaling length of snout;

mouth somewhat oblique, maxillary nearly reaching middle of orbit; spines very robust, second anal spine 2-5 length of head; dorsal fins little connected; head 3-in. length; depth 2 2-3; D. IX-I, 12; A. III, 9; Lat. 1. 50. Length 10 to 15 inches.

Very similar to the White Bass is the Yellow Bass, which is found in the waters of the Lower Mississippi, rarely going farther north than St. Louis or Cincinnati. It frequents ponds and the deeper parts of the streams, seldom ascending brooks or passing shallows. The most northern locality from which specimens have been seen by me are Brookville, Ind., and Peoria, Illinois. The Yellow Bass is a fish of more pronounced qualities than the White Bass. Its mouth is larger, its spines are much stronger, its scales are larger and rougher, and its coloration more definite, brassy yellow with lengthwise stripes of black. From its general appearance it should be an excellent game-fish, and such no doubt it is. Dr. Goode remarks that it is called in Louisiana "Bar-fish," probably on account of its stripes. "The appellation," says Hallock, "is equally appropriate as applied to its habit of congregating in great numbers upon the shoals of clear-water branches and bayous which empty into the Mississippi. The minnows and shiners seem to seek the bars at night. In early morning the water is alive with Bar-fish and "Trout" (Black Bass), in pursuit of the minnows, until it fairly boils. This is the time of day to go fishing."

#### THE WHITE BASS—*Roccus chrysops* (Rafinesque).

*Description.*—Silvery, tinged with golden below; sides with blackish or dusky longitudinal lines, 4 or 5 above the lateral line, 1 through which the lateral line runs, and a variable number of more or less distinct ones below it, the latter sometimes "more or less interrupted or transposed so as to appear like ancient church music;" dorsal outline much curved, second anal spine 1-2 length of head; axis of body rather below the middle of its depth; head conical, slightly depressed at the nape; mouth small, nearly horizontal; maxillary reaching middle of pupil; head about 3 1-3 in. length; depth about 2 1-2; eye large, its diameter equal to the length of the snout;

D. IX-I, 14; A. III, 12; scales, 7-55-13. Length, 10 to 15 inches.

A gentle, quiet, handsome fish, common enough, yet never very abundant; fairly well known yet unobtrusive, never taking a prominent part in anything. Such is the White Bass. It is found throughout the region west of Lake Champlain, north of Tennessee and east of Dakota. A few White Bass may be found in any pile of Black Bass or Sunfish from the lakes, as they lie in the market stalls. Yet no one ever saw a catch of White Bass, and no one ever went fishing especially for them.

It is a food-fish of good flavor, similar to the Black Bass, and not inferior. It lives in deep or still waters, both in rivers or lakes, but it seldom ascends small streams, and dislikes waters which are muddy or weedy. It is said to do well in ponds. It may be caught in the same ways as the Black Bass, though it is certainly less voracious and less gamy.

THE CALICO BASS—*Pomoxis sparoides* (Lacepede).

*Description.*—Body oblong, elevated, greatly compressed, the depth being nearly half the length, the head one-third; profile more regular than in the Crappie, the projections and depressions being less marked; head much deeper and shorter than in the Crappie, the mouth considerably smaller, the mandible being considerably shorter than pectorals; snout projecting, forming an angle with the descending profile; fins very high; anal rather larger than dorsal, its height being from one-fourth to one-fifth of the length of the fish without caudal-fin; dorsal VII, 15, varying to VIII spines, very rarely VI; anal VI, 18, varying to V, 17; lateral line with 40 to 42 scales; color a bright silvery olive, mottled with clear olive green, the dark mottlings gathered in irregular small bunches, rather than in lines or bars, and covering the whole body and the soft rays of the anal as well as those of the caudal and dorsal fins; usually a dusky opercular spot. This species reaches a length of a little more than a foot.

Closely allied to the Crappie, but loving colder and clearer



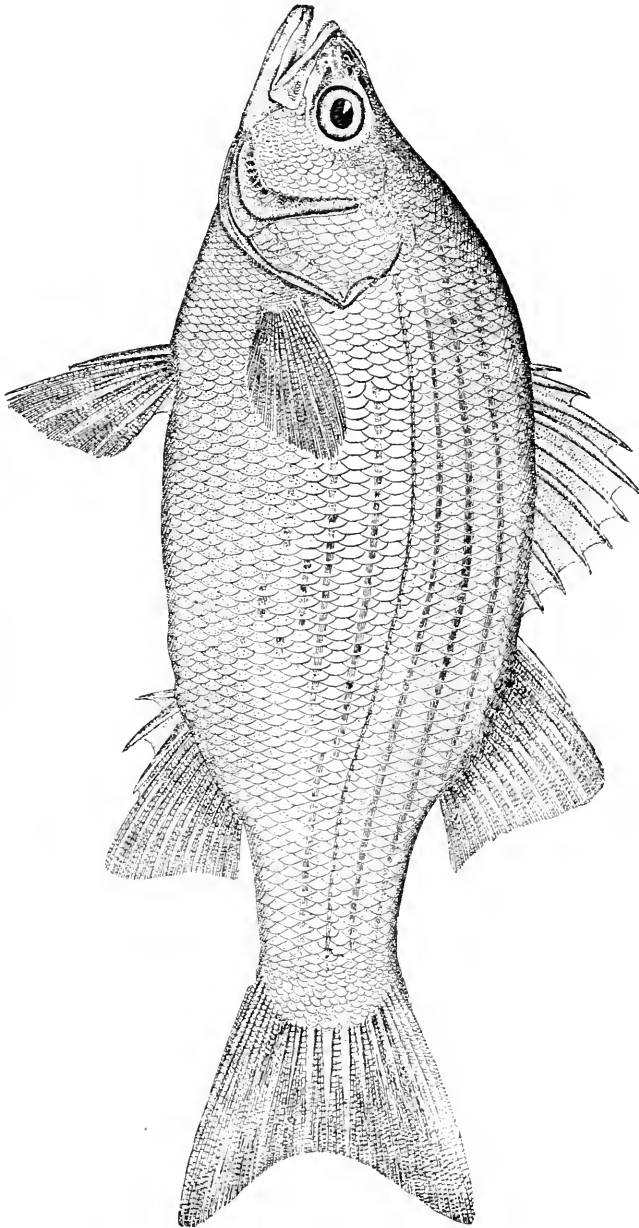

WHITE BASS—*Ammocetes chrysoptera*

waters, and therefore a finer, firmer, more deeply colored and more vigorous fish, is the Calico Bass.

The range of this species extends from South Carolina north-westward to Kentucky, Vermont, Iowa and the Great Lakes, being almost identical with that of the Rock Bass. Many fishermen fail to distinguish this from the Crappie, and Dr. Henshall has proposed to spread the same name over both, calling this the Northern Crappie. It has, however, good names of its own, and the observant angler will notice that while the true Crappie has but six spines in its dorsal fin, the Calico Bass has seven, and its anal fin is mottled and spotted like the dorsal, while in the Crappie this fin is almost plain. In Lake Michigan, where this fish is abundant and the Crappie is not found at all, the name of Bar-fish is in common use. In Ohio and Illinois, besides the appropriate name of Calico Bass, there are others of less pertinence. Strawberry Bass, Grass Bass, Bitter Head and Big Fin Bass are among the best of them, but it will be best to let them all die away through disuse.

The Calico Bass is an excellent game fish, rather superior to the Rock Bass, inasmuch as it is handsomer and usually grows larger, and shows a good deal of eagerness and spirit.

Of all our American Bass-like fishes, this will probably prove to be the one best adapted for artificial ponds, especially those with weedy or mucky bottom and clear water.

The case for the Calico Bass is thus strongly put by Dr. Jared P. Kirtland, as quoted by Dr. Goode:

“The Grass Bass has not hitherto been deemed worthy of consideration by fish culturists; yet from a long and intimate acquaintance with its merits, I hesitate not to pronounce it the fish for the million. It is a native of our western rivers and lakes, where it usually resorts to deep and sluggish waters; yet in several instances, where it has found its way into cold and rapid streams, and even small-sized brooks, by means of the constructing of canals or by the hand of man,

CALICO BASS, OR STRAWBERRY BASS—*Pomoxys stravidis*.

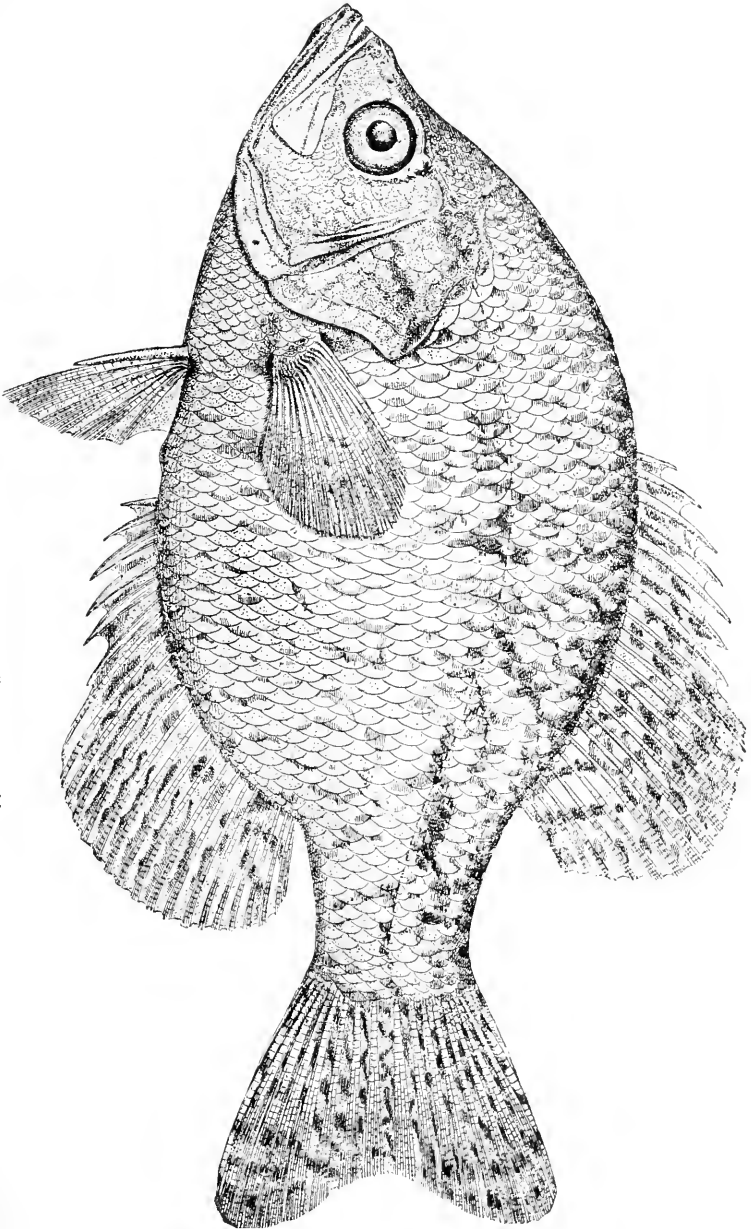

it has adapted itself to the change, and in two or three years stocked to overflowing these new locations. As a pan-fish, for the table, it is surpassed by few other fresh-water species. For endurance and rapidity of increase it is unequaled. \* \* The Grass Bass is perfectly adapted to stocking ponds. It will thrive without care in very small ponds of sufficient depth. \* \* It will in nowise interfere with the cultivation of any number of species, large or small, in the same waters. It will live harmoniously with all others, and while its structure and disposition restrain it from attacking any other but very small fry, its formidable armature of spinous rays in the dorsal and abdominal fins will guard it against the attacks of even the voracious pike."

## THE SENSES OF FISHES.

BY WILLIAM C. HARRIS.

THE subject of the mental and emotional capacity of fishes is the cause of much curious comment and speculation among angling naturalists, who do not willingly consent that the class *Pisces* shall be placed upon a plane of intelligence below that of the insects. The belief that fishes possess qualities which reach a standard beyond the instinct of self-preservation has recently gained in strength and interest, owing to the increased facilities that fish-culture has given us for observing their habits. Seth Green, the Nestor of fish-culture in America, believed that fish talked to one another; and the idea is by no means an extravagant one.

It is conceded by naturalists that certain insects and many of the lower animals have the power of imparting mutual intelligence by processes unknown to us. The little ants hobnobbing with each other, the cooing dove wooing its mate vocally, the hen clucking her brood under protecting wings, are familiar instances of vocal intercourse among insects and birds; and no one who has watched the minnows of a shallow pool, or those in an aquarium, has failed to see equally sure indications that fishes have a way of their own in communicating with each other. They dart up to one another, put noses together for a moment, and then dart off with an air as much as to say, "All right."

"Old Eschylus, in one of his poems, calls fish 'the voice-

less daughters of the unpolluted one;’ but many of the ancients and moderns testify to the utterances of fish. Pliny, Ovid, and others tell us of the *Scarus* and its wonderful powers of intonation. In the days of old Rome certain fish were said to have a regular language, ‘low, sweet and fascinating,’ and the Emperor Augustus pretended to understand their very words. We have all heard, or heard of, the various sounds of the Gurnards, of the booming of the Drum-fish, the grunt of the Croaker, Weak-fish and others. The Grunt-fish of the Gulf of Mexico is said to express discontent and pain, and when touched with a knife fairly shrieks, and when dying makes moans and sobs disagreeably human. Take it all in all, we cannot but believe that fish have the power of making intelligent communication to one another, mouth to mouth, and we have frequently noted, or thought we did, a kind of knowing look about their eyes which led us to credit them with looking unutterable things.”

The scientists tell us that in many fishes no trace exists of an organ of hearing; that the tympanum, its cavity, and the external parts of the ear, are entirely absent; that in others this organ is only imperfectly developed, and that in the remaining few, such as the shark, the shad, herring, and others, there is an odd connection between the organ of hearing and the air-bladder. With these crude facts before him, the ichthyologist leaves the angler to work out the answer to the question, “Can fish hear?” which is a most practical one to the careful angler, in his pursuit of the educated game fish of our inland waters. We sum up briefly the conclusions of an old Black-Bass angler on this subject:

Fish hear no sound originating in the air.

Place a cannon upon an India-rubber carriage, sufficiently large and elastic enough to deaden, when fired, all concussion upon the ground, and Mr. Fish, after the explosion, will be as placid in his pool as a *gourmand* after dinner.

But, step as lightly as one may upon the margin of a

stream, and the fish will scatter like shot, from the shallows where they are feeding or frolicking. The larger the fish and the lesser the depth of water, the greater and wilder the scattering will be.

Security seems to lie with them in the relative depth of the pools, as the step of the angler only disturbs them in a foot or two of the water. A fish lying in a hole three or four feet deep, close to the banks, is undisturbed by any ordinary concussion.

Again, any concussion originating in or upon the bed of the river or below the fish, does not appear to disturb them. This was verified by this old angler one day upon a large Bass which he saw lying motionless within a foot of the stake to which the camp boat was tied. The water was about four feet deep. He struck several successive hard blows upon the top of the stake, which protruded about two feet out of the water, without causing a flirt of the fin in the fish below.

Our angler at once concluded that the Bass could not hear the noise made by footsteps upon the bed of the river when wading in the stream and, as the jolly fins could not hear the conversation originating out of the water, anglers may indulge in social chat and pleasantries whenever inclined, taking care, however, to be always on the safe side, by not becoming too boisterous in their discussions or hilarity.

"Boys," said a fly-fisher on one occasion, "what fools these bait-fishers are to put their comfort in a straight-jacket when they go a-fishing. Some old fellows won't let you whisper in the boat, and are as querulous and over-cautious as my grandfather was whenever he had an attack of the gout. He would lie flat on his back in bed, with his gouty foot propped up on a pillow laid across a chair, placed bottom upward, and in this position would center and strain his eyes and fears upon the knob of the chamber door, which was no sooner turned upon its axle than he was heard crying out with prospective pain, 'Watch out for my foot!'"

"It is just so with these old bait-fishers. A motion of your lip, although voiceless, and they would cry out (if they dared), 'Watch out for my coming bite!' They are right in thinking that the least motion of the boat is apt to frighten the fish, but 'I won't go home till morning,' by a dozen bass voices is less disturbing to a pool or a bank than the twitching of a toe on the bottom of a boat."

Anglers generally agree on the subject of the sense of sight in fishes. A fish can see in water but not out of it.

The shadow of a split-bamboo rod thrown across a pool will create in a fish the same skittishness as would be caused by an elephant browsing upon the bank.

A passing cloud over a shallow and pellucid pool protects the angler and puts another fin or two in his creel, where a moment before each cast of his drove the fish to deeper pools or behind protecting rocks.

An old angling friend once said to me that fish were like ostriches in some of their ways, notably in that they seemed to feel safe when their noses were hid behind a tuft of grass or in the crevices of a sunken rock.

"Fish facing the sun, and forget not this rule, even when the twilight is over the waters, by casting toward the west," was the law enacted by his knowledge, based upon experience, of the effect of shadows upon the wary fins, who are more startled by unusual appearances on the surface of a pool than they are by strange things below.

Vision and hearing, in fishes, being the senses most important to the angler, in his water sports, those next in value are smell and taste. The possession of these by fish seems to be a disputed point. They have evidently taste in a modified degree, as they will reject the artificial lure if the barb of the hook is not immediately imbedded in their flesh, but on the other hand, they will take a leather or rubber imitation of the natural bait with as much gusto as a live minnow or bug—hence the question is a see-saw one.



Of course, among angling naturalists, the gift of the senses is, or at least they think it should be, confined to game-fish, as they cannot imagine any dispensation of providence that places the ignoble Catfish or the snaky Eel upon the same plane with the Salmon, Trout and Bass.

Fish, no doubt, in common with other animals, have the instinct of danger developed almost to the quality of reason; and it is no bar to the truth of this to argue that, because a fish will take the bait with a half dozen broken hooks in its mouth, it follows a brutish appetite that is blind to danger; for, look you, be ye an angler or a butcher, that stomach of yours is death to you every day of your life; that smoking dish, be it a red herring or canvas-back duck, is causing you to make rapid strides grave-ward, and you know it; and yet you gorge yourself every day upon your favorite dish.

It ill becomes a man to argue that, because an animal cannot control its appetite, it has not the lordly gift of reason. To sum up:

Can a fish taste? Certainly—he spits out his artificial bait.

Can a fish smell? Aye, there's the rub; yet why the anointed lures so prized by old anglers and many modern ones?

This fact, however, is sure: fish are susceptible to anger and jealousy; for we have seen them fight, and we all know how tiger-like in combat Salmon and Trout are, on their spawning beds.



## FISHING TACKLE AND HOW TO MAKE IT.

---

BY JOHN HARRINGTON KEENE.

Author of "Fly-Fishing and Fly-Making," etc.

---

### INTRODUCTORY.

THE desirability of self-help is more conspicuous in regard to angling than any other sport. Very few fishermen are quite unable to help themselves, it is true; but imagine the plight of the would-be angler by the side of some splendid trout pool, wherein he ever and anon catches sight of incarnadined and gleaming fish-forms, without the least idea of tying a hook, or making a fly, and with only some twine and loose hooks in his possession! Or suppose him to be scores of miles from the nearest town, with broken rod, reel full of sand, leaders used up, and flies of the wrong sort—all of which may happen, together or separately—and observe what a benefit the few envelopes of feathers and silk, or the hank of gut, screw-driver and oil-can, and loose hooks, with the knob of wax, are to the sportsman who knows how to fix his own tackle. That man who has taken the trouble—and to the true angler it should be a pleasure—to learn to make his own tackle, is alone worthy the name of "Senior angler," and to him assuredly come the highest guerdons of the

craft. He is never "cornered;" and the gratification of taking fish is enhanced a thousand-fold by the thought that it was done by means of one's own handicraft throughout. To make one's own rod, tie one's own leaders, dress one's own flies, search out oneself the haunts of the stream's Apollo, the trout, catch him oneself, and share him around the camp-fire with one's friend, is, me seems, the very pinnacle of piscatorial accomplishment. Thus did the past masters of the gentle craft, from the earliest days to those of Uncle Thaddeus Norris, of fragrant and well-loved memory.

Not that the desirability of professional tackle-making is less, but that the principle of resourceful adaptation should be more, in the angler. Flies, and the various appurtenances of the fisherman, can be much better and more truly made in the work-shop than in the wind-swept woods. There are those who cannot afford the time to attend to the practical refurnishing of the tackle-basket. Life is too short already for such, and certainly too brief for the minutiae of fly-making. They pursue wealth, and get it. They can afford to fill the fly-book, etc., with the best that can be bought. There is nothing to say against this. But such people are in danger of becoming mere "dudes," in the art-piscatorial, and they are apt to evoke a smile of genuine pity from the practical fisherman, as he realizes how much is lost in true enjoyment by this growing tendency of wealth to have everything done for it by others.

George Dawson has well said: "It is not all of fishing to fish." So far as I am personally concerned, the æsthetic pleasures of fishing far outbalance the mere gratification of the grosser man—of the hunting instinct. To sit down and imitate some fairy-winged insect and have the seal of approbation placed on it by the leaping fish, is a mental treat to tickle the palate of the intellectual epicure. To make yourself a graceful greenheart or rent cane rod, light and pliant

as an Ariel's wand, during the boisterous days of winter, and by its means, through many years, to gently force thousands of fish to your creel, is to create a friend and servant around which will cluster associations of jeweled luster. Nay, will not such a weapon, in the sportsman's sanctum, often and often, as he glances through the smoke of his evening pipe, bring tears to his eyes, recalling from shadow-land "the touch of a vanished hand and the sound of a voice that is still?" Odds and ends of tackle are strewn around me on the table even as I write. Some are suggestive of friends scattered over this broad fair land—others of good anglers and true across the ocean; and dearest of all are those mementos of him to whom I owe all of the enthusiasm, and skill, as a practical fisherman, I possess. He it was who taught me to tie a hook at five years of age, and catch a three-pound trout soon after; and who has now passed to where, "beyond these voices there is peace"—my father. Such associations are inexpressibly welcome to the angler, but they are practically unknown to the *dilettante* fisherman. Of a verity, "It is not all of fishing to fish."

In the following paper I purpose giving (1) my deliberate selection as to the most suitable tackle for angling of all kinds, (2) and explanations of its materials and methods of amateur manufacture. Of course my *opinion* is but that of an individual, and doubtless good anglers and true will differ from me; but it will be an honest one, and in matters of fact I shall state what I *know*. Not one assertion will be found that depends on the experience of someone else. Thirty-years in the midst of fishing and tackle, in two hemispheres, should have taught me enough to set me up in experience of my own. At any rate I am willing to stand by what appears in this chapter, and to the end that it may be of the utmost utility to the tyro, it has been boiled down to an intense concentration and terse practicality.

The first thing the amateur fisherman had better learn to do is to tie the various knots indispensable in joining tackle. This is a lesson necessary at the very outset of his apprenticeship.

#### SECTION I—KNOTS AND TIES.

The properly tied leader, hook and line, bear the same relation to "good form" in the angler, as the trim, well-finished harness of a "two-forty" trotting horse does to the good form of its owner. Imagine a symmetrical brilliant-coated pacer tied to the sulky by means of hideous knots and make-shift splices instead of smart buckles and carefully adjusted straps—neat and strong in their arrangement! Or fancy a man of reputed taste in dress promenading the streets in fine broad-cloth sewed together with twine, and pinned or tied instead of buttoned! Precisely analogous is the condition of the outfit of that angler whose good gut leaders are joined with knots that are unsightly and insecure, and whose hooks and lines are strung together according to his unskilled fancy.

The remedy is simple, and one which every follower of the "gentle craft" should be aware of. Efficient knots and ties are as easily and swiftly made as insecure and unsightly ones. A little careful attention to the following directions, and practice with a piece of common cord for one half-hour, will forever dissipate the angler's ignorance on this subject, and give him the ability to have strongly made tackle, of the appearance of which he need never be ashamed.

To plunge *in medias res* of the subject, it is certain that one of the very first lessons the angler has to learn is how to tie a loop. This process seems easy enough; and so it is, if the only material to be tied is a silk or cotton line. Almost any loop will do, in such case. But assuming that gut is required to be looped, its nature requires a knot of different

character to that which will serve for ordinary purpose. Gut will slip, under some circumstances, and it will become brittle under all.

How then ought we to proceed?

I have experimented with all kinds of loops and ties, during the past twenty years, under all possible conditions, both in Europe and this country, and the best and most reliable knots I declare to be as follows:

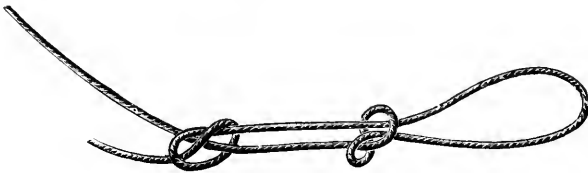

Fig. 1.

First, the loop for gut or any other material: Fig. 1 shows my favorite. It is recommended by the English Alpine Club—a club of mountain climbers whose very existence occasionally depends on the reliability of a knotted cord. It will be seen to consist of two single ties—one in the free end of the line, and the other in the line itself.

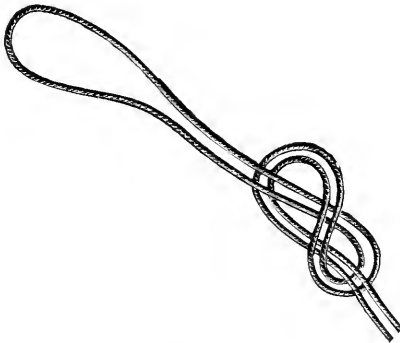

Fig. 2.

When the two are drawn taut they form a perfectly secure and very neat tie, which has the merit of having each part of it under evenly distributed strain. In all knotting, this latter quality is the great desideratum.

Another loop is seen in fig. 2, and it also is a very secure one. It is easily made. The loop being formed, it is passed in a figure-8 form and drawn tight. Of course, it need scarcely be added that gut or hair should be well soaked

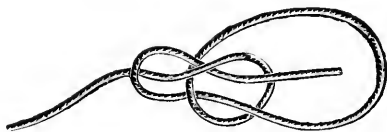

Fig. 3.

before tying. Fig. 3 shows the famous bowline knot, and it needs no special recommendation from me. It is secure, and easily loosened; but on this latter account it is not, I think, to be unqualifiedly recommended for gut leaders.

The three loops above are all-sufficient for snells or leaders. Before leaving this part of the subject, however, I must draw attention to the best method of joining the reel-

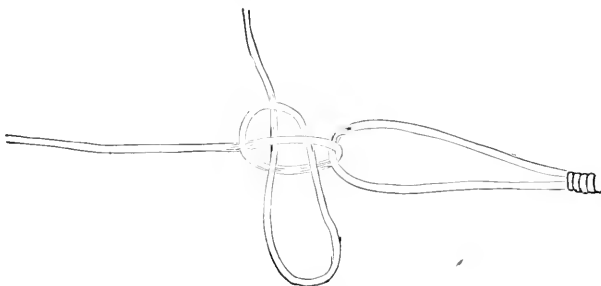

Fig. 4.

line to a gut or gimp snell or leader. Fig. 4 indicates it. The tighter this is drawn the more secure it is, and yet it can be instantly undone by pulling on the free end—a consideration sometimes of great value, when time is of importance.

Junction knots serving to connect the parts of tackle—for example, leaders—need to be especially secure, and as far as possible, free from sharp and sudden angles and bearings. Usually—with the ordinarily tied leader—the breaking strain causes it to part at the knot. This need not be so, if figs.



5 and 6 are used. Fig. 5, drawn tight, is reliable, and readily made. Fig. 6 is based on the same principles with the addition of an interlacing of horse-hair or gut, as shown. This latter acts as a buffer, like the buffer-springs of a steam-car,



Fig. 5.

and does not add to the size of the knot materially. When all is drawn tight, the actual bearing is on the intervening "buffer", and of course the risk of breakage is thus reduced to



Fig. 6.

a minimum. If a loop be desired in the leader, it can easily be woven in between the knots, and is absolutely secure.

One other knot may be given as reliable and convenient. Fig 7 shows it. I give it place here as an alternative

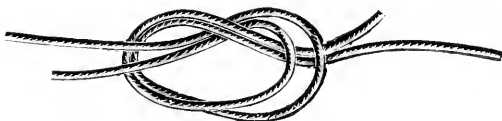

Fig. 7.

only, and do not recommend it in place of the "buffer," (fig. 6). It is the one commonly used, but is liable to snap when dry, as I have proved to my cost.

The above knots are sufficient for any and all purposes, and I need not add to this part of the subject of tackle-preparation by additional descriptions.

#### SECTION 2—LINES: GUT, HAIR, SILK, GIMP, ETC.

The next consideration obviously is the materials in connection with which the knots given are used. The first of these, and perhaps the most important, is gut. This mate-

rial is a transparent thread, of one fiber, apparently (though really many are massed together), and derives its name from the fact that it is taken from the viscera of the silk-worm (*bombyx mori*). Its length varies from twenty-three inches (and even longer) to six inches; and its gauge or thickness is from that of a thick carpet-needle to that of a fine human hair. This latter is not often produced naturally, but is got by a process termed "drawing"—through fine holes in steel plates—in a way similar to the drawing of wire. Attempts have been made, in this country, to obtain longer and thicker as well as strong gut from the native silk-worm (*attacus cecropia*), but they have failed—the gut being very brittle, though of good appearance, and in some instances, three yards in the length of a single strand.

The process of gut-production, as practiced by the peasants of Murcia (Spain), from which cholera-tainted town almost all the gut in use is imported, is described by Mr. S. Allcock, the largest gut-factor in the world, as follows:

"Worms are bred by the country people in their cottages or houses, which usually consist of two rooms on one floor. The roofs of the houses being nearly flat, no fire-place in the houses, the cooking is done outside in the yard. The windows are simply iron cross-bars without glass in the sleeping room. They tie together bamboó cane reeds (which grow plentifully there) with string, forming a bed from twelve to fifteen feet long by four feet wide, raised from the floor about four feet high. The worms are spread all over these beds formed of cane, and are fed five times daily by covering them with mulberry leaves. Before feeding, all the dead and sickly worms are picked out, so that the others are kept in a healthy state. The worm lives about fifty days, during which time they sleep three days at a time, in all twelve days. When they are ready to spin into the cocoon they creep upon branches of small trees cut out of the gardens, which are placed over the worms. They are taken off,

put into vinegar, where they remain for six hours, then put into water. Some of the country people make a special business of this, and purchase the worms from others, and employ girls to draw out the gut, which is done by taking off the head and taking hold of the entrails by the thumb and finger and pulling them out as long as they will come, then placing the gut in clear water again. When a sufficient quantity of two or three thousand are made, it is tied in bunches, and hung up to dry in the yard or garden. Some worms produce one gut, some two, and a few three guts. It is afterward sold by the pound-weight of rolls to the gut-makers. The gut-makers boil the gut with soap and a little soda, when the outer skin or film comes off easily. It is then washed, bleached and hung up in rooms. Then girls are employed who place each gut between their teeth, holding the other end with their fingers, and rub it with wash leather. It is then sorted—the strength, lengths, and quality—re-rubbed and tied in bundles of 100, then in 1,000 each, for sale.”

This graphic description was written by Mr. Allcock on the spot, and I need not remind my readers that he had unrivaled opportunities of knowing, having a factory there, and preparing, as he does, all the gut he imports so vastly.

Good gut is of course expensive, but it is by far the cheapest, in the end. The characteristics of good gut are as follows: Length—the longer the better (*cæteris paribus*)—thickness (for Salmon gut), and strength. The best Salmon gut I ever saw was over twenty inches long, very thick, and sustained a dead weight of twelve pounds. This, however, was worth more than its weight in gold.

Good gut, when bent, should not form a permanent right-angle, showing what medical science terms a “green stick fracture.” It should be round also. This is easily determined by taking it between the finger and thumb of each hand and twisting it in contrary directions. Of course if the fiber is flat it will look like a long miniature screw,

because of the angular twist. Gut that is old, or has been exposed to the sunlight, becomes brittle, and will break like a carrot. Refuse this always.

To keep good gut in a fine state of preservation—and really good gut is worth keeping—the following is a capital formula: take chromic acid, one part; water, five parts; dissolve the chromic acid. Of this solution take one ounce, and mix with five parts glycerine. Steep the gut ten days; at the end of that time submerge the gut and keep it entirely in one part carbolic acid and five parts glycerine. This is unequaled as a preparation of gut for tying, and as a preservative afterward.

Of course when one is not preparing to tie leaders for Salmon, such elaborate precautions are not necessary. For Bass and Trout (brook and the Von Behr species) the ordinary thicknesses in use are suitable. Before tying this together it should be soaked in water of about 80 degrees Fah. for an hour or two. Each knot should be drawn tight with a pair of tweezers; and the leader, for the sake of appearance chiefly, may be stretched on a long board by means of brass pins, till dry. The length of leaders varies from one yard to three—the latter is the general length for Trout-fishing. Besides the two end-loops, two others should be tied in the junctions for the admission of the snells of two dropper-flies. The proper distance of the first from the terminal loop should not be less than twenty inches, and the second should be two feet from the first.

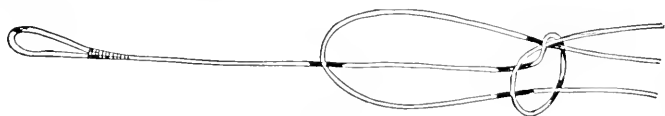

Fig. 8.

In the tying of snells it is frequently advisable to reinforce that part nearest the hook, because the teeth of the fish frequently fray it disastrously. I have found nothing superior to the device shown in fig. 8. Of course the knotting there

shown is drawn snug and tight, and the result is *three* strands nearest the fish's teeth. If two be preferred, a long loop is simply tied and cut through at its apex, leaving the two strands to be joined to the hook.

Horse-hair is seldom used for leaders nowadays, for the reason that it is not strong enough. It is exceedingly rare to find hair capable of lifting more than two pounds. If fine gut be scarce, however, the resourceful angler will not disdain a few hairs from the "gray palfrey's tail." The hair of a stallion is preferable to that of a mare or gelding.

Silk, in its manufactured state of course, forms the staple of reel-lines. These are commonly braided by a machine, sufficiently indicated in fig. 9. The various grades and

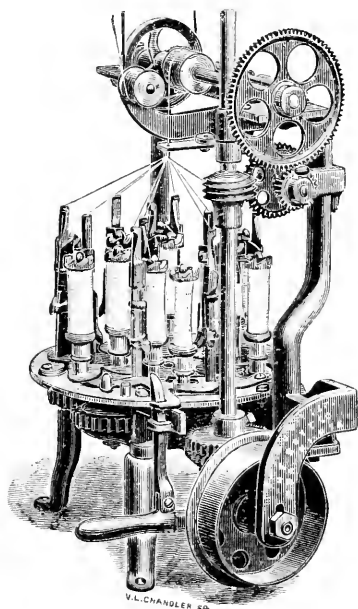

Fig. 9.

gauges most suitable for each fish will be given when the tackle for them is considered, and therefore it would be a work of supererogation to recite them here. The dressings

of the lines most in use, also, will be given under the appropriate heading. Gimp is extremely useful on which to mount gangs, spoons, etc., for the more voracious fish, such as Pickerel, Pike, Mascalonge, etc. The difficulty in procuring good gimp is rather considerable, if it be bought from the ordinary retailers. There is much adulteration going on, and the core of the gimp, which should be pure silk, is too often nothing but a mixture of silk and cotton. The best plan I know of is to buy banjo strings; these are splendidly strong, and though more expensive, are incomparably more satisfactory than the ordinary silvered gimp. If the silver brightness is too ostensible, it may be turned to a dark neutral color by the use of the following solution: bichloride platinum, one part; water, ten parts—or sulphide of potassium, one part; water, ten parts, will do as well.

A splendid substitute for fine gimp is a banjo string with core of fine steel wire covered with silvered wire. It makes the best kind of trace for Pickerel or Mascalonge.

### SECTION 3—WAXES, VARNISHES, LINE-DRESSINGS AND STAINS.

In order to clear the ground as I go, it is now proper to speak of the waxes that are necessary to the fly-tier and general maker of tackle. The old-time wax was that used by shoemakers; and for stickiness and generally reliable endurance it is, without question, as good as any. But it sometimes becomes necessary to show the color of the tying silk, and especially does this natural color show to advantage on flies of delicate colors, and on light-hued rods. This being so, a colorless wax was the desideratum, and the following are recipes I have used with satisfaction. I give them in their order of excellence, according to my experience:

1. One pound clean white resin; melt it over a slow fire. Four oz. diachylon; add to the resin and stir till thoroughly incorporated, then add two ozs. Bergundy pitch. Pour out into a vessel of cold water and pull till cold. The more it is

pulled the whiter it gets. The wax is suitable especially for Salmon fly tying, where grease is likely to be detrimental to the fine shades of silk employed.

2. Two ozs. best yellow resin; one drachm white beeswax sliced; dissolve, then add two and one-half drachms fresh lard. Pour out into water and pull till cold.

3. Yellow resin, twenty-three drachms; beeswax, thirteen drachms; suet (without skin) two and one-half drachms; melt together and pour into water, pulling till cold as before.

Either of the above recipes may be rendered tougher and more sticky by the addition of say five per cent. of gutta-percha—the sheet gutta-percha is the best.

With these formularies the tyro is well supplied. It will perhaps be necessary to keep all of these in moderately warm quarters, that they do not become brittle, but in summer they should be stored, either in clean water or in a cellar where the temperature is not liable to great change.

The most useful all-round varnish is that made from bleached shellac. It can be manufactured by the amateur without difficulty, from alcohol and pulverized bleached shellac; but it is better to buy it from some good varnish-maker, because there is the certainty of its having been matured, in that case, before it is offered for sale. This shellac varnish requires to have been made quite a long time, before it is at its best for use on flies, hooks, and whipping generally. When using it, it should occasionally be thinned with a little 95-per-cent. alcohol. It ought to penetrate—not simply lie on the outside of the whipping.

Here is a “wrinkle” worth knowing, in connection with all alcohol varnishes: Alcohol has a strong affinity for water, and extracts it from the atmosphere whenever the cork is out of the varnish-bottle. Of course the amount it attracts is infinitesimal, but “many mickles make a muckle,” as the Scotch say, and the least amount of water in the varnish tends to render it less resisting to moisture. To cure this I

place a few slips of gelatine in the varnish. This gelatine in turn attracts the water from the varnish, and the proof of this is the swollen and damp appearance of these strips when one reaches them, as the varnish is used up.

This varnish is the one I use for all work where silk is employed for whipping, binding, etc., and as it dries rapidly and is transparent and hard, it is very satisfactory.

Another good orange-colored varnish is that made from the unbleached shellac. Take alcohol, three ounces; shellac, one and one-half ozs.; gum benzoin, one-half oz.; mix, cork, and stand in a warm place till dissolved.

The best coach-varnish is unapproachable for rods. It should of course be applied by means of a camel's-hair brush, in a room where no dust is flying about.

Another good varnish is the following quick-drying one: Cut the whitest pieces of copal with oil of rosemary, and add alcohol in small quantities, shaking well. All of the above hints are the result of actual experience, and can be relied on.

The dressings for lines are numerous, and the differences of opinion in regard to them are legion. My own experiments have led me to discard the so-called enameled line. It is true the enamel looks very pretty, but it encases the line as in a tube, and in the casting of the line from the reel the sharp angles described by the line and the top of the rod breaks this tube, letting in the water. This moisture soaks far into the line, beneath parts which are intact, and hence, from this spreading on either side of the broken enamel, the line may become rotten without showing a particle of wear on the surface. The result is, a lost fish, at some time when you most required that fish—and of course the lost fish is the biggest you ever caught! That is always the case.

Boiled linseed oil is, without qualification, the best dressing I know of. It takes a long time to dry, but it is a true preservative.



The following are good dressings also, and I have used them all with success at different times. (The secret of keeping lines in good shape is to put little dependence on dressings, and more on drying the line, each time after using. Never omit this attention. Those reels on the market that profess to obviate the necessity for this, are a delusion and a snare. A perforated reel-plate is a good thing to aid in drying off the line, but the latter should always be unwound on a chair before the fire or stove, and thoroughly dried.)

1. Boiled oil and best coach-varnish, equal parts; mix at blood heat, and immerse line twelve hours.

2. Boiled oil and gold size, equal parts.

3. Boiled oil, one pint; beeswax, one-fourth pound. Put the oil in an earthenware jar and stand this in a pan of water, kept boiling. Add the wax in small shavings. Immerse line when the dressing is still hot.

4. Half a pint boiled oil; three-fourths oz. beeswax; one and one-half ozs. Burgundy pitch; one tablespoonful copal varnish. Raise the heat of this mixture a little above the heat necessary to make a complete solution. Allow the line to remain in it at least twelve hours, keeping in a warm place all the time.

5. One-fourth oz. beeswax; one-half pint boiled oil; one-fourth pint gold size. Immerse line a few hours, keeping the dressing hot; stretch and dry.

6. Paraffine wax, 1 pound; yellow resin, one-fourth pound. Melt and immerse line. Rub off superfluous wax with a damp cloth. The line requires to be drawn from the hot mixture through a hole in the lid of the receptacle, because it cools so fast. A beautiful surface can be obtained by using this dressing, but it is not a very lasting one. Of course the dressing can be renewed at will and therefore it is an entirely valuable one to take in the woods, when camping.

All the above dressings are applied by soaking, and, with the exception of No. 6, all are then taken out and stretched

where dust and rain cannot get to them. The superfluous dressing is then carefully rubbed off, by aid of a piece of chamois leather held between the finger and thumb. A part of an old kid glove will do admirably, if the chamois is not convenient.

Quite a large number of feathers, etc., require the aid of the dyes, and I may as well at once give a few recipes for staining wool, feathers, gut, etc.

First, as to gut: The analine dyes are not suitable, unless very largely diluted, because they are, in the majority of cases, corrosive, and destructive of the silk fiber of the gut.

Mist-color: This is produced as follows: Take a piece of copperas about the size of a coffee-bean, and dissolve it in a cup of boiling water. Now take a teaspoonful of logwood chips and infuse them in a half-pint of water (boiling). When the temperature of the infusion has lowered to about 100 degrees, immerse the gut and let it remain till it seems to have well taken the dark wine-color of the infused logwood. Then turn in the solution of copperas. The result will be, the "mist"-color—so carefully guarded as a secret by more than one tackle-maker. The shade must of course be a matter of experiment, as in all dyeing.

For feathers the Diamond Dyes, to be gotten at any drug-store, are both convenient and effectual. The feathers need thoroughly washing and rinsing, and to be dyed whilst wet. The directions that are given for *silk*, on the packets, may be applied to feathers in every particular.

Hackles should be tied on sticks, and when dyed the sticks should be whirled between the palms of the hands till the feathers are dry. They then assume their original shape.

Black is a difficult color to dye, and yet it is often indispensable. I have got a good black by soaking the hackles in acetate of iron (warm solution) and then boiling in an infusion of madder and logwood.

Dun hackles are also very difficult to get natural. White

feathers are boiled in a mordant of alum and water, and then in an infusion of fustic, sumac, and a small portion of copperas.

Some writers prefer alum as a mordant in all cases, and I am not sure it is not the very best one can employ. The proportions should be one oz. alum to one quart boiling water and the feathers should remain in this solution quite a long time—say twelve hours, if delay is of no consequence. The very killing colors of the smaller flies are often exceedingly difficult to arrive at, and the following recipes from Halford's fine work on the "Floating flies" used on the chalk streams of England, may be found useful. I have tried them and they are very satisfactory.

**Green Olive:** Tea-cup ebony chips in a quart of water, to which is added a piece of chrome potash about the size of a small pea. Boil down to a pint; fill up and boil down to a pint again. Pour off, and add three drops of muriate of tin, then immerse the feathers and dry as usual.

**Medium Olive:** Boil for two or three hours two good handfuls of the outside brown leaves of onions in distilled or fresh-caught rain-water, to which is added sufficient good vinegar to make it perceptibly acid. The addition of a piece of copperas will darken the dye.

**Brown Olive:** Add to the above a small quantity of black tea and a small piece of copperas—the more of the latter that is used the browner will be the solution.

There are several varieties of the "May flies," "Canada soldiers," etc., all comprised under the order Neuroptera—genus Ephemera—and all have wings shaded more or less with a greenish tinge. The best stain I know of to imitate the natural tint is as follows:

**Natural Tint:** One quart soft water; one-half tea-cup ebony chips; chrome potash, size of pea. After dyeing the feathers in this bath, rinse thoroughly and immerse momentarily in very light-green Diamond-dye solution, to which a little

slate has been added. Of course one must be watchful not to allow the latter bath (or indeed the former) to become too deep in color.

Slate Color: Handful logwood chips; quart boiling water; copperas, size of a small nut. I find it best to soak the feathers well in the infusion of logwood first, and then add the copperas, stirring till it dissolves.

Practically the above answers all the requirements of the amateur tackle-maker, and though there are more tints required by the professional Salmon and Trout fly maker, they are all more or less matters of experiment on the emergency. The tyro will naturally achieve these as he goes on, and the foregoing is ample foundation for him to work upon.

#### SECTION 4—HOOKS.

The selection of the best hook for "all-round" fishing is more difficult than at first appears. Experience alone teaches the make to be depended on in the majority of cases. And

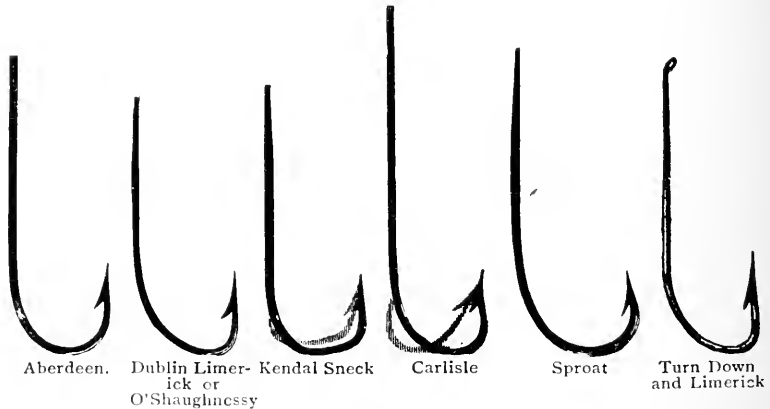

Fig. 10.

the experiences of anglers differ just as widely as do their scenes of operation. One man swears by the O'Shaughnessy, and his neighbor by the Sproat; both are justified by their experience. It is only after gathering the consensus of opinions and reinforcing this by studious experiment that

one is entitled to speak authoritatively. I have done this carefully, and here declare that, at the time of writing, the "Dublin-Limerick", or "O'Shaughnessy", at present is the best all-round hook, followed closely by the "Sproat" bend of hook.

In order to make plain this matter of shapes to the uninitiated, I give, in fig. 10, the different kinds chiefly used in fresh water, as manufactured by Allcock, of Redditch—the largest tackle-maker, in the world.

The process of manufacture has been so often described that I do not think it is necessary to here again repeat it. Those who are curious on the subject will find it described at length in my book, "Fishing-Tackle—Its Materials and Manufacture" (Ward, Lock & Co., 33 Bond-st. New York).

Of all the shapes of hooks, as I have said, the Dublin-Limerick is the nearest to perfection; and personally, I prefer this hook, eyed with the bashful turn-down eye, as shown. The eye obviates the tying on of a snell, of course, and it has this supreme advantage: when the gut is at all worn or frayed, it is not necessary to discard the hook. All you have to do is to cut off the gut and re-tie. This advantage is patent to everybody.

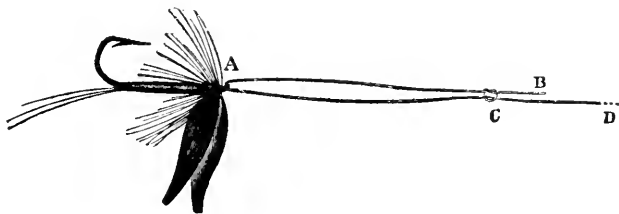

Fig. 11.

This section would be incomplete if I did not here pause and tell how to tie and re-tie the knots referred to. There are four really good ways of tying, but on the whole I prefer fig. 12. It is the one I always use myself, and has never drawn or failed me in any way. I do not say the others

are not good, but my experience declares for this one.

Fig. 11 is thus tied: Take the fly by the bend, in the position shown, with the eye turned upward. Pass two or three inches of the end of the leader (B), previously well moistened, through the eye (A) toward the point of the hook; and then, letting go of the fly, double back the gut and make a single slip-knot (C) round the center line (D). Next draw the slip-knot tight enough only to admit of its passing freely *over* the hook-eye (A), then run it down to and over the said eye, when, on gradually pulling the central link (D) tight, the jam knot is automatically formed. Cut off the end of gut, and you have a knot which will not draw, or allow the hook to hang *hinged*, loosely, as it were.

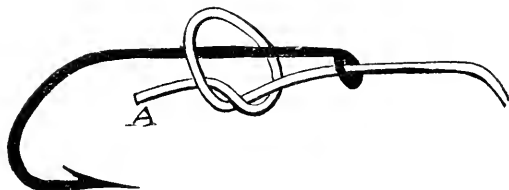

Fig. 12.

Fig. 12 is far less intricate, and explains itself. Take care to pull the end (A) as tight as you can get it. Then draw it down to the eye, giving a good pull to fix it.



Fig. 13.

Fig. 13 is thus described: First stage, pass the end of the line (A) through the hook-eye (B), and run the hook a few inches up the line, out of the way; then make a running noose (C) with the slip-knot (D), and draw the said knot as tight as possible. Second stage: Run down the hook again to the position shown in first stage, and passing the

noose (C) over it, pull the line (E) quite tight, cutting off the spare end. This completes the knot, and it appears as shown in *third stage*.

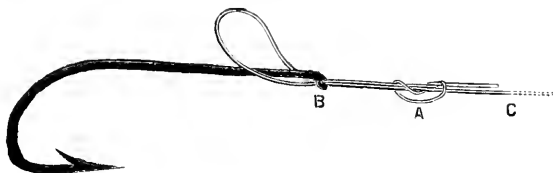

Fig. 14.

In fig. 14 we have an exceedingly useful knot where additional strength appears necessary—if indeed further security *can be* added to the foregoing. Salmon fishermen prefer this knot, if only because it looks surer—and it is possible, on second thoughts, that it is so in reality, because of the greater ratio in the size of the hook.

It is thus tied: Take the hook by the bend, between the finger and thumb of the left hand, and with the eye turned downward, in the position shown in the diagram; then—the gut of course having been well softened—push the end a couple of inches or so *down* through the eye (B) toward the point of the hook, then pass it round over the shank of the hook, and again from the opposite side downward through the eye, in a direction away from the hook-point (the gut-end and the central link will now be lying parallel); make the double slip-knot (A) round the central line or link (C), and pull the said knot perfectly tight; then draw the loop of gut together with the knot (A) backward (toward the tail of the fly), until the knot presses tightly into and against the metal eye of the hook (B), where hold it firmly with the forefinger and thumb of the left hand, whilst with the right hand, the central link is drawn tight, thus taking in the slack of the knot. Cut off the end and the knot is finished.

To tie a double slip-knot: make a single slip (see a, fig. 15) and before drawing it close, pass the gut-end (B) a sec-

ond time round central link c, and then again through the loop (a), then the knot will be like (A) in fig. 14. To finish, pull the end of the gut (C) gradually, and at last very tightly



Fig. 15.

—*straight away* in a line that is with the central link (C).

#### SECTION 5—FLY-FISHING.

Tackle for angling may be conveniently divided into three categories: 1. Tackle for top-water fishing—fly-fishing with artificial insect.

2. Tackle for mid-water fishing—trolling, bait-fishing, live-baiting, etc.

3. Tackle for bottom-fishing—fishing for Bull-heads, Eels, Suckers, etc.

The distinctions between the tackles used for these different styles are not arbitrary, of course. They are merely adopted for convenience, and to aid the tyro in referring.

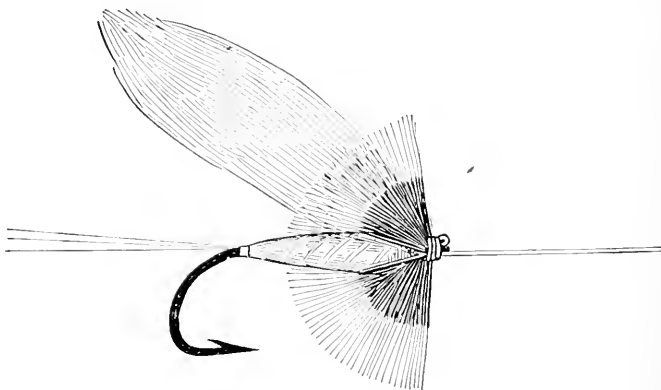

Fig. 16.

(1) TACKLE FOR TOP-WATER FISHING.—(A)—THE FLY.—Fly-fishing with the artificial fly is par excellence the chief of all sports—and the chief item of the necessary outfit is, without question, the artificial fly.



I take it for granted that all of my readers are familiar with the appearance of an artificial fly, as made after the conventional pattern. However, to bring the ensemble more vividly before their notice, fig. 16 is interpolated. That it is not at all like a fly, in detail, is nothing to my present purpose. It is what Dudley Warner terms a "conventionalized creation," not an imitation; and it undoubtedly does catch fish!

There is probably no more fascinating work than the making of these dainty fur-and-feather lures; and I shall not waste time in further preface, but, assuming that the reader desires to learn how to "dress" a fly, I beg him to at once begin with me the construction of his first "brown hackle"—which I choose as being the simplest form of so-called artificial fly.

TO MAKE THE "PENNEL" BROWN HACKLE.—Take a hackle (proportioned to the size of the hook) and having bound the hook on with waxed silk, lay it on the end of the shank, as

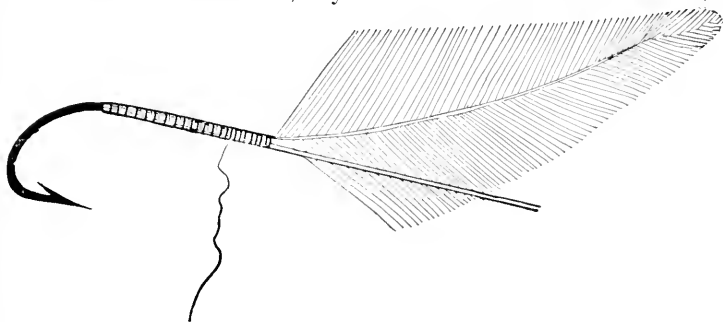

Fig. 17.

shown at fig. 17, with the under concave side upward. Tie it securely. Then take the tip between the forefinger and thumb of the right hand, and take several turns around the hook-shank (see fig 18); tie as shown. Let the turns be sufficient in number to allow of as much remaining hackle as is shown in fig 18. This hackle is then bound tightly side by side of the shank, and a double hitch secures it at a point about opposite the barb. The projecting remainder of the hackle forms a tail.

This is the simplest fly made, and it can be manufactured from almost any small feather in fifty seconds—a boon to the angler in the woods who prefers the fly to the bait.

TO MAKE THE ORDINARY BROWN HACKLE.—Here I must

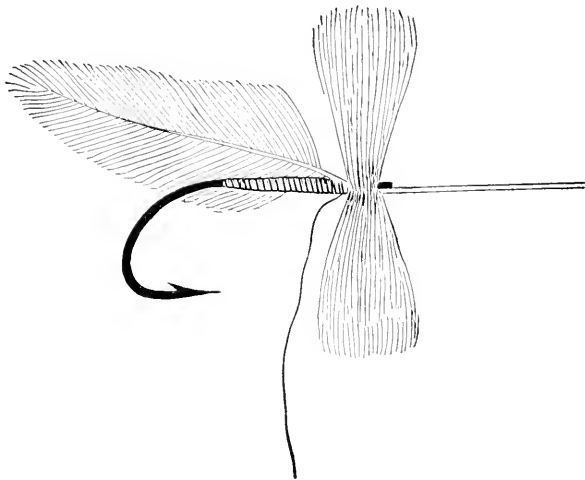

Fig. 18.

diverge a little, and explain a very important labor-saving method of preparing the hackle for all kinds of flies (and necessarily of course for the “brown hackle”).

It is easy to see, if one takes the hackle fresh from the rooster’s neck, that it is almost impossible to roll it evenly round the shank of a hook, unless it is done as recommended

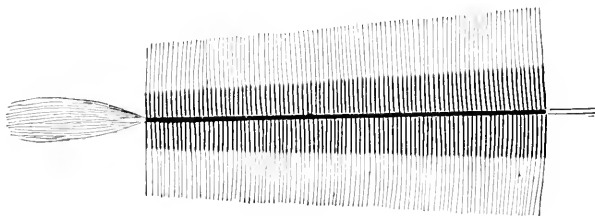

Fig. 19.

for the “Pennell” hackle, and this method is far from neat, or satisfactory in any way, when applied to the finer-winged

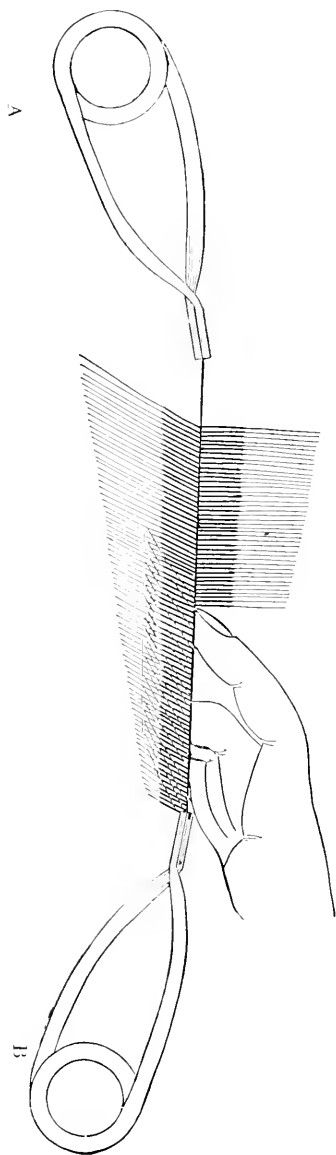

Fig. 20.

flies. The fibers are apt to get criss-crossed, and entangled, one with the other, and the result is, a mass of fibers as ineffectual as unsightly. To obviate this, the hackle is taken, and after stripping off the fluffy feathers from the butt-end,

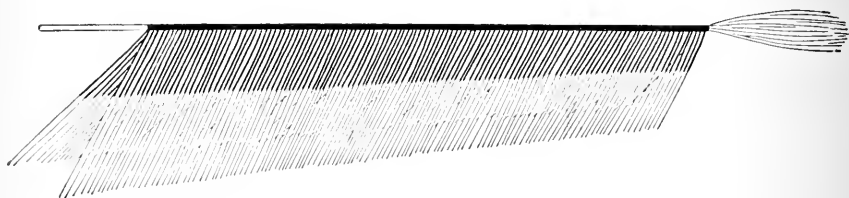

Fig. 21.

the fibers are stroked carefully in the reverse direction until they resemble fig. 19.

The next process is to attach a pair of pincers to each end as in fig. 20. Now let an assistant take A firmly whilst the

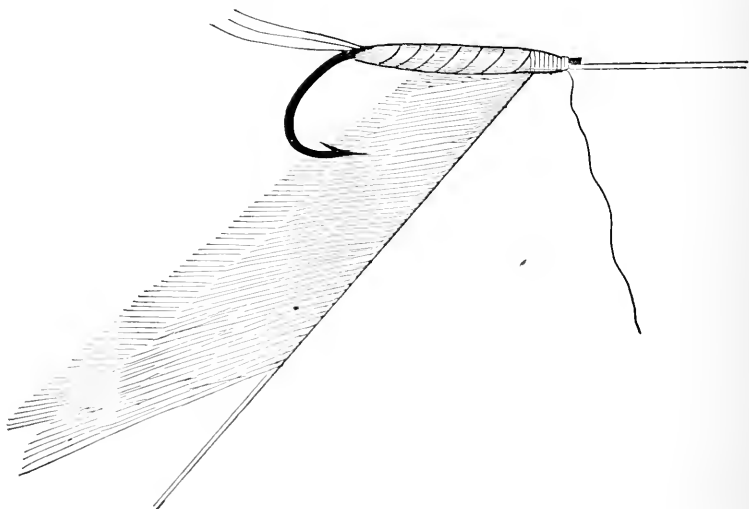

Fig. 22.

tyro grasps B in his left hand. Passes are now made on each side of the mid-rib, as shown, with the forefinger of the right hand, bringing the nail close to the roots of the fibers. This proceeding doubles them back and downward

until they assume the position shown in fig. 21. This "turning of the hackle" is one of the trade "kinks" which is here fully explained in a printed volume for the first time.

But to resume the making of the "Brown Hackle." The hook is duly attached to the snell, and the body of the fly formed for which see figs. 18, 19, p. 468, and the hackle turned ready for attachment. Fig. 22 shows where this attachment is made. The tip with the fibers turned back is placed as indicated and securely fastened—the tying silk coming up toward the end of the shank being retained between the gut and the shank as shown in fig. 22. Then the hackle is wound in a spiral whose coils are close side by side, and finally tied at the end of the shank by means of two half-hitches. The

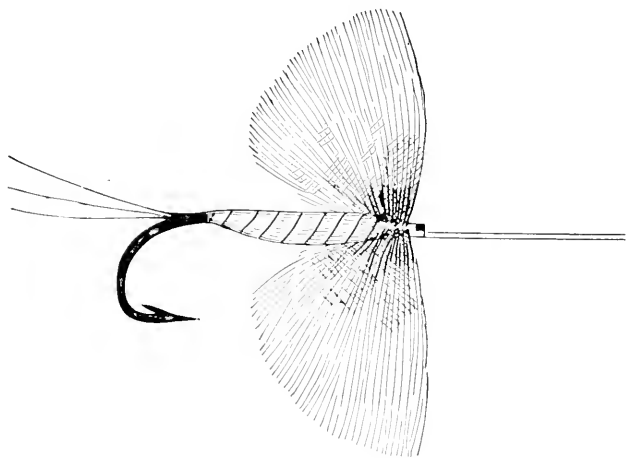

Fig. 23.

final result is shown at fig. 23, and is a very killing lure, wherever it is presented, to any and all fish that take the fly. Of course the size of hook varies from the smallest 14 or 16 for Pennsylvania Trout to the number 1-0 and 2-0 for the Black Bass of Michigan waters.

When the tyro has made a few dozens of these two hackles he will be prepared to learn how to make a fly like fig. 16.

This is the way: Fig. 24 represents the hook tied on and secured by means of a half-hitch (A). The tying silk is then run up by wide coils toward the end of the shank. Next, two slips of feather taken from two feathers from the right and

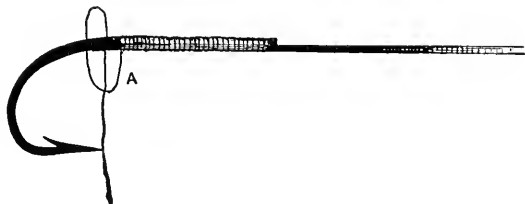

Fig. 24.

left wings of a bird are laid on each other so that they are of one size perfectly. They are then taken between the left forefinger and thumb and arranged by side of the hook as

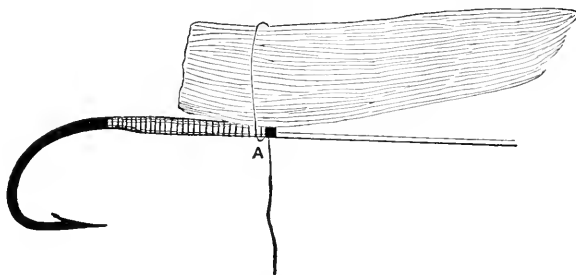

Fig. 25.

shown in fig. 25. Whilst in this position the silk is passed round them (they are still lying flat) and as the finger and thumb grasps them somewhat tightly the thread is drawn tight and the ends are whipped down the shank as shown at fig. 26.

The next operation is to form the body. Suppose, for example, it is to be yellow silk ribbed with silver tinsel and brown hackle tail—the silver tinsel A is tied in first, then the floss silk (cable silk is good) B, and next the three fibers of cock's hackle at C, fig. 26. Then the silk is rolled up taperingly, and fastened off by the whipping silk; then the silver

tinsel is wound in wide coils for the ribbing, and finished off duly.

Now the fly lacks the hackle. This is attached in precisely the same way as in the case of the brown hackle (see fig. 27)

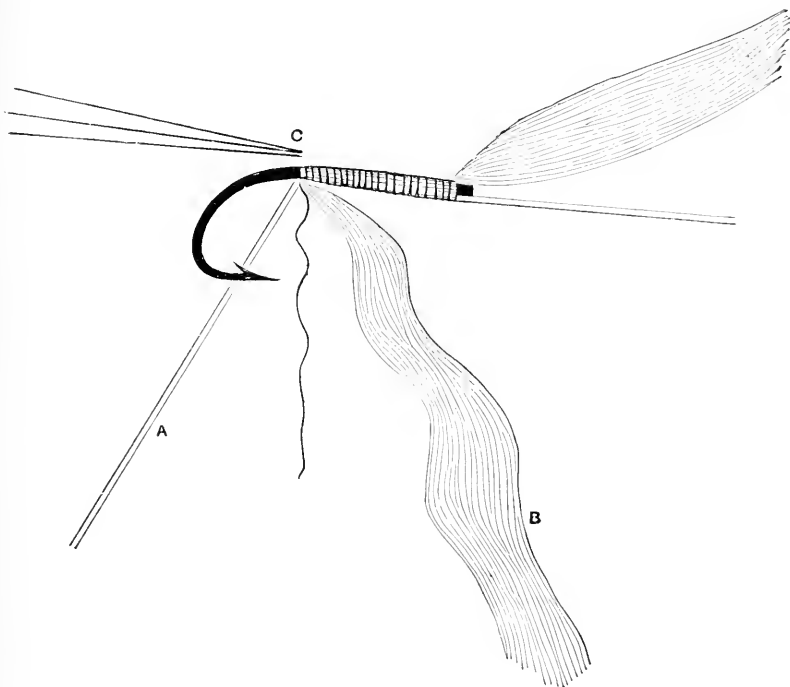

Fig. 26.

and finished off. Then the wing is turned or reversed and tied down. The end of whipping silk is clipped off, the head is touched with varnish, and your fly is done, and resembles fig. 16.

The foregoing terse directions form the foundation of fly-making. The angler who can make his flies from them has conquered the chief difficulties. All other flies are comparatively easy—in proportion to the amount of time expended in practice on these primary specimens.

A description of the flies represented on the colored plates may here fitly be introduced, and the more so because the majority of them are departures from the usual patterns.

PLATE I A.— POOR MAN'S FLY.—Body, worsted or seal's fur; hackle, white; wings, gray turkey wing-feather.

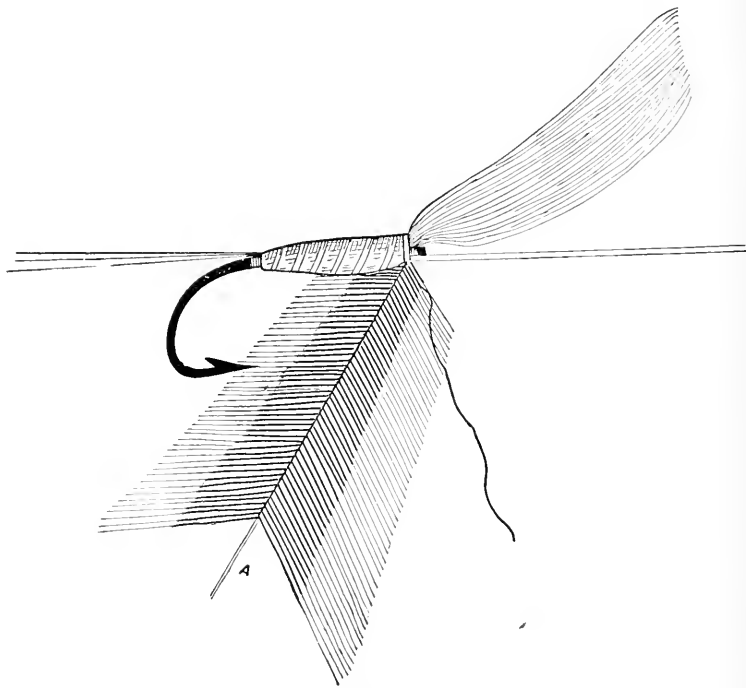

Fig. 27.

B.—BROWN SQUIRREL HACKLE.—The body of this capital Bass and Trout fly is composed of a strip of brown or red squirrel fur; the hackle is a reddish-brown one from the game rooster; tail-fibers from ibis wing-feather.

C.—BLACK JUNE(quill body).—This is a new dressing of a favorite fly for Bass. The ordinary "Black June" is endowed with a peacock herl body, and this being frail, soon gets cut by the sharp teeth of the fish.

To obviate the danger of this, I make it of a strip of quill



torn from the mid-rib of a crow's feather. (If I am making Trout sizes I get this from the red-winged blackbird.) The wings are double and water-proofed crow feather.

This water-proofing process for Bass and the larger Trout I conceive to be a great improvement. The feather is naturally held together by means of the clinging, hooked processes, to be found on the two sides of each fiber. These, however, are very feeble, as compared with the strength and ferocity of the fish, and ordinarily the first fish tears the wings into a straggling, shapeless mass. The semblance of a wing is hopelessly gone. Moreover, the feather gets water-logged and "soggy" and generally demoralized, so that the fastidious fisherman feels like putting on a fresh fly—especially if the quarry are not rising very freely.

My method of getting over this difficulty—to a very satisfactory degree, at all events—is to water-proof the feather precisely in the same way that water-proof sheeting is made. A water-proof preparation impregnates two surfaces of feather, and these are placed one on the other, and submitted to pressure. This forms one wing. The same process is of course necessary for the other, and thus four slips of feathers are used instead of two only, and they are rendered not less pliable, but tougher, and not likely to separate into fibers of independent directions at the touch of the fish. Moreover, the water cannot wet them through, any more than it can a rubber coat.

D.—**MOUSE-FLY.**—Trout and bass will take mice, if the fish be large and the mice small. Some makers produce a pretty close imitation of the quadruped himself; but in the fly before the reader its color only can be said to be counterfeited. The body of this fly is of muskrat-fur, the end of body tipped red silk and tinsel. The wings are from the gray goose, or brant, and should be lead-colored dun in hue.

E.—**WHITE MOTH, FOR TROUT.**—Body quill stripped from

white dove's quill-feathers; ribbed yellow silk under quill; wings, white dove; hackle, white leghorn rooster.

F.—FITZ-MAURICE.—Body, black chenille, and red silk ribbed gold tinsel; tail, peacock fibers; hackle, yellow; wing, mallard breast-feather.

G.—REUBEN WOOD.—Tag, red silk; tail, fibers brown mallard; body, white chenille; hackle, brown; wing, mallard breast-feather.

H.—STRAW FLOATER (*Ephemeridæ*).—This fly is an imitation of the May flies (*Ephemeridæ*) and the body can vary in color according to the fly to be imitated. It is made of rye-straw, dyed and softened by soaking in warm water. A suitable length is then cut and placed round a hog's bristle to which has been attached the whisks to form the tail. It is then secured in place by the tying silk being wound spirally in loose coils around it and finally attached to the hook which has already been tied to the gut. The wings are commonly two small separate feathers of the mallard breast, and may be stained or not according to the necessities of the case. These flies float on the water and are very killing, being such close imitations of the natural insect.

I.—QUILL-BODIED GRAY DUN.—The quill-body is from the feather of the moor or water hen, and is possessed of a lighter and darker strip each side so that when wound on it successfully imitates the ringed markings of the actual insect. The wings are the dun under-feather of the mallard or wild-duck's wing, and the hackle is a blue dun from a rare breed of chickens I managed to secure one day when I was in luck.

K.—PARMACHEENE BELLE.—This handsome fly is my first example of the compound wing. With care the red ibis and white goose feather can be "married" together and turned as one feather. The hackle is white first and then red; body, yellow seal's fur ribbed with broad silver tinsel; and ending with a tag of peacock tail, two slips of feathers—ibis and white goose or swan.

L.—ABBEY.—This well-known fly is thus dressed: wing,



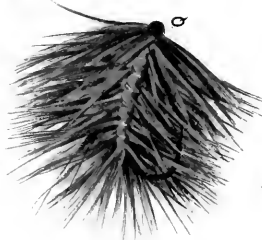
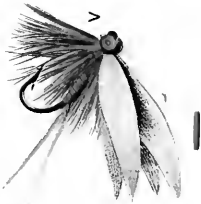
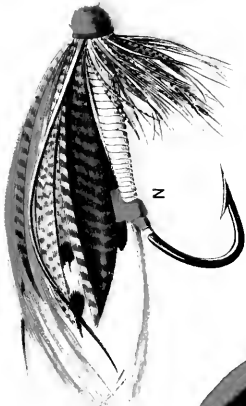

teal-breast; body, cardinal silk; tag, peacock herl; tail, fibers from golden pheasant tippet; hackle, brown.

M.—ALEXANDRA.—This fly is formed as follows, and is an instance of a bunch of separate fibers forming the wings. Wing of peacock feathers; tail of peacock fibers; body, white silk ribbed silver tinsel; tag, red silk; hackle, white. This is the invention of an English Trout-breeder and sportsman, the late Col. Gerald Goodlake. He used it with great success in taking the large American Brook Trout he bred for his fishery. By the way, these fish grew to six and seven pounds weight, and then disappeared—probably down-stream to the ocean.

PLATE 2.—N.—SILVER DOCTOR—SALMON FLY.—This fly

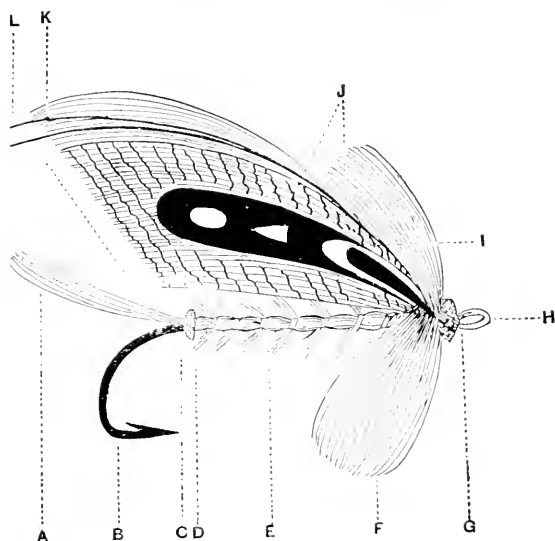

Fig. 28

is a superb creation, and as productive of sport as it is handsome to look at. (Before describing it, however, it is necessary to make the reader acquainted with the technical names of the different parts of a fly. As these are more numerous in the Salmon-fly, I give in fig. 28, the diagram of

a representative one—the “Greenwich fancy,” which will serve the double purpose of enlightening the tyro as to the parts of both *Trout* and *Salmon* fly—so far at least as the technology of both is concerned. In the Trout-fly there are necessarily less parts, but the names of those that are present are the same as on the Salmon-fly. The “Greenwich fancy” (fig 28) is thus described: A, tail; B, iron or hook; C, tag; D, butt; E, body; F, throat-hackle (also extending down the body); G, head; H, loop or gut snell; I, cheeks; J, outer wing; K (topping of golden pheasant), over-wing; L, feelers or horns; M, wing).

‘Silver Doctor,’ is thus described: *Tag*, silver tinsel and yellow silk. Tail, golden pheasant topping (feather from the crest or top of the head of the bird); butt, dark scarlet wool; body, silver tinsel, flat-ribbed in a wide coil with silver wire; throat-hackle, of guinea-fowl feather and white hackle dyed blue; wings, connected strands of golden pheasant-hackle (or tippet, as it is termed); wood-duck, pintail duck, golden-pheasant tail, swan (a goose), dyed light yellow and light blue; strips, of mallard and bustard, and the over-wing a topping (golden pheasant crest); horns, blue macaw (fibers from the quill-feather); head, dark-scarlet wool.

O.—DARK DUN (*Ephemeridæ*).—This fly is made of a new material, with the exception of the legs, which are of horse-hair, of which the interior of the body is also formed. This material is the membrane found on the under surface of the large silvery scales of the Tarpon (Silver King, — specific name, *megalops thrissoides*), found in southern waters. It is the toughest membrane in nature, and has several peculiarly valuable properties. First, it is capable of being procured so thin as to be finer than the insect’s wing itself. It takes a dye readily, and, when both out and in the water, stands erect, as shown in the illustration. When dry it is rather stiff and

quill-like, but unlike quill it softens right down when wet, becoming more pliant than feather, and yet retaining—in fact increasing—its toughness. Both the body and wing of this fly are of this material; the legs are of hair, and I need scarcely say it is almost indestructible. No wonder the tackle-makers do not care to make these flies—and it is a fact that they are slow to take them up.

P.—YELLOW MAY FLY.—This beautiful and favorite fly is found very plentifully on northern streams, during summer and the “counterfeit presentment” on plate 2 is an exact imitation. The wings are stained Tarpon membrane, the legs are horse-hair, and the body is of horse-hair wound round with horse-hair. The tail consists of two fibers of the mallard breast-feather. I leave it to the unprejudiced reader to say if a nearer imitation of an actual insect is possible.

Q and R are two forms of the favorite “brown hackle.” Q is the *palmer* hackle and R the brown hackle.

S.—GRASSHOPPER-FLY.—Why this is so called I do not know. Orvis & Co. (tackle-makers), figure it in their elaborate catalogue, “Fishing With the Fly,” but it certainly resembles no grasshopper of this sublunary sphere. All the same, it is a good Trout-fly, and with it I have taken some big fish. It is thus dressed: Tag, silver tinsel and green silk; tail, yellow swan and wood-duck (the black-and-white-tipped feather); body, brown silk; hackle, cardinal; wing jungle-cock feather, with over-wing of red ibis and yellow swan (dyed); head, peacock herl.

T.—ADJUSTABLE BASS OR LAKE TROUT FLY.—There is a peculiarity about this fly which demands close attention. It is made in two sections, on a system new to fly-makers. The body and tail are formed on the hook, and a thin tube of brass, or even quill, is inserted, after the fashion of the female ferrule of a rod. The hackle and wings are tied securely *on a pin*, which, when inserted into the aforesaid

tube, fits snugly and completes the *tout ensemble*. The hook-part, of course, is securely attached to the snell, and the adjustable wings and legs do not throw out, but are naturally tightened by the water.

This novel invention is (like all the other novelties described in these articles), my own, and I claim for it quite an extended range of usefulness. It often happens that the Bass, Trout, and even Salmon fisherman finds it necessary to change his flies till the right color and arrangement are hit upon. If he possess twelve only of these sets of adjustable flies—that is, twelve bodies, twelve wings, etc.,—he can make twelve dozen—or 144—different changes, and a gross

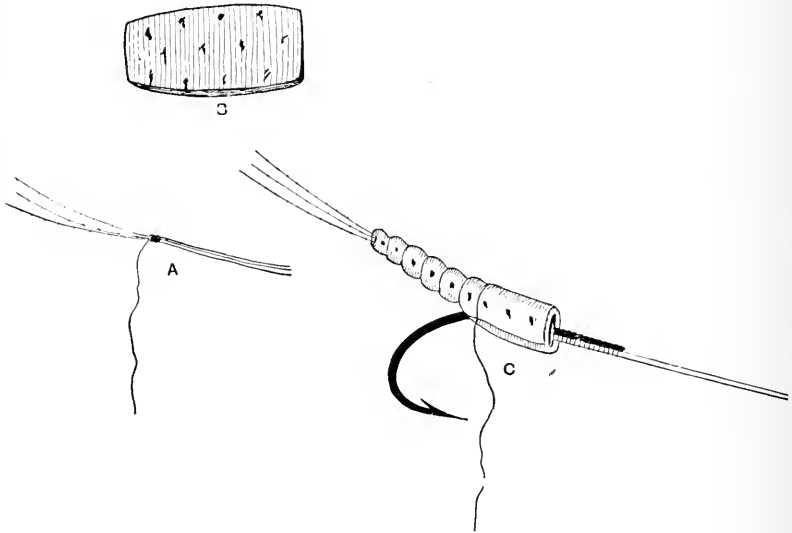

Fig. 29.

of these flies, costing no more than a gross of first-class flies ever do, will provide him with—not 144, as would be the case with a gross of ordinary flies—but twenty thousand seven hundred and thirty-six changes—sufficient to last a life-time. It should be said that the adjustable system is



applicable to all sizes of hooks larger than number 8 (Red-ditch numbering).

U.—CORK-BODIED FLOATING FLY.—Body, cork; tail, fiber from peacock wing-feather; hackle, brown; shoulder, two turns of peacock herl; wing, mallard breast-feather.

The details of the making of this exceedingly killing fly are worth giving. Two bristles are taken, and the fibers for the tail are attached by strong tying silk, as in A, fig. 29. A slice of good clear cork is then cut (B) and soaked in warm water for a few moments to render it pliant. It is then wrapped round A, and the tying silk (of appropriate color, of course), is rolled round it in wide coils, and the cork is then placed on the shank of the hook (C). The coils are continued and finally secured. The peacock herl hides the junction between cork and hook; the hackle is added, and then the wings; and the fly is finished.

V.—DOUBLE-WINGED RED SPINNER.—This feature of double-winging not only imitates many of the natural insects, but owing to the greater volume of feather (usually from some water-bird whose feathers are always most buoyant) it renders the fly a floater, when the wings are dried, by whirling in the air once or twice between each cast, as is practiced on the much-fished streams of England. This is pretty fishing—to see the fly sailing down, wings erect, on the water, until the rising fish takes it with a musical smack of his snowy lips. What says Shakespeare?

“The pleasantest angling is to see the fish  
Cut with her golden oars the silver stream,  
And greedily devour the treacherous bait.”

X.—THE ROYAL COACHMAN.—Tail, wood-duck; tag, peacock herl; body, scarlet silk; shoulder, peacock herl; hackle, brown. A splendid all-round fly.

Z.—RED-LEGGED GRASSHOPPER.—Body, yellowish green chenille; legs, mid-rib of hackle, fibers clipped close; wings, sparrow small quill-feathers; head, peacock herl. As will be observed, this is an imitation of nature. I have tried

all kinds of imitations, and this is the one with which to best fool Trout, in a clear stream, in the grasshopper season. Of

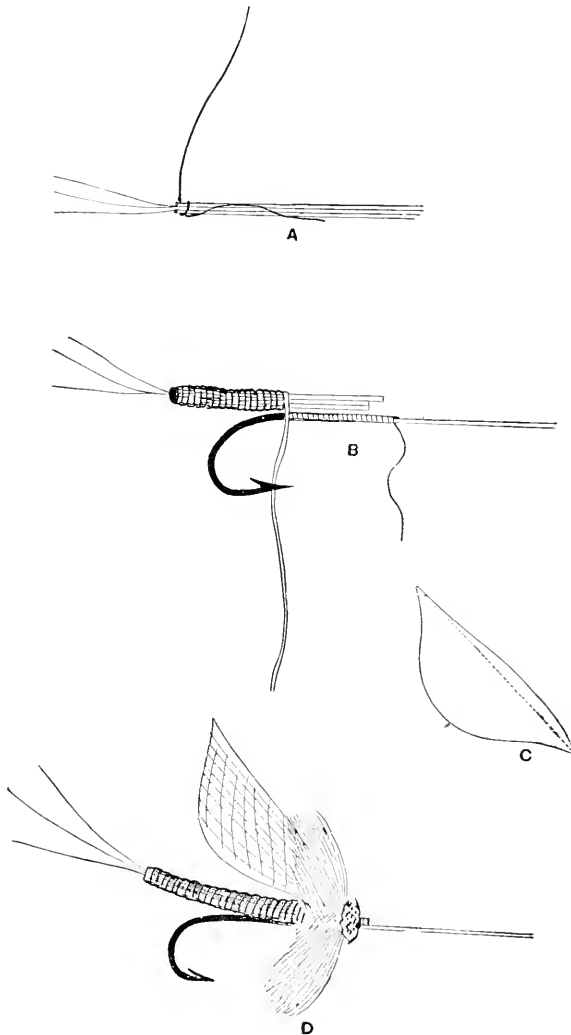

Fig. 30.

course the natural insect is more killing, but this is very effectual, even in comparison.

The chief of the flies to be found near water can be very closely imitated in gut, for the bodies (or quill) and the scale-membrane wings are always acceptable, when the insect to be copied is possessed of a one-hued wing. Of course, if it is of various shades and tints the scale fails and we are obliged to resort to feather.

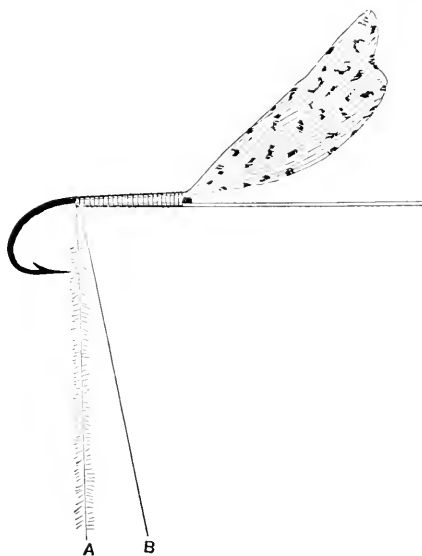

Fig. 31.

The process of the making of the ordinary gut-bodied, detached membrane winged fly is shown in the diagram, fig. 30. The flattened waste-ends of hank-gut are soaked, and drawn between the thumb-nail and finger to straighten them. One is then taken and set on, round three or more hog's bristles (see A), and continued till the stage B is arrived at. The gut is then further wound on, and secured finally by the tying silk. Next, the hackle is set on, then the wing. This latter is formed thus: Take a piece of scale-membrane, and double it—then cut it till the free edges resemble C. Next cut a piece out of the fold, as shown by the dotted line in C, leaving a minute piece joining the two wings at top and

bottom. Next, place it and tie it *in situ* (see D); finally tie on a piece of ostrich or peacock heel for head, as shown.

Sometimes a fluffy and woolly body is preferred. In such cases fig. 31 shows the amateur what to do. Take two pieces of well-waxed tying silk and secure them, as shown, to the hook. Pick out the fur or wool, etc., and lay it carefully on the left-hand thread; then bring the other on top of it, and twist both threads to the left till the two threads have gathered up the dubbing satisfactorily. It can then be wound on as one thread. This is a far better plan than using one thread only and trusting to the stickiness of the wax.

All the quill-bodied gnats are made from the quill of the fibers of the peacock eye-feather. The list of the fiber is stripped off, and there remains a parti-colored strip which, when wound on the hook as a body, is wonderfully like the natural insect. These imitations can be varied indefinitely, and the taste of the tier is brought greatly into play in the manufacture of these tiny flies.

In the above directions and explanations sufficient has been said to put the learner on the right track, and it is his own lack of enthusiasm to blame if he does not profit by them. The following are the dressings of the chief and most valued patterns of Trout, Bass and lake flies. [Salmon flies will be dealt with in another section.]

## NAMES AND DRESSINGS OF STANDARD TROUT FLIES FOR THE AMATEUR FLY DRESSER.

### HACKLES.

#### BROWN HACKLE.

TAG.—Gold tinsel.  
BODY.—Peacock herl.  
HACKLE.—Brown.

#### SCARLET HACKLE.

TAG.—Gold tinsel.  
BODY.—Scarlet silk, ribbed, gold tinsel.  
HACKLE.—Scarlet.

#### WHITE HACKLE.

TAG.—Gold tinsel.  
BODY.—White silk, ribbed, gold tinsel.  
HACKLE.—White.

#### YELLOW HACKLE.

TAG.—Silver tinsel.  
BODY.—Yellow silk, ribbed, silver tinsel.  
HACKLE.—Yellow.

#### GINGER HACKLE.

TAG.—Gold tinsel.  
BODY.—Light brown wool yarn.  
HACKLE.—Light brown (ginger).

#### GRAY HACKLE.

TAG.—Gold tinsel.  
BODY.—Green silk, ribbed, gold tinsel.  
HACKLE.—Gray, from Plymouth Rock rooster.

### WINGED FLIES.

#### COACHMAN.

TAG.—Gold tinsel.  
BODY.—Peacock herl, ribbed, black silk thread.  
HACKLE.—Brown.  
WINGS.—White dove.

#### COACHMAN, LEADWING.

TAG.—Gold tinsel.  
BODY.—Peacock herl, ribbed, black silk thread.  
HACKLE.—Brown.  
WINGS.—Lead-colored feather under wing of mallard.

#### COACHMAN, ROYAL.

TAIL.—Fibers of black and white wood-duck feather.  
TAG.—Gold tinsel.  
BODY.—One-third peacock herl, one-third scarlet silk, one-third peacock herl.  
HACKLE.—Brown.  
WINGS.—White dove.

#### COACHMAN, RED TIP.

TAG.—Gold tinsel and red silk.  
BODY.—Peacock herl.  
HACKLE.—Brown.  
WINGS.—White dove.

#### COACHMAN, GILT.

TAIL.—Yellow.  
TAG.—Gold tinsel and two turns of peacock herl.  
BODY.—Green silk, ribbed, gold.  
HACKLE.—Brown.  
WINGS.—White dove.

#### COWDUNG.

TAG.—Gold tinsel.  
BODY.—Yellowish-green wool.  
HACKLE.—Brown; clipped and coiled-up body  
WINGS.—Brown hen wing.

#### BLUE JAY.

TAIL.—Yellow goose.  
TAG.—Yellow silk.  
BODY.—Claret silk.  
HACKLE.—Wine color.  
WINGS.—Blue jay.

#### RED ANT.

TAG.—Gold tinsel.  
BODY.—Butt of herl, body red silk.  
HACKLE.—Scarlet.  
WINGS.—Ibis.

#### GREAT DUN.

TAIL.—Brown mallard.  
TAG.—Gold tinsel.  
BODY.—Brown wool?  
HACKLE.—Brown.  
WINGS.—Dark lead feather from mallard under wing.

#### CINNAMON.

TAIL.—Brown mallard.  
TAG.—Gold tinsel.  
BODY.—Bright cinnamon-brown wool.  
HACKLE.—Brown.  
WINGS.—Brown (light) feather from turkey tail or wing.

#### DEER FLY.

TAIL.—Black hackle.  
TAG.—Gold tinsel.  
BODY.—Bright green silk.  
HACKLE.—White.  
WINGS.—White dove.

#### RED FOX.

TAIL.—Fibers of mallard.  
TAG.—Gold tinsel.  
BODY.—Red brown wool.  
HACKLE.—Brown.  
WINGS.—Light dun under feather of mallard.

#### GOVERNOR.

TAG.—Scarlet silk.  
BODY.—Peacock herl.  
HACKLE.—Brown.  
WINGS.—Dark brown mottled turkey.

#### GREEN DRAKE.

TAIL.—Brown mallard.  
TAG.—Gold tinsel.  
BODY.—Dirty yellow silk, ribbed, brown.  
HACKLE.—Brown.  
WINGS.—Mallard breast feather, stained yellowish green.

#### AUDER FLY.

TAG.—Gold tinsel.  
BODY.—Dark brown wool.  
HACKLE.—Black.  
WINGS.—Very dark slate duck feather.

#### SOLDIER.

TAG.—Gold tinsel.  
BODY.—Scarlet silk.  
HACKLE.—Brown.  
WINGS.—Light dun mallard wing.

**BLACK ANT.**

**TAG.**—Gold tinsel.  
**BODY.**—Butt of ostrich, body black silk  
**HACKLE.**—Black.  
**WINGS.**—Crow.

**SETH GREEN.**

**TAIL.**—Mallard.  
**TAG.**—Gold tinsel.  
**BODY.**—Light green, ribbed, gold or yellow silk.  
**HACKLE.**—Brown.  
**WINGS.**—Lead feather under mallard's wing.

**PROFESSOR.**

**TAIL.**—Ibis.  
**TAG.**—Gold tinsel.  
**BODY.**—Yellow silk, ribbed, gold.  
**HACKLE.**—Brown.  
**WINGS.**—Mallard breast feather.

**BLUE PROFESSOR.**

**TAIL.**—Ibis.  
**TAG.**—Gold tinsel.  
**BODY.**—Blue silk, ribbed, gold.  
**HACKLE.**—Brown.  
**WINGS.**—Mallard breast feather.

**DARK STONE.**

**TAIL.**—Brown mallard.  
**TAG.**—Gold tinsel.  
**BODY.**—Dark chocolate wool.  
**HACKLE.**—Brown.  
**WINGS.**—Mallard back feather (brown).

**SILVER BLACK.**

**TAG.**—Silver tinsel.  
**BODY.**—Black silk, ribbed, silver.  
**HACKLE.**—Black center, white tips.  
**WINGS.**—Crow.

**SCARLET IBIS.**

**TAG.**—Gold tinsel.  
**BODY.**—Scarlet, ribbed, gold.  
**HACKLE.**—Scarlet.  
**WINGS.**—Ibis.

**STONE FLY.**

**TAIL.**—Mallard fiber.  
**TAG.**—Silver tinsel.  
**BODY.**—Gray silk, ribbed, silver.  
**HACKLE.**—Gray dun.  
**WINGS.**—Gray dun lead feather from under mallard's wing.

**WHITE MILLER.**

**TAG.**—Gold tinsel.  
**BODY.**—White chenille.  
**HACKLE.**—White.  
**WINGS.**—White dove.

**FIERY BROWN.**

**TAIL.**—Red, ibis.  
**TAG.**—Gold tinsel.  
**BODY.**—Red-brown wool.  
**HACKLE.**—Brown.  
**WINGS.**—Brown hen's wing.

**YELLOW DRAKE.**

**TAG.**—Gold tinsel.  
**BODY.**—Yellow silk, ribbed, gold.  
**HACKLE.**—Yellow.  
**WINGS.**—Mallard breast feather, dyed yellow.

**GRIZZLY KING.**

**TAIL.**—Red, ibis.  
**TAG.**—Gold tinsel.  
**BODY.**—Green (light), ribbed, gold.  
**HACKLE.**—Grizzly.  
**WINGS.**—Mallard breast feather.

**SOLDIER PALMER.**

**TAG.**—Gold tinsel.  
**BODY.**—Red silk, ribbed, gold, hackle carried up the entire length.  
**HACKLE.**—Brown.

**OAK FLY.**

**TAIL.**—Golden pheasant tippet.  
**TAG.**—Gold tinsel.  
**BODY.**—Yellow silk.  
**HACKLE.**—Brown.  
**WINGS.**—Dark mottled turkey.

**YELLOW MAY.**

**TAIL.**—Brown mallard.  
**TAG.**—Gold tinsel.  
**BODY.**—Yellow silk, ribbed, gold.  
**HACKLE.**—Yellow.  
**WINGS.**—Yellow swan or dove (dyed).

**BLACK JUNE.**

**TAG.**—Gold tinsel.  
**BODY.**—Ostrich herl.  
**HACKLE.**—Black.  
**WINGS.**—Crow.

**TEAL.**

**TAIL.**—Black hackle.  
**TAG.**—Gold tinsel.  
**BODY.**—Dark wine silk.  
**HACKLE.**—Dark green.  
**WINGS.**—Green feather from quills of teal wing.

**REUBEN, WOOD.**

**TAIL.**—Brown hackle.  
**TAG.**—Gold tinsel, and red silk butt.  
**BODY.**—White chenille.  
**HACKLE.**—Brown.  
**WINGS.**—Mallard breast feather.

**RED SPINNER.**

**TAIL.**—Brown hackle.  
**TAG.**—Gold tinsel.  
**BODY.**—Crimson silk, ribbed, gold.  
**HACKLE.**—Red and gold.  
**WINGS.**—Pale dun feather from mallard under wing.

**WIDOW.**

**TAIL.**—Black hackle.  
**TAG.**—Silver tinsel.  
**BODY.**—Blue silk, ribbed, silver.  
**HACKLE.**—Black center, white tips.  
**WINGS.**—Medium dun feather from mallard under wing.

**GRASSHOPPER.**

**TAIL.**—Wood-duck, black and white, and yellow swan.  
**TAG.**—Gold tinsel.  
**BODY.**—Green one-sixth, brown five-sixths.  
**HACKLE.**—Wine-color.  
**WINGS.**—Jungle cock.

**STEBBINS.**

**TAIL.**—Mallard.  
**TAG.**—Gold tinsel.  
**BODY.**—Blue silk (dark).  
**HACKLE.**—Partridge.  
**WINGS.**—Medium under duck wing.

**ORANGE BLACK.**

**TAIL.**—Golden pheasant tippet.  
**TAG.**—Gold tinsel.  
**BODY.**—Orange, ribbed, gold.  
**HACKLE.**—Black.  
**WINGS.**—Black crow.

**COCH-Y-BONADHU, or MARLOW BUZZ.**

**TAG.**—Gold.  
**BODY.**—Peacock herl and ostrich, half each.  
**HACKLE.**—Brown tips, black center.

**AUGUST DUN.**

**TAIL.**—Two rabbits' whiskers.  
**TAG.**—Gold.  
**BODY.**—Brown silk, ribbed, yellow.  
**HACKLE.**—Brown.  
**WINGS.**—Brown hen's wing feather.

**CHANTREY.**

**TAG.**—Gold tinsel.  
**BODY.**—Peacock herl.  
**HACKLE.**—Brown.  
**WINGS.**—Dark brown mottled turkey quill feather.

**ETHEL MAY.**

**TAIL.**—Black hackle.  
**TAG.**—Gold tinsel.  
**BODY.**—Green, ribbed, gold tinsel.  
**HACKLE.**—Black.  
**WINGS.**—Guinea-fowl feather.

**KATOODLE BUG.**

**TAIL.**—Mallard.  
**TAG.**—Gold tinsel and blue silk.  
**BODY.**—Light egg-yellow mohair.  
**HACKLE.**—Brown from half-way up body.  
**WINGS.**—Black and brown mottled turkey.

**PARMACHEREE BELLE.**

**TAIL.**—White and red, white below.  
**TAG.**—Silver, butted, peacock herl.  
**BODY.**—Light yellow mohair, picked out and ribbed, broad silver tinsel.  
**HACKLE.**—Red and white  
**WINGS.**—Red and white, half each.

**WHIRLING FLY.**

**TAIL.**—Ginger hackle.  
**TAG.**—Gold.  
**BODY.**—Squirrel's red fur, mixed with yellow mohair.  
**HACKLE.**—Ginger.  
**WINGS.**—Darkfish lead feather from mallard wing.

**BROWN COFLIN.**

**TAIL.**—Mallard fiber.  
**TAG.**—Gold.  
**BODY.**—Gray and bright claret mohair, mixed, tipped with orange silk.  
**HACKLE.**—Gray.  
**WINGS.**—Light lead-color.

**PALE EVENING DUN.**

**TAIL.**—Pin-tail fibers.  
**TAG.**—Silver tinsel.  
**BODY.**—Yellow silk (pale lemon), ribbed, silver.  
**HACKLE.**—Yellow (lemon).  
**WINGS.**—Pale lead feather, from under wing of mallard.

## LAKE TROUT FLIES.

**SILVER DOCTOR.**

**TAIL.**—Wood-duck (black and white barred), yellow swan (dyed), and ibis.  
**TAG.**—Gold and yellow silk, then crimson silk.  
**BODY.**—White silk, ribbed, silver tinsel.  
**HACKLE.**—Yellow first, followed by guinea-fowl.  
**WINGS.**—Brown mottled turkey, surmounted by stripe of ibis.

**SCARLET IBIS.**

**TAIL.**—Brown mallard.  
**TAG.**—Gold tinsel.  
**BODY.**—Scarlet silk, ribbed, gold.  
**HACKLE.**—Scarlet.  
**WINGS.**—Ibis.

**BLACK JUNE.**

**TAG.**—Gold.  
**BODY.**—Peacock herl, ribbed, gold thread.  
**HACKLE.**—Black.  
**WINGS.**—Crow.

**GRAY DRAKE.**

**TAG.**—Silver.  
**BODY.**—Light leaden-colored silk, ribbed, silver tinsel.  
**HACKLE.**—White.  
**WINGS.**—Mallard breast feather.

**CAPTAIN.**

**TAIL.**—Ibis and wood-duck barred feather.  
**TAG.**—Gold and peacock herl (two turns).  
**BODY.**—Lavender silk.  
**HACKLE.**—Wine-color.  
**WINGS.**—Leaden-color feather from mallard under wing.

**ACADEMY.**

**TAIL.**—Ibis.  
**TAG.**—Gold and section of scarlet silk.  
**BODY.**—Peacock herl, ribbed with brown hackle.  
**HACKLE.**—Brown.  
**WINGS.**—Owl's feather from quills, surmounted with stripe of ibis.

**MONTREAL.**

**TAIL.**—Ibis.  
**TAG.**—Gold.  
**BODY.**—Crimson, ribbed, gold tinsel.  
**HACKLE.**—Wine-color.  
**WINGS.**—Brown turkey quill feather.

**BEE.**

**TAG.**—Gold.  
**BODY.**—Peacock herl, ribbed with yellow chenille.  
**HACKLE.**—Black center, brown tips.  
**WINGS.**—Bronze ends of wild-turkey tail.

**TOMAH JO.**

**TAIL.**—Yellow hackle.  
**TAG.**—Gold and peacock herl (two turns).  
**BODY.**—Silver tinsel.  
**HACKLE.**—Yellow and scarlet, mixed.  
**WINGS.**—Black and white barred wood-duck feather. Head, peacock herl.

**BLUE BOTTLE.**

**TAG.**—Gold tinsel.  
**BODY.**—Blue silk, ribbed, gold.  
**HACKLE.**—Black.  
**WINGS.**—Crow.

**CANADA.**

**TAIL.**—Ibis.  
**TAG.**—Silver tinsel.  
**BODY.**—Black silk, ribbed, silver.  
**HACKLE.**—Yellow.  
**WINGS.**—Gray turkey quill feather.

**NO NAME.**

**TAIL.**—Ibis.  
**TAG.**—Gold and scarlet silk.  
**BODY.**—Yellow silk, ribbed, gold.  
**HACKLE.**—Brown.  
**WINGS.**—White swan, over wings of ibis.

## BLACK BASS FLIES.

## LA BELLE.

TAIL.—White and scarlet.  
TAG.—Silver and scarlet silk.  
BODY.—Blue silk, ribbed, silver.  
HACKLE.—Blue.  
WINGS.—White swan or goose.

## WHITE MILLER.

TAG.—Silver.  
BODY.—White chenille.  
HACKLE.—White.  
WINGS.—White swan or goose.

## POLKA.

TAIL.—Brown and white.  
TAG.—Gold.  
BODY.—Scarlet silk, ribbed, gold.  
HACKLE.—Red.  
WINGS.—Guinea-fowl.

## ORIOLE.

TAIL.—Black and yellow.  
TAG.—Gold.  
BODY.—Black silk, gold tinsel ribbing.  
HACKLE.—Black.  
WINGS.—Orange (dyed goose).

## OCONOMOWOC.

TAIL.—Ginger hackle.  
TAG.—Gold.  
BODY.—Yellow silk (light).  
HACKLE.—White and dun.  
WINGS.—Woodcock brown feather.

## LORD BALTIMORE.

TAIL.—Black.  
TAG.—Gold.  
BODY.—Orange silk, ribbed, gold.  
HACKLE.—Black.  
WINGS.—Crow.

## HENSHALL.

TAIL.—Four fibers peacock tail feather.  
TAG.—Gold.  
BODY.—Peacock herl.  
HACKLE.—Dirty white.  
WINGS.—Dove's wing (light drab).

## ALEXANDRA.

TAIL.—Four fibers peacock tail feather.  
TAG.—Silver.  
BODY.—Scarlet silk one-fourth, silver tinsel rest.  
HACKLE.—White.  
WINGS.—Fibers of peacock tail feather.

## TRIUMPH.

TAIL.—Parrot.  
TAG.—Gold.  
BODY.—Green silk one-half, light brown chenille one-half.  
HACKLE.—Black.  
WINGS.—Crow.

## JUNGLE COCK.

TAIL.—Yellow, scarlet, and peacock herl.  
TAG.—Gold.  
BODY.—Yellow silk, ribbed, gold tinsel.  
HACKLE.—Yellow.  
WINGS.—Jungle cock, head black.

## DAVIS.

TAIL.—Yellow and red.  
TAG.—Gold.  
BODY.—Yellow silk, ribbed, gold tinsel.  
HACKLE.—Green.  
WINGS.—Brown turkey, mottled black.

## McCLELLAN.

TAIL.—Ibis.  
TAG.—Silver (broad).  
BODY.—Orange, ribbed, broad silver tinsel.  
HACKLE.—Guinea-fowl.  
WINGS.—Wood-duck black-and-white barred feather.

The angler who can make a good Trout-fly will find little

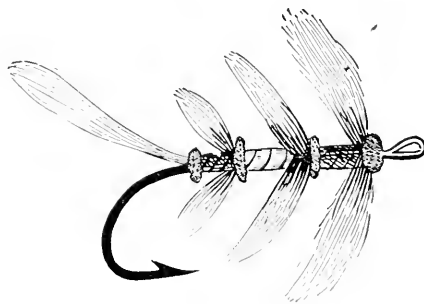

Fig. 32.

difficulty in the construction of a Salmon-fly, except such as will arise from the increased care and greater sense of proportion necessary. A few words preliminary to the intro-



duction of the dressings of some of the best flies for the "lordly" fish will not, however, be out of place.

The easiest Salmon-fly to make is perhaps the "hackle" shown in the illustration. I call it the "Fascinator," and it may be thus described: Tail, golden pheasant crest; tag, gold tinsel; butt, black ostrich; first section of body, black silk; first hackle, black, butted with dark gray ostrich; second section; white ribbed silver wire; second hackle, gray, butted with black ostrich; third section, dark crimson ribbed gold tinsel; third hackle, dark wine-color; head, brown ostrich.

Now, this hackle is made precisely as if making an ordinary Trout hackle, and the extra care necessary is expended on the selection of the right-sized hackle, and in tying each section neatly and smoothly. There is absolutely no difficulty that care and practice will not overcome.

The bodies of all Salmon-flies are made in an analogous if not similar manner. And the hook being larger, they are in reality much easier to construct than the tiny midges and gnats of the Trout fisherman.

The winging of a Salmon-fly, however, presents some difficulties. Each side must be prepared separately, and it is necessary that the fibers of the different feathers should be laid with care that their ends be level and not uneven. One side is then placed on the other, and the two are lifted up by placing the forefinger of the left hand upon them flatly and then passing the stiletto or large darning needle underneath. By this means the two wings can be lifted from the table undisturbed, and embraced by the thumb and finger, then to be tied in place strongly and firmly. After the side wings are tied the cheeks and top-wing are adjusted, then follows the horns, and finally the head—though previous to the head being wound on, the whole mass of crushed feather-ends should be soaked well through with the varnish. There really seems to be little else to be said of great importance about Salmon-fly tying. Of

course one does not begin to tie a Salmon-fly at first—that is the wrong end of the string—but having begun at the A B C, in the “Pennell” hackle, and worked on, the amateur will find this *chef d'œuvre* of the fly-dresser's art by no means so unattainable as it looks.

The following dressings are those of a dozen of the most killing combinations known, and are veritable jewels, in feather, fur and silk.

### DRESSINGS OF SALMON FLIES.

#### BUTCHER.

**TAG.**—Silver twist and yellow silk.

**TAIL.**—A topping, teal and powdered blue macaw.

**BUTT.**—Black herl.

**BODY.**—In four equal divisions, beginning with light red-claret, and continuing with light blue, dark red-claret, and dark blue seal's fur.

**RIBS.**—Silver tinsel, preceded on large hooks by silver lace.

**HACKLE.**—Natural black from light red-claret seal's fur.

**THROAT.**—Yellow hackle and gallina.

**WINGS.**—A tippet and breast feather of the golden pheasant, back to back, both being well veiled on either side with slight strips of teal, golden pheasant tail, gallina, bustard and peacock wing, with strands of parrot and swan (dyed yellow), and with two strips of mallard at top.

**HORNS.**—Blue macaw.

**CHEEKS.**—Chatterer.

**HEAD.**—Black herl.

#### POPHAM.

**TAG.**—Gold twist.

**TAIL.**—A topping and Indian crow.

**BUTT.**—Black herl.

**BODY.**—In three equal sections, buffed with black herl. The first dark orange silk, ribbed with fine gold tinsel, having Indian crow above and below, as shown; the second, or middle joint, of yellow silk, with the ribbing and crow's feathers repeated; the third, of light blue silk, but with silver ribbing and the crow's feathers, as before.

**HACKLE.**—Jay, at the throat only.

**WINGS.**—Tippet, teal, gallina, golden pheasant tail, parrot, light brown mottled turkey, bustard, red macaw, yellow macaw (swan, dyed yellow for large sizes), with two strips of mallard above and a topping.

**HORNS.**—Blue macaw.

**CHEEKS.**—Chatterer.

**HEAD.**—Black herl.

#### DURHAM RANGER.

**TAG.**—Silver twist and very dark yellow silk.

**TAIL.**—A topping and Indian crow.

**BUTT.**—Black herl.

**BODY.**—Two turns of dark orange silk, two turns dark red-orange seal's fur; the rest, which is about half, black seal's fur.

**RIBBED.**—Silver lace and silver tinsel.

**HACKLE.**—From orange seal's fur, a white coch-y-bonddu dyed orange.

**THROAT.**—Light blue hackle.

**WINGS.**—Four golden pheasant tippets, overlapping, and enveloping two projecting jungle fowl feathers (back to back), and a topping.

**CHEEKS.**—Chatterer.

**HORNS.**—Blue macaw.

**HEAD.**—Black Berlin wool.

#### JOCK SCOTT.

**TAG.**—Silver twist and light yellow silk.

**TAIL.**—A topping and Indian crow.

**BUTT.**—Black herl.

**BODY.**—In two equal sections; the first, light yellow silk ribbed with fine silver tinsel; above and below this are placed three or more toucan's feathers, according to the size of the butt, extending slightly beyond the butt, and followed with three or four turns of black herl. In the second half we have black silk, with a natural black hackle running along it, and ribbed with broader silver tinsel (and silver lace on very large hooks).

**THROAT.**—Gallina.

**WINGS.**—Two strips of black turkey with white tips, two strips of bustard and gray mallard, with strand of golden pheasant tail, peacock (sword feather), red macaw and swan (dyed blue and yellow); above there are two strips of mallard, one on either side, and a topping.

**SIDES.**—Jungle fowl.

**CHEEKS.**—Chatterer (formerly kingfisher).

**HORNS.**—Blue macaw.

**HEAD.**—Black herl.

**DANDY.**

**TAG.**—Silver twist and yellow silk.  
**TAIL.**—A topping, strands of summer duck (barred), and a chatterer feather.  
**BUTT.**—Black herl.  
**BODY.**—Silver tinsel (flat), and very light blue silk.  
**RIBS.**—Silver tinsel (oval).  
**THROAT.**—A very light blue hackle and gallina.  
**WINGS.**—Two tippets (back to back) enveloping two projecting jungle fowl feathers (back to back).  
**SIDES.**—Summer duck.  
**CHEEKS.**—Chatterer, and a topping above.  
**HORNS.**—Blue macaw.  
**HEAD.**—Black Berlin wool.

**CAPTAIN.**

**TAG.**—Silver twist and light blue silk.  
**TAIL.**—A topping and chatterer.  
**BODY.**—Two turns very dark yellow silk, two turns very light orange seal's fur, two turns red-claret seal's fur, and finish with dark blue seal's fur.  
**RIBS.**—Silver tinsel.  
**HACKLE.**—A white coch-y-bonddu, dyed red-claret, from the very light orange seal's fur.  
**THROAT.**—Light blue hackle and gallina.  
**WINGS.**—Pintail, teal, gallina, peacock wing, Amherst pheasant, bustard and golden pheasant tail, swan (dyed light orange), dark orange, dark claret, and dark blue, with two strips mallard above and a topping.  
**SIDES.**—Jungle fowl.  
**HORNS.**—Blue macaw.  
**HEAD.**—Black herl.

**SILVER-FLY.**

**TAG.**—Silver twist and yellow silk.  
**TAIL.**—A topping and unbarred summer duck.  
**BUTT.**—Black herl.  
**BODY.**—Silver tinsel (flat).  
**RIBS.**—Silver tinsel (oval).  
**HACKLE.**—A silver furnace hackle along the body.  
**THROAT.**—Widgeon.  
**WINGS.**—Golden pheasant tippet, strands and tail, bustard, swan (dyed yellow), gallina, powder-blue macaw, mallard, gray mallard, and a topping.  
**HORNS.**—Blue macaw.  
**SIDES.**—Jungle fowl.  
**HEAD.**—Black Berlin wool.

**GREENWELL.**

**TAG.**—Silver twist and yellow silk.  
**TAIL.**—A topping and jungle fowl.  
**BUTT.**—Black herl.  
**BODY.**—Light blue silk.  
**HACKLE.**—The same, colored blue from the first turn of the ribs.  
**RIBS.**—Silver lace and silver tinsel (flat).

**THROAT.**—Pintail.

**WINGS.**—Two strips white-tipped turkey (black), golden pheasant tail, bustard (light and dark), gallina, white turkey (dyed green and scarlet), gray mallard, with two strips of mallard above and a topping.  
**SIDES.**—Jungle fowl.  
**HORNS.**—Blue macaw.  
**HEAD.**—Black wool.

**BLACK DOSE.**

**TAG.**—Silver twist and very light orange silk.  
**TAIL.**—A topping, teal and ibis.  
**BODY.**—Two or three turns of light blue seal's fur and black seal's fur.  
**RIBS.**—Silver tinsel.  
**HACKLE.**—Natural black, along the back seal's fur.  
**THROAT.**—A very light plum-claret hackle.  
**WINGS.**—Double tippets, veiled with teal, light-mottled turkey, golden pheasant tail, unbarred summer duck, peacock herl, and mallard, strands of ibis and parrot for small patterns; swan (dyed the same two colors), for large sizes.  
**HORNS.**—Blue macaw.  
**HEAD.**—Black herl.

**TANTE'S FANCY.**

**TAG.**—Silver twist and blue silk.  
**TAIL.**—A topping and toucan.  
**BUTT.**—Black herl.  
**BODY.**—Silver tinsel (flat).  
**RIBS.**—Silver tinsel (oval).  
**HACKLE.**—Claret, from the second turn of tinsel.  
**THROAT.**—Blue hackle.  
**WINGS.**—Hen pheasant tail, peacock wing, swan (dyed very dark red orange), golden pheasant tail, and two strips of mallard above.  
**HORNS.**—Blue macaw.  
**HEAD.**—Black herl.

**LION.**

**TAG.**—Silver twist and yellow silk.  
**TAIL.**—A topping.  
**BUTT.**—Black herl.  
**BODY.**—Silver tinsel (flat), ribbed with silver tinsel (oval), about one-fifth part being left at the shoulder for dark scarlet seal's fur, well picked out.  
**HACKLE.**—Natural black.  
**THROAT.**—Gallina.  
**WINGS.**—Commencing with a few fibers of golden pheasant tippet, sword feather of the golden pheasant, and peacock herl, yellow macaw, red macaw, bustard, golden pheasant tail, teal, gallina, with two strips of mallard above, and a topping.  
**SIDES.**—Jungle fowl.  
**HORNS.**—Blue macaw.  
**HEAD.**—Black Berlin wool.

**SILVER DOCTOR.**

See page 477, and N, plate 2.

## FLY-FISHING CONTINUED.

**THE LEADER (b).**—A few words in the heading "Gut" have already been said in regard to the leader or length of gut which interposes between the fly and the reel-line. It need only be added that its selection as to gauge should be dependent on the state of the water and the size of the fish expected to be taken. If the water be low and clear a fine leader is manifestly necessary. If it is roily, and the fish run large, a thicker one is advisable. It should at least be as long as the rod.

**THE REEL-LINE (c).**—It is almost impossible to single out the best makes of line. My personal preference is for those made by Mr. E. J. Martin, of Rockville, Conn., and for the Acme copper gimp-centered line of Foster Bros., Ashborne, Derbyshire, England. The latter is heavy without bulk, and is exceedingly easy to "lay out" on the surface of the water.

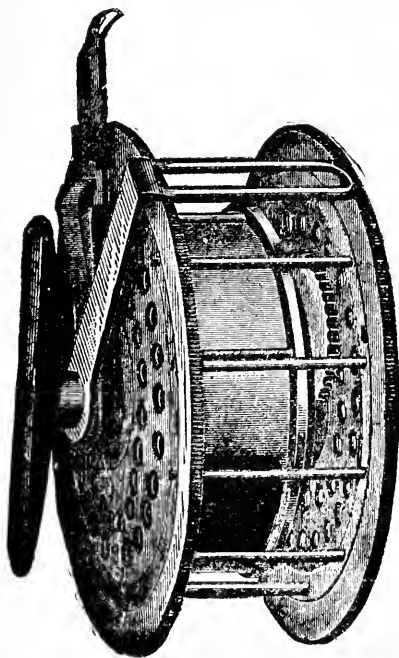

Fig. 33.

**THE REEL (d).**—So many splendid reels are now on the market, that the task of selection is almost invidious. The diagrams show those I use myself. Fig. 33 is the Automatic. This operates automatically when a fish is hooked and it is desired to reel in. The whole operation is performed by one hand. The little finger bears on the brake, and the reel begins to wind in; and the fish has a spring operating against him all the while. Fig. 34

is that patented by Mr. Chubb, of Post Mills, Vt. It is termed the "Henshall-van Antwerp," and for all-round fly fishing cannot be surpassed. Of course for Salmon a larger reel is necessary.

THE FLY-BOOK (e).—This is a consideration of some importance, and the number of different patterns in existence proves that there are differences of opinion as to the best. The gut-snell of fly-books in this country is for some reason fixed at four and one-half inches, and the ingenuity of inven

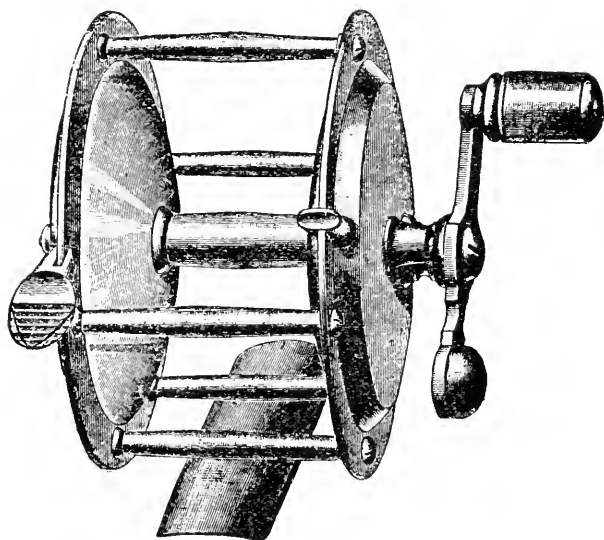

Fig. 34.

tion has been exercised over the discovery of some device which shall retain the snell straight, before and after use. The most efficient, as far as I have been able to examine—and I have seen all—is the Bray arrangement. The hooks are hung over a bar, and then brought down between the close helices of a spiral wire fixed crosswise in the book. The same idea appears in another device of later

design, in that separate rings are crowded together on a rod confined at the ends. Both are good, but the "Bray" arrangement is best.

The fly-book of the future will not be arbitrarily arranged for the four-and-one-half-inch snell, for the reason that the snell of the future will probably be as long as possible without a knot. When the fish of this country become educated to the height of culture exhibited by their European cousins, the farther the loop of the snell is from the hook the better. There is an inevitably bad feature of all the fly-books, as at present made, also in that they crush the fly, and if it should be of the "roofed" or flat-winged species it is entirely put out of shape every time. I am getting up a book which isn't a book, for it is made of tin or zinc. The flies extend beyond the top in a kind of wooden case, and each one can be drawn out without disturbing its fellow. There is nothing so attractive to a shy fish as a brand-new fly, floating with dry buoyancy along the crystal stream, with the sunbeams filtering through its lace-like wings, and glinting on its gay-colored body and opalescent hackle.

I am also perfecting a fly-fisher's hat, the description of which may thus be shadowed forth: A hat having a belt-attachment instead of band encircling it, with books, etc., for the attachment of flies and leaders. Under the helmet-shaped peak, fore and after, are pockets for spare leaders, etc., and on each side an attachment for spare flies. If the angler wants to go to church in this hat he can do so, after removing the attachments, leaving it a respectable-looking chapeau enough—anyhow, good enough for a truth-perverting angler.

[For "Rods and Rod-making," see chapter under that heading.]

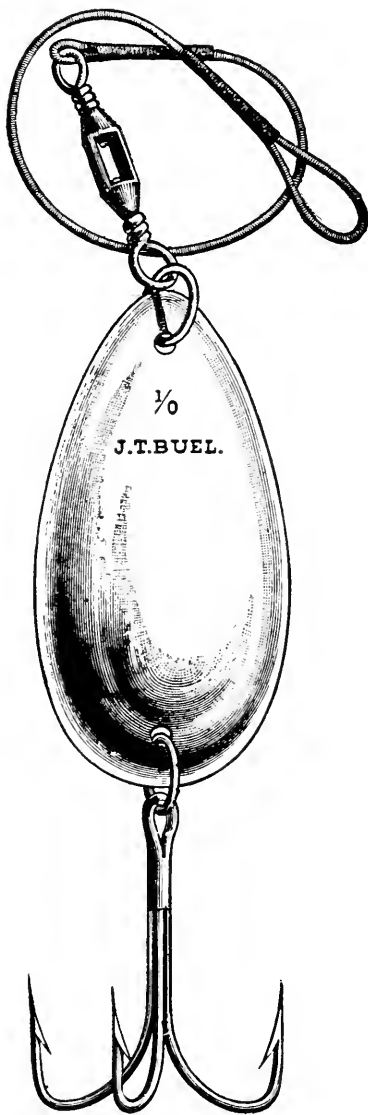

Fig. 35.

## SECTION 6—TACKLE FOR MID-WATER FISHING.

TACKLE FOR TROLLING.—ARTIFICIAL BAIT.—The etymology of the word “trolling” need not concern us very much here, beyond pausing to say that it is evidently derived from the French *troller*, to lead about. Trolling may be defined in this connection as fishing in mid-water with lure, natural

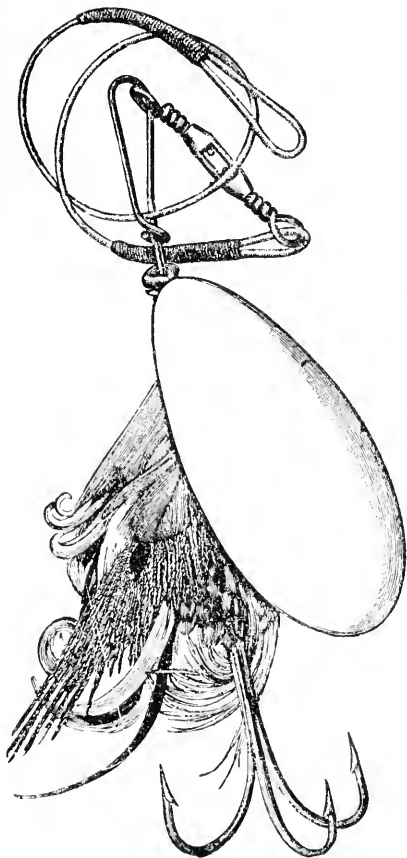

Fig. 36.

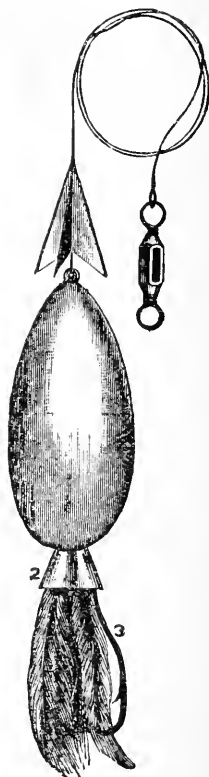

Fig. 37.

or artificial, using a running line in doing so, and so manipulating the bait as to keep it constantly trolling or moving about. Fish of prey, such as Salmon, Trout, Bass, and the Esocidæ, are thus killed by the angler.



I shall first refer to artificial baits. The spoon is without question the chief of those, and in its thousand-and-one modifications is invariably a successful lure. It would be invidious to single out special makes as being superlatively superior. Competition looks after the quality, and reliable tackle-sellers keep good goods. "Cheap," in reference to spoons, infallibly means "nasty."

Fig. 35 represents the orthodox spoon-bait. The attractiveness of this is enhanced by adding tufts of gaudy feathers, and therefore American ingenuity has improved on the original plain spoon of Britain, and we find a combination spoon, as shown at fig. 36, is preferred by trollers for Mascalonge or Pickerel or (Pike).

The difficulty with spoon-trolling is, that the hooks being necessarily so exposed, they catch into weeds and grass with annoying frequency. This has been obviated by the device shown in fig. 37; 1 and 2 and 3 are each arrangements for deflecting or throwing off the weeds, 3 being a flattened bar protecting the point. As it is of spring-steel, it fits, with a slight degree of tension, against the point; and the impact of soft weeds is not sufficiently strong to force it away from the guarded hook, whilst the spring is not strong enough to prevent the fish being hooked as the bait is seized. This arrangement must be seen to be appreciated. It is patented by the Syracuse Fish-

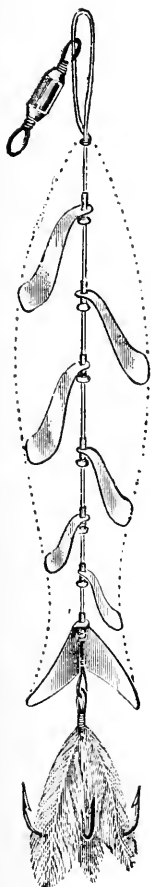

Fig. 38.

Rod Co., N. Y.

Another novelty, of an exceedingly effective form, is made by the same firm, and I give it place because I have personally proved its efficacy. It is shown at fig. 38. When the

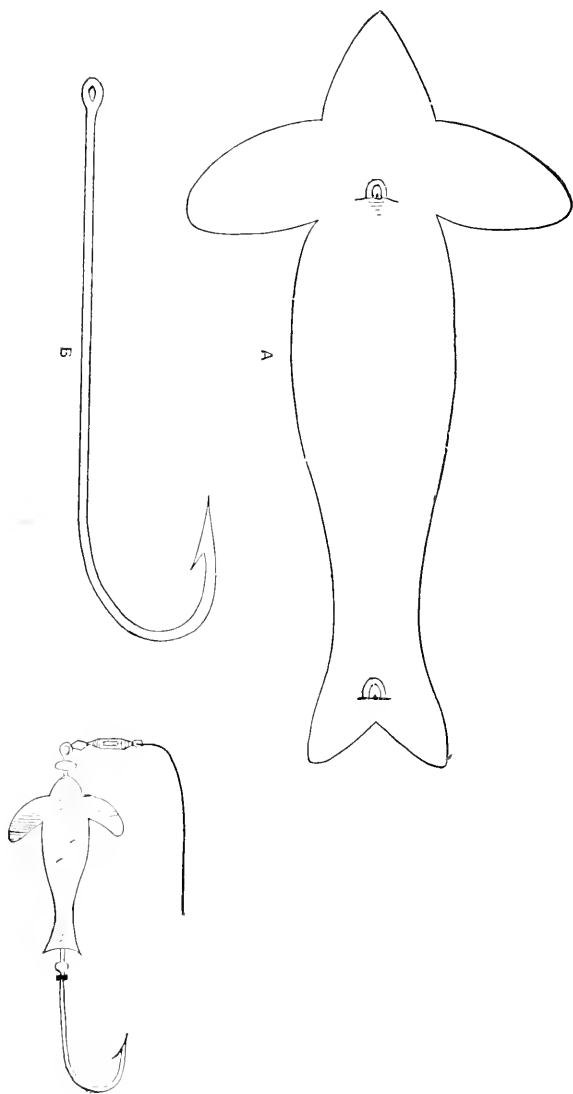

Fig. 39.

flanges are spinning, they represent, from below, a bright and multi-moving fish. The dotted lines in the diagram show the outline. This is a genuine improvement. Of the distinctly artificial, or rather "fancy" baits, the trolling-fly deservedly stands amongst the first. These are made of the ordinary material, as a general thing, and some times a small spoon is placed above them, to their great improvement. But the ordinary fur-and-feather fly is too frail for the teeth of fierce predaceous fish, coming at it with a tiger's dash, and the result is great destruction to one's tackle, in an ordinarily good day's fly-trolling. I make most of my trolling-flies so as to be practically indestructible. The body is of silk, covered over with transparent Tarpon scale-membrane, and the wings of the membrane also. This being, thickness-for-thickness, the toughest skin in the world, baffles even the destroying fangs of the Pickerel, and absolutely defies the horrent teeth of the Bass. Of course the material can be dyed any color deemed necessary.

Artificial frogs, helgramites, and the various abominations termed "luminated" baits—that is, baits smeared with Balmain's Luminous paint—need not here be recounted. I have undertaken only to tell of those baits I consider *best*—without fear or favor.

Of course the novice can manufacture his spoons, if he can afford to buy a stamping apparatus. It is improbable that he can do so, however, and I think he would find a difficulty in getting the spoons separate from the gearing—at least in this country. He can, however, make the flat-metal baits, such as that figured in fig. 39. It is termed "James' trolling bait." A consists of tinned copper, or tin only, and at the head and tail are soldered two loops through which a long-shanked hook is passed. Two beads of solder are fixed on the shank (see fig. 39) to retain the hook, and a swivel is entered into the loop at the end of the shank. The whole bait is simplicity itself.

TACKLE FOR TROLLING WITH THE NATURAL BAIT.—There is always, to my mind, satisfaction in using the dead natural bait—it requires a certain art in adjusting, and the lure is certainly more in keeping with what we know of the food of the quarry. To me, an air of ghastly unreality pervades the gyrations of the glittering spoon. The fish comes up, the victim of morbid suicidal mania, rather than of healthy gormandizing. It is caught by the “giddy pleasure of the eyes,” rather than the promptings of a healthy appetite for food.

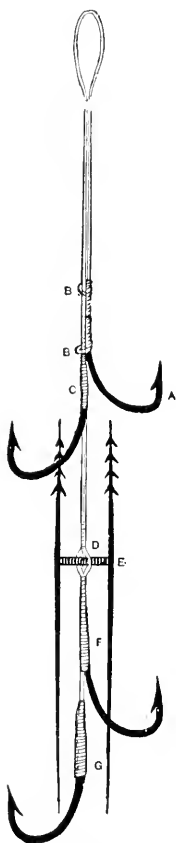

Fig. 40.

The gangs in ordinary use for trolling the dead fish are wrong in principle, and are the same as have been used in the early days of British angling—I specially refer to the three triplet hooks and lip-hook. For these *ten* hooks I substitute four, and find them amply sufficient. Fig. 40 represents my device, and by practical experiment I find it superior to all others—though the “Pennell,” and my “Nonpareil” run it close. [These are described later.]

Fig. 40 may be thus described: A lip-hook is tied on to good fine gimp (A), and two loops of the same material are also tied in (B B). The loose end of the gimp is now turned back and passed through B B and a large single hook (Limerick) is whipped on to it (G); above this another is attached as shown (F). The barbed arrangement (E) must now be explained: It consists of two pieces of rather thick sheet-copper or brass, cut and filed into the shape shown. (If of brass it must not be hardened.) A loop is tied into the gimp at D, and the cross-piece E is placed therein as shown. An inch

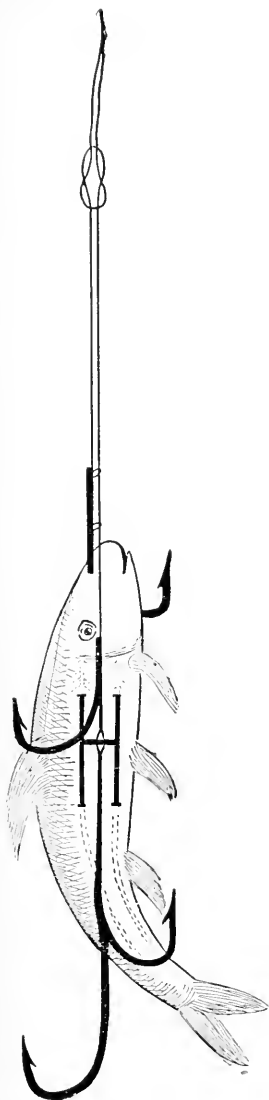

Fig. 41.



Fig. 42

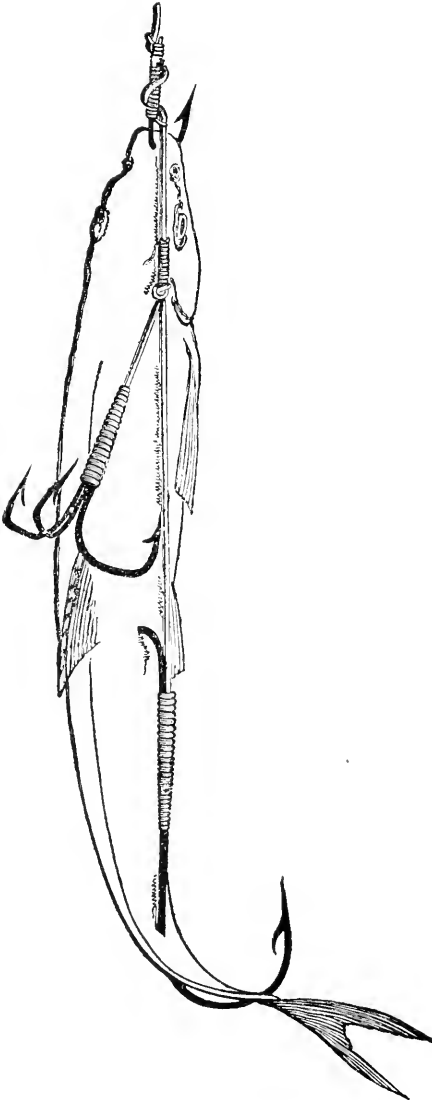

Fig. 43.

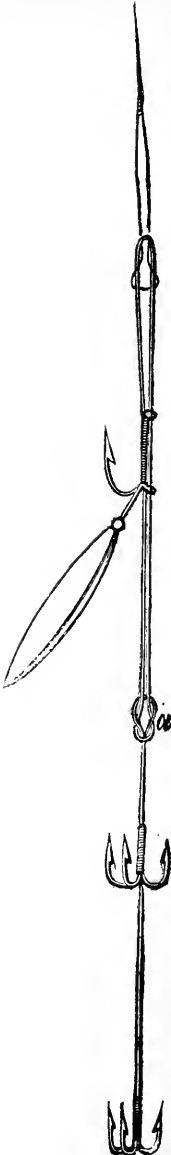

Fig. 44.

further up the line another hook is tied (C), and the apparatus is complete.

Fig. 41 shows the gang baited. The manner of accom-

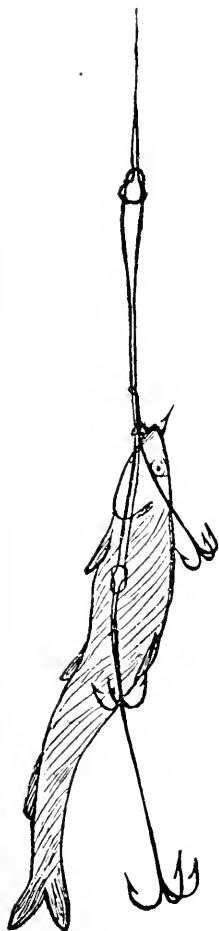

Fig. 45.

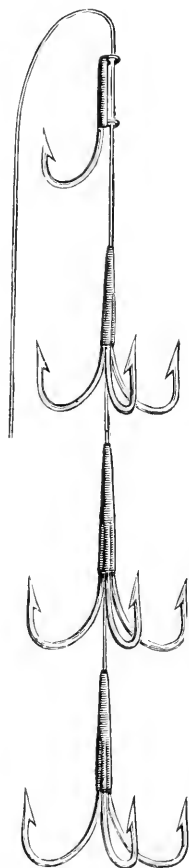

Fig. 46.

plishing this is as follows: kill the minnow, then insert the two long prongs into the fish at a point a little tailward of the dorsal fin, and push it as far as it will go toward the fork

of the tail, along-side the backbone of the minnow. Now below the head of the fish insert the short barbed forks, and press them up to the cross-bar, withdrawing the long forks at the same time, of course. It is now baited as shown (fig. 41), with the exception of the bend in the tail-end of the body. This is made to the extent required, according to the judgment of the angler. About the bend shown in the diagram is sufficient, ordinarily, to make the fish revolve with celerity, and without much "wobbling."

Fig. 42 shows the "Pennell" gang, and it is deservedly popular, in England; the only fault I find is that the triplet often fails to hook the fish. It is the fault of all triplets. One hook goes in quicker, and holds quite tight enough for me. Fig. 43 shows the gang baited. Fig. 44 shows the "Nonpareil" gang. The junction at A allows of the lip-hook being shortened or lengthened, according to the size of the bait. Fig. 45 shows the bait *in situ*. The sinker is placed in the mouth, and the lips are closed by means of the lip-hook. The back is turned and bent as shown, to produce the spin or "wobble" so necessary to attract the attention of the fish.

Fig. 46 indicates the ordinary trolling-gang, and it is not to be entirely condemned, because it undoubtedly *does* catch fish. The lip-hook in this case is stayed in its place by means of a twist or two round the shank. The above tackle is sufficient for all practical purposes in trolling.

Sometimes, when the grass is too thick to allow of a bait being drawn through the water without the hooks fouling, the dead gorge bait is used. In this country it is deservedly reprobated, except under the circumstances I have named; and in the British Islands it is equally decried, during late years, though books have been written about it, in the "long ago," as witness Nobbe's "Art of Trolling." The ordinary form of the hook is shown at fig. 47. A is a pear-shaped body of lead, and the hook is passed, by means of a baiting-needle,



in at the mouth and out at the tail, the double hooks lying by the side of the bait's head, just under the eyes. This bait is not drawn through the water, as the spoon or dead gang-bait is drawn; but, after casting, it is manipulated with a sink-and-draw motion, and when the angler has a "strike," he lowers the point of the rod, and gives five minutes or so for pouching or "gorging." He then reels in—does not strike—and the hooks penetrate the gullet of the fish.

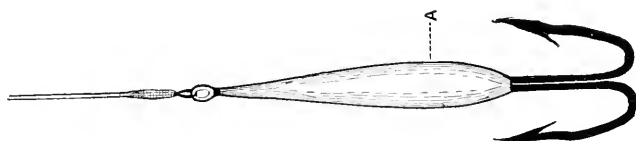

Fig. 47.

An improvement on this hook is shown at fig. 48. The body of the affair is made of linked leads or sinkers, and the hook itself is adjustable, so that no matter what size the bait is, the angler has only to add to or take away from the leads,

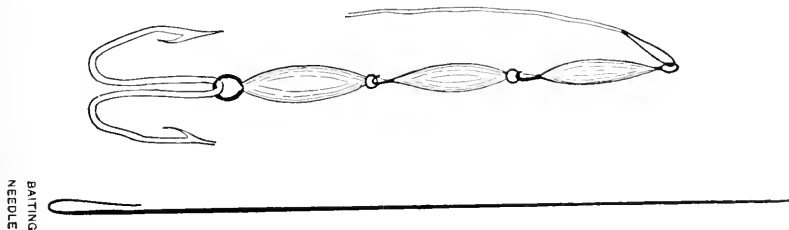

Fig. 48.

and alter the size of the hook, to suit the bait. With fig. 47 this is impossible. A fresh hook must be substituted each and every time.

**TACKLE FOR LIVE-MINNOW FISHING.**—The ordinary single hook, hooked through the lip or under the back fin, generally suffices the rough-and-ready angler. But the observant angler notices that only a comparatively small percentage of fish are hooked when they are "coming short"—or not biting

with avidity. To avoid this, I commonly adjust a large single hook or triplet, as in fig. 49, below the single hook; or, as in fig. 50, a rubber band is tied so that it keeps the hooks

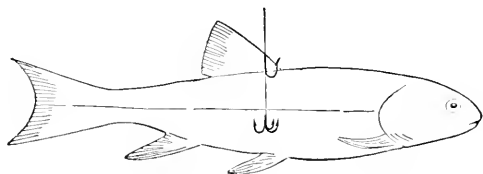

Fig. 49.

in situ, thus causing no inconvenience to the bait except that of having a hook through the gristly cartilage of the nose—which I do not think the bait objects to very much.

Fig. 51 shows a more brutal “gorge” live bait. It is *deadly*

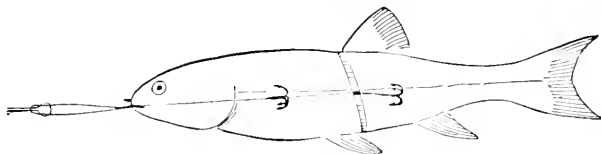

Fig. 50.

because the fish is allowed to gorge it before the angler strikes on him. That is all the recommendation I can give it.

In fig. 52 we have the best arrangement for live-bait fishing, where large Pickerel, Pike, or Mascalonge are expected.

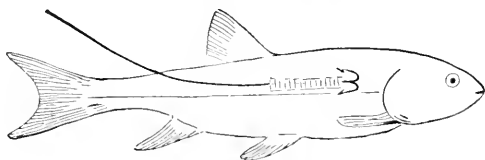

Fig. 51.

The hook near the gills is lightly hooked under the pectoral fin, and that on the back penetrates the cartilage of the dorsal—cruel to the bait, but deadly. With it Mr. Alfred Jardine, of London, England, took the two largest Pike ever taken

with a hook and line. They weighed seventy-two and one-half pounds the pair.

\* \* \* \* \*

Of all live-bait tackles, however, I prefer (individually) the "paternoster" (so-called from its succession of hooks, proba-

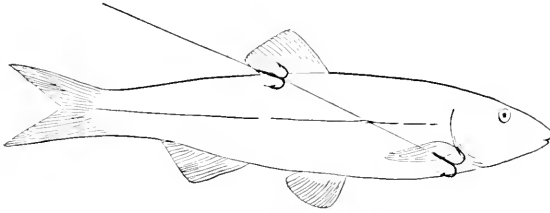

Fig. 52.

bly, like beads on a rosary). Fig. 53 shows it. The main line may be either gimp or gut, and the hooks are attached as

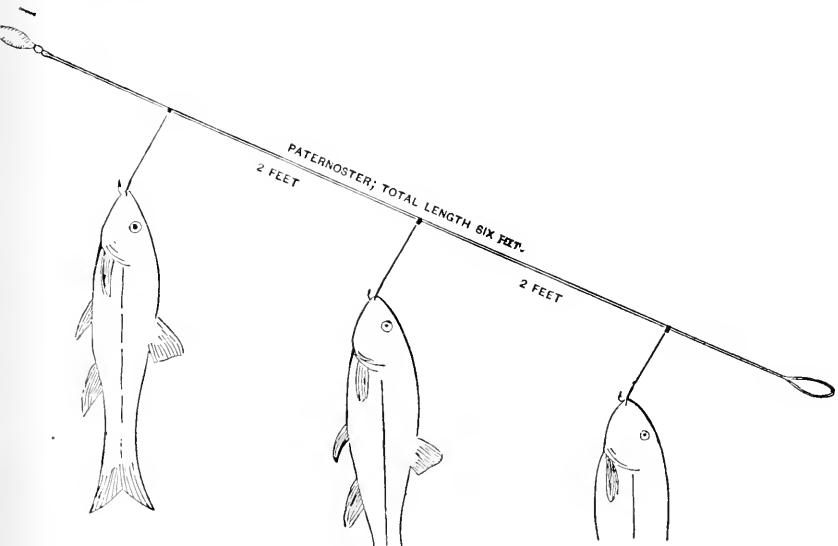

Fig. 53.

shown. At the lower extremity is a pear-shaped lead. This tackle is cast out gently, and as gently worked in toward the boat; and thus it searches the water within considerable

radius. Sometimes a couple, or even three, Bass are on the hooks at one time, and then, look out for fun!

Here endeth mid-water fishing, so far as the actual hook-tackle is concerned. A few remarks on other parts of the outfit may be in order, and they need be only very few.

First, as to the leaders, or "traces," as they are termed, "over the water": In order to avoid "kinking," it is necessary that to all trolling baits swivels should be used. I prefer at least three—one at each end—and if a sinker is needed, one just before it on the line. The traces are best of stout gut, or fine gimp, or twisted gut. The latter make elegant and very strong lines.

I mentioned the sinker, just now. Of course, in the case of fig. 44, no sinker is needed on the line to sink the bait, but one is to be preferred with all the others. This sinker should be heavy or light, according to the depth of the water, or the rapidity of the stream if there is a current. If possible it should be adjustable, and it should always lie under—not



Fig. 54.

on—the line. Fig. 54 shows an adjustable sinker of the shape I prefer. It is rendered adjustable by means of the spiral terminations into which is forced a piece of soft India-rubber cord. As can be seen, it is possible to alter the position to far or near the bait, at will, and if this be used as well as three swivels, there need never be any "kinking."

The reel should be of either of the good makes. Do not purchase a cheap imitation of a good make; and let the one you get be large enough to hold at least 300 feet of line.

## SECTION 7—BOTTOM-WATER AND BAIT FISHING.

Very little so-called "bottom-fishing" is practiced in this country, but it seems likely that the Bull-head, Sucker, Eel, and several other useful fishes, might be more readily made to render sport, if a little more attention were paid to their methods of capture.

Take for example the Bull-head: There is a right and a wrong way of putting on the worm for this fish. It should be threaded right up the center, though I am aware that



Fig. 55.

when they are freely biting it matters little how the bait is affixed. For bait-fishing for Trout, the best tackle is that shown at fig. 55, and the way to adjust the wriggling worm is as shown in fig. 56.

Ordinarily, the best sinker is a round shot; but in the case

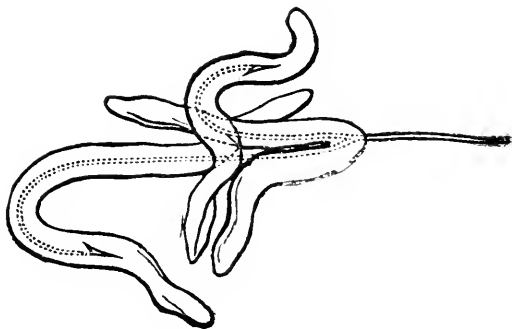

Fig. 56.

of fishing in a swift stream, the leaden sinker shown at fig. 57 is far superior. When a fish bites it draws the line in the direction of the arrow, and the fisherman at the opposing end

feels it instantly, and strikes. Sucker-fishing with the succulent worm and fine tackle is far from ignoble sport, at the proper season of the year.

Bottom-fishing is much practiced in Europe, where fish of the ground-feeding kind are more frequently met with than is the case here. Still, there are times when the sta-

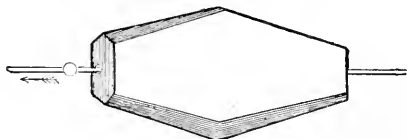

Fig. 57.

tionary sunk worm will take Bass, and nothing else will—this is also the case with the Trout (*S. Salvelinus*).

The newly acclimatized Carp may be caught by still-bottom-fishing, but a previous ground-baiting is necessary. The bait—either a paste of cheese, or worm, should be allowed to rest on the ground, and the wily fish will then, if the tackle be fine, avail themselves of it. They are “kittle-cattle,” however, to capture.

I have thus briefly and succinctly sketched the lesser tackling of the angler, and the methods of making. The matter of rods is a very serious one, and demands a separate chapter, which is accorded it. The two subjects are separated for the convenience of the reader, rather than because they are necessarily of distinct nature. Any and all anglers can learn to make their flies, leaders, etc., but to make rods requires closer attention, and is really a trade in itself.

#### THE FISHING-ROD, AND ITS AMATEUR MANUFACTURE.

The origin of the fishing-rod is lost in the mists of antiquity—and it is of not much consequence. It may be

interesting, however, to briefly note the difference between the "angle" described in the first "Treatyse of Fysshynge," and the wand-like rod so ineffably graceful and beautifully made, now to be seen on every hand. The fish in this country in the great majority are about the same in education as they were four hundred years ago, when the "Treatysse" was printed; but how changed the tackle! Listen to the following:

"Ye shall kytte, between wyghelmas and candlymas, a fayr staffe of a fadom and a-halfe long, and arme grete (thick as one's arm), of hazyll wylowe, or ashe (this is for the butt).

\* \* \* "In the same season take a fayr yards of grene hazle (this is for the second joint); \* \* \* Take a fayr shote of black thorn crab-tree, medeler, or of jeny pie (this is for the tip). Then shave your staffe and make hym tapre wexe (wax taper)." "Hopes of yren"—hoops of iron—are to bind it for strength in place of the modern ferrule (vyrell) and there is no doubt the entire apparatus must have weighed several pounds. My split-cane Spalding, with which I have killed tons of fish during the past five years, weighs just *seven ounces*, fittings and all complete.

The present beautiful weapon is the evolved production of four centuries, and the survival of the fittest, unquestionably. The different types of rods may be here briefly enumerated:

(1) RODS FOR TOP-WATER FISHING.—These are the finest productions of the rod-maker's art, as befits the use to which they are put, and are of several different classes of material. In my mind the *best* kind is that manufactured from the outer skin or enamel of the ordinary bamboo cane. This material is found to be tougher and lighter than any other wood as yet discovered, and it is detached from the cane in such a way as to admit of the greatest amount in the smallest compass when the rod is made. The process will be explained hereafter. It is sufficient here to say that the shape of the finished rod is commonly six-sided, it being contended that this shape admits of the most enamel to the least amount of

inside wood—which is of practically no elasticity. The weapon, from butt to tip, is composed of strips cut from the large butts of the bamboo-cane. These are glued together, and whipped with silk at intervals, and are of course tapered perfectly to allow of the maximum of strength, lightness and resiliency.



Fig. 1.

THE TROUT-FLY ROD is used usually in the single hand—that is, two hands are not taken to it for its manipulation. The reason for this probably is the fact that the rivers in which the Brook-trout is found are for the most part really brooks as to size, and the larger, heavier and longer fly-rod is not necessary to command the water. Hence the Trout-fly rod in ordinary use in America is seldom more than eleven feet long, and from three and one-fourth to ten ounces in weight. The three and one-fourth rod is admirably adapted for ladies, and the ten-ounce rod for gentlemen who prefer a heavy weapon, because of some inherited fancy; but I personally prefer a seven-ounce as the happy medium. One should be able to wield such a rod for weeks without undue fatigue: I have certainly done so.

It is difficult, if not impossible, to convey an accurate idea on paper, either by diagram or description, of the appearance of such a rod. Fig. 1 will give an idea of the proportion preserved, and the following are the measurements: length of each joint, three and one-half feet; diameter of handle, one inch; diameter just above swell of handle, six-sixteenths; diameter at point just below first ferrule, five-sixteenths; above first ferrule, five sixteenths; below second ferrule, three-sixteenths; above second ferrule, three-sixteenths; end



of tip below terminal ring, three thirty-seconds of an inch.

Fig. 2 shows a section of the wood from which the rod is made, and the method of cutting it out. The dotted lines represent the shape of the strips when they are planed down to the proper angle for greatest strength.

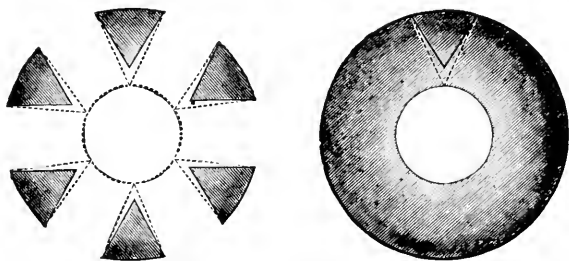

Fig. 2.

The apparent fragility of this rod does not indicate its actual strength. I have, during five seasons, used mine on both Bass and Trout, and the largest Bass was six pounds. It is to-day as straight and strong as when I got it from the maker. There is nothing to be said against the solid-wood rod—if properly made. Several kinds of wood are in popular use, and the favorites, both in this country and England, are greenheart, blue mahoe, lance-wood and hickory. Occasionally one meets with ash, but it is seldom used, except for butts. Lance-wood and greenheart (bethabara I hold to be a species of greenheart, and very unreliable at that)—are the chief of these four, and may be said to be preferable above all the solid woods used in rod-making so far.

The split-cane Salmon-rod is but an enlarged edition of the split-cane Trout fly-rod. I have seen a very good specimen of the kind of rod used on the Restigouche. The specification of this rod was furnished to Mr. Chubb (Rod-maker, Port Mills, Vermont) by Dr. Baxter, weighs from twenty-five to twenty-eight ounces, and is composed of *eight* strips, therefore being octagonal. It is four-jointed, sixteen

feet in length, and of course is very powerful and satisfactory.

For my own part I prefer a double-action, solid-wood greenheart rod, for Salmon, built on the "Castle-Connell"

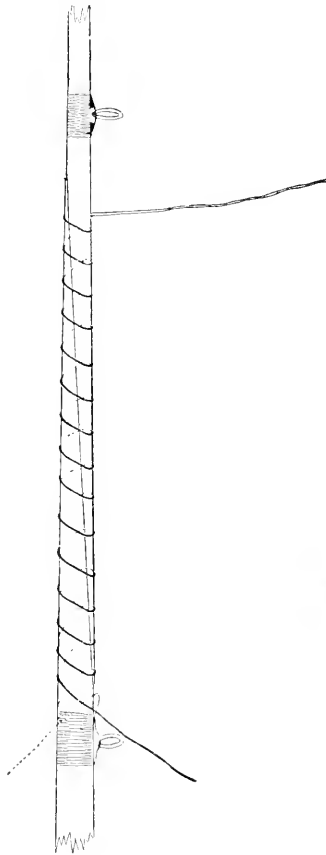

Fig. 3.

principle. Doubtless a little further explanation will be acceptable to the amateur. By double-action is meant a rod with rather exaggerated resiliency, insomuch that its tip, when striking a fish, first goes forward and *then* backward—i.e., its action is double. The "Castle-Connell" rods are also without ferrules, the joints being put together by splicing (see fig. 3); hence a most important feature, elasticity, is preserved along the *entire length* of the rod, and not interfered with by the unyielding ferrule. There is also in this rod considerable play in the butt-joint, which is not the case with the ordinary make. I have just received one from "Joe" Dalzell, of St. Johns, N. B.—the best Salmon-rod maker I know of, and with it a few of "Joe's" sentiments on spliced rods. He says—and I fully concur: "I think there is no rod like a

spliced rod. Of course I have to make ferruled rods, but I 'cuss' when I come to put a strain on them, to see two stiff parts in the rod (the ferrules). In making my rods I glue them up the full length—sixteen feet, or whatever it may be—and then work all down together, so I am sure that every

part of my rod works in unison. Rods that are made to gauge in separate pieces are not near so good, as you will find some parts of them more dense in grain, and other parts more open. By working all together you can make them act in unison—that is, each part of the rod does its share of the work. I think you will find every part of my rods does its share of the work. *I make it work from handle to tip.* Most rods are made with stiff butt. This is good enough for its purpose—giving length. In a rod of that kind the fish is killed on the weakest part; in my rod you kill him on the strongest. Also, in casting a line—if you get impetus from the resilient butt you can cast with less exertion, and a smaller rod of this kind will do the work of a much larger one of the ordinary build.”

RODS FOR MID-WATER FISHING, such as trolling, fishing with live bait, etc., need to be of rather sterner character. For Bass-fishing, Dr. Henshall recommended an eight-foot three-inch rod of eight ounces, made of ash-butt; lance-wood tip and second joint. For my own part I prefer one rather longer, but this is a matter of choice. The ten-foot two-joint rod (Chubb's) fig. 4, with reversible hand-grip, is to me a splendidly efficient weapon. By the way, this hand-grip is a good idea. It allows of the reel being below or above the hand, and one can cast from the reel or not, according to choice.

Of course the short, strongly built Tarpon and Mascalonge rods are “horses of a different color” to the above. I have one made of greenheart from an old ship's knees or ribs, which weighs 28 ounces, and is but twelve feet long—but oh! the strength! It is capable of helping a man out of the water without straining, and is fine-



Fig. 4.

ly trimmed, and in everything good for its purpose—catching big fish and killing them quietly; and if one needs a boat-pole, on an emergency, he has just the implement handy.

Not only has the vegetable kingdom been laid under contribution for material in the manufacture of rods, but also the mineral. Naturally, steel has come in for a share of attention. Forty years ago old Giles Little, of Fetter Lane, London—an enthusiastic fisherman and tackle-maker—made a steel rod. It was simply a tapered steel-spring, with a swelled butt or handle, and was light and exceedingly powerful. I saw it and handled it, in 1879, and thought then that the time was not far distant when a really efficient jointed-rod of steel would be introduced to anglers.

The thought is realized in the steel rod produced by the Horton Steel-rod Co., and I have had the advantage and pleasure of testing one of these rods with great severity. First, I may premise that the ten-foot fly-rods will lift a dead weight of ten pounds—there is no wood-rod fit for fly-fishing that will do that—and in practical fishing they are unbreakable, and as far as I have gone they don't rust. They are made from fine sheet-steel, in tubes, not brazed but brought round together without actual juncture. Some of these rods are telescopic, and act very satisfactorily, if a fine line be used; but a thick line is apt to cling to the large surface of contact, because it runs through the interior of the rod. These rods are, however, now made with guides outside, and the improvement makes an extremely useful rod for rough usage—camping, etc. The temper of the steel is excellent, as it of course must be to be of any use.

Other rods of whalebone—which trenches on the animal kingdom for material—made like a whip with braiding, have been tried, and I myself once endeavored—and shall do so again—to produce a rod of steel and vulcanite; but the split cane, as yet, is triumphant over all its competitors.

There are some pretty rods made, both in England and this country, with metal centers. The "Foster" rod is steel-centered, and the "Hardy" rod (both English) is not only steel-centered but "built up," as it is termed, of bamboo. Fig. 5 shows the "Foster," with its guides on both sides and its reel at the end; and fig. 6 indicates the process of "building up" practiced by Hardy Bros.

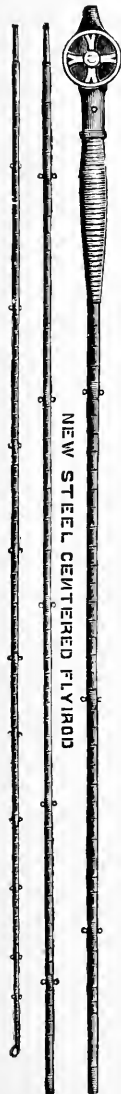

Fig. 5.

Another capitally made rod is the built-up rod of Edwards (Hancock, Del. Co., N. Y.). It is substantially similar to that of Hardy, except that it does not contain the steel core. For my own part I don't want the steel core. This maker says: "I have, for about ten years, made the single enamel, split-bamboo rods. During this time I have used nearly all kinds of ferrules to prevent their breaking off at the ferrules. Finding this was a failure, generally, as the bamboo was strong only on the outside—the inside being at the best very poor—the idea occurred to me to plane away as much of the inside as was poor, and glue another piece of enamel in its place, thereby making the whole rod out of enamel. It takes forty-eight pieces or strips to make a rod with two tips."

A brief glance at the most desirable trimmings—rings or guides, ferrules, reel-plates, etc., is now in order. They have gone through as many vicissitudes as the rods, and are now so improved as to be practically perfect. There are, however, many old-fashioned arrangements on the market, and I make the following remarks to inform the reader of the *best* out of these. Nothing is so objectionable as a good rod with bad trimmings—it is like a beautiful woman in tinsel

and tawdry finery instead of real jewels and good dress.

First, as to guides or rings: these have to receive and allow the line to pass through them, and the minimum of friction

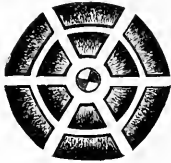

Fig. 6.—Before cementing.



Fig. 6.—After cementing.

is a desideratum. There also should be no possibility of entanglement. This being so, I can find no better ring than that



Fig. 7.

shown in fig. 7. It can of course be made in all sizes; it is simple and lasting.

For a butt-ring on the Bass casting rod, I know of no better one than that shown at fig. 8. It allows the line to pass

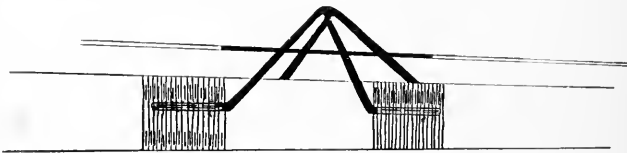

Fig. 8.

through without confining it unduly, which is most necessary for long casting. The simplicity of this arrangement is obvious. It simply consists of two loops of wire tied on in juxtaposition as shown, and touched with hard solder at

their points of meeting. It is a device of my own, and exceedingly practicable. Of course it can be varied as to size, etc.

The ordinary rings for fly-rods are shown in fig. 9. They consist simply of a round metal ring held on the rod by the tie, which is whipped with silk. This is a useful ring for



Fig. 9.

fly-fishing only, and even then not wholly satisfactory, because of the severe friction on the line. Nothing is so discordant to the finished angler as friction in regard to any part of his gear. It sets his teeth on edge. Hence the folding rings (fig. 9) "must go."



Fig. 10.

Tip-rings are extremely various in make. One of the best is that shown at fig. 10. It simply consists of a hard ring—agate, preferably—set between two uprights so that it will be freely movable according to the angle assumed by the line. Of course the size is regulated to suit the rod, though a comparatively large ring is undeniably to be preferred over small ones. Fig. 11 also shows a ring, not on the market, but the like of which I made fifteen years ago. It consists of a ball and socket joint. As will be perceived, it will move in any direction, but needs to be exceedingly well made to stand wear and tear. Fig. 12 shows the solid agate tip ring; and its neat and effective appearance needs no commendation. If one can afford to put a jeweled tip to his rod, the saving in the wear and tear of the line amply compensates him. For myself I am content with the ring shown in fig. 13. It is simply a bended wire, but so far as its efficiency is concerned, is quite equal to more elaborate contriv-

ances. Perhaps the best rings of the whole number are figs. 12 and 13—only do not hesitate to have them *large*.

Ferrules form an important part of the ordinary rod, and

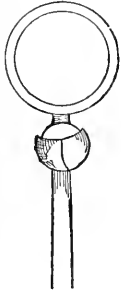

Fig. 11.



Fig. 12.



Fig. 13.

require some careful consideration.

It has been pretty generally thought that the shape of the male ferrule should be as shown in fig. 14—that is, provided with a dowel (A). This was supposed to render the joint more secure, and probably to render it more pliant and elastic.

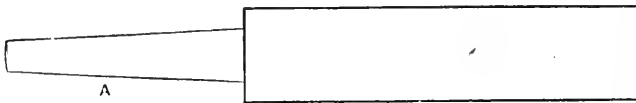

Fig. 14.

It certainly does not *allow* a joint to be secure, unless the latter is tied in, for the wedge-shape of the dowel is precisely the shape of all others most likely to loosen the joint in the act of casting, etc. In the most approved rods of the present day this dowel is, however, omitted, and thus we witness another return to first principles—for my father bought and made rods after this style at least twenty-five years ago, to my certain knowledge, and he always preferred the undoweled ferrule.



This ferrule is shown in fig. 15, and 1 and 2 in the diagram represent the points of contact between the male and female ferrule. Both at 1 and 2, plates of metal should be soldered, that the entire arrangement may be water-proof.

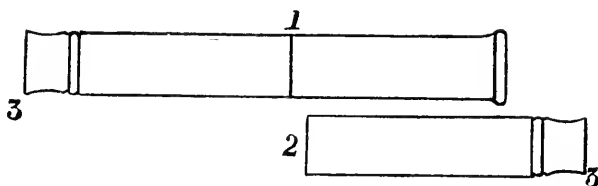

Fig. 15.

Most English rods, of this day, not only possess the dowel, but are so ill-fitted that the bayonet-fastening, screw, or loops of wire, at each end of ferrule, are necessary to keep the rod from throwing asunder. This is simply a confession of bad workmanship—there is no reason for it in the climate, as I have heard it plausibly suggested. The fact is, the ferrules are not “trued” one to the other, and they are not of the right material. Most of them are of brass, and very few are of german silver. This latter metal is the best for a ferrule intended to hold together by its own cohesion.

Of course the metal must be flawless and hardened—the tubing should be drawn inside and out—that is through an annular die, upon a highly smooth mandrel, and I prefer grinding the two parts together with very fine emery and oil and afterward rotten stone and oil, until the surfaces are absolutely smooth—so smooth in fact as to require quite a little force to put them into place. After these ferrules have been together a few minutes, and the condensed air has gradually found its way out, it is almost impossible to pull them asunder quickly, owing to the vacuum existing and the pressure of the atmosphere outside—in fact, in the ferrule made as I suggest, they form an actual pneumatic tube similar to that of the air-pump.

The weakest part of the rod has hitherto been at the junction of the ferrule and the wood—in a word, at 3, fig. 15. Ferrules made as fig. 15 represents at 3, “3”, are destructive. They are not fit for a fine elaborate rod, because, as no chain is stronger than its weakest link, so this weak spot is a blemish as bad as a spavin on a pacer. The rod is certain to give way at that point before it does anywhere else, and there is no help for it as long as the ferrule is of the shape shown.



Fig. 16.

All great discoveries are simple, and that shown at fig. 16 is at once simple and great; it is the ideal ferrule, and if I know it I will never purchase a rod without it. Unfortunately it is patented—though I presume the amateur will not find difficulty in getting permission to use it—and therefore only the best makers are licensed to use it. Precisely how this matter stands, I do not know.

It will be seen that the serrated edges do not bear on the wood at all to its detriment, but rather as a support; and at the same time they take off the strain which, were they not there, would come on the solid part of the ferrule just above them. The device is a perfect adaptation of the means to the end.

The ordinary reel-seat is confessedly inconvenient. It is shown at fig. 17 as now made, and it must be admitted that when the material is german silver it presents a handsome appearance. But it does not allow of various sized reel-plates being fastened, and herein lies the disadvantage. Notwithstanding the standard of sizes once adopted by the National Rod and Reel Association, few makers make it; and the result is that only one or two reels that you meet in a life-time fit the

reel-seat. Then again the band is forever working up, unless it fits very tight; and who amongst my experienced readers has not met with that awful catastrophe—a disengaged reel, just loosened at the period of greatest agony and excitement, when the fish is doing his best to run all the line out? Even now I could groan at the loss of one mighty *Salmo* at least, through this very cause.

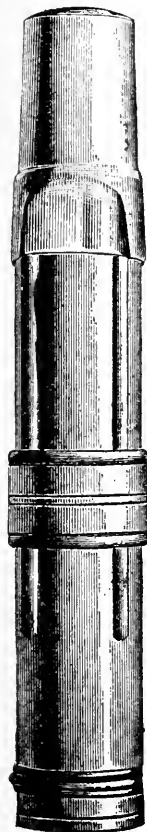
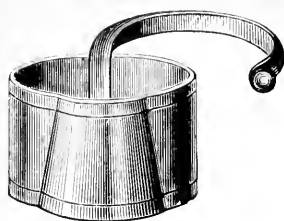

Fig. 17.

American ingenuity, however, comes to the rescue again (fig. 18). The upper and lower receptacle for the plate-ends are tapered—hence they can take from the least to the largest, and the upper band is movable. It is shown at A. Moreover, behind it is placed an ingenious clutch—which is shown out of gear in A, and in situ in the larger diagram (fig. 18). I have seen it on Trout, Bass and Salmon rods, and it works like a charm.

#### HOW TO MAKE A ROD.

In the following directions for the making of rods I shall purposely place myself in the position of a novice who has never made a rod, but has ingenuity and some mechanical aptitude. Machinery is rapidly taking the place of manual labor, and the various parts of most of the rods we see are made by that method. There is, however, great pleasure if not profit in the construction of the weapon with which you intend to slay the coming summer's monarch of the brook; and it will be all the more valued if its manufacture is completely your own—that is, as far as may be, for I do



A

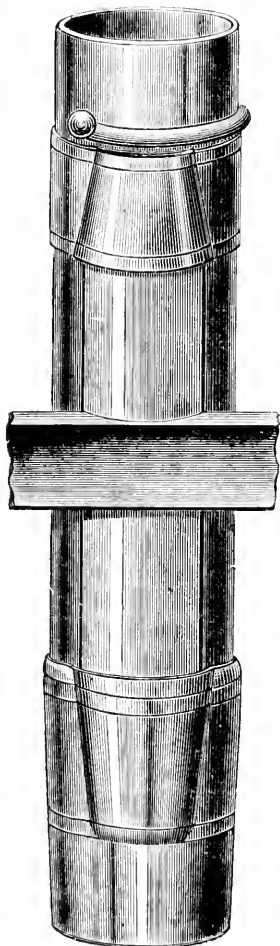

Fig. 18.

not think it advisable to describe the detail of ferrule and reel-plate making, when they can be bought so much easier than made. They can be obtained of any of the tackle-makers.

Perhaps the best rod for the novice to begin on will be a three-jointed, ten-foot lance-wood fly-rod. The difference between the make-up of a fine rod and one of inferior build, is great in effect as regards actual wear and tear, but in the manufacture there is little appreciable difference, on the principle that it is always nearly as easy to do good work as it is bad, and to make a fine fly-rod as one approximating to the so-called "pole" of our ancestors. As the tyro and myself intend to make the rod together, and as I imagine him to know absolutely nothing about rod-making, a word or two about tools are necessary:

These are neither elaborate nor expensive. First, it is desirable to have a good stout bench or table to work upon. It should also stand in a good light, and be of a height commensurate with that of the operator, so that he may incur as little fatigue as possible. A tired man at any task is seldom a minutely particular man, and it must be understood once and for all that eternal vigilance is the price of good rod-making. A vise is desirable also, but not absolutely necessary. One can generally resort to a neighboring

carpenter's shop for any vise-work he has to do.

First of all you should get three or four—three at least, good planes. I prefer the Bailey iron planes—and so does every rod-maker of my acquaintance—and the sizes are those marked in the catalogue of the Stanley Rule and Level Co. as No. 1, 6-inch; No. 5, 14-inch; and No. 50, 3 1-2-inch—the three costing in all about seven dollars. These are by far the easiest for the novice to manipulate and keep sharp.

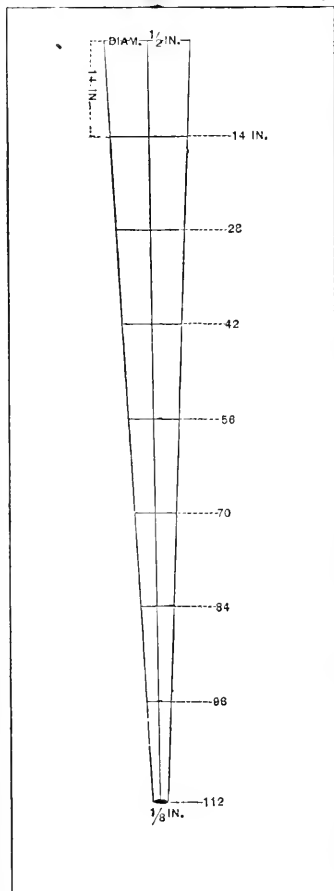

Fig. 19.

Suppose we say ten feet long over all. The handle is to be ten inches, which, deducted from 122 inches (ten feet) leaves 112 of rod now to be made.

How thick through should it be? Say, at the butt-

Files of several degrees of cut, and wood-rasps, sand-paper, broken glass, and some pieces of an old saw-blade, make up the really indispensable tools. The material—lance-wood—can be procured of Chubb, and he is very particular in picking out good pieces.

The first thing to do, when one has decided to build anything—from a hog-pen to a railway bridge—is to get out a working plan of the task to be done. My own usage always has been to take a piece of sheet-brass or copper, and true the upper edge of it square.

I then begin to think out the

end, where it goes into the handle, half an inch, and at the extreme end of the tip we will render it one-eighth of an inch (see fig. 19). How long shall each of the joints be? The first or butt, may be forty inches; the two others thirty-six each.

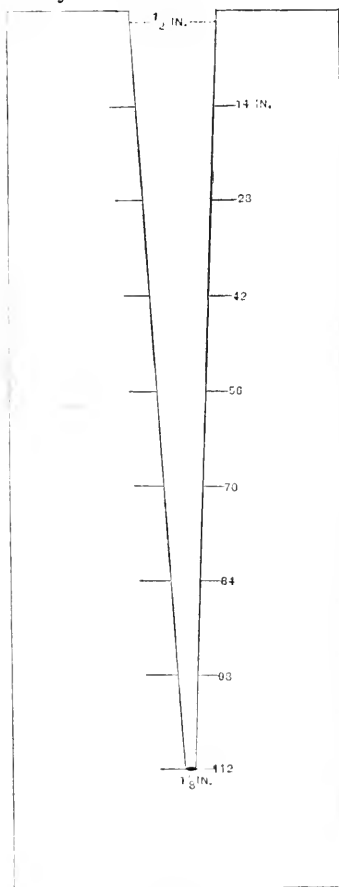

Fig. 20.

draw straight lines right across at each intersection, and the length of each of these lines represents the actual thickness your rod should be at each section. Thus fourteen inches from the largest end the rod is to be seven-six-

These dimensions being determined upon, I draw a perpendicular line down the brass or copper plate, with a sharp point of some kind, of almost any length. In the diagram it is four inches long. This represents 112 inches—the length of the rod. Now, across the upper end a line is drawn precisely equal to the diameter of the butt-end of the rod—in this case half an inch (see fig. 19), and at the lower end I draw another precisely equal to the diameter of the extremity of the rod or tip—in this case one-eighth of an inch. Now two lines drawn from the left and right extremities of the upper line to the left and right extremities of the lower line, represent a plan of the taper of the rod. Now take the compasses and divide this four-inch perpendicular into eight equal portions, each representing fourteen inches. Then

teenths of an inch; at twenty-eight inches six-sixteenths, and so on till, at the extremity, it is but two-sixteenths or one-eighth of an inch in diameter.

Having marked the plate precisely as shown in the diagram (fig. 19), and that very legibly, go to the next tin-smith and have him cut out the piece of marked diagram from the plate, reducing it to the appearance shown at fig. 20. You have in this simple device, a gauge of your rod from butt to point, and one of the chief difficulties is over. As you taper the wood under your hands you can bring it to gauge by passing it into the slit to its proper number. Thus at seventy inches in length it should be one-fourth-inch in diameter, and so on to the end.

The wood will come to us in square strips. Bore two holes right through the butt-end of each strip, so that when planing, the end can be slipped onto a pin driven into

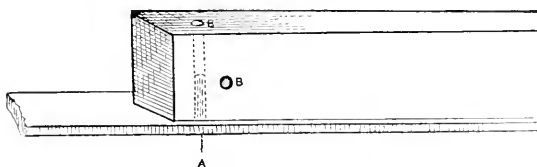

Fig. 21.

the table or bench (see fig. 21. A, pin; B B, holes). You can then plane from you, and will find it much better than if the upper end were fixed against a stay. In the latter case the wood (especially lance-wood) is apt to bend and get out of line owing to the pressure exerted upon it in pushing the plane.

First, plane one side perfectly smooth, then plane the opposite side; next take a right and then a left side, and so plane that a true square is preserved, no matter what taper is arrived at. You want a tapered square for the first joint that at the butt will just go in the gauge at the half-inch mark, and at the other end will fit just short of the forty-two-

inch notch. Having planed until you have got these measurements, you are ready for the next operation. (*Par parentheses*, each joint should be long enough to allow for the cutting off of the bored end.)

The next process is to convert the square into an octagon.

To do this you need a length of wood grooved out to the

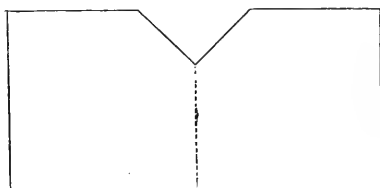

Fig. 22.

extent of a right-angle (see fig. 22) in which to lay the joint. It may be of one piece, or two pieces, glued together, the latter is easiest to make. Before placing the square joint, however, it is well to take up the ends and mark with pencil a true octagon, and cut with a sharp knife carefully to the

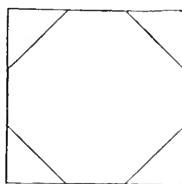

Fig. 23.

marks (see fig. 23). Then plane away, as before. Of course a constant constricting of the gauge is necessary in this as in the preceding process, so that none of the sides are untrue. The next process is, with the small plane to shave off the corners of the octagon, and further lightly shave until a round joint is approximated to. This rounding process can be continued with scraper, glass and fine sand-paper, till it is true and exactly to measurement.

I mentioned the pieces of old saw-steel in my enumeration



of tools. Here is just where their usefulness comes in. Fig. 24 represents a piece filed into semicircular hollows, with their edges made sharp. With this convenient tool you will find the process of obtaining a truly round joint greatly facilitated. Now test your material. Bend it with considerable force in different directions. If it resumes the original shape without *any* set, you are a very fortunate individual in possessing a piece of superlative lance-wood. If it "*sets*" badly, *hang* it up in a dry room for the next three months; it is not sufficiently seasoned.

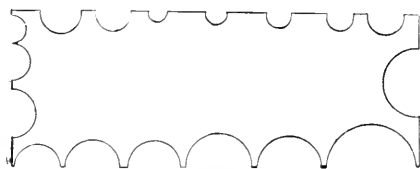

Fig. 24.

Now go to work and round up your other joints in precisely the same manner. The next operation is to fit the ferrules. The ferrules I recommend are those without dowelpins, and the female ferrule should be fitted on the wood with care, using the file and scraper for the purpose. Be very careful to evenly cut away the wood, so that they go on perfectly straight. Be also careful not to push the joint too far in the ferrule, but just enough to hold the male securely. Fig. 16 shows about the right proportion. It is well to give the wood plenty of room in the ferrules, which room or space is to be filled up with whipping and cement. This is to provide for the possible swelling of the wood. I have seen the male ferrule split and enlarged so that the rod could not be jointed together, owing to the tightness of the fit and the accidental immersion of the joint.

I have tried various cements, but have narrowed down my preferences to two: one is the liquid solution of India rubber or gutta-percha (I don't know which), termed, in the hardware stores, Prof. Callan's Brazilian Gum. A solution of

India rubber in chloroform is good, if this cannot be had, or a solution of the same material in bi-sulphide of carbon. These are of a family, and are about equal in merit—readily melted, if a break of the rod necessitates, and drying quickly when applied. The other cement is the same that I, personally, use as a wax in fly-making. It is thus composed: one ounce clear light resin; one teaspoonful oil (boiled is best); one drachm gutta-percha (sheet). Melt all together, pour into water, and pull as you would pull candy. Le Page's glue is also good.

Having prepared those parts of the joints destined to receive the ferrules so that there is a small but appreciable space left between the wood and metal, wind the wood with silk rubbed well with the cement. You will have already decided how far the ferrule is to go on the wood, and have wound the silk to that point. Now push on the ferrule, leaning the end against a firm wall or door-post. Do not of course use a mallet, but when you have got the ferrule on as far as you can get it by main force, light your spirit lamp and heat the ferrule or hold it over the hot stove coals till the inner cement is softened, and the ferrule itself somewhat expanded. Then push the ferrule into place, and it is a hundred chances to one against its ever starting, even in the driest weather. If ever it does, the operation must be repeated, using a little thicker silk and more cement.

Never under any circumstances drive a pin in to secure the ferrule—it is a source of weakness, and if you have to replace the ferrule it causes four-fold labor.

You have now got your rod to position where you can test its "feel"—its hanging and balance. It is not finally rounded off; and though you have "trued" it to a taper as far as you could, you have to correct crookedness and lack of balance—poise—in the hand. Joint it together and handle it. I go to the length of fitting on the handle (which I make separately, sometimes half-a-dozen at a time), and attaching reel and

line, and casting with the rod to see the kind of implement I have.

The changes to be made can scarcely be enumerated here, so much do they depend on the quality of the wood—the individual likes and dislikes of the user and his previous skill. A fly-rod should be stiff enough to have no droop in it—that is, for single-handed weapons. If it is unevenly elastic (and the best of lance-wood is that) it must be reduced, where it is stiffer, to adjust it to the strength of the most pliable part. Other points will occur to you as you go along, but be sure that your rod suits your hand. An ill-fitting rod is as bad as an ill-fitting gun, and both are abominations. If the joints crook at all, heat over a warm stove, and get the wood as you wish it, then tie to a perfectly straight steel rod for a time.

Having, with file, scraper and sand-paper, adjusted your rod, next proceed to smooth it with the finest sand-paper, using plenty of elbow-grease. A little finely powdered tufa (pumice) aids one to get a very smooth surface, and after this if each joint be rubbed briskly with a handful of good hard-wood shavings—those you have slivered off your rod, will do—the surface will be perfect for varnishing.

The next thing, however—before varnishing—to be considered, is the handle. Of course you can enlarge your lower joint if you choose, in the old-fashioned way; but I prefer the handle made of some nice-grained wood, such as sumach, or it may very commendably be a plain wood wrapped round at the grasp with flax-twine, well waxed, or covered, as one of mine is, with India rubber tubing—the hand never blisters, if this is used. These handles should be ten inches long over all, and the diameter should not be more than one inch at the largest “swell.” The interior of the upper part should be bored to receive the butt-end of the largest joint of the rod. This requires whipping and cementing with the same care as bestowed on the ferrule-fixing, and any ornamental whipping or banding at the junction is permissible.

Varnishing is now in order. I use coach-varnish, the best I can get; there is nothing better, and it is well to give it several coats, drying it each time in the air, in a bright sunshine, if possible. It should be thinned with turpentine till it flows readily from the brush, and a very thin coat should be put on, repeating it several times. When four or five coats are dried on hard they can be rubbed down with pumice and water (pumice-blocks ready prepared for the work can be procured) washing off every now and then to see how the surface is progressing. When sufficient has been done, rotten stone and water follows, and finally, dry rotten stone. Then wash to clear it entirely, and dry quickly. Then rub the rod with a handful of the finest tissue paper, pretty vigorously, changing the paper occasionally, and the result will be a brilliant polish. The same treatment applies to all kinds of rods if you desire a really handsome appearance. If that is a matter of no consequence an ordinary varnished surface will serve—indeed very few of even fine rods are polished as above described. The materials for the ordinary varnishing process are procurable of Mr. J. C. Chubb, of Post Mills, Vermont.

The making of a split-bamboo rod demands much higher skill and carefulness, but it is not so difficult as it appears, when one can readily and neatly finish a whole-wood one. It bears a relationship to simple rod-making similar to that borne by Salmon-fly making, as compared with ordinary Trout-fly manufacture. It is impossible for the absolute novice to make a Salmon-fly at first sight; and the same may be said of that fairy-wand, the modern split-bamboo fly-rod.

The cane generally used is the Calcutta bamboo, with the brown mottling, and only the last five feet of any stick is useful. In selecting it be careful to look it over for worm-marks; reject all canes that have that ominous boring in it, and select only those that are perfectly sound and not burned deeply—for the mottling is undoubtedly due to burning.

The whole process of preparing the split cane, by the large manufacturers, is effected by machinery; but in the present case we must be content to make the rod by hand, strictly; and the first thing is to split the bamboos for use.

Now take a cane in your hand and look it over. You will find that on two sides the knots possess little pip-like projections. On these sides the cane is useless for rod-making. You require, therefore, that part which lies between these two unusable parts.

Some saw the cane. I prefer to use a knife, and for this purpose I have placed an old carving knife in a stout wooden handle. By the aid of a mallet I split the cane end-to-end, and with care this can be done with surprising ease and precision, even with such a rough implement. Having done this, take the portions which are of no use for rod-making and try the flexibility and resilience of the wood. This will give you an idea of the worth of the parts you reserve for use.

Your split bamboo is now in your hands in the form of a strip with a rectangular section, and the object you have in view is the reduction of six of them to tapering sections of



Fig. 25.

exactly sixty degrees (fig. 25—also fig. 2, showing amount to be planed off), the rind to remain outside and untouched, and the apex of the triangle to be directly opposite the middle of the outer rind.

First pick out six strips for your butt, cut them off the length required (that is, an inch or two longer than the joint is to be), file the knots smooth, and endeavor to so select the strips that no two knots are near each other when the strips are glued in place.

Now the form of the completed strip is that of an equilateral triangle—i.e., each side is equal. If therefore you

decide that the butt-end of the first joint shall be one-half an inch in diameter, it is certain that you require six strips with three sides, one-fourth-inch each (see fig. 26). Your first operation therefore is to square your strips so that they are one-fourth-inch square. Remember, nothing must be

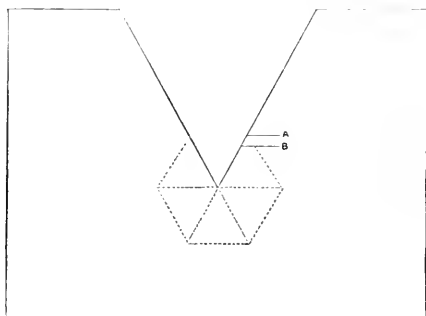

Fig. 26.

taken off the outer or rind side.

Now take a piece of sheet-brass and cut out an angle-piece of sixty degrees (see fig 26), and mark out the plan of your rod. I have already begun to do this, at A and B. A indicates the point to which the largest strip must come at its larger end. B shows the point for its smaller end. Mark the size of the ends of each of the other joints plainly, and keep this plan for gauging the final results. For pre-

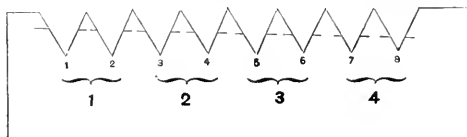

Fig. 27.

liminary results fig. 27 hints at a device that is most useful. This diagram is marked out for a four-joint rod, but the same principle is precisely applicable for the three-joint. A perfect guide is presented, in figs. 26 and 27, to the sectional make of the split-cane rod.

The planing of the strips to the exact pattern, so that each

one tapers truly, will tax all the care and patience of the operator. Having squared his six strips, he must make a four-foot block of hard wood with grooves of the angle shown in fig. 28. This had better be made in sections as shown, and joined together. In this case they can be planed to the correct angle with the planes you have; but if you do not mind the expense, you can, of course, have planes made to cut the grooves you want. If you are going in for making many rods this will be the better plan—it is not necessary,

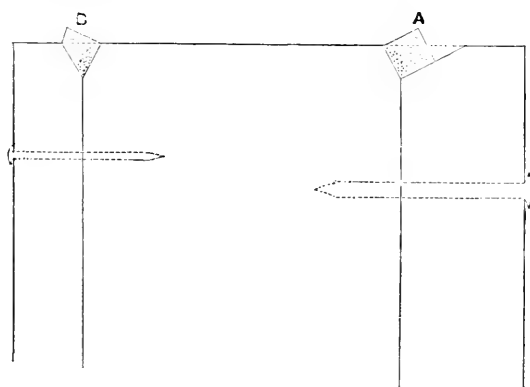

Fig. 28.

however, to the tyro. The groove must be of a depth to suit the plan of the rod, and should be of slightly *decreasing* depth to form the taper. Assuming that the grooved block is ready, lay the square strip in it and plane away, with great care, all that part above the dotted line in fig. 28, A. Having done this, place it in the left-hand groove, at B, and again plane it—of course not touching the enamel; and the result should be as shown at fig. 25.

Of course, the shape will not be quite correct. Take now a piece of saw-steel, and file with a triangular file several processes, like that shown in fig. 29. If you go to the trouble of marking them, as in fig. 27, so much the better for your correctness of angle and truth of taper. Place the strips

together as they are destined to be in the rod, every now and then, and so adjust them; but remember, the rod must be solid when glued, and to this end each section must fit its neighbor exactly. Use the file frequently, and always at right-angles to the grain, in fitting. Precisely the same process is to be gone through in regard to the other joints, with the addition of ever-increasing care as to detail, till the three or four joints are got out, and are ready for the next process, namely, gluing together.

A word as to the glue: Le Page's glue is the best I know,



Fig. 29.

but the ordinary Russian fish-glue is very good. Be careful to use it hot, and let your strips be warm also. Apply the glue with a brush rapidly, and glue in pairs first, and then the three pairs altogether next. Do this as quickly as possible, and then take a long piece of strong twine and wrap it rapidly and tightly around the strips in the same way as in the splicing of a Castle-Convill rod (see fig. 3), bringing the line back in a double coil, as shown at fig. 3, by the dotted lines. Let the joints dry in a warm room thoroughly. Any excess of glue on the outside can be scraped off when the wrapping is removed.

The most difficult part of the making of a split bamboo is now completed, and if you have been conscientious and thorough you will at least have a strong and even elegant rod, sufficiently enduring and presentable to encourage you to make another.

But the rod is as yet far from finished. After smoothing it off, the next operation is the ferruling. For the details of this you must refer back to what has already been said.



It is specially necessary to be careful with them, and to make them a good fit, to prevent water getting into the rod and so loosening it—this is of very rare occurrence, however. Having fitted the ferrules to your satisfaction, joint the rod and

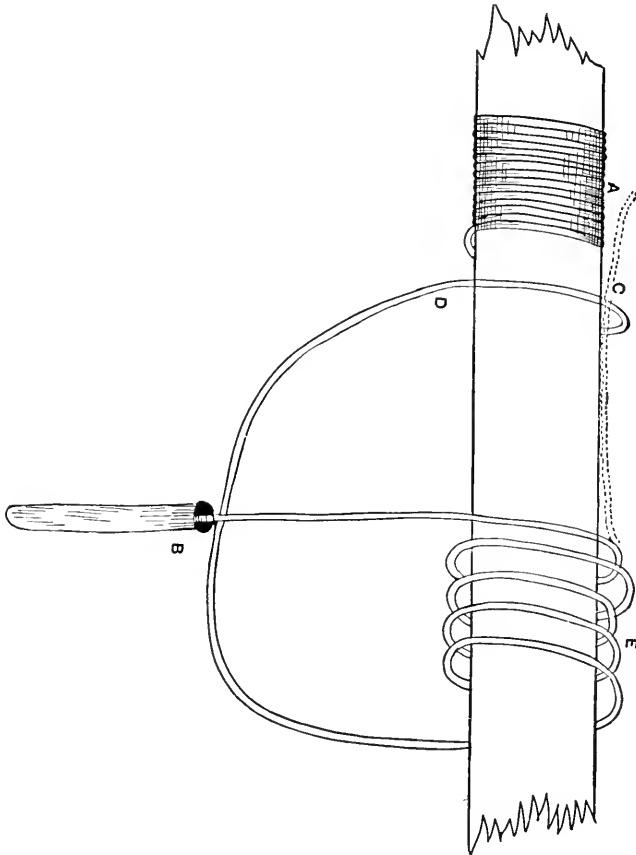

Fig. 30.

try it as recommended for the whole-wood rod; a little may be taken off either end, if you find the balance not quite to your liking, but no other alteration can be made.

The winding—by which is meant the whipping of silk

thread at intervals up the rod to increase its strength—and the tying on of rings or guides—is a pleasant task, though requiring patience. The chief thing about it is the knowledge of how to tie off, or in other words, form the invisible knot. If the learner will carefully look over the diagram (fig. 30) he will be able to puzzle this task out without difficulty. Let him take a piece of string and a stick and hold it in the left hand with the thumb uppermost. Now pass one end of the string under it with that end pointing to the right. Now bring the twine down under, up, and over toward him and over the end of the twine—placing the thumb firmly on it. Repeat this two or three times. Now to fasten off with the invisible knot. Still holding the thumb at A, insert the end of the thread in a quill and retain it there by means of a plug (B). Now pass the thread in a large loop to the right, and drop the quill over in coils as shown, three or four times; finally bring it up to C as shown in the dotted line. Now wind D side by side with A and over C, not too tightly, and as you turn the stick round to do so you will find all the coils (E) unwind, being transferred as a continuation of A. C will be laid underneath them, and all you have to do is to pull gently but firmly on C, and the knot is made.

The whipping should be at intervals of a few inches all down the rod, and may be of any-colored silk, waxed with either of the transparent waxes, or even with the cement given for ferrules.

Necessarily in the foregoing a great deal has been left to the reader's ingenuity. Mechanical operations are the very hardest of all to describe, but as each process is explained in exact accordance with my own first efforts, I am induced to think this chapter will be sufficiently comprehensive and detailed to be useful. I once visited Alcock's factory, at Redditch, where five hundred people are regularly at work turning out tackle, and saw the chief Salmon-fly tier turning out most beautifully finished "Jock Scots" at a rate that

astounded me. "What is the secret of such fly-making?" I asked. The answer came, paraphrasing Demosthenes' famous reply as to the secret of oratory: "Practice, practice, practice!" So I say, in concluding this chapter. Do not be discouraged by failure, by the tediousness and seeming difficulty of the task, by the possibly clumsy look of the finished rod, or by the lack of proportion. The secret, whole and entire, of pleasurable rod-making—in its facility and the beauty and satisfaction of the result, is "practice, practice, practice."



## REELS--THEIR USE AND ABUSE.

---

BY B. C. MILAM.

---

THE invention of the fishing reel dates back something over two centuries. The earliest mention of it, so far as I know, is in Baker's "Art of Angling," London, 1651. He says:

"Within two foot of the bottom of the rod, there was a hole made for to put in a wind, to turn with a barrell, to gather up his line, and loose it at his pleasure."

In the second edition of his work, the author says:

"You must have your winder within two foot of the bottom, to goe on your rod, made in this manner, with a spring, that you may put it on as low as you please."

In the "Compleat Angler," 1655, we read:

"Note also that many use to fish for a Salmon with a ring of wire on the top of their rod, through which the line may run to as great a length as is needful, when he is hooked. And to that end, some use a wheel about the middle of their rod, or near their hand, which is to be observed better by seeing one of them, than by a large demonstration of words."

The "Experienced Angler; or, Angling Improved," by Col. Robert Venables, 1662, shows, on its frontispiece, an illustration of the reel, as it was then made, and in the text the author says:

“The next way of angling is with a troll, for the Pike; you may buy your troll ready-made, therefore I shall not trouble myself to describe it, only let it have a winch to wind it withall, and when you may certainly conclude he hath pouched your bait, and rangeth abroad no more, then with your troll wind up your line, till you think you have it almost straight; then with a sharp jerk, hook him, and make your pleasure content. \* \* \*

“The Salmon takes the artificial fly very well; but you must use a troll, as for the Pike, for he, being a strong fish, will hazard your line except you give him length.”

From the character of these statements, we may safely conclude that the reel had but just been introduced, and was not then by any means well known. It appears, however, to have grown rapidly in favor during the remainder of the seventeenth century, and to have become recognized, by the beginning of the eighteenth, as a necessary article in every well-to-do angler's equipment. There are still to be found men who take fish with a hook, and who think they enjoy doing so, who adhere to the ancient float, and who scout the reel as a superfluous bit of modern extravagance. Such men, however, do not—cannot obtain the full meed of sport from angling. They are ignorant of one of the greatest sources of pleasure in either bait or fly fishing, namely, the music of the reel, the pleasure of taking and giving line, and the confidence and sense of superiority that the angler feels who holds the crank of his reel and watches the frantic leaps of the gamy Trout, the lusty Black Bass or the lordly Salmon.

No Angler's outfit is, complete therefore, without a good reel, and the better the reel, the more complete his outing and his summer pleasure will be. As the heart is the seat of life, and as perfect health depends upon its action, so the reel is the most important part of an angler's kit, and the success of his tours depends upon its good behavior. Nothing

can be more annoying, and I might say heart-rending, than to have your reel give way at a critical moment, when a "champion catch" is tugging away at the end of your line; or equally sad and terrible is it to have a handle drop off or a screw work out and be lost, when you are far away from shop and civilization, leaving you helpless as a "condemned soul without claws," to watch the sport go on and gnash your teeth in agony.

In order to avoid such misfortunes as above mentioned, and to furnish the Angler with an article he can depend on, a great deal of care and time, to say nothing of money, has been spent to perfect a reel to stand hard use and rough trips, and stay with him "from start to finish." In this broad land of ours, a man can find a reel, like everything else, to fit *any* purse.

There are many different kinds of reels made, of various shapes and at various prices; but when you get one because it is cheap, you must expect a very unsatisfactory affair, and must prepare yourself for many a troublesome accident; for a good article cannot be made cheap.

The cheapest is the common spool, with handle riveted *directly* to spool-bar; and the bearings of the bar at center of reel-plates. A good pattern of this form will allow you to cast fairly well, but when you begin to draw in your line, the trouble begins, for you lack speed. There are some styles of this spool made though, tall and narrow; this increases the diameter, and by mere size causes the line to be reeled in quite rapidly.

The click-reel is of this style, being a spool with a permanent click attached. This is used only for fly-fishing, where an easy, free-running reel could not be used, because the rod is caught above the spool and the line drawn off and whipped over the water.

Then there is the automatic reel. This implement handles the fish *literally* on its own hook, and a sports-

man who loves to feel his fish, and whose blood tingles when his rod bends and his line cuts the water, who revels in that honorable, just feeling, peculiar to all true anglers, when he puts his skill and generalship against the finny beauty's pluck, endurance and strength, could never use and enjoy this style of reel.

We have, in the next class, the multiplier. This class is as numerous as the sands, and the price varies according to material and workmanship. They are all made after the same style and upon the same principle, viz: a wheel working into a pinion, the pinion attached to the spool multiplying twice, four times, or even oftener. Some people are surprised when they hear that a fine multiplying reel costs seventy-five dollars or one hundred dollars; but when we explain that these extra fine ones are made of coin-silver, with gold slides and trimmings and jeweled bearings, the price does not appear extravagant.

The material generally used for their construction is brass, hard rubber, and german silver. By german silver, is not meant nickel-plated—for this is only a brass foundation, plated over with nickel, and after a short service, the latter rubs off, leaving an unsightly looking surface; but german silver is hard solid metal, the same color clear through, takes a high finish, and is about the best material used for making reels.

A perfect multiplier requires as much care in its construction and as skilled workmanship as the finest watch; and when you see an announcement that a firm is making an all-machine article, and have done away with "the old-time hand-made principle," you had better not go to this firm, for a lasting companion.

In 1834, fifty-five years ago, I saw the need of a first-class reel—one that could be relied upon, and that would always be found in order, I was then at the watch-making business. I spent several weeks at hard work, and at last finished a reel of as fine workmanship as I was capable of doing.



This was made of brass. I had hardly finished it, when a local angler who had experienced much trouble, came in and at once bought it for twenty dollars. He used it for a long time, and it proved so easy and so smooth, in operation, and stood the rough usage so well, that several other anglers came and ordered duplicates of it. So the "Frankfort, or Kentucky" Reel was first made.

Those made for local anglers found their way abroad, and a good trade has been built up on this class of reels. Anglers have found that a reel that is high-priced at first, proves cheapest in the end, for those made away back in the thirties, are good to-day, and have been in constant use ever since they left the shop. There is only one way to make a perfect whole, and that is to make each part perfect as you go. In the first place, you should get your metal rolled hard till it springs like steel. The caps and plates are then cut from this. Never should a casting be used; it is too soft, and a smart fall may break your cap, and render this part of your outfit useless. Bars are turned from the same hard material. Next, your gearing must be adjusted so that you feel not a bump, but a steady roll when the handle is turned and the weight is put on. The pinions must be of properly tempered steel, and the wheel of hard-hammered brass. Thus, all your parts gotten out, they must be put together with great care, so that when the thing is complete, it runs noiselessly and smoothly, yet the spool is free from shake or vibration.

The secret, in a long-lived reel, is the gearing. This must be made to absolutely roll. If there is the slightest friction the evil will continue to grow with use, and soon you will have a regular coffee mill. This is the part that requires the greatest skill in its construction.

The truest machinery will occasionally produce an imperfect tooth. After we have made our wheels with the latest and best gear-cutter, also our pinions, every pair is tested

and the least bump or jar is taken off with a file by hand. This requires experience and knowledge, and herein lies the superiority of our hand-made gearing. We expend more time and labor on our gearing alone than is used to make a complete machine reel; but after this is done, and done correctly, you are equipped for a life-time. We make eleven sizes, from 00 to 9. The 00 is one and one-fourth inches in diameter, and the 9, three and one-half. Nos. 7, 8 and 9 are for Tarpon-fishing and heavy sea-work, while 0 and 00 are fancy sizes, and too small for much heavy angling. Nos. 2, 3 and 4 are the sizes most used. We attach a click and drag so that our reels can be used for bait-fishing, fly-fishing or trolling.

A reel requires a great deal more care than many of them receive. We frequently get them in, for repairs, that have been used ten or twelve years, and that have never been oiled. A reel is a delicate piece of machinery, and requires oil and care accordingly, if you would get the best work out of it. Properly, it should be cleaned and oiled every fall, after the fishing season is over, and every spring before it begins. With a little care, one can clean the reel himself, and save time and money. First get a screw-driver, small enough to fit the screws on face-plate, then take the handle off first, next remove the top screws, then the bottom screws. Never touch the alarm and rubber screws; let them alone and they will take care of themselves. They are so arranged that you can get your cap off and not interfere with the blocks. So, be careful, for this is where you are likely to get into trouble, by taking out alarm and rubber blocks and not being able to put them in properly. It is best, as already stated, to let them alone. Now you have all the screws out of the cap, and you find the cap refuses to slip off. See if you have the rubber off; if you have, that is the cause; for the rubber block is under a spring that is screwed to the inside plate, and holds your cap fast; so slip the bottom, so

that the drag is on. Now try, and if you cannot pull the cap off put one of the top screws in the outside hole, in the one it came out of; don't screw it in, simply put it in as far as it will go, and then tap the head with the butt of your screw-driver, and your cap will drop off. Now take out the screw in the end of the top-bar, and your end-plate will come off, and your reel will be in pieces and ready to clean. Get a tooth-brush and some alcohol, and clean every part, and then take a piece of pine, sharpen the end and put in the first holes at the ends of plate and cap, cut off the lock dirt and put it in again, and again clean it till the stick comes out clean. Clean inside of wheel in same way. After you have your parts all bright, you are ready to oil. The great mistake made, generally, is in putting in too much oil. By doing this, you clog your spool and it will not run. Put one drop of good sperm oil in the first hole in plate, one in cap, two on pinion that reel runs on, one on end of drag-pin, and three on the teeth of the brass wheel at different points. Now put the parts up just as you took them down, and your reel is as free-running as when new. Do this every fall and spring, and a good reel will last fifty years.

No matter how tight-fitting your reel may be, you should clean and oil it after fishing in salt water—not every day, but after each salt-water trip, it should be cleaned and oiled, for nothing injures a reel so much as salt water. It fairly chews up the steel parts, so the salt water should not be allowed to stand long on a reel.



## PRACTICAL POINTS ON CAMPING OUT.

---

BY G. O. SHIELDS.

---

AS many of the best fishing waters are in the wilderness, reinote from hotels or even from farm houses and ranches, and as much of the best fishing can therefore be done only from camps, it is deemed proper to give here some general observations and instructions on the subject of camping out. What I shall say will be designed specially for young sportsmen, or novices in the matter of field sports, and yet it is possible that my thirty years of experience in wood-craft and mountaineering may enable me to say some things that will interest the "old boys," as well.

So many anglers are also devotees of the rifle or gun that it may not be out of place to cover, in so far as it can be done in a limited paper like this, the subject of camping in general, whether for hunting, fishing, or merely for fresh air, rest and recreation.

### CLOTHING.

Before camping come the busy notes of preparation for camping; and the first and most important question on this point is, "What shall I wear?" My answer to this question is, "Whatever you wear, let it be all wool." No matter at what time of year you are going out, whether in mid-summer or in mid-winter, in spring or fall; whether your destination

is Alaska or Florida, Canada or California, the Adirondacks or the Rockies, don't put on a garment that has a thread of cotton in it, unless it be in the way of overalls or overcoat. I say this advisedly, and you will agree with me when you have studied and experimented on this subject as long as I have. In fact, this rule should be rigidly adhered to, by every man, woman and child, the year round, at home or abroad. It is adhered to by every man and woman who has given the matter thorough and careful consideration.

Woolen underwear, especially, is cooler in summer and warmer in winter than cotton, linen or silk; does not stick to you when you perspire, and if you wear it you will not know one half the aches, pains and chills you have known while wearing either of the other fabrics. If you are caught out in a rain-storm and get wet to the skin, or if your boat capsizes and you have to swim, neither the water nor the air will feel half so cold to you if dressed in woolen as if in cotton. The woolen goods dry more quickly, and you suffer less than half the ill effects, in either case, that you would have suffered had you been clad in cotton. Observe the loggers, the raftsmen, the cowboys, the miners, professional hunters and trappers. They wear woolen the year round, and they ought to know what is good for them, for nearly their whole lives are spent outdoors and where they are exposed to various kinds and degrees of hardship. Go thou and learn wisdom from them. I have not worn a cotton or linen undergarment, at home or abroad, for years, and I never knew how to enjoy hot weather until I discarded those delusive "duds."

Select then for your outing two suits of woolen underwear—light weight if you are going in hot weather, heavy weight if you are going in cool or cold weather. Let your outside shirts be heavy-weight woolen, no matter what the weather is to be. Dark blue is the best color for these. Socks may be light or heavy, according to the season, and to your fancy,

but heavy weight is best if you are liable to get your feet wet. Six pairs of these and two suits of underwear will be enough for a month in camp. You can wash them or have them washed once a week, or oftener, if you choose. A coat, vest and trousers of almost any strong woolen goods may be worn. An old, cast-off business suit is just the thing. Plenty of pockets are desirable, and it is well to have two large inside pockets made in the skirt of your coat, which will be found useful for carrying your lunch, a pair of dry socks, a reel, and other bulky property. A canvas hunting-coat and a pair of canvas overalls may be worn over these if desired.

Personally, I prefer buckskin for hunting, in the late fall or winter. It resists brush and cold winds better than anything, but is likely to be sneered at by the "smart Alecks" in the rural districts.

In summer a light rubber coat should be carried; in fall or winter a Mackintosh is better. It should be made to reach nearly to your heels, and is about the only kind of overcoat that should ever be carried in the woods or mountains. A heavy overcoat is bulky, and is a burden to a man when hunting. If the weather grows extremely cold, put on your other heavy blue flannel shirt. It will answer the same purpose, and be much less burdensome.

If you are to sleep in blankets, a long flannel night-shirt, long enough to come below your feet, will add greatly to your comfort; but if you are to use a sleeping bag this will not be needed, and in fact it cannot be conveniently worn in the bag. In either case, take off all your clothing except undershirt and drawers. The old hunter's plan of sleeping in trousers, vest, and even coat, is not a good one.

About the best head-gear, for winter or summer, North or South, is a medium light-weight, light-colored felt hat with a moderately broad brim. This withstands all kinds of weather, can be rolled up and stuck in the pocket, in a war-

bag or valise, and is an adequate protection against the rain or the rays of the sun. A pair of ear-muffs should be provided, to wear in extreme cold weather. For mid-winter, in high latitudes, a thick, knitted woolen cap is good, and this should be large enough to come well down over the ears and back of the neck. A silk or light worsted skull-cap is sometimes needed when sleeping outdoors in cold weather, but should not be worn unless absolutely necessary. Never wear a fur cap when hunting, if you value your hair or your health. If you do so, your head will get hot when you walk, and the perspiration will run down your neck; you will take off your cap to get relief, and will get a cold in your head that is liable to last you a month.

As to foot-gear there is a great diversity of opinion among sportsmen. No boot or shoe has ever been made that was perfect in every particular for hunting and fishing. Rubber and leather are both objectionable, under certain conditions. No leather is suitable for wading, nor for walking in the woods in rainy weather or in wet snow, because no leather is water-proof; and none of the so-called water-proofing materials will make it so. They will render it partially so, for a time, but you may soak your boots in the best of it, then put them on and walk half a day in wet grass or wet snow and the water will get in all the same. As good a thing as any extant for all-round hunting and fishing, aside from wading, is a medium-weight leather walking-shoe with a heavy sole and a broad, low heel. It should be made to fit the foot, and if so made one may walk comfortably in it all day. You may be compelled to wade a creek or a swamp occasionally, and so to get your feet wet; but if you wear thick woolen socks, as already advised, no serious trouble is likely to result from this. You are not likely to take cold, your feet are not likely to be blistered, and you will be much less tired than if you had worn a pair of heavy leather boots.

For wading, for walking in wet weather, or in wet snow,



I have never found anything better than the Hannaford ventilated rubber boot, with rubber lining. If this boot gets wet inside, either from perspiration or from getting beyond your depth in water, take it off, pour out the water, and in a few minutes the boot will be dry again, and your socks and trousers are not dyed red, green or blue, as they would have been if the boot had been lined with felt of either color.

When the upper portion of the leg of the boot is not needed for wading, turn it down clear to the foot, then turn it and bring the upper edge to the top of the stiffened portion of the boot-leg. The lower end of the fold will now be midway between the knee and the foot. Give this two turns upward, and you have the surplus material neatly reefed in, just below the knee, where it will stay a week if desired, and give little trouble by catching on brush or other obstructions.

Felt boots are a favorite with lumbermen for winter-wear, and, with rubber shoes over them, make a comfortable foot-gear for extremely cold weather. Rubber wading-trousers and wading-stockings are good in fishing-waters, where there is little walking to do on dry land; but where there is much of this to do, they make the wearer uncomfortable because of the lack of proper ventilation. After walking a few hundred yards in them, either through woods or fields, in hot weather (and the weather is usually hot when men go Troutng) you will get so hot that you will wish you had never seen the pesky breeches, and that you had worn simply a pair of hip rubber boots. If the water be too deep for hip-boots, I prefer to wear simply a pair of old leather shoes, and to get wet; for if one be dressed wholly in heavy woolen clothing there is little danger of any serious results from getting wet.

For dry weather and dry land, winter or summer, in the woods, in the mountains or on the prairies, the most comfortable and serviceable of all foot-gear is a pair of heavy buckskin moccasins. It is the most natural, reasonable, per-

fect piece of foot-wear ever known to human beings. The only time I ever feel thankful to the man who invented Indians is when I get away from civilization and put on a

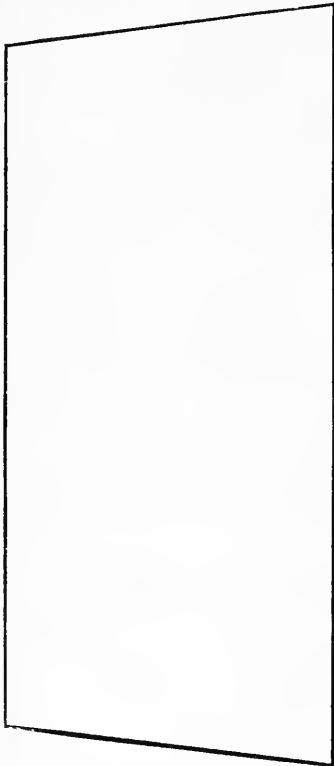

No. 1.

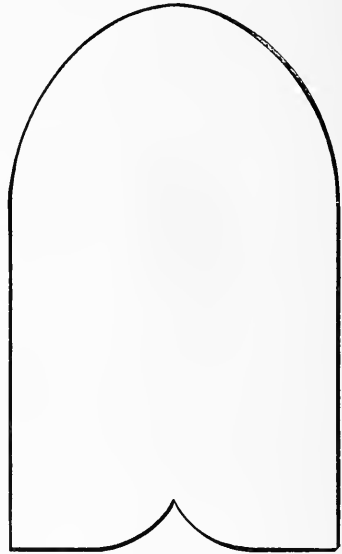

No. 2.

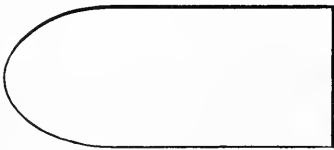

No. 3.

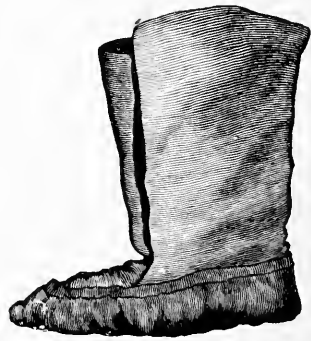

No. 4.

pair of moccasins. I then forget about my corns and other troubles, and wish I could stay in the wilderness forever.

For fall and winter-hunting they should be made large enough to permit the wearing of two pairs of socks, and if the rocks hurt your feet put a pair of sole leather insoles in the moccasins. The accompanying diagram will enable any glove-maker or shoemaker to make a pair.

If you wear leather shoes you will need, in addition, a pair of leggings. I have never seen a pair of these that I liked, and so devised an improvement on existing styles. I bought a pair of ordinary brown canvas leggings, that were made to buckle on the inside. I cut off the straps and buckles, and sewed on, at one side of the opening, a flap half an inch wide, in such a position that when the legging was wrapped tightly around my leg, one edge overlapping the other about two inches, this flap would nearly meet the outer edge. Then put eyelets in this flap and in the opposite edge of the legging. I now take two extra-long shoe-laces, splice them, and, beginning at the bottom, lace the leggings up as I would a shoe, and have a leg-gear that fits, sets easy, and has no hooks or buckles to catch in brush or weeds, and which, consequently, saves much of the annoyance that is inflicted on the wearer of any of the other styles in the market.

Buckskin makes about the best glove for all-round work, except for wet weather, and then a pair of rubber gloves will add greatly to your comfort. For hunting, in extremely cold weather, a heavy, loose yarn-mitten, that you can pull on over your buckskin glove, is invaluable.

Snow-shoes are indispensable for winter-hunting, either in the North-woods or in the mountains. Those made by weaving raw-hide thongs on a wooden bow are best. They can usually be bought of the large dealers in the cities or in the settlement or town nearest to the hunting country.

#### THE WAR-BAG.

And now that you have made up your list of wearing

apparel, you want something in which to carry that part of it that you do not put on at the start. The simplest, cheapest, and one of the most serviceable articles for this purpose is an ordinary seamless grain-bag. It costs twenty-five cents, and is more popular among loggers, freighters, cowboys, miners and other professional rustlers than any other "trunk" in the market. In such circles it is universally known as the "war-bag." Into it go boots, clothing, grub, ropes, tools and everything else that cannot be carried elsewhere. It is always ready and there is always room in it for something else. The only objection to it is that the thing you want is sure to be at the bottom of it; but it is the work of only a minute to dump the whole business on the earth, get what you want and stow the rest away again. It is well to put a coat of water-proof paint on the bag in-order that if caught in a rain it will keep your outfit dry. The rubber companies make a bag, of rubber or Mackintosh, that is thoroughly water-proof, and is an excellent thing to have in wet weather, or in case your boat capsizes when your worldly effects are on board; but it is rather expensive, costing about six dollars.

If, however, you are to travel entirely by rail or team, a trunk is admissible. It should be as small as possible, should be covered with raw-hide and well ironed. A small trunk may even be carried on a pack-mule, but it is a cruelty to the mule to put such a thing on him, and it is furthermore a constant source of annoyance to its owner and to the packer.

#### TOILET-CASE.

A valuable toilet-case is made of two pieces of drilling thirty-six inches long—one nine inches wide, the other eighteen. The wider piece is cut square at one end and tapered to a point at the other. The narrow strip is now laid through

the center of the wide one, sewed across each end and along one edge, being held full so as to shorten it to the length of the wide part of the longer strip. The space is now divided into a series of pockets, varying in width from one to six inches, by running seams through both thicknesses of the cloth. Now sew a yard of tape to the pointed end of the outer piece of drilling, bind or hem the raw edges of the goods, and you have a most convenient catch-all for your soap, towel, comb, hair-brush, tooth-brush, needles, thread, bachelor buttons, and various other small articles that would get lost anywhere else.

#### MOSQUITO-DOPE.

If going into the woods or mountains in summer, you will require a lotion to keep off mosquitoes and flies. Many preparations are sold for this purpose, all of which have more or less merit; but the objection to most of them is that they are not durable. They evaporate rapidly and have to be applied every half-hour or so. I have tried nearly all of them, but have never found anything that did the work so thoroughly as the following mixture: To three ounces of pine-tar add two ounces of castor-oil and one ounce of oil of pennyroyal. This mixture has a good body, an odor like a tan-yard, will last all day, and can be relied on to stand off any herd of mosquitoes this side of New Jersey. Those muzzles that are made of gauze and intended to be worn over your head are a failure. Several times while wearing one I wanted to spit, and forgot that I was muzzled until I got myself in a most uncomfortable predicament. When I wanted to eat or drink I had to take the measly thing off, and then the mosquitoes crawled down my spine and made me wish I were dead. Finally, while wading a Trout-stream, an overhanging limb caught the gauzy gaud, flipped it over into the next school-district, and I have never seen it since. Then I greased myself with my tar-ointment and was happy.

## BEDDING.

Too much care cannot be given to this subject. Next to that of a good suit of clothing it is the most important part of a camp-outfit. As I have before had occasion to say, I would rather get into a good bed at night, without my supper, than sit at a feast and then sleep on the hard ground without covering enough to keep me warm. After a hard day's work at tramping or rowing, a good night's rest is absolutely necessary to prepare one for the labor and fatigue of the following day. This can be had only in a good bed. You may possibly tramp all day with your feet wet—all your clothing wet, if need be—without injury to yourself; but be sure you crawl into a good, warm, dry, soft bed at night. Blankets are the staple article of camp-bedding, and you should never go into camp with less than two pairs of good heavy ones, even in summer; and in fall or winter the number must be increased as the temperature descends.

But the boss camp-bed for all times and all climes, for all tramps and all climbs, is a sleeping-bag. I would as soon think of going into the woods without my rifle as without my sleeping-bag.

The following description of it, taken from my book, "Cruisings in the Cascades," is re-printed here for the benefit of such as may not have seen it there:

The outer bag is made of heavy, brown, waterproof canvas, six feet long, three feet wide in the centre, tapered to two feet at the head and sixteen inches at the foot. Above the head of the bag proper, flaps project a foot farther, with which the occupant's head may be completely covered, if desired. These are provided with buttons and button-holes, so that they may be buttoned clear across, for stormy or very cold weather. The bag is left open, from the head down one edge, two feet, and a flap is provided to lap over this opening. Buttons are sewed on the bag, and there are button-holes in the flaps so

it may also be buttoned up tightly. Inside of this canvas bag is another of the same size and shape, less the head flaps. This is made of lamb skin with the wool on, and is lined with ordinary sheeting, to keep the wool from coming in direct contact with the person or clothing, and with one good heavy blanket inside, the whole business weighs but eighteen pounds. One or more pairs of blankets may be folded and inserted in this, as may be necessary, for any temperature in which it is to be used.

If the weather be warm, so that not all this covering is needed over the sleeper, he may shift it to suit the weather and his taste, crawling in on top of as much of it as he may wish, and the less he has over him the more he will have under him, and the softer will be his bed. Beside being waterproof, the canvas is windproof, and one can button himself up in this house, leaving only an air-hole at the end of his nose, and sleep as soundly, and almost as comfortably in a snowdrift on the prairie as in a tent or house. In short, he may be absolutely at home, and comfortable, wherever night finds him, and no matter what horrid nightmares he may have, he can not roll out of bed or kick off the covers.

Nor will he catch a draft of cold air along the north edge of his spine every time he turns over, as he is liable to do when sleeping in blankets. Nor will his feet crawl out from under the cover and catch chilblains, as they are liable to do in the old-fashioned way. In fact, this sleeping-bag is one of the greatest luxuries I ever took into camp, and if any brother sportsman wants one and cannot find an architect in his neighborhood capable of building it, let him write me and I will tell him where mine was made.

Good cot-beds are now made for camp-use, that fold into a small package, are light, but strong and durable, and if you have the means of carrying one, it is well to take it along, for it will add greatly to your comfort. If you have not, here is a map of one that you can carry on almost any

trip: Take a piece of eight-ounce duck-canvas, about six inches longer than yourself and forty inches wide. Run a hem on each side six inches wide—double-seaming it, on a machine, with the heaviest thread it will carry. Then when you get into camp take two poles, about three inches in diameter and a foot longer than your canvas, and run them through the hems; lay the ends in four good strong forks driven in the ground, or lay them on two logs and brace the ends of the poles apart with two sticks cut to the proper length to stretch your canvas tightly. You now have a good springy cot, on which you can spread your blankets or sleeping-bag, and sleep more comfortably, after a hard day's tramp, than you would on your woven-wire or spring-and-hair mattress at home, after being shut up in your office all day.

If you have plenty of transportation and don't take a canvas-cot, take a cotton or wool mattress. It need not be more than two feet wide and three inches thick. The weight is insignificant. The only question is that of bulk, and if you can take it along it will go a long way toward shortening the nights. As a substitute for this and the cot, carry an empty bed-tick. It weighs only a couple of pounds, and you will often find chances to fill it with straw, hay, or even with green grass, weeds or browse, any of which are better than nothing.

One way to provide for a comfortable night's rest, in extremely cold weather, is to build a big log-fire, let it burn several hours, then move it away and make your bed where the fire was. The earth is thoroughly heated, and by covering up the site and preventing—in a measure, at least—the escape of the heat, the ground will keep warm all night, and you may sleep as comfortably as if in a feather-bed at home.

A good soft pillow is also essential to a good night's rest. It costs but a trifle, weighs about the same, and takes up but little room. It may be loaded with corn-shucks or goose-



hair, the latter being generally preferable. If, however, you are traveling with a small pack-train, where every inch and every ounce of weight must be carefully considered, a good substitute for a civilized pillow is made by placing a couple of suits of underwear in a flour-sack. They should be folded carefully and laid in smooth, so that there may be no lumps or wrinkles, and in this way they make a very fair pillow for a tired man. When it becomes necessary to wear them, you wash your others and put them in the bag in place of those you have taken out.

The rubber pillow cannot be recommended. It is not so bulky as a feather-pillow, it is true, but is fully as heavy and not so comfortable to sleep on.

A rubber blanket is a good thing to have along to spread on the ground under your bed, if you do not use a cot, or to spread over your cot if you have one. It prevents dampness and cold from coming from the ground into your bed. It will also be found useful to roll<sup>o</sup> your bedding in while traveling, to protect it from rain and dust.

Two or three sheets of water-proof canvas, each four feet wide and eight feet long, are useful in camp for various purposes. One of them should be over your bed. It is good protection against cold winds and against rain, if you have to camp without a tent, as is sometimes necessary. Others are useful for covering up saddles and other property in camp, and to spread over the packs while traveling. When thus used they are called manteaus.

For winter-camping, in cold climates, a buffalo robe is useful, but under any other circumstances, is an unnecessary incumbrance.

If you have not a canvas-cot or a mattress, always procure pine, hemlock, fir or cedar boughs for a foundation for your bed, if in a country where they can be had. If not, then brush of almost any kind is better than the hard ground. If none of these can be had, get hay, straw, rushes, grass, or even

weeds—anything that will have some elasticity and relieve the solid monotony of mother earth. Remember that a good bed makes a short night, and *vice versa*. You had better work until ten o'clock at night in making your bed, than turn into a hard one at dark, and then groan with tired joints from midnight until daylight.

Some hunters condemn boughs as useless, and say they soon pack and become as hard as the ground itself. This is because they don't put down enough of them. Always lay them from a foot to two feet deep, and be careful to have no large limbs among them. In this way you will have a bed that will give with every movement of the body and that will remain soft all night—or a dozen nights in succession, for that matter.

#### CAMP-EQUIPAGE.

The first and most important article in this line is the tent. The size and style of this must of course depend, in a great measure, on the number of persons to occupy it and the kind and quantity of transportation with which the party is to be provided. If four men are going together and have a wagon, or a large boat, and no portages to make, or if they are to travel with packs and have plenty of them, then a wall-tent eight by ten, or ten by twelve feet, may be taken. In making up for the pack or boat outfit, the tent-poles should be jointed, the various joints being not more than three feet long. This is done by means of wrought iron strap-hinges screwed to one side of the pole, and two staples or strap-iron loops, one above and one below the cut, on the opposite side from the hinge, with a half-inch round iron pin passing through both. For a larger party of course a larger sized tent is necessary, and where it is possible to carry it, a Sibley tent, such as is now used by the United States army, is an excellent thing. But better than either is a round tent, after

the style of the Indian teepee. The one that I have used on several trips is eight feet in diameter on the ground, and eight feet high, tapered nearly to a point at the top, and having an opening there eighteen inches in diameter. One of the seams is split from the ground four feet upward, has flaps on either side, and strings attached with which to loop it up. This forms a door. The tent has loops at intervals of two feet all around the bottom, and a half-inch rope is rove into the edge of the canvas around the top-opening. It is made of a light-weight, firmly woven drilling, weighs only eight pounds, affords ample sleeping-room for two men, and storage room for their baggage. It is mounted on four or six poles (the latter number is best) eleven feet long, which are cut wherever night overtakes us. These are tied together six inches from the top-end, the ends are slipped through the top-opening of the tent; they are then set up, and the lower ends are spread so as to form a perfect square, if there be but four poles, or a hexagon if there be six. The tent is now pinned down tightly and is ready to live in. Jointed poles may be carried for this tent also; if so, there should be but three of them. These should be made fifteen feet long and in five pieces. They should in that case be made of heavy bamboo and jointed with strong brass ferrules, the same as are used for heavy bamboo fishing rods. They may then be placed outside of the tent and erected in the form of a tripod, the tent afterward being suspended to them by ropes attached to the small rope which encircles the opening in the top of the tent.

A fire may be made in the center of this tent when needed. Thus it proves a great advantage over a wall-tent, or any other style which will not admit of fire being made inside without a stove. A large, roaring, log camp-fire is one of the important elements of comfort in a camp, when the weather will admit of its being maintained and enjoyed; but there are times when it cannot be, on account of rain or severe cold,

and in such cases it is a great luxury to be able to build a small fire inside of the tent, crawl in, close the door and defy the elements. Mr. Orin Belknap, an old-time hunter and ranchman, of Thetis, Washington Territory, and well known to all readers of sportsmen's literature as "Uncle Fuller," devised a plan for feeding a fire inside a tent of this description, which he called by the name of a certain well-known cooking-range in the market, but which I have thought proper to rechristen the "Belknap Range." The plan is this: two trenches, six inches wide and deep, are cut from the outer sides of the tent running at right-angles to each other and crossing in the center of the tent. These are covered with bark or boards or flat rocks, except at their intersection. Here two green sticks, about two feet long and four inches thick, are laid at a distance of two feet apart; a piece of heavy sheet-iron or a large flat rock is laid on them and the fire built on this. The purpose of these trenches is to supply fresh air for the fire and thus create a draft to carry off the smoke, through the opening in the top of the tent. This arrangement has been found effective, and has afforded a great deal of comfort in many a bitter cold night, to "Uncle Fuller" and his companions, while hunting in the mountains.

If a wall-tent be used, then a sheet-iron stove should be carried along. There are several of these in the market—one at least intended solely for heating purposes, and others for both heating and cooking. Any tinner can make a good camp heating-stove. The best pattern is simply a cone with the pipe collar on the smaller end. This is placed with the larger opening on the ground; and near the lower part of it is a door about six inches wide by eight inches high. Four joints of pipe should be carried, each about twenty-two inches long, and made to telescope so that when packed they are but little longer than one joint would be. The stove may be made in any desired size, but one of about eighteen inches in diameter at the mouth and eighteen inches high, will, if

well fed with good dry wood, roast you out of a tent twenty feet in diameter when the mercury stands forty degrees below zero.

Camp cooking-stoves are made either solid or to fold up, but the former pattern is on the whole most desirable. The size of this would also be regulated by the number of hungry men to be fed from it; but by economical use a stove twelve inches high, sixteen inches wide and twenty-six inches long, with four holes and an oven, will furnish cooking capacity for six men. Little space need be occupied by the stove, for in packing for transit you can fill both the oven and fire-box with tin-ware and cooking utensils. The stove should be packed in a strong box or trunk, made for the purpose, with metal corner-pieces, handles and lock. It can then be checked on railroad trains as other baggage, and may be placed on a pack-animal or hauled in a wagon over any kind of road without injury.

Another important item in almost any camp outfit is a boat. If the chief object of the expedition be fishing or duck-shooting, or if for any reason a large portion of the outing is to be on water, where boats are not kept for rent, then this item will be one of the first to be considered, and substantial lap-streak or other wooden boats would be provided. But if the trip is in search of large game there is scarcely any section of the country likely to be visited in which a boat of this character could be carried conveniently, and yet a boat is sure to be frequently needed. Lakes or streams are likely to be encountered where some kind of a craft would be a welcome accessory for fishing, exploring or for reaching desirable hunting grounds, that would otherwise be inaccessible. Canvas folding boats are now made that are so serviceable and seaworthy that I should never start on a hunting trip, in any country where I expected to find much water, without one in my outfit. One of the best of these, so far as I know, is made by N. A. Osgood, of Battle Creek, Mich.

His No. 2 boat, which is twelve feet long, three feet wide, and weighs when light-rigged but twenty-eight pounds, folds into a package sixteen inches in diameter, three feet long, and is capable of carrying 600 pounds.

A photograph camera is another essential element of the pleasure of almost every party in search of either fish or game. In the selection of this instrument of course you must consider your bank account and the question of transportation. A tripod camera, that will make a five-by-eight picture, fitted with a twenty-five dollar lens, is desirable, but is both bulky and expensive. A good detective camera, carrying a four-by-five plate, is sufficient for recording all the choice bits of scenery, views of camp, fish, and game, and for making portraits of the party, of a satisfactory quality. These vary in price from ten or twelve dollars up to one-hundred dollars. The little Kodak, and the Waterbury, are good for the prices at which they are sold; but if one's means will admit of a larger outlay, then it is better to have an Anthony instrument, costing, when fitted up with roll-holder, about eighty dollars. Glass negatives should no longer be thought of for outdoor work. Celluloid is now prepared for this purpose, and works so successfully as to effectually displace glass for all time to come. No chemical outfit need be carried for developing plates in camp. This part of the work should be deferred until your return to civilization. Photography has been so simplified of late years by the introduction of the dry-plate process, and by various other improvements, that by careful study of the little book entitled "How to Make Photographs," which is furnished with each camera, and a few days devoted to making experiments, any person of ordinary intelligence may learn to make fair pictures. Of course it requires years of careful study and practice to become an expert photographer; but such is not the aim of most persons who take up the subject simply as an adjunct to hunting and fishing, and to make such pictures as would be sat-

isfactory to most people under these circumstances, I repeat, but little study and practice are needed. A strong, solid trunk should be made for the camera, into which it should fit snugly, and be protected from concussion by pads of cotton or wool. Apartments should be made at one end of the trunk to hold the celluloid rolls and such other items as may be provided to carry with the camera. The trunk should be thoroughly ironed and provided with handles. It may then be checked as other baggage, without fear of injury to its contents. A rubber bag should also be provided, into which the camera can be inserted for carrying it short distances, as a protection against rain.

Another handy item in a camp-outfit is a pack-strap.

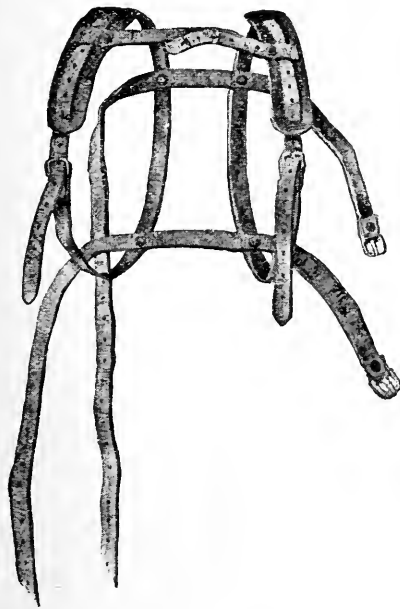

This is a kind of human harness, made to fit over the shoulders, and with straps attached, for buckling up the roll of bedding, clothing, or whatever else is to be carried. The accompanying diagram will enable any shoemaker or harnessmaker to make one. This strap is often useful in carrying a light outfit into the woods or mountains, or for carrying game out of sections of country where a horse cannot travel. Each man should carry, when tramping or riding in the country, a rubber

drinking cup. He should also advise his companions to do likewise. This thing of all having to drink out of one cup is not always pleasant, and often entails unnecessary delay when crossing a stream.

A generous supply of rope should be provided in every camping outfit. It will frequently come in demand for various purposes. Not less than fifty feet each—of quarter-inch and half-inch—should be provided, in addition to the picket ropes, tent ropes, etc.

Each man should carry a field-glass. It is one of the greatest luxuries imaginable for a trip on the mountains or plains, and will often come into play in wooded countries. By its aid rocks are often turned into living animals, and *vice versa*. Elks or bears are often found to be only cattle or horses; and domestic sheep sometimes turn out to be antelopes. A clear pool of water is often transformed into a dry bed of alkali, and a white rock sometimes proves to be a wild goat. The glass is useful in hunting lost horses and in looking out favorable camping grounds. It saves an immense amount of riding and walking, and pays for itself once a week regularly. While you are buying a glass get a good one. It will cost twenty to thirty dollars, but will prove a good investment.

A good compass is another important item. It should cost two to three dollars, and should be set in a nickel or silver hunting case.

No man should ever go into the woods or mountains or on the plains without a water-proof match-box. And yet, strange as it seems, there is no such thing in the market. There are several which purport to be water-proof but are not thoroughly so. You can get a surgical-instrument-maker to make one out of a piece of brass tubing, say three-quarters of an inch in diameter and about two and a-half inches long.

A convenient and serviceable camp-kettle is made of heavy galvanized iron, and if intended for three or four men should be ten inches in diameter and sixteen inches deep. It should have a  $\frac{1}{4}$ -inch wire around the top, a bail of the same size, and heavy malleable iron ears. If built on these



specifications it may be packed on a horse, and if properly placed in the pack the lustiest packer in the mountains may cinch it until he turns black in the face, and cannot hurt it.

Two tin pails, made of heavy block-tin, should be made to nest in this kettle. They should be nine inches in diameter and eight inches deep. They should have flat covers, that fit tightly, with small movable iron rings at the sides, below the cover. Then when you desire to cook dried fruits, rice, oatmeal, farina, beans, and other food that is liable to scorch when cooking, in an ordinary camp-kettle, you can place it in one of these pails, put in with a sufficient quantity of water, fit the lid on, fill your camp-kettle half full of water, drop three or four pebbles in the kettle, set your tin-pail in on them, put a rock on top of it to hold it down, then put your camp-kettle on the hottest fire you can make, and let it hump itself until dinner is ready. Now take out your tin pail, take the cover off, and your rice, fruit or whatever it may be, will show up as clean and as deliciously cooked as your mother, wife or sister could cook it at home. If you cook more than you need for one meal, and are to move camp before the next, fit the cover on the pail, set it in the camp-kettle, and the cooked rations will ride to your next home as well as though they had not been cooked.

You will need one or more large frying pans with flat wrought iron handles. When cooking on a big fire you can cut a stick two or three feet long, split the end of it, slip the end of the iron handle into the split, wrap the stick with a cord, and then stand so far back from the fire that your meat will fry before your face does.

You should also carry a good-sized wire broiler, made double so that the meat can be laid on one part and the other will fold down on it. The two handles fasten together with a running ring. The handle may be spliced out with a split stick the same as the frying pan. A half-inch board should be cut, of a size slightly larger than the broiler, to

fold in it when packing, and to keep it from being crushed in the pack.

If traveling with teams and without a stove, a "Dutch oven" will be found useful for baking bread, meats and vegetables. But if you travel with pack animals, canoes or mackinaws, it will be found cumbersome; and in all such cases it is better to depend entirely upon the frying pan for baking, and on this, the camp-kettle and broiler for cooking meats and vegetables.

The coffee-pot and tea-pot should be made of heavy block-tin, with pressed lid. The handle should be riveted on and the bail attached by heavy malleable iron ears.

Plates and cups should also be of block-tin; the latter should be pressed, should have the handles wired on at the top and loose at the bottom, so that any number of them will nest. Knives and forks should be of steel—not cast iron, and the former should be kept sharp enough to cut meat without generating profanity.

The ax should be a full-sized one weighing about three pounds; should have a full-length handle; and should be carefully muzzled so that it will not cut up any other articles in the pack or in the wagon. A good muzzle is made of sole-leather, fastened with copper rivets, and should have straps to pass around the pole and over the handle and then buckle.

I never could see the value that many hunters attach to a hatchet. A large hunting knife will do almost any work that a hatchet will do, and much in the way of cutting up game, etc., that it will not do. When there is a log to chop off or a tree of considerable size to cut down, I want a full-grown ax. Even when canoeing or tramping in the woods I carry an adult ax.

It is possible to dispense with a number of the articles enumerated in the foregoing pages, when it is desirable, from any cause, to travel very lightly. For instance, when traveling on foot, in a big woods, and carrying the entire outfit

on your own back, you will find that you can get along with a limited supply of bedding, extra clothing, and cooking utensils; and for such work it is almost impossible to give absolute instructions. Each man must act in a measure on his own judgment, his own taste, and his own willingness to carry a big load or to live like an Indian. One cannot be too careful in sifting out all unnecessary articles, in a case of this kind. It is possible for a man to go into the woods and live in comparative comfort for a month with no other outfit than a gun, a supply of ammunition, a pair of blankets, a few fish-hooks, a line, a bag of hard-tack and two pounds of salt.

In nearly every company of three or more men will be found one who, if not a professional mechanic or artisan, is at least handy in the use of tools. When possible, such an one should carry with him a kit of tools and materials, such as are most likely to be needed for repairing possible injuries or breakdowns that may occur to guns, fishing tackle, boat, harness, wagon, cooking utensils, or other portions of the camp-outfit. This kit need not be complete, however, nor expensive, for under compulsion an ingenious mechanic may make one tool answer several purposes. He may draw on nature for many implements and materials needed, if he have not brought them with him. The kit should include one of the latest and largest tool-holders, which has a thumb vise attached, and contains brad-awls, chisels, screw-driver, file, and several other tools in the handle. The list should also include a pair of strong pliers, a hammer, small hand-saw, two or three shoemaker's awls, a harness-needle, and a sail-needle. Among materials to be carried should be a strip of thong-leather, a piece of strap spring-steel, and half a pound each of Nos. 18 and 24 copper wire; a few wire nails, and brads,—assorted sizes, a few horseshoes—assorted sizes, a few horseshoe nails, a few screws, and a supply of the component parts of each rifle and gun carried by members of the

party. All these except the saw should be carried in a stout canvas-case, made after the same pattern as the toilet-case described on page 26 of "Camping and Camp Outfits."

It should be made large enough to hold, in addition to these articles, the reloading tools, if any are to be taken along, though as a rule it is not advisable to carry them. The saw should be tied between two thin pieces of board, of the proper size and shape to hold it so that the teeth can not come in contact with any other object.

A temporary vise may be made anywhere in the woods by cutting down a small tree and splitting the stump in the center. You can spread the jaws open with the ax, insert the article you wish to work on, and then, if the pressure should not be sufficient to hold it firmly, put a rope around the stump just below, rig a tourniquet, and turn it until you get the proper pressure.

#### GUNS AND RIFLES.

On this subject there is really little that can be said in a paper of this character. It is presumed that every man who reads this book has already formed his idea as to the best arm for his use. This must of course depend on where you are to go and what kind of game, if any, you are to hunt. It is presumed, furthermore, that nearly every man who goes on a camping trip of any kind, either for pleasure or on business—and even if the principal business is to be fishing, or resting—is to carry a firearm of some kind; for in nearly every wild country there is game, either large or small, and nearly every man likes to shoot at it when he sees it. Personally, I prefer a large-bore rifle for all kinds of large game, and recommend nothing smaller than a 50-caliber for anything from deer to moose and bear. There are those, however, who object to carrying so heavy an arm and such heavy ammunition. Deer, antelope, and even larger game may be killed, and often is killed, with a 32, 38, or 40-rifle;

but unless hit in a vital part an animal shot with either of these is liable to run a long distance before giving way, and many animals, although killed, are thus lost. I consider it more humane and sportsman-like, therefore, to use a 50-caliber express, which will kill the game dead in its tracks if fairly hit.

If one is not expert in the use of the rifle and prefers to use the shotgun, he will of course in most cases have made his choice as to the make, size and weight of the gun. In this line I prefer a 10-bore, and heavy charges for all game larger than quails and snipe. As already stated, I advise for either class of arms the carrying of a full supply of loaded cartridges, and that reloading tools be left at home.

If you carry your cartridges in a belt you should be provided with suspenders, bringing the weight on your shoulders instead of at your waist. To this belt should be attached—if you are hunting big game—the scabbard containing your heavy hunting knife, skinning knife and steel. For wing-shooting the better plan is to wear a vest with cartridge-holders distributed over the front. If going long distances, you should provide for your guns heavy wooden cases, with lock and key, and well ironed, so that they may be checked with your other baggage.

#### FISHING TACKLE.

This is another subject that may not here be spoken of at length, for reasons stated in the chapter on guns, and for the further reason that my colleagues have prescribed the kinds and qualities of tackle needed for taking every variety of fish treated of by them. It may be briefly said that if one is going into the Far West he should carry both a fly and a bait rod. These should be packed into a strong wooden case that may be carried in a pack, and cinched tightly, or may be thrown into a wagon and buried up in boxes of grub

and other bric-a-brac without danger of injury. If on a special hunting trip, take as little other fishing tackle as possible. What you do carry should be in a wooden box. Your tin tackle-box is no good for the wild and woolly country.

#### PROVISIONS.

The question as to what kinds and what quantity of food to carry on a camping trip is perhaps more difficult to settle satisfactorily than any other that besets the sportsman when preparing for an outing. In making up his commissariat he must of course be governed by the number of men that are to make up the party, the length of time the trip is to occupy, what is to be its means of transportation, and how much of that is to be provided; where the party is to go; whether the trip is to be in quest of fish or game or both. If you are to travel by team, over good roads, you may of course carry a much more elaborate bill of fare than if by pack-train, by canoe or on foot. As a rule, however, only plain substantial food should be taken into camp. This is the kind you will crave, the kind you will need, and delicacies should be left at home. As a rustler once expressed it, "Pie and cake are good enough at home, but they don't climb the hills worth a d—n."

Cancel all the knickknacks on your list at the start, and give your stomach a rest during your outing. You doubtless need a chance to recover from the ill effects of the rich food you have been living on for years past. Bread, meat, vegetables and fruits are the staples that you will require when you come to climb the hills, tramp over the prairies, wander in the dense woods, or pull on the paddles. How to make up a list of edibles suitable as to quantity, quality and variety for a given number of days in the woods is therefore a serious question, to those who only go into the woods occasionally. To the old-timer it is the work of but a few min-

utes. He knows by experience just what he wants to eat and drink, and how much of it he will need per day. His requisition on the supply-store, for a month's trip in the mountains, is usually 50 pounds of flour, 25 pounds of bacon, 2 pounds of salt, 5 pounds of tobacco, and 5 gallons of whisky; but a man of temperate habits would make an entirely different selection.

As to quality, buy the best of everything; it costs but little more than an inferior grade and the best is none too good for an honest man, when hard at work. As to quantity and variety, no better guide can be given than the army regulations regarding the soldier's ration. This is made up as the result of years of study and practical experience, by men whose lives are spent largely in camp, and who have learned to a nicety what an ordinary man, engaged in active outdoor work—or play, for that matter—requires to keep him strong, healthy and happy. The lists of provisions appended to this chapter are based on the figures given in the army regulations as constituting the soldier's daily ration; and any man who has had the good fortune to fall in with a party of soldiers when engaged in partaking of a meal, well knows that they live on the best, for their purpose, that the land can afford.

If you are sure you are going to find plenty of game or fish, you can reduce the figures given as to the supply of meat materially. But don't be too sure on that point. This world is full of disappointments for hunters and anglers. You have heard of men going for wool and coming back shorn.

Unless you are going to have a permanent camp, that can be reached by good wagon roads, don't carry any canned fruits. They are a delusion, and are two-thirds water. The chances are, you will get better water where you are going, and save the freight. Fruits are dried or evaporated nowadays in such an excellent manner that there is no need

of carrying them done up in tin and water. These remarks apply with equal force to the popular Boston fruit—canned beans. All provisions should be put up in good strong canvas bags, or in wooden or tin boxes. Never risk paper packages on a camping trip, or you will very likely find your sugar, salt, coffee, beans and other staples sadly mixed.

#### WHISKY.

Don't take any. The guide, packer or cook is sure to steal it and get drunk, if you don't keep it under lock and key, and you and your friends are better off without it.

There are many other points that I should like to treat of but have not space to do so here. I must therefore beg modestly to refer the reader to my book, "Camping and Camp Outfits," wherein exhaustive details are given on all points pertaining to this subject.

#### CHECK-LISTS.

##### *Of Articles Constituting Camp-Outfits, for Various Seasons and Under Varying Conditions.*

With reference to the first of the following lists it may be noted that a strong man can carry fifty pounds ten or fifteen miles a day comfortably, when accustomed to this kind of labor. If traveling by canoe the only addition necessary to make to the loads, in case of portages, would be the canoe and paddles. If no long portages are to be made, a photograph camera should be added to the list, and a few luxuries may be taken along; but they should be such as are light, and take but little room.

The total weight of such articles, enumerated in the second list, as are to be carried on the pack-animals, is about 320 pounds, or 160 pounds to each animal. With these loads they will travel comfortably twenty to thirty-five miles a day. As the provisions and cartridges are used up, skins, heads or other trophies may be added to the load in their stead. No



animal should ever be allowed to carry more than 250 pounds, and small ones not more than 150 to 200. Overloading is cruel and is nearly sure to cause sore backs.

SUPPLIES FOR TWO MEN FOR A TEN DAYS' TRIP ON FOOT.

---

10 pounds hard bread.	2 belts and hunting	1 coffee pot.
12 pounds bacon.	knives.	2 tin plates.
3 pounds dried apples or	2 pocket knives.	2 spoons.
peaches.	1 axe.	2 tin cups.
2 pounds salt.	1 tent.	1 dish cloth.
3 pounds sugar.	2 pack straps.	2 pounds tobacco.
2 pounds coffee, roasted	2 suits extra underwear,	2 pipes.
and ground, or	in bags.	1 map.
$\frac{1}{2}$ pound tea.	4 pairs socks.	300 matches.
2 sleeping bags, or	2 rubber coats.	2 water-proof match
blankets.	2 compasses.	boxes.
2 rifles or guns.	2 watches.	2 ounces insect lotion.
100 cartridges.	1 camp kettle.	2 cakes soap.
2 fishing rods.	1 frying pan.	2 towels.
2 reels.	1 wire broiler.	2 tooth brushes.
Hooks, lines, flies, reels,	1 stew pan.	Supply of small change.
etc.		

Total weight about 90 pounds.

It is possible to curtail this list slightly, but not without some sacrifice of comfort.

SUPPLIES FOR TWO MEN FOR TEN DAYS, TRAVELING WITH  
TWO SADDLE HORSES AND TWO PACK  
HORSES, SUMMER OR FALL.

---

2 saddle horses.	12 flies, assorted colors.	2 tin cups.
2 pack horses.	2 sleeping bags, or	2 dish cloths.
2 riding saddles.	3 pairs heavy wool	1 box matches.
2 pack saddles.	blankets.	2 water proof pocket
2 bridles.	2 pillows.	match boxes.
4 saddle blankets.	1 tent.	20 pounds flour, or
4 picket ropes.	2 sheets, canvas.	15 pounds hard bread.
2 sling ropes.	2 suits heavy woolen	14 pounds bacon.
2 lash ropes.	clothes.	3 pounds dried apples or
2 cinches.	4 heavy woolen under-	peaches.
2 manteaus.	shirts.	3 pounds oat or rye meal.
50 feet quarter-inch rope.	4 pairs heavy woolen	3 pounds beans.
50 feet half-inch rope.	drawers.	3 pounds rice.
2 gun slings.	4 heavy woolen outside	2 pounds salt.
2 rifles or guns.	shirts.	$\frac{1}{4}$ pound pepper.
200 cartridges.	6 pairs heavy woolen	3 pounds sugar.
2 cleaning outfits for	socks.	2 pounds roasted and
guns.	2 light felt hats.	ground coffee, or
1 small can of oil.	2 pairs buckskin gloves.	$\frac{1}{2}$ pound tea.
2 belts.	2 rubber coats.	2 pounds desiccated vege-
1 axe.	2 pairs rubber hip boots.	tables.
2 hunting knives.	2 prs. heavy leather shoes.	2 pounds tobacco.
2 skinning knives.	2 bags to carry clothing	2 pipes.
2 pocket knives.	in.	2 toilet cases, each con-
2 steels.	4 pairs buckskin moccas-	taining soap, towels,
1 map.	sins.	tooth-brush, needles,
2 compasses.	1 camp kettle.	thread, buttons, safety-
2 watches.	Stamped envelopes and	pins, and other small
2 pack straps.	paper.	articles.
2 prs. goggles or smoked	1 frying pan.	1 kit tools and materials
glasses.	1 wire broiler.	for repairing camp
2 pairs ear muffs.	1 stew pan.	equipment, etc.
1 photograph camera.	1 coffee pot.	4 horse shoes.
3 dozen celluloid plates.	2 tin plates.	1 pound horse nails.
2 fishing rods.	2 spoons.	2 pounds powdered alum,

2 reels and lines.	2 knives.	for curing skins.
12 bait hooks, assorted sizes.	2 forks.	Supply of small change.

---



---

SUPPLIES FOR TWO MEN FOR TEN DAYS, TRAVELING BY  
TEAM, SUMMER OR FALL.

---

1 team and its equipment.	1 tent.	2 tin cups.
50 feet quarter-inch rope.	1 camp cooking stove.	2 dish cloths.
50 feet half-inch rope.	2 sheets, canvas, 4 x 8 ft.	1 bar laundry soap.
2 rifles or guns.	1 folding camp table.	1 box matches.
2 gun slings.	2 folding camp chairs.	2 waterproof pocket match boxes.
200 cartridges.	1 hammock.	20 pounds flour, or
2 cleaning outfits for guns.	2 suits heavy woolen clothes.	15 pounds hard bread.
1 small can of oil for guns.	4 heavy woolen undershirts.	14 pounds bacon.
2 belts.	4 pairs heavy woolen drawers.	2 pounds dried apples.
1 axe.	4 pairs heavy woolen shirts.	2 pounds dried peaches.
2 hunting knives.	4 heavy woolen outside shirts.	2 pounds dried apricots.
2 skinning knives.	6 pairs heavy woolen socks.	3 pounds oat or rye meal.
2 pocket knives.	2 light felt hats.	2 pounds beans.
2 steels.	2 pairs buckskin gloves.	2 pounds rice.
2 compasses.	2 rubber coats.	5 pounds salt.
2 watches.	2 pairs rubber hip boots.	$\frac{1}{4}$ pound pepper.
2 pack straps.	2 prs. heavy leather shoes.	3 pounds sugar,
1 map.	4 pairs moccasins.	2 pounds roasted and ground coffee, or
2 prs. goggles or smoked glasses.	2 bags to carry clothing in.	$\frac{1}{2}$ pound tea.
Stamped envelopes and paper.	1 folding canvas boat.	25 pounds potatoes.
2 pairs ear muffs.	1 camp kettle.	2 pounds tobacco.
1 photograph camera.	1 frying pan.	2 pipes.
24 celluloid plates.	1 wire broiler.	2 toilet cases, each containing soap, towels, tooth brush, hair brush, needles, thread, buttons, safety pins, etc.
2 fishing rods.	1 stew pan.	
2 reels and lines.	1 bread pan.	1 kit tools and materials for repairing wagon, camp equipment, etc.
12 bait hooks, assorted sizes.	1 coffee pot.	
12 flies, assorted colors.	1 Dutch oven.	
2 sleeping bags, or	2 tin plates.	4 horse shoes.

4 pairs of heavy wool blankets.	1 folding rubber bucket.	25 horse nails.
2 mattresses, or	2 spoons.	2 pounds powdered alum for curing skins.
2 folding cot beds.	2 knives.	Supply of small change.
2 pillows.	2 forks.	

.....

.....

.....

If more than one pack-animal to each man is provided, then a folding canvas boat, folding cots, chairs, and even a table may be carried. A sheet-iron cooking stove may be taken, but it adds greatly to the labor of packing and but little to the comfort or convenience of the party.

For a larger or smaller number of people, or for a longer or shorter outing, the requisite quantity of supplies may be determined by multiplication or subtraction.

# The Big Game

OF

# North America.

Its Habits, Habitat, Haunts, and Characteristics. How, When, and Where to Hunt It.

A BOOK FOR THE SPORTSMAN AND THE NATURALIST.

EDITED BY

G. O. SHIELDS ("COQUINA"),

Author of "CRUISING IN THE CASCADES," "RUSTLINGS IN THE ROCKIES," "HUNTING IN THE GREAT WEST," "THE BATTLE OF THE BIG HOLE," "CAMPING AND CAMP OUTFITS," etc.

8vo, 600 Pages, 80 Illustrations.

Cloth, \$3.50; Half Calf, \$5.00; Full Morocco, \$6.50.

## CONTENTS.

Introduction, by the Honorable John Dean Caton, author of "The Antelope and Deer of America," etc.  
Moose Hunting in the Rocky Mountains, by Newton Hibbs ("Boxey Newton").  
Elk Hunting in the Olympic Mountains, by W. A. Perry ("Sillalicum").  
The Wapiti (Poem) . . . by "Wah-bah-mi-mi."  
The Caribou, by William Pittman Lett ("Algonquin") and Dr. R. B. Cantrell.  
The Mule Deer, by Rev. Joshua Cook ("Boone").  
The Mule Deer of Southern California, by T. S. VanDyke, author of "The Still Hunter," etc.  
The Columbia Black-tail Deer, by Thomas G. Farrell.  
The Virginia Deer, by Walter M. Wolfe ("Shoshone").  
A Deer Hunt (Poem) . . . by "Wah-bah-mi-mi."  
Hunting the Grizzly Bear, by Rev. Dr. W. S. Rainsford.  
The Polar Bear, by Sergt. Francis Long, of the Greeley Arctic Expedition, and George S. McTavish, of the Hudson Bay Company.  
A Polar Bear Hunt . . . . .  
The Black Bear . . . . . by Col. Geo. D. Alexander.

The Buffalo, by Orin Belknap ("Uncle Fuller").  
The Musk Ox, by H. Biederbick, of the Greeley Arctic Expedition.  
Still-hunting the Antelope, by Arthur W. du Bray ("Ganche").  
Coursing the Antelope . . . . . by M. E. Allison.  
The Death of Venus (Poem) . . . by Wm. P. Lett.  
The Rocky Mountain Goat . . . by John Fannin.  
The Rocky Mountain Sheep, by G. O. Shields ("Coquina").  
The Percary . . . . . by A. G. Requa.  
The Cougar, or Mountain Lion, by W. A. Perry ("Sillalicum").  
The Lynx . . . . . by J. C. Natrass.  
The Wolf . . . . . by Wm. P. Lett.  
The Wolverine . . . by C. A. Cooper ("Sibyllene").  
The Wild Cat, by Daniel Arrowsmith ("Sanganamon").  
Coon Hunting in Southern Illinois, by Daniel Arrowsmith ("Sanganamon").  
Fox Hunting in Virginia . . . by Dr. M. G. Ellzey.  
Alligator Shooting in Florida, by Cyrus W. Butler.  
The Ethics of Field Sports, by Wm. B. Leffingwell.

The Honorable John Dean Caton, the eminent naturalist and jurist, author of "The Antelope and Deer of America," etc., says of this work: "It is, without exception, the most elaborate, comprehensive, and valuable treatise on our Big Game Animals that has ever been published."

This book will be mailed, post paid, on receipt of price by

**RAND, McNALLY & CO.,**

162 to 172 Adams St., CHICAGO.

# DO YOU KNOW

THAT THE

## Hannaford Ventilated Rubber Boots

CAN BE WORN WITH

### ABSOLUTE COMFORT

WITHOUT SWEATING, CHILLING, OR DRAWING THE FEET?

ASK YOUR DEALER FOR THEM OR SEND FOR CIRCULARS.

HANNAFORD VENTILATED BOOT CO.,  
79 MILK STREET, BOSTON.

---

ANGLERS WHO ARE IN WANT OF

## RODS, LINES, OR HOOKS

THAT WILL NOT BREAK, AND

Reels which will not get out of order through fault of  
material or workmanship,

AND ALL AT MODERATE PRICES,

Send Ten Cents in Stamps for a Ninety-page Illustrated Catalogue  
and Price List of Fishing Tackle, to

A. B. SHIPLEY & SON., Factory and Warehouse, 503 Commerce St., Philadelphia.

---

## MAPS AND GUIDES

TO ALL OF THE

### PRINCIPAL CITIES

AND

## Every Country in the World.

---

Globes, Map Racks, Spring Map Rollers, Wall and Pocket  
Maps, Historical Maps; Classical, Biblical, Historical,  
Anatomical, Astronomical, Physical, and General  
Atlases of all kinds kept in Stock.

ADDRESS RAND, McNALLY & CO.,

MAP PUBLISHERS AND ENGRAVERS,

166 and 168 Adams Street, CHICAGO, ILL.

# WILD FOWL SHOOTING

BY

WILLIAM BRUCE LEFFINGWELL.

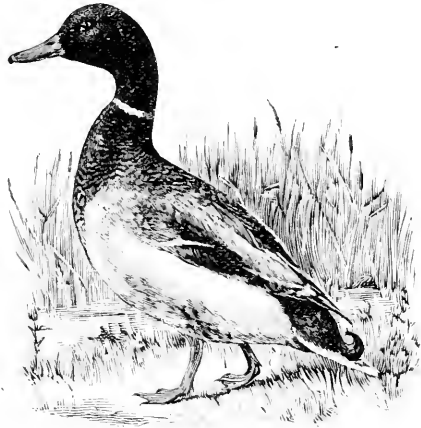

TREATS OF

*Guns, Decoys, Blinds, Boats, <sup>AND</sup> Retrievers,*  
FOR WILD FOWLING.

This Book has never Received an Adverse Criticism.

First Edition of 1,000 Copies sold in less than 30 Days.

**Endorsed by Every Prominent Sportsman and Sporting Paper in America.**

DR. N. ROWE, of *American Field*, the leading authority in America, says:

Frank Forester has the reputation of having been the best writer on field sports we ever had, but he never wrote a work of such enduring merit as this. I consider it the best book on field sports ever written.

*Forest and Stream; Shooting and Fishing; Outing; Turf, Field, and Farm; Breeder and Sportsman; Sports Afield; Sporting Goods Gazette; Charles W. Budd; James R. Stier; H. McMurry, and hundreds of others, endorse it as the best work on the subject extant.*

Write for Descriptive Circular to

**RAND, McNALLY & CO.,**

**CHICAGO, ILL.**

Price, \$2.50 Cloth; \$3.50 Half Morocco.

# Experienced Travelers

Always take the Popular



## BURLINGTON, CEDAR RAPIDS & NORTHERN R'Y

FOR

Chicago, St. Louis,  
Minneapolis, St. Paul,  
Des Moines, Omaha,  
Kansas City, Denver,  
Colorado Springs,

AND ALL POINTS IN



Texas, Oklahoma, and California.

Call on B., C. R. & N. Agents for further information, or address

J. MORTON, G. T. P. A.,  
Cedar Rapids, Iowa.







SH American game fishes  
461  
A45

Forestry

PLEASE DO NOT REMOVE  
CARDS OR SLIPS FROM THIS POCKET

---

UNIVERSITY OF TORONTO LIBRARY

---

LIBRARY  
FACULTY OF FORESTRY  
UNIVERSITY OF TORONTO

