

DEANE'S MANUAL
OF
FIRE ARMS.



DEANES' MANUAL

OF THE

History and Science

OF

FIRE-ARMS.

"If the wealth of nations is based upon the industrial energies of their peoples, the power and independence of a nation is no less dependent upon a healthy condition of its military institutions, and on the excellence of the arms which it places in the hands of its soldiers."—*Essay on the Modern Improvements in Fire-Arms. Military Review, July, 1852.*

LONDON:

LONGMAN, BROWN, GREEN, LONGMANS & ROBERTS,

PATERNOSTER ROW.

1858.

231. a. 60.

GEORGE T. THOMASON,
Illustrative Printer,
80, UPPER THAMES STREET.



PREFACE.

ERRATA.

PAGE

- 77 line 13, for "sixty two after," read, sixty two years after.
" " 21, for "foud," read, found.
120 " 7, for "at the neck," read, at the cheek.
124 " 11, for "full cock bent," read, full cock bend.
129 " 11, for "round the jug," read, round the jag.
132 " 14, for "rags doubled several times, which are kept by letting," read, rags doubled several times, which are kept on by letting.
133 " 17, for "disagreeable," read, disagreeable.
" at last line, for "further," read, farther.
138 line 8, for "decenitnum," read, decennium.
147 " 22, for "from sheet, wadding," read, sheet-wadding.
154 " 10, for "is strong and well rivetted," read, is strong and well fitted, and the screw good.
172 " for "through the charge and the," read, through the charge, and the
175, 9th line from foot of page, for "indisputable," read, indispenible
229, line 16, for "subsequent accessary" read, subsequent accessory
232, 7th line from foot, for "in the chambers," read, in the chamber
235, 7th from foot of page, for "powder gases themselves, upon the" read, powder gases themselves upon the
236, 15th from foot, for "in the base of a rifle" read, in the barrel of a rifle
237, line 24, for "1.70 mm" read 1mm 70.
261, 13th from foot, for "upon this occasion are, in" &c. read, upon this occasion, are in &c.
268, 10th from foot, for "Hon. E. India Company's" read, Hon. E. India Company

126, line 10, for "fire," read, fibre.

SYSTEM OF IGNITION to military arms became a much mooted question in Germany; and its subsequent adoption there in several States to the infantry musket, induced a corresponding movement in France, and awakened attention thereto in this country.

Like every suggested change in our military usages, it was, nevertheless, contemplated at first with little favour; and the expense of transforming the flint-lock musket to the percussion system for the entire army, was one which afforded that semblance of reasonable opposition to all change, which those

THE UNIVERSITY OF CHICAGO
DEPARTMENT OF CHEMISTRY
5800 S. UNIVERSITY AVENUE
CHICAGO, ILLINOIS 60637
TEL: (773) 835-3100
FAX: (773) 835-3100

1. The first part of the document discusses the importance of maintaining accurate records of all transactions. It emphasizes that proper record-keeping is essential for the integrity of the financial system and for the ability to track and audit activities. The text outlines the various types of records that should be maintained, including financial statements, contracts, and correspondence.

2. The second part of the document focuses on the role of the accounting department in ensuring that all transactions are properly recorded and reported. It describes the various tasks and responsibilities of accountants, including the preparation of financial statements, the management of accounts payable and receivable, and the oversight of budgeting and forecasting. The text also discusses the importance of maintaining accurate records of all transactions and the role of the accounting department in ensuring that all transactions are properly recorded and reported.

3. The third part of the document discusses the importance of maintaining accurate records of all transactions. It emphasizes that proper record-keeping is essential for the integrity of the financial system and for the ability to track and audit activities. The text outlines the various types of records that should be maintained, including financial statements, contracts, and correspondence.

4. The fourth part of the document focuses on the role of the accounting department in ensuring that all transactions are properly recorded and reported. It describes the various tasks and responsibilities of accountants, including the preparation of financial statements, the management of accounts payable and receivable, and the oversight of budgeting and forecasting. The text also discusses the importance of maintaining accurate records of all transactions and the role of the accounting department in ensuring that all transactions are properly recorded and reported.

P R E F A C E.

THE continually progressing modifications made in the mechanism of fire-arms during the last thirty years of the long Peace, had already received in 1846 a military development so remarkable as to form a new era in their history, the influence of which upon the art of war—though contended by many from whom a more perspicuous judgment was to have been expected—was practically illustrated sooner than anticipated; and from 1848 to the present day, the results of that progress, though universally admitted, are yet, nevertheless, imperfectly appreciated in their prospective extent.

The custom of upwards of two centuries, which had established the flint-lock as the *ultima Thule* of mechanism in the perfection of fire-arms, had not long become obsolete on the arm of the sportsman, when the adaptation of the percussion system of ignition to military arms became a much mooted question in Germany; and its subsequent adoption there in several States to the infantry musket, induced a corresponding movement in France, and awakened attention thereto in this country.

Like every suggested change in our military usages, it was, nevertheless, contemplated at first with little favour; and the expense of transforming the flint-lock musket to the percussion system for the entire army, was one which afforded that semblance of reasonable opposition to all change, which those

political economists who looked no farther than the present, and who at that time sought to prescribe the very degree of progress that things military should make in this country by the rule and scale of the chapman, found convenient to their use. Supplied therefore at first with a niggardly hand to some few of our troops, it was not until the conviction of its expediency for general adoption was forced upon the public mind, by the rescue from imminent destruction of a company of the 37th Native Infantry by the percussioned arms of a few marines in the first China war, that the substitution of that system of lock throughout the army was resolved upon. It was now believed by the sturdy admirers of their "queen of weapons," the "Brown Bess" of the British soldier, that all its imperfections, if it had any, were radically alleviated.

Yet a few short years, and they were again doomed to learn the fallacy of the acquired notion, that the things we have been accustomed to, and in the use of which we have arrived at a ripe old age, are therefore incapable of further improvement. To the roundly affirmed superiority of the British musket in its flint-lock phase, had been attributed by many our successes in the battle-fields of the Peninsula; and by the opponents of innovation, no more clenching argument could be adduced that improvement was both inexpedient and impossible. But, without regard to the predilections and opinions of our veterans of the Peninsula, the problem was being assiduously solved in France and Germany; and the conviction of the expediency to move yet further with the spirit of the age in the improvements carrying out in small arms, found its way at length to the understanding of some less biassed minds at home.

The contemporaneous progress made in that science which had bridged over the narrow seas between this country and

continental Europe, came also as a potent auxiliary in solution of the question; and the attention of government was directed not an hour too soon to that improvement in the fire-element of battles which was becoming general with all the European powers.

There was a time when skill in the use of the bow was considered one of the most necessary national qualifications of an Englishman, and it was one by which for upwards of two centuries our ancestors won a European renown. That time was before England's wooden walls had made her inaccessible to foreign invasion. But another cycle of time and of national existence has been sometime commenced, and by sheer progress we may be said to have retrograded to a military-geographical position on the map of Europe, not unsimilar to that of the days when the bows of our yeomen were the best safeguards of our land. Steam-power has been establishing a certain equilibrium upon the seas, between this country and some of the maritime continental states; and the time may yet come when a national skill in shooting with a rifle will be found as valuable as was that of our stalwart ancestors with the long bow.

From our early conviction that this acquirement, with that of a more generally diffused knowledge of fire-arms and their modern improvements, are matters that should not be disregarded in the all-engrossing pursuits of commerce, till the prosperity derived from that commerce and our national independence be assailed at home, we think some public service may be rendered by popularising in the present form a knowledge of the History and Science of Fire-arms; and by bringing their elements before the public in such shape as will enable those who have a disposition to acquire a clearer knowledge of the gun and rifle in theory and practice, to

attain these to a degree that will be serviceable whether in the field of sport or of war.

The hitherto too general ignorance in this country of the proper and safe handling of fire-arms—of the principles of their mechanism—the properties of gunpowder—and the laws that govern the flight of projectiles, and influence their effects in usual or particular circumstances, is one which (apart from the mournful accidents the first of these so frequently entails) demands as much correction by culture as any other of the deficiencies in useful physical or intellectual recreation. The general neglect of these things, yet more increased by the habits of life and thought which had grown out of a nearly forty years' peace, had made the great majority of all classes in modern England strangers to attainments which are both manly and useful; and which now, more than is generally considered, should become as familiarly known as a national acquirement as it is in many European states in the present day, and daily becoming more general.

Though the popular acquisition of a knowledge and skill in the use of *any arms* has been encouraged by no British government since the days of the "bow and cloth yard arrow," and that a reluctance has been long evinced to see such a qualification in the men of England, we think—and the opinion has been expressed by many enlightened and patriotic men of the present day—that the political reasons which could formerly be urged against it have long ceased to exist.

In 1854 the dream of "Perpetual Peace" was dispelled. The hopes of the philanthropist, the theories of the modern disciples of Montaigne, were as unavailing as the efforts of the ablest statesmen to controul the march of events. Those who had believed that so lengthened a peace had changed human

nature were made sensible of their amiable error ; and the predictions of the "Great Exhibition" prize essayists, who in their overcharged rhapsodies depicted the world for ever indissolubly bound in the silken bonds of harmony and love, that were to evolve out of that over-estimated effort of human industry, received a confutation, the force of which was the more striking from its very suddenness.

Among the productions of that Industry of Peace, they had not understood the significance of those things which in that very temple manifested that in peace, more than in war, the ingenuity of man directed itself to improve the appliances of destruction. To reconcile this, to them, seeming anomaly, they sought to find therein a greater assurance "that the perfection of military weapons, by rendering war more terrible, would render man more disposed to peace;" an inference for belief which the history of the world contradicts. By the dispensation of a higher and inscrutable Will, the will of one man was to prove the fallacy of the wisdom of the nineteenth century ; and that where an equilibrium of *Offence* is available to all alike, there is no more security for a perpetual peace between nations possessed of the most terrible engines of annihilation, than there was when they were all in equilibrium with inferior means of destruction.

With facts so patent to our senses as those which the last four years have evolved, who shall assume to say what is *unlikely* or *impossible* ?

The faithful friends and allies of one or two generations may be succeeded by foes as implacably hostile. Moral and peace doctrines alone have yet long to establish their benign sway over the hearts of peoples and princes. So long, therefore, as their supremacy is so doubtful and distant ; in

presence of the improved military organization which is every where progressing in unison with the aids of science as applied to every human art, it would be suicidal to neglect an equal progress in the same direction.

Though favoured in less degree by our insular position than heretofore, all its advantages have not yet been lost to us ; and the very nature of those improvements in arms which now make war so terrible, can be made the more available to us as a new element of national strength, by popularising their knowledge, and making their practice a national characteristic as in the olden time. To neglect this would, humanly considered, be to found our reliance upon a basis to which we had failed to give the strength and breadth of which it is susceptible ; and which, limited alone to the nucleus of the Regular troops, present, at the outbreak of the storm, would be deficient in that vigour of national life, which in such a juncture should permeate the land, and leap on every hand into the struggle, ably auxiliary to support and feed the regular constituted means of support and defence, after a fashion that would render the fields and homesteads of Britain the grave-yards of the most potent military aggressors.

The first sheets of the present work were already in the press during the Russian war, which will account to the reader for the application of some incidental remarks to that struggle, in the present tense. Resumed since under favour of a greater increase of interest derived from the further improvements effected, and still effecting, both at home and abroad, in fire-arms and their projectiles, it may not prove less acceptable than at that period, to those desirous of information upon many things not generally known in relation to sporting and military fire-arms.

A MANUAL OF FIRE-ARMS,

ETC., ETC.

INTRODUCTION.

THE knowledge of the structure, action, and effect of Fire-arms, of their inspection and keep in effective condition, is in reality almost as requisite to the Sportsman as to the Military man—for without it, neither can acquire that correctness of judgment which is so indispensable to their skilful use. By the knowledge of these only, can both alike qualify themselves for the proper test of the efficiency of their arms for the object desired—by these only can they detect their faults and imperfections—the means by which these may be corrected, and attain to the conception and suggestion of useful alterations and improvements.

From the circumstance of the mechanical structure of fire-arms having hitherto admitted of a certain maximum of perfection only, the exercise of the latter faculty will necessarily depend much upon the construction and manner in which they have been put out of hand, which frequently impose a limit to their improvement, or admit at least of modifications only.

As it is, therefore, for the military man equally with the sportsman and amateur, for the more initiated, as well as the novice that we write, we shall here first shortly advert to the special auxiliary sciences, some distinct knowledge of which is required for the attainment of a well-grounded comprehension of the sphere comprised in the Science of fire-arms. To these belong:—

The Mathematics—For the solution of many questions of computation, respecting power of resistance and effect.

Physics and Chemistry—To ascertain and judge correctly the properties and qualities of the different materials, and the results exhibited in their union and manipulation.

Technical Knowledge—Of the amalgam and working up of the

materials. This in its full extent is to be expected and found only in the best workmen, (gun-makers, cannon-founders, &c.,) acquired by them through many years of practical manipulation and experience, which serve them better than all theory. A knowledge, nevertheless, in so far necessary to the understanding of the Science of fire-arms, that it enables the possessor to detect the faults in the raw material, or those which have become evident by defective workmanship. This is best acquired by frequent visits to, and inspections in the workshops, &c., of manufacturing establishments.

Before the general application of fire-arms to the purposes of War and of the Chase, the projective arms were very simple and of comparatively restricted effect. He who drew the Bow or whirled the Sling, could alone give to those arms their full value by an unremitting practice and acquired skill, such as is given to the Assegaye by the Caffer, &c., or as is still given to the sword or sabre by the well practised swordsman.

Fire-arms, combining in their principles and structure, elements of a far more complex and extensive sphere of action, demanded from those who would elicit all the advantages of their use, a no less practical skill and knowledge of their properties. But as a certain readily acquired, though limited aptitude in the use of fire-arms, could be obtained even with a total ignorance of the laws on which their effects and efficiency were founded, that regard to the latter which would have best advanced their improvement, had during upwards of five hundred years been addressed to them at unfrequent and short intervals only; until as we have already observed, of late years especially, a successive combination of circumstances had arisen, showing the necessity of a much closer attention to their improvement, and indicating the imperatively required extension of a more popular acquaintance with their use and structure, as *the* arms about to become more than ever of paramount importance to the preservation of NATIONAL INDEPENDENCE.

Hitherto, the fire-arm of the Infantry, the Flint Musket, that *non plus ultra* of the old school, and of those who thought they must be right to echo their dictum, required, no more than the Shotgun of the Sportsman, any great physical qualities in the Soldier for the acquirement of that degree of drill aptitude to its use, sufficient for the attainment of those effects which, according to the almost universally received notion of the Routinists in modern tactics, were

the consummation of excellence, to attempt any change in which implied in their opinion either presumption, ignorance, or madness.

The simplicity of all the other kinds of arms had presented but insufficient materials, on which to establish a collect of principles for their construction and efficiency of action. But those of fire-arms demanded such a system; one which nevertheless obtained due consideration of late years only, and first in France and Germany received its due place and rank among the Military Sciences.

It is by no means unimportant to consider here, the causes which so long impeded the development of the science of fire-arms; since not only in modern times, but even up to the present moment, many deficiencies therein yet remain to be supplied, and numerous prejudices to be overcome.

The construction and use of fire-arms originating first with artisans or mechanics void of all auxiliary knowledge of physics, chemistry, and mathematics, they were of a necessity, frequently obliged to trust to chance in their structure, and were without any guiding principle of action. The sphere of individually acquired experience which each concealed with the most jealous caution from the knowledge of others, could necessarily expand itself but slowly.

Where the mere workman, even when become a foreman or master-armourer, changed in little or nothing but in nominal position; and, (as yet in the present day too frequently) in many establishments limiting his notions of the degree of progress attainable in his-craft to the possession of a certain amount of acquired manual labour-skill alone; in his conceit of that mere mechanical aptitude, a conceit always overweening in proportion to his real ignorance, contributed in his own person most effectually to retard advancement by an invidious and scornful repudiation of every light of Theoretical Science. What else could or can be expected.

The ill effects of this self-defeating and narrow-minded spirit, were yet more increased by the expense concurrent with all experiments, whereby to solve with any accuracy a questionable or contradictory result; an expense for which the means are seldom at the disposition of private enterprise, and often less frequently still at that of those who have the genius of research, and the intelligence necessary to carry them out.

When Governments eventually assumed to themselves the manufacture of fire-arms, they were of a necessity compelled to resort to these workmen, who on their side resorted also to every means to make themselves indispensable, in the new and permanent position where they laboured no longer at a personal pecuniary risk. Here, therefore, even in the government establishments, slowly and by degrees only, were the experience, manipulation, and secrets of the Craft extracted from them, and, reduced to a system, which in turn, the Governments, from other motives, considered safe only to entrust the knowledge of to a special class of individuals, in order to ensure to themselves a superiority in their production, and an advantage over their neighbour states. This Guild-like spirit—this assumptive Craft-mystery—and defective knowledge of chemistry and physics, together with the difficulty and expense of experiments on a large scale, constituted the chief obstacles in the way of progress in the science of fire-arms. The two first, even yet, unfortunately, though perhaps, somewhat less ostensibly than heretofore, still exert in part their influence; though the veil of pedantry in which the gunmakers and artillerists of past days so cunningly sought to shroud their incapacity, is (abroad at least) greatly dissipated.

To be enabled to arrange and conduct the experiments required to establish a correct Theory demands moreover great perspicuity and judgment, with a comprehensive knowledge of the whole subject. The very considerable expenditure with which these are frequently attended, permit of them but seldom; and under peculiarly favourable circumstances only, dependent often on the position of the individual originating the change, improvement, or innovation; and on a variety of things readily conceived and known to those who have addressed themselves to that effect to the constituted authorities.

The not unfrequent paucity of the qualifications adverted to above, in the very Functionaries themselves appointed by the Authorities to superintend such matters, combined with other circumstances less excusable even than the want of those professional attributes, throw impediments in the way of a proper investigation, and the real value of a suggestion or experiment, fails to be recognized from causes beyond the control of the projector, and often irrespective of the merits of the subject. On the other hand, not unfrequently, also, the results of experiments even when made and conducted in a fair and impartial spirit, are but so much dead material, which the head and hand of an intelligent and scientifically competent judge, can alone appreciate and turn to useful account.

The difficulty is moreover greatly increased when after such experiments have been made, their results are required to be immediately carried into practice ; when many constituent things highly important in themselves are but imperfectly treated, so long as the whole subject matter itself is as yet imperfectly established. No less frequently the fear of erring in useless speculations creates a prejudicial hesitation in effecting them, and a proper provision for much that is essentially important, is wholly overlooked or deferred to a future period ; whereby, not only the advantages which might have accrued to the State from an earlier and direct attention are lost or injudiciously deferred ; but great injustice frequently perpetrated towards the Inventor.

Lastly, but of especial influence with Governments : all extensive material changes in the *materiel* of fire-arms, and in their sudden adoption, occasion a great loss in Stores. The vast expense which thereby often accrues to the state, with the loss of time their completion requires, are necessarily subjects requiring consideration. In addition to these many arrangements and suggestions, experimented upon even on a large scale, (in small ones the results are seldom to be relied upon or useful) appear very advantageous ; but which in War, when the passions are inflamed, and coolness and presence of mind not quite so ready at hand as on the Practice Ground, are by no means so reliable or possible.

Hence, furthermore, has arisen the slower progress in the improvements of fire-arms—great caution is required of the Military man on occasions of important changes ; and he is frequently prevented by circumstances demanding great consideration from immediately introducing that which is found *to be better* ; considerations which often compel him as a duty to remain by and use that which already exists. But it is no less incumbent on him, while sedulously avoiding an over hasty impulse to a love of innovation, to avoid likewise a convenient pedantic adherence to existing Routine ; and he should endeavour to steer that middle course so difficult in all things, which is possible only when to a well grounded knowledge, and a clear understanding, a sense of the necessity to move with the times is concurrently felt.

From these premises the wide sphere comprised in the science of fire-arms, up to their present progress towards improvement, and the obstacles which have hitherto so long impeded it, may be readily

comprehended; but as the object of the present Manual must naturally restrict itself to that which is most necessary to impart a general and more popular knowledge of the subject, we have endeavoured to keep within those limits.

THE BOW AND CROSS-BOW.

PREVIOUS to taking such a retrospective view of the history of fire-arms, as of right should form a feature of this work—and which as especially connected with the interests of the subject, may be desirable and useful to every class of reader—we will shortly advert to *the* arms that more immediately preceded the gun in the Arquebus form, as the chief arm of the Sportsman in the far distant days of our ancestors. In so doing, we are disposed to believe, such a notice will be pleasing to many readers, the more especially as we know of no modern English commentary on the subject ; for we do not consider the compilations of Roberts and Moseley on the use of the bow in England for Military purposes only, as addressed to this particular point.

We will, therefore, first shortly dwell upon that arm in the use of which of all the peoples of Europe, the English once excelled ;* and which kept its ground in this country as the NATIONAL and favorite arm even long after the rest of Europe had adopted fire-arms, and forgotten or discarded its use. The Bow as an arm of offence was known of all antiquity, and was the arm of all the peoples of the earth. Its form was so simple, so little complicated, that its idea or conception must have come naturally to the first of mankind everywhere, and simultaneously ; without direct communication from one people to another.

Though the Sling is mentioned in Holy Writ, and is doubtless of high antiquity, it would seem less ancient than the bow, and of less universal use ; for the sling was not found among the aborigines of the Americas, while the bow was in general use among them.

Though the bow became the especial military arm of the Anglo-Normans, and achieved in their hands the most glorious renown to the English name on the fields of France, yet there is every reason to believe that before the Conquest it was not so ; for our Saxon ancestors, though they brought the bow with them to Britain,

* Gaston Phoebus Count de Foix, one of the earliest French writers, on the "Sports of the Field," (his work was composed at the end of the 14th century, he died 1391) speaking of the bow, says, "*Of bows I know not much, but who would know more, let him go to England, for that is truly their business.*"

distinguished themselves more particularly for their expert use of the ponderous battle-axe and iron war-mace, to the weilding of which their remarkable corporal strength, prowess, and love of close combat, were so highly adapted, and impelled them.

These qualities, and the predeliction of our Saxon ancestors for the use of the last-named arms, were exhibited no less in foreign lands, and there also attributed to them, as a National peculiarity ; for we find those who emigrated from England at the period of the Danish usurpation, and entered the service of the kings of Hungary, and of the Greek emperors, distinguished themselves as the body guards of those sovereigns by their great prowess and skill in the use of their *national weapon the battle-axe*.

But with our *Anglo-Norman* ancestors, the bow became the *special arm of the people* ; and its practice, their favorite amusement in time of peace, rendered the English archers the chief strength of the armies of their sovereigns. It no less became in those days the chief and popular *arm of the Chase* ; the use of the more costly and complicated cross-bow, a later introduction from the East, by the Crusaders, being confined rather to the nobility, and preferred by them from its possessing several advantages over the bow, as better adapted to *Sporting* purposes.

On the Continent, both for these and for war purposes, the cross-bow was the more universal arm, and preferred especially for field sports, in southern France, Spain, and Italy ; the peoples of which countries were as celebrated for its skilful use, as were the men of England for that of the bow ; to which the popular feeling fostered by the encouragement of each successive legislature clung even longer than on the continent to either of those arms, and adhered to it long after both had made way for the Arquebus and Haquebut.

During the more peaceful reign of Henry VII., the parliament of England fearing that the disuse of the long-bow, heretofore the safeguard and defense of this kingdom, should cause the decline of the invincible militia which had so long been the terror of its enemies, was loud in complaint of the gradually subsiding practice of our yeomen with this arm : and in statutes made in the thirty-third year of Henry VIII., the practice of the bow was still insisted upon as the most reliable arm of our national strength, in spite of the general adoption of fire-arms in the rest of Europe.

In these statutes, chap. 9, as a provision to make good marksmen at sight : it is forbidden to shoot at a *standing* mark unless it be for a rover, when the *archer* is to change his mark at every shot. Any person above twenty-four years old is also forbid to shoot with any

prick shaft or flight at a mark of eleven score yards or under. This was to give strength and sinew.

It was furthermore expressly enacted and enjoined *on all persons* to be regularly instructed *even from their tender years* in the exercise of the long bow and arrows, and to be provided with a certain number of them. Thus was it that soldiers were moulded from childhood in the days of yore in England; and when the use of the modern rifle shall be enjoined as it should be by similar enactments, England will as little fear as in those days the foot of an invader.

The value of the English long-bow had been no less learned by the Scotch in their wars with our sovereigns, and Scottish bowmen fought side by side with the soldiers of France in the expedition of Charles VIII to Italy. At Guinegate in 1479, as auxiliaries to Duke Maximilian, afterwards Emperor of Austria, three hundred English bowmen vied with their favorite arm, with the German arquebuseers, and as their fathers had done nearly a century and a-half before on the soil of France, wrought confusion and death in the ranks of their adversaries.

So tenaciously indeed, was this predilection for the long-bow evinced in this country, that as late as the reign of Elizabeth, when fire-arms had become everywhere else of universal use, the prejudice against these was so strong, that the general opinion expressed itself openly against their use, and to strengthen the popularity of this prejudice, it was even vested with a religious garb; for at that period in England, the extension of the use of fire-arms was considered in the light of a very calamity, and people were found who prophesied the downfall of the state itself, from their more general introduction.

Not only during the reign of Elizabeth, was the use of the favorite bow the popular theme, and a treatise thereon written by Roger Ascham, 1589; but as late even as the days of Cromwell, Jervaise Markham, 1634, wrote upon the subject, exhorting the Government to return to the use of the bow, and re-establish the archer militia of England. But the long-bow appears to have made its final exit from the theatre of war in the reign of Charles I., 1627, at the siege of the Isle of Rhé, where the archers of England still formed a part of the troops sent to the succour of the French protestants.

The estimation in which the bow was thus held so long in England, found moreover an apologist of no mean Military judgement on the Continent in the person of Blaise de Vigenère, who in his *Art Militaire*, (1593,) speaking of the long-bow and cross-bow, as compared with the effects produced by the arquebuseers of that more advanced period, says:—"And it is a thing on which the best captains of our

age are agreed, that the archers and cross-bowmen slew more, than do the arquebuseers."

All these predelictions and opinions would appear moreover justly founded, since our own writers on the long-bow assure us, that the English archer would shoot twelve arrows in one minute of time, and unless he would expose himself to the bitterest ridicule, dare not miss the mark with more than one at two hundred and twenty yards. Such results could not but stand out in strong contrast with the performances of the arquebus and hackbuteers of that day, whose arms though greatly improved from what they had been in the preceeding century, presented to their most sanguine advocates but little ground to anticipate what we have seen science effect for them, after a lapse of two centuries and a half, the latter of which had nearly been passed in a state of peace.

We cannot refrain from expressing the reflexion which obtrudes itself here as we write: How vain were the hope and baseless the conviction entertained and expressed also in that day, by Michael Montaigne the philanthropist, "that he thought to see before he died the abolition of the use of Fire-arms!" We have seen his opinion cited anew as authority by a member of our modern Peace Society, but both his opinion and its reiteration we feel convinced will prove anew as vain and irrational as the prediction of the French general Latrille, who having sworn an implacable hatred to Field Artillery, wished to confine artillery wholly to the defence of fortresses. "For that" says he "is the true domain of artillery; I may be deceived but, I think the time will come when it will be only used for that purpose." How the Napoleonic battles of the years 1809, 13, 14, and 15, proved Latrille a false prophet, we leave the reader to judge.

The Cross-Bow was in reality but a modification of the bow, in other words a bow adjusted to a shaft or stock, and though the Balista was known to the ancients, (which was nothing more than a cross-bow of gigantic dimensions) yet the cross-bow (*balista manualis*—*manu balista*,) was a projective arm of much more modern European date, and was more generally used as a *Sporting* arm. As the first *stocked* projective arm, it may be considered, therefore, the one of first and nearest affinity to the Fire-Arm itself, and from its better adaptation to the purpose, the more costly but "deadly cross-bow," was the especial arm of the Chase throughout Europe up to the time of Charles V.

Though the date of its invention and use in Europe is difficult to fix, Father Daniel, in his "*Histoire de la Milice Francoise*," assigns to it some antiquity, and speaks of cross-bowmen in his life of "Lewis

the Fat," (deceased in 1137), as the favorite arm of the Chase; but as a War arm it was more generally adopted in France by Philip Augustus at a later period, and our lion-hearted Richard who had passed safely through so many perils in the battle-field, was slain during the reign of Philip by a cross-bow at the siege of Chalus. Gillaume le Breton an early poet chronicler of Brittany, assigns a retributive justice to this incident of the death of Richard I. by the cross-bow, for having first introduced its use into England and France in the time of king Philip, in the early part of whose reign he says it was so little known, that in the whole army of that sovereign there was not one engineer who knew how to use it :

Francigenis nostris illis ignota diebus,
 Res erat ignota omnino quid Ballistarius Arcus
 Quid Ballista foret, nec habebat in agmine toto
 Rex, quemquam sciret armis qui talibus uti.

And on the occasion of Richard's death, he puts the following words into the mouth of the Fate Atropos :

Hac volo, non alia Richardum morte perire
 Ut qui Francigenis Ballistæ primitus usum
 Tradidit, ipse sui rem primitus experiatur
 Quamque alios docuit, in se vim sentiat artis.

in which Atropos condemns him to die by the self-same arm, the use of which he had taught the French. The poet was nevertheless guilty of one of those licences which are permitted to his kind, for the cross-bow had not been unknown in France before that period; but as its use had been abolished for several years during the observance of the Canon of the Second Council of Latran, which forbade the use of that arm, and that it was reintroduced by the warlike Richard on his return from Syria, and imitated by Philip Augustus; Guillaume le Breton in his patriotic hate of the enemy of France, and imbued with the religious awe of his day for the canons of the church, thought to see in the manner of Richard's death, the retributive justice he figures in his latinity.

Alonzo Martinez de Espinar, the author of an excellent treatise in the Spanish language, on "The Chase,"* is the only one who describes the cross-bow in sufficient detail for a perfect comprehension of its mechanism. Being nevertheless of frequent occurrence in the cabinets of collectors of arms, there are few of our readers who will not have seen and examined their action. As may readily be imagined, the cross-bow for the chase was generally of less proportion in every way than that used for war purposes, from which it differed

* *Arte de Ballesteria y Monteria*, Madrid, 1644.

also in some other points, especially in the double bow-string, which shot small leaden or baked clay balls, instead of arrows and quarrels.*

The cross-bow which had become familiarly known to the first Crusaders, and improved upon in Europe on its eventual introduction, consisted of a wooden shaft or stock through the end of which a steel bow of from 6 to 10 lbs. weight was passed and firmly secured. The two ends of this bow were connected by a cord or bow-string of firmly twisted hempen or gut strands. By means of a small iron hand-windlass, the bow-string was made to bend the bow, which on the release of the former by the pressure of the finger on a trigger of simple form, enabled its powerful retraction to project through a half or whole tube of iron extending along the upper part of the stock, a fifteen inch long arrow or bolt, or even leaden balls, with great force, velocity and precision.

The Hand-Balista or smaller cross-bow which was the arm of the Chase, was made wholly of iron, having beneath the trigger a mechanism to span the bow-string. This kind of bow kept its ground in Germany some time after the adoption of the lighter and improved arquebus, and in England almost a century longer as a war arm with the long-bow. It was doubtless the growing use of the cross-bow in England in the time of Henry VII. and VIII., that gave rise to the fears then evinced, that the long-bow would fall into disuse; and to the enactment of the statutes cited for its diligent practice.

The cross-bow used in Spain for the Sports of the field, killed, according to the Spanish author, "at a hundred and fifty paces, and *beyond*," this establishes a range for that arm as used in the chase, quite equal in efficiency to the modern flint musket; but this range and certainty was still further surpassed by the war cross-bow, the killing range of which was two hundred paces, and *beyond*. There would appear to be no exaggeration in this estimate; for the testimony of the author of "*La Discipline Militaire*," is corroborative of the Spaniard, for he says, both the archer and cross-bowman, will slay a man at from a hundred to two hundred paces distance, *equal to the best Arquebuseers*; and in such manner even, that though covered with defensive armour, if it is not of the best, it cannot resist them. From experiments made at Annecy, in France, at the end of the last century, the arrow and quarrel projected by the cross-bow, fired almost horizontally, attained a range of four hundred paces, others,

* The quarrel "*carreau*," (Latin *quadrellus*) was an arrow with a square iron head, called "a bolt" by early English writers, they were feathered frequently with brass.

three hundred and twenty, and the least, two hundred and sixty : the pace was the ordinary one of from eighteen to twenty inches.

The modern Sporting Gun is doubtless more handy, more rapid in its use, and more deadly ; but the cross-bow had one quality which no fire-arms can dispute with it, that, namely, of killing *noiselessly*, and that it did not frighten the game. Its device, says Espinar, was "*Mata y non espanta ;*" it kills, and does not alarm. This faculty which was lost to the sportsman, when the Arquebus was adopted, is particularly regretted by an Italian writer on Field sports, Dominick Boccaurazza, who, in his treatise on the "Sports of the Campagna of Rome," 1548, observes : the Arquebuseers had so much scared the four-footed game, that their number had greatly decreased in those parts.

The cross-bow was thus, before the invention of fire-arms, the chief arm of the Sportsman in Continental Europe, and much more generally used than the bow, over which it had the advantage of greater range and precision. There was another advantage also with the former arm ; the projectile could be accommodated to the game, and several different kinds of quarrels and arrows, as well as balls of clay and lead, could be fired from it. Though many sportsmen of the present day, ascribe some merit to themselves for a very indifferent skill with the gun and rifle, it may be imagined that the skill and correctness of aim acquired by him who piqued himself on well handling the cross-bow, must have been something more difficult to attain, than that of firing with ball from the rifle. As the cross-bowman did not shoot on the wing and seldom at a running shot, a sporting dog was much more necessary than in the present day, particularly for hares and partridges. The dog for his use must have then required also much more care in breaking in and tuition, while the sportsman himself required great practice, and an extremely keen sight to detect the game when on the ground, and when his dog came to the point. What resources also in stratagem, in skill and precaution, must he not have required, moreover, to make up for the imperfection of his arm, compared with those of the present day !

The use of the cross-bow lasted, as we have said, some time after the invention of the Arquebus, and even after these had been improved and rendered more managable than they were in their primitive form. It was not until towards the end of the 14th century, that this arm was almost totally abandoned, and when at length the Arquebus had been so far improved as to permit of firing on the wing, which as we have observed, was not possible with the cross-bow, adapted only to shooting at a standing shot, at least so far

as regards small game ; for as respects the larger kind, it is easy to believe that on some occasions they could be killed running, particularly when not pursued, and when going at their own and usual pace.

Such, as far as our limits will permit us to adduce was the arm that formed the connecting link between the Bow and the Gun ; partaking of the character of the former, and forming the model, if we may not say the type, of the latter, in many respects of its conformation, and projective qualities.

But we cannot leave this part of our subject, without placing in as salient a light as possible, the special *Tactical* advantage which the bow possessed over the cross-bow as a Military arm, on which also the historians and military writers of those days, and the best military critics and *service* soldiers of a later time, have remarked and are agreed. It was, viz., that the bow from its construction and greater facility to handle, gave to the archer the power to produce a far more rapid multiple of shots—a faculty which was always controllable by those who possessed it, and always available at need. We lay especial stress upon these points in reference to the bow, and as truly applicable to the improving fire-arms of our infantry, submit them to the reflection of those who not long since endeavoured to impress upon the minds of our Authorities that “rapidity of fire,” produced at will, as in the improved Breech loading and Revolving arms of the present day, (their more special advantage) was and is on the contrary a DISADVANTAGE!! It has been proved of all time, that where the will exists to do so, a man’s highest qualifications can be turned to his discredit ; so is it not unfrequently with things. But from whatever motives or ignorance such attempts to mislead may have been made ; the fact, (were it generally known and duly considered) that from the earliest use of the Fire-arm, the efforts and ingenuity of man have been directed for nearly five hundred years to the attainment of *Celerity* and *Precision* for that arm, must either prove something in favour of the intelligence of our forefathers through those long cycles of time, or that both the time and their efforts have been misapplied and misdirected ! In the latter case, then indeed, is the wisdom of the past contemptible in comparison with the sagacity of those modern Connoisseurs in the qualities of a Military Fire-arm ; and it would have been better for all who in the present and future wars may think too lightly of those qualities, that the sequential order in the intelligence of the men had been reversed five hundred years ago.

For ourselves, we were from the first always at a loss to under-

stand how an Offensive or Defensive Fire produced and controlable *at volition* could be a *military* disadvantage! and we have yet to learn that modern discipline, and an attentive exercise in the use and appliance of the improved fire-arms of the present day, can achieve less for the British soldier than the discipline of the olden time did for our archers at Poitiers, Cressy, and Agincourt, and through the two centuries of glory won by their hand and eye in the wars of the Tudors.



HISTORICAL RETROSPECT OF FIRE-ARMS.

1.

It was not until about the end of the 13th and commencement of the 14th centuries, that those traces of the knowledge and use of a matter whose powerful effects were developed by Ignition, and whose ingredients are still imperfectly known to modern science under the name of the GREEK FIRE,* were partially resuscitated after a lapse of centuries in the form of GUNPOWDER.

2.

Then first began the epoch in which either invented anew, or made known to Europe by some other means, gunpowder became applied to the purposes of war ; but its use became more generally extended, only during the latter part of the 14th century. The expansive force of cords, of particular kinds of wood, and of steel, applied in the Balistic arms of the period, the use of which had been continued with little change from remote antiquity, was far behind that of gunpowder in its effects, which could be applied to the projection of the heaviest masses to a considerable distance ; the latter, therefore, despite the doubts, prejudices, and sturdy opposition of the *Artemonists* † or Engineers of that day, gradually excluded those ancient machines from the scene, as the *art* to make others became more diffused, and the application of such a means afforded.

As illustrative of the momentum or force of projectiles fired even horizontally from modern artillery as compared with the momentum of one of the most formidable engines of antiquity and the middle ages, the Battering ram ; it was estimated by an eminent artilleryist at the close of the last century, that the momentum of a Battering ram 2 feet 4 inches in diameter, 180 feet long, with a head of cast iron of $1\frac{1}{2}$ ton weight, the whole ram with its iron hoops, &c.,

* Its use and composition appeared alike to have fallen into oblivion after the Crusades, in which wars, the Saracens employed it with frequent effect against the Christians. The knowledge of its composition appears to have been either surreptitiously obtained by the former from the Greeks, or, perhaps, with more likelihood, derived from the same source whence Callinichus, the architect of Heliopolis, himself obtained it about 670, i.e., from India.

† *Artemonis* was the name then given to the science of war machines, and the technists or engineers in that *arte* were so designated.

weighing 41,112 lbs., and moving by the united strength of 1000 soldiers, would be only equal to that of a ball of 36 lbs. shot point blank from a cannon.

3.

In the first century of the use of gunpowder in Europe, the proportions in the admixture of its component parts were still very various. Each ingredient was reduced separately to powder, then mixed as thoroughly as possible, and used in this meal-like form. To facilitate its preparation, hand mills were at first resorted to, and these are spoken of as used for that purpose in 1340, at Augsburg, in Bavaria. But a century nearly elapsed, before (in 1435) the first Powder *Stamping* Mills on a larger scale were established in that cradle of modern industry and art, the city of Nuremburg.

About the commencement of the 16th century, the strength of gunpowder was increased in Germany almost one-third, by the transformation of the hitherto mealed into corn or grain gunpowder; a process first commenced by the French in the latter half of the 15th century, to prevent the prejudicial effects of its binding. It was then divided into three sorts—siege powder for guns of heavy calibre—Arquebus powder, and petrial or pistol powder, which consisted of the finest grains. The powder for priming, and that used for fireworks and incendiary projectiles, of a kind which ignited less rapidly, remained ungrained. Corned gunpowder was, nevertheless, first generally used in England at a much later period, that of the reign of Charles I.: both artillery, fire-arms and gunpowder being imported long after the first establishment of a Cannon Foundry in Houndsditch by Henry VIII., in 1535.

4.

With the same merit to belief as some chronicles relate that a mortar was the utensil used in the accidental discovery of the projective force of gunpowder in Germany, by Schwartz,* it is no less probable that the first implement in fire-arms greatly resembled such an utensil, and their funnel or crater-like interior form was adapted to receive and throw stone and leaden balls of different sizes. It was

* Vague attempts to throw discredit upon this tradition, have been made of late, both in France and England, but with equal success. In the latter country it has been claimed for Roger Bacon, but though the latter may have become acquainted with the component elements of gunpowder, from the work of Marcus Græcus, there is certainly no evidence of his having effected the practical experiments therewith, which are attributed by early and yet unrefuted tradition to Schwartz, who according to some authorities lost his life in the course of his experiments. In a paper of great professional and historical research continued through several numbers of *The Military Review*, 1852-3, the evidence of Schwartz's merit to a practical discovery of the effects of gunpowder (in Europe) is clearly argued.

probably discovered shortly afterwards, that with such short cylinders there was a very great difficulty, if not impossibility to throw a shot with any certainty of aim, and they were then made about eight times as long as their capacity was wide, leaving the interior part for the reception of the powder charge of a conical form, whence arose the *Metzen*, Stone Crusher, or Thunder-Büchsen* of the Germans ; (Fig. 1.) the Bombarde of the French and Italians.

5.

Although the mechanism and use of these engines of war were much more simple than those of the ancient projective machines, yet great difficulty was found in the construction of the former in regard to their resisting power and durability. As things of simple conception and easy of structure, form the earliest beginning of every art, the first or primitive cannon were made of wood ; the inner cavity of which was lined with strong sheet iron or copper, and bound externally with numerous iron hoops like the staves of a barrel. (Fig. 1.) Improving on these at a later period, a series of strong wrought iron bars were closely fitted together at the edges after the same manner, or welded together in the length, and then firmly bound with a number of strong wrought iron hoops. But towards the end of the 14th century, the majority of cannon were cast in iron, and at Augsburg already in bronze. In the infancy of the art, unskilled in the scientific relation and proportion of the charge to the strength of the cylinder, we find these stone-throwing guns of enormous size and weight.

The Bombard, a later and further improvement on the first instruments of destruction to which the use of gunpowder was applied, was of less simple construction ; and as the most considerable of all the early artilleristic engines, it remained for a long time the most important piece, and gave its name for a period of three centuries to the soldiers of Artillery, (Bombardiers). It was formed of two cylinders of almost equal length, the anterior one, the bombard proper or *Trump*, being nevertheless the widest. They were cast together or separately ; in the latter case, the lesser cylinder which formed the chamber and breech called the *Male* (Masculo)† was made to enter and fit into the larger one with such precision that at the points of junction, the least vapour could not escape. The whole was then imbedded for one-half of its length in massive beams or blocks of

* Büchs, Büchse, plu, Büchsen, the early generic name given by the Germans to cannon, and afterwards to hand fire-arms—from *Pyxis* a box.

† Some writers of the 13th and 14th centuries designate Bombards under the generic name of *Vases*, from their Vase-like mouth, though externally they were conical.

wood connected by bolts, which were held fast by means of rings and bands of iron. There were also though more rarely, bombards cast of a single piece; as the iron bombard called St. Paul, of one piece, in the inventory of the artillery of King Lewis XI. of France, 1463. To transport these with their beds, they were laden upon waggons. In this manner, for many years they were dragged before besieged castles and towns at a great expense of money and labour, when they were unladen from their waggons, fired often lying upon the ground, and worked as effectively as could be expected from engines of such imperfect structure, in which process the prevention of the strong recoil required great precaution and exertion.

6.

These ponderous and awkwardly massive machines being more especially used for the defence and attack of fortified places, it was imagined that by increasing their size, still greater effects would necessarily be produced, and this was carried to such excess, that they became not only extremely difficult to move and transport from place to place, but required also such large charges of powder, that they readily burst,* and frequently destroyed the very walls and defences of the besieged themselves. Notwithstanding these defects, it must be admitted, they frequently produced very favourable results; and though these were not altogether brought about by their accuracy in striking the object against which they were directed, and by their material action, yet they greatly operated upon the *morale* and imagination of the enemy, by the immense stream of fire, report, and smoke, which attended their discharge, and by that means rendered him more tractable and yielding.

The disposition in this Country in the present moment to return to the notions of the Cannon founders of the 15th century in regard to the superior advantages of magnitude of size in pieces of ordnance, would seem likely to lead our modern *Artemonists* into the same errors of exaggeration. For ourselves we see therein less a proof of real artilleristic progress than a striking illustration of that ever recurring return to the ideas of the past, which lost sight of for awhile emerge again as it were into life, to be claimed as *new* ideas and cited as evidences of the progress of the age! In the course of

* Mahommed II., 1452, caused the largest cannon on record to be cast at Adrianople, by Hungarian cannon-founders, for the siege of Constantinople. It threw a stone ball of the weight of twelve hundred lbs.; its calibre or bore was twenty-seven inches, and to set it in motion, the united strength of seventy oxen and two hundred men was required. It occupied two months to transport it from Adrianople to Constantinople, a distance of thirty-six hours march only; arrived there, it was fired but seven times a day, as it required two hours to load it. It burst after some days firing.

these pages we shall have more than one opportunity of signalling this feature when adverting to the numerous so-called *new* inventions in Arms and Projectiles which the unexpected difficulties of the recent siege of Sebastopol and the inaccessible character of the Russian fortresses of the Baltic have called anew into existence.

Eventually the idea gradually evinced itself to decrease somewhat the bulk of these engines. They were then cast of a single piece and the whole of the interior of a cylindrical form, and no longer conical at the mouth; which became the distinguishing difference between the Cannon (from *canna* a tube or cylinder) and the Bombard with its vase-like conical mouth. These improved and lighter pieces were then mounted upon strong wooden frames or carriages furnished in front with two solid or *block wheels*, with a kind of wooden adjusting gear affixed behind, in order to give the gun a somewhat better direction when laid.

7.

The greater convenience of iron balls having been ascertained,* longer pieces were now cast for their use, to which the names of cannon—cannon royal, were given; which although still retaining in their interior a funnel-shaped or cylindrical contraction for the reception of the powder charge, gave a much more certain shot than the bombards, and had already externally much resemblance to our present cannon. About the end of this century, the conviction of the inutility of over large cannon was established, and gradually as these were abolished, they were replaced with lesser ones, but cast with better proportioned dimensions. These cannon were further mounted on wheel carriages furnished with limbers, and the lighter ones were used in all engagements in the field, under the name of Carro-Cannon, Field-Culverins, &c.

8.

Antecedent to these later improvements in Artillery, the first Hand-Fire-arms had made their appearance and came into use about the middle of the 14th century. For reasons which will be obvious to the reader, the hand or portative fire-arms were a later product of the application of gunpowder to war purposes, than bombards and cannon. The latter, difficult of transport from their unwieldy size and weight in the earlier period of their use, and applied mostly to the defence of towns and castles, required little or no mechanism to adapt them to the use designed in a stationary and frequently permanent position. While on the other hand, for the creation of a

* In 1497 they had been used at the siege of Boppard, in Germany, and were then considered as a remarkable improvement.

fire-arm susceptible of easier transport and ready use as a weapon of offence in every locality, the lapse of a certain time was necessary before the ingenuity of the mechanist could devise and establish even the ruder elements of form and mechanism requisite and applicable to such ubiquitous purposes ; though the norm of such a mechanism was already presented in the cross-bow ; and guided by this, it may be readily imagined that previous to their establishment they passed through several rude stages of progress.

At the period referred to they were variously called *Bombardelles*, *Hand-Coulevierins*, *Arquebusses*, *Harcuobuts*, and *Escopettes*. They consisted of strong wrought iron cylinders or barrels, from fifteen to fifty lbs. weight, which were served by two men, and were fixed on a stand, frame-work, or in a shaft or stock, and were fired either by means of a slow match or piece of tinder.

Another kind of hand fire-arm took rank with these at this early period, evincing how soon the idea of *Loading at the Breech* (so erroneously considered by many in the present day to be a *modern* invention) was conceived by the early artists in gunnery. This was designated by the name of a wedge or quoin-gun. (*Fig. 2*). The barrel as will be seen, (*a*) was fixed or mounted upon a three-legged wooden stand or tressle furnished with rollers or castors. Behind, for the reception of the charge of powder, was a moveable chamber with a vent, (*b*) which on the ball being placed in the barrel, was pushed in behind it, and immoveably jammed there by means of a wedge (*c*) and of a strong chamber guard (*d*) affixed to the barrel. In other guns constructed to load at the breech, leaf-valves and screws took the place of the wedge ; but all these modes of closing up the breech of the gun still failed in that early stage of the mechanical art, in the requisites of firmness, durability, and security against the escape of the gases of the powder ; and these sort of fire-arms were consequently, though not wholly abandoned, yet of unfrequent use.

9.

In order to obtain a greater facility of aim with these kinds of fire-arms, trunnions were eventually affixed to them near their centre of gravity by means of which, when they were laid upon a moveable fork or crutch, which turned upon an axis, they could be moved and pointed both in a vertical and horizontal direction.

The cylinder terminated in a handle, by which it was seized and laid with the left hand, and the match applied to the vent with the right. These hand-guns were frequently seven feet in length ; fired eight ounce leaden balls, and were called *trussile-guns* and *wall-*

arquebusses. They were frequently taken into the field and used for the attack and defence of important posts. With some later modifications, under the name of Stone-throwers, (*Pierriers*) they kept their ground up to a very late period, as a light breech-loading cannon, throwing a three pound ball, and were much in use in the 17th century, particularly for the defence of small merchant vessels, to prevent being boarded from boats; for sea defences, and that of castles where the terre-plein of the ramparts was too narrow to allow of the recoil of larger pieces of Artillery. They were likewise used to throw coils of chain, nails, pieces of old iron, and stones.* (*Fig. 3.*)

10.

Ball-throwing barrels manufactured from wrought or bar-iron, having been found so durable, the hitherto heavy arquebus, was much improved by the end of the 14th century, when they were made after a lighter fashion, their barrels set in a sort of wooden sheath, (shaft or stock) and these were held even against the shoulder on being fired. This arm was still discharged with the right hand by means of a slow match, but improved upon by the addition of a vent opened at the *side*, and beside this, with a *Pan* to receive the priming powder, which was protected from accidental ignition by a moveable lid or cover.

Although these discharged but comparatively small balls only, yet they could not be fired without a rest. For this purpose a sort of crutch or fork, generally of the length of four feet, was stuck into the ground, upon which the gun was rested when fired.

The larger and heavier fire-arms were furnished underneath with a projection or hook, (*h. Fig. 4.*) which on their discharge was rested on the walls or other supports, to diminish the recoil of the pieces for the marksman. This kind of fire-arm was called the *harquebut*, *hack* or *hookbut*, differing from the longer crutch of the (*arquebuse à croc*), (*Fig. 4.**) and is the sire of the modern wall-musket.

11.

It was not till the time of the emperor Charles the Fifth, (a century later) that the Spaniards made use of longer fire-arms, which carried two ounce leaden balls, but on account of their weight, also, they could only be fired from rests, and were called *mousquets*.

These fire-arms were gradually made lighter and smaller, so that more balls could be fired from them in a given time, of a size or calibre of from eighteen to twenty to the pound; and in this manner

* A Portuguese piece of this kind was fished up near the Goodwin sands, at the end of the last century, and is figured in the *Archæologica Britannica*.

was formed at that later period, the type of the now obsolete Flint Musket, which maintained its place for upwards of two hundred years.

12.

The use of fire-arms had become very general on the Continent of Europe, when towards the end of the 14th century, the *Match Lock* was invented; an improvement greatly required to alleviate the difficulty so long experienced in firing the piece with the hand by the slow match, which with the whole process of adjusting and pointing the gun, rendered the aim and firing very uncertain.

The match-lock (*Fig. 5.*) consisted in a crooked iron lever, (*a.*) which in the upper part was split into two divisions, between which a piece of burning slow match (*b.*) or tinder was held fast by a screw. Through the lower part of this lever, a steel pin was passed, upon which, when the finger pressed upon the trigger, (*d.*) it moved accurately towards the pan (*c.*) When the cover of the pan had been previously pushed off, the priming powder therein, and thereby the powder charge in the barrel, were ignited with tolerable certainty through the vent in the breech of the latter, if prevented neither by rain or a high wind. But this means of ignition required that the men should always carry a provision of several ells of ignited slow match; which, at night particularly, betrayed their presence very readily to the enemy, and led moreover to frequent accidents in loading. The mode of carrying the ammunition by the Musqueteer was also very inconvenient. Twelve powder charges only, were the usual number for each man, carried in as many small wooden cylinders appended to a bandoleer or shoulder belt; a bag or pouch contained the same number of balls, and a pound of priming powder, (of which in the imperfect mode of firing, a considerable quantity was always spilled,) was carried in a flask depending on the right side of the soldier. The slow match was carried partly wound round the bandoleer, and partly round the arquebus or musquet itself.

When we consider how slow the mere act of loading could proceed with such a mechanism, how correctly before every discharge of the piece, the slow match was required to be placed in the cock, so as not to miss the pan; that then the priming powder had to be poured into the pan, exposed to every risk of being scattered by the wind or damaged by the rain, the tediousness of the operation of Firing may be readily imagined; and that the small number of twelve cartridges was an ample immediate supply of ammunition for the soldier in those days.

Nevertheless, and under all these material disadvantages, the

Arquebuseers of Spain, Italy, Germany, France, and Flanders, had acquired a great skill and aptitude in the use of that arm, the individual range and effect of which was far greater than that of the modern Flint Musket. In fact, from the battle of Agnadello, 1509, up to the time when Field Artillery were improved, the ponderous Arquebus and heavy Musquet were the chief arbitrators of battle.

13.

About this time, also, it was, that the *Escopette*, a lighter description of this fire-arm, were first used in the Sports of the Field. But strange as it may sound to our modern Gunmakers and Sportsmen, it is not from English sources that a knowledge of the application of fire-arms to the Chase is to be obtained, any more than to War; for the bow and cross-bow, the former more especially, were the arms yet long pertinaciously adhered to in this country, and all researches on this subject also, must be made among the peoples of the Continent. The most ancient document verifying this in France is the "Ordonnance des Chasses," or "Sporting Regulations," of Francis the First, issued in 1515, which makes clear mention of the above-named fire-arm as arms of the Chase, and speaks of them as of no very recent invention.

In 1525, in many towns of France, Companies under the style and title of Knights of the Arquebus, consisting of the gentry and wealthier citizens, formed themselves into Associations, under the sanction of the king's letters, to practice shooting with this arm at certain times of the year; and in many Towns of Flanders, associations of this kind had existed anterior even to 1515.* In Germany, Target Practice had long been instituted, and practised at Nuremburg, in 1429, at Augsburg in the following year; and Prizes for Arquebus practice established in various cities of Switzerland in 1450.

Though the archives of St. Etienne, in France, shew that a manufactory of Sporting Arms already existed in that town long before 1535, the period when the town first gave its attention to the manufacture of Arms of War; yet the chief arms of the Sportsman were still throughout France and the greater part of the Continent,

* This admirable custom revived throughout Belgium in the present day, the government of that country has wisely given its sanction to the establishment of a "Federal Practice Ground for Shooting with the Rifle," in the plain of Linthout, near Brussels; so that the customary Annual September Gatherings to dispute the Prize at Rifle Shooting at Brussels, will now have full scope to perfect a skill in that arm, the predilection for which, analogous to that always shown by the Flemings for the Arquebus, has constituted them from a very early period, next to the Swiss, the best marksmen in Europe.

the bow and cross-bow; the latter of which as a Sporting arm, was not abandoned even on the Continent where fire-arms were more generally used than in England, until the improvement in the construction and management of the arquebus had been sufficiently effected, to allow of firing at game on the wing or running. In this—as with everything else the perfection of which is developed only by degrees and with a progression more or less slow—it is easy to imagine that the lovers of the Chase began first by firing with single ball only, both at the lesser and larger game. It would then doubtless have suggested itself to load with two or three balls, to cover a larger surface; and eventually the number of balls was increased by decreasing their size; till lastly, the so called buck-shot, swan-drops, and small-shot invented in Italy about the middle of the sixteenth century, were progressively arrived at, with which the lesser as well as larger game were killed, first at the standing shot; until insensibly the art was acquired, to fire both on the wing and running.

The process by means of which lead was reduced to the shape of small spherical grains as in small shot was long kept a secret, and it was not till a much later period, that a manufactory of this necessary article for the sportsman was established in Paris, in the tower of Saint Jacques la Boucherie; and eventually introduced into England.

In our present Shot manufactories the lead in bars (pig lead) is lifted to the top of the shot tower by means of a windlass and chain, worked by steam. The metal is then put into a furnace; the fires of which are maintained night and day attended to by two sets of men, one for the fires and the other to pour the melted lead into the metal strainers. After passing through the strainers it falls a height of 150 feet (the passage through the air giving the shot their shape or form) into a large vat or tub of water. From this they are dipped out with a ladle and thrown on an inclined plane, down which they run into a drum heated by steam and worked by machinery, until the shot are dry, when they are passed into a revolving polishing drum which stops by the action of machinery every five minutes. From this drum they are thrown into a hopper, and from this over a series of inclined planes, when the defective shot are carried off, and the perfect shot through sieves into drawers, where they are assorted by the action of the machinery on the sieves, and lastly into large boxes from which they are taken, put into sacks and weighed; when they are ready for use.

The idea of loading small cannon at the breech which we adverted to at (Page. 8) in the early Quoin tressle-gun, was now, 1540, applied

by no less a personage than Henry II. of France, (who with his love of arms, evinced great mechanical genius), to the hand arquebus, which he contrived to *open at the breech by means of a hinge*.

In endeavouring to fix a date from facts, for the period of perfection in the use of fire-arms for Sporting purposes, the curious will be greatly assisted by a small Italian work, entitled, "*Excellenza della Caccia de Cesare Solatio Romano*," printed at Rome, in 1669, who states, that at the time he wrote, the art of shooting *on the wing* had been known in Rome about eighty years, so that it may be taken for granted that in Italy, Sportsmen began to shoot on the wing about 1589. It is therefore natural to suppose that about the same period that practice became tolerably general on the continent of Europe. We may, therefore, fairly consider, that until about 1580, Sportsmen did not yet fire on the wing nor even running, excepting at the largest game. We are further supported in this assurance, by reference to the "*Chasses*," "Sports" of Stradan, who flourished about that time; among whose figures, no Sportsman is represented firing with the arquebus, either "on the wing" or "running." In the French poem, entitled "*Le Plaisir des Champs*," "The Pleasures of the Field," by Claude Gauchet, first printed in 1583, (the author was a Sportsman by profession) we find several kinds of shooting with the arquebus described; and he relates both his own exploits, and those of some sportsmen of his acquaintance, but in none of these does he speak of firing on the wing. Sometimes he describes partridge shooting *on the snow*, at others, wild ducks *on the water*, &c., &c.

In speaking of animals, he cites *one* single instance of shooting a wild boar *running*, which he pierced "*through and through with two impetuous leads*."—Another was killed by him firing from the fork or rest, but the animal was standing; as also a roe standing; and some young wild boars in a litter of five with the sow, of which he killed three at once, also a standing shot. Lastly, passing along the edge of a wood, friend Gauchet, arquebus in hand, espies a wicked renard making off with a young leveret towards his hole; on this Gauchet slips into the wood to head the fox and fire at him as he passes, but he fires only at the moment when the fox *stopped* to shoulder his prey better.

14.

All the disadvantages and difficulties presented in the Match-Lock, to which we have adverted in describing that first step towards improving the mode of ignition of fire-arms, were at length alleviated, and in some measure obviated by the invention of the German *Wheel-Lock* (*Fig. 4 and 6*), in 1517, at Nuremburg. But in this also,

the mechanism was much too complicated, liable to injury and expensive, to keep its place for any length of time.

The wheel-lock consisted of a small circular steel wheel-plate, sharply toothed or notched on its circumference, fixed under a pan furnished with a sliding cover, (*d.*) the bottom of which pan it worked into, and there reached the priming powder. Externally, the wheel had a small square axle, (*e.*) upon which it was turned or wound up by a key, spanner or winch (*i.*)* In the interior was a chain which, upon winding up the wheel, wound itself round its axis, and at its other end was attached to the moveable arm of a spring which was distended on the winding up of the wheel. A pin then caught in a tooth of the wheel, held it on the cock, and the key could then be taken away. On the other part of the lock stood the hook or cock (*a.*), which held between its jaws a piece of iron pyrites, or a blunt flint (*b.*) screwed in. To fire the piece, this cock was moved towards the pan upon which it was pressed by the spring (*c.*); the trigger (*f.*) was then pulled with the finger, when the pin before mentioned released the wheel, which, obeying the action of the distended spring, effected its rapid revolution round its axis, by which its notched circumference produced a violent friction, and kindled sparks which ignited the priming powder in the pan, and then the charge. Some time afterwards, the little chain in the interior was wholly omitted, and the spring allowed to act directly on the circumference of the wheel; the pan was moreover protected from the wet and dust by a sliding cover, which, self-acting, moved off on the spanning of the wheel. To guard against the accidental firing of this description of lock it was frequently furnished with a safety bolt, as at (*g.*)

The proper management and handling of this lock required as much skill, as it did a certain degree of care, not to injure its mechanism; besides which the winding up of the wheel went but slowly, and therefore quick firing was out of the question.

15.

The invention of the wheel-lock was nevertheless an important stride in the mechanism of fire-arms; and Nuremburg, to which we have already had occasion to allude, soon became especially remarkable as the birthplace of many of the most important improvements, the merit of the invention of which has not unfrequently been assigned to, or assumed by other places. The prevailing ignorance that has

* The mechanism of this lock resembles that of the Pocket watches which were also invented in that city.

existed in modern times, and yet exists generally, up to the present moment, of the ingenious efforts of the early craftsmen in fire-arms and artillery, has greatly favoured the assumption of originality which has been paraded by the numerous aspirants to novelty in the fire-arm, and projectile improvements of the present day. Those even who have affected to treat upon the subject, (from some of whom a more intimate cognizance of the matter, and a more correct information might have been expected), appear nevertheless either to have wholly ignored what had *been done* in the *past*, or to have drawn their meagre information from sources, of the correctness and authenticity of whose data they were unable or careless to ascertain. Yet is it to the artizans of Germany, that the Rifle owed its origin at the close of the 15th century. In 1498, grooved barrels (with the grooves *straight*) were the arms of the citizens of Leipsic at Target Practice, and towards the middle of the next century in 1520, Augustin Kutter or Koster of Nuremberg, became celebrated for the perfection of his so called rose or star-grooved barrels, having a *spiral* form.* Three hundred years and more were, however, to elapse before Kutter's conception was to receive its full development from the genius of a DELVIGNE; with the aid of a new means of inflaming the charge, which then undreamt of, was to effect in our day the most surprising revolution in the construction of fire-arms since their creation.

The discovery of the spiral groove has been somewhat disparagingly attributed by Captain Panot as "incontestibly" due (though upon no defined grounds that we have seen) to accident rather than to Theory. But from the historical evidence that target practice had been a diligently pursued recreation of the citizens of many cities in Germany for a long period, and that the suggestion first of the straight groove to the arquebus, must have led to a closer study of the theory of projectiles, and this, eventually, to the suggestion and practical test of the spiral groove, we are disposed to differ with his authority on that subject, and for the following reasons:—In numerous arms of every variety of calibre of that and a closely succeeding period—which we have diligently examined—we have found such a variety of the inclination of the spiral and number of the grooves, that we are disposed to think, this very variety must have arisen from a pursued and progressing study of the Theory itself, and from a perfectly established knowledge of the influence of the spiral grooving and its degree of inclination, upon the flight of the projectile. A knowledge

* From the star-like shape presented by the grooves at the muzzle of the piece, this invention has been attributed by some German writers to Caspar Zoller, of Vienna, at an earlier period—the *end* of the 15th century which is doubtful.

which like many others we could adduce, became lost at a later period, from those multifarious causes and mutations of custom, fashion, &c., which produce such oblivion of the things of yesterday ; till disinterred anew by the researches of a Leuttman and a Robins, to be again partially lost sight of, till the advent of a Delvigne. To George Kühfuss, and Caspar Reinagel, the wheel-lock owed its subsequent improvements ; and Wolf Drüner, of Nuremburg, was to become shortly famed in Germany, for his improvements in forging and boring.

16.

Almost contemporaneously with the German wheel-lock, the Snaphance lock was invented in Spain, for which reason it was also called the Spanish lock. Every English writer who has treated the subject of the early fire-arms, appears to have fallen into the same error as to the origin of this lock ; doubtless, as with many other things, from having made a mere reiteration of the errors of some nearly contemporaneous writer, without due research ; citing, and taking for granted what he may have written to the best of his belief, or the vulgar report. Misled by the English corruption of the Dutch term *Snapphahn*, anglicised *Snaphaunce*, (Snap-cock), and from the circumstance that the English auxiliaries in the wars of the Low countries first learned its use there, where it had been brought by the Spanish musqueteers ; those writers represent it as a Dutch invention, in the same manner as our soldiers adopted it under a corruption of its Dutch name. In this lock, (*Fig. 7.*) the spring which gives the blow (*a*) is outside the lock-plate, and works with its moveable end at (*b.*), upon an arm of the snap-cock (*c.*), the other arm of which (*d.*) on the cocking of the lock, rests upon a pin projecting from the inside through the lock plate (*e.*), which on pulling the trigger, draws back, whereby the spring (*a.*) drives the cock with its flint against the ribbed steel surface of the pan-cover, and there ignites the priming. At first, the pan-cover was separate from the steel which struck the fire, and only attached by a crooked guard. At a later period, the lock was constructed with a second projecting pin (*f.*), which enabled it to be put at the repose or half cock.

17.

Before the end of the 15th century, the use of fire-arms had become so general, that the Cavalry also began to use them. The larger kind of these fire-arms were called *Petrinals* or *Poirinals*, and were a short kind of carbine, which fired leaden balls of large calibre. The butt end of their stock was much curved, and upon being fired,

was rested against the lower part of the cuirass, or upon the saddle-bow, in order to resist better their recoil, but as the eye could not be well brought to the line of sight or adjustment, objects only which were quite near, could be hit with any certainty. These arms were carried suspended from the shoulder by a belt.

The first introduction of fire-arms in the Cavalry, has been usually attributed to the French, who armed their mounted Arquebuseers with pieces of the length of two and a half feet; but we are rather disposed to accept the dictum of some German military authorities on this head, and to consider that the French derived this practice from the German Reitres, who sought service in the civil wars of France, and who were already celebrated for their use of that arm. This practice became at a later period so confirmed, as to establish the fire-arm as the arm *par excellence* of the cavalry, which here and there preferred firing, to attacking with the *arme blanche*, a custom that kept its ground for nearly two hundred years.

The Spaniards increased the length of these fire-arms, and gave to them the name *Carabina*, (*Carbine*). The duke of Alba, on his march to the Netherlands, is said to have derived good service from some Companies of horse, to which he had given this arm, as an improved imitation of the German Reitres; and the carbines of that period served as the type, or primitive idea, from which those of the present day have, through a variety of alterations, gradually assumed their present shape.

18.

The shortest fire-arms were the *Pistol*, which first received that designation in the middle of the 16th century. It is, we think, correctly assumed by Cibrario, that they derived their origin from the span-long hand-barrels, at first called *bombardelles*, made at Perugia, (*Pistoja*) in Italy, in 1364, the balls fired from which had sufficient percussive force to penetrate the armour worn at that period.

The first pistols were for the most part of tolerable length, some of their barrels being from twenty to twenty-five inches long. These date from 1547. Their stock was sloped but little, and mostly terminated in a sort of knob, (*Fig. 6.*) which in the course of time changed into the form of pistol stock, used in the present day. This kind of pistol was carried by the German Landsknecht, (pike-men of the infantry) as well as by their cavalry, which acquired for their *Reitres* in France, under Henry II., the name of *Pistoliers*. With the latter description of troops, these arms, prescribed by a royal ordonnance of the king of France for all his "Archers of Ordonnance"

were, in the rule, provided with wheel or snaphance locks ; for in all probability, the use of the match-lock, which was almost wholly confined to the infantry, was attended with too many inconveniences on horseback.

19.

It was not alone, however, in the lesser fire-arms, that progress had now been made. Cannon were also greatly improved, and a much more rational conception of their construction and use was now exhibited. But the merit of these improvements is by no means to be arrogated as we have seen it in the present day, by ourselves ; and it is not at home that we must yet look for any effort of the kind. For, long unskilled in the Mechanical Arts, not only without inventive genius, scientific aspirations or taste, but with an unawakened manufacturing and commercial spirit, we lived yet as it were isolated in our own limited National habits of thought, and all that was then known of art of any kind in England was of foreign product. It is, therefore, to the workshop of the Foreign artizan, to the restless spirit of inquiry and ingenuity of the German, French, and Italian mind, that we must still look for every progress in fire-arms and artillery, as to the studio of their sculptors and painters for those higher productions of Art and taste which until the middle of the last century found no soil congenial to their creation in England.

The institution of a School of Artillery, (the first foundation of the kind in Europe) at Venice, at the commencement of the 16th century, of one somewhat later at Burgos, in Spain, in Sicily, and other of the Continental states, contributed doubtless most favourably to this ; for ignorance, prejudice, superstition, and pedantic Craft-mystery, had up till then weighed heavily enough upon the Artillery, and especially upon the art of Cannon founding. To the Swiss Moritz was due at the beginning of this century the invention of the machine for *boring* Cannon, so that they could now be cast full and solid, whereby the manual labour of the old system was certainly greatly reduced.

In order to arrive at a more correct relation and proportion between the length and strength of cannon to the size of their shot, the emperor Charles V.; who had inherited from his father Maximilian, the predilection for the Artilleristic science which that monarch had so especially evinced, and who effected so much towards its development ; caused experimental researches to be made at Brussels, in 1521, (12th year of the reign of Henry VIII.) which elicited, that a length of from seventeen to eighteen diameters of the ball, was the length most appropriate to the charge of powder used therewith. Guided by these results, he ordered cannon to be cast at

Malaga, for the siege of Tunis, on a new model and proportions, which were called the Twelve Apostles, these although they threw a forty-five pound ball, were found so excellent, that similar pieces were cast throughout Spain and the Low Countries, which became for a long time the pattern for the European Artillery.

Field-guns were now first properly distinguished and regularly separated from Siege cannon, and the latter from mortars. These no longer threw stone balls only, but hollow iron balls also, which were eventually called *bombs*. But the variety of cannon was still too great, (some States had no less than from fifteen to twenty different kinds) and very unfavourable to the use and combined effect of artillery.

20

It was vainly endeavoured, about the middle of the 16th century, to reduce this numerous variety to from six to eight different kinds; but the form and number of the existing cannon were already too great to justify the great expense that a thorough reform would have entailed. This proceeded therefore but slowly, and so much so, that long after the Thirty years War, the so called *Culverins* of the 15th and 16th centuries were still in use, the length of which was not unfrequently from forty to sixty, and more, diameters of the ball. These, it is true, gave a great range, but were no longer calculated for the description of powder of that day; and the field pieces of the 15th and 16th centuries described by Fronsperger in 1582, remained thus long in use throughout Germany—the Noth Schlangen or Culverin carrying a 15 lb. ball, a piece $8\frac{1}{2}$ feet long, and weighing from 22 to 30 cwt., requiring a draught of 10 horses, with 3 more to drag the balls and 2 to the powder waggon. The Falcon, of a length of 8 feet, weighing from 13 to 20 cwt., requiring 6 to 8 horses, and 1 each for the ball and powder waggons. The Falconet or little Falcon, a 2 pounder, weighing 5 cwt., of a length of $5\frac{1}{2}$ feet, dragged by 4 horses with powder and ball. The weight of the charge of powder for these different pieces was generally half that of the projectile; and the breech was of the thickness of the ball. The ordinary charge was enclosed in a cartridge, and when close on the enemy “*grape canisters*” were fired—so called from a cylinder filled with a heterogenous charge of nails, cut cubes of iron in the shape of dice, and balls. The lowest calibre of the Battery pieces was a 24 lbs. ball. On the march these were not carried on the gun carriage, but upon a strong framed waggon.

As a striking feature in the History of Artillery, and in remarkable contrast with the neglect of that Arm in this Country for

so long a period, in which not only the western and southern continental states of Europe had made such progress ; the much poorer state, Sweden, itself, had turned such especial attention to the casting of cannon, and the manufacture of fire-arms, that already in 1431, (contemporary with Henry VI. of England) cannon foundry and master gunners, formed an important feature in the Military organization of that country ; and Murberg makes mention even of a description of Flying Artillery with which that people opened the engagement, in their wars. In 1452, in the expedition of king Charles Kuntson against the Danes, he took with him as many as twenty cannon into the field, and under Charles IX., such attention was directed to the Artillery, that in 1594, Sweden reckoned 1432 brass, and 2027 iron cannon of all calibres in its Arsenals ! Great attention was also paid in that country to the manufacture of gunpowder, a vast quantity of which was used ; as in firing, the custom there was to charge with a pound of gunpowder for every pound weight of ball.

In England, Artilleristic progress went but slowly ; for it was not until the third decade of the 16th century, (Henry VIII.) that a Cannon had been cast in this country, all those in use having been obtained from foreign parts. Nor was it until 1584, that the art of Gunnery, to use the expression of the antiquarian Pennant, " was flung into a system " in this country—which was effected by one William Thomas, Master-Gunner of the queen's ship the " Victory."

21.

Early in the 17th century, the king of Sweden, Gustavus Adolphus, appeared as the next great Reformer in Artillery and Fire-arms. He decreased as much as possible the weight of his Field Artillery, and introduced the practice of loading them with several small balls (grape), using them in all his campaigns with such judgment, that it was impossible that other than favourable results could accrue to the science.* But in lightening his Artillery, he went somewhat too far, for his so called *Leathern Cannon*, according to Francheville in his *Histoire des dernières Campagnes de Gustave*, heated so much after ten or twelve rounds, even with very small charges of powder, that it was necessary to let them cool before further firing.

* * To a considerable portion of his infantry, he also gave the match-guard invented by the Dutch, consisting of a tin tube, into which the match was inserted, to protect it from the damp and rain ; he further introduced in 1624, the calibre for his musketeers, which was adhered to in Sweden up till 1811, and which was that of the old arquebus ; viz., a one and a quarter ounce ball, with a self-acting pan-cover to the cock of the wheel-lock, which moved off when the cock was let down.

These leathern cannon, so celebrated in the wars of that monarch, have been erroneously affirmed by many modern historians, to have been the invention of the Austrian, Baron Melchior de Wurmbbrand, and to have been first used at the siege of Wormdit, and at the battle of Leipsic.* As with many other things, nevertheless, even in the present day, in Arms and Artillery, they were then but a resuscitation; for the Venetians used leathern cannon in the 15th century, the figures of which are extant in early Italian archæological works. The Swedish leathern cannon in question, consisted of a copper cylinder of the thickness of one-eighth of the calibre, and of the length of fifteen diameters of the ball, securely closed at the breech by a strong false or *slip-breech* screwed on with a six thread-screw. At the place where the charge came, the resisting power of the gun was strengthened by iron rings, covered in the whole length with varnish or mastic, and thickly wound round with cords and canvass. At a short distance from the centre of gravity they were provided with iron trunnions at the side, and lastly the whole was made even with gypsum, and then covered with leather. A small iron tube was screwed into the piece in the place of a vent.†

22.

In the last mentioned year, this monarch had also instituted some trials with a shorter six pounder gun, suggested by a German artillery officer, Colonel Siegroth, which weighed no more than six cwt. and a quarter. This was especially intended to give greater effect to the discharge of Grape. It was a chamber gun—the powder charge was enclosed in a thin wooden box, to which the ball itself was fastened by wire. It proved very efficient; but we find no further evidence of its having been adopted. After numerous experiments, the king eventually adhered to a field-gun, either invented or improved by lord Hamilton, a distinguished Scotch officer in his service, which was introduced throughout the whole Swedish army. This was an iron gun, four feet long, which fired a four pound, or according to others a three pound ball. It could be fired thrice during the time a musketeer could load and fire once. On account of its lightness, it

* An error corrected in the August number of the *Military Review*, for 1852; in the pages of which periodical, both the professional man and the amateur will find more researchful, correct, and interesting details and data, on the rise and growth of the artillery science, than have before appeared in any English work.

† A leather cannon, weight 1 cwt. 0 qr. 7 lbs., formed part of the share of stores which fell to the British on the capture of Paris by the Allied Armies, 1815; and was brought from the Arsenal of Paris and deposited at the Royal Woolwich Repository, where it was to be seen some years ago. It was supposed to have belonged to the warlike Swedish monarch.

could be drawn by two, or if necessary, by one horse only. The king gave this light piece both to his infantry and cavalry. The former had two per regiment, and the king carried a great number of them with him from Sweden to Germany. This kind of field-gun was at a later period imitated in other armies. By this organization the number of guns was naturally greatly increased ; and in his first campaigns in Germany, the contrast was very great compared with the scanty equipment of armies of the previous period. In 1620, he rejected also the loading ladle with field-guns, and loaded wholly with cartridges, in which the French and others eventually imitated him. The firing with grape, which had hitherto been seldom customary but with siege-guns, and effected frequently in the shape of pieces of old iron, was as we have observed, by him first regularly established with field-pieces, in the special form of musket balls, enclosed sometimes in wooden or tin cases, at others in bags of coarse linen, or merely bound over and together with withies. By all these means, he gave both a greater facility of motion to artillery, and much more efficiency to its fire than it had ever attained ; and this, on his appearing on the scene in Germany, imposed not a little on his more unweildly adversaries.

Instead of the hitherto restricted employment of Master Gunners for the service of the artillery, who everywhere jealously strove to arrogate an exclusive capacity for the service of all guns, he wisely appointed the best informed musketeers of his Infantry regiments to the service of their own Regimental cannon, by which means he not only excited a spirit of emulation in his infantry regiments to attain a knowledge of that arm, so necessary for their independent operation at all times ; but was enabled to supply the place of the regular master gunners without difficulty. This was also more readily effected perhaps, from the circumstance that grape was almost always fired in his artillery. Sweden was, moreover, enabled of its own resources to furnish every description of arm. The muskets were manufactured in the villages of that country by the so called barrel-smiths, in which manufacture they paid their taxes. They were paid for their labour in money and corn, and often in the raw material. Each barrel smith was bound to deliver yearly fifty-two large muskets to the government. The cannon founders in Stockholm and Finspau, delivered cannon of the respective calibres from forty-eight to one pound ; and the powder mills of Nacka and Wallinge, furnished amply the supply of that article.

Notwithstanding the impulse given by the Swedish monarch to an improved organization of Field Artillery, and the obvious advantage

which his German opponents conceded to him as deriving from his reforms; yet so slowly progressed the correction of custom, routine and prejudice in all ages, that some years elapsed before he had imitators in the simplification and order, to which he had reduced that important branch of Military Organization; and the great Montecuculi, who wrote about 22 years after the death of Gustavus, says, "In the old Arsenals there is a chaos of Artillery without order, distinction, or proportions. Scarcely are there names enough to distinguish them; so much so, that there is no serpent, beast, or bird, whose names have not been given to some pieces," &c.

23.

Reverting to the chief subject of the present Retrospect—Small Arms; it was shortly after the Thirty years' war, that the *now* obsolete *Flint-lock* was introduced in France, and gradually adopted throughout Europe, with the new name given to the musket, of *Fusil*.* Yet, in France itself, the fusil was at first very sparingly adopted before 1763; the usual array of prejudices, short-sighted selfishness, &c., throwing every possible obstacle in its way, until as usual, Truth, in regard to its superiority over all then existing gunlocks, forced itself, *nolens volens*, upon the public mind, and Louis XIV. from 1699 to 1704 guided by the enlightened councils of Vauban, had completely changed the armament of the French Infantry.

It is possible that the invention of the flint-lock was the result of a happy combination of the mechanism of the old wheel-lock, with that of the more recent snaphaunce-lock; for the flint-lock resembled the latter in its exterior, especially; while on the other hand, its chief interior parts were taken from the wheel-lock.

Simple as the flint-lock proved in use, yet the wheel-lock, to which custom had habituated everybody, was unwillingly abandoned, and Vauban, the celebrated French engineer, proposed a lock which should satisfy all parties, by admitting of both modes of ignition. But the rapid improvements in the flint-lock soon took precedence of his duplex mechanism.

24.

Almost simultaneously with the duplex lock of Vauban, the flint musket which had now proved itself an excellent fire-arm, was transformed into an arm of close combat by the adjunct of the *Bayonet*, so called from its invention in the town of Bayonne, 1640. This, at first, consisted of a simple small pike mounted on a wooden handle,

* The term fusil is nevertheless not originally a French word, but borrowed from the Italian *focile*, a flint; whence fusil by corruption—and fusileer.

by which it was fixed *in* the muzzle of the piece ; but by which, also, its use as a fire-arm was momentarily prevented. This disadvantage was obviated by the first recorded military invention of a native of England, Philip Russel, in 1678,* who improved the bayonet by the invention of the screw to that arm, so that even when firing, the advantages presented by the pike were still retained. This soon decided all minds in favour of the fusil ; the longer enduring flint of which, soon procured its universal adoption, to the abrogation of the too readily used pyrites, and inconvenient match-lock.

25.

The improvements in the fire-arms of the Continental troops, had now been gradually transferred to those of this country.

In 1663, when the organization and arms of the British cavalry assumed under Charles II. a somewhat more regular tactical form, the household cavalry of that sovereign, as indeed, the troopers of all the cavalry regiments then organized, carried (the former) both pistols and carbines, the latter, pistols only ; but these were circumscribed by especial order to a length of fourteen inches, such having been found necessary, to restrict the taste which had long existed for an excessive and awkward length in this kind of fire-arm ; a correction which had been some time adopted by cavalry on the Continent, where the most reputed cavalry of their day, the German *Reitres*, had already adopted a double-barrelled pistol as early as 1607, and in 1620, a more simple pistol of larger calibre.

In 1684, the *Grenadier* companies which, in imitation of the French organization, had been added to all English regiments six years before, were furnished also with the new screw bayonets to their fusils in the Second Regiment of Guards ; and by the end of the 17th century, the length of barrel as adopted generally for the bayonet-fusil was regulated to about three feet eight inches, and that of the bayonet blade to eighteen inches. The calibre in the German infantry was from fourteen to sixteen balls to the pound—in that of the French somewhat less.

26.

According to some, the Swedes are nevertheless, the first who fired with *fixed* bayonets, and then the Prussians, in 1732 ; but in the front rank only. From this, we must infer, that the bayonet used by the Confederates at Turin, in 1693, was the bayonet in its primitive form, as described above. Yet as late as the battle of Mollewitz,

* In latter times the merit of this improvement has been fathered upon a General Mackay.

1741, the third rank was unprovided with this arm, as is shown by the accounts of that day. Simultaneously with the different improvements in the musket, and from the necessity which daily became more evident, of a quicker mode of firing, the method of loading was changed, and the infantry throughout were provided with paper cartridges, of which each soldier carried from twenty to forty in a leathern pocket. In the Prussian army, the iron ramrod had now also been some time introduced, in lieu of the wooden one, which was so frequently broken in action ; for this reason, also, the Corporals in the Prussian and Austrian infantry had previously been provided with spare iron ramrods in two parts, which when required were screwed together.

27.

By the close of this century, which may not be inaptly designated the epoch of Revolution for the art of war, as well as of improvements in fire-arms and artillery ; the mechanical construction of the latter in all its details had attained to a grade of development worthy of all respect. The numerous wars of Louis XIV., and especially the expedition and bombardment of Algiers, 1674, gave rise to numerous experiments in artilleristic novelties and improvements. One of the chief inventions belonging to this time, is that of the *Elevating screw*, in 1650, by a Jesuit. The cannon of his construction had trunnion-screws, to permit of its lying in a parallel carriage furnished with an elevating-screw. It was also provided with a chamber whose diameter differed little from that of the chase. While loading, the chamber of the gun was closed with a wooden plug. Up to the end of this period, concentric bombs and shells only had been used. But to prevent their falling on the fuze-hole, they were made thicker on one side than the other. To obtain this result, it had been previously imagined, to fix leaden plates on the floor of the projectile.

At this period we find several instances of the priority of thought and invention in regard to many projectiles, the merit for the suggestion of which is claimed for and presumed to belong to the present day ; for as it was then also believed that *oval* shells produced a greater effect than wholly round ones, oval projectiles were not only then used, but even *Conically-pointed* shells, to which the German artillerists gave exclusively the appellation Bomb, while all round, hollow projectiles of every weight, had been called *Grenades* or shells. It would appear that Braun, a celebrated writer on artillery, of this century, first gave the name of *bombs* to the larger shells. As a remarkable production of this period, may be cited the shells invented by Miether, which he threw into Prague, in 1678.

They exploded of themselves upon falling. These were in point of fact a *Concussion shell*; their wooden fuzes contained within, a loaded iron cylinder, the bottom of which was perforated with several holes; the head projected above. The shell being heavier at the fuze hole, fell necessarily upon it, and thereby drove the iron fuze into the shell and exploded it. By this means Miether obtained the result, which in modern times was aimed at in Frankfort, by means of the soldered whistle shaped fuze. In 1672, the celebrated and warlike bishop of Munster, Bernhard von Galen, first applied his invention of the *Carcass* at the bombardment of Grool; and in the same year, Geisler in the presence of Louvois, effected his remarkable experiment with *Shells filled with musket balls* at the siege of Lille; the first layer of the small balls being fixed in the shell with pitch, and the others put in loosely over them. Our readers will here perceive that the *Shrapnel shell* of modern times, is therefore, but a modified resuscitation of this elder thought. Pyrotechnics, in relation to military fire-works, which had received much attention in Italy, in the early part of the 16th century, were in this century also greatly improved and applied, particularly in France.

The second bombardment of Algiers, in 1682, may be accounted among those events, which, like the recent siege of Sebastopol, brought artillerists and others for some time to turn their minds to the discovery of long range mortars. The invention of the celebrated *chats à feu* (fire-cats), a description of long howitzer, with which the Bomb-Galiots were armed, and which afterwards spread desolation in Algiers, is due to that event. The huge Mortars, which from their size received the name of *Comminge*, from a very stout French officer of that name, the calibre of whose bombs was *eighteen inches*, of the weight of *five hundred pounds*, and which could only be put into the piece by a lifting gear, appear to be but an extension of those efforts at destruction which were made at Algiers. Shortly after, (1693) the partridge bombs, of which a figure is given in Grose's "Military Antiquities," were invented—Petri, their inventor, gave the mortar a weight of two hundred and forty-one pounds. They threw a large, and twelve small shells. The middle chamber was charged with half-a-pound of powder, the other chambers with less. These chambers all communicated with each other.

An important invention of this period, was also that of *screwing in* the iron or steel bolts through which the vents of cannon were drilled. This was also a product of Miethers, in 1684. Great progress had also been made in the manufacture of gunpowder, which from the practice of damping it with *acids*, during that process, for

the purpose of increasing its strength, had led to the frequent bursting of cannon. The charges which up to this time had been very great, i.e., two thirds of the weight of the ball, with the idea of attaining a greater range, were now decreased, from the conviction of their destructive effect upon the guns, to half the weight of the ball. By the aid of scientific research, a more correct proportion had been gradually obtained, in which the artillerists of France took the lead of all others. The boring machine was improved, and while Huygens and Lævenhock made researches upon the gases evolved on the combustion of gunpowder, a De Challes, in 1674, applied the *Parabolic theory* to firing. Blondel worked out a parabolic theory, in which the resistance of the air was duly considered, and experiments undertaken to calculate thereby the elevation of a mortar from a given strength of powder; while Newton's discoveries in Science were carefully investigated and observed.

28.

In the commencement of the 18th century, a most important invention (which, as usual, was not esteemed as it merited until some time after,) was suggested by Gotfried Hautsch, in Nuremburg,* who manufactured a pistol, the vent of which externally was funnel-shaped, by which form it became no longer necessary to shed the priming powder into the pan, as the cartridge on being rammed home primed the piece, and thus materially increased the speed of loading. Geisler, a contemporary writer, and the author of a work on the artillery service, much praised this arrangement, but to prevent the powder rolling forward, recommended the breech plug to be cut off diagonally.

The predeliction long shown by the Cavalry for fire-arms, which had been so much exhibited in the Flemish war of independence, whence our De Veres, Morgans, and Skippons, had introduced into England the new tactics of Prince Maurice, and of Parma, was yet more exhibited at this period; in which continual changes were effected, some induced by necessity, others by mere prejudice. The French Carabineers received grooved or rifled barrels; the dragoons of all nations long flint fusils with bayonets, in addition to the again resuscitated long cavalry pistols. At length the practice of dismounting the latter description of troops in action was wholly abandoned, and they fought in the same manner as the heavy cavalry; for which reason, in the Seven years' war, they were deprived of the to them useless bayonet.

* An idea suggested, nevertheless, by the Italian, Bossi, in 1625.

29.

A century had however nearly elapsed, before any decided reformation took place in the Artillery science. France had first began to move in this direction. The existing cannon were wholly re-cast, and five kinds only retained, with two descriptions of mortar. Frederick II. of Prussia, not only decreased the weight of his artillery, but carried out a thorough and rigorous separation of siege and field guns.

These examples were followed also by Austria after the first Silesian war, taught by the severe lesson of experience; when so much simplicity and propriety of arrangement was introduced in that service, that they far surpassed their models, and sufficed even to all the exigencies of field tactics up to the later Napoleonic wars.

In that Syn-chronological order which in as much as possible we have endeavoured to preserve throughout this Retrospect, we must here advert to a circumstance that took place about this time, which will serve to disabuse the public of the present day on a recently assumed priority of invention of an Incendiary Fluid, the paternity of whose discovery has formed matter of dispute to two rival claimants and correspondents in the columns of the *Times* newspaper during the past Autumn. As illustrative of the old axiom, "there is nothing new under the sun," it will serve among the many other instances we shall have to adduce of the truth of that trite saying, in the course of this notice on Fire-Arms; and to convince such as accept too readily the arrogations of those who in the present day pretend to the *first* discovery or invention of the host of warlike appliances which have been recently brought forward as new nostrums for the annihilation of the Russian power in the present war; that they are in principle nothing *new*, and if not wholly analogous resuscitations are but modifications of the ideas of the past!

A presumed re-discovery was made about this period of that terrible and mysterious incendiary fluid matter which under the name, and the name only, of the Greek Fire, will be familiar to most readers.

An individual of the name of Dupré, a native of the environs of Grenoble, established as a goldsmith at Paris in the reign of Louis XV., in endeavouring to find a composition for the making of false diamonds, discovered by accident an inflammable liquid of the most active and fearful violence. Chalvet, who relates this fact in his *Bibliothèque du Dauphiné*, informs us that this liquor consumed everything combustible that it touched, that it continued to burn even in the water, and reproduced all those effects attributed in ancient times to the Greek Fire. Dupré caused the king to be made

acquainted with his discovery, and by his order, he performed some experiments upon the canal at Versailles, and in the court-yard of the arsenal of Paris. This was in the year 1755, at a period when our present allies were engaged against us in that collision which preceded the Seven years' war, and brought about the ruin of the naval power of France. Dupré was sent to several of the sea ports of France to make trial of his incendiary liquor against ships, and the effects which he produced were so terrible, that the seamen themselves were terrified on seeing them. Nevertheless, Louis XV. yielding to a noble sentiment of humanity, thought it his bounden duty to renounce all the advantages which this invention proffered him, notwithstanding the pressing exigencies of the war. He forbade Dupré to make his discovery public, and to ensure his silence, and prevent all inducement to his communicating it to the enemies of France, he granted him a considerable pension with the Order of Saint Michael; Dupré died faithful to his word and without betraying his secret. But calumny, which spares not the character of the purest, much less that of a sovereign open to censure in so many respects as Louis XV, accused him, as Dupré's Biographer pretends, (with a malvolence but little creditable to him) of having precipitated his death.

In an Essay entitled *Essai sur de Prétendues découvertes nouvelles*, published in France, 1803, a secret analogous to that of Dupré is alleged also by M. Coste to have been discovered anew by an artificer of the name of Torrè, under the ministry of the Duke d'Aiguillon, 1771. "The secret of the Greek Fire" says M. Coste, "was discovered in France under the ministry of the Duke d'Aiguillon by a builder who certainly was not seeking it, and who was occupied at Havre in making a mixture for composite stones. My testimony upon this subject is irrefragible, for it was I who composed and wrote the *Memorial to the Council*, wherein that honest artiste made homage to the King of his fatal discovery, requested his commands, and offered to load a wooden cannon of a size no larger than one man could carry, with 700 arrows filled with his composition which would ignite, burst, and set fire to everything around them upon falling. This preparation with the Wooden cannon to discharge the Greek Fire to a distance of 800 toises, was the invention of the artificer, Torrè."

Notwithstanding this further authenticated re-discovery of a composition so analogous to the world-famed and fearful incendiary matter of the Byzantine Greeks, of the discovery of this man, we never met with any practical application of it, and the name of the artificer, Torrè, is completely unknown in the present day.

With the later invention of the mechanic Chevallier, it was otherwise : and his tragical end attracted thereto for some time the public attention in France. Chevallier, an engineer and mechanic at Paris, had succeeded in making incendiary Rockets, which burnt in the water, and whose effects were as certain as they were terrible. The Pyrotechnical experiments which he conducted on November 30, 1797, at Meudon and at Vincennes, in the presence of several officers of high rank in the French navy, experiments which were resumed at Brest on the 20th of March, following, demonstrated that these Rockets which had some features in common with the Congreve Rockets of the present day, reproduced also some of the effects commonly attributed to the Greek Fire. Chevallier was engaged in perfecting his incendiary compositions, when he perished—the victim of a fatal political error. From the outbreak of the Revolution, he had made himself conspicuous by the exaltation of his Republican sentiments : in 1795 he had already been arrested as an agent of the Jacobin Conspiracy, and set at liberty upon the amnesty of the year IV. In 1800, denounced to the over-zealous and umbrageous Police of the period, as being engaged in Pyrotechnical preparations and the manufacture of incendiary Rockets with a suspicious intent ; he was thrown into prison under the accusation of having intended an attempt on the life of the First Consul. This charge having been brought to no serious solution, Chevallier was on the point of being liberated anew from his prison, when by a most fatal coincidence, the explosion of the celebrated Infernal Machine occurred. Although it was evident that Chevallier had no connexion with the authors of that horrid conspiracy, he was nevertheless brought some days after before a council of war, condemned to death, and shot the same day at Vincennes. The reason for this summary riddance of Chevallier was thought to arise less from the suspicion of his having any criminal political relations with the conspirators in that plot, than in the professional jealousy which his Pyrotechnical skill incited in the Officers composing his council of war.

30

In Fire-arms, in the course of the Seven years' war, as already observed, as well as in the ensuing Turkish war ; many changes and improvements had been further made ; and it may be said that the Prussians under their warlike kings took precedence of all others, both in this respect and in military discipline and manœuvre. They were, as we have already observed, the first to introduce into their armies the stronger iron ramrod, more appropriate to the rough

usages of war ; and when the Austrians and several other states imitated them, they came forward in 1773, with the cylindrical ramrod, which had the advantage of not requiring to be turned while loading, although it did not so efficiently answer for the equal lodgment of the ball. Considered justly as a material defect, and to give it more lightness perhaps, it was afterwards made thinner throughout by the Hessians, and provided at each end with a broader head and heel.

In 1781, the fire-arms of the Prussians were furnished with the funnel-shaped touch-holes already alluded to, whereby they primed themselves, and at the same time with a shield for the entire lock, consisting of tin covered externally with leather, to protect it from the wet. With the exception of this lock-guard, they were imitated by the Saxons, Hessians, Austrians, Hanoverians, and ourselves. At this period, the Austrians first armed a portion of their excellent light frontier troops (Croats, &c.) with double-barrelled muskets, one a grooved or rifle barrel, the other smooth. They did not long retain them nevertheless, chiefly on account of the weight and inconvenience of such an arm. Eventually, rifled carbines (Stutzen) with broad bladed bayonets, the originals of the present French sabre-bayonets, and of the sword-bayonets of our present Sappers, were given to the Austrian non-commissioned officers and fuglemen of each section. With similar rifles to these, the Jägers up to the present day were likewise armed, and with these improved weapons for the Fire-fight, the armies of all the Continental states were then diligently exercised, particularly in the practice of target-firing, which excellent and sensible custom became again in later times neglected in a manner difficult to account for, but which in the British service, of all others, was most neglected up to the opening of the present war with Russia.

With the exception of the funnel-shaped touch-holes, the fire-arms of the Cavalry remained nearly unchanged, and these were almost universally adopted, until the Austrians, in 1760, armed the front rank of their Cuirassiers with the so called trombones (blunderbusses), a somewhat short fire-arm, the barrel of which increased considerably in width towards the muzzle, and threw a charge of twelve bullets.

For the Dragoons, from whom the bayonet had been taken, it was now attempted to supply the place of that arm with a pointed ramrod, which on being half drawn, was kept firm in that position by a spring. This however, as might have been anticipated, was soon abandoned. An invention which at that time merited perhaps more imitators, was that of a ramrod attached to the barrel by a joint or

hinge, from which it could not be detached or lost. The Hanoverian Chasseurs à cheval were the first to adopt this arrangement; but they were imitated only by the Saxon cavalry.

Several suggestions were now also brought forward, resuscitations of earlier efforts in the art of Gun-making, but which were then rejected as inapplicable to the uses of war; such for instance as fire-arms loading at the breech, and with *Revolving* barrels; others with barrels whose bore diminishing at the breech, permitted the ball by the mere action of rolling down the barrel, to fix itself firmly on the charge and diminish the windage on the first ignition of the powder: and again, of guns which loaded themselves by means of a magazine of several charges, a method for which of late years Patents of Originality have been applied for, and granted, like many others, from utter ignorance of the past efforts of the art.

31.

Reverting once more to the progress in Artillery towards the conclusion of this century, Gribeauval, though like all Military Reformers, most invidiously opposed by his Profession, succeeded in effecting a yet further change and decrease of weight in the French artillery on the model of the Austrian and Prussian guns. He at the same time constructed more appropriate carriages for the different guns, which were again imitated by others, and by our own artillery among the number.

This was the general condition of the arms with which the wars of the Revolution were fought out; but as the inventive genius of man never wholly stands still, so partly during those wars, and partly since, new arrangements and improvements forced themselves into use in several European armies, which even at the present time still attract the general attention, and have unmistakeably awakened a general desire and assiduity to a further perfection of fire-arms and artillery.

32.

The most important of the changes which have arisen from the state of things during the almost uninterrupted European peace of the last forty years, have indisputably resulted from the impulse and field for improvement in Fire-arms, given by the discovery of the Percussion and Fulminant agents at the end of the last century. The successful application of these agents to the ignition of the charge, have not only rendered useless those ingenious efforts of the earlier craftsmen to obtain the precision and rapid multiple of fire, the attainment of which had long been either forgotten or condemned

but have given birth to modifications of these, which have taken the most initiated by surprise, and been arrogated as wholly new inventions in our day.

In France and England, already in 1807-10, these agents began to be applied as a means of ignition to sporting and amateur guns, and in the course of thirty years all the mechanical appliances having reference to its use were so much improved, that they were not only adopted in the Percussion-lock by all the Continental states for the Infantry musket of their respective armies, but of a necessity also in our own, where it was applied also to the firing of Artillery, which hitherto, at least on land, had been almost everywhere ignited with the linstock or portfire.

33.

In the Congreve war rocket, and Shrapnel shell, the Artillery had received from this country, both a novel and important means of destruction. Though rockets are of ancient date, and came into use, if not before, at least almost simultaneously with gunpowder, they had been but little resorted to since the 17th century other than as agents of festive display. At the end of the last century, our countrymen in India became acquainted with these projectiles upon various occasions in the field, and particularly at the siege of Seringapatam, when they were used in the defence of that place by Tippoo Saib. Congreve in imitating, greatly improved upon them; and they have now some time been adopted into the artilleries of almost all the European states, in one of which, (Switzerland,) considerable improvement has been made in their structure and composition by Colonel Pictet of that service.

They were first used at sea on a large scale at the bombardment of Boulogne, 1806, and Copenhagen, 1807, and subsequently at Algiers and St. Jean d'Acre. In the field, at the battle of Leipsic, the Peninsula, and Waterloo.

In this Projectile it was currently reported that our French Allies had made vast improvements at the arsenal of Metz during the spring of 1855, which comprised a much greater range than that, even of the largest Calibre Rockets used on former occasions.* But neither at the siege of Sebastopol nor in the Baltic, have we yet ascertained on competent authority that their range or effects exceeded those of this projectile on Congreve's original system. It is somewhat remarkable, nevertheless, that with the exception of Hale's

* The range of one of these Rockets carrying a 12lb. Shell, tried 1853 at Toulon, attained to from 4000 to 500 metres, or more than a league, being from 700 to 1000 metres more than the range of the larger calibre rockets in use till then.

tailless Rocket of yet dubious merit, all the endeavours to perfect this formidable though expensive projectile, have chiefly been made in the Artilleries of the Continental States, and not by the Officers of that arm in the country where it originated as a modern engine of warfare. It is a subject both of regret and imputation, that the Officers of the British Artillery have been too satisfied to content themselves with the statu quo of their arm since the days of Congreve and Shrapnel; and as remarkable that the latest efforts at improvement in this projectile, as in Artillery, in this country, have emanated from Civilians.

The modifications of Hales, in the Congreve or War Rocket, for which a patent was granted in this country, are analogous to those suggested in France by Colonel Thiroux of the French Artillery in 1840, viz., the disuse of the tail or rail, the impression of a rotatory motion on the rocket by discharging it from a grooved or rifled rocket tube, and of an equal initial velocity by restraining the issue of the rocket from the tube, until it has overcome a resisting check established at the lower part of the rocket tube, and connected before firing with the posterior part of the rocket case.

In reference to the Shrapnel Shell to which we adverted (Pgh. 27.) when speaking of Geisler's experiments with shells filled with musket balls at the siege of Lille, it is but just to observe, that the projectile of the German artillerist Geisler himself, was but a resuscitation of this kind of shell, for shells cast of a *friable* metal similar to the common bell metal, were in use in France in the time of Louis XIII; and during the reign of that monarch in 1620, various kinds of this shell are spoken of by Hanzelet, the engineer, in conjunction with the alchemist, Thybourel: as also of an inextinguishable incendiary compound, burning under and upon the water, and no less of poisonous and asphyxiant compounds used in shells. Hence the *grénades asphyxiantes*, recently brought out in France for naval use, are also but a resuscitation with some modern modifications.

34.

We may here advert also to the Rifled *Air-gun* as one of the attempted adoptions for the purposes of war by the Austrians, in the first campaigns of the wars of the Revolution, with which they armed some of their Croat sharpshooters, and which, without report or smoke, threw a ball with greater precision and range than could be done with a charge of gunpowder half the weight of the ball, i. e., when charged with condensed air at the maximum. But the process of filling the magazine, formed by the butt end of the gun, was found

both fatiguing and often dangerous. The Austrians then restricted their use to the defence of fortresses only. The air gun was invented in the 15th century, but more generally known only in the 17th. About fifty-two years ago, a German of the name of Staudenmayer, located in London, had much perfected this arm, having adopted thereto an *elongated* or *cyllindro-conoidal* ball, as also a *belled* or zoned spherical ball, which fitted into the straight-two-grooved bore—forms of ball, the invention of which has been recently attributed to Captain Norton and others, but which date as far back as the year 1725, as the invention of a Spanish officer, and suggested by him to the Marquis of Santa Cruz, for a new Infantry carbine of his proposal.

35.

The steam-gun of Perkins, may here also be enumerated among the inventions of modern times; the application of which to war purposes, though much insisted on by the inventor, was wholly disproved at Vincennes, in 1829. The uncertain percussive force imparted to the projectile, the range of which decreased progressively, and the weight of the machine itself (four thousand pounds) to throw a four pound ball, evinced how little it was calculated to supersede artillery.

36.

At present every new invention which arises in the different European states, a speedy acquaintance with which is now become matter of policy and necessity, is examined and tested for the most part by Military Commissions or Boards appointed for that purpose. From whom, intimately acquainted as these *should* be, with the art of war and its auxiliary sciences, it is equally expected while they bar the way to every impracticable project of improvement, that they dismiss from their minds those tenacious prejudices of Routine and Professional jealousy, which have so frequently been productive of delay to the perfection of arms and the equipment of armies, as well as of injustice to merit.

It would greatly extend our limits were we to enumerate here, much less detail, the endless variety of so called Inventions which have been brought forward of late years, and more especially since the war with Russia laid bare to the world our defective Military Organization in arms and artillery, to say nothing of our army Administration as a System; all of which the successes of a time of war remembered but by few had encouraged the Nestors of our military hierarchy, no less than our statesmen of the same school, to believe still sufficient for every purpose in any future European contest.

Our poverty in the elements of success adapted to a progressed state of military organization, armament, and tactics, which had been ably and patriotically exposed for some years past by a few keensighted but contemned individuals, was but tardily admitted; and not until engaged with an enemy of different military dimensions to the tribes of India and Caffer land, and the example of our active war-inured French allies, had shown us the grave error of our self-sufficiency and neglect, had we in the second year of the present hostilities exerted ourselves to remedy the supineness of the past and assume our arrogated place as a first-rate militant power.

In singular illustration of the disposition of the public mind in the present day, to exaggeration in all the appliances of Science and Art, which a long continuation of Peace had enabled it to direct successfully to purposes of Commerce, Agriculture, and Engineering; grown accustomed to the accomplishment of the wonderful, and the achievement of magnitude in design and form, the attainment of the gigantic in everything became credited as possible and safe, despite many rude and instructive lessons of its fallacy as a rule.

In such a tone of mind, when a comprehension of the inaptitude and neglect of Administrations, which moving ever in the same circle, had not kept pace with the spirit of the times, had been forced on the senses of the nation by the befall of an unexpected revelation of our Military deficiencies—the public mind writhing under the sentiments of grief, disappointment and exasperation, rushing from one extreme into the other, ran riot with suggestions of destructive enormities incompatible with sound practical principles and application. Monster artilleristic engines whose projectiles were to pulverise fortresses of granite—asphyxiant and letheifirous shells—electric guns mounted on waggons, which were to make mince meat of whole batallions—rockets of giant dimensions, impossible ranges and chimerical destructiveness—steam locomotives armed with scythes, which should mow down the enemy's squadrons like the grass of the field—submarine devices with infernal machines explosive or non-explosive at will, which should blow whole fleets into the air though moored in obstructed harbours and behind ramparts, were the familiar subjects of daily suggestion.

But of all these wild creations of a disordered fancy put forward to avenge the consequences of a supine neglect of the really needful only, in Organisation and Armament, such as in the present day a first-rate power should possess, as calculated for any crisis abroad, or threatening its own homesteads—mortars of 13 inch bore, 5 inches less than were in use above a century ago, have resulted; while the

System, the senile System, the incubus which would have palsied the energies of the nation and shackled its vital capacity to repel the advance of a few war inured legions upon its own shores, after the adventitious loss of one battle ; reigns unchanged but in words and semblance—the enthroned time-honoured cheat of an easy and too confiding public.

37.

Among the most prominent of the artilleristic suggestions of the day, the monster Marine Mortar of Nasmyth, became matter of wonder-comment, to that numerous class of persons who in this age in singular coincidence with that of the earlier youth of the artilleristic art, fall into the same error of the superior advantages in strength, durability, and effect, which magnitude of size and massiveness of metal give to artillery.

The superior strength and tenacity of wrought iron over cast iron, such as is produced in this country, becoming also of daily discussion in the Press ; seized with the same propensity for massive proportions in everything, and either over-estimating the power of his machinery or strangely unconscious of that experience which the early fathers of Gunnery had groped their way to—Nasmyth undertook to forge an iron gun in the mass, of such huge proportions as were to ensure a strength of resistance and force of projection from the magnitude of its charge and weight of projectile, that was to exceed all cannon hitherto fabricated and achieve immeasurable results.

The result of this undertaking was sooner to be measured than its projector or the mass of the public dreamed of ; for again as in the early days of gigantic cannon forging, though with mightier tools wherewith to knead the fibre of the metal, it was discovered that the interior of the mass had remained not only unwrought by the ponderous steam hammer, but had remained so long in that state of incandescency so prejudicial to the texture and cohesive strength of the metal, as to lay the surest foundation for its speedier destruction. At the time, we vainly endeavoured to make our weak small voice heard on the subject, for we were supported by historical instances and known mechanical and artilleristic principles in affirming, that the object sought for by Nasmyth, would have been better attained, if he had gone yet farther back for his lesson to the still earlier efforts of *Bombard*-making, and have constituted his gun of a compound of wrought iron staves and rings in alternate close adapted layers, in which every component part of the whole engine would have received that equal toughening, cohesiveness and multiple elastic power of resistance which are the real and requisite elements

of strength in ordnance, and might be obtained by a judicious amalgum of steel with the iron, in the forged bars and rings of such a resuscitation of the olden "gones."

38.

Of those recent efforts in Gunnery which have gained a certain historical notoriety in the Russian war, the Lancaster gun may be cited as a step in advance, although from the defectiveness of the cast iron of English produce in which the normal good qualities of the ore are so much deteriorated by the custom of smelting it with coal instead of charcoal, the bursting of several of those pieces in which the friction is considerable, has resulted. The chief peculiarity of structure in this gun, which is now so generally known as to need no description, is an application to cannon of the system of the Brunswicker, Captain Berner, who in 1835, submitted his *Elliptical* bore musket to the inspection and trial of the Royal Hanoverian Commission, appointed for that purpose; and which under their judicious investigation gave results so satisfactory, that it was considered admirably adapted for the Jäger and Light Infantry Battalions.

Notwithstanding this favourable judgment, the usual grave consideration of the expense of its adoption and substitution for the arms in use, and then in progress of change to the Percussion system, placed it in abeyance; and until its principle was patented in this country by Lancaster, and in a further modified and less abrupt form by Adams, of Revolver notoriety, Berner's idea remained comparatively dormant, and was but little known even in France under the appellation of *carabine à rayures à virgule*, or the comma grooved Rifle; so called from the excision of the metal of the bore by the cutter in this mode of rifling, leaving from two to three and four almost inapparent ridges of metal throughout the spiral of the rifling, each assuming at the muzzle of the piece the profile of a comma in letterpress punctuation; showing the points of aberration of the bore from the spherical to the spheroid or elliptical shape, and giving to the bore of the rifle a duplex or greater and lesser axis.

Much merit has also been recently attributed to Captain Julius Roberts, R. N., for his presumed new method of slinging guns on board ship, so as to prevent their recoil when fired, from being so detrimental to the decks and frames of ships of war. But the merit of this idea not only in Theory, but in practical fact, belonged to the late Sir William Congreve, to whose fertile and creative genius the Artillery Science in this country is so much indebted for a host of improvements too numerous to cite. Models of this principle of

slings mounted guns, lifting their own weight in their recoil, in a curve of nearly three feet perpendicular, and coming in without shock to the ship, where they were held by a pall at their extreme recoil and height, in a convenient position for loading, and eased out again by their own weight, without any exertion on the part of the men, were within our recollection in the Royal Military Repository at Woolwich. This principle may not improbably have been suggested to Sir William Congreve himself, by the suspended *Epreuves* of the celebrated Dr. Hutton, who did so much for the Artillery in this country at the end of the last century.

Before closing this necessarily condensed Retrospect of the History of Fire-Arms, the progressive improvements in Artillery, and Inventions applied to the purposes of war ; it might be considered an omission if we made no allusion to the already almost forgotten but once all-absorbing topic of the "*Warner Invisible Shell*" and "*Long Range*," as also to the more recently proffered means of the Earl of Dundonald to bring the war with Russia to a conclusion, after a manner as effectually destructive of the enemies' fortresses as economical to the national exchequer.

In reference to the former, Warner's Invisible Shell, adapted as a submarine agent to the destruction of ships of war ; the idea of such a means had already been conceived in the last century by Rouelle, a French chemist, and in another form was ineffectually tried last year by Dr. Jacobi, to blow up the allied ships in the waters of the Baltic. The experiment tried at Brighton on Mr. Somes's vessel the *John of Gaunt*, under circumstances as favourable as these always are to experiments tried in time of peace, as compared to those of a time of war, though effective in the destruction of that ship, did not suffice to satisfy our then naval authorities of the practicability of applying such a means with that constant certainty of success which in matters of the kind is so desirable. That Warner in the charge and mode of ignition of his shells, had availed himself of some of the known fulminates and percussion primers there is no doubt ; and as in all cases where those destructive agents can be successfully applied, his invisible shell on the favourable occasion adverted to, fulfilled the object.

But there are, and all always will be, many favourable contingent circumstances required for a successful result in the use of such agents of destruction as those of *Warner* or *Jacobi*, which depend so much on the auxiliary but always *fortuitous* aids of time, tide, weather, &c., to carry them out ; so that where they do succeed, that result will have derived more from the aid of chance, than from the

certainty of their successful application. Warner's "*Long-Range*" proved, according to the current reports of the day, a failure ; though with every facility allowed for its test, in the Isle of Anglesea.

41.

With respect to the Dundonald Arcanum, this as the public has been informed, has been confided to a Council of certain members of the present Cabinet, and some professional and scientific men, the latter of whom, it has been said, expressed an opinion favourable to its destructive capabilities, and to the possibility of applying it ; but the reasons for an apparent refusal, or hesitation to employ the Earl's nostrum, have like the knowledge of the means themselves, yet to be made public. Whether these revelations will ever be made, is matter of great doubt. Not that we believe, when the cost to us of life and treasure in the present war, are considered, that the infliction of greater loss of life, and destruction of his fortresses to the enemy, would be abjured from the supposed motive of humanity—but there is another argument against the resort to means of destruction of the presumed fearful efficacy of the Earl of Dundonald's, which in the case of most offers of the kind proffered to Governments in the last and present century, have had more weight on the minds of Statesmen than any motives of humanity. This is, the very doubtful *Policy* of resorting to the use of a means of Offence, which however great the momentary advantage of its *FIRST resort* may be to the party using it, will from its very application be discovered to the enemy himself : who in turn, master of the same means by that power of analysis and imitation, which the present more intimate knowledge of the Chemical Science has imparted alike to all the States of Europe, would naturally, soon be in equilibrium in regard to such a desperate means of aggression, and would of a surety measure out the same meed of destruction to his enemy, on some favourable opportunity, when the retribution would be most sensibly felt, and no sympathy found for the sufferings of *those* who were the first to employ such infernal means of aggressive annihilation.

There is moreover another point for consideration, in reference to the resort to such extraordinary agents of Offence ; and it is one too frequently overlooked, both by the Inventor and those who share his confidence of success. This is in the frequently complete or partial failure of the appliance, when first resorted to on a large scale, under all the numerous incidental and fortuitous circumstances which the keenest foresight does not always calculate nor provide against, and which the disturbing emotions and accidents of a first actual application in war, paralyse too frequently, or render far less effective than anticipated.

In the minds of most men of sound judgement, therefore, the resort to such terrible known means of annihilation, would be alone politic and excusable as a DEFENSIVE resort against a powerful and inexorable assailant of "hearth and home;" when as in the Arab onslaught on Byzantium, the Patriot's despair would be the most potent and unexceptionable plea for the practical application of a means of Defence, which otherwise, were better preserved as a State Secret in the bosom of the Government—a private heir-loom of knowledge, for the rescue of the land from the oppressor in extreme circumstances of National peril.



GUNPOWDER.

As the limited form of this work will not permit of our entering into a detailed chemical analysis of the component parts of gunpowder, nor into that of its manufacture, we will confine ourselves to so much of the subject as will best enable our readers to estimate how much every result depends upon a competent knowledge of its *action, quality, and proportion*, for the different arms and projectiles used.

It is the charcoal and saltpetre (nitrate of potasse) in gunpowder, which furnish the gases; and the detonating property of gunpowder derives from the great quantity of nitric acid, which is a constituent element of saltpetre. The sulphur is the incorporating medium aiding its granulation and preservation, increasing the density, inflammability, and strength of the gunpowder; and in a parity of all other circumstances, the goodness of the gunpowder depends on the perfection of the mixture of these its component parts.

Submitted suddenly to a high degree of heat, (about three hundred degrees) gunpowder ignites and explodes. A violent blow, and contact with an ignited body, produce the same effect.*

Upon being inflamed, gunpowder becomes decomposed, and evolves both gaseous and solid bodies. The former have a violent tendency to occupy a space much greater than that filled by the gunpowder before its ignition. The parts of a charge of gunpowder do *not* ignite nor combust *simultaneously*, as was long believed and insisted upon, but *successively*. The charge of shot, the ball or projectile, do not therefore receive their strongest impulsion instantaneously, nor until these have passed over a part of the length of the barrel do they receive the greatest action of the gunpowder.

* We feel it our special duty to impress this explosive faculty of Gunpowder *from a blow*, on the attention of the reader, from the circumstance, that in the October number, 1854, of the *United Service Magazine*, a writer evidently incompetent to treat the subject which he had undertaken, affirmed that "There is no instance known of common gunpowder being kindled by a blow from a hammer on an anvil, or, an analogous manner." If the writer had tried it himself, he never would have made public an assertion, likely to become so dangerous. Struck by a heavy hammer upon an anvil, *gunpowder will explode*; and as this explosive faculty may be developed in any analogous manner, common gunpowder should not be exposed to such possibilities in Fire-work or other manufactories.

Hence the expansion of expanding projectiles, supposed by some to be so *instantaneously necessary* for rifled arms, to throw ball of that kind with best effect,* is no more so instantaneously produced upon them, than the full impulsion upon a spherical ball or charge of small shot in a smooth bore. The better the quality of the gunpowder, and the more readily it inflames, the less it soils the gun—when its combustion is slow, and when it is damp, it soils considerably.

Good gunpowder, exploded on a sheet of white paper, leaves no residuum. Inferior gunpowder, so tested, leaves a deposit of the but partially decomposed saltpetre and sulphur attached to the paper, which crumbles under the fingers. Good powder may be thus exploded on the bare hand without a sense of burning. If gunpowder blackens white paper, it contains too much charcoal; if it leaves yellow stains, too much sulphur.

Examined in the light of the sun, it should exhibit no shining particles—when this is the case, it is an evidence that the saltpetre is not well crushed, nor sufficiently combined with the sulphur and charcoal. It should not be black in colour, which denotes too much charcoal, when it readily absorbs humidity. It should be of an uniform slate colour, without and within. Large grained powder, if good, is less susceptible of damp.

Angular gunpowders, and those which are not too smooth and bright, inflame more readily than hard round smooth powder, though the former are more liable to bind on over-tight compression, when their readiness to ignite is impeded.

THE IGNITION AND COMBUSTION OF GUNPOWDER.

The ignition of gunpowder must be clearly distinguished from its combustion. Ignition indicates the moment when a combustive body begins to develop light and heat; this in gunpowder takes place from grain to grain, and is generally communicated with the greatest rapidity throughout all the parts of the charge—the combustion is effected in the interior of each grain, producing the total decomposition of all the separate grains by fire, and the total evolution of their gases. In gunpowder, these phenomena follow each other nevertheless so rapidly, that unless the mass is spread over a considerable space, they *appear* simultaneous.

This rapid succession of the ignition and combustion is explained by the readiness with which each separate grain receives, takes up and spreads them through the intervening spaces, and round its

* We recollect seeing this supposition adduced in lieutenant-colonel Gordon's letter to Sir C. Trevelyan, on the Enfield experiments last year.—*Remarks on National Defence.*

sphere of action, which is from five to six times greater than its own diameter.

The granulation of gunpowder has a great influence on its rapidity of ignition: the larger the grain, the more readily will the gases produced by the combustion of the first inflamed grains communicate to the whole charge; but the slower will be the combustion. With smaller grains, though the ignition is slower, the combustion is very rapid, from the less amount of volume in each. This will account for the superior shooting generally obtained with large than with fine grained powder when firing expanding projectiles, though the reverse has generally been believed and acted upon with rifles, firing the ordinary spherical *forced* ball.

The size of grain and hardness, should be considered according to the length and diameter of the barrel, and the character of arm, whether smooth or rifled. Hardness and smoothness of the surface of the grain may retard the ignition, and this is the objection made to smooth grain gunpowder, which, nevertheless, from its more durable quality, and good action, would appear ill-founded. A small per centage of moisture does not very sensibly affect the ignition, but more than four per cent retards both that, and the collective combustion very materially, when the powder produces a less effect.

Mealed gunpowder, that is, crushed grain powder, or ungrained fresh dry gunpowder, inflames readily; but from the want of *intervals* in the interior of the mass, the inflammation spreads more slowly, and it therefore decomposes more slowly also, than grain gunpowder, and proportionately exhibits less strength the more closely it is pressed together.

The greater and more violent the inflammation of powder at the commencement, the more rapid under an otherwise respective parity of circumstances must be the combustion. The flame from burning saltpetre was long used and considered as the means best adapted for the inflammation of gunpowder, because unlike most other burning bodies it develops not only light and heat on the surface, but is wholly penetrated therewith; next to this was the spark from steel, and burning charcoal, but this is now effected with greater certainty still, by the flame jet of chlorate of potasse, or of fulminating mercury.

The combustion depends, therefore, immediately on the inflammative faculty; and if the former is to follow this completely, then must every individual grain of powder be wholly penetrated and decomposed by the fire. Hence the rapidity of combustion, both in separate grains of powder, and in larger masses, depends on the

relation or proportion of the surface of the mass to its contents—this justifies the regular and generally round form of the separate grains and their fineness.

Though this in the rule is not very perceptible, yet it is so in very small charges (from $\frac{1}{2}$ ounce and below), and proportionately very large grains; as also in larger masses which present but a small surface to inflammation, or offer no intervening space to the spread of the fire, such as tightly compressed mealed powder, or firmly driven grain Powder (as in Rockets).

According to Theory, inflammation spreads most rapidly from the centre of the charge. Nevertheless those who have given their attention to the subject, have found no difference in the effect upon the projectile, whether the inflammation under ordinary circumstances begin at any one part of the surface, or in the interior of the charge; but one fact very worthy of attention in regard to the action of the charge upon the gun is, that in arms where the vents are very forward, the recoil is great: hence it is more advantageous for fire-arms to have the ignition take place well behind.

The time necessary for combustion under ordinary circumstances, even in masses of one or more cwt., is scarcely perceptible to the senses; but with larger masses under an otherwise parity of circumstances, it must necessarily be greater than in small ones, yet in what proportion has not been accurately ascertained.

Both upon the inflammation and upon the combustion, the temperature, &c., of the surrounding atmosphere has considerable influence. In fair dry weather, both will take place more readily; because then the air both on the surface and in the intervening spaces of the powder, is a better conductor of heat, and better adapted to accelerate and spread the development of the fire; but on the other hand, also, no differences worthy of much attention affecting the ordinary use and effect of fire-arms, are exhibited at the different periods of the day.

GUNPOWDER BY WEIGHT AND BY MEASURE.

That it is frequently required to measure *accurately* a certain quantity of gunpowder, in order to attain equal or similar results, will be readily understood. To effect this, if Weight be resorted to, from the inequality of the grains even in gunpowders of one and the same sort, an unequal volume will be obtained; while on the other hand, if Measure be used, an inequality of weight will be found.

In both cases the number of grains is unequal, hence arises a great difficulty in ascertaining an accurate knowledge of the effects or action of gunpowder, and its great inequality becomes evident.

The equality of powder charges which is so frequently required by Theory, is therefore in point of fact never wholly attainable ; and hence the results so frequently contradictory to theory.

Accurate weight gives a more correct measure than the most careful measurement by volume ; but as this requires much time, and a precision which is impossible in works on a large scale, the powder-measure (i.e., a tin cylinder of a specific content) is used. This mode of proceeding is nevertheless very defective when working with different sorts of gunpowder, or of different manufactures. It is therefore necessary to fix the cubic contents of the required measure, by ascertaining the *accurate weight* of a certain volume of given powder. Coarse grain gunpowder is usually heavier than fine grain.

THE RESIDUUM OR DEPOSIT AFTER THE COMBUSTION OF GUNPOWDER.

After every combustion of gunpowder, a residuum is found in fire-arms, which in dry weather very soon stiffens or beads, and adheres to the inside of the barrel in the shape of a powder-crust : in damp weather it assumes a fluid and slimy consistence. This is produced by incomplete decomposition, and consists of the *material* parts thrown off on the decomposition of the gunpowder : the ashes of the charcoal, and sulphur in combination with charcoal, appear to predominate in this deposit. The more impure the ingredients which composed the gunpowder, and the greater the quantity consumed, the greater will be the deposit. With large charges, proportionately less deposit is left in cannon, than with lesser ones : this is accounted for by the greater force with which the former upon their discharge project a great part of the residuum out of the piece, than do the latter from the proportionately much longer barrels of fire-arms. In the former of these cases, in guns of great diameter, it spreads itself over the whole interior surface, and so forms a very thin layer, which readily imbibes the atmospheric air. The acids which it contains act as a decomposer of the metal. During a long and continuous use of a fire-arm, the interior of the barrel can become restricted by this residuum to a prejudicial degree. If it be not then cleaned, as is usual with the infantry musket, and should be with all sporting guns ; with every new charge a portion of the powder-slime or crust is driven into the breech or chamber of the gun, and a very dangerous increase of this deposit is occasioned, which intercepts the fire, or may upon loading effect a spontaneous ignition. Even with those cannon, which are usually cleaned after every round, this sometimes occurs through careless sponging. Modern experiments have elicited that the residuum of the powder in the gun barrel is phosphorescent, i.e.,

emits a light in the dark, like many other oxides, especially those deposited by fire-gas ; but this is not a dangerous appearance.

FORCE AND ACTION OF GUNPOWDER.

The cause of the powerful action of inflamed gunpowder, is the extraordinarily rapid expansion of the gases and vapours of the so called powder-damp, wrought by the high degree of heat to intense elasticity, which in its sudden effort to occupy a much greater space than it occupied in its solid and material state, strives to overpower every obstacle that would oppose this expansion. This may be exemplified by igniting a *single* thoroughly dry grain of gunpowder in the open air, when it will be found to evolve and spread around itself a heated mass of air, which at the distance of four or five times the diameter of the grain, is still capable of inflaming another grain. The spherical-shaped space which at this moment in obedience to the aerostatic law, the expanding powder-damp takes possession of on all sides around it, and within which it is capable of communicating inflammation, is therefore from about five hundred to a thousand times greater than was the material bulk of the grain. Experiments and calculations have shown that the powder-damp, evolved by a closely confined quantity of powder, at the moment of inflammation and completest possible combustion, strives to occupy a space about five thousand times greater than it occupied before, and from which it expanded ; this would denote a force or power equal to five thousand times the pressure of the surrounding atmosphere.

But this force does not develop itself in ordinary fire-arms to this degree ; in these the computed pressure is from two to three thousand times only that of the atmosphere, though under some circumstances it has been found far greater. Meinecke found the force of gunpowder two thousand two hundred ; Munke, two thousand two hundred and forty-one ; Hutton, two thousand three hundred times greater than the pressure of the atmospheric air, which, as is known, is computed at fifteen pounds on the square inch.

But these and other similar data, serve only as isolated attested illustrations from which a general conception of the force of gunpowder may be formed, without furnishing a positive reply to the question of the *absolute* force of gunpowder.

Its *relative* force is alone known, that is, how much a certain quantity, under certain circumstances, or in comparison with another quantity under the like circumstances, can effect, and this it is which is of the greatest importance in the structure of fire-arms.

When the *great* force of gunpowder is considered, and that as

regards its projective powers, there is no room to complain that shot or shell cannot be thrown to a sufficient distance ; but that the fault lies much rather in the too frequent mechanical defects and inefficient action of the fire-arm or piece of artillery, that much within the range to which gunpowder hurls its projectiles, there are many active causes why an accuracy or precision in striking the object is not attained, a circumstance, the difficulty of which increases with the distance—it may readily be conceived why powders consisting wholly of or combined with agents of such formidable and violent action as the fulminates of modern times cannot be safely employed as projective substitutes for gunpowder with the arms in use. When the far greater danger of the transport and use of a matter which ignites from a blow or from concussion is duly weighed, it may be readily assumed that every attempt to increase the force of gunpowder by combination with such potent auxiliaries must result in mournful accidents to those using them in that shape, either from their immediate effect, or their progressive but infallible deterioration of the resisting properties of the metal. We consider, therefore, the practice which has partially obtained with some manufacturers of gunpowder of increasing the *quality* for the use of the Sportsman by the means adverted to, as a most reprehensible method of competition for public favour, and the more so as few are able to detect the introduction of the formidable adjunct, which in the smartly exploding charge though procuring for the manufacturer the repute for making a first-rate powder, may in the shape of a casually luckless and ill-assorted grain, ignite by friction in the powder flask, and perform upon the person of the confiding sportsman the effect of a Petard against the gate of a fortress. For the detection in gunpowder of such dangerous ingredients as the fulminates of nitrate of silver or of chlorate of potasse, we would impress upon the mind of the reader, that those fulminates combine but indifferently with the gunpowder, and will adhere to the hand on the least friction in isolated silvery molecules.

CIRCUMSTANCES DETERMINATING AND MODIFYING THE ACTION OF
GUNPOWDER.

Quantity would appear to be the first and fundamental condition on which depends the greater or lesser effect of gunpowder, inasmuch as a greater quantity consumed at once and simultaneously, must clearly induce an increase of the force ; but the just application of *this* principle does not exactly depend alone upon the condition of the “ simultaneous combustion,” but upon other circumstances also. These co-acting influences we will endeavour to explain.

Among the active influences which affect the exhibition of the strength of gunpowder, stands first, the solidity and completeness of its confinement, or in other words the *resistance* which opposes the expansive force of the powder.

When gunpowder is exploded in the open air, so that it has no other resistance to overcome but that of the surrounding atmosphere, the explosion takes place without the exhibition of great force or report. When the same quantity of powder is twisted up in a piece of paper only, and ignited, a greater exhibition of force is immediately observed ; and this increases with the strength of the enclosure or of the resistance which opposes the expansion on all sides ; but naturally, only *up to a certain limit*, which, as aforesaid, cannot yet be determined *absolutely*.

The reason of this law that the force of inflamed gunpowder increases to a certain limit, and in a greater proportion than the resistance which opposes it, lies in the common properties of all gaseous or elastic fluid bodies to expand, particularly when as in this case their elasticity is incited in a high degree. Such a body of elastic fluid requires especially a fulcrum, in order to act with effect, and one on whose solidity the action depends : from the greater resistance, moreover, a greater portion or the whole quantity of powder finds the time necessary for its inflammation and combustion, by which the action or force of the powder is suddenly evolved out of a greater quantity of powder damp, than when by the first expansion of *one part* of the powder, and therefore with a *less* force, the *lesser* resistance has already been overcome : in the above case also ensues a less partial dispersion or escape of the caloric, so prejudicial to the development of the force.

A further eminently active cause of the development of the force of gunpowder, lies in its greater or less rapid inflammation and combustion. But this depends not only on the interior character of the powder, but also on its greater or less humidity, on the size of the grains, their form, the form of the space which holds the powder, and on the density and condition of the surrounding atmosphere.

Dry gunpowder inflames and burns quicker than when in a damp state, or when it has suffered in its interior quality from that condition. *Smaller* grains burn more rapidly than larger ones, and the inflammation of their surface considered as simultaneous, must develop a greater and more sudden action ; a result which nevertheless, in particular circumstances only, is important, and valuable in smaller quantities of powder. Grains which are perfectly *round* and spherical in form, come in contact with each other at isolated points

only, and the intervening spaces between each grain being equal everywhere, permit the kindled flame to spread rapidly throughout the charge, when the surface of all the separate grains take it up in an instant, and those spaces facilitate greatly the inflammation, without taking into account the influence the atmospheric air which fills those intervening spaces, may exert upon the combustion by its oxygen.

But the more irregular and angular the grains, and the more they depart from the globular form, the more closely they must necessarily lie, with the entire sides of their surface against each other, particularly with an unequal size of grain; and when the powder is pressed together, forming small lumps, through which the kindling flame cannot, as in the former case, extend nor spread instantaneously. This speaks emphatically against the pressing together or tight ramming down of charges; though it must not be lost sight of, that inflammation and combustion must follow more suddenly and completely, the smaller the superficies of the space in which the powder to be exploded is confined, and when all the points of that superficies are as much as possible *equally distant* from the point where the ignition commences, as would be the case with a spherical formed grain when the inflammation commences at a central point.

The condition of the surrounding atmosphere, its humidity and different density, act also on the inflammation and combustion, but in a manner which has not hitherto been ascertained in all its bearings.

Lastly, the development of the force of gunpowder is affected by the proportion of the space which it occupies to the other parts of the space in the vessel or cylinder which it does *not* fill, and in which the inflammation and combustion takes place. Experiments have shown that with the increase of the unfilled space, the absolute force of the powder greatly decreases, which may be explained by the elastic fluid evolved into that part of the space which is only filled with air, losing in intensity and heat before it can act upon the projectile.

When guns are burst by their usual charge of gunpowder, the ball not having been driven home upon the charge, though a space filled with air only, intervene between them; it is thus to be explained:—the space between the charge of powder and the ball, has enabled the *full* expansion of the gases to take place *before* the ball is set in motion by them, and as the ball upon the first violent expansion of the fluid was not moved forward with the required rapidity, the violent reaction of the fluid takes effect on the barrel *before* the ball has received its impulsion, and the barrel bursts. Whereas,—had the

space not existed between the ball and the charge, the expansion of the gases of the gunpowder would not have been able to attain so high a degree of development, before the ball driven forward would have enabled the fluid to gain space *in the same progression or degree* only as the combustion effected itself.

In the same manner, though opinions are not agreed thereon, when a free space is left round *mines*, or that their charge of gunpowder is mixed with sawdust or other dry bodies, a greater effect is produced than if the whole space had been filled with gunpowder. Many believe, that in such cases, these effects are brought about by the assistance of the oxygen in the atmospheric air, which occupies the space unfilled by the powder. But we may here observe, that this effect takes place more particularly with larger charges ; (above one pound) and for certain this admixture could not be applied to ~~fire~~ arms, since from the increased residue which would be left after the combustion of such a charge, the re-loading of the arm would be as difficult as dangerous.

THE MODERN DISCOVERIES IN EXPLOSIVE AGENTS AND THEIR APPLICATION TO FIRE-ARMS.

THE knowledge of the detonating properties of metallic oxydes, is by no means of so recent date as we have seen repeatedly affirmed, and as is commonly believed, even in the present day of assumed universal information.

Priority of conception in all that relates to Science and Art, even in their comparative infancy, was doubtless ever a subject of individual or national rivalry and assumption—but at no time was it more flip-pantly mis-assigned, or more audaciously arrogated, than in the present day, by a host of empyrics, who, like birds of prey ever on the wing to swoop upon the ideas of master minds, convert them on every hand under the disguise of some specious modification to their own exclusive property of thought, and bear away both the fame and emolument which should be the meed alone of some departed or living genius.

It has always been our uncontrollable impulse to refuse acceptance of the dictum of a writer in whom we have thought to perceive the flippancy we have adverted to, or who at variance with truth on the subject treated, has written only with the obvious view to pander to misconceived and egregious national vanity, which reckless of justice and right, assumes to its own country upon every occasion indiscriminately, the merit of a discovery in science, or of an invention or improvement in art. As a practice which serves to perpetuate error; to throw obstacles in the way to the attainment of the knowledge of the right, and to flatter vulgar prejudice, it is one we have considered deserving of the severest censure and the most unsparing correction.

For the pardonable gratification of this deeply felt sentiment, it has ever been our delight to see and to assist “to place the saddle on the right horse” without respect for persons or nationalities: and to merit by every means in our power the confidence of the reader of these pages, we have spared no labour for our own satisfaction and his information, to make every possible research for the truth upon this as on every other part of our subject.

From these, in respect to the discoveries in Science and Art having reference to our present theme, results our more than ever confirmed conviction that we are for the most part too unmindful of the just injunction given by the sacred writer—"Look not every man on his own things, but every man also on the things of others,"* in observing which duly, and casting back to the mind labours of those whose names though almost forgotten, are yet to be found graven on some stone of that Temple of Science in which they loved to toil while living, and to whose grandeur their genius first contributed; each of us as individuals or nations, will find that however great may be our past or present merits, the men who have passed away long before us were not of inferior intelligence to ourselves; and that in days when a superiority of mind though not less jealousied than in the present, was a far more perilous distinction, the sturdy pioneers who first broke ground and opened up the mysteries of the physical world for our deeper explorations, were not *all* as a matter of course born of our own country.

In the very matter which forms the theme of the present subdivision of our subject, it is to the successive and untiring labours of those enthusiastic Alchymists of old, who at once the ridicule or superstitious dread of their time, consumed their life-energies in mysterious isolation, bent over the furnace and crucible, in their hope to seize the fleeting moment when as they believed, that transformation of the vulgar earths into GOLD would be achieved, that should endow them with those inexhaustible means of worldly happiness and power which was the dream of their existence. To these early Martyrs of Science, in the pursuit of the *Great Arcanum*, we are chiefly indebted for the sum of human knowledge which has initiated the modern world with the mysteries of Experimental Metallurgy.

But in the earlier days, when science and its researches were confined to the monastic cell, or the privacy of a mysterious and repulsive seclusion from the exterior world; few of those zealots of the Great Art were to be found willing to disclose their discoveries, and the results which their assiduous and secret labours had revealed to them in the shape of a knowledge of wondrous Alchymistic agencies were jealously wrapt in their own bosoms.

Few, even up to a late period of the 17th century, cared to form adepts in an art, the secrets of which, acquired by so much toil and privation, were the cherished monopoly of wisdom that elevated them in their own eyes to a rank above that of kings; and which, therefore, they jealously carried with them to the grave. It was in

this pursuit of the mysteries of metallurgic lore that Boulduc, in 1699, discovered the composition of a fulminating powder, but unwilling doubtless, as his predecessors, to reveal his discoveries, the particulars relating to fulminants remained in that vague obscurity which generally attends the early dawn of a new discovery.

But an Institution had been founded in France by Louis the XIVth, which, while it formed one of the greatest merits of his long war-stained reign was soon to afford the means of recording and handing down to the scientific world the too frequently lost labours of its votaries; for in the last three years of his reign 1712, 1713, and 1714, the Memoirs of the French Academy of Sciences record the experiment of Lemery concerning a fulminant matter of his discovery; and sixty-two after, in 1774, the year of the death of Louis the XVth, Bayen treats on the same subject in the February number of the *Journal de Physique*. This great Chemist, who in 1756 was chief pharmacist of the French armies at the taking of Port Mahon, had investigated this subject a few years afterwards (1766), and made himself a perfect master of the analysis of the fulminate of Mercury; respecting which in the year first adverted to (1774), when relieved from the laborious duties of his office during a long period of war, he found time to address his communications on the subject to the Academy of Sciences. It is, therefore, neither to Fourcroy and Vauquelin in 1738, nor to Howard in 1799, but to Bayen that the merit is due of divulging the composition of fulminating mercury, and to Fourcroy and Vauquelin can alone be attributed the merit of having introduced the mercurial fulminate into the new Chemical Nomenclature; for, even if they did modify it in any way, it could have been but imperfectly, since our countryman Howard was obliged to resume their labours, and in 1799 established the formula for the composition of the fulminate of mercury since called after his name.

But eleven years anterior to the definite results arrived at by the labours of Howard with respect to the mercurial fulminate, Berthollet had effected at Essonne (1788) experiments with another fulminate, to the discovery of which he had been led in his endeavour to manufacture gunpowder by a more simple and less expensive process. These experiments were made with muriatic acid. But it has been alleged, in complete error, that the muriatic powder of Berthollet, in which the fulminate obtained from hyper-oxygenated muriatic acid, or the chloric acid of the present chemical nomenclature was employed, or in use, in the year of his experiments at Essonne, for fulminates or percussion primers; the anachronism in

assigning so early a period to the invention and use of these, will be sufficiently obvious to our readers on the mere indication that such primary agents could not then have been applied to artillery or fire arms, since the mechanism of neither had as yet been modified for that purpose, and it is wholly inadmissible to suppose that a composition, the violence of which would not only have been highly dangerous, but have occasioned considerable perturbations in the fire of artillery, should have been used in making quick-match. If, moreover, the notion had been already entertained in 1788, of applying fulminants as primers to cannon, why should not the fulminate of mercury have been used, the analysis of which Bayen had long before revealed, and who, at the siege of Port Mahon, in 1756, when the provision of the quick-match for the artillery began to fail for want of saltpetre to make it, succeeded in extracting the nitre from the gunpowder. If, therefore, the idea had then been entertained of applying fulminants to the priming of cannon, is it not natural to suppose that Bayen would have availed himself of so favourable an opportunity to propose his product of mercury?

Doubtless the labours of Boulduc in 1699, and of Lemery in 1712—14, shed the first light on this mysterious study; but it was not until the more precise revelations of Bayen in 1774, of Berthollet in 1788, and of our countryman Howard in 1799, that science and industry, by slow degrees, made the fulminants subject of serious and open application.

In regard to Berthollet's discovery of the fulminate obtained from chloric acid, we will here cite a few words from the interesting but not sufficiently known work of Dr. Figuier.*

"The experiments undertaken by Berthollet in 1788 to replace the saltpetre of *our gunpowder* by *chlorate of potasse* are of a grave scientific character. In studying the oxigenated combinations of the chloride of potasse, Berthollet had discovered the chlorates, a class of salts, the most remarkable for their chemical properties. The chlorates are composites which decompose themselves with extraordinary facility; and, as they contain a great quantity of oxygen, this rapid decomposition renders this class of salts one of the most active agents of combustion of chemistry. The chlorate of potasse mixed with sulphur, with charcoal, or with phosphorus, constitutes so combustible a mixture that the blow of a hammer suffices to explode it. On rapidly tritulating also in a mortar a mixture of chlorate of potasse, sulphur, and charcoal, successive detonations are produced resembling the cracking of a whip, and red or purple flames

* *Histoire des Principales Découvertes Scientifiques Modernes.*

are seen to flash out of the mortar. These facts, on being observed by Berthollet, suggested to the mind of that chemist, the idea of substituting the chlorate of potasse for the saltpetre in gunpowder. The experiments he undertook with this view were in appearance crowned with the most advantageous results ; a very intimate mixture of sulphur, charcoal, and chlorate of potasse, in the proportions usual in the making of gunpowder, presented an explosive force of extreme energy, and so greatly exceeding ordinary gunpowder, that the projectiles were thrown to a distance three times greater than by ordinary gunpowder. Encouraged by this fact, Berthollet requested the government to authorise him to prepare a large quantity of the new powder for experiments on a more extensive scale. The gunpowder manufactory at Essonne was placed at his disposition, but the undertaking was attended by a very deplorable disaster ; a terrific explosion destroyed the manufactory, and several persons lost their lives in the catastrophe. We here give some positive details on this unfortunate event.

“ M. Letort, the Director of the Manufactory of Essonne, was full of confidence in the success of Berthollet's experiments and in the future of the new gunpowder ; he expressed the assurance that it would present no more danger in its manipulation than in that of the saltpetre-gunpowder. The day on which the manufactory of the new powder was fixed to commence, he invited Berthollet to dinner, and on rising from table they went into the workshops. The mixture was being made in the ordinary manner, in mortars with wooden stampers and with a proportion of water, in order to prevent the development of heat caused by friction. M. Letort was of opinion that the addition of water was superfluous, and that the mixture could quite as well be operated dry. To prove this he approached one of the mortars, and with the end of his cane, began to triturate a small patch of powder which had dried upon the edges. Immediately a fearful explosion was heard, the building was blown up and half destroyed, and from among the ruins were taken the bodies of the director, that of his daughter, and those of four workmen : Berthollet escaped as by a miracle.

“ Nevertheless, so much importance had been attached to the use of chlorate of potasse gunpowder, that the terrible event had not its full effect. Four years afterwards the government authorised fresh trials to be made. In the midst of the wars of the Republic, it was difficult to abandon the hope to possess an agent of such wonderful power. The precautions indicated in such circumstances were increased ; but all were useless, a second explosion blew up the manu-

factory and killed three workmen. Since that period the idea of repeating such fatal experiments has been abandoned. Besides it is now well known, that gunpowder made with chlorate of potasse presents no advantages, and nothing but danger. It detonates with such facility, that the mere vibration from the passing of a cart may cause its explosion. All the substances which like the chlorate of potasse, explode upon a simple blow, present in point of fact powders of a destructive *bursting* tendency, and taking effect at the same time upon the projectile, and upon the interior of the barrel of the gun, or of the cannon, almost always induce the bursting of the arms in which they are used."

The remarkable labours of this chemist upon the nitric, sulphuric, and carbonic acids, had already obtained for him a distinguished place among the men of science of the period, when in 1784 he was nominated to replace Macquer as Director of the manufactory of the Gobelins. It was shortly after his accession to those important functions, that he discovered the property of chloride of potasse to bleach wools. This substance was at that time called *oxygenated muriatic acid*. In treating this in various ways Berthollet found a product in which the oxygen existed in much more considerable quantity than in the chloride. He called this new produce *hyper-oxygenated muriatic acid*; this is the chloric acid of the present day, which, as is generally well known, detonates on the least concussion as soon as it is mixed with combustible salts. Notwithstanding the ill success of his experiments at Essonne, and the dangers to which he exposed himself, this indefatigable chemist did not allow himself to be cast down; but continued his researches on inflammable matters, and in the same year, 1788, discovered the fulminate of silver, or precipitate oxide of silver.

While on this part of our subject, we feel we should be but ill-performing the duty we have assumed towards our readers, did we not advert here to a man who would seem to have been born of that category of beings, who in spite of all they may do, are destined only to experience the ingratitude of their contemporaries. The chemist ROUELLE, a biographic notice of whom is to be found in the correspondence of Baron De Grimm, Councillor of State of the Empress Elizabeth of Russia, was of this hapless number. Rouelle had studied under the German chemist Spitzley, and had not only given a very great impulse to the progress of chemistry by his enthusiastic labours, and even formed the greater part of the distinguished men of science—Darcet, Chamousset, Bayen, Cadet, Gassicourt, Parmentier, Berthollet, and Lavoisier, but all those who preceded the phalanx to

which belonged Guyon de Morveau, Fourcroy, Vauquelin, Gay Lussac, and Thénard.

To use the words of Baron De Grimm, "Rouelle ought to be considered as the founder of Chemistry in France, and nevertheless his name will pass away, because he never wrote anything, because those who did write estimable works on that science in his time, and who issued from his school, never rendered their master the homage which they owed to him; they found it more convenient to place the principles they derived from their master, to their own account: hence with good reason there was a coolness between Rouelle and all those of his disciples who wrote on chemistry. He avenged himself for their ingratitude by the abuse with which he overwhelmed them in his public and private lectures; and it was known before-hand, that on the occasion of such a lecture he would give the portrait of Macquer, at another that of Malouin, pictured to the life: according to him they were ignorami, shavers, fraters, and *plagiarists*. This last term had acquired in his mind so odious a signification, that he applied it to the greatest criminals; and to express, for example, his horror of Damien, he said that he was a *plagiarist*. His indignation for the plagiarisms which he had suffered degenerated at length into a monomania: he always beheld himself plundered; and when the works of Pott, or Lehman, or of any other great German chemist were translated, and that he found in them ideas analogous to his own, he pretended that those people had robbed him.

"Rouelle was of an extreme petulance of temper; his ideas were confused and without clearness; it required a good head to follow and bring his lectures into any order and precision.

"He generally explained his ideas in a very diffuse manner; and when he had said all, he then added: "*But that is one of my Arcani which I divulge to no one.*" One of his pupils would frequently get up and repeat to him in a whisper what he had just said aloud: Rouelle would then believe that the pupil had discovered his Arcanum by his own sagacity, and he then entreated him not to divulge what he had just said before two hundred people.

"He was generally so absent of mind that external objects no longer existed to his senses; when speaking he would act like one possessed; throw himself back into his chair, strike himself, kick the person next to him, and tear his wrist ruffles without being in the least aware of it. One day being at a party where many ladies were present, while speaking with his customary vivacity, he unfastened his garter, drew his stocking down over his shoe, scratched his leg for some time with both hands, replaced his stocking and garter, after

which he continued his conversation without being in the least aware of what he had been doing.

“In his course of lectures he was generally assisted by his brother and nephew, to perform the experiments before his auditors. These assistants did not always attend; Rouelle would call out: “*Nephew! eternal Nephew!*” and if the eternal nephew did not come, he went himself into the back part of his laboratory to get the vases or objects which he required. During this operation he still continued his lecture, as though in the hearing of his auditors, and on his return had frequently terminated the demonstration which he had commenced, and re-entered with the words: “*Yes, Gentlemen.*” He was then requested to begin again.

“One day being left by his brother and nephew, and performing by himself the experiment he required for his lecture, he said to his auditors: “*You see, Gentlemen, this cauldron on the furnace? Well, if I discontinue stirring it for a single moment, an explosion would take place which would blow us all into the air.*” With these words, nevertheless, he did forget to keep the matter stirring, and his prediction was fulfilled: the explosion took place with a fearful noise, broke all the windows of the laboratory, and in a moment two hundred auditors found themselves scattered in the garden. Fortunately no person was wounded, because the chief force of the explosion had found an issue by the opening of the chimney; the learned lecturer escaped with the loss of his wig and the damage done to the chimney.

It is truly a miracle that Rouelle, performing his experiments almost always alone, because he desired to conceal his *Arcani* even from his own brother, who was very clever, did not blow himself up by his frequent inadvertencies; but, by dint of inhaling the most pernicious exhalations, he became paralysed in all his limbs, and passed the last years of his life in terrible suffering.

“Rouelle was a frank and honest man, but of so rough a mould of character, that he could not understand or observe the established forms of good society. Rouelle was demonstrator at the public lectures in the *Jardin des Plantes* (then the *Jardin du Roi*). Dr. Bourdelin was professor, and generally finished his lecture with these words: “*As Monsieur the Demonstrator, will prove to you by his experiments.*” [Rouelle, then addressing the audience, instead of making his experiments, said: “*Gentlemen, all that Monsieur the Professor, has just told you is false and absurd, as I shall prove to you.*” Unfortunately for the professor, the demonstrator frequently kept his word.

“He was on the other hand a zealous and patriotic Frenchman, but censorious and fond of news when he had not his eyes fixed upon a crucible. At the commencement of the last war, he wanted to command the flat-bottomed boats to go and burn London. He did not the least despair of finding a means to set fire to the English fleets under water; it was one of *his arcani*. I met him the day after the battle of Rosbach; he was quite lame and walked with difficulty. “*Eh! God bless me, what has then happened to you, Mr. Rouelle?*” said I to him. “*I am milled—ground,*” he replied; “*I am quite done for; last night the whole Prussian cavalry rode over me.*” He then called the enemies’ Generals plagiarists, and I felt it was not the moment to make him alter his opinion. He was sometimes so much affected by great military and political events as to discuss them in the midst of his course of chemistry.

“He reckoned among his disciples not only all the most eminent chemists of the present day, but a great number of men of celebrity and merit of all classes; independently of his excellent principles in chemistry, he possessed, moreover, the secret of all men of genius, that of making you think.”

In the words of a modern French critic of some acumen:—“By a strange fatality for the name and scientific repute of the eccentric but gifted Rouelle, at a period when the literature of France beamed with intellectual light upon the whole of Europe; he, Rouelle, the father so to say of chemical science in that country, never put pen to paper.

“Whether he was too much engrossed by his labours, or preferred action to writing, or that he possessed little aptitude for authorship—Rouelle wrote nothing. This was doubtless a serious loss to chemistry; for whatever his disciples may have contributed, they did not wholly make up for the silence of the master.”

The facetious pen of the titled agent and spy of the Russian court, Baron Grimm, whose business it then was, as since it has been, and is in the present day, of similar skilfully selected servants of the Russian state policy, to render a faithful report to his sovereign of the thoughts, sayings, and doings, of the chief personages, men of science, and literati of the several European capitals, depicts the French chemist, doubtless, to the life.

Rouelle, as it may be believed, was an original of his kind, a rough diamond; and, as such aberrant specimens of the man are usually designated, a half-madman, whom every body thought himself privileged to ridicule. But, with all this, Rouelle was incontestibly one

* Anquetil, *Notice sur les Pistolets tournants*.

of those devoted path-finders in Science who consecrate their existence to study.

It may not be doubted that Alchemy possessed formerly many precise data relating to numerous fulminant matters of which science at a later period has given us the analysis and established the properties and formulæ. But the alchemists, as already observed, wrote not, or when they did write, they enveloped their thoughts under a mysterious hermetical cloud, the depth of which was beyond the ken and intelligence of the profane.

In compensation for this, nevertheless, here and there one, like Rouelle, of more generous mould, took delight in forming adepts in their art—some favourite pupil, the beloved disciple of their preference, or he among them in whom the natural disposition and intelligence best responded to the hope of the master, in order that their name and the memory of their discoveries should be rescued in his person from oblivion. Rouelle, as already observed, had studied under Spitzley; had he acquired from him the vast store of knowledge that he possessed, or was it the fruit of his own researches? Be this as it may, it is more than probable that he possessed the key of numerous fulminate compositions, and the experiment of the cauldron, cited by Baron Grimm, is alone sufficient to confirm the presumption. By a striking coincidence of time, this leads us back to the nearer consideration of the close approximation between the chemist Rouelle, and the Dupré of whom we have already spoken in Paragraph (29.) of our Historical Retrospect.

In 1750, at the commencement of the disastrous war in which France beheld herself despoiled by England of her finest Indian possessions, Rouelle offered to direct a squadron of flat-bottomed boats and pledged himself to burn the English fleets and London itself. With all his eccentricity, as deviating in habits and manners from the polish of French society in his day, Rouelle was a man of serious character and of steadily established habits of thought—he had a long practical experience in chemical manipulations, respecting which he was unlikely to assert things of so grave a nature with lightness and flippancy. It was no fault of his that his proposals were not accepted—nevertheless rejected they were.

From 1742 to 1766, the long period of twenty-four years as chemical demonstrator at the Jardin du Roi, (the present Jardin des Plantes) Rouelle prepared and performed all the experiments of a course of chemistry, which as the taste for the physical sciences became a prevailing fashion of the day, found auditors among the élite of French society of both sexes and persons of all classes. Such being

the case, it may readily be presumed that Rouelle, ingeniously loquacious, absent and somewhat eccentric as indeed are most men who devote themselves to study, carried away by one of those impulsive outpourings of the mind-wealth within, or yielding to one of those emotions of pride—pardonable enough perhaps, and too difficult to suppress, for one who has made himself master of an important discovery—should in such an unguarded moment have revealed sufficient to put some of his auditors, whose zeal and intelligence he may have remarked, upon the track of his Arcani. When we think that Chamousset, Bayen, and Cadet-Gassicourt, who were all three, disciples of Rouelle, who all three knew the detonating property of amalgams and of the metallic salts, were led thereto by certain reminiscences of the lectures of the celebrated Professor, the following suspicion arises in the mind, and is arrived at by reasonable induction :—

It was five years only after Rouelle had made his offer of an incendiary matter burning on and beneath the water, that Dupré (1755), presented his. It will be recollected that Rouelle was then and had long been a public demonstrator of chemistry ; that he was a simple open-hearted man ; and before his too confiding nature, taken as it were by surprise, had engendered his subsequent mistrust, may he not have been too communicative of his knowledge ? As for Dupré, he was one of those adventurers whom our sprightly neighbours beyond channel have since designated by the comprehensive titular of “ Knights of Industry ; ” a precursive type of that numerous class of individuals, in the present day, who in every protean guise imaginable, illustrate the dictum of the sage who established but two generic classes of men, as best defining the quality of the social soil that produces them. Under cover of his trade of jeweller, he dealt in false diamonds, and at his need made them also. Engaged in such an occupation, it may be readily conceived that the lectures of the most distinguished chemical practitioner of the day were not unfrequently attended by him. From such a probable supposition, the sequential inference presents itself as readily, that, Dupré was one of those who taking advantage of the too confiding Rouelle, and possessing himself of one of his favourite Arcani, excited the horror of plagiarists so openly expressed by that chemist. In support of such an inference, besides the priority of the divulgation, Rouelle has his known open uprightness of character in his favour.

It may be urged ; though Rouelle did not write, why did he not speak out in support of his prior right of property in the revelation ?

But Dupré had one more advantage, and a great one over the

chemist ; his fabrication and sale of false diamonds had brought him into relations with the Court of which he had the tact to avail himself so well, to procure support in his negotiation, that he obtained more than he had hoped for : a title and a pension of 30,000 francs, an enormous sum for that period.

Though his secret was purchased, it is within reason to think that no vague sentiment of humanity induced its purchase, but much rather the fear that such a discovery becoming known, a misuse of it could quite as possibly be made against the king and his ministers as against the enemies of France.

Rouelle himself did not live so completely out of the world as not to know the character and disposition of the Court. He was well aware of the existence of the *lettres de cachet* by which the ministers of Louis got quietly rid of all who raised any plaint or clamour against them. He was not a rich man : he held also a Government appointment, and having need of tranquility for the prosecution of his labours with a declining health, he was obliged to smother his discontent in silence, and keep secret those discoveries which if divulged might both trouble his peace and arrest the course of his loved experiments.

As summary to these details of the matter-of-fact knowledge possessed by many men of science, and others, at the commencement of the second half of the last century upon the fulminates, particulars which we considered would prove acceptable to many readers : it may be here observed, with no injustice to the present state of intelligence of the subject, that notwithstanding the constantly pursued researches of Chemists and Pyrotechnists, we have not surpassed if even we have come up to the point at which Rouelle, Dupré, Torré, and Chevalier, had arrived from 111 to 58 years ago in the secret of preparations possessing the property of burning in the water. For though the combinations of the oxide of silver with ammonia, and of a salt of silver with ammonia and potasse, of which Berthollet gave the formulæ in 1788, are susceptible of detonating in the water, yet are they almost immediately extinguished ; and though Serrulat and others of the present day, have shown the property of water itself to become an ignitive agent when brought into contact with many saline and metallic amalgams, and as such to be available for submarine mines ; though the formulæ of the detonants may be more distinctly elaborated and in some instances novel, yet the discovery and use of the ignitive properties of water to produce combustion is some centuries old, and detailed by Hanzelet, 1620, and by others before him, as applied to combustive shells, &c., used in sieges to discover

and reveal at night the works and movements of the enemy when thrown into the wet ditches of fortresses. With personal knowledge therefore, and conviction, we will affirm that there exists no incendiary shell or appliance that has been brought forward as a new discovery in the present day which has a clear title to the name; from the *grénades asphyxiantes* of recent re-introduction in the French marine artillery to the combustive shells in course of trial by our present Ordnance authorities.

FULMINATING OR GUNPOWDER COTTON.

The successful application of the fulminates of the class we have adverted to, was soon to be followed by the discovery of detonating agents of a new kind, possessing not only the characteristics of immense expansive and projective power comprised in an exceeding small volume and gravid weight, but a great facility of preparation at a comparatively small cost, and some degree of less peril.

In 1832, M. Braconnot a chemist of Nancy, in France, in treating starch with concentrated azotic acid was led to the discovery of a pulverulent and combustible product, to which he gave the name of Xyloidine. This discovery was passed over nevertheless with but little notice; till in 1838, M. Pelouze, a chemist of some celebrity, resuming the labours of M. Braconnot, discovered that the very simple matters, paper, cotton, linen, and a variety of tissues as well as other substances, possessed the fulminating property attributed to starch.

But it did not enter his mind, more than that of M. Braconnot, to try the effect of those products to the loading of fire-arms. That happy thought suggested itself to Professor Schönbein, of Basle, in 1846; and the surprise which such an appliance created in the public mind, at a moment when thanks to the vast improvements derived from the new principles successfully established in the structure of fire-arms, at *the very part* where it had been considered no modification or improvement could be effected, may be in the recollection of many of our readers.

Nevertheless, for many reasons, the different Governments of Europe did not evince any great disposition to welcome this discovery. In this, some were influenced by the illiberal representations of the Boards of Artillery, everywhere the sworn enemies of everything that does not emanate from their own body, as of everything calculated in their opinion to diminish their influence and importance; others which had reserved to themselves the exclusive right to manufacture and sell gunpowder, feared their monopoly was about to slip through their fingers; and all, in fact, at a moment when society everywhere

was agitated with revolutionary fermentations, feared to see this new product of Chemistry become in the hands of the people both a cause and a means for incessant troubles.

Although the period of the discovery of this ingenious appliance is so recent, the combination of the constitutive elements of the Pyroxile has been studied with such success, as to enable its immense expansive force to be tempered and restrained within limits that render them no longer dangerous and destructive of the arms, yet with the retention of a projective force from six to eight times greater than gunpowder ; so that by loading a gun or pistol with one-sixth of the charge of powder, and a rifle, rifled pistol, or other arm having a good substance of metal, with one-eighth of the usual powder charge, excellent results may be obtained without the risk of bursting them, and of its consequences.

The light brought to bear in the last century upon the properties of different products with metallic or saline bases, having once led to the knowledge of new explosive agents igniting by friction, and by concussion, the uses to which they might be applied became as a natural consequence a subject of study.

A sufficiently determinate intelligence of the degree of explosive force of the fulminates having been thus gradually acquired, they were first appropriated by Pyrotechnists, and eventually applied to their most important use in their substitution for the flint, as a means of ignition for fire-arms ; and with the first successful supersession of the flint in the improved Percussion-lock to Sporting guns, a new era of progress dawned once more also for the arm of the Infantry soldier, the magnitude of the importance and bearings of which, grasped and admitted at first by the intelligence of a few only, has now assumed a character which threatens to effect almost as great a revolution in the whole art of war as the discovery of gunpowder itself.

Applied to this purpose, there are two kinds of percussion powder, and each has its respective advantages and inconveniences. One consists generally of a hundred parts of chlorate of potasse, twelve parts of sulphur, and ten parts of charcoal ; this is called *muriatric powder*. The other kind is composed of five parts of fulminating mercury, and three parts of gunpowder ; or, instead of the latter, of three parts of saltpetre, and is called *fulminating powder*. As charcoal has a great tendency to absorb moisture, it is omitted by some, and the sulphuret of antimony substituted for it. The above with

various other formulæ of the fulminates are, nevertheless, still in the course of yet further modification and experiment, and are by no means wholly established as admitting no variation.

The preparation of these different kinds of powder, which we recommend no Sportsman to attempt, is most safely effected in *small* quantities; the last-named with, and the former without moisture, gently triturated and mixed on marble slabs or in earthen vessels. As regards the preference to be given to either of the above-named fulminates, there yet exists much difference of opinion. The muriatic powder is more frequently used, although it has a chemical action upon fire-arms that is very deteriorative, particularly to iron. The preparation of the fulminate of mercury has been objected to on hygienic grounds by Dr. Van Broeck, an eminent Belgian army physician and chemist, as emitting mercurial vapours highly prejudicial to the health of the soldiers, when fired for any length of time by several hundred men in the restricted space of a square, or in casemated buildings, &c.; and though less detrimental to the metal, more dangerous in the preparation and transport; more expensive, and more subject to miss-fire, from being readily impaired by damp, and also, as extremely subject to accidental ignition.

The Gunmaking Craft in appropriating the fulminates to its use, necessarily imposed on itself the task of finding the mechanical modifications requisite for the purpose, and as necessarily these were effected progressively only. But as early as from 1807 to 1810, Lepage, a then celebrated gunmaker in Paris, distinguished by the estimation in which his productions were held by Napoleon, brought out the first new mechanism for portative percussion arms. Having conceived a method of using the new priming medium, and a motive power in the percussion-hammer, he suppressed the pan of the flint lock and substituted in its place a disposition of the breech of the arm, which eventually became the nipple. He then changed the cock, and afterwards modified the interior of the lock.

The road thus thrown open, other Parisian, London and German gunmakers were not long in entering it as competitors, and the rivalry in mechanical skill which resulted from competition, bore its usual fruits. Forsyth in England was not long in following, and soon after took out a Patent for a System of Percussion, in which we believe the detonating medium, in balls, was an amalgam of chlorate of potasse, sulphur, and lycopodium. For the most part, the earliest locks adapted to the Percussion System were constructed with a small magazine containing a supply of the fulminate powder in

grain, which upon the cocking of the gun supplied a kind of pan with a few grains of the fulminate, which were exploded by the stroke of a hammer. The complicated structure of such a lock was found to have numerous disadvantages; and the speedy deterioration of the percussion powder, which from the great tendency both of the chlorate and charcoal to imbibe the moisture of the atmosphere, was soon effected in its readiness to inflame. Hence this mode of percussion firing was wholly inadmissible. To obviate this, Prelat, of Paris (1818), had covered the priming grain with a varnish, but this was far from answering the purpose.

Though the Percussion System of Lepage, and his imitators or rather modifiers, did not long keep its ground, yet is the meed of merit due to Lepage for having traced out the road on which so many other inventors were impelled to follow in emulation of the idea which constituted him the founder of the new school. At length, thanks to the mercurial preparation of Howard, a further step was made by Deboubert, of Paris, 1820, wholly transferring the primitive capsule into the present percussion cap, which concurrently with Blanchard's of the same city, made the system and percussion gun of the present day what it is. It was then believed, and a few years since only, impossible to effect any further important improvement, whether in the manipulation of fulminates, in the combined action of the limbs of the lock, or even in the mode of constituting and loading fire-arms. To prove the errors of this belief; among other discoveries made in quick succession, was one which we shall speak of more fully in its place, as establishing above all the rest the fact, that in the science of fire-arms, as in all else, we were yet but in the youth of a transition state. Progress may halt awhile, as though to repose itself and take breath; but obedient to that impulsive destiny which urges it onward, overthrowing prejudice, the customs of a day, narrow-minded selfishness and stubborn routine, it resumes its way, and in the conflict of the new mind with the old, victorious ever, moves forward in new guise and new-born strength.

For the arm of the Sportsman much had been effected; the Soldier alone still shouldered the nearly two hundred years old little altered flint lock upon his musket. For the Soldier only, no one had yet known how to apply the now common and acknowledged advantages of percussion firing. Many things it must be admitted, contributed to delay this extended adoption of the principle; for those whose duty it was to consider and attempt its application, were necessarily obliged to weigh well the numerous and almost insurmountable obstacles which the introduction of this system of

firing presented for an entire army, and no less, the means by which those obstacles were to be overcome. It is one thing, for a lover of field sports, to order the making of a single gun of his gun-maker, according to any new and approved principle, who is enabled to give to it his whole and undivided attention, and to turn his whole industry and skill upon the construction of that single arm; but it is a very different matter when hundreds of thousands of muskets, constructed upon a long established principle, are to be adapted to a new one. There is, in fact, no room for comparison between the outfit and preparation of the Sportsman for the field with his individual arm and its ammunition upon a new principle, and that of the re-modelling of the arms of an entire army. If this was felt by the Governments of states whose security from without, and internal order, depended more than then did those of this country upon the efficiency of their Military organization; the hesitation which was shown in England, where a jealous and inveterate opposition had long been evinced to every expenditure for the service and advantage of the Military arm, may be readily conceived and accounted for.

But the example of the Continental states was soon to render it a matter of *necessity* to place our troops on a footing of Tactical efficiency in arms with those of the other powers, in the event of such a thing as war.

Numerous experiments had been made on the Continent, where not even the smallest state of Germany remained inactive. A variety of suggestions had been listened to with attention, but not enduring the test of proof, were in turn rejected. It is true that all the earliest obstacles were not yet overcome for the adaptation of the Percussion system to a military arm; such as the sure and efficient fitting of the caps on the piston or nipple, which in the quantity to be manufactured on a large scale, and with the requisite expedition, could not so readily be put out of hand with the nicety and precision the thing required. A difficulty had been also found in regulating the degree of heat, so as to obtain such a regular and proportionate size and thickness, as to admit of the Percussion medium contained in the caps resting equally on the nipple, and with a firm hold; while if the cap was of greater diameter than the nipple, it fell off upon the least movement.

An employé in the imperial Austrian service at Milan, of the name of Console, was in 1835, to solve the difficulty for the arm of the Soldier after another mode. He projected a method of firing, in which the percussion powder was contained in a small tin cylinder

or cap, seven lines in length by one in breadth, called the *zunder* or igniter, which on the stroke of the hammer, delivered the stream of fire in a *horizontal* direction to the charge in the barrel. This had been effected *vertically* by the caps of Deboubert. Imperfect at first as was this suggestion also, yet those who were able to detect its merits, clearly saw therein another fast approaching remedy for all the disadvantages of the primitive capsules, and decided in its favour. Experiments on a small as well as more extensive scale were now carried out; and at the suggestion of field-marshal Baron Augustin, the musket-lock of the Austrian soldier was constructed upon principles more in consonance with the improved condition of military technics. From being flat, the priming agent was now round as in the sporting-gun. The percussion medium was also changed, and the new Percussion cap contained also the fulminate of mercury; for experience had shown that the chlorate attacked the metal of the gun. Thus, in 1840, the alteration of the old flint-lock into this form of percussion-lock, was begun for the whole Austrian army.

In the new disposition of mechanism, which was required for the percussion-lock, the property possessed by fulminating powder to ignite on the concussion of two metals, instead of igniting by the spark emitted by the flint against the hammer of the flint-lock pan; nothing was in reality changed at first in the interior of the lock; but externally, the hammer had disappeared entirely, together with its spring, pan, and flint. The cock had become nothing more than a little conical, hollow hammer, substituted for the jaws which held the flint, at the bottom of which hollow the priming medium was introduced, enveloped in a little cap made of thin sheet copper, in the form of a small cylinder. This cock, or rather hammer, falling with an ordinary force upon a kind of anvil or piston, also of a conical shape, fitting exactly into the hollow of the cock, compressed the priming in the cap and ignited it. The little anvil pierced with a hole terminating near the bottom of the powder charge, communicated the fire thereto, and the charge exploded immediately. Eventually the piston gave place to the nipple, and the present Percussion system was completed. What a simplicity of structure when compared to the old wheel-lock of past centuries—and all emanating from the modern progress in the Science of Chemistry.

Convinced alone by this movement with which France had kept pace, the various and universal defects that had so long existed in the structure of the European musket, and of the lock hitherto in use, were attentively considered by all the other Continental states. The result in most of these was the establishment of a wholly new

arm for the Infantry soldier, better adapted in its several parts, its form and structure, to all the requirements of the modern system of war.

A lapse of three more years, and the flint-lock musket of the British army was transformed to the percussion musket ; but with us the original defects of the old arm remained otherwise the same. It was the cobbling only of that which was bad inherently, instead of at once establishing a better model for the new arms then in course of manufacture—while in France, where the most assiduous attention was still directed to the establishment of further improvements, by the expiration of 1842, a percussion Line-musket had been introduced, fulfilling almost all the conditions then considered desirable in an Infantry arm, and greatly superior both in solidity, facility to keep in order, and precision of fire.



THE GENERAL PRINCIPLES ON WHICH THE CONSTRUCTION OF FIRE-ARMS IS BASED.

ALTHOUGH the construction of Fire-arms differs in many respects, according to the different purposes for which they are respectively designed, or the caprice of the amateur, as Sporting guns : yet as far as relates to their main object as arms of War, the requisite and fundamental qualifications of their barrels, the action of the gunpowder constituting their charge, and that which relates to their projectiles, are nearly the same with all. It is, therefore, under a general and collective sense that these are to be considered, and that the fundamental features of their structure, action, and use, are best defined and established ; so as to save re-adverting to these in the after description of their different kinds.

To arrive at a proper estimate of the nature and requisite qualities of gun-barrels, it is necessary that the main object and purposes of their structure should be known, and the special leading point to this, is the consideration of the force exercised by the inflamed gunpowder upon the barrel and the projectile.

Supposing the charge in the barrel to be inflamed, it must be imagined that the powder-gas developed by the inflammation strives to expand *equally* upon all sides, i. e., that it acts or impinges with the same degree of force upon the immediate sides as against the bottom of the barrel, and against the projectile. For this reason, the sides of gun-barrels as indeed of the cylinders of all *fire-arms* must have such a capability of resistance or strength, and such a connection and adhesiveness of all their parts, that they can withstand the expanding force of the gunpowder, which would otherwise burst them, and the result of the impulsion of the projectile either not be effected at all, or incompletely, and with great danger to the person firing.

It is, therefore, eminently necessary that that part of the barrel where the powder is inflamed, i. e., nearest to the bottom, or the *breech* of the barrel, should be the strongest, and stronger than towards the open end or *muzzle* ; because with the sudden decrease of the density and inflammation of the powder-gas, its action upon the sides of the barrel decreases also.

It is for this reason, that the external form of the barrels and cylinders of most fire-arms is somewhat that of a *truncated cone*.

When the surrounding sides have the proper solidity, then the force of the inflamed powder which expands equally on all sides can effect no movement of the barrel, either to the one side or the other, or upwards or below ; because the pressure or blow which acts upon or strikes, for example, the upper and right side, strikes also simultaneously with the same force upon the under and left side immediately opposite ; and thus a reciprocal lifting and equalization of the acting force of the powder takes place in the opposite direction.

This action experiences, nevertheless, some change from the opening called the *vent* or touch-hole, when, as is mostly the case, it opens above or on one side through the side of the barrel ; because as a part of the powder-gas pours out unimpeded through it, the barrel must follow the blow or pressure which it receives from the force of the powder on the side opposed to the vent ; since here, no reciprocal lifting of the acting force takes place on the opposite direction. The amount or force of the blow which is brought about by the vent, depends on various collateral circumstances, which in this place cannot yet be more closely adverted to.

A similar circumstance as regards the action of the inflamed gunpowder, takes place in the direction of the axis of the barrel, but in far greater degree ; for as the projectile is driven by the force of the inflamed powder into the bore, and lastly out of the barrel, there ensues, (while here also, no *reciprocal* lifting of the blow takes place in the opposite direction as at the enclosing sides, as soon as the projectile leaves the barrel,) an action in the opposite direction, against the bottom, which is called the *Recoil*.

Both as a point of support or fulcrum to the force of the inflamed gunpowder acting upon the projectile, as also for the obviation of the danger which might otherwise result from it, the solidity or strength of the bottom of the barrel is as much a cardinal condition as that of the enclosing sides in the construction of gun-barrels.

The vent should be opened as near as possible to the bottom of all fire-arms, as otherwise it would not be possible to shoot with very small charges, and because experience has shown that those fire-arms which have their vents more towards the muzzle give a much stronger recoil.

THE WEIGHT OF GUN-BARRELS.

Next in importance to the above cardinal qualification in a gun-barrel is, that it should have a certain *weight*. Though the recoil adverted to above may have no prejudicial influence, yet must the

motion which it produces be met, and if not wholly counterbalanced, yet diminished and limited so far as to render the use of the arm neither dangerous nor unpleasant. For were a barrel supposed even of strength sufficient to resist the explosion of the charge without bursting, yet which was not heavier than the projectile, there can be no doubt that upon being fired (if no other circumstances acted to prevent it) the barrel would be driven backward to a distance equal to the forward impulsion of the projectile, which can only be met and prevented by giving to the barrel or the whole fire-arm, a weight many times greater than the projectile discharged from it.

THE LENGTH OF GUN-BARRELS.

The following may be deduced from practical experiments, having especial reference to the mode and manner of the action of gun-powder. The projectile by its weight opposes a resistance to the expanding force of the inflamed powder—to overcome this resistance, the development of a certain force is necessary. It is only after the development of this force that the projectile is set in motion from its state of rest, with a *velocity* proportioned to the force developed by the inflamed charge. If the charge be greater than is required then will the force acting upon the projectile, or in other words the velocity, increase by the successive combustion of the remaining parts of the charge effected in the next consecutive instants of time; and this, if the barrel is of the requisite length, will continue until the whole charge has developed its force and acted upon the projectile. The greatest velocity which by such means would be impressed upon the projectile, will be equal to that with which the inflamed gunpowder has expanded.

From this, of a consequence, follows, that under an otherwise parity of circumstances, a *certain length* of barrel is necessary to a charge, in order that while the projectile is in the barrel, the charge may wholly consume itself and impress upon the projectile the greatest possible velocity. If the barrel be *longer*, it is of no use, because the projectile has already received the greatest velocity which the charge can impress upon it; and if the barrel is *shorter*, then the projectile issues from it before it has received the action of the whole charge.

Hence for every charge there is *one* certain length only, which for the above reason, is the proper one, and up to this length, therefore, in general, under otherwise equal circumstances, the longer barrel will give a greater *range* to the shot; the longer barrel assists also the precision of the shooting, for reasons which we shall hereafter have occasion to advert to more closely.

The following circumstances must, nevertheless, be taken into consideration in reference to the length of the barrel as modifying the above.

Experience has shown, that with an increasing velocity of the projectile, the resistance of the air which opposes it increases in greater degree, so that the distances or *ranges* to which projectiles are thrown, increase in a much less proportion than the initial or first velocities with which the projectiles left the barrels or cylinders.

It is furthermore, nevertheless true, that in the above respect, with an increase in the length of the barrel, the velocity of the projectile increases on the whole ; but this increase is considerable only at the commencement, and takes place only in an always less degree, until at length it wholly ceases. If for instance the projectile be supposed passing through the barrel with its first imparted velocity, it will be readily conceived that the still succeeding development of the force of the charge, will upon the whole, increase that velocity ; but also, that this increase in equal divisions of time, takes place only in a degree by so much the less, as the already attained velocity is great.

Supposing the velocity attained in the first division of time to be one hundred, its increase in the second division of time to be one hundred and fifty, in the third, two hundred, the fourth, one hundred and fifty, the fifth, one hundred, the sixth, fifty ; then would the whole velocity in the second division of time be two hundred and fifty, in the third, four hundred and fifty, in the fourth, six hundred, in the fifth, seven hundred, in the sixth, seven hundred and fifty : the velocity on the whole was therefore increasing, but the increase took place under *decreasing* circumstances ; and in a somewhat similar manner is it with the action of the charge on the projectile.

Hence it may be established, that beyond a *certain limit*, the increase in the length of the barrel gives but an unimportant increase to the range. If, therefore, a certain length of barrel attains a range adapted to the general purpose required, there is no reason to give a preference to an increased length of barrel increasing so slightly the extent of range, when other advantages, such as decrease of weight, and greater ease in handling, &c., can be gained by the former.

CHARGE OF POWDER.

In the foregoing exposition of the necessity of a certain length of barrel for a certain charge, will be readily perceived, also, the grounds on which the proportion of the latter is established ; in other words, that under an otherwise parity of circumstances, there is in fact for

each respective length, *one appropriate charge* only, which produces the greatest range. A greater charge would not only not increase the impulsive force, because the projectile will have already left the barrel before the increased part of the charge will have been burnt, and will therefore be in part projected out of the barrel unconsumed, as we have frequently seen occur; but by the increased charge occupying a greater space in the barrel, the projectile will also come to lie further forward towards the muzzle, and by that means the space will be shortened in which it is exposed to the action of the charge of powder in the barrel.

A *lesser* charge, on the other hand, will not impart that velocity to the projectile which in proportion to the length of the barrel might be given to it.

There are, moreover, many other circumstances to be considered as comprised in this exposition respecting length and charge, such for instance, as the purpose to be attained, the kind of fire-arm, the amount of recoil, the character of projectile, &c., &c., subjects on which we shall dilate more fully in the sequel.

WINDAGE.

In the days (and they are indeed not far behind us) when the attainment of rapidity of loading and firing without great regard to precision and effect were considered the cardinal tactical qualities of the British infantry soldier under fire, the prejudicial effects of an excess of windage, upon the direction in which the ball leaves the barrel of the musket, were not only often greatly overlooked, but even ignored or obstinately disregarded. To get the ball into the barrel and put it down upon the charge with such ease that the muzzle could be turned with the least possible delay upon the enemy, was the especial requirement of a system of Linear tactics, the rigidity of which grew out of the very defects of structure in the Infantry fire-arm itself. To effect this, the diameter or calibre of the ball was of a necessity required to be smaller than the diameter of the bore. This difference in the diameter of the ball and bore, called the *windage*, had nevertheless a material influence upon the action and effect of the arm, and this was greater in the British army, than in that of any of the other European states. By this arbitrary arrangement, a great portion of the force of the gunpowder escaped from the barrel without obstacle, even *before* the ball was set in motion, and partly as long as it still moved through the barrel, and therefore of a necessity without participating in the same velocity as the outward streaming powder-gas. By this windage, therefore, a

part of the force of the inflamed powder-charge was lost, without taking a concentrated effect upon the ball, a loss which increased with the extent of the windage.

From this defective arrangement resulted, however, another very important disadvantage. Let the reader imagine to himself the ball lying in the barrel in front of the powder-charge, (*Fig. 8.*), brought by its gravid weight to lie upon the under part or lower side of the barrel, with the vacuum or windage, above and between it and the upper side of the barrel. Upon the inflammation of the charge, one part only of the gases first evolved, and a further part while the ball was set in motion made their way out, imparting not a direct forward stroke to the ball ; but a side stroke against the lower side of the barrel, which in Artillery, particularly in long used cannon, presents its practical evidence in the so called ball-beds or hollows, found at a point in the chase of the gun a little beyond the place where the shot generally lies, and which can arise from nothing else but the first action of the stroke above alluded to. This was as heretofore, again the case with our siege guns during the siege of Sebastopol, so little attention to the correction of a defective degree of windage pointed out by Artillerists at the end of the last century, had been given to this important feature.

By this means the ball received an impulsion *not* through the centre of gravity and in the direction of the axis of the barrel as it ought, in order to be projected from the barrel in that direction, but in the direction above alluded to. Thus, a bounding of the ball against the side ensued, which in obedience to the law of elasticity, was followed by a rebounding to the opposite side, this was repeated several times in the barrel, so that the ball was projected from the barrel neither in the direction of the axis of the barrel nor parallel, but in a direction slanting from the axis of the barrel. The greater the windage in a gun-barrel, the greater is this deviation ; and the direction of the deviation depends on the number of points which it strikes below or above, or right or left sideways in its reboundings on its passage out of the barrel : and lastly on its exit in the *opposite direction* to the last rebound.

Experience has shown that in general long barrels shoot more correctly than shorter ones. This admits in part of explanation from the circumstance that the points of the superficies (at least of one of them) over which the aim is taken at the object, stand farther apart from the eye upon a long barrel ; by which means a more correct aim is possible. But this may also be explained in another way, which refers to the before-mentioned bounding and rebounding of the ball in the barrel.

In a long barrel for instance the powder-gas which last evolves from the combustion of the remaining part of the charge, *follows* up and reaches the ball, driving it with the last impulse in the direction of the axis of the barrel; by this means the bound and rebound of the ball becomes gradually shorter, and the deviation of the direction of the path of the ball from the direction or line of the axis of the barrel, becomes less than under similar circumstances, in a shorter barrel.

These are the general and most important Principles which serve as first and leading points of remark, for the acquisition of a knowledge of Fire-arms; whereto, nevertheless, a variety of other influencing circumstances belong to which we do not here advert, partly because we shall have occasion to touch upon some of them when speaking of the several kinds of Fire-arms individually, and partly because Science with all its progress has not yet thoroughly investigated and established their knowledge; upon which the most opposite opinions are frequently entertained, the investigation of which requires a greater Sphere of Physical and Chemical Analysis than was contemplated in this Manual.

THE TRAJECTORY, OR LINE OF TRANSLATION, DESCRIBED BY PROJECTILES.

THE End and Purpose of Fire-arms, to strike certain distant objects with the projectiles thrown from them, can only be properly attained by a clear comprehension of the general Principles applicable to all Fire-arms, deduced from the relative positions and respective bearings of three Lines, called—the Line of Fire, the Line of Aim or Sight, and the Trajectory.

The *Line of Fire*—or axis of the barrel indefinitely prolonged. This is the natural direction of the Centre of the ball, as the direction which that centre would not cease to follow, if the Projectile was subservient only to the Projective Force of the Gunpowder.

The *Line of Sight or of Aim*—a straight line passing from the eye through the middle of the foot of the breech or back-sight, and over the top of the front sight, on the muzzle of the arm. The Line of Aim thus defined, is called the *Artificial Line of Aim*, to distinguish it from the *Natural Line of Aim* which passes through the highest parts of the breech and of the mouth of the barrel. To aim, is to direct the Line of Sight of a Fire-arm upon a given Point. For the aim to be good, it is necessary that the two points which determine the Line of Sight and the Point aimed at should be exactly on the same straight line.

The *Trajectory*—or the *Curved Line* described in the air by the Centre of the Projectile.

It must be observed that, as long as the projectile is in the bore of the barrel, the Trajectory is nearly one and the same with the Line of Fire; but as soon as the ball has issued from the mouth of the piece, the Trajectory separates from the Line of Fire, and continues to do so, more and more, the farther the ball ranges from the piece.

The Line of Fire is constantly above the Trajectory to which it is tangent towards the mouth of the piece.

The projectile in its passage through the air is further subservient to the action of three Forces, viz. :—

1. To the *Force of Projection*, developed on the combustion of the Gunpowder : but, if the projectile was alone subservient to this Pro-

jective Force it would move indefinitely in a straight line, and the Trajectory would be combined or as one with the Line of Fire.

2. To the *Resistance of the Air*. The Air like every kind of fluid or solid body is composed of material particles, and the projectile in its flight is compelled to separate and force its way through these particles: hence a Friction and Contact arise, and consequently a Re-action of the opposing particles; from which derives a considerable loss of Velocity to the projectile.

3. To the *Weight or Absolute Gravity*. This Force which acts constantly and immediately on all the particles of Matter, exhibits its action in directions perpendicular to the surface of the earth; it is, moreover, a constantly *accelerative* force, the law of which is well known. Left to the action of its weight by a supposed sudden cessation of the Projective force, the ball would immediately fall vertically to the earth, with a continually increasing velocity; for Weight, or Absolute Gravity, acts throughout every instant of motion, and constantly adds a new action to all the actions pre-produced. Hence it will be conceived—the longer the time a projectile is under the influence of the action of Weight, the greater is the velocity acquired at the *last moment* of its fall.

In Theory, the Trajectory should be wholly contained in the plane of Fire, which is a vertical plane within which it should be comprised when the Fire-arm is well constituted to that effect. But in Practice, the projectile is found subject to numerous causes of deviation which so much influence its Trajectory, that it is never rigorously contained within that plane, or at least it is comprised within it during a very short period only of its flight.

The Lines of Fire, of Sight, and of the Trajectory, form thus respectively certain Angles or Points of intersection in regard to each other. These angles or points of intersection are:—

The *Angle of Fire*, or the Angle made by the Line of Fire with the horizon at the moment of firing.

The *Angle of Aim, or of Sight*: the Angle made by the Line of Aim with the Line of Fire, and which is more or less an open angle.

When the object fired at is on the same level or horizontal line with the muzzle of the piece in the plane of Fire, the angle of sight is equal to the angle of fire; and the Trajectory and the Line of Sight may be considered as invariably blended when the latter line remains in the plane of Fire.

Fig. 1. (pl. IV.) will best illustrate the different Lines and Angles adverted to. If we suppose GB to represent the barrel of a gun or

rifle, the Line BF will be the *Line of Fire*, LS the *Line of Sight*, BTOY the *Trajectory*. The Angle LTB formed by the Line of Fire and the Line of Sight will be the *Angle of Sight*, and the Angle TBH formed by the Line of Fire and the Horizontal Line will be the *Angle of Fire*.

If we consider the position of the Trajectory in relation to the Line of Sight, it will be perceived that on issuing from the mouth of the barrel, the Trajectory is below the Line of Sight, and that it then cuts the Line of Sight at a certain Point *a*, generally very near to the mouth of the barrel: departing from the Point *a*, the Trajectory passes above the Line of Sight, and rises for some time in respect to that line, when it descends and cuts it at a second point V.

POINT BLANK AND POINT BLANK RANGE.

This Second Point of Intersection of the Line of Sight and of the Trajectory is called the *Point Blank*. The distance GV from the mouth of the barrel to the point blank is called the *Point Blank Range*; departing from the Point V, the Trajectory passes below the Line of Sight; it preserves this position indefinitely, increasing continually its distance from the Line of Sight.

On inspecting this Diagram it will be seen: that if in order to hit a Point K situate between the mouth of the barrel and the Point blank, the Point is aimed at *direct*; the ball will pass above it by a certain altitude E: the same would occur for any other point comprised between the points *a* and V: and if to hit a point P situate beyond the Point blank, it was directly aimed at, the ball would pass below by a certain quantity RD; the same would also occur for any other point situate beyond the Point blank.

From this will therefore result (abstraction being made of the Point *a*), that to hit a point situate on this side of the Point blank, the aim must be taken *below* that point equal in quantity to that by which the Trajectory passes *above* it; that to hit a point situate at the Point blank, the aim must be taken *directly at it*; and that to hit a point situated beyond the Point blank, the aim must be taken *above* that Point, by a quantity equal to that by which the Trajectory *descends* below the Line of Sight at the distance of that Point.

It is here proper to remark, that as the Service charge of powder and ball is constantly, or should be the same for the same description of Fire-arm, and the point blank range not varying very sensibly with slight differences of inclination of the Angle of Sight upon

the horizon, the point blank range for one and the same kind of Fire-arm may be considered constant.

The Point blank range of a Fire-arm depends on the greatness of the Angle of Sight : the more that Angle increases within certain limits, the more the Point blank range will increase also ; this range will on the contrary decrease if the Angle of Sight is diminished.

With the aid of a very simple Diagram it may be seen that, in varying the thickness of the barrel at the breech, the Angle of Sight will be increased or diminished. If, instead of varying the thickness of the barrel at the breech, a pillar or stem be placed on that part of the barrel which will permit the point L, which belongs to the Point of Sight, to be raised or lowered at will, the Angle of Sight will be increased or diminished by that means ; this stem or pillar is called the Breech or back-elevating Sight.

DEFINITION AND USE OF BREECH OR BACK-SIGHTS.

The name of Breech or Back-Sights is given to graduated moveable stems which, fixed usually upon the breech of Fire-arms, permit the Angle of Sight to be varied, and thereby the Point blank range.

The *Natural Angle* of Sight, or that formed by the natural line of Sight and the Line of Fire does not alone depend on the difference of the barrel at the breech and at the muzzle. It depends also on the length of the barrel ; for if the length of the barrel be decreased, and the same thickness at the breech and muzzle be retained, it is easy to ascertain by the aid of a Diagram, that the Angle of Sight will have been increased : so that of two barrels of the same thickness at the breech and muzzle, the longest barrel will have the smallest Angle of Sight. It may thus be readily conceived that a Fire-arm shorter than another, with a less charge of powder, and an absolute range, less—may, nevertheless, have a more distant Point blank range.

THE MANUFACTURE OF FIRE-ARMS.

It is with guns as with many other things composed of parts, which are not all the production of the skilled labour of one and the same workman. The workman who produces each, should, and may be, a first-rate hand in that particular branch of the Gun-making Art : but it does not follow as a consequence, and in extremely exceptional cases only is it found, that after the tubes have come from the tube-makers, the gun for the rest is or can be put out of hand by one and the same individual.

Yet in gun-making the credit of the whole product as a piece of workmanship is assumed by the stocker and finisher. A credit which except as regards the external appearance of the gun, belongs to him as little as the real merits or demerits of a book, belong to the bookbinder. But in the fire-arm, the credit due to the barrel-maker, lock-maker &c., is arrogated and assumed by him who has least to do with the normal material merits of the arm itself—and who, more frequently than otherwise as we have seen, would impress upon the uninitiated, not only the idea of the centralization in himself of the whole creative credit and capacity to produce the arm he puts into your hand—but the whole knowledge, past, present, and future of the craft of gun-making, and an exclusive ken of all the mysteries of the Science of Ballistics, emanating, as he would have you infer, from his personal skill, which after all is but the mechanical superficialities of the work, and has but little to do with the fundamental merits of the gun.

To give the details necessary for the acquisition of the Art of Gun-making is not the object of this work ; and to enter into a detail of the Process of Barrel forging, welding, and Gun-making, or to advert even at any length to the different kinds of Iron and combinations of Steel and Iron applied until very recently to this purpose by the manufacturers of this country, and designated by them under their multifarious technical denominations of Stub-iron, Wire-twist, Damascus, &c., through all the inferior sorts from the so-called

charcoal Iron Skelp* and Threepenny, to that of the all expressive Sham-dam, would both greatly exceed the limits and the pretension of these pages.

We may, nevertheless, here observe, that in the fabrication of Fire-arms, up to a very recent period ; the commercial ingenuity of English Barrel manufacturers had for many years succeeded in contriving a much greater number of grades of quality in the material, than redounded either to the repute of the Craft or the Country. Had they, on the contrary, like those of Suhl in Germany, St. Etienne in France, and Toledo in Spain, restricted their skill and industry to the production of fewer sorts only, of good, and less economically contrived stuffs—or that the Government of this Country had earlier shown itself more paternally regardful of the interests of home-society and those of our export trade, by enforcing obligatory Proof Regulations of as stringent a character as those which had long existed at St. Etienne : that wholesome check would have been placed upon the spurious products of a discreditably understood Trade-competition, that was so long required in this country—even to the very bread of the people, and the commonest necessaries of life.

But “made to sell” was, a few years since only, too much the motto in the Fire-arm Branch of British Industry ; and the Principle, as it never fails to do in the long run, sold more than short-sighted gain-greed, and self-defeating cunning calculated upon—for it sold therewith that character for commercial Integrity which once lost—is so difficult to re-establish.

To the Gun-makers of London must be awarded the credit for having made the first efforts to correct this neglect of past administrations. To protect and place themselves in a position to ensure the solidity of the barrels of the arms of their make and to bear their names ; they wisely besought from the Legislature the establishment of a London Proofing House, and this progressively wrought the desired effect, and established for the productions of so many well known London Makers the world-wide repute which they acquired.

We need scarcely say, that the vast improvements in machinery which by the aid of the giant power of steam, have latterly been applied to every kind of manufactory, are now about to operate also a vast change in the process of barrel forging, welding, and gun-making. First resorted to in the United States on a large scale, in the government and private gun factories, these important changes

* Skelp, the name given to the piece of iron about 3 feet long and 4 inches wide, thicker and broader at one end than the other, of which gun-barrels are forged.

are in progress of execution at the present moment in this Country, and we may soon expect to see in the Government Small Arms Manufactory at Enfield, as well as in all the larger private establishments of the kind, much of the hitherto expensive hand labour of man, performed with more reliable precision and rapidity, by the unskilled but amenable labour of the will-less machine.

By this means, instead of forging with the hammer of the barrel-smith, military barrels are now rolled at once with an uniform pressure, and then welded in one heat.* Though it has been urged by many that the metal of gun-barrels will be less purged of its impurities by the rolling machine than by the hammer of the forger and welder; yet, on the other hand, if a more conscientious selection of the metal be made, and a judicious amalgum of iron and steel in the case of shot-barrels and sporting rifles; the too frequent carelessness of the barrel welder, to which as much as to the fault of the material used, may have been justly attributed the bursting of many a gun-barrel welded in the ordinary way (i.e. in the length), will be put beyond such frequent recurrence; and as good and serviceable arms will be produced by this more simple process as in those days when the barrel-makers of this country put more conscience and pride of craft in their productions.

As, nevertheless, some outline of the Process of Gun-making may be acceptable to the uninitiated, we will give the ordinary one in a few words.

Gun-barrels are manufactured from quadrilateral bars of iron, the four sides of which are unequal and unparallel, rolled in their whole length in the form of a tube upon a cylinder called a mandril. The long sides of these bars are sloped off to facilitate welding, which is first effected from the breech part to half the length of the barrel, and afterwards from that point to the muzzle; the barrel being seized by the breech. Were a barrel manufactured in the old way, from a solid piece of *iron*, bored centrally, it would have no solidity and would burst at the first discharges. But this is not the case with the cast-steel barrels, which are now bored out of the solid in the United States. The gun-barrel is then enlarged interiorly by from 4 to 5, or from 10 to 12, and even to 22 borers† passed into it successively.

* This method of barrel-rolling, though dating from 1818, has obtained but of late years at the Government Manufactory at Enfield, and within the last three years a manufactory of barrels by this process has been established at Liege in Belgium.

† The borer, or boring-rod, is an iron stem furnished with a square steel head, called the bit or cutter, of various lengths, which on being turned in the barrel cuts the metal and removes the inequalities and roughness left in the forging, obliterating also the small cavities which present themselves called *Forge Spots*. When passed into the

This operation is performed by means of a machine called the Boring bench, which, in some establishments, admits of boring a dozen or more barrels at a time.

The barrels are then "struck up;" for this operation the interior of each is carefully examined to ascertain that no inequalities of boring present themselves, and their exterior surface is beat with a light hammer, to fill out any hollow places which may have been detected.

The finishing or fine boring bit* is then lastly passed into the bore; this instrument, which takes off little of the metal, renders the interior perfectly round and smooth. This operation is repeated three times, when the bore is said to be "struck up" and well-calibred.

The barrel is then turned exteriorly and brought to the prescribed dimensions: the breech is then screw-tapped, the breech plug adjusted, the hole drilled for the reception of the lump; and, lastly, the loops and front sight are brazed on. The barrel is then re-examined throughout, and marked, ready to be submitted to proof in the proofing house.

Gun-barrels are proofed upon a strong wooden bench or bed, to which they are fixed by means of iron-bands, having semicircular spaces or notches to receive the barrels and keep them in their places; the part of the bench on which the breeches of the barrels rest has a sheet-iron flooring.

After being proofed, the barrels are washed out and examined; those which are found without defect are marked with the proof mark. Their exterior and interior surface are then struck up again and smoothed down with oil and the file. The finished barrels are then cleaned of all oil and grease, and placed for several days in a damp room, in order that the humidity of the place may show itself upon the finest flaws in the metal, which become evident from a slight trace of rust.

Until of late it had been believed that notwithstanding the great elasticity and hardness of steel, its little cohesiveness and tenacity

barrel, the cutter is well oiled and kept lubricated. As the action of the cutter heats the barrel considerably, the latter is carefully covered with wet rags, and frequently remoistened, which also prevents the bit or cutter from losing its temper. The French Rified Musket is bored by 22 different borers.

* Called by the French *La meche*. The square polished steel head of which is sometimes from ten inches to a foot long, furnished with numerous exceedingly sharp angles which cut the metal with great delicacy. The steel head diminishes progressively towards the end, in order to admit of the adjustment upon one of the faces of the borer of a small blade or splint of wood called the *Etelle* which enables two angles only of the boring bit to work.

would not admit of its employ in the manufacture of the barrels of Fire-arms, in a pure state and without iron in amalgum. This has nevertheless, proved to be an erroneous opinion. Cast steel shot-barrels are now fast superseding the Stub-twist and Damascus kinds, in public favour in this Country, and are now also made at St. Etienne in France, the strength and resistance of which leave nothing to be desired. Upon their first manufacture in France some four years since, they were tested experimentally in Paris by a Commission of Artillery Officers, and subsequently at St. Etienne, at a Public Meeting of Manufacturers there, presided over by the Proof Master of the Syndicate of that town—on which occasion they were found to support six successive and constantly increasing charges of powder and shot, from 30 grammes* of fine powder and 200 grammes of shot No. 4, to 80 grammes of powder and 360 of shot. One of these barrels was $26\frac{3}{4}$ in. long, $\frac{11}{16}$ ths of an inch bore, and weighed 2lbs. 15 oz.; the other $30\frac{3}{4}$ in. in length, the same bore as the former, and weighed 3lbs 9 oz. The first expanded on the proof 1 millim 2-10ths (a trifle more than $\frac{1}{32}$ of an inch), the other only 2-10ths of a millimetre. Neither one nor the other, after the severe trials which they were submitted to, presented either crevice, rent, or shake, although the shot was disposed in such a manner that the whole charge of powder could burn in the barrel.

Although in the instance of these single barrels there was both more weight and thickness than would be either required, or of easy handling when adapted to a double-gun; yet it proved incontrovertibly the advantageous use that could be derived from cast steel in the manufacture of gun-barrels.

But already, ten years before, viz., in 1843, had the adaptation of cast steel to this effect been placed beyond a doubt in France, by the celebrated competition of the Paris gunmakers MM. Bernard and Gastine Renette, with fourteen gun-makers of St. Etienne under the direction of M. Jalabert Lamotte; who experimented upon a cast steel barrel, which resisted the enormous charge of 8 balls and $2\frac{1}{2}$ ounces of powder in the presence of Baron Doguereau, Colonel Général, and General Tugnot de Lanoye, Commandant of Artillery. We must not, therefore, imagine that our recently much mooted essays with cast steel applied to fire-arms and artillery are the first attempts of the kind.

The Laminated Steel Gun-barrels, which are now so much in vogue for shot-barrels, are so called from the metal of which they

* One gramme 77 centig. equal 1 drachm English.

are made being first rolled into laminæ or thin sheets between steel rollers, and then welded together. Laminated steel gun-barrels were we believe first made in the United States, and a few years since, only, from laminable sheet or plate-silvered steel, cut or broken into lengths and put into an iron ring, one length upon the other, until the ring is full, when the whole is called a faggot. In placing the lengths of laminated metal into the ring, care is had to cross the grain of the steel, which is essential to give the whole a greater uniformity of attractive cohesion, and to bring every atom or particle of the steel into an equilibrium of resistance. When the faggot is thus completed, it is put into a furnace and heated to a welding heat, then put under the tilt-hammer worked by steam, and afterwards under a pair of rollers and rolled into plates. This process is repeated several times to bring the metal into a dense yet ductile state, and thus give it the beautiful figured or waved appearance which these barrels present when finished. After being faggotted two or three times, it is drawn into rods 15 or 20 feet long and about 1 inch square. These rods are sent to the barrel-maker or welder, who coils or twists them round a mandril, in the same manner as a wire spring is twisted: this brings the grains or pores of the steel parallel or across the barrel and forms the twist where the edges of the rods are welded together.

Gun-barrels of this kind will bear 82,000lbs. hydraulic pressure to the square inch one-eighth of an inch thick. As gunpowder is computed to be 1000 over and above the atmospheric pressure—the latter being about 15lbs. to the square inch—and as gunpowder exerts a pressure of 15,500lbs. on the inch, and expands 5000 feet per second, these barrels oppose 82,000lbs. resisting force to the 15,000lbs. expansive force of powder, friction of the charge, and condensed air in the barrel, caused by the momentum of the charge. Common twist-barrels bear about 34,000lbs. hydraulic pressure on the inch, one-eighth of an inch thick, for which reason guns of those barrels being made of common iron and sold at a low price, frequently burst.

Silver-steel plate is made by breaking rods of cast or shear steel, which are put into a large crucible or pot, and melted down with 1 per cent. of silver put into it in a fused state; this amount of silver amalgamates with steel and forms a chemical union.

The several limbs of the Lock, both iron and steel, are forged with the hammer, experience having shown that the casting of these parts which has at different times been proposed, and in some instances adopted, produced but very inferior results. The recent intro-

duction of stamped cocks, triggers, and other limbs of the lock, of malleable iron, appears likely to find favour with gun-makers, as considerable economy in the manual-labour production of those pieces will be effected, but a trial of some years use will be requisite to confirm the opinion of their equal durability with forged limbs of the best materials, which we greatly doubt.* The forged pieces are first polished by the grindstone and file, then put together, fitted, tempered, and fine polished. The steel parts, such as the two springs of the lock, the tumbler, the sear, and all the screws or pins are tempered. The springs are re-tempered with oil by placing them on burning coals until the oil upon them has been wholly consumed, and by plunging them a second time into water. The other limbs are tempered in a much less degree.

The Lock pieces, both iron and steel, are tested by breaking some of them, by pinching the springs between the jaws of a vice, and leaving them there for some time to ascertain their elasticity.

The Trigger-guard and other furniture parts of the Arm which are of iron, are not tempered, but the trigger is made of steel tempered and retempered with oil. The springs of these pieces are of steel tempered in the same manner as those of the Lock.

The Stocks are required to have the combined qualities of strength and lightness, and should be made of a good binding wood, easy to cut, on account of the great number of pieces which are to be fitted and let into them. The fibres of the wood should be close and of great tenuity so as to resist separation, because being frequently intersected, they have no other support than their own cohesiveness. The French walnut wood, which is much used for gun-stocks, admits of being easily cut and its fibres have great cohesion; it is little liable to split, and when carefully rubbed with oil, will keep a very long time unattacked by the worm. In Germany, white woods are generally employed for gun-stocks, which are afterwards stained. The best woods are grey, greyish, or brown. They should have a three years seasoning in store. If dried by steam they require but from forty to fifty days preparation.

The dryness and fitness of the wood is ascertained by the friable character of the shavings, and the dryness of the sawdust; but above all, when a gun has been fresh stocked, and the metal parts well cleansed from grease, by exhibiting the absence of all rust, which

* A Mr. Renton, of New York, has patented a new process for the reduction of the oxide of iron and the production of the malleable metal, founded on the Theory of deoxidising the ore in the absence of atmospheric air, which engenders much waste in the usual process of manufacture. It is said, that iron prepared by this process has peculiar advantages for the manufacture of steel.

otherwise in a few weeks evinces itself where the edge of the metal comes in contact with the wood.

In the Gun-making Art, considered in its real light, as the judicious and skilful assemblage of the several parts of a Fire-arm ; it is admitted, and with candour, by the most eminent and intelligent of the Craft among Foreigners ; that the gun-makers of London have established an unquestionably high repute for the excellence and mechanical finish of their productions : an especial attention having for some years past been directed by them to the fundamental quality of the work, the proportions of the arm, the solidity, welding, soldering, and colouring of the barrels. But the price demanded and paid for their productions has been such as well to warrant the presence of those qualifications, and to encourage that attention.

It must not, however, be believed, as we have frequently had occasion to find it, and heard it urged by Gun-makers and workmen in this country, that their brethren of the Continent are wholly their inferiors ; for the productions we have seen, and which daily appear in France, Belgium, Germany, and Spain, attest that the rivalry in excellence extends to something more than that artistic elegance of finish and ornament which we do concede to them, and that they are fast becoming formidable competitors in regard to the fundamental material of their arms, and the mechanical excellence of the work itself. In this as in the other products of Art, no more self-injurious error can be committed than to set down in a stolid self-sufficiency of having established a certain repute, and there abide, with the notion that workmen of no other clime or country can approach it.

The persistent indulgence of such a belief never yet failed to be disagreeably undeceived, and is one of the weaknesses engendered by that overweening nationality, which in its blind self-love can scarcely admit of the supposition that the World's Creator fashioned His other Peoples with the human norm of intelligence and capacity equal to our own—a doubt too much inoculated upon the ignorant mind by the too frequently misapplied zeal of writers, who, instead of teaching aright, mislead the mass by pandering to the most worthless side of the national conceit, and who thus create the most serious obstacles to the national improvement—such are neither the true friends of the British Artizan, nor of the Country.

In England as in France, and indeed, as in most of the Continental States, the Capitals in each, have respectively acquired the greatest repute for the excellence and elegance of finish of their productions ; and of these London and Paris especially. For the quality

of the barrels on the other hand the provincial Towns in each, Birmingham and St. Etienne, have established the most repute. But, of late years, Liege in Belgium has made rapid strides in the higher branches of gun-making both as regards sporting and military arms.

To designate by name those who in this Country stand in most repute for their productions is scarcely required, for their names are world-known. The most celebrated of the craft in Paris, Brussels, and Liege, are now also as familiar to most amateurs. In Germany, Schnevoigt at Lhar in Baden, Pierre Cot of Vienna, and Lebeda of Prague, have the most repute; and in Spain, the fame of the chef-dœuvres which once issued from the workshops of Grenada, Cordova, and Toledo, is ably maintained by Zuoloaga of Eybar and Isasi of Toledo.

We cannot close these necessarily restricted observations on the manufacture of fire-arms, without adverting to the fact, that with all the credit we have heard assumed, as our own, for the application of much of the new machinery now in use, in aid and in economy of handicraft labour—yet in that of the manufacture of military small fire-arms, as with many others of late years, we have been taught our best lessons by our juniors in mechanical repute, the men of the United States. The greater expense of skilled handicraft labour in the Union, induced there the resort to machinery as a more stringent necessity than with the manufacturers of Birmingham; and it there attained no less of a consequence, to a more extensive development.

It is, nevertheless, an error to pretend that the machinists of Manchester took the lead in this respect of the manufacturers of Birmingham, who imitated the former from the mere apprehension of their competition in the production of fire-arms—for in Birmingham, machinery as applied to certain of the more simple parts of the work, had been in use for many years.

Beyond this, however, whenever an attempt was made to introduce the use of the various revolving and shaping cutters, which had been devised and brought into use in the gun-making establishments of the Union, it met with great opposition from the contumelious prejudice of the English workman against all and every thing that rivalled his own skill, to say nothing of his dread of all innovation likely to supersede and materially depreciate the importance of that labour skill.

Partly from this cause, and partly from the uncertainty of demand upon their industry by the Government, which had some time

time contemplated the extension of the Enfield Establishment, the Birmingham manufacturers were unwilling to risk the outlay of the capital required for a more extensive application of machinery; and when the sudden and exceptional circumstances of the Russian war called for the utmost exertion on the part of the Government to make up for lost time and hesitation in moving with the improvements which had been made in military small arms; the home means of production were not competent to the task, and large contracts for arms were of a necessity offered to the private establishments of Liege, St, Etienne, and Windsor, and Hartford in the United States.

The most important of the machines derived to us from American ingenuity, are those constituting the "set" of 25 different machines through which the gun-stock passes in its manufacture, and which are capable of turning out 250 gun-stocks per day. These with numerous "milling machines" for the cutting of the gun-locks and execution of other of the metal parts of the gun—with others too numerous to mention, have been purchased and set up at the Enfield-lock Establishment, where, under the superintendence of engineers from the Harpur Ferry Armoury, it is anticipated that 500 muskets daily may be eventually put out of hand.

DOUBLE BARREL GUNS.

THE Invention of double barrel guns, formed by two parallel barrels with locks to each, one on either side, is by no means so modern an appearance as is generally believed. We have seen it asserted that the manufacture of Sporting Arms followed step by step the progress made in Military Fire-Arms up to 1750. This is by no means the case. A long and zealously pursued study of the subject, favoured by opportunities to examine many of the first Public and Private Collections of Arms in Europe, has led us in numerous instances to the conviction that in the earlier days of the Art of Gun-making, as in the early part of the present century, a greater exercise of mechanical invention and ingenuity was applied to the arms of the Sportsman than to those of the Soldier; and that the latter, on the contrary, may be said to have followed in the wake of the former.

Though previously to 1750, a double gun with two locks, and parallel laid barrels secured together by screws, loops, and bolts, admitting of detachment at will, and with back and front sights to each, was a rare specimen of the gun-maker's craft; yet we have frequently met them in collections, and seen them cited in early accounts.

Of these the earliest of the kind were productions even of the days of the Wheel-lock Arquebus. One inlaid with ebony of a very antique taste, apparently of the date 1600, supposed to have belonged to Henry IV. of France, together with another scarcely less ancient in appearance, though with locks constructed like the flint-lock of the last century; were in the Collection of the late Kings of France.

The chief difference in those early double barrel arms from those which were introduced in the last century and now in use, is that their barrels were *not* brazed nor soldered together. They were simply adjusted side beside, and held together by the tails of their breeches, and by three or four bolts running the length of the shaft, passing through eyelets placed opposite to each other under each barrel. Each barrel had its separate sights, and the space between

the barrels not being filled up with a flat band or rib of metal, formed a triangular hollow.

As a more perfected effort of Art, in all probability, the kind of double barrel gun with a detached flat band or rib of metal, separating the barrels from each other at will, and held together by bolts and screws, followed the above; and these were eventually succeeded by the present brazed or soldered double barrel guns.

The former of the last cited permanent methods of connecting the barrels, derives from St. Etienne in France; where that kind of gun for Sporting purposes more especially, had been manufactured at the commencement of the last century and for some years before 1738; the period they were first made in Paris, by the celebrated John le Clerc, deceased in 1739, uncle to Nicolas le Clerc, gun-maker to Louis XVI.

But antecedent to, and more ancient perhaps than all these, were the TURNING or REVOLVING Guns, formed of two detached barrels, one *above* and the other *beneath*. The mechanism of this ancient double Fire-arm, consisted in a revolving break effected at the breech, by means of which, when the first barrel was fired, on pressing with one hand on the bridge of the trigger-guard, with a turn of the other hand the remaining loaded barrel was brought upward. The lock of this gun had also a break, and all the interior action of the mechanism took place in the upper part, which was immovable, the lower part of the lock carrying only the hammer and pan. This lower part was double, while the upper part was simple; that is to say, there was but one cock, but a hammer and two pans both above and below; so that in bringing the lower barrel upward after firing the first shot, and having re-cocked the gun, another hammer and pan were likewise brought up and presented themselves to the cock, enabling the next shot to be fired. As may readily be imagined it had one great disadvantage, for a sporting arm; it was difficult to fire a second time at the same game or object.

On the same plan, also, Guns with four barrels were constructed; for it is easy to conceive that the mechanism of the revolving break could be equally applied to *two* double barrels as to two simple ones: two cocks, four hammers, and four pans being alone required. These four barrel guns were naturally very heavy, and to be made tolerably solid, they could not weigh much under 8 or 9 lbs. at least, 5 lbs. of which went to the barrels, supposing them to be 30 inch barrels, and of a calibre of from 28 to 30 to the pound.

Other four barrel guns were subsequently imagined without the Revolving principle. These consisted of four barrels brazed toge-

ther, two above and two below ; the latter 3 inches shorter, with four flat-bands or ribs to fill up the exterior vacancies formed by their union. The hollow in the centre served to hold the ram-rods.

These guns had four locks and four triggers ; consequently one trigger, and the bridge of the trigger guard were longer than usual with double barrel guns. As may be readily conceived, the two locks on each side, could not be on the same line ; since two of the barrels were lower than the others. They were placed therefore one at the extremity of the other, so that although that of the long barrel encroached a little on that of the short one in order that the triggers might be less far apart, and that the upper lock should not impede the action of the lower one ; the springs of the hammer were placed inside instead of out as in the ordinary flint-lock.

Although on the one hand the Quadruple Guns of this later construction had the advantage over the Turning or Revolving barrel Guns, of a more prompt fire, they had one inconvenience which the latter had not, viz., a great defect in the precision of fire and range of the *lower* barrels ; which fired by the same line of sight or aim as the upper ones, shot of a necessity much lower. Added to this, they were still heavier ; some 30 inch barrel guns of this kind weighing 10½ lbs. Few Sportsmen, therefore, even at a time when the habits of modern civilization had not so generally unstrung the manly fibre as in the present day, could make up their mind to carry a-field, so cumbrous an arm ; especially, as so few cases occur in which a Sportsman requires (in Europe at least) a four barrel gun. This production of the Art, may therefore rather be considered as a curiosity for the cabinet of the collector than as a serviceable fire-arm, even though resuscitated with the more convenient modern appliances of Percussion ignition, and structure.

THE SPORTING OR SHOT GUN,

ITS CHOICE, ETC.

We once heard it argued with some warmth by a thick and thin antagonist, not only of our doubtless somewhat defective Game Laws, but of the Sports of the Field collectively; that "Man was no more born a sporting animal than a weaving animal."

That we did our best to convince him that man was inherently both, and indeed anything that his necessities, whether in a state of nature, or in a so-called civilised condition compelled him to be, may be readily imagined; though at the same time, we did not omit to make our disputant as sentient as possible of the obliteration in his own person of much of those natural impulses of his species, which the peculiar and fortuitous circumstances of his own artificial existence had imposed and engrafted on him, which, while we excused—we did not envy.

Despite the casual existence of opinions such as the above, there are few of our countrymen who will not admit that even if the circumstances of their life have not been favourable to a frequent indulgence in the sports of field, fen, and moor, they have not been wholly exempt from the inclination to enjoy them whenever the opportunity presented itself. The acquisition of a gun is, in fact, the realisation of one of the most sanguine desires of English youth; and abstraction made of the scions of our aristocracy and landed gentry, there are few even in the middle class of life in our toil-teeming cities, who at some early period of their lives do not make a decent double-gun part and parcel of their personal effects, and take pleasure in its use.

The first selection made by the aspirant Sportsman, unless under the guidance of an experienced shot, and practical judge of the qualities of a gun, is not always distinguished by that discretion which excludes an after regret in the choice; and too frequently seduced by that attractiveness of form and embellishment under which the Gun-maker's art so well knows how to induce in the mind of a novice, an oblivion of the existence of more requisite qualities, the young amateur makes his debut by giving a preference to the beauties which

he does see, over the, to him, less evident but more important qualities, of which unable to judge, confiding in the assurances of the vendor, he yields himself to the hope that he will find them in the gun of his fancy.

The maturity of judgment requisite in the selection of a gun may therefore generally be said to be only first acquired upon the purchase of a second. When no longer dazzled with the pretty devices of the ornamentation, he will confine himself rather to those requisites which have more immediate reference to his own facility of handling, his personal safety, and the ease with which it will enable him to bring the game under his line of fire.

To use a homely comparison it may be said of a gun, as of a ready made garment, it is not made to fit every man ; and for a novice purchasing the former article for the first time, there are certain prescriptive things necessary that he should know, as guide for his choice, which will not be made so sentimentally obvious to him at the time, as would the tight or loose fit of a coat.

On such a novice and a stranger, presenting himself to purchase a gun, the amount of his intelligence on the subject is of course quickly detected by the Gun-factor, Gun-maker, or Foreman of the establishment. On these persons, according to their individual idiosyncracies of character, depends much of his luck in the quality of the first arm of which he becomes possessed. Though this may be truly said of everything that exchanges hands between buyer and seller ; yet is it especially so with reference to the purchase of the products of an Art, which purely mechanical in its norm, in all time and every where, partly from the assumptiveness of that exclusive guild-like, craft-mystery, which is still hereditary in its members and among its artisans, gives an ungraciousness even to their intended urbanities, that often awakes suspicion or disgust in a sensitive and otherwise well-informed mind. Inasmuch, nevertheless, as there are "good greyhounds of every colour"—should the novice in question drop in upon one of those rarer types of the craft, which happily are sometimes to be met with both at home and abroad ; possessing the unison of that aristocracy of the mind and feeling, which is the adornment of every occupation, with a *con amore* sentiment for his ingenious art and a passion for field-sports—then, indeed, has the aspirant to the joys of the sportsman some security for an advantageous outlay of his money.

It may be thought, perhaps, supererogatory to say so ; but all men are not built alike—to the tall long-necked, thin-faced man, the same cut of gun stock will not adapt itself, that will be in perfect accord

with the anatomy of the short, stout, thick-necked, and full-faced individual.

To the former, the gun with a long somewhat curved stock thick in wood at the cheek, so as to fill up his want of fulness of visage and permit his eye its proper command of sight along the middle of the barrels is best adapted. While to the latter individual the short straight stocked gun, thinner in wood at the neck to permit of easy access to the line of sight will be much more eligible. In the latter gun, the straightness of stock will in part afford a remedy to the easily contracted bad habit of most persons, of firing too low and behind the bird.

Though it is generally attributed to the straight stock that it makes the recoil of the gun more sensibly felt; if that recoil be not greater than may be conveniently borne, the objection is of little moment, and the straight stocked gun will be better adapted to the majority, both on the moors, curraghs, and open country, and no less for Pigeon-shooting.

The following conditions and proportions may be cited as a succinct exposition of the qualities and structure of the stock of a double gun.

The Stock of the gun should be of Walnut, free from all inserted pieces, the grain of the wood straight, especially at the neck, the weak part of the gun, which of a necessity must be thinner of wood in order that the finger should have free access to, and play upon the triggers. The part of the stock where the cheek comes to lie should be full, as it gives more support to the line of fire; rather long than short, and more straight than curved, for the reason previously assigned. The heel of the stock should be in a straight line with the middle rib of the barrel. The length of the stock from the trigger to the cheek is generally limited to about $15\frac{1}{2}$ inches for a long armed individual, $14\frac{1}{2}$ inches for one of ordinary length of arm, and for short arms at from $13\frac{1}{2}$ to $13\frac{3}{4}$ inches. With a gun established on these proportions the long ranges will be much more certain, the slope of this arm enabling the Sportsman better to lift as it were the charge of shot. On the other hand, in this as in all else, the contrary extreme is to be avoided, for with a gun stock as straight as a pike staff, the results will be most sensibly felt both by the cheek and shoulder. A medium between the two therefore, a semi-straight stock, is that which best adapts itself to the majority.

The Stocking or lodgment of the barrel, and of all parts of the arm, should evince the greatest care and nicety, and present no apparent interstices between wood and metal. The barrel and the

locks should be closely adherent to the wood, though easy to be replaced in their beds on being removed. The Cocks and body of the locks, or lock-plates, should be of first quality iron, and the interior limbs of the locks throughout, with the exception of the bridle, of cast steel. To obviate the inconvenience of splinters from the cap, the interior of the nose or mouth* of the Cock should be well hollowed out, with an opening in front to facilitate the disengagement of the cap after firing, and prevent the head of the cock from splitting or breaking. The action of the locks should be smooth, but at the same time smart and vigorous.

For young Sportsmen the safety trigger is most desirable; in addition to which, one of the simplest and best contrivances in aid of security from accident that we have seen, and of which we recommend the adoption to all Sporting Fire Arms, is the Cock of a Shotgun exhibited at the Great Exhibition of London, by M. Fonteneau, of Nantes, in which the cylindrical part of the cock, is made the receptacle of a screw, *moveable at will*. The head of this screw forms the crown of the cock, which being chequered round the edge is readily turned with the finger and thumb. Half a turn suffices to render all explosion of the cap impossible on its accidental release at half or full cock, and while it secures the Sportsman from all accident, the gun can be instantly put in a condition to fire by turning the screw. The barrel of the gun should be without defect, for on its strength the life of the Sportsman depends. The quality of this part of the gun should be especially and carefully ascertained. The best barrels are the Damascus, steel, and laminated steel barrels, the two latter of which have now been brought to great perfection and are much in vogue for best guns. The best lengths of barrel are, the breech included, from 30 to 32 inches for open country, and 26 to 28 inches for copse, of from 14 to 16 and 18 bore. For ourselves we prefer the 16 bore in a well constituted gun.

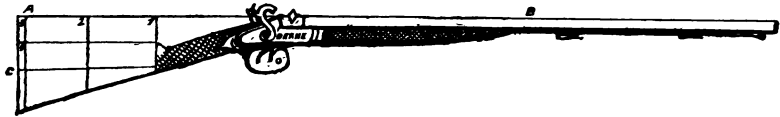
The barrels of the gun which are connected by the concave top rib or band, are admitted to be preferable to barrels of the same quality with the flat rib—for the following reasons :

They are lighter—conceal a defective brazing or soldering less—enable the sportsman to follow the game better than the raised flat rib, as the hollow between the barrels aids the eye to keep the line of sight along its channel; and for the further reason that the expansion of the metal together with the vibrations arising from the action of the gases of the powder at the moment of the first displacement of the projectile, are less irregular than in the raised flat rib,

* Called also the bell of the cock from that form being sometimes given to it.

which causes considerably more disturbance to the charge of shot, and influences prejudicially both the range and good effect of the projectiles.

The subjoined wood-cut will serve as a means of impressing on the mind of the amateur the rules of form and proportion which he should seek in making choice of a gun.



It is especially from the nose of the stock to its centre that the slope adverted to must be sought, the base with few exceptions being of much less importance, as it is between the figures 1 and 2 that the cheek of the sportsman almost always comes to lie when stooping his head forward over the stock of his gun to take the line of sight. It is therefore, to this part of the gun he should direct his attention. The more distant the top of the stock at that part is from the trace of the line A B, representing a straight line which would form a continuation of the rib between the barrels, the greater will be the slope or curve of the stock.

A further point of considerable importance to observe is, that a due regard has been paid to the proper fall of the point of equipoise or centre of gravity of the arm, the barrel being stocked and the gun put together in all its parts. This centre of gravity should fall at a point about 2 feet 2 inches to 2 feet 3 inches from the heel of the butt. Where this is not the case, we have seen it obtained by the introduction of an ingot of lead proportioned in weight to that effect, inserted between heel plate and wood in the butt of the stock.

OF THE TRIAL OF THE GUN.

THOUGH this important matter is seldom made the subject of attention till after the purchase of the gun ; it is one that we earnestly recommend previous to its acquisition. A fire-arm, as little as a horse, should be bought with the eyes shut ; in one as in the other case, a minute attention should be directed to their *trial*.

The trial of the shooting qualities of the arms of their production is a matter, nevertheless, which gun-makers, despite their desire and endeavours to maintain a fair repute, confide not unfrequently, but too negligently, to individuals whom they employ *ad hoc*, who do not give that attention thereto which the subject demands.

It thus happens, not unfrequently, that the defects of a gun are discovered only after some time and use by the purchaser ; who himself, perhaps, incapable of effecting a proper trial in all its requisite detail, trusts wholly to the assurances of the gun factor, or the maker, who has no positive personal knowledge of the shooting qualities of the arm. Whenever possible, therefore, and capable of making the trial himself, to guard against disappointment—the purchaser should submit the gun to a minute test.

The test of a gun embraces two distinct subjects—that of the action of the lock, and that of the range of the barrel. To ascertain the former, and ensure that its mechanism is good and established on a perfect coincidence and harmony of all its constituent interior limbs, the attention should be directed to the following points :

That side of the trigger which acts on the tail of the sear should be perfectly plane, and the under part of the sear-tail well-rounded. The contact of these two limbs of the lock should be so just, that no greater friction ensue from it than what is strictly unavoidable.

The trigger guard should be so let into the stock that the tail of the sear bears wholly on the thick of the trigger, and not upon its extremity ; for if the extremity only of the trigger work upon the round tail of the sear, it will not take sufficient hold of it, so that its leverage will be sufficiently powerful to disengage the sear-nose out of the bent of the tumbler, without effort, jar and friction ; all of which are highly deteriorative of those two limbs—while if they

are well polished and assorted to each other, act equally, and with a smooth reciprocal bearing, the action of the lock will be easy, smooth, and agreeable to the hand. But if, on the contrary, the sear-tail bears in part only on the thick of the trigger, the action becomes hard and stiff, and the limbs soon become worn by the acute angular friction that ensues. Furthermore, if the sear-tail be too short, it might occur at the moment when the person thinks to fire, that the trigger passing on the pressure of the finger between the tail of the sear and the wood of the stock will lose its action on the sear and work in a vacuum, leaving the sear nose indefinitely engaged in the full cock bent.

The triggers should be so disposed in the trigger-guard, that a distance of 1 inch 3-8ths at least exist between the right trigger and the front of the trigger guard, 1 inch 3-16ths at least between the curves of the two triggers, and sufficient space between the left trigger, and the hind bow of the trigger guard to enable that trigger to move without check or impediment. If, on the contrary, the triggers are not sufficiently wide apart, either on account of their respective lodgments being cut too close to each other, or that the workman who made them with the idea of giving them a more graceful form, established them with more width and roundness; the person firing incurs the risk of finding the triggers come in contact with each other, so that both barrels go off simultaneously, which may entail the following results.

He cannot recover the lost game—he loses a charge—and he receives a violent concussion from the double explosion; when he loses his confidence in the fear of a similar occurrence. A similar result will ensue when the two curves of the triggers are not at a sufficient distance from each other, so that he can fire the left barrel without the salient and interior edge of the right trigger hurting the index or trigger finger.

It is scarcely necessary to observe that the simultaneous explosion of the two barrels in a gun thin in metal at the breech, may occasion it to burst, because the vibrations imparted to both barrels by the explosion of one—being violently perturbed by those of the sudden explosion of the other—if the gun is not equally strong everywhere it will give way at the weakest point.

Other defects also have been observed to occasion this accident.

If the locks are not well regulated, and that the explosion of the two barrels, or only of one of them, occurs through too easy an action; generally arising from too great a weakness in the sear, or that the full cock bent has not sufficient depth: the concussion

resulting from the discharge of one barrel only, fired with a strong charge, will suffice to induce the almost sudden explosion of both barrels at once. The vibrations of the metal, moreover, being readily transmitted to the wood in which it is imbedded; the explosion of one barrel may again occasion that of the other, when the sear comes flush with the back part of the lock; that is when it bears on the wood, when the lock is placed in its bed. This inconvenience may arise from the sear being left too long; as also when the tumbler having been re-cut (although the sear was not too long before), the latter, from the different position it would then take on the lock, would graze that part of the wood which supports the under part of the lock.

By a simple inspection of the triggers, it will be easy to ascertain whether the way in which they are established will induce a double explosion from their mutual friction—but if the defects are concealed in the interior of the lock the difficulty is greater.

To ascertain this without incurring the risk of accident, should the gun to be tried be exempt or not from this cardinal defect of simultaneous discharge of the two barrels—load the right barrel only with a strong charge, and prime only the left barrel, for fear the left cock in coming down on the naked nipple may break—then fire the right barrel.

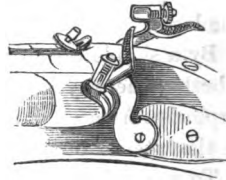
Should the left hand cock come down, then the defect in question exists; if, on the other hand, it remains on the full cock, then the concussion of the right barrel has no effect on the left hand cock, or in other words its sear spring is sufficiently firm, and the sear is neither too long nor grazes the wood.

Some sportsmen being in the habit when shooting to prepare themselves for the rising of different sorts of game, and with a view to obtain longer or shorter ranges as may be momentarily required, load their two barrels differently; the necessity may sometimes occur to fire the left barrel first, the right barrel being loaded, and the right cock at the full cock bent. In order, therefore, that the purchaser may fully satisfy himself; the same test should be resorted to inversely; that is, by discharging the left hand barrel first, after having had the precaution to put a cap on the right nipple, the right cock being at the full cock bent and the right barrel unloaded.

Should the purchaser have neglected to make the trials we have indicated above, at the proper time; i. e. before purchasing the gun, and that he should discover therein defects against which he ought to have guarded himself, he should not only have those defects cor-

rected, either by changing the sear or the sear springs but require the gun-maker to adopt the principle of cock invented by M. Fontenau, of Nantes, to which we have already alluded, and of which we subjoin an illustration.

M. Fontenau has further established a modification and great improvement in this cock, which consists in piercing the thread of the screw that enters the head of the cock, with a circular and horizontal hole, into which he introduces by force a spill of hard wood or other elastic and spongy body previously saturated with oil. This piece of wood or other body, the fire of which readily accommodates itself by its pressure against the tapped part of the cock into which it enters, gives by its constant elasticity a greater adherence to the action of the screw, and from its capillary nature becomes a reservoir of the oil with which it is impregnated, and which preserves a constant facility of action to the screw, notwithstanding



the collateral advantage of the greater adherence or tightness which it imparts to it. This is in point of fact an improvement that might be advantageously resorted to in all circumstances requiring the same effects of elasticity and capillarity in the tapped part of screws, pins, and other pieces, where friction and precision of fit are required : as also in all parts tapped or smooth, disposed for the reception of such pieces.

The trial of the shooting capabilities of a gun is usually made at from 30 to 50 yards with No. 6 shot. If it throws the shot regularly and does not recoil too much, there will be no doubt of its rendering good service in the field.

To try the gun, begin by burning half a charge of powder in each barrel. Should it be perfectly clean, it will be sufficient to snap a couple of caps on the nipple with the muzzle inclined to the ground, to ascertain by the dust raised on the soil whether the vents are not stopped up. Then put the charge of powder into the barrel ; then a wad well set down by two or three good strokes of the ramrod : put an ounce of shot into the barrel, (if the shot be *very small* diminish the charge one-tenth),* slip in the second wad, and set it on the charge of

* The smaller the size of the shot the more sensible is the recoil to the shoulder. So much does recoil increase in shot guns in the ratio of the *decrease* of the size of the component grains of the shot charge, that a charge of sand equal only in weight to that of the lead in a charge of snipe shot, gives a still greater recoil than the latter. A gun loaded with ball does not recoil so much as the gun loaded with small shot, though we have found the common belief the reverse of this, and that the larger the grains of shot, the greater must be the recoil of the gun.

shot without too much force, this will afford the means to determine the *recoil* of the gun : put the cocks at half bent ; put on the caps after having ascertained that no powder has got up into the vent ; let the cocks down gently upon the caps, press them with the thumb behind the head, and replace the cocks at the half bent : the gun is then ready,

In moments of leisure, find by repeated experiments and with *graduated* charges, that which best suits the gun. The extent of its range will be ascertained by gradually diminishing the charge of shot when that which best suits it will be recognised. By this means the knowledge and confidence that will have been acquired of and in the gun, will impart a greater feeling of reliance in its precision of shooting. In general the best shots are those whose guns kill best, because they know how to profit by the knowledge which they have acquired by numerous experiments frequently repeated, either when shooting, or at home, with the view to obtain the farthest possible ranges with the ordinary charge. The adherence to this rule of practice will be found advantageous.



THE KEEP IN CONDITION AND CLEANING OF THE GUN.

It is not enough to possess a good gun. It must be kept in an efficient condition to render good service whenever required. On the part of the person who performs the operation of *cleaning a gun*, some degree of intelligence is necessary, and no less particular care; without which some parts of the arm may be injured either in the unstocking or replacing them.

The cleaning rod, for convenience sake, should be divided into three parts or lengths, screwing respectively together, with some reserve parts, say four; provided with a sponge, having at one end a jag to retain hold of the tow, a round steel scratch brush, and a double worm to draw the wad, &c.

All the screws and metal furniture of these rod pieces should be of brass, except the worm, so as not to injure the barrel of the gun, which would take place if the rod furniture was of steel or iron. Two turn screws of different sizes, a nipple screw, nipple wrench and nipple key, a small tin oil holder, two hammers, one of steel, the other of brass or copper, to prevent injury to such parts of the arm as may require to be struck, when force is necessary to drive them from their place if held fast by rust or the gluten formed by the deposit from stale oil and dust; a small hand vice, a bottle of refined neat's foot oil, and another of pure olive oil; a packet of tow, some clean old linen rags, a box of emery powder, a piece of soft dressed chamois or sheep-skin, a few soft wood picks of willow, aspen, or walnut, a steel wire pliable hand-carder to rub the barrels with, a smooth firm buff-stick, and a nipple brush or cleaner.

To wash a gun-barrel, it is indispensable to unstock it. To effect this, proceed first to take out the ramrod—then holding the gun in the left hand, the muzzle of the barrel directed upwards, and the cheek of the stock leaned against the upper part of the left thigh; with the blade of the turn screw push in the end of the bolt, and disengage it a little from the loops; take hold of it then on its head side between the thumb of the right hand and the blade of the turn screw, and draw it out of the loop which fastens the barrel into

the stock-shaft or forehand ; give a slight lifting blow to the barrel underneath with the hand near the muzzle, and separate it from the stock. This being done unscrew the nipples and the barrel is ready for washing.

To do this the barrel should be placed in a wooden tub or bucket, and boiling water poured into the latter sufficiently deep to dissolve by the action of the liquid and the steam combined, the residuum of the burnt gunpowder deposited in the barrel. Renew the water after a few minutes ; raise the barrel upright, the breech always immersed at the bottom of the tub ; introduce the cleaning rod with a piece of rag or tow wrapped round the jug into the barrel, push it down and draw it up successively so as to produce the effect of the sucker of a pump-piston ; continue this operation, taking care to change from time to time both the water and the tow at the end of the cleaning rod, until the water is no longer discoloured and the tow comes up clean. Then take the barrel out of the tub, rub it externally with a piece of clean linen, and wipe it out internally with dry tow changed now and then as in the first process of washing it ; pour a few drops of olive oil on the sponge, and pass this once or twice up and down the barrel, which will prevent rust from striking in ; after this clean the nipples and replace them, taking care that they do not play too freely on their threads, in which case, as this proceeds from wear, they should be replaced by fresh nipples for fear of accident ; oil these lightly, and screw them on firmly. The operation is now completed.

In washing the barrels of fire-arms, soft water, i.e., rain or river water should be preferred, as other waters frequently contain saline or acid matters, which readily engender rust on iron, or steel, if not thoroughly dried. In case it should be inconvenient to wash a gun, the interior orifice of the barrel from the muzzle down to a depth of from 3 to 4 inches should be wiped with a greasy rag, by this means the barrel is protected from the oxidation which the damp air communicates to that part ; the remainder of the barrel is more or less preserved by the residuum of the burnt gunpowder which collects round the interior sides of the arm.

THE CLEANING OF THE LOCK

is a more complicated operation and requires the most minute care. A certain aptitude and use to the handling of arms is indeed requisite to this operation ; and he who is not somewhat skilled in the matter would do better to send his gun to a gunmaker, or content

himself with merely removing from the lock as much dirt as possible with a piece of clean linen rag, and with re-oiling the pins, the joints, and the bents of the tumbler.

Should the locks really require to be taken to pieces, and that the party is competent to do so, and to put them together again without injury to the limbs, he should begin with the right hand lock in the following manner :—

Remove the large side pin or screw of the lock plate ; loosen the lock from the stock by striking the neck of the stock lightly with the hand : take hold of the lock by the hammer or cock so as to remove the lock without chipping the wood, and lay the right hand lock in a place by itself. In the same manner take off the left hand lock and put it in another place apart, so as not to confound or mix the limbs, pins, &c. of the one with those of the other.

Proceed then as follows with each, one after the other successively.

Let the cock down by disengaging the sear from the repose or the half cock bent of the tumbler ; unhook the mainspring by pinching it adroitly between the claws of its lifting spring, then the small spring, unless it happen to be engaged under the bridle of the tumbler, which frequently happens, particularly in locks with worked bridles. In that case, the bridle of the tumbler should be first taken off, carefully avoiding to mix its different pins, for if one only be put into the wrong hole, the action of the lock will be deranged.

This inconvenience will be best avoided by resorting to a method in use in France, which is to deposit those pins successively as they are taken out in a small flat board pierced with holes corresponding to those of the lock plate, so that they cannot be mixed. The sear is then removed ; the tumbler pin ; and, with the tumbler screw driver introduced into the hole of the tumbler pivot, the cock is released from its square or axle, and the lock is taken to pieces.

Should the lock limbs be free from rust, a clean linen rag slightly imbued with neat's foot oil will suffice to clean them ; but should they have acquired rust, it will be necessary to resort to the use of a pick or scraper, and to the buff stick with a little oil and emery.

During the operation of cleaning, the greatest nicety and cleanliness is requisite, as it is indispensably necessary, that no foreign body, or particle of dust, should remain in the bents and joints of the lock limbs.

The lock is put together nearly in the reverse order :—

The tumbler with its swivel ; the bridle of the tumbler ; sometimes the small spring before the bridle, according to the build of the

lock ; the sear, the mainspring, and the hammer, its pin and the pin of the tumbler. A few drops of oil are then applied to the pivots, to the bents of the tumbler, and to the sear.

In putting the lock together, care should be taken that the bridle of the tumbler, as well as the sear, are not screwed on too tightly, so as to impede the free action of those pieces : nevertheless, they must be set on home, or otherwise the lock will not fit in level or flush in its bed, which would prejudice its action, and in the sequel deteriorate greatly the wood of the stock itself.

In replacing the locks care should also be had to push the triggers behind, so as to disengage the holes where the sear tails come, unless this is done the locks cannot be replaced perfectly in their beds. The lock plates should lie exactly flat and flush, in order not to impede the mechanism, and should never project beyond the wood. Lastly, on terminating the fixing of the locks into the stock, with the large lock pin, care should be taken that that screw does not protrude on any side, without being either too slackly or tightly screwed up.

THE CLEANING OF THE TRIGGER.

All careful and judicious sportsmen should be particular to send their guns for the inspection of a good gun-maker before the opening of the shooting season.

It frequently occurs that the triggers though clean do not act smoothly, and effect with difficulty the engagement of the sear in the full cock bend. This may arise from a coagulum of the stale oil ; a little fresh neat's foot oil introduced will dissolve this.

But if the triggers require cleaning, begin by unscrewing the two pins of the trigger-guard : turn down the trigger-guard ; take out the screw of the breech-tail and the screw of the fore part of the piece to which the triggers are fixed, take out this piece and unscrew the triggers. When these parts have been cleaned with the neat's foot oil, first remount the triggers, then the spring that moves them, taking care that it does not bear against either of them, which would create a friction very unfavourable to their action and disagreeable to the ear ; replace the trigger-plate with its breech-ward and front screw, screw on the trigger-guard carefully, and secure it by its two stock screws without damaging the wood.

When the barrels are in a very dirty condition after having worked them well inside as directed, they should be briskly rubbed outside in a longitudinal sense with the metallic scratch card, and wiped with a piece of linen or a very clean chamois skin. If the stock

is dirty, rub it over with spirits of turpentine which will dissolve the dirt, and by rubbing it then with a little tincture of benzoin on a small linen wad, the lustre will be restored.

After having put a gun in the manner prescribed in an efficient condition for use, should it not be required for any length of time and lie by ; in order to preserve it from injury, rub the whole arm over with a slight coating of oil, or better still with a grease prepared from mutton suet strained while hot through a piece of muslin, and mixed with a small quantity of best oil ; this grease should be kept hermetically corked up and free from dust ; the barrel muzzles should then be hermetically closed with greased felt-wads, or corks, connected together by a piece of string so as not to lose them, or find them too far pressed into the barrels ; cover the nipples with greased rags doubled several times which are kept by letting the cocks down upon them, and put your gun in a dry place. In this manner a gun will be ensured for a long time against all rust. As it may frequently happen when out shooting that the sportsman may not be near a water-course where he can wash his gun ; he should, after every seventh or eighth discharge, slip down an ordinary wad slightly wetted, upon top of the wad over the powder, or one of Wilkinson's metallic wads, by this means he may shoot a whole day without requiring to wash a barrel.

OF THE INTERIOR POLISH OF GUN-BARRELS.

ON the manner in which this has been executed depends greatly the regularity of the shooting and range of the gun. Barrels are sometimes polished diametrically, or spirally, on account of the greater facility this method affords to the striking up of the barrel, and that in the same space of time more work is got over by the turn in polishing, than when this is done in the longitudinal sense of the barrel—yet the latter method of polishing the interior can alone give to the barrel those qualities which are indispensable to its good shooting.

The diametrical polish can never wholly obliterate the lines which the cutters have left on the interior sides of the barrel during the boring. These unequal lines become prejudicial to the range of the shot charge from the beatings to which they give rise, they determine also in a great measure the amount of the recoil of the arm, and facilitate the speedy fouling and leading of the barrel, when the gun necessarily loses much of its precision of fire and extent of range. With the longitudinal polish, on the other hand, the disagreeable results enumerated are avoided.

The spiral interior polish is doubtless more pleasing to the eye from the brilliant but deceptive optical effect which it produces in the interior of the barrel when looked through upward from the breech, and it is this that frequently seduces and misleads the uninitiated in regard to the excellence of its finish. But in the longitudinal polish, the most minute line or mark left by the borer is made perceptible; and the work must be terminated with the most extreme care to save the workman from the imputation of carelessness—reason sufficient why the most of those whose special department this is, evince an antipathy to the longitudinal polish of shot barrels.

It will thus be readily understood that all the advantage is on the side of the barrel which has been polished longitudinally (not with the eccentric but with the hand): it throws the shot closer, carries further, fouls and leads less. This may be conceived by thus com-

paring the effects of the two modes of polishing—the passage of the grains of the shot charge through the barrel may be imagined to represent that of the sportsman over a ploughed field—the spiral polish gives the cross furrows, and the longitudinal polish the furrows in a straight line—over and through which, a passage is the most easy for the sportsman in the one case, and the shot in the other, is scarcely doubtful.

Should this parallel be considered overdrawn, and a doubt be urged on its validity, the incredulous may obtain conviction by cutting open a barrel lengthwise which has been polished diametrically, when he will not fail to perceive how prejudicial it must be to the good shooting and range of a gun.

At the same time it may be remarked, that a barrel which has been longitudinally bore-drawn with the rough file only, will present on first trial a great sharpness in the manner it throws the charge—but after a certain number of shots, the fouling will be very great, and soon destroy the effect of the resistance which this kind of rough-boring opposes to the charge, and which at first increased the range of the shot—while the barrel polished longitudinally with the smooth, and then with oil and emery, will keep its shooting for a whole days' sport without requiring to be washed out, and is, moreover, always easily loaded.

The gun-makers of Spain have long been reputed for the finished polish they give to the interior of their barrels; but, like ourselves, they have now abandoned the custom of giving to them that *conical* interior form which once was so prevalent also with English gun-makers, and given to the barrel by a mode of boring and striking up, to which a greater superiority of shooting was attributed than by any other. By the method adverted to, the breech was established one calibre larger than the middle of the barrel, towards which for a length of from 7 to 8 inches this width decreased. From the muzzle of the gun, which like the breech was one calibre larger than the middle, the decrease of bore was gradual to the centre for a length also of from 7 to 8 inches; so that supposing a gun to be 14 bore at the muzzle and breech, it was but 16 bore in the middle.

The object of this was to produce a first rapid combustion of the powder charge, which drove the shot with full violence towards the middle of the barrel, where being compressed by the restriction of the bore at that part, it was supposed to acquire a greater concentrated impulsion, the issue to which was then facilitated by the greater width towards the muzzle, and the vibration of the shot being diminished there by a less thickness of iron to impede

its passage out, it was deprived of less of its impulsive force, and the gun scattered less.

Other barrels deviated from these in a more uniform interior resemblance to the cone, diminishing insensibly and uninterruptedly from the breech to the muzzle for the whole length of the barrel: as for instance; having a bore of 12 at the former, and 14 at the muzzle. Though this may have been a better form than the first mentioned, as more regular, and presenting less disturbance to the passage of the powder gases; yet we have heard it observed by an eminently practical gun-maker and sportsman, that to establish this form of bore precisely and properly, it required a skill and nicety of the work on the part of the barrel-maker, which were not to be met with every day.

If we recollect rightly, for we have no copy of his work accessible, and it is some years since we read it, this conical form of bore was considered very advantageous by one of our most practical gun-makers, Mr. Greener; who illustrated his opinion with data of experiments which he had made on this point. It would, nevertheless, seem to us that this kind of bore is not applicable to the double shot guns now in use, and this conical form of the mouth of the barrel would require a greater thickness of metal the whole length of the barrel, to prevent its frequent deformation at the muzzle. Though applicable to such barrels as are heavy at that part; to the light thin barrels of our present shot guns it would be inadmissible—neither was it customary with the Spanish gun-makers, with any but single barrel guns.

A perfectly cylindrical gun-barrel of less thickness of metal than a conical barrel, will resist also a larger charge of gunpowder than would the latter. It is, moreover, preferable for firing ball, both as regards its greater precision and its less recoil: in fact, to fire ball from a conical barrel with a full charge of powder, is what we would by no means recommend as pleasant or *safe*, to those who should chance to possess a gun of the kind.

We may here advert to another practice (now almost obsolete) that was often resorted to, to increase both the strength of the charge of powder, and impart a more uniform direction of the shot to the muzzle of the barrel, and thereby produce more accurate shooting than with a smooth bored and highly polished barrel.

This consisted in the so-called hair-rifling, as also in a broader series of very shallow grooves running straight from breech to muzzle; the latter mode was less frequent, as it required a greater thickness of iron. Though this method has been found to succeed in later experiments,

yet no permanent advantage was obtained by it over the smooth bore barrel. They were, moreover, heavier, for a greater thickness of metal was required towards the muzzle of the barrel to admit of the grooves being sufficiently defined to produce the required effect; while on the other hand, they leaded and fouled much more readily, and required the greatest cleanliness and care, to prevent the deterioration of the rifling and the consequent loss of their shooting quality.

In this respect, therefore, these may be considered in the same category as the ring-bored or rough-bored barrels, whose greater amount of friction places them eventually in the same condition; while the amount of pressure which that friction induces in the interior of such barrels, requires, of a consequence, a greater thickness and solidity, or at least if that does not exist, a decrease for safety's sake of the charge both of powder and shot. It is scarcely necessary to say, that to long gun-barrels, these several modes of boring are less admissible than in short ones, friction being already in sufficient quantity in long barrels of smooth bore.

OF THE BREECHES OF GUNS AND THEIR DIFFERENT KINDS OF CHAMBER—AS EXPEDIENTS FORMERLY AND STILL RESORTED TO FOR THE INCREASE OF THE RANGE AND SHOOTING QUALITIES OF SMOOTH BORE SHOT BARRELS.

Since the application of the fulminates with the copper cap of the present percussion system, the increased rapidity of the combustion of the charge arising from the keenly penetrative and ignitive vivacity of the flame-jet of the fulminate, has become so obvious, especially in the increase of range in short barrels, that a less charge of gunpowder has been found sufficient to project the same or even a greater weight of shot than did the larger charge of powder with the flint lock. This potent auxiliary to the strength of the gunpowder has thus rendered quite unnecessary those researches and artificial means of increasing the strength of the latter, in order to attain greater ranges with shot guns; and the attempts to effect this by such devices have become now but a matter of history.

As illustrative, nevertheless, of the attention and endeavours directed thereto at an early and somewhat recent date, we will introduce some of these to the notice of the reader.

As it will be natural to suppose such means were in the first instance resorted to in cannon, and one of the most important was in the interior conformation given to the piece at that part of the breech where the powder charge was placed, to facilitate the fullest development of its force upon the projectile.

In mortars, the defects of a cylindric interior conformation throughout, had been already discovered in the 15th century. By this uniformity of structure it had been found that when fired with high elevations, the heavy ball or shell crushed the powder charge, prevented thereby its rapid inflammation, and decreased its effect on the projectile. From that period, therefore, the place for the powder charge was made narrower in that description of artillery. But it eventually became an accepted and well known principle in artillery, that in every fire-arm, the greater the diameter of the base where the powder is exploded, the more readily it combusts; and from the

greater or less degree of combustion depends that of the expulsion of the projectile.

According to this principle many years previous to the end of the 17th century, it had been customary in the artillery of several of the Continental states to establish in the gun a chamber larger than the chase of the piece, to receive the charge of powder. This as it would appear was first practically illustrated in some cannon cast at Lisbon, where about the sixth decenimum of that century it was first established, that a chamber of spherical or circular form produced the greatest possible combustion of the charge. This principle of construction was there first applied to a kind of howitzer-cannon of $1\frac{1}{2}$ feet in length only—firing a 24 lb. shot with 10 lb. of powder, and thence introduced into France and Germany.

The Portuguese guns of this kind represented by Masson,* were cast with a globular chamber six inches in diameter; at the extreme base of which, the now so much mooted advantage of *central fire*, or ignition, was obtained by a vent practised in the cascable, which to accommodate itself to that object was cast in a pan-like and jug-nose form instead of solid. The advantages of this piece were that they could be loaded and wiped out clean with the hand, without the usual implements. They were easy of transport in every locality, on the backs of two pair of mules; the gun itself being slung between two of them, and the carriage made like that of the old ship guns, between the others. The advantages of these spherically chambered cannon were nevertheless greatly counterbalanced: it was necessary to secure their trunnions with strong iron bands as with mortars, for they recoiled twice as much as ordinary cannon, and if this recoil was not checked, they not unfrequently turned a somerset with their carriages and broke them—their report was also very great.

But the primal cause of all these defects was and is, that the diameter of a spherical chamber being much smaller at the *entry* than in the chamber itself, the gases of the powder in combustion not meeting with a free issue to escape, they strike the sides of that form of chamber, receive therefrom a most confused and tumultuous commotion, in which they act and re-act violently upon each other, and upon the sides of the chamber; all of which has a very violent concussive effect upon the piece and its carriage. For these reasons a chamber of this form being both very inconvenient and inadmissible to establish in hand fire-arms, it was as may readily be conceived not applied to these.

The celebrated chevalier Folard, imagined another form of chamber

* Les Travaux de Mars, 1685.

much more applicable both to artillery and small arms, one, namely, of a conical form, or rather of the shape of a truncated cone, the base of which is considerably larger than its superior part. Experience proved that this chamber has at least, in a great measure, the advantage of the spherical chamber, of procuring a more complete combustion of the powder, from its presenting the latter in greater quantity round the vent. It has not moreover its inconvenience; because the sides of the truncated cone inclining gradually towards and meeting the entry to the chamber, the gases though somewhat confined, escape more readily and with less reaction along those sides, and produce considerably less concussion on the barrel. This chamber is still used in some mortars, and they throw their bomb farther than the cylindrical chamber which is that used in ordinary mortars. They have, however, a disadvantage which the latter have not got, since they will not permit of a ready and effective cleaning after firing; for this reason, as far as mortars are concerned, cylindrical chambers are the best for all under a 13 inch diameter; they are, moreover, more conveniently loaded with cartridges than any other, and are also not inapplicable to smooth bore fire-arms.

A chamber in the form of a frustrum of a cone would appear also to present some advantages for smooth bore sporting guns, and it was upon this principle that in 1814, Colonel Graubert had invented a musket, the lower part of the bore of which had that form, which gave a greater range and avoided moreover the necessity of using a ramrod.

But with reference to ordinary shot guns, we see but little necessity for a resort to a chambered breech, though the form that would be most applicable to a smooth bore barrel is that, perhaps, of the truncated cone. At the same time, however, that the range of the gun would be thereby increased, it would also increase the recoil, which might nevertheless be made bearable by giving a little more weight to the barrel. Besides the three kinds of chambers named above, there were also in use for mortars in the last century, the *conic* and the *parabolic* forms, the latter of which was the invention of Count de Lippe Buchberg. The former was generally made of a circular form at the base, so that the sides produced, met the extremities of the diameter at the mouth, it being imagined that the powder acted in right lines parallel to the sides of the chamber; as this, however, is not the case, though contrary to the opinion of many great artillerymen of that day, we are disposed to consider the conic chamber as the worst of all.

The parabolic chamber in mortars was a form also adopted by the

Portuguese, from the advantage of the shell having no windage with that shaped chamber ; but being the widest of any, it may therefore be included among the worst ; as it is not the *interior* figure of the chamber but the *entrance* which produces the effect ; because the smaller that is, the nearer it reduces the effect into the direction of the projectile. We believe this form of chamber to have been recently applied to smooth bore fire-arms by Captain Shrapnell, but that he found it improved by rounding or cutting off the apex of the parabola at the base, which rendered this chamber more easy to clean.

Mr. Wilkinson had previously patented a breech of the parabolic form for shot guns, in the disposition of the sides of which, the ellipse was nevertheless too sudden at its junction with the base lines of the bore, and his form of chamber presented in a greater measure at that part, the defective angles of the spherical chamber. To barrels light in metal, this was therefore a misapplication ; the reaction of the gases from the restricted entry of his chamber, occasioned when the gun began to foul, a strong repulsion of these to the vent, which not unfrequently threw up the cock to either the half or full bent, and sometimes even, as we have heard it remarked, broke the main-spring or the swivel.

The celebrated Joseph Manton had adopted a chamber of perhaps still more defective form, in which the fire was communicated to the charge through a long narrow cylindrical gut or channel, the base of which was in direct right angle with a somewhat long funnel-shaped vent ; such an interrupted, long, and restricted channel of communication to the charge, occasioned as it might have been conceived a great disposition to hang-fires, and was scarcely admissible even for a long barrel much less a short one.

Henry Nock's chamber for shot guns was superior to all these in every respect, and greatly preferable to that of Mr. Wilkinson ; but the improved breech of Mr. Greener was a still better conceived form, in which the fire was immediately communicated to the charge, which lay in a conical chamber with slightly elliptical sides, widening gradually to their junction with the sides of the bore.

To increase the projective force of the gunpowder itself in the charge of sporting guns, and thereby increase the range, was an idea that suggested itself long before the discovery of the modern fulminant compounds so dangerous as agents of impulsion. The use of a certain portion of antimony, of cinnabar, or of the precipitate of mercury mixed with the charge, was well known to Italian sportsmen

in the commencement of the 17th century, but it was also soon ascertained that the frequent use of those ingredients have a very corrosive and deteriorative effect upon the barrel, that endangers its bursting.

In the funnel shaped vent proposed by the Italian, Julian Bossi, in 1625, and afterwards almost universally adopted, we find the germ of the different improved modern vents and patented chambers which preceded shortly the ignition by percussion, and further, that the correct principle on which to procure a more efficient combustion of the charge and thereby a greater range, is not only no modern discovery, but a recurrence merely to the gone-by thought and practice of minds whose forestalling wisdom had long been forgotten or neglected.

The most simple form of chamber from its facility to "cup it" in the breech plug of the gun without prejudicially affecting the strength of the thread of the screw, is that of an inverted elliptical cone, resembling in its section the anterior part of an acorn above its cup; the small pin-head like point upon the top of the acorn being represented by a further small shallow cone with perpendicular sides terminating in a rounded apex, so as to conduct rapidly the jet of flame from the cap into the centre of the chamber proper, and produce a smart, quick discharge. A chamber of this conformation is superior to that we have frequently seen in use in shot guns, forming a cup, the section of which has a resemblance to the Phrygian cap.

With the former, neither hang nor mis-fires are to be feared, nor those disadvantages that belong to all the forms of breech adverted to above. In addition hereto, that requisite solidity of the breech on which so much depends for the sportsman, is effectually preserved.

We are disposed, nevertheless, to consider that the form of chamber of the Delvigne rifle, which is now frequently adopted by French and Belgian gun makers, would be preferable to the above—forming as it does a breech plug sufficiently long to take in the whole charge of powder, and presenting a small shoulder or ledge on which the wad rests on being driven down, compressing the powder sufficiently, without crushing it and impairing its action. Herein the element strength, is fully preserved, with security for a good range to the charge, and precision of shooting.

When in Brussels, in the summer of 1854, we found that the principle of the pillar breech of the suggestion of M. Thouvenin of the French artillery for the rifled carbine of the Chasseurs de Vincennes, had been ingeniously adapted to the purpose of increasing the range of shot guns by M. Mangeot, of that city. The

vent in this gun, though established at the side, was pierced, nevertheless, so as to enter the breech near the centre. A breech plug of a length of thread such as to avoid obstructing the breech end of the vent holes, is furnished with a short steel stem terminating in a lozenge-like lance head. The charge being compressed with a concave headed loading rod *ad hoc*, forces the wad upon this stem, which pierces it by this means, and opposes considerable resistance to the action of the powder. The resistance of the wad thus held back by the lance-headed stem, affords time for the evolution of much of the powder-gas in the same space, and determines thereby a greater expansive force.

While adverting to the pillar breech principle in this place, it may not be uninteresting to the reader to be informed that Julian Bossi, who wrote in 1625, a short treatise in Italian, "upon some inventions which had been made to increase the shooting of arquebuses," may not improbably have assisted M. Thouvenin to the idea of the steel pillar in the breech of the Vincennes carbine.

Bossi speaks of the following somewhat curious method; by means also of a base screw, a small *tube* in this instance, so proportioned in height and diameter as to contain the third of the charge of powder, the second third taking its place around this tube, and the third sufficiently to exceed its height and cover it, was screwed into the breech plug of the arm. This tube was pierced all round with small holes. Bossi assumed that, a more complete inflammation and combustion of the powder would result from this conformation, inasmuch as the fire communicated through the vent first made its way round the tube, inflaming the powder there, and then rapidly that which the tube contained, through the small holes adverted to, and these two parts inflamed that which covered the top of the tube, so that the powder was wholly consumed. The Italian author adds, moreover, that those who adopt this method, establish the tube of greater or less length and width; but the proportions he gives, appeared the most advantageous in producing the desired effect.

We can well imagine it was efficacious with the gunpowder of that day.

NIPPLES AND CAPS.

To describe the numerous forms of nipples that have been devised, and in turn approved and condemned, would be a seriously long and useless undertaking. We will limit our remarks upon this subject therefore to the following :—

To be good and serviceable in material, the nipple should be of cast steel ; though a much greater number are made of ordinary steel, and of iron tempered only.

The generality of forged gun nipples have the defect of too little thickness of the cone of the nipple upon which the cap is fixed ; a defect obliging an inconvenient reduction of the diameter of the orifice of the hole or vent of the nipple, in order to preserve solidity sufficient, or to obviate explosion—or if the temper of the nipple is too brittle, its rupture under the blow of the hammer, and sometimes the sinking of the cones if the temper is too soft.

The nipples of English manufacture are, generally speaking, much better combined in proportions, inasmuch as they are a good third thicker in the cone, which facilitates the inflammation of the charge by permitting the drill of a vent-hole sufficiently wide, without weakening the cone, and enabling a sufficient quantity of the stem of the nipple to enter well up into the cap. The most usual form of cone is flat at the top, the vent or hole very narrow at its orifice, to a depth of one-sixteenth of an inch, where it assumes a conical form to its base, which is somewhat wider, in order to facilitate the access of the powder of the charge. For a gun with vigorous mainspring, this form of nipple is preferable, but requires to be kept clean and to be seasonably changed. Another form of nipple is pierced with a wide funnel-shaped orifice and a wide base, but forms a narrow cylinder of about three lines in length at the neck of the cone, and then an interior conical hole of about $\frac{7}{8}$ of an inch long. This method of boring the nipple increases the force of the gunpowder charge, from the great body of gas from the fulminate of mercury, that is driven down the nipple hole and vent—this nipple requires also a cap thick in copper.

The nipples of St. Etienne, some of the best of which we have

before us, are funnel-shaped at the orifice for about $\frac{1}{32}$ of an inch, and the remainder of the conduit nearly of the same equal length to the base, where it becomes wider.

Another form of nipple which we have seen recommended by Parisian gun makers to facilitate the inflammation of the cap where the mainsprings of a gun are somewhat weak, has a wide entry; and the conduit tapers gradually to $\frac{1}{16}$ of an inch at the base, where it becomes flat, and then terminates in a narrow issue. These nipples are nevertheless very liable to give hang and misfires, if large grain gunpowder is used. The English and St. Etienne nipples with flat tops, are imitated by the Liege makers, but they do not come up with either of the former in durability, they fail most in being less well tempered. We have heard the quality of the St. Etienne nipples considered superior to either the English or Belgian; but as relates to the former, without prejudice, we cannot assent to this. In all guns of price, (or in the parlance of the trade) "best guns," the nipples should be provided with a thin, round washer of copper, at the shoulder of the circular bed where the thread of the screw terminates. This washer of soft metal, both mollifies the stroke of the hammer and shields the breech from the attack of rust at the part where the nipple screws into it. But it would be worth the notice of nipple makers to apply an amalgum of metal to the fabrication of the washer, which would possess the blow-deadening faculty of the copper, but whose contact with the steel of the nipple would not be so prejudicial to the latter by the action of the acid deposited by the fulminate vapour when the nipple has remained uncleaned.

With the exception of the first quality caps of the Messrs. Eley, "patent double waterproof anti-corrosive or metal lined anti-corrosive," the No. 3 caps of the manufacture of Gévelot, of Paris, may be said to be superior to those of our other present manufacturers. The German caps are greatly inferior in quality, because instead of employing Howard's fulminant as in England and France, for economy's sake they use the chlorate or nitrate of potasse, which is very corrosive of the metal of the arms.

While upon the subject of Percussion Caps, we feel it a duty to contribute the expression of a testimony to the merits of a cap (which we have no less found frequently expressed) of the manufacture of a person whose name and products in that line appear now rarely before the public—those namely, of Starkey, of Birmingham, which on the Continent, established the first repute for percussion caps of English make, under the name of "Patent Safety Caps," and "Best Anti-corrosive Caps." They are not now of frequent occur-

rence ; and the excellence of their quality renders this a subject of some regret.

A Baron Gersheim, of Vienna, invented some time since a cap similar in shape to a small nail, which at the moment of its explosion volatilises. In these caps it is presumed, the fulminate is covered merely with a thin layer of copper, deposited by the galvanic process.

All who have a regard for their eyes should use only the grooved or smooth *split* cap. A new cap was introduced to our notice in the summer of 1854, at Brussels, by M. Mangeot, the eminent gunmaker of that city, of the manufacture of M. Gévelot. This cap which exploded on the stroke of the hammer without splintering, sinks softly under it upon the cone of the nipple, from which it is easily removed.

No caps should be used in which the fulminate consists of muriate of potasse, which twenty-four hours after use, engender a rust so corrosive as to attack both steel and iron most virulently.



OF GUN-WADDING.

ALTHOUGH it is to be presumed most Sportsmen take the field provided with the best modern appliances under this denomination, yet it is by no means a matter of small interest to be acquainted with the best means of supplying the casual want and local deficit of those convenient appliances, which the competing ingenuity of modern purveyors to the necessities of sportsmen has devised, in some instances so efficiently in regard to service, furnished moderately as to price, and luxuriously, if we may be permitted the expression, as regards convenience and variety.

The opinion is now no longer so prevalent, that of whatever the substance the wadding may be composed, or whether it be loose or full and tight in the barrel, affects but little the range of the gun—as far as relates to that which is put on the shot well and good, but not so as regards the wadding upon the powder, that at least should be full in the barrel, though not too tightly jammed in the bore. It should be of a soft and mouldable material, but of a sufficient consistency to drive the shot before it, and carry it to a certain distance. If the wadding is of a hard, stiff substance, and jams too much, the gun will recoil more, and scatter the shot charge: if, on the other hand, it is of a very light nature, such as cotton, wool or dry leaves, and does not press on the charge sufficiently firm, it will not have consistence enough to drive and carry the shot before it, when the shooting of the gun will be weak.

To supply, should it be required, the place of the now generally used gun-wadding of the trade, nothing is better or more convenient than blotting paper; it admits of being rolled by the fingers, assumes readily a round shape, combines consistency with elasticity, and will range from twelve to fifteen yards from the muzzle of the gun. Tow in emergency also may be used, though a bad substitute, and in dry weather dangerous, from its liability to set fire to the dry stubble or grasses in or near copses, woodlands, and homesteads.

In apple-growing countries a very fine greenish-grey moss is often found upon those trees, which serves again as a tolerably good wadding, with the advantage of fouling the barrel less than paper, from its containing a considerable portion of vegetable oil.

With a punch of the same bore as the gun, wadding may speedily be made of an old hat or pieces of old belt or buff-leather, such as may be had of breeches-makers, village harness-makers, or at grindery-shops, but it is subject to shrivel and shrink on the ignition of the powder and permit of the escape of the gas. The resort to linen wadding is to be avoided, in which the shot will frequently roll up and ball itself.

Cork, an almost everywhere obtainable article, will afford a very servicable wad, and indeed, if cut with the punch and knife, of the thickness of the finger (in length, all wads should exceed the diameter of the bore by $\frac{1}{8}$ of an inch)* and forced down the barrel, from its compressive and elastic nature it will fill the bore of the barrel as hermetically as the best artificially manufactured wadding, prevent all escape of gas, and preserve the whole strength of the powder to the muzzle of the gun. From frequent experience, when unable to procure the manufactured wadding, and requiring a better substitute than the before-mentioned kinds, we have found it effective in giving good ranges and strong shooting, while it has the important advantage of an elastic friction, which combined with its cellular fibre, clears and carries away with it the powder residuum out of the barrel, diminishing, thereby considerably, both the recoil and fouling of the gun. Those who habitually punch their own wads, from sheet, wadding, paste-board, felt, &c., would find this worthy their attention. Cork of the thickness designated, may be purchased ready cut in convenient lengths at the shop of any cork cutter in most large towns. While advertng to the use of the punch as applied to the cutting of felt wads, two small notches made on both sides of the diameter of the punch so conform the wad, that its descent to the bottom of the barrel is facilitated, admits of the free revulsion of the gas after the combustion of the previous charge, and its uninterrupted issue by those small indentations in the periphery of the wad.

In the manufactured article of wadding, we must do justice to the superiority of those of English make over all that we have met with abroad. The chemical wad of white wool, derives its superiority from the mixture of grease and stearine coloured with orcanet, with which it is imbued. It cleans the gun most effectively, and lessens thereby the recoil; facilitates loading, and keeps the barrels in a regular shooting condition for a long time.

The well known thick concave wad of Messrs. Eley is also good for many reasons—its thickness, by interposing some substantially filled

* This will prevent it turning in its passage up the barrel, and enable it to answer the object of the wad, i.e., effectually to confine behind it the gases of the powder charge.

space between shot and powder charge, diminishes the recoil—the concavity of its form drives the shot in an uniform manner before it, and tends to lessen their friction against the sides of the barrel—from its duplex features of concavity and length, it cannot like the flat wad take a rotatory movement in its passage to the muzzle, and from its confining the gas more effectively and in a more restricted space it imparts a more concentrated impulsion to the shot, cleaning the barrel equally with the chemical wadding, being prepared in a like manner—but it is only adapted for a powder wad, for put upon the shot it increases the recoil very sensibly, and not the range.

Mr. Wilkinson's metallic wad has the merit assigned to it of cleaning the barrel effectually, and keeping the shot well together. In exceptional cases its use may be advantageous, viz., in a long day's shooting, used now and then to cleanse the barrel; but as a frequent appliance, we should think it deteriorative of the bore, yet far preferable in many respects to Walker's thin metallic scraping wad.



SHOT-GUN-CARTRIDGES.

It is now some few years since the use of cartridges for shot-guns has been resorted to in England for the purpose of expediting their loading in the field ; thereby saving time to the sportsman, and presenting other advantages, among which, that of increasing their range is perhaps the most prominent. In this respect those of the Messrs. Eley have acquired a wide-spread repute both at home and abroad.

In the paper and linen cartridges which had previously been made for this purpose, containing the powder and shot charge in one envelope, and in which the paper on the side of the powder was torn previously to putting the cartridges into the barrel, the prejudicial friction of the shot in its passage to the muzzle was not obviated, and the fouling of the barrel was further increased by the carbonization of some of the paper or linen, while a more serious evil could readily result from a small portion of either, or some grains of powder damped by the residuum in the interior of the barrel, remaining behind in a half incandescent state, which on ramming down the next charge might cause its sudden explosion.

Though in any form the loading of shot-guns by means of cartridges is disapproved by many, and for ourselves we prefer to charge from our powder flask and shot pouch, for many reasons ; yet the isolation of the shot charge in the Eley cartridge is generally accepted both as a very ingenious and effective contrivance.

The cartridge itself consists of an extremely fine netting of copper-wire forming a cylindrical tissue, of a size somewhat less than the bore of the gun, from $1\frac{1}{2}$ inch to $1\frac{1}{4}$ inch in length, the web of which is folded inside at one end so as to form the base of the cartridge. Over and round this metallic cylinder into which a mandril is introduced to keep it in shape, a paper envelope is pasted. The base of the cylinder is also covered with a paper patch bearing the Number and weight of the shot. The shot charge is then put in mixed with bone dust, and the whole covered with a wad, when the cartridge is closed up and pasted down. These cartridges for their preservation from injury, are packed in small paper bags of a dozen each.

The charge of shot varies between one and one and a-half ounce, but for long ranges it extends sometimes to two ounces. The number of the shot is assorted to the different kinds of game for which it may be required.

In order to use these cartridges with advantage, the ordinary charge of powder should be increased one-sixth, and for extra ranges one-fourth, as the maximum, to obviate the too early rupture of the metallic web which would destroy the effect this is intended to produce.

The Eley cartridge is of safe use in open localities only. In copse and wood, where the presence of other individuals is not always so readily apparent, its length of range and great penetration might lead to serious accidents.

To load with this cartridge, it is rammed down upon the powder with the wadded end upwards by a few smart blows of the loading rod. If time presses, to be ready for the rise of another bird, it is not necessary with this cartridge to put a wad on the powder; though, if there be time sufficient, the usual wad on the powder gives more regularity to the shooting. The great merit of the Eley cartridge over the ordinary or loose shot charge from the shot pouch, lies in the collective arrangement of the shot-grains. In the ordinary way of loading, the heaviest grains of the shot overtake the lighter ones, in their passage down the barrel, and take the first place upon the powder; for though all of the same No. and apparent size, there are always many heavier and denser in metal than the rest, which, of course, having more gravid weight, make their way best through the crowd. In the case of the said shot, this is not as it should be, for the heaviest should be farthest removed from the first impulsive force of the powder, for the following reason: they would not then acquire before the lighter shot, a force of impulsion, which in the ratio of their weight, exceeds that of the lighter shot before them—which they soon outstrip, making most un-courteously room for themselves by driving them either against one another or against the sides of the barrel, and then become dispersed themselves almost immediately after issuing from the gun. All this, as will be readily conceived, tends to produce the loss of part of their projective force, of their precision of direction, and of their force of penetration, to say nothing of their *leading* the barrel.

All these ill effects are doubtless greatly mitigated, if not wholly avoided, with the Eley cartridges; since held together by the metallic web of their envelope, in the same position in which they were introduced into the cartridge, no friction of the shot as it passes up the barrel takes place—no simultaneous and conflicting contact *inter se*,

in which those of the greatest gravid weight displace, overrun, and distance the lighter shot ; but all collectively and in the mass receive the concentrated impulsion of the powder-gas, impressed in a direction in conformity with the object desired : a result obtained by the joint action of the metallic web of the cartridge, and the bone dust, by which the grains of shot are surrounded—so that they issue from the muzzle in a mass, not unlike a solid ingot of lead, in which each of the component parts participates in the increased impulsive force acquired to their agglomeration in the form of a solid projectile.

It is affirmed by the proprietor of this cartridge, that it cannot burst at any distance, because it empties itself gradually and regularly on its issue from the barrel until it is wholly emptied, which occurs only at about forty or fifty yards distance, at which the charge of shot groups itself and penetrates as well again as that of a gun loaded in the ordinary way. The ranges of the Green cartridges considerably exceed those of the Red, on account of the greater consistency given to the texture of the metallic envelope in the former, proportioned to the results required to be obtained, a feature which wholly annuls the leading of the barrel. If the precaution is moreover taken to grease slightly the exterior envelope, a greater ease in loading is obtained, with a decreased friction of the cartridge in the barrel. It is further affirmed by the inventor that by affixing the powder wad to the cartridge, the expansion of the powder is much more accelerated, and increases both the projective force of the latter and the penetration of the shot.

The merits of the Eley cartridges were very highly attested to by that enthusiastic sportsman the late Colonel Hawker, and their superiority over the ordinary charge is incontestible at long ranges ; hence for that description of sport to which the Colonel was particularly devoted, (duck and wild fowl shooting) he found it merit every encomium ; but it is not so eligible for the kinds of game usually brought down at short distances, where the ordinary mode of shot charge has quite sufficient penetrative force, and does not lacerate the bird too much. A slight increase of the powder charge has the effect of increasing both the range and the grouping of the Eley cartridge ; but beyond an increase of one-fourth of the charge of powder, the dispersion of the shot as with an increased powder charge in the ordinary way of loading, increases in the proportion of the greater range acquired. Nevertheless, the Eley shot cartridge may be used with advantage in lieu of ball, swan drops, &c., for the shooting of many animals which are thick in fur, and too tenacious of life to succumb to the weaker penetration and less concentrated stroke of the ordinary shot charge.

SHOOTING ACCOUTREMENTS

UNDER this head we shall neither attempt the description nor the prescription of aught having reference to that part of the sportsman's outward man appertaining to the domain of the tailor, &c., &c. The taste, fancy, or judgment, the latter not unfrequently the rarer quality displayed in these, being naturally as various as the characteristics of the individuals themselves. The axiom that applies to the equipment of the foot soldier, more especially to him of the light Infantry, is in equal degree applicable to the sportsman: all that impedes motion and the freest use of the limbs and organs of sense compatible with the season and weather, should be sedulously shunned; everything detrimental to these is all that too much. A regard to colours is, nevertheless, by no means a less indifferent subject of consideration in the shooting dress, than it was regarded by sportsmen in the latter part of the last century. Green during the fine season, and while the leaf is yet upon the tree, is less readily perceptible at a distance by the game, than a colour that stands out in salient relief from the surrounding verdure; but not such a so called *green* as that with which the sages of our Military Board of Clothing still persist in making the men of our rifle brigade, (the very kind of troops that should be least discernible to the enemy) more conspicuous at a distance, even than the glaring red coats of the Line, which under certain atmospherical circumstances blend better with the tints of the aerial perspective. In winter, a brown-grey, approaching the colour of the dead leaf is on the other hand the best colour. But in respect to the convenience for use and transport, and security from accident, a choice of some discrimination is necessary in the following articles:—

THE POWDER FLASK.

The experience acquired from the fatal accidents that resulted from the defective mechanism of this article as in general use some years since, and still too frequently carried, has so far stimulated the exercise of the ingenuity of their manufacturers, as if not wholly to exclude the possibility of accident, to prevent at least its so frequent

occurrence from that cause which led so directly to it, i. e., the unimpeded contiguity of the charge in the top of the powder flask to the powder in the flask itself.

Of the various methods by which the isolation of the former from the latter has been sought, that of the patent "turnover-top" flask is hitherto the best. By this contrivance the powder measure on being filled, and the communication severed by the cutter, on being pressed down by the finger turns its mouth downward, when its contents become completely detached and isolated from the powder flask during the operation of pouring the charge into the barrel. It is scarcely necessary to dwell on the advantages this mode of structure of the top of the powder flask has over the flask with the fixed top introduced into the muzzle of the gun when loading. A few seconds more time may, perhaps, be required for the use of the former; but this can scarcely be a consideration with those who prefer safety to a considerable amount of risk incurred at a trifle less outlay in the article with the fixed top, whether with interior or exterior spring to the cutter.

The material of the body of the powder flask is no less a matter of selection. The copper flask has several disadvantages, with all the security it gives for the preservation of the powder from damp. The chief of these are, the unpleasant smell it imparts to the hands in warm weather, and its ready liability to be bruised. The Britannia metal, German silver, or plated flasks, are exempt from the former, but almost as liable to the latter. The copper or tin flask, covered externally with a good rough hog skin or wicker, both of which admit of being cleaned with a little soap and water and brush, are the most preferable, both for solidity and freedom from smell, and also for firmness of hold in the grasp, on a cold winter day.

As the sometimes required variety of graduation of the charge is not presented in one top, for guns under 10 and over 22 bore, this may be obtained by the use of a supplementary top to the same flask, graduated according to the circumstances. Having reference to this convenience for the ready graduation of the charge of powder to such circumstances, the remarks (p. 68) on the influence of the temperature of the air on the inflammation and combustion of gunpowder will be borne in mind, and the occurrence of the circumstances of a greater or less amount of caloric or humidity in the surrounding atmosphere, may require a judicious variation of the charge. Less would be required in dry weather than in damp; but in the extremes of heat and cold, the difference of this influence is still more sensible. An attentive study of these influences will accustom the sportsman

to regulate his powder charge with a judgment that will enable him to avail himself of such circumstances as are favourable, or to avoid those influences which are prejudicial to his success.

THE SHOT POUCH.

The shot pouch with a graduated lever-top charger from 1 to $1\frac{1}{2}$, and 1 to 2 ounces, of flexible but strong leather, is about the best form and material for this article. In its selection care must be had to ascertain that the two cutter-valves are fitted to act efficiently, so as to separate the charge of shot when once taken, from all further access of shot grains from the pouch itself, and that the pin or axle of the lever is strong and well rivetted on both sides, as also that the stem which supports the lever be firmly established.

The shot belt or magazine best adapted to carry the supply for several days' shooting, is by no means the single sling or double belt usually worn over the shoulder, and crossing the strap of the game bag upon the chest. This form of shot magazine is as defective from the compression it produces on the chest, and the fatigue arising therefrom to the sportsman, as the late cross belts of our Infantry, which were so pertinaciously adhered to by our Military routinists. The inconvenience arising from the continual beating about of the shot and belt with every exertion, particularly when passing over a country much intersected with ditches and water courses, is a further most unpleasant feature in belts of this construction, worn hitherto as a counterpoise to the game bag, and to distribute the weight carried.

The shot magazine in the form of a stiff waist belt is also a most uncomfortable and prejudicial appendage, and this form is alone inadmissible when the material is of a soft pliant chamois dressed leather, which in long use does not lose its pliability, nor become so readily injured. With a waist shot magazine in two distinct compartments, for two kinds of shot, of this material, no oppression of the abdomen is felt, and the weight can be readily shifted round at will.

The so-called "bent or snake shot belt," from its curved shape to adapt itself flat to the body, is a great improvement on those hitherto used, lying closer during exertion, and facilitating the access of the hand from its constant retainment of place.

As may readily be conceived, the size or No. of the shot used should not only be adapted to the game, but to the season; for as the latter may be, so does one and the same kind of game require a different No. shot. From the middle of August, for instance, to the first of September, when partridges are not full quilled, their

stroke of wing yet weak, and their rise closer, they require a size grain less than in the middle of September, when they are full quilled, strong on the wing, and wilder. As the appropriate use of the different Nos. of shot will be known to most of our readers, or soon acquired in practice by the novice, we will here close this part of our subject to advert to two kinds of smooth bore shot guns, on the proportions of which no two sportsmen or writers on the matter are agreed.



THE PIGEON AND DUCK GUN.

PIGEON shooting must be considered less in the light of a field sport than in that of a modern recreation, favouring the indulgence of that passion for betting, which as a people we are so especially disposed to introduce in most of our amusements. The plea urged in excuse for this tame kind of butchery, that it "keeps the hand in," and perfects the skill during the suspension of the shooting season, is scarcely tenable, for of our own experience, the best "shots a field" that we have known, were not the best shooters from the trap; neither as far as our own humble opinion goes does this kind of recreation differ much from the "pheasant battues" in close well stocked preserves, which the so-called "shooting parties" of our modern Fashion pique themselves upon as exhibitions of the qualities of sportsmen; affording as they do little of that pleasing relaxation in which the exercise is as beneficial to the health, as the diversity of incident is recreative to the mind; and in which, moreover, the self-love and skill of the sportsman finds in success, so much more real subject of self-gratulation. In pigeon matches, self-love and money-love being mostly at stake together, to ensure the safety of those two imperilled sentiments resort is had to guns of great bore, 8, 10, and 12, very artillery, throwing from $1\frac{1}{2}$ to 2 ounces of shot with circa 138 grains of powder; so that in this kind of shooting, the skill of the shooter may rather be measured by the calibre of his gun than attributed really to himself. Nevertheless this modern fashion of pigeon shooting has extended from this country both to the north of France and to Belgium; and the birds for the indulgence of this amusement have become a staple of export to a very considerable amount from the latter country to London.

In this exercise, if the double shot at two pigeons released at 15 yards from two *separate* traps successively, and not together, were the rule, it would form a better school of practical exercise for the young amateur sportsman, from the greater analogy it would then present to "shooting a field," where for the most part the double shot occurs at about that distance and from the separate rising of two birds.

Where a light gun of from 5 to 6 lbs. with a length of from 26 to 28 inches, is preferable for the field, to admit of ready handling, and

afford the freedom and rapidity of movement which is there necessary ; the requirements of pigeon shooting demand on the other hand a more indispensable thickness of metal and a certain length of barrel.

The best bore for this kind of shooting is 10 and 12. The length of barrel should be in the proportion of forty-six times the diameter of the bore, inclusive of the breech. The length of the stock from the right trigger to the heel plate should average from $14\frac{1}{2}$ to 15 inches, and from $13\frac{3}{4}$ to $14\frac{1}{2}$ inches for a short armed person ; exceptional cases may of course sometimes occur. The weight of the gun should not exceed 7 lbs., 4 lbs. of which to the barrel, and 3 lbs. to stock and furniture.

THE DUCK GUN.

Whether from the want of any higher sentiment of their art than its mere restricted mechanical routine as a trade calling—the difficult access to opportunity in this country for the indulgence of its practical study in the field even where the disposition may have existed—or from the unceasing assiduity in their trade occupation as a living, which the constant burden of the most oppressive imposts inflicted upon industry in any country under the sun, have long rendered obligatory on those who live by handicraft labour, and which have made it a vital consideration with the English gun maker, as with every other so engaged, to grudge himself a moment's relaxation from his weekly toil, even though to extend his knowledge of his business beyond the mere mechanical routine and workmanlike finish of his products ; few or none of the craft have been or are, like most of their brethren on the Continent, themselves practical sportsmen or shots.

Thus socially situated, and as a collect moving constantly in the same circle, submissive to circumstance and the habits of thought which it imposes, the majority of the improvements and innovations in sporting arms have derived to them from the suggestions of those of their customers who, practical and reflective sportsmen, have given them the advantage of their experience and suggestions as to the proportions, shooting requirements, &c., &c., of the very articles of their production.

With no one of these has this been more the case than the Duck gun.

Of a comparatively restricted use, the duck gun had received from our gun makers, with some few exceptions only, but little attention, until the late Colonel Hawker to whom we have already adverted, directed, as an enthusiastic lover of this kind of sport, considerable attention to this description of sporting arm.

In some instances the length of barrel in these guns was either too great, with a thickness of metal inadequate to support the not unfrequently doubled and tripled charge, or their excessive length of barrel and substance of iron, gave to them a most inconvenient weight. Others with short thick barrels, with the view to make them more handy, had not sufficient length for the attainment of the range required of them, and their bore was either too large or too small. According to Colonel Hawker, who established two kinds of duck gun, the large and the lesser one, the best length of barrel varies from 3 feet 8 inches in the less extreme, to 4 feet 4 inches in the maximum, which admit of being fired without a rest or crutch; beyond the latter length it ought never to exceed from four to six times the diameter of the bore. Though citing numerous experiments on the duck gun, it is to be regretted that the Colonel, who was so well qualified to give more precise data on this head, should have neglected to inform his readers upon many details necessary to give a conclusive character both to his experiments and opinions. To his large 7 bore duck gun he assigns the weight of 14 pounds, with a length of barrel of 4 feet 6 inches. To the lesser one, 12½ pounds weight, a 4 feet 5 inch barrel, and the same bore as the former; which guns, fired in competition with double shot guns of 9 pounds weight, 14 bore, and barrels of 32 inches in length, gave the following results:—

At a distance of sixty yards the large duck gun threw 32 shot grains into a target of 12 sheets of thick paper placed over each other, 25 of which passed through the last sheet of paper, while the double gun put but 20 into the first sheet and 18 in the twelfth. At 45 yards the lesser duck gun put 45 shot grains through the 12 sheets of paper; the double gun put but 26 into them.

He gives however neither the No. of the shot, the amount of charge, nor the weight nor quality of the powder used in these experiments. As a general rule in reference to the duck gun, he deduces on the other hand—that if the calibre is too great in proportion to the weight of the barrel the gun has considerable recoil—that the short barrel scatters considerably—that the gun recoils less fired from the shoulder than from a rest—that the stock of the gun should be as short as possible, and sloped, so as to diminish the recoil, and that in this exceptional instance the heel plate should be curved in order to facilitate its fit to the shoulder.

The difference of range which he assigns to the great and lesser duck guns, as compared with that of the double gun, appears very trifling when the difference of weight and length of barrel between

them are taken into consideration, and that the diameter of the bore of the latter in respect to its application was too small. From our own experience, nevertheless, we have both had and seen on many occasions when shooting in Ireland, and in the wide spreading marshes of the Theiss in Hungary, a more frequent success with a heavy double 8 bore gun, and in the latter locality with a 12 bore conical Esquibel barrel of 36 inches length, than with considerably longer and heavier *duck guns*. This we attributed in a great measure to the too protracted friction and beating of the shot charge through such a length of barrel,* which detracted from its force and initial velocity, as also from the well regulated spread of the shot induced by the not unfrequent balling of the charge.

As a fair rule for the proportions of the duck gun for ordinary circumstances, its dimensions should permit of its easy loading; its length of barrel should be no greater than will secure a good range and regular distribution of the shot; its weight should be no more than sufficient to oppose a proper resistance to the recoil, and the length of barrel calculated on the scale of forty-eight times the diameter of the bore—the stock should be short, as in most cases the sportsman is enveloped in thick warm clothing; the forehand of the stock should be of a length to secure the barrel to it by at least two bolts and loops; the ramrod should be stout and strong, of ash, oak, or any foreign wood such as beef wood of compact fibre. An interior longitudinal polish of the barrel is unexceptional in a gun of this kind, and a conical bore presenting a diameter of $\frac{1}{16}$ of an inch more at the breech than the muzzle (a diminution of metal at that part, which in a barrel of the required weight and strength of iron, cannot prejudicially affect the latter quality), is in this instance an exceptional preference. The furniture should be of horn, which in winter is less cold to the hand than metal.

* The quality length which in proportionate quantity is productive of force, became here prejudicial from its excess.

ON ACCIDENTS WITH FIRE-ARMS.

APART from those mournful accidents that accrue to youth, and to persons wholly ignorant of the handling and nature of fire-arms, from their extreme incaution and folly of trifling with them in sportive play, accidents of the gravest kind occur not unfrequently in the field, from the forgetfulness, levity, or recklessness of manner with which others, better accustomed to their use, carry them in circumstances which require the exercise of precaution and an ever wakeful judgment.

Shooting, one of the most healthful exercises resorted to by man, has in its own degree, like every other physical recreation, its accompanying amount of peril, and in like proportion it demands at all times and in all places the exercise of that guarded caution, which the intuitive sense of a possible danger awakens in the lowest animals, and should therefore at least be expected from a human intellect. To the means and mechanical improvements calculated to decrease its dangers, it may nevertheless be truly said, the gun makers of modern times have shown themselves much less insensible than have, or do even yet, sportsmen themselves: for some from recklessness, or an overweening confidence in the constancy of their discretion, others from aversion to change, and too many from a false economy, adhere still to the old, and adopt the safeguards from danger only after the oft-times painful experience of a narrow escape.

To detail the various incidental causes of accidents from fire-arms in the field would require of itself considerable space, but the most frequent arise from forgetfulness and carelessness to guard against incidental circumstances of continually possible event.

As we have already indicated, one great danger to the hand and life itself may now be guarded against by the use of the powder flask with "turnover" top charger—the sight is no longer imperilled when the split-grooved cap is used—the safety trigger guard, a simple, and by no means inconvenient mechanism, affords security against the fortuitous contact with an unobserved protruding branch,* the

* This must not be confounded with the safety half-cock bent to the lock, cut lower down upon the tumbler, so as to bring the cock-nose at the half-bent no farther from the nipple than $\frac{1}{2}$ of an inch. This lock has many inconveniences.

cocks on the principle of M. Fontenau already adverted to, prevent them at will from coming down upon the caps ; and the cost of all these securities is so trifling, that no person of ordinary discretion or care for himself or others should take the field without them.

We will conclude these observations by a recommendation of the rule imposed by consent upon all members of Pigeon Clubs in Germany, viz., the adoption to their guns of the necessary precautions against accident, under the penalty of an amount equal to ten shillings, and exclusion from shooting until the rule has been complied with



THE CAUSES OF THE BURSTING OF GUN BARRELS.

It may be safely affirmed that no gun barrel manufactured of *good materials*, and by a barrel maker who sets a higher value on his reputation than upon an immediate and temporary profit economically obtained, bursts, except in the case of being badly loaded or loaded to excess.

Under the first of these exceptions must be placed the instance, when from defective loading a space or vacuum is left between the ball or the shot charge, and the charge of powder; in this instance there will be *great* danger of the barrel bursting, even though it may *not* burst on all occasions; the latter must rather be considered as fortunate exceptions to the rule. To produce this exception when firing ball, it is sufficient that there should be the least unfilled space between the ball and the side of the barrel, and it may readily be conceived that it is difficult for a ball to bear equally on all the points of its circumference, unless it have been forced down with an iron ramrod. In that case, as it will mould itself to the barrel and fill the bore hermetically, however trifling the vacuum be between the ball and the charge of powder, and however strong the reinforce or breech of the barrel may be, the barrel cannot fail to burst.

But with the charge of shot there is *no such favourable eventuality possible*, as the wad and shot *close the bore hermetically*. Thus every time that the communication of the air enclosed between the ball or shot charge, and the powder, be *totally* intercepted from that of the external air, the barrel must of a necessity burst. The same will happen upon any mould or snow getting accidentally and unobserved into the barrel of a gun by the muzzle coming in contact with the ground; or if it does not burst, it is only because those extraneous substances do not exactly fill up the bore at the place where they have lodged.

From this it is easy to conceive that on firing a gun the muzzle of which is thrust into the water it will burst, also, since it is then certain from the nature of the obstacle that opposes the explosion of the powder, the powder gas can find no outlet to escape, and its whole expansive power, concentrating itself on some part of the barrel weaker than the rest, will force its way through that part.

Except in these cases and that of an excess of charge, it is very rare that a gun-barrel will burst ; if it does it is from a defect in its manufacture, either of the metal not having been properly heated, of some parts having been improperly welded, or that it has some deep grey or flaw ; or lastly for want of care and due attention in the filing, when a greater thickness has been left on one side than the other.

The last defect is the more general one, particularly in low priced guns, and it is also the most dangerous one ; for the rarified gases of the powder which always tend to expand and occupy a larger space, confined and compressed in a barrel in which they find a weak and less resisting part, break through the obstacle and make their way out at that place, which could not have occurred if they had met with an equal resistance on every point of the circumference, and if the repercussion occasioned by the strength of the thicker part had not favoured the exertion of their force against the weaker part. Hence it may be assumed as a rule, that a thin light barrel, forged close to the file, and equal in metal in all its parts, is much more safe than a barrel considerably more weighty in metal, but badly filed and of unequal thickness.

In remarking on the causes of the bursting of gun-barrels, we have not thought it necessary to take into account the bad quality of the iron, because we argue only on the supposition that though the iron may not be of the very best quality, that it is at least such as it *ought* to be, to be converted into a fire-arm ; that is to say of a tough fibre, not too coarse in the grain, and of a dull silvery colour when broken inch-wise off the sample bar-iron. But there is a quality of iron too frequently used for some years in this country, which although otherwise worked with every proper attention, is incapable of standing the most average proofing, and the conversion of which into fire-arms has consequently not failed to produce the most disastrous results.

FIRE-ARMS OF ABERRANT FORM.

THE BREECH-LOADING AND REVOLVING-BREECH PRINCIPLES.

Few things more than the majority of the improvements or so called new inventions in Fire-arms, have better illustrated the truth of the remark of Tacitus nearly 2000 years ago, that "there is a certain natural rotation in human things," or as may be expressed in other words—that human creations gravitate always in nearly the same circle of ideas, however novel to the age the appearance they assume.

Herein, as in everything around us derived of man, we see—some unconsciously—and those who have an inkling of it, with too ready forgetfulness and neglect of the moral which it teaches, not only the reproof to our arrogance in laying exclusive claim to the conception of a material form, much less of an idea ; but the infallibility after a few generations have become as it were "born to their manner," of the partial or complete oblivion both of the forms and ideas that constituted the life of their time, as of the generations who deemed them an integral and indispensable part and parcel of their existence.

To minds, and we meet with too many such in this ultra selfish age of our civilization, who almost wonder how the world could have gone on before their coming, and think it scarcely possible after their departure that it will be able to go on without them, such reflections may certainly be humiliating. But nevertheless this is an indefeasible and wisely ordained destiny, by which instead of *one* acquired phase of forms and ideas remaining impressed on the world as an immutable state of attainment, one that would be a premature caducity, where all is yet in the fresh youth of an eternity, in which the life of a nation is but a link : the germs of change spring up around us every day in the new born humanity of the child, the fresh mind-link that is to connect the past with the future in the world's life of thought.

In that child is typified, for those who can see it, the rotation in human things, figured by Tacitus. That child is at one and the same time, the elementary and terminal link in the cycle of human progress of his time—the beginning and the end of which is circumscribed as

the life of the individual man is short. Where the mind of the man left off, the mind of the child but begins again—new care, and with the same process of new culture to mould and develop the same norm of intelligence :—that done, what has been effected ?

We have advanced but little farther, and how often retrograded, when we think, under a new name or a modified form, to have attained perfection and **THE NEW !**

That is *the* reason why we have as yet, progressed so far, only,—why, physically and morally, practically and theoretically, we have even in the present day but modifications of that which has gone before—the mechanical and ethical principle of which is as a rudiment, coeval with nature and with man in the world's life, though the vanity of each age, the complex of that of the individual man himself, believes that it has grasped the in and for this world, never attainable new. The school of Nature, as a mine of mechanical principles, is as inexhaustible as the **VAST THOUGHT** that conceived and founded it. An eternity only can unfold all its principles, though they are old as Creation, and their instructive originals extant on every hand. The student in that school, Man, is but an ephemera, beginning as we have said as the child, where the man ended ; and were it otherwise, Humanity would be in disaccord with the Nature around it, an impossibility in an all-perfect design.

We beg pardon of the reader for a digression of thought which he may perhaps consider as aberrant from our subject matter as the kind of arms we are about to consider, from those with which he may have been acquainted from youth upward ; but as he is the best sportsman and wisest man who best accommodates himself to circumstances, so is the reader no less so, who takes most indulgently every writer “in his humour.”

But it is thus also as we have sought to convey, that the fresh impulse given by circumstances to the improvement of fire-arms in recent years, has awakened the ideas of the past from their long slumber, to rehabilitate them as it were in a new garb only ; proving that the intelligence of a truth, though but faintly grasped and impossible of full development by the circumstances of one age, may under more favouring contingencies return an accomplished fact in a later one, because the truth of a new idea leads frequently to the recurrence of, and the return towards a more ancient idea, as a basis for the development of both. This was evinced at an early period of the application of the new igniting medium to sporting guns.

In our examination of the two Systems of fire-arms, designated in the heading of the present sub-division of our subject, we shall feel

it a duty, the performance of which is claimed alike, by truth and science, to point out and correct the errors of belief that were so inconsiderately promulgated in this country, as to the exclusive originality of idea and property attributed in the principle of the last of these systems to Colonel Colt, by his over-zealous servitors here, as his sole and emanating invention.

In so doing, we at the same time impress upon the minds of our readers, that we are actuated by no other sentiment than that spirit of truth and justice which we believe most men esteem and desire to see dispensed, where the interests of knowledge and science are concerned, and which in the present day, we think few only would knowingly assist to pervert and exclude from the growing and future generations.

Taking the two systems in chronological order, we will first deal with the Breech loading principle, and then with that with Revolving chambers.

THE BREECH-LOADING PRINCIPLE.

The application of the muriatic fulminant (chlorate of potasse) to the ignition of the charge of sporting guns, in lieu of the flint and steel of the old system; an application for which the Rev. Mr. Forsyth had obtained a patent in 1807, though like all first attempts to supersede a long-established and known custom, gave the first practical impulse to an innovation which, despite its numerous opponents among the gun-makers of the day, led the more speculative of the craft to researches for the simplification of the mechanism first resorted to for percussion firing.

The new field for the exercise of the gunmaker's ingenuity which had thus been opened in England by an amateur, was not long in attracting fellow labourers on the Continent. Simultaneously with Deboubert of Paris, who in 1811 (like Vauban at the close of the 17th century) to meet the growing inclination for the advantage of the new discovery, and to satisfy the adherents of the elder system, designed a duplex lock for fowling pieces, which combined both modes of ignition, the flint and the fulminant priming; Pauly of that city, led the way in the suggestion of uniting the priming to the cartridge itself; and recurring for its application to the breech-loading principle of the olden time, first applied as we have shewn to the small tressle cannon of the fifteenth century, and afterwards by Henry II. of France, 1540, to the hand arquebus, resuscitated a mechanical structure of the breech which, though recommended by

Marshall Saxe himself to obtain that rapidity of loading and firing which is desirable in so many circumstances, had been abandoned as inapt to the military flint lock musket of that day.

The reiterated return at different periods to the breech loading principle as a mechanical base for the construction of a fire arm evinces how much celerity of loading and firing was continually considered an object of desirable attainment. Another modification of this structure made its appearance in 1663, in which the chamber opened at the side by means of a hinged joint, and in 1751, a Frenchman of the name of La Chaumette suggested another variety.*

Partly by the combination of a percussioned cartridge (the ignitive agent of which was the fulminate of mercury) with the advantages of ease and speed in loading, presented by the breech-loading principle, effected at once two things: by the former he obviated the then imperfect percussion priming-grains which had replaced the muriatic powder for sporting guns, and by the return to the latter mechanism, with the auxiliary aid of an improved element of ignition, he led the way, though perhaps unwittingly, to the present perfection of a mechanical principle in the structure of fire-arms, the advantages of which have become one of the most important accomplished facts in the arms of the present day; not only realising more than ever could have been dreamed of by the early fathers of the breech-loading system, but staggering the prejudices of the most inveterate professional routinists opposed to the adoption of a breech-loading fire-arm for military use.

This gun designated by the name of its inventor, enabled the sportsman to load and fire from 10 to 12 shots in the space of a minute. The charge and the priming were united in the same cartridge prepared in a special manner; the priming of which taking fire in the centre of the bottom of the charge, the inflammation ensued more rapidly, and the powder being burnt almost simul-

* A resuscitation of the breech-loading principle had been reverted to in England in 1772, as shewn in the archives of the Patent Office, Southampton Buildings, Chancery Lane, by "Wright and Byrne's Patent" of that year, No. 1003, applied, in the words of the patentees, to "screw and lock barrels." In this patent is found reproduced the *hinge-break to the chamber*, of 1540, better known in the present day as the Lefaulcheux system. In this, therefore, as in many other instances where patents of invention, and as such of special property in and of monopoly of manufacture, are granted, the interests of the public and of the trade in whose domain the fundamental mechanical principle had long been a common property, were ignored by those officials who it may justly be considered should be as a matter of course acquainted with pre-existing productions of the kind, and which were and are still extant in most collections of ancient arms. Where an adaptation of a known principle with modifications and amendments are patented, should such rather not be designated Patents of Modification than of Invention?

taneously, half the charge sufficed to produce the same effect as the whole charge in ordinary guns.

The gun on Pauly's system had moreover the advantage of being secured from damp and even from rain, of never missing nor hanging fire; its charge could not in any manner become deranged; and as it was impossible to load accidentally with two or three cartridges, the accidents resulting from such circumstances were prevented. The priming being moreover inflamed inside the barrel, neither the fire nor smoke resulting from it affected or deranged the person firing, who was thereby enabled to aim with more precision and observe the effect of the shot. The necessity of a ramrod, either for the charge of powder or the shot, was also obviated, since both charge and priming were placed in the breech at the same time. It was a smooth bore.

The chief disadvantage in this system even as applied to a sporting gun, and therefore in a greater degree to a military arm, was the serious danger of the constantly primed cartridge in the rosettes which contained the percussion medium. M. Roux, the successor of M. Pauly, made a slight improvement to this system by substituting the capsule for the fulminate of mercury in powder in the rosettes affixed to the cartridge; but in this also the same defect of a constantly primed cartridge existed. M. Pichereau, who succeeded to M. Roux, changed the whole system. He wisely suppressed the rosettes entirely, and all *interior* inflammation of the charge, by substituting the exterior nipple of Deboubert, (1820,) upon which his improved caps were fixed at will. This important change in the mode of ignition approached the BREECH-loading system or Pauly nearer to the modern percussion gun, which was fast superseding the flint shot-gun with sportsmen.

Several other improvements were made to these arms by M. LEFAULCHEUX, who in turn succeeded to M. Pichereau, which rendered them more convenient and more simple; but from Pauly's primitive invention up to the latest improvements then made, a very considerable inconvenience had not yet been remedied. This was, that after firing a certain number of shots, the moveable breech gathered interiorly so much deposit from the combustion of the charge, that it could with difficulty be raised to reload, and not unfrequently, at the risk of breaking it. This was for a long time, and is yet in part, one of the great objections in the mechanism of many modern breech-loading arms, to be obviated alone by an improved and more perfect mechanism, closing it so hermetically as to prevent all escape of gas.

This was subsequently effected in a great degree by M. Lefauchaux

himself in his hinge breech-loading arms, a resuscitation also of the principle of a sporting fire-arm of the sixteenth century, of which in 1854 we met with and examined a very rare and interesting specimen, in a collection of ancient arms at Brussels, belonging to a Russian nobleman, and brought to that city for public sale. In the beautiful illustrated catalogue of that remarkable sale, it was also depicted. This bore the date 1675, and the name Adam Flèche, A.V. Bergers; the lock was a flint lock, the barrel six-grooved, and the workmanship throughout very superior.

The mechanism of this ancient arm is very ingenious; the barrel opens and drops at the breech by means of a strong hinge or pivot pin working on small rollers, and is closed by a stop with two bents or notches moved by a spring; the charge is placed in a metal tail-piece, which adapts itself to the bottom of the breech of the barrel, this tail-piece is furnished with a pan that serves also for the introduction and withdrawal of the tail-piece, by itself sliding into a groove on the right side of the barrel along the breech; in fact, the arm itself is as simple, if not more so, as in that of our modern guns on this principle, without exception even of the Lefaulcheux, which evidently was established after some similar model.*

By means of the improvement made by Lefaulcheux on this principle, the difficulty of opening the breech when fouled in Pauly's gun was obviated; for in the former the breech is opened at all times with facility. The lock is the usual percussion lock, but the stock has neither forehand nor middle part. The barrel Fig. 1, Plate 2, (c) has a powerful hinge at (b.) connecting it with an iron-piece called the key, which serves as base to the breech. At (f) are two hooks into which the under bolt band catches. The cartridge is provided with a thin copper undersheating which prevents the gas from escaping. The whole gun is two pounds lighter than the ordinary percussion gun, The solidity with which the key closes the barrel and secures it to the stock is very great, and it joins the barrel to the breech in such a manner as wholly to prevent that escape of the gas of the charge, which existed in all other breeching loading arms. Up to the present day, though a variety of modifications have been produced in France and Belgium in breech-loading arms by several eminent gunmakers, and especially by Montigny of Brussels, the Lefaulcheux gun is pronounced both by sportsmen and gunmakers of high repute and

* In 1822, an ancient Italian specimen of a breech-loading smooth bore fire-arm of very beautiful workmanship, was catalogued under the No. 865 at the Royal Military Repository, Woolwich. It loaded by a lifting valve, and the ammunition was inserted through the *butt*. It was afterwards removed to the Tower.

practical judgment, to be superior as a breech-loading shot-gun to all its competitors, and has latterly found some favour in this country.

In 1830, a wall or rampart gun was introduced in France upon the breech-loading principle, which though from 18 to 20 lbs. weight, was used before Antwerp and at Algiers with some success.

The barrel of this wall piece of the length of 50 inches, was rifled with 12 grooves, and fired balls of from $1\frac{3}{4}$ to 2 ounces. The breech chamber on being lifted up permitted the insertion of the cartridge, when the breech chamber was pushed into its place, and by means of a moveable nut near the hinge, it was brought into immediate and firm connection with the barrel, rendering all further displacement but by the hand impossible. At the point of the centre of gravity of the piece, a pivot hinge connected a short rest or crutch to the barrel, which broke the recoil, and on the neck of the stock the piece was strengthened by an iron plate. The residuum from the powder, combined with the splinters from the stripping of the balls, were found nevertheless to obstruct this mechanism considerably, and after fifty shots it was necessary to clean the gun.

In 1831 ROBERT of Paris had also produced another breech-loading method applied to sporting guns. The Robert gun has neither lock nor ramrod (and procured for its inventor in 1834, the gold medal from the society for the encouragement of the arts. It differs from the LEFAULCHEUX gun in many respects; the barrel and the stock remain *constantly connected*; the breech opens by means of a lever (*a*), Fig. 2, Plate 2, which on being lifted, presses down the mainspring simultaneously, which performs the part of the hammer (*b*), until it moves forward and catches under a triangular spring, that serves at the same time as sear spring and trigger. The cartridge is provided with a priming cylinder that requires some care in the carriage; upon placing this cartridge in the chamber, so that the little cylinder projects at (*d*); on lowering the lever the loading is not only effected, but ready to be fired, when upon pulling the trigger, the hammer (*c*) falls on the priming cylinder. This gun had the disadvantage of being difficult to put at the repose or half cock, when it had been once put at the full bent.

In the same year also Ackerstein in Sweden, took out a patent for a breech-loading arm, with a mobile stock, in which for the purpose of cleaning the gun, it is necessary to draw one screw only.

The above cited first modern European* resuscitations of the

* Throughout India and China the breech-loading wall piece, or jinghal, was and is a fire arm of hereditary and constant use, but exhibited, as it still does, no improvement in the mechanism of the breech, which remained the same as had been transmitted

breech-loading principle of fire-arms formed as it were the dawn of the new era, which in less than forty years was to break upon the long torpid art of gunmaking, and concurrently with its twin brother and rival principle the revolving chambered-breech, was by the aid of a new medium of ignition to more than realise the aspirations of those early craftsmen of whose creative genius every collection of ancient fire-arms furnished the unacknowledged types, on which to graft the shoots of the tree of modern mechanical science.

The modifications upon this principle which have since made their appearance in Norway, Sweden, France, Germany, America,* Belgium, England, and Spain, may almost be expressed in the word legion; for to this kind of fire-arm in particular, the ingenious of our day, under more favouring circumstances than in the olden time, directed from the first, and still direct their attention.

Possessing or assumed by their authors to possess some special advantage and superiority, they have as a matter of course, nevertheless, with a few rare exceptions only, some special and characteristic defect or other; and, from comparative trials of their merits that have been instituted, their competition for public favour and military use, bids fair to resolve itself into so narrow a circle, that few of them will attain any footing in the former, and but one, we think, hereafter to be described, is eventually likely to establish itself in this country as an arm for special corps of light troops.

From Norway, as adverted to, where, as in Sweden, a close attention had been for some years addressed to improvements in small arms and artillery, we may, to speak in chronological order, date the next leading effort in resort to this principle of construction, which further modified by M. de Feilitzen, an officer of the Swedish navy, and adopted in that service, gave the key note in 1835 to the gunmaker Dreyse for the establishment of the celebrated Prussian needle musket, subsequently perfected by Klein.

Carrying out Pauly's idea of a central ignition of the charge and the unity of priming and cartridge (objectionable as was the latter combination for transport and general military use), the Norwegian and Prussian needle rifles presented a mechanical structure of breech of a wholly novel and ingenious design.

through centuries of use, and is doubtless the early type of the form known in Europe in the first days of the art. May it not have found its way thither from the East, as had the greek fire, and eventually gunpowder itself?

* In the United States alone, so general has been this direction of the attention to the production of breech loading arms, that, as we were informed by a gunmaker of the Union, it occupied a friend of his a whole day in the investigation of the patents at the Patent Office having reference to arms of that kind.

In this system, the friction caused by the smart puncture of a steel rod or pin, fitted concentrical with the axis of the barrel, in the socket of a trellised spindle, by which it was driven into the centre of the fulminate priming attached to the base of the cartridge, effected what hitherto had been done in all modern breech loading arms, except that of Roberts, by the concussion of the hammer on the capped nipple. The latter were therefore wholly omitted; the greater issue of the powder gases through the vent obviated, a more vivid concentration and diffusion of the jet of flame of the priming effected in and through the charge, and the facility of a *multiple fire* established.

Despite the somewhat complex and delicate structure of the mechanism of this arm, which not unfrequently after much use exhibited a derangement or rupture of the needle that rendered it useless; despite also the ungainly form of the obtrusive knob of the lever, by the action of which the trough of the breech of the barrel was opened to receive the cartridge, and reclosed to give fire by the action of the trigger upon the sear, working in the posterior end of the spindle—together with the unsightly yawning of the cut-a-way trough in the barrel itself, which prejudicially reduced the length of the barrel passed through by the projectile; the needle system found great favour with the gunmakers of Germany,* who in emulation of each other directed such attention to the improvements of the several parts of the mechanism, that of all the breech-loading arms which had hitherto appeared, it was *the first* that acquired admission to the rank of a *military fire-arm*, and became adopted in several regiments of infantry in the Prussian army.†

Though favoured with the usual amount of depreciation bestowed upon every attempt at further innovation in the arm of the infantry soldier, its declaimers, no where more numerous, among military men and gunmakers generally than in this country, were soon to be rebuked by the results of the practical war-application of the needle rifle in the hands of the Schleswig-Holsteiners, in their struggle with the Danes, 1848-49, and in the Prusso-Baden campaign.

On those occasions, and especially at the bloody battles of Kolding, Frederica, and Idstedt, in the former war, the needle rifle in the hands of the insurgent Jägers told fearfully on the Danish ranks the

* At the Great Exhibition of London in 1851, a finely finished specimen of the needle rifle, of greatly improved breech structure in all its parts, of seven barrels, was contributed by Teutenberg of Hustedt.

† This was we believe Klein's improved pattern.

fallacy of the English military authority who had derided the *breech-loading principle* as inapt to a military fire-arm—"because the soldier being thereby enabled to fire more rapidly, would as a sequiter squander his ammunition, and find himself bereft of it at the moment when he most needed it" *

It was, nevertheless, from the needle musket, a yet imperfect phase of the breech-loading principle, that the cherished maxim of military routinists, the "noli turbare circulos meos," received the rudest shaking it had yet sustained; but which with the few who, less wedded to the forms of the past, had faith in the signs of the times established the conviction which has now gained ground so widely, that the prospective and very possible improvement of breech-loading arms, in combination with the concurrent and equally startling improvements making in muzzle-loading rifles and projectiles, would realize that revolution in the arms of the European infantry soldier, the organization of infantry, and the modern art of war, so derided as an absurdity by some of our veterans of the Peninsula campaigns and their congeners elsewhere. There were however not wanting other more perspicuous professional minds in Germany and France, who had also passed through the baptism of fire in the Napoleonic wars, and who with that distinguished Prussian soldier and writer, Brandt, as presciently foreshadowed the coming change as they had pointed out its requirement.

The detractors of the Prussian needle musket were also to receive a further positive and official negation to all their assertions of the *unfitness* of this arm for military purposes—of the necessity it had entailed for the abolition of "file firing" in the Prussian ranks, and of its subsequent abandonment by the Prussian military authorities. For, during the height of the Crimean war, when circa £200,000, i.e., 1,000,000 thalers more than the preceding year, were voted for the supply and repair of small arms, the manufactories for the production of the needle musket were ordered to be considerably enlarged, so as to turn out increased numbers of this arm in a shorter time; and all the percussion muskets in use and in store were ordered to be converted into Minie rifles; while for the practice and training to the use of both, imitating like ourselves the French schools of musketry, new practice grounds suitable to the longer ranges attainable by both these arms, were laid out.

* By the same authority it was also asserted, that such was the perfection of artillery fire with shrapnel or spherical case shot (though the calmest practice on Woolwich Common contradicted such perfection) that no isolated skirmishers with the improved rifles could keep their ground against field batteries!

Of the breech-loading principle it may as truly be said as of the rifle-loading at the muzzle, the varieties which have appeared within the last few years as representative of their respective systems, are so numerous that it would occupy a volume of no small dimensions to describe them.

In almost every country of Europe, and in the United States concurrently, a remarkable attention and development had been given to the mechanism of breech-loaders; and, like every other striking innovation which, even in this age of changes, has disturbed the established ideas or the private interests of those who would ever cry "let things be as they are," they have been denounced on the one hand with as little reflection and capacity to judge, as on the other they have been larded with hyperbolic praise.

The dispassionate comparison of the advantages and inconveniences appertaining to breech-loading fire-arms generally, is rather therefore the chief desideratum, and one in which on public grounds, both animadversions and eulogy should be restricted within the just bounds of truth and fact.

According as the system may be on which they are established to open and close at the breech for the reception and the ignition of the charge, they of course exhibit more or less complexity in the mechanism of the lock, and present in the same ratio more or less safety and efficiency in their use. Those combining therefore, with the least complexity, the general and known requisites of a good fire-arm, are of course to be preferred.

The kind of breech-loading shot gun which has found most favour with sportsmen on the Continent, and been hitherto there considered the most preferable, by men of practical and mechanical judgment, are those which open and close *underneath*, upon the Lefaulcheux system, which has received some ingenious modifications from the M. M. Beringer of Paris, and Loron of Versailles, but especially from M. Bernimolin of Liège. While those of the kind which *open above*, and which had their first types in those of Pauly, Perrin Lepage of Paris, and Montigny of Brussels, though not wanting in solidity, have been found, especially the latter, to inspire many sportsmen with a certain uncontrollable misgiving, lest some luckless day on bringing the piece to the shoulder, the lever of the mechanism should carry away part of the jaw after the discharge.

In the shape of sporting or smooth bore guns, none that we have seen or know of, have a greater nor so great a range as the ordinary well constituted shot gun, but it is said they mass the charge of shot better, and have a more regular fire. In arms of this kind, small

bores would appear most appropriate. Furthermore, breech-loading guns have indisputably many considerable advantages over the ordinary gun. They are more easily and rapidly loaded, and without the noise and movement which in loading the latter tend so frequently to alarm the game, and occasion both loss of time and opportunity to the sportsman. Herein the reader will doubtless be impressed with the somewhat near approach to the re-acquisition of that quality which upwards of two centuries ago Espinar bewailed the loss of, in his comparison of the respective merits of the crossbow and the fire-arm (cited at page 23), and in which he assigned to the former the indisputable superiority as a sporting arm, by reason of the *less noise* made in its use.

In the use they are also cleaner for the hands of the fastidious, neither do they lead nor foul till after an exceeding number of discharges. They are speedily cleaned, and there is no difficulty in withdrawing a charge one does not feel disposed to fire to the winds.

Their inconveniences on the other hand may be summed up as follows. Having for the most part specially made cartridges adapted to their particular system, it is not unfrequently necessary for the sportsman to make them himself; though the means of procuring special cartridges for the different systems of breech-loading arms at present in vogue in this country, is greatly facilitated by the manufacture of the former by Messrs. Eley and others, from whom the gunmakers throughout the country obtain a ready supply; yet, for use out of England, or at a distance, a deficiency may occur. When purchased also ready made, they may be either too weak or too strong, though the latter perhaps rarely. If, moreover, the cartridges have been long made, they lose somewhat of their strength, and should they have contracted damp, the powder not unfrequently binds and forms one mass with the shot charge, on any displacement of the wad, and the fire of the piece is greatly prejudiced, so that after the report, away goes the bird unscathed. Some of these guns, furthermore, do not present that solidity of the breech which is indisputable to obviate accident, and if, in the hurry of loading, a cartridge should become torn, the grains of powder are liable to get into the joint and interstices of the breech base, and become for a time an obstacle to the ready use of the arm.

By the way, we may perhaps here adduce a just remark we have heard made by the friends of their old servant, the percussion shot gun:—"I am exposed to none of these inconveniences; whether it rain, blow, or snow, my powder is always dry in its flask; if a larger kind of game shew itself, my shot pouch enables me immediately to

increase the charge, and I am never obliged to fire at a wild duck with a cartridge fit for snipe only."

As the object kept from the first more especially in view by the French and Belgian gunmakers, in their efforts to improve the mechanism and method of ignition of this system of gun, was more especially the production of a double shot gun for sportsmen, and not a military arm; and as, to do them justice, they first succeeded in effecting this object at a price not exceeding that of the ordinary percussion double shot gun, some succinct description of a few of the best, based on the Lefaulcheux system (opening and closing underneath), which, after being much pooh-poohed by English gunmakers, has nevertheless been recently acquiring much favour among English sportsmen, may not be unacceptable to those as yet unacquainted with them.

The idea conceived by M. Loron of Versailles to use the cold-beat copper base to the cartridges for his gun on this system, gave thereto for some time a special advantage: but the Messrs. Chaudun and Palmer of Paris suggested in turn the use of their well known "culots à brochette," which equalised the advantages for the original Lefaulcheux.*

Béringer of Paris, under his patent for improvements on this system, produced likewise a shot gun of considerable merit. His cartridges are also metallic, with interior priming. The joints of intersection of the breech permit of no escape of gas, neither does it become dislocated by a constant use. The breech always retains its polish. The cartridge, made of very thin copper, preserves the powder dry in all weathers, and the priming, being in the interior of the cartridge, cannot get wet though immersed in water for several hours. The same cartridge may be used twenty times, and the sportsman can re-load it as he would an ordinary gun. The priming, being circular, has the advantage of enveloping and igniting the whole of the powder charge instantaneously, giving it a promptitude of fire which few cartridges applied to these arms possess. The Béringer breech-loader admits also of being loaded with a ramrod and the ordinary priming, the same as any other percussion gun.

In the breech-loading shot gun of M. Bernimolin of Liege, that eminent manufacturer, by a happy appropriation of the best elements of each of the various French and Belgian systems, produced in 1853 a new arm, which soon took a front rank place with the best of

* From experiments made with the copper cartridges of M. Palmer of Paris, it has been proved that many hundred shots may be fired with them before they become unserviceable: they load in the same way as the ordinary gun, so that the sportsman is never at a loss to reload them.

them. From the Lefaulcheux he took the method of closing, and retained the lock mechanism of the ordinary percussion gun, with this difference, that the cocks serve no other purpose than to facilitate the play of the tumbler to cock and uncock the gun, on the same principle as in the Béringer pistol; the barrel, together with the mode of loading it, by means of cartridges with metallic bottoms, is in imitation of Loron's idea. The direct ignition at the axis of the bore of the barrel, as in Robert's, Montigny's, and Loron's guns, is effected by the disengagement of two small metallic stems, acting as hammers upon another stem affixed to the base of the cartridge, and on which the cap is placed; the jet of flame from which comes consequently into immediate contact with the charge of powder.*

For those who would use the copper culots to the best advantage, and ensure their lasting a long time, it is necessary that they should be fitted carefully in the chambers of the gun, otherwise they are soon rendered unserviceable. It is also indispensable that they should be carefully and promptly cleaned; which is done with a mixture of three parts of soft water and one of sulphuric acid; in which they should be immersed for about half an hour, and then well rinsed in pure water and wiped very dry. Strong pure vinegar may be used where the sulphuric acid is not at hand, in which case an immersion of two minutes will suffice. Neither oil nor grease should be allowed to come in contact with them, as these produce a verdigrise on the copper.

While the gunmakers of France and Belgium had more particularly directed their attention to the construction of an efficient sporting breech-loader, those of Germany and the United States, followed in quick succession by those of England, in emulation of each other, addressed their ingenuity to the production of breech-loaders for the more serious game of war; and taking advantage of the assiduous labours of the military commissions in France in prosecuting improvements in the muzzle-loading rifle, and in the study of elongated projectiles, a like success has been achieved in the production of some very formidable military breech-loading arms.

In this place, previous to entering upon some detail of the latter, we will advert in passing to a military breech-loading arm of considerable merit, which owed much of its origin to the special attention directed to its production by the Emperor, Louis Napoleon.

As an artillery officer, the present Emperor of the French had

* A special advantage in M. Bernimolin's modification was perspicuously sought for in the establishment of the faculty of a duplex service, viz, that though loading at the breech by means of cup or metallic bottom cartridge, this gun, in the event of these failing, could be used like the ordinary gun.

devoted himself with predilection to a serious study of the artillery science, and the mechanism of every description of small arms. To this predilection the military world is indebted for the "*Etudes sur le Passé et l'Avenir de l'Artillerie*, a work of distinguished professional merit; by the production of which the solitude of the fortress of Ham became at one and the same time less irksome to the illustrious captive and useful to science.

Both as a skilful theorist and able practician, following with deep interest every effort of the day tending to develop the improvement of the different branches of his favorite study, no one can well be supposed to have been more impressed with the importance of the military results obtained by the improvements in the arm of the infantry, which in the hands of the Chasseurs Bataillons of the French army had rendered them the theme of general admiration.

Having himself conceived a new system by which a certain equilibrium might be established for the cavalry arm, he was desirous to see it realized; and in the summer of 1854 the attention which the Emperor had directed to the production of a breech-loading fire-arm for cavalry use resulted in the construction of the rifle or "fusil-lance" of the Cent Guard.

Guided by the suggestions of the Emperor, the Commandant, Treuille de Beaulieu, director of that department of the manufacture of small arms which relates specially to the production of rifled arms, under the designation of "L'Atelier des armes de Précision" of the Board of Artillery, succeeded in establishing an arm fulfilling all the required conditions, and which as a cavalry fusil presented incontestable advantages over all hitherto suggested in France on the breech-loading principle.

As prescribed by the Emperor, the "fusil-lance," or, as it would be Anglicised, the lance-fusil, loads at the breech, and the barrel is rifled. The mechanism of its breech structure is remarkably simple. The whole system of the lock being constituted of three limbs or pieces only, simplifying greatly the keep in order of the arm. The mainspring, and in fact the only spring of the lock, is external; so that its condition can always be ascertained without taking the lock to pieces.

The manual of the arm consists simply in a pressure of the thumb upon the trigger guard, which opens the breech and cocks the rifle, when the cartridge is inserted and the piece ready for immediate discharge. Like ordinary sporting and military arms, it has a half-cock bent.

The effective range of this breech-loader is the same as that of the

Chasseur's Rifle (the pillar breech), viz., 1200 metres, at which distance the velocity of the projectile is the same for both, i.e., about 100 metres per second. But on issuing from the lance-fusil, the projectile passes over 400 metres in the second, while the initial velocity of the Chasseur's rifle is but 200. The degree of rotation of the former projectile is 500 turns per second up to 600 metres. The precision of fire of the lance-fusil is superior even to that of the chasseur pillar breech arm; and, from the simplicity of its manual, six shots per minute can be fired without hurry.

The recoil of this arm is very slight. It is loaded by means of a cartridge having the priming attached, resembling somewhat the Gevelot cartridge for shot guns, which cartridge serves alike for the cavalry pistol on the same system, and of the same bore; the range of which is 800 metres, or that of the first graze from a French 8-pounder field piece.

The length of this cavalry breech-loading rifle—for in the usual English acceptance of the word (though not a correct one) it cannot be called a carbine—is 1 metre 50 centimetres = 4 feet 10½ inches, at the extremity of which may be fixed at will (in the manner of a bayonet) a straight lath-like sabre, channeled throughout its whole length of 3 feet 3¼ inches, giving to the whole weapon the length and appearance somewhat of a lance, whence we presume the name "Fusil-Lance." The gauge of the bore of this military breech-loader is but 9 mille-metres, or $\frac{3}{8}$ of an inch, being the half of that of the Chasseur Rifle; the charge is 2 grammes only, 46 grs. of powder, that of the muzzle-loading arm 4½ grammes. The projectile weighs 11 grammes only, 253 grs., while that of the chasseur's arm is 48 grammes; so that under a like weight, 3½ times as many cartridges can be carried as by the chasseur.

Detached from the fusil, the sword is easy to handle, of a light and elegant form, retaining its resisting powers at the back and the edge of the blade.

Before we conclude our citation of the most interesting productions of this type of fire-arm on the Continent, we must advert to that of M. Francotte of Liege, whose repute for the manufacture of military arms, and especially for that of *the* Minie Rifle-Musket,* the patent and special rifling machinery for which are his property, made in 1854 the nearest approach to that desideratum in a modern military musket—the duplex faculty of loading both at the breech

* We designate this rifle thus emphatically, from the early acquired and still existing error in this country, to designate every rifle firing an *elongated projectile*, the "Minie Rifle."

and muzzle—which had yet been effected. The necessity, nevertheless, for the resort to a projectile of two different sizes to meet both views, remains we believe still to be overcome. This breech-loader fires by the cap and nipple, opens and shuts by means of a lever like the Prussian needle gun, with the exception that the Francotte lever acts above and behind the lock.

The patented systems of the breech-loading arm of English design and make, that have obtained most attention, are, as we remarked, for the most part, if not all of them, more especially intended by their authors as types for military use. To describe them all would be a task indeed, and as several are already sinking fast into oblivion, neither a very serviceable nor agreeable one. But illustrating the sportsman's adage that "there are good greyhounds of every colour;" of the number also, there are some few which bid fair to keep a certain position, and one which as a fire-arm will rank A 1 for a long period to come, even though it may not as yet have succeeded in winning that official assent of appreciation which servile custom with us has most erroneously constituted the great criterion for merit in all things; but which, by a reversion of the natural order of things that had long become and yet remains somewhat natural to us, must be caught up or inspired from the subordinate off-sets of the Barnacle family before its CEdiles may safely stoop to evince the competency of judgment. But it is not our intention to enter upon a discussion as to which is the best, the muzzle-loading or the breech-loading fire-arm, because elsewhere than in the narrow circle adverted to, judgment has been pronounced; and it has been for some time generally admitted by distinguished service officers, men proficient in the art of war, and well cognisant of the numerous kinds of service connected therewith.

In a word, if one be better suited to bayonets, and those "great bataillons" which we have been long told are most favoured by the God of Battles, the infantry of the line, the other is susceptible of most advantageous use as the arm of special corps, tirailleurs, light infantry, foot artillery, cavalry, &c.

As a matter of course, in the first stages of modern improvement upon the breech-loading system, the results were not and could scarcely be as satisfactory as contemplated by those who devised them. That it took nearly four hundred years to produce the muzzle-loading Percussion gun might with some reason have been adduced to soothe the feelings of each who affirmed his breech-loading type to be the *non plus ultra*; but at the same time it should have been remembered that the former was not much the elder effort of

the two, and that as the one had actually been found so susceptible of improvement, there was no mechanical law to prevent the other evincing the same adaptability to the new agent of ignition.

We admit, that mature deliberation and a lively solicitude for the public interests were eminently necessary in the European Commissions of Artillery delegated to watch over these things; and it has been well that these have known how to resist all enthusiasm in a matter that required the exercise of a cool judgment to defer their veto until the evidence of better results. For, on the one hand or the other, some defect made itself apparent; it was either an escape of gas, a complication of mechanism, or a construction of cartridge, which forbade the adoption of the system presented. And it must not be denied, that the perforating needle, the primed cartridge, the metallic bottom, stems, &c., &c., are so many defective appliances which are inadmissible to an ordinary musket.

Restricting ourselves for the reader's sake to a simple nomenclature of the most known English and foreign types of this system, at the close of this part of our subject, we will here address our attention to the military breech-loading rifle on the principle invented by Mr. Prince, the arm we adverted to (page 171), which may justly be pronounced the most successful effort at a just conception and combination of the elements of simplicity and solidity in a breech-loading fire-arm that has yet appeared, whether in Europe or the United States. In the mechanical principle of this arm, he has at one and the same time evinced as happy a comprehension of the object desired as of the means by which to achieve it; and to him must be accorded the merit of being the first and only one who has approached that perfection in the breech-loading principle which had appeared almost hopeless of attainment. In the expression of this opinion, we are not merely pronouncing our own, but that of several eminent practical gunmakers, both foreign and English, as also the *viva voce* sentiments of several service officers, French and English, practically cognisant of fire-arms, and highly competent to judge of the merits of Mr. Prince's production to establish itself as a sound *military type* of the breech-loading system.

In outward appearance it bears a strong resemblance to an ordinary gun, a circumstance of form which, combined with its other structural features, will be no small recommendation in the eyes of those who find a cardinal objection to all fire-arms that deviate in externals from those they have been accustomed to, especially as applied to military service.

Like all things constituted of simple elements, the breech-loading rifle of Mr. Prince is clearly described in a few words.

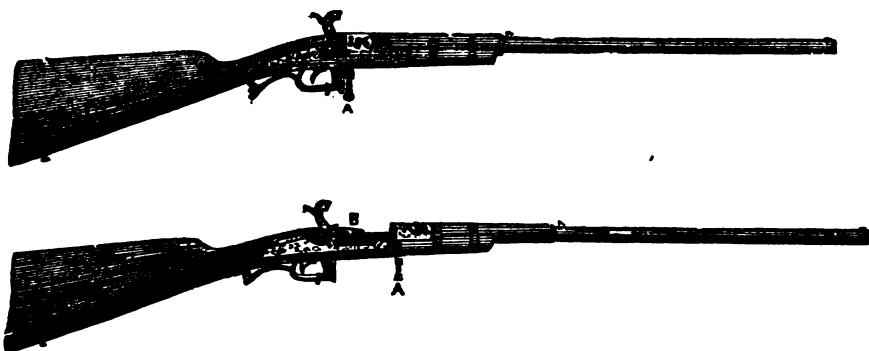
Its chief structural difference with the ordinary gun lies in the form of the breech-plug, and its mode of adjustment to the barrel. The plug in the former is *conical*, having a steel pin drifted into that part of the cone that enters the breech of the barrel, forming the *segment of a screw*, instead of the full thread cut in ordinary breech-plugs. The steel pin adverted to, enters into corresponding inclined slots cut out of the breech of the barrel, when a slight turn of a lever jams the two cones, by means of the inclined planes on the steel pin and the cross slots in the breech of the barrel, producing a mechanical result like the biting twist of a stopper in the neck of a bottle. A corresponding movement effected by the lever, frees the barrel from the breech-plug, which is itself a fixture, and forms one piece with the ordinary strap through which the breech pin is inserted. This permanent fixed plug is therefore a cardinal feature of no mean consideration; for the gun is thereby constituted as sound and solid as an ordinary muzzle-loading fire-arm, and presents therein that fundamental condition of strength of breech which the experience of centuries has established as the indispensable elementary principle of structure in all fire-arms. This prominent feature in the mechanism of the breech of Mr. Prince's rifle, has acquired for his system the approbation of many of the most skilled practical gun-makers of the day, who, superior to those petty influences of craft-jealousy which once were so general, have conscientiously subscribed to its singular merits, as beyond comparison the best yet resorted to, and free from those practical objections which existed in all breech-loading arms hitherto produced.

Fired by the hammer and nipple, like the ordinary percussion musket, Prince's Rifle, having some analogy with the Prussian Needle Gun and M. Francotte's, opens and closes by means of a lever underneath and in front of the trigger guard; this lever pushes and draws back the barrel, which disengages itself from and re-imbeds itself on the breech. Adapted to the trigger guard is a small safety bolt, which prevents the lever from moving from its position when the gun is closed.

The directions for use, or the manual of this arm, are simply as follows:—after discharging the rifle, the left hand need not be moved from its position. On taking the rifle from the shoulder, half cock it; then place the butt under the right arm, and press the side of the guard with the fleshy part of the thumb, the second finger overlapping the knob of the lever, and drawing it to the right, the

barrel can then be pushed forward. After inserting the cartridge, draw the barrel upon the plug by placing the ball of the thumb on the inside of the trigger-guard, and the fingers round the lever. A slight tap on the knob of the lever with the palm of the hand then drives the breech into its proper position.

The diagram below will afford the most approximate idea of the principle and structure of this arm.



A The lever by which the barrel is moved forward.

B The cone, equivalent to the old patent-breech when the barrel is returned to its place and fixed by the segment of the screw.

From this extreme simplicity and strength of structure, it is admirably adapted to withstand that exposure to wet and rough usage incidental to military fire-arms, a faculty by no means equally possessed by any other of the existing breech-loading arms, whether of American or European origin ; while the cartridge used, partaking of the same simplicity of structure, and made of a waterproof yet highly comburative paper, contributes to its efficiency, giving a greater spontaneity to the evolution of the powder gases, yet leaving no residuum of its own behind.

Though a cartridge composed of so inflammable a paper may be advantageously applicable to the use of the sportsman, and no less to that of light troops armed with such a rifle, yet for their necessary transport in quantities as munitions of war, it would doubtless be considered dangerous, from a too ready susceptibility to take fire from any of the causes incidental to the transport of ammunition.

But the cartridges to these arms may equally be made of any ordinary paper, and used for a considerable time without inconvenience ; and in the want of all made cartridges, a spherical ball may be placed in the barrel, and discharged by a loose charge of powder from a common flask as from ordinary guns.

With mechanical elements so simple, the system of Mr. Prince renders it moreover readily applicable, and at small cost, to all arms now in use in Her Majesty's service. As far as the service qualities of this system are concerned, the official trials made of this rifle have been as satisfactory as the inventor could have desired; and whatever may be the present obstacles or influences which stand in the way of its adoption on trial into some special corps in the British army, there can be no doubt that, in common with all practical truths, it will eventually make its way, and assume that position which it is so eminently qualified to take as an unexceptionably efficient service arm both for light infantry and foot artillery, as a rifled musket—and for cavalry, as a carbine. In one of the early trials (1855) made before Colonel Hay at the Hythe School of Musketry, a carbine of Mr. Prince's was fired in competition with the Enfield Rifle, 50 shots being fired from each at 300 and 600 yards respectively. At the latter distance a private soldier shot both guns, and Serjeant Hines of the 90th at the shorter distance. At the longer range, the shooting of the two arms, despite the greater length of barrel of the Enfield Rifle was about equal, Prince's Carbine striking the target 48 times, the Enfield 47, out of the fifty shots. Though a strong head wind blew at the time, scarcely a shot fired but would have told on a small detachment of men; while, at the 300 yards, the accuracy of fire from the carbine was greatly superior to the Enfield, every shot from the breech-loader, inclusive of 17 bull's eyes, being within a radius of 3 feet diameter, and those from the Enfield within 6 and 4 feet.

By way of comparing the relative faculties of the two arms in the matter of rapidity of fire, Serjeant Hines then fired the Enfield Rifle for 15 minutes successively, loading and firing as quickly as possible. 35 shots were thus fired from the Enfield, all striking the 6 yard-square target, but variously distributed over the same. Mr. Prince himself then loaded and fired his breech-loader for 5 minutes only, taking time for a much more deliberate aim than Serjeant Hines with the Enfield, but in that 5 minutes he delivered 24 shots, every one of which would have struck the figure of a man. To make up the number of 150 rounds, Mr. Prince then fired from a rest at 200 yards, to prove that neither quick firing, nor the carbine remaining uncleaned, detracted in the least from its shooting qualities.

Tried again before Sir Thomas Maitland, on board H.M.S. *Excellent*, at Portsmouth, on two successive days, Mr. Prince's carbine was fired with the same successful results, without miss-fire or stoppage of any kind. Upon this occasion, the superior efficiency of Mr. Prince's

cartridge was also put to the test in two muzzle-loading rifles. Several of these were immersed in water for some time, and then placed in the gun entire: ignition was invariably produced, and very good practice made at 1200 and 1000 yards. At the latter distance, the 5-foot target was struck the very first shot.

In order to facilitate the construction of this rifle in a great measure by machinery, so as to permit of its being put out of hand with that speed which has now become one of the requirements for military arms, in order to ensure an undeviating similitude of dimensions, &c., &c., in all their constituent parts, and thereby obtain their speedy finish for adjustment or for repair, Mr. Prince has still further simplified several labour details in the mechanism of his arm; and, since the above-cited trials, every subsequent test, both private and official—many of which have, as of right, been most severe—have invariably been attended with the same success; neither impediment in the action nor break-down in any part having occurred. From the structure of the cartridge adverted to, being rendered a self-cleansing fire-arm, its shooting precision is unimpaired by any number of discharges, and instances have been frequent where, after the previous firing of 150 rounds—a considerable portion of which, to show its rapid faculty of loading and discharge, had been delivered at the rate of 5 to 6 shots per minute—5 successive shots have been fired from a rest (a mode of firing in which the vibrations of the metal are always considerably stronger than when fired from the shoulder) at 200 yards, when the operator put every ball into a 9-inch circle.

Tested by Mr. Blissett of Holborn, an impartial and most competent judge of fire-arms, after a similar number of rounds fired by him in quick succession, he found, as he asserts, the action of the principle not only as good as at the [first shot, but, after leaving the gun uncleaned for twice 48 hours, he found it still as ready for use and free in action; and, on wiping it out, found an insignificant amount of powder stain only, which, without any cleaning, would have impaired in nothing the shooting qualities of the arm. With results such as these, when addressing the inventor, on the subject, Mr. Blissett concludes his testimony to its merits in the words—"I hold your gun to be the best breech-loading gun by far that has been made. I think it excellent in principle in every way."

Tried, Nov. 1856, at Brussels, in the presence of Baron de Gaugler, an ex-Crimean officer of the Chasseurs de Vincennes, and several others of the Belgian "Regiment d'Elite," a military rifle and carbine of Mr. Prince's obtained the unreserved approbation of all present.

At that trial it was demonstrated, that the manual of such an arm was so easy, that the soldier of the least intelligence could immediately acquire it. The fire of the arms adverted to was rapid, and shewed great accuracy and range. One of the cartridges which on this occasion had been immersed in a glass of water for three quarters of an hour, burnt with the same rapidity as those which were dry. The recoil of both was very slight, and pronounced incomparably less than that of the pillar-breech rifle and others of the new military muskets. On this occasion, the carbine of Mr. Prince was affirmed by the officers present to be the best adapted for the use of cavalry of any yet produced.

We understand that a further competitive trial of Mr. Prince's breech-loader, at the Hythe School of Musketry, in the present year, against the best of the American and English types, resulted in a further confirmation of its superiority ; and the time is, doubtless, not far distant, when it will assume that place as an approved arm in the British service, which for a time the American carbine of Sharp had apparently taken.

Previous to closing this part of our subject, we cannot refrain from a few reflections in reference to the future of this type of fire-arm, which, in its progress to improvement in our day, has met with more opposition than did even the improvements in its muzzle-loading rival ; and that, of a surety, was sufficient to quench the creative genius and faith of no common mind.

Long range and precision of fire, as desirable qualities for the soldier's musket, had eventually succeeded in becoming a permanent conviction ; but from a sense only that those who should most pertinaciously adhere to the "proved efficiency" of the old-established though already much modified favorite, might perchance pay a serious penalty for evincing so much firmness. Long foreseen by moderate military judgment, the old stiff clip-clap system of Linear-fire tactics, was, at last, not only seriously assailed, but doomed to become soon a thing of the past. Its tenacious representatives, and their obsequious adherents, already unforgiving at the irresistible second established innovation, turned their ire and derision, with the fitfulness of an expiring energy, upon the presumptive breech-loader ; and much less of good common military sense, than of irritable weakness, was evinced on the subject where least anticipated.

Yet, if a justification is to be found for deducing tolerably correct inferences of the value of things and ideas from the facts not only handed down historically, but still extant among us in the material form, or type ; another faculty—*multiple fire*—was one as anciently

deemed a desideratum, as long range or precision ; otherwise, with these, it never would have remained one of the principal attributes of a fire-arm striven for by the gunmaker's craft from its earliest efforts at progress ; nor have engaged, at repeated intervals, the attention of the greatest military tacticians of each succeeding century.

That faculty of pouring at given times, and well, a rapid succession of deadly missiles against the assailant, in the shape of the cloth-yard arrow, so highly-esteemed in our light infantry of old, whether for attack or defence, was it less desirable in the exigencies of modern fire-fight ? In what had the incidents of war been changed ?—were they not, in fact, unaltered through thousands of years ? and will they not ever remain the same ?

The rapidity of a multiple fire, at will, once more attainable, must and will become anew a powerful element of success in battles, and its value will yet be established as thoroughly as in the Crimean war was that of the improved faculties of range and precision in the muzzle-loading musket.

That power which first evinces the sagacity to arm its light infantry with the most unexceptionable breech-loading rifle, whether as the assailant or on the defensive, will multiply its strength, though with weaker numbers. Whether dispersed *en débârdade* or in small rallying clumps, light infantry will laugh to scorn their hitherto most formidable enemy the cavalry ; against which, heretofore, after the delivery of their first fire, they have been comparatively defenceless, and before enabled to re-load, pierced with the lance of the horseman, whom their bayonets could seldom reach. How immeasurably increased, both on the advance or retreat, will be the confidence and courage of light troops so armed upon such occasions ! Though their first shot should have failed them, a second, third, and fourth, rapidly attainable, and delivered point blank, will be their rescue from otherwise imminent danger. With such an arm, presenting a constant reserve of deadly fire at their disposition, the audacity of the boldest cavalry will be checked, and its *morale* sensibly affected, by the certainty of the ready means of defence possessed by the isolated riflemen—rendered yet more terrible the nearer the approach to them.

In how many situations of attack and defence will not such a fire-arm, of equal range and even greater precision than the new infantry rifled-musket, give the equilibrium, if not the advantage, to the lesser number, opposed to the latter arm itself ? Of what eminent service to the foot artillery for the defence of their batteries ; to the sappers and miners, and trench guards, to repel surprise while

carrying on their works; the defence of baggage-trains in cases of ambuscade, that of posts, bridges, defiles, &c., &c.

In what order for effective onslaught would a front formation of Line infantry come down with the shew of the bayonet on such a rapid multiple of fire, delivered coolly and steadily, up to their close approach, by a two-line formation of light troops so armed?

No arguments that we have ever heard resorted to, plausible in a tactical sense as they sounded, would come unshaken out of the practical test, before such an element of success in the hands of troops well organised and officered, thoroughly skilled in that tactical use of such a fire-arm, of which its superiority is so suggestive to no few service officers of light troops.

Deeming that a nomenclature of the most known and recent modern types of the breech-loading principle would be interesting to our readers, we subjoin the same, as nearly as possible in the order in which they were brought to public notice in each country by their inventors.

MODERN PERCUSSION BREECH LOADING SYSTEMS.

FOREIGN.

	Pauly, Paris.....	Opening above, and closed by a spring-hook.	
1831	Roberts, Paris.....	Ditto, ditto.	Central ignition.
	French Rampart Gun Pattern ..	Ditto, ditto.	
	Perrin le Page.....	Ditto, ditto.	Central ignition.
	Montigny, Brussels.....	Ditto, ditto.	Central ignition.
	Lefaulcheux, Paris.....	Opening and closing below by a spring-screw.	
	Beringer, Paris	Ditto, ditto.	
	Loron, Versailles.....	Ditto, ditto.	Central ignition.
1858	Bernimolin, Liège	Ditto, ditto,	ditto.
1839	Norwegian	Percussion Stem.	
	Swedish Navy. M. de Fellitzen	Ditto.	
	Prussian. M. Dreyse von Som- merda	Percussion Needle.	
	Prussian. Klein's	Ditto.	
1854	German. Schlesinger	Ditto.	
	" Dr. Kuhl	Ditto.	
	Clerville		
1854	Commandant Treuille de Beaulieu	Cent Garde " Lance Fusil."	
1854	Francotte, Liège	Percussion hammer and cap, opening by Prussian-lever action.	Breech and muzzle loading.
	Prélat.....		
	Potet		
	Guérin		
	Miné, Captain.....	Prussian needle.	Complicated mechanism.
	Thomas, Paris		
	Riera. Spanish	With a most approved mode of ignition by a fulminating stem, applicable to every system of fire-arm.	

AMERICAN.

Jennings	Self-priming. Elongated charged-ball.
Welsh	Ditto.
Sharp	Ditto, Cavalry carbine, opening by action of lever-trigger guard, common cartridge, or loose powder and greased ball; cut off at base by lock action on closing breech.
Hall	
Moulton and Eustis	
Greene	Cavalry carbine, ordinary ball cartridge, pierced centrally by a steel tooth on closing-breech. Maynard's Patch Primer.

ENGLISH.

1853 Needham	Needle or Percussion, Shot-gun and Rifle.
Gilby	Self-priming.
Greener	
Cooper, Birmingham	Detaching chambered-breech, ordinary cartridge, or loose powder and ball.
Bentley, Liverpool	Rifle barrel, moved forward by a straight lever bridled to body of breech.
1854 Crickmay	Underneath fire. Rifle.
1855 Brant, since Calisher and Terry	Rifle.
1856 Prince	Percussion Carbine and Rifle, barrel moved forward by Prussian-lever action (see p. 183).
1858 Harding	Percussion Double Shot-gun. Fixed breech; barrels revolving half a turn on a spindle, by a lever trigger-guard.

By the well-timed appearance of the last-named ingeniously conceived breech-loading shot-gun, Mr. Harding, of the well-known firm of Deane & Son, late Deane, Adams, & Deane, has proffered to the British sportsman a "birding" breech-loader of home production, which bids fair to gain for itself a preference over the Lefaulcheux gun, which had recently begun to obtain a footing in this country.

In Harding's breech-loader, the principle on which the breech of the barrels is opened to receive the cartridge differs wholly from any of the modern types we have yet seen, and combines simplicity with strength. A little below the surface of the rib of the barrel, and forming a solid continuation of the former, projects a stout circular spindle, which imbeds itself into the solid metal of the false breech. On this spindle the barrels are made to rotate sufficiently to bring up the open breech of each barrel, in turn, to receive the cartridge, by means of a lifting trigger-guard, turning from left to right, and *vice versa*, at right angles with the gun. By this movement of the guard, a projection in the underneath side of the female breech is released from the hold and pressure of a hook, or claw, attached to the end of a spindle, formed on the guard itself, which, like the spindle projecting

from the rib of the barrels before described, works also in the solid metal of the false-breech, though at right angles with it.

In further addition to the security afforded by the pressure of the claw on the solid projection under the female breech, a bolt which passes under the bar on each barrel, is thrown forward by the return of the guard to its place parallel with the axis of the gun.

The cartridge hitherto proposed for use with this gun, consists of a soft metallic case of conoidal form, containing the charge of powder and shot, the wadding between which is of the ordinary kind, while that at the base of the cartridge is made of thin sheet-lead, the expansion of which on the combustion of the powder prevents any escape of gas or flash, on the face of the false breech.

The conoidal form given to the cartridge is resorted to in order to overcome more advantageously the resistance of the column of air in the barrel on the discharge of the gun.

For the production of a projectile perfectly analogous and adapted to the use of rifles constructed on this principle, a simple apparatus is made use of for cutting the bullet into the shape and length required, out of a round bar of compressed lead, by which process the uniformity of the density of the metal is better secured than by casting.

THE REVOLVING BREECH PRINCIPLE.

WE have already shown when speaking of the antiquity of double-barrel guns, that the rotating principle applied to the *barrel* is of even a remoter date, and one that once conceived could not fail to induce an early application of the rotatory movement to the *breech* itself, leaving the barrel a fixture. All the advantages of a ready multiple of fire sought for by the revolving barrels were hereby achieved, with that of a great decrease of mass and weight in the gun. The most ancient known fire-arms upon this principle—that is, with a group of small barrels so connected as to form a compact revolving iron *cylinder* or drum—with chambers performing the office of a rotatory breech to one barrel, date from the commencement of the sixteenth century.

Of the early origin of the modern so called “Revolver,” or fire-arm with rotatory breech, numerous and interesting examples exist in almost all the arsenals and collections of arms in the chief capitals of Europe, as well as in the cabinets of many private individuals.

Among the latter, of various dates, the most interesting specimens

that have come under our immediate notice are : a five-shot revolver gun in the possession of M. Camps of Brussels, a great amateur of rarities in fire-arms. This arm exhibits an indisputable character of antiquity, and evidently dates from the commencement of the seventeenth century ; it bears the maker's name of *Lehanne*. It is a gun of one barrel, which is immoveable in the stock. Between the stock and the barrel, a moveable group or drum of five small barrels strongly connected, rotate round an axle, and present in turn so many breeches to the true barrel. They admit of being separately or successively loaded, the orifice of each coming up clear and of ready access during the rotation of the cylinder. Its mechanism is simple. The lock is adherent to the stock, the cock (there is only one) is also adherent to the latter, nevertheless each tube is provided with a separate pan, so that when one of the little barrels presents itself in the movement of rotation at the extremity of the large barrel, its pan presents itself simultaneously to the action of the cock. M. Leroy, another antiquary of the same city (Rue des Finances) is also the proprietor of a gun having much analogy with the above as far as relates to the system of rotation. It has also five rotatory breeches, but it has no pan. In lieu of the latter, each of the five small tubes is provided with a concave-vent performing the part of pan, and this concavity established in the thickness of the breech, is covered over by a moveable metallic plate. When the cock falls, it drives a stem moved by a spring, that slides this plate back into a double groove, and the powder in the concave vent receives the spark produced by the friction of the flint in the jaws of the cock, against a permanently fixed steel. This singular fire-arm bears the date 1632. The proof mark upon it exhibits a fleur-de-lis placed between two H's, but the name of the maker to whom this mark belonged is not known.

Of another gun belonging to this category, in the collection of Messrs. Deane and Son, London Bridge, the reader will find a faithful representation at Plate 3. This will be perceived to have the *Spanish lock* or snap haunce, in its *earliest* stages of introduction. It will be remembered by those who have perused our preceding Historical Retrospect of Fire-arms, that the Spanish lock having the main spring outside the lock plate, made its appearance in Spain almost contemporaneously with the creation of the *wheel-lock* at Nuremburg in 1517 ; which it shortly superseded : hence the specimen referred to may by no means be one of the earliest of the kind.

The fire-arm above figured, has not alone the early Spanish lock, but every other indication of Spanish manufacture and execution of that period. Its revolving cylinder has three chambers only, each of

which presents its respective charge for ignition upon arriving on a line with the barrel, one of smooth bore, and of small calibre, and evidently made for sporting purposes.

Apart from the long well-known existence of ancient arms on this principle, preserved in the arsenal of Vienna, at Berne in Switzerland, the arsenal of Metz, the Musée d'Artillerie at Paris, and in other continental public institutions and private collections too numerous to mention, their existence in this country as types of a known ancient mechanical principle was familiar to the curious in these matters.

The Tower of London armoury, and the Royal Repository at Woolwich had long contained and still exhibit, in variety, both match-lock guns of the fifteenth century, wheel lock guns and ancient *pistols* with revolving chambers in various numbers 4, 6, &c., &c., the description of which would occupy too much of our space ; but which, as far as relates to the Woolwich Repository, are detailed in a catalogue of the ancient fire-arms in that institution, published in 1822.

That this principle of structure had not been wholly lost sight of in this country during the eighteenth century, is made evident by the existing grant of a patent to one Puckle, 1788, 4th. of George I.,* who therein applies it to a rampart piece to be moved and fired on a tressle, for the defence of bridges, breaches &c.

Of its recurrence as a type, known and made in this country at a later or rather more modern period ; viz., at the end of the last or quite at the beginning of the present century, Messrs. Deane have also had some time a proof, in their collection of Revolver Fire-arms, viz., a product of the gunmakers art in the Sister Isle, a six-chambered flint-lock smooth bore gun with revolving cylinder, made by an individual of the name of "Patrick," Dublin, whose existence as a gunmaker in that city could be no doubt authenticated without much difficulty. The gun in question, a short piece, has a slightly bell-mouthed muzzle, similar to a blunderbuss ; the lock is the improved flint-lock of the last and beginning of the present century : and each of the six chambers of the cylinder is furnished with a small pan and steel for the ignition of the charge on coming round to the cock.

Previous to adducing the mention of other examples in the revolver line in this country, in the second decennium of the present century, we think from what we have already appealed to, the reader who may yet from hearsay be impressed with the idea of the right of Col. Colt, or

* In the archives of the Patent Office, Southampton Buildings.

any other person of the present day, to claim the invention of the Revolving Chambered-Breech as their original conception and production, must dismiss such a notion as an error ; and, as far as relates to the period of its invention as a principle applied to guns and pistols, in obedience to the good old maxim of "*Suum Cuique*," concede to the ingenious craftsmen in gunnery of the olden time, not only their rightful meed of merit to its invention, but that admiration which we owe to them who with no pre-existing models before them for guide, grasped with so little tangible help the principles which form the groundwork of the great majority of the modern improvements in fire-arms.

We should not have laid so much stress upon this point, had it not have been for the boldness with which the paternity of invention of the revolver has been claimed in the United States ; and of the disposition shown to take advantage of the want of general information that prevailed in this country, on the history of fire-arms, and the different phases of progress through which these had not only passed, but were still progressing in England, France and Belgium, anterior to, and concurrently with, the efforts of the gun-makers &c. of the United States, upon the identical principle of revolver, or fire-arms with a rotatory chambered breech. That the first pattern of the principle found its way thither from the old world, is too obvious to doubt ; whether from England, France, or Belgium we cannot assume to say : but in proof that positive and practical efforts were still being resumed at the very commencement of the second de-cennium of the present century, in France, for the improvement of this principle in fire-arms (by no means unknown or forgotten), a gunmaker of Paris of the name of Lenormand, about 1820, constructed Revolver *Pistols* with a five chamber breech. Lenormand's pistol had but one barrel, at the breech end of which a drum or cylinder, performing a *non-intermittent* rotation, that is, not requiring to be cocked for each discharge, performed the functions of the revolving-breech. This arm presented still many defects. Its mechanism was complicated, and easily deranged. The action of the lock, which was harsh, prejudiced the precision of its fire, by communicating an irregular vibration that imparted itself as a matter of course to the hand : Lenormand's efforts were therefore unsuccessful.

In England, concurrently almost with Lenormand in France, a gunmaker of the name of Collier, who practised his calling at No. 45, Strand, London, took out a patent for revolving-breech fire-arms, fired by *percussion*, the *solid* chambered cylinders of which were turned and bored for him by the present Mr. Evans, engineer,

of No. 114, Wardour Street, Soho, in 1821-2.* An Elisha H. Collier, probably the same person (but whether an Englishman born, or a citizen of the United States, we have not been able to ascertain) had patented in the latter country, a few years before (in 1818) a *flint-lock* revolver gun, having all the disadvantages of that mode of ignition, with other structural defects, which, if the Colliers were one and the same person, he had sought to remedy in the percussion-revolver first cited, patented in England, and the first of the kind made in this country with that mode of ignition, and the *solid* cylinder.

One Wheeler, of Boston (United States), had also suggested a structure of flint-lock revolver gun, patented by Coolidge in 1819. But Collier's (of the Strand) percussion gun, patented in England at the date adverted to, was obviously a step in advance, both of any former production of his in America, and of the flint-lock arm of Wheeler.

In France, Devesme, of Paris, patented about the same time as Collier in England, a 7-shot percussion revolver, which had no less its defects, and shortly after him Hermann, of Liège, constructed a revolver pistol, of simple and most elegant form, with great portative convenience, smoothness of action, and facility to handle. It had, nevertheless, its defects, which, though susceptible of correction, the author neglected; and his first labours were unproductive of the result they might have led to.†

* We consider it no more than an act of public justice to assign in this place to *Mr. Evans*, the meed of merit due to the early exhibition of his talent as an engineer and mechanician. To the exercise of these in the service of the gunmakers of London and Birmingham, for the last 36 years, the most celebrated of these have been indebted for the designs and execution of those machines by which they have been enabled to economise labour, and to carry out the improvements effected by them in the manufacture of arms. Among the beautiful specimens of engineering skill which have emanated from *Mr. Evans'* hands may be cited his—

“ Machine for Rifling gun-barrels;” designed and executed 33 years ago.

“ Lathe for Turning gun-barrels.”

“ Drilling Machine for Touch-holes.”

“ Drilling and Tapping Machine for Percussion Nipples;” designed and executed 13 years ago, &c., &c.

Furthermore, and as a fact not generally known, it is to the talent of *Mr. Evans* in this particular branch of mechanics, that both the government establishments of Woolwich and Enfield have been for many years indebted for the designs and construction of several of the machines there applied to the same purposes; and, above all, for the first design and construction of the machine for making the cylindro-conical balls, for the new rifled muskets, by **COMPRESSION**; which machine, sent to Woolwich Arsenal, formed the *model* for the large ball-compressing machine since constructed there by *Mr. Anderton*.

† We have, nevertheless, since seen a very beautiful specimen of *M. Devesme's* system with his later improvements; a long barrel 7-chambered revolver-gun, made to order, in 1835, for an Arab chief. The ignition of this arm was interior and vertical.

Somewhat later, the *Mariette* Pistol made its appearance, differing from the preceding arms by the revolution of a group of barrels connected by means of a massive breech, bored with chambers of like number to that of the barrels, instead of having a revolving cylinder. The number of barrels varies from four to twenty-four. Each barrel screws on to one of the chambers of the revolving breech, which thus effects the forcing of the ball. To load this pistol, the barrels are disengaged by means of a bullet-mould, having one arm fashioned so as to gripe into the muzzle of the barrels in the square, and each chamber of the breech has behind a well-imbedded nipple that presents itself to the action of a hammer under the lock and fulfilling the office of cock.

In the *Mariette* pistol, like that of Hermann, the rotation is *continuous*, that is to say, it does not require to be *re-cocked*, the tumbler having no half-bent, nor full-cock notch, but merely a bent of escape, the release from which is instantaneous. As soon as the finger presses the trigger, the massive breech and group of barrels move together, each barrel taking its place opposite to the percussion hammer, where it is retained by a *stop* till the moment of firing. The stock or hand of the pistol resembles that of the ordinary pistol. The trigger exteriorly is in the form of a ring, into which the index finger inserts itself; the massive breech turns on a centre pin, serving as axle, which, fixed in the centre of the body of the lock, traverses the group of barrels and terminates in a stem or style, which at need will serve as a poniard or bayonet. From its number of barrels, and consequently its comparative weight, the system of the *Mariette* pistol can be applied to no possible utility but as a breast pocket fire-arm. The continual rotation of the barrels, and the perturbation occasioned by its mechanism require that it should be fired at close quarters, and this arm being one of little precision of fire is of very secondary use, except in cases of defence in close contact with an adversary.

The *Rissac* Pistol, another variety of the numerous systems of revolver that appeared simultaneously in France, is, like the Hermann pistol, of graceful form, with a chambered cylinder, and one barrel. Its movement is continuous, and the hammer, in contradistinction to the *Mariette*, acts above. The mechanism is extremely harsh in its action, and consequently little reliable service could be derived from it.

Thus far in England, France, and Belgium, up to 1830-35, had revolver fire-arms progressed, as a resuscitated mechanical principle of construction; and numerous revolvers had made their appearance

in the United States, of American design, before the year 1829 ; the year in which Col. Colt, by his own admission,* first directed his attention to the construction of such arms, the priority of invention of which he believed to be peculiarly his own ; a misapprehension which he does not discover till the year 1835, during a visit to Europe.

The early arms of Colt, which began to be manufactured in number at Paterson, U.S., from 1836 to 1842, had, as a matter of course, gone through different phases of improvement by himself, and they had not assumed their present form till 1840. They eventually first entered the lists for a comparison of merits with the rival American revolvers of Leavitt, Warner, and Perry ; and those of Leavitt and Warner, whether from the too close proximity of their merits to those of the Colt pistol, or some structural analogies, were denounced as infringements on Colt's patents, and their proprietors prosecuted according to law.

Now, analogies are easily found, and must, as a matter of course, present themselves frequently between numerous things of human contrivance, especially in those designed for the same purpose ; and we see no sound or equitable reason in the pretext of the existence of an analogy in the fundamental idea of two things having the same object, produced concurrently, or at a short interval of time from each other, by two different persons—to exclude the concurrently produced, or later one (and perhaps the best), from competition for public favour ; and the less so, when both are alike grafted on what may in this case, of a verity, be termed a common stock principle which had pre-existed both. If such a pretext were to be established by a strained legislation, as damnatory of concurrent or later productions, then would there be a bar not only to all improvement, for the sake of establishing a temporary monopoly, in which one or more persons found their interests at the expense of the public and of art progress itself, but a very summary method of curtailing the state revenues derived from an institution which, judiciously carried out, would be a security for really novel designs of merit, from piracy. And though the human mind, like the body and all else in nature, has very wisely been constituted susceptible of divergencies or dissimilarities, it never could have entered the head of any person to reproach seriously an inventor, for having applied to his use and purpose, principles and materials already acquired either to science or art, in improvements upon the improvements of another.

* Published in London, 1853, in the Excerpt Minutes of Proceedings of the Institution of Civil Engineers.

However little it may be worth, we must express the opinion, that in arms on this and the breech-loading principle, *unless* the one denounced be a SUBSEQUENT production of *identical* mechanical form of parts effecting the same result, no just and equitable ground exists for such a proceeding on the part of any patentee, the basis of whose own invention is a pre-existent and well-known normal principle, fallen centuries ago into the domain of the public, and made subservient to the original purpose of a long forgotten inventor, by mechanical agencies the forms of which are *not* wholly and radically new, nor of the patentee's own first design. We would hope to believe that no jury of engineers or intelligent mechanics would be so influenced in this country, as to grant damages in such a suit, save and except the direct action of the denounced arm was effected by structural parts of the same form throughout as those of the arm of the pursuing patentee.

And for this reason :

The mechanical motive forces are world-known simple principles, the property of mankind, admitting of application by an endless variety of mechanical forms of agency, or accessories to the effect sought for.

The right to modify the form of those accessory agents is no less a common one, and though that should *act* analogously to another existing modification of form, and effect similar results in a worse or better way ; it is not therefore to be considered one and the same, or in other words, a copy or infringement of a concurrent or pre-existing patent, itself a modification of known principles. *

The early disposition shewn by Collier in London, and Lenormand, Devesme, Hermann and other gunmakers of France and Belgium during the period indicated, from 1823, to direct their attention to the production of a fire-arm capable of a multiple fire, established on the revolver system, was as natural a result of the successful adaptation of the percussion system to fire-arms as the efforts of Pauly, Robert, Lefaulcheux, and others, to establish an improved breech-loading gun. But in the United States, the inducement, the prospective encouragement, was far greater ; for it was from the peculiar and constantly hostile character of the relations of the people of the Union with the Indian tribes bordering upon their frontier, that the revolver and breech-loading systems of fire-arm became an especial object of study to the gunmakers of America ; in the pursuit of which it may

* Since writing the above exposition of our ideas on this subject, we have learned that a tribunal in Belgium, came not long since to the same conclusions, and rejected a suit of Col. Colt's against a manufacturer of that country, in regard to his lever-ranrod.

be rationally supposed they did not shut their eyes to what had already been done, and was doing, by the gunmakers of Europe, in the general impulse towards improvements in fire-arms from 1820 to 1840. To suppose that they had not been observant of this, would be to doubt their possession of that acumen which is, *par excellence*, the boast of our Transatlantic cousins. In this, as in most cases where the circumstances favour the research, a more improved means whereby to obtain a particular and desired object, was arrived at by several competitors.

The Indian, or red man, from those advantages which a life of nature gives over the white or civilized man, was in most cases individually greatly his superior. Military discipline and courage were not always sufficient to give the latter the advantage, and though skilled in the use of the rifle, the Indian was as good, and more frequently a better shot with the same arm. Breech-loading and revolver fire-arms therefore, though somewhat at variance with the spirit of that professed love of "fair play and a stand up fight" which is an especial favourite axiom with the *soi disant* Anglo-saxon race, ensured superiority. Hence it was considered quite fair, or, in senatorial parlance, expedient, to profit by the immense advantage that would accrue from the use of an arm with which the gallant red antagonist was not yet acquainted.

In perfect accordance with the dictate of an antique, sound military custom, which ignores the specious chivalry of pugilism, breech-loading and revolver fire-arms, especially, of more easy carriage on the person, delivering a rapid fire at will, and combining the precision and percussive force of the rifle, were just the weapons, and soon became objects of special demand with incursive back settlers, and the weak military posts stationed on the different points of the extensive frontier boundaries of the Union.

Advantageous markets for arms on this principle were yet further opened in California, the Texan and Mexican wars; and varieties or modifications of these arms, of rival merit, were therefore produced as a consequence by others in the United States. The breech-loading and revolving arms of Hall, Sharp, Leavitt, Warner, Colt, Perry, and a host of others, contended for precedence from 1836 to 1848; and, favoured moreover by certain social circumstances which distinguish life in the Union, the revolver had become so diffused as to be an indispensable and popular article of the personal effects of the individual.

In the Old world, on the contrary, though as we have shewn, some ingenious efforts had been made at an earlier part of the

present century, to establish a revolver pistol, yet the principle as applied to a fire-arm was one of which the European public in the mass knew absolutely nothing; until a few years since the staid notions of European society were startled with accounts of the flagrant violations of order and bold acts of aggression perpetrated with the revolver in America; and the European Military world learned that the government of the United States, after several instituted trials of the different rival systems brought out in America, had adopted the Colt revolver into the American army, which, by the concurrent testimony of United States officers of every grade, rendered important services in Florida and Mexico.

With such results bruited in their ears it was but natural to anticipate that the mechanical skill and industrial efforts of British, and other European gunmakers, should receive a fresh stimulus to go in for a share of the harvest of repute and remuneration, which the successes of their American brethren foreshadowed, for a good type of the genus revolver on this side of the Atlantic; and, upon Colonel Colt's arrival to exhibit his arms at the Great Industrial Exhibition of London in 1851, he found also other "Richmonds in the field."

With justice it has been and must be conceded to Colonel Colt that, as a revolving fire-arm, his pistol was a great and leading step in advance; that it gave an immense impulse to the development of that ancient principle applied to modern fire-arms; and no less, that it greatly excelled any efforts of the kind that had been made anterior to it. But that it was, what it was dogmatically asserted to be, "without reproach," and superior in each respect to every other that concurrently appeared with it in 1851, has been sometime decided otherwise by the European public, and that ordeal which is the true touch-stone of all human creations, time and experience.

To dwell at any length upon the numerous types of the rival revolvers produced by English gunmakers would greatly exceed our limits, but the most remarkable were those of Joseph Lang, J. Barnett, and Robt. Adams, the last of which, despite an antagonism which was both favoured by influences calculated to mislead, and conducted in a spirit of Trade, rather than Art rivalry, shortly established itself as the most formidable and successful English competitor of the Colt Pistol, and has since achieved an equal world-wide repute under the well-known name of the "Deane-Adams" Revolver.

To a definition and comparison of these last arms we shall therefore restrict ourselves, as the two which have, since their appearance in 1851, acquired the most notoriety. From the manner in which we

shall effect this, we hope to satisfy our readers that we have sought neither to ruffle the self-love, nor to tread too close upon the interests of the individual; and estimating these as secondary in import to the interests of truth in an exposition of mechanical and scientific facts, we give in the same expression with our own, the complex of the opinions of judges of the highest practical competency and strictest impartiality.

As preliminary thereto, we consider that a concise definition of the distinctive features which modern revolver fire-arms had assumed, *inter se*, and which separated the genus into two distinct classes, or species, if we may be allowed so to designate them, will better facilitate not only a clear comprehension of the mechanical points of difference that existed and exists between them, but a salient one, which, had it received a due consideration from those who, pronouncing arbitrarily upon their respective merits, would have fairly assigned to each its due, as a type of the class to which it belonged, and given to their comparison a less questionable hue of partiality.

It is to such too general omissions at the outset of a comparison of the merit of things, that may be ascribed the confusion and uncertainty that frequently rests so long upon them; whereas, had the special mechanical or art distinction in their structure been kept steadily in view by the critic, not only would the speciality of their respective design have been clearly understood by the uninitiated—but in the ratio that each fulfilled the object of that design, would their respective class merits have been duly assigned to them; and, according as each of its kind was best adapted to fulfil the object of the type it represented, it would have been at once stamped with the true seal of recognition, as best, or less adapted of its kind to the purpose for which it was designed and might be required—and A not preferred over B, for effecting what B was not designed to do, and *vice versa*, while each was, or is, the best representative of their classes for a special purpose.

It must be inferred, as will doubtless be admitted, that the cardinal object sought from the first to attain by a revolver fire-arm was, *rapidity of fire*, either for attack or self-defence, on a sudden emergency. To combine that preliminary quality with precision of fire and a certain effective range, entered also as a second factor to be obtained by their structure. But rapidity of fire, as of every thing else, is a function which has its degrees. It is either successive, at intervals more or less marked, or interrupted; or successive for a time with less sensible interruption. Hence it is *intermittent* or *non-intermittent*. According as those two degrees of rapidity of function have been

imparted to the mechanism of revolver fire-arms, so of a necessity do these find their place in the class to which they belong, and of which one or more may be, in degree, the best representatives, and more suited to their particular purpose.

Hence, it must be strictly from the latter point of view, that the appropriate and comparative degree of excellence in one revolver (or any thing else) over another is to be measured, before it is pronounced superior, in all respects and for all uses, to every other of the genus or kind ; and this process (the only just one) leads to that proper qualification of things which should be given to all, and not lost sight of in the interests of the individual inventors, however great their respective merits.

Wholly distinct as the classes to which they belong, the Colt pistol is an *intermittent*, that of Adams a *non-intermittent* revolver. Hence the Colt is not, in the strict sense, that which it was designated, a "repeating pistol ;" though, as an intermittent revolver, it holds as high a place as the Adam's pistol (in the stricter sense a repeating pistol) in the class of non-intermittent revolvers. Having thus, we think, clearly defined that distinguishing feature in the respective functions of these pistols which has been so much overlooked, before we proceed to a succinct detail of their respective mechanism, it may not be out of place to suggest the query : for what most general purpose would a revolver pistol be required ? or, in other words, in what circumstances would rapidity of fire in a short, portative fire-arm be most desirable and useful ? We think the reply will be, in all those more especially in which *pistols* were hitherto resorted to for centuries past, viz., more at close quarters and for defence in sudden attack against one or more assailants, than for long shots. The exigencies of these circumstances, then, are pre-eminently met with in a good non-intermittent action revolver, be whose it may, and in which the cardinal faculty of a *revolver* pistol, a rapid and multiple fire, exists, associated with precision and a good range.

As respects the two latter qualifications, a revolver being pre-eminently a fire-arm for close conflict, sudden attack, and quick defence, if its rapidity of fire produce but little deviation, the qualities precision and great range are in reality only *secondary* requisites ; and in the non-intermittent revolver, the latter would be less indispensable, though we know of none, not even of the worst of this kind, that do not much exceed the range of any percussion pistol of equal and even greater bore.

As regards the rest, it must remain a mere matter of choice between the two kinds of arms ; and either will be "*the best*" that

best of its kind answers the purpose required of it—a greater or less rapidity of fire at *close quarters*. If, on the other hand, a pistol is required that shall almost answer the purpose of a rifle at long shots, both the revolvers in question, and Colt's large pistol especially, satisfy a requirement which very few would consider indispensable in a pocket, belt, or even holster pistol.

The basis of the stock in the Colt pistol is formed by a piece of metal, having a boss of hemispherical shape in the rear of it, which is cored out to receive the hammer, trigger, &c., and serves to cover the nipples. To allow of the percussion-caps being placed on the nipples, the boss is cut away on one side. In this boss is fixed a pin, on which the six or five-chambered cylinder revolves; and a shallow thread cut in the pin at this part serves as a reservoir to hold the oil necessary to lubricate the pin, and enable the cylinder to revolve freely upon it. This pin serves also to carry the barrel, which is keyed to it. By forcing up this key the barrel is brought into contact with the cylinder, and the latter in contact with the boss. To prevent the loss of the key, by being wholly disconnected from the barrel, a small screw is fixed in the barrel, the head of which enters a groove in the key, and prevents it being withdrawn. On the front of the piece of metal, first adverted to as forming the basis of the stock, are two small pins, which serve to steady the barrel, the projection at the end of which has holes bored to receive them.

The ramrod is guided by sliding through a projection forged on the barrel, and is moved by a lever which works on a pin as a fulcrum. When not in use, this lever is kept in position by means of a spring-catch, furnished with a spiral spring, so that, after being used, the lever is fixed by the act of grasping it with the barrel, and is immediately disengaged by pressing down a projecting tongue, which extends transversely beyond the diameter of the lever, to admit of this being done with facility.

The hammer (which is both cock and tumbler) moves on a pin, as a fulcrum, and is actuated by a spring, the end of which bears on a friction roller in the heel of the hammer. By this means, when the barrel and cylinder have become foul from use, they can be taken to pieces and cleaned. To this effect, the key requires to be driven back, and the barrel and cylinder can then be slipped off the pin, cleaned, and put together in a few minutes.

The movements of the cylinder and hammer are provided for as follows :—

The cylinder, being bored to receive 6 charges of powder and ball,

must be moved one-sixth of a revolution each time. It must be held rigidly in a line with the barrel at the moment of firing, and it must be capable of making a complete revolution in order to load it.

The motion of the cylinder is thus provided for. The rear end of it is cut into a circular ratchet of six teeth. A lever, attached by a pin to the hammer, moves the ratchet as the hammer is raised in the act of cocking, and the lever being held against the ratchet by means of a spring, the cylinder can revolve in one direction only.

The cylinder is held while the hammer is falling, by a lever, the end of which has a tooth in it which takes into one of the notches, of which there is one over each nipple. The other end of the lever is moved by a pin fixed in the hammer, and so adjusted that as the hammer rises, the lever is out of the notch, and the cylinder is released before the ratchet is made to revolve by the lever. While the hammer remains at half-cock the lever is clear of the notch, and the cylinder can be revolved and loaded. Before the hammer is brought to full-cock, the pin fixed in the hammer passes the end of the lever, and the latter being released, is forced by a spring into the notch, to hold the barrel in the right position at the moment of firing.

This spring is divided into two parts, one acting on the lever holding the chamber whilst the hammer is falling, and the other acting on the trigger to keep it in contact with the hammer.

After the pin fixed in the hammer has passed the end of the lever in going up, it could not repass it in coming down, unless this was provided for. This is effected by splitting the end of the lever which holds the cylinder while the hammer is falling, in two pieces, on the inner of which only, the pin fixed in the hammer, acts. The point of the pin is also bevilled, so that in its descent it collapses the two pieces of the lever which holds the cylinder while the hammer is falling, and passes them, their elasticity keeping them extended after it has passed.

Method of use. The hammer is half-cocked, which sets the cylinder at liberty, as described, and the powder being poured into each chamber in the cylinder in succession, the balls are put on the powder without wadding, and rammed down by the lever ramrod.

To prevent accidental discharge while being carried, a small pin is established between each nipple, and the nose of the hammer has a corresponding notch, so that if the hammer be lowered on to the pin, the cylinder is prevented from rotating, and the hammer is not in contact with a cap; in order that, though the hammer be struck violently by accident, it should not explode the cap.

The hammer at full-cock, forms, by means of a slight notch in the

crown, the back sight, by which to take aim, and can be raised to full-cock by the thumb of the pistol hand, but not so readily as by using both hands.

The constituent mechanism or parts of the lock, are therefore technically expressed and summed up, as we have shewn, a main-spring, a hammer or cock, a sear-spring, a lever, a trigger, and a pall.

The barrel of forged iron, or more properly of cast steel, is rifled with seven grooves, with an inclination of one turn in about six feet six.

The form of the barrel, from muzzle to end, differs wholly from that of other revolvers, and is quite *sui generis*, being cylindrical at its anterior part, and of a massive, irregular, flattened form for the length of some inches (according to the size of the pistol) at the posterior part.

The Colt pistol fires both spherical and cylindro-conical projectiles. There are five different sizes—the holster, for cavalry; the belt (two sizes), for infantry, &c.; pocket, two sizes: each with five chambers.

As already said, the Colt pistol was a great step in the improvement of revolver fire-arms, but with all that, far from being the perfect arm it was affirmed to be. It is true, that, as compared with those that preceded it, both of intermittent and non-intermittent fire, the action of the lock was smoother, its fire more regular, its range and precision greater; with more percussive force or penetration, and capable of rendering services which it would have been vain to seek from its elders of the same genus, but:

It neither was nor is, in the strict sense, a "repeating" pistol, or one with a successive and uninterrupted fire, since the six charges cannot be fired without interrupting the revolution of the cylinder as often, to cock the hammer. Barnett's and Adam's in England, with their and Colt's predecessors on the Continent,* were and are true repeating pistols, i. e., nothing interrupted their rotatory movement.

It was cited as a special advantage of the Colt, that neither wad or cartridge were required in loading it. But this was by no means peculiar to the Colt. It was a faculty common to almost all revolvers; but all the competitors of the Colt could claim exemption from the *necessity* to use a ramrod, or a loading-lever; and the Adams' revolver established its fame before the addition of any of the different loading-rods since attached to it was made. Furthermore, the obviation of that very necessity of a loading-rod for a revolver, was urged by many military men and foreign gunmakers, as

* Those of Hermann, Rissac, and Mariette already adverted to.

an *advantage* in a short fire-arm, more required for use in close emergency, and perhaps at very short notice, than for fire with long aim at distant objects.

Simplicity of construction was also specially claimed for the Colt pistol. To speak truthfully, it is very complicated, and too much so for a revolver ; but this resulted, doubtless, in a great measure, from the design that it was *to be intermittent* in its action.

As regards its safety of transport, affirmed to be such that no possibility of accidental discharge could therein arise, the irregularity of form of the Colt adapts it less than most revolvers for carriage in the holster, belt, or pocket ; for the hammer is completely exposed, and as susceptible of being lifted without pressing on the trigger, does not fulfil those conditions of safety required, from accidental shock, or fall, as well as friction.

The butt of the pistol placed in juxta-position against the body of the lock, and fixed to the stock by a single screw, is very susceptible of becoming shaky, and the two bands which attach the lock to the wood, encircling the grip and the butt, from being of soft metals, brass or german silver, are more susceptible of wear at the places of lodgement for the five screws which fasten them to the body of the lock ; neither is the appearance of the pistol improved by this resort to those metals.

The Colt pistol does not afford greater facility for taking aim than Lang's, nor Adams', when any practice has been acquired with these. With its celerity of fire we have already dealt, which is, of a necessity, less than in all revolvers with uninterrupted rotation.

The superiority over all others, affirmed in the expression that "the Colt revolvers are the best that exist," must always remain a matter of opinion. We consider Barnett's at least as good, Lang's preferable, and Adams', as a *revolver*, greatly superior. In point of fact and truth, Col. Colt cannot be said, with all his merits to praise, to have successfully overcome all the difficulties which presented themselves in the construction of these arms. He has made great improvements, but he has not invented much : in the last respect, he stands only where all his competitors do ; and in the former, the prior merit is his due for having so ably availed himself of the labours of those moderns who preceded him—Lenormand, Devesme, Hermann, Mariette, and others.

One really distinct advantage in Col. Colt's system is that of the separation established between the nipples and the distribution of the points with which those separations have been furnished.

But the Colt revolver becomes easily deranged, not in the action of

the lock, but in the rotation of the cylinder. It requires more time to load it than other revolvers (excepting the Mariette pistol), and is by no means guiltless of mis-fires. One assistant cause of this is a weakness in the action of the trigger, which, despite the smooth action of the mechanism of the lock, imparts but little vigour to the fall of the hammer, and a not unfrequent derangement in the movement of the cylinder. This weakness in the trigger action renders the use of a thin cap desirable, the splinters from which are the more liable to get between the cylinders and the flat of the hemispherical mass behind the body of the lock, entailing a suspension of all movement of cylinder and gear. The mode in which the barrel is fixed on the cylinder-axle is also objectionable. The lever ramrod is far from simple, it is more complicated than any of the kind in use; and, as regards the merit of having *invented* that, there are several machines in which motive agents very similar exist; and it was justly observed by Anquetil, in his "Notice sur les Pistolets tournants," that the eccentric used to move locomotives from one line of rail to another, exhibits the same principle, though the mechanism is established so as to produce a result acting in an opposite sense.

The Colt revolver is heavy, much too heavy. The lever and rod, the irregular part of the barrel, the boss or hemisphere behind the lock, the bands of the furniture or mounting, being all solid, massive metal, it could not be otherwise.

The shape of the pistol-butt is not elegant in an Artistic point of view. This remark may be objected to on the readily acknowledged justice of the reply, that the artistic elegance of a thing has nothing to do with its merits in fulfilling the purpose for which it was designed. However willing to give our adherence to the matter-of-fact character of that truth, yet we think, in the present day, when in this country we contemplate manufactures of all kinds in a more æsthetic point of view than was our national wont, a co-operative association of handicraft with Art in gun and pistol-making is as desirable as in any mechanical production for the uses of life. Such, at any rate, was the sentiment of the early and later craftsmen in fire-arms on the Continent, which, like every other product of human skill, was and is made an effort of Art, and conducive to the culture of Art itself. But for the tyranny of a too long subsisting principle of economy in production, on which manufactures were established and understood by our countrymen and their American descendants, we should not have remained so long behind in the expression of this higher sentiment in our productions, nor have been considered more insensible to and incapable of the æsthetic feeling; or, in other words, of that

inspiration and tasteful handling in our works which evince both real culture and genius.

To resume, the Colt pistol does not lie well in the hand. It is liable to become shaky and to detach itself. To take to pieces and put together the Colt revolver is, moreover, no easy matter; and few amateur possessors of this arm would be able to effect it properly.

Thus far as regards the merits and defects of a fire-arm which made its appearance under circumstances more favourable to a speedy publicity and adoption than had attended the production of any portative fire-arm since their first invention. Attaining, though it may be said to have done at one bound, a position and repute so high both in the new and old world, it promises to recede (at least in Europe) almost as rapidly from public estimation, and, displaced by its English and Belgian competitors, to become in a few years more an object of curiosity than of general use.

Restricting ourselves to the limits assigned to us, we will first shortly advert to the revolvers of English origin, which, appearing concurrently with the Colt pistol at the Great Industrial Exhibition of 1851, rescued the "old country" from the imputation of the lack of that spirit of progress which was assumed to have transferred itself, *in toto*, to their American descendants.

The pistol produced by Lang belongs to the class of "intermittent revolvers." In respect of that system, therefore, compared as "like with like" with the Colt revolver, it is considerably lighter; for the use of a ramrod and its concomitant lever being rejected, the metallic part adherent to the barrel is less massive. The rotating apparatus is a block of metal representing two cylinders having the same axis, but of different diameter. It turns on a cylinder pin, and the barrel is maintained thereon by means of a key-bolt. The chambers are situated in the anterior cylinder, that of the greater diameter. The orifice of the chambers is widened, so as to permit the posterior orifice of the barrel to set into them, and thereby prevent the escape of flash and gases. The movement by which this insertion is effected is regulated by a spring.

The nipples are set vertically upon the posterior cylinder, the one of least diameter. The lock has its action behind the cylinder. The cock is placed on the right side of the pistol.

The action of the whole is smooth and pliant. The arm is simple in structure and form; very handy; and its fire regular and of great precision.

On the other hand, its defects are as follows: the nipples, having no metal to separate them, may explode from each other's fire, and

during the rotation of the cylinder, from the vertical position of the nipples, the caps are subject to fall off. The form of the cock is ungraceful, and, from its crown being inclined too much backward, it is cocked with some difficulty ; placed also somewhat too near the line of aim, it impedes this, or retards it somewhat ; and, lastly, a small spring, situated at the neck of the stock, and serving to keep the cock off the caps, does not always act well, and is easily put out of order.

Notwithstanding the last cited imperfections, the Lang revolver has so many features of excellence, that it has been a matter of surprise that some correction of the former has not been made to render it deserving of the competitive rank it seemed entitled to.

The Barnett revolver is with uninterrupted rotation, and does not require to be cocked by a distinct or special movement. Like the Lang, it wholly repudiates the use of the loading-rod and lever of Colt's system. The office of the cylinder-pin is fulfilled in this pistol by a prolongation of the lower part of the barrel, which, passing through the cylinder, adapts itself to the body of the lock behind the former ; below the barrel in front, this prolongation is armed with a spear-like point, which serves to pierce the cartridges used with this revolver. The bore of the barrel is smooth, i e., without rifling.

The cylinder is analogous in form to that of the Lang revolver. The limbs of the lock have their function behind the cylinder in a circular lock body, and the cock-nose acts in unison with the vertical plane of the axis of the pistol. As a revolver not requiring to be cocked, the Barnett pistol has a greatly preferable action to the Mariette. It is lighter, more handy, and easy of carriage ; more simple in form and appearance than any of those hitherto spoken of : but as regards the vertical disposition of the nipples, and the action of the small spring performing the office of safety-bolt, it participates in the defects of Lang's revolver.

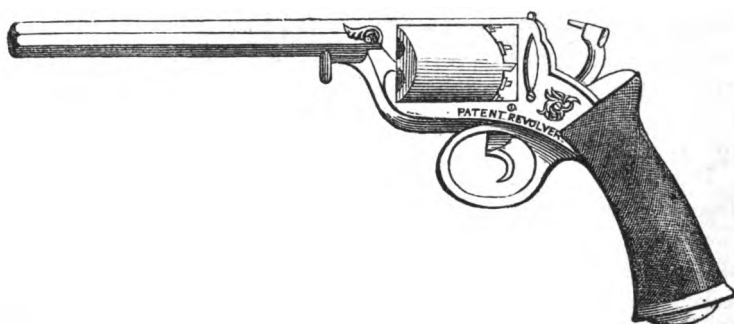
Finally, the mechanism of the lock is subject to derangement on account of its complexity ; and the hammer, from the manner in which it is established, greatly interferes with the aim ; because the eye of the operator, in order to find the front sight, is obliged to direct its glance through an intersection made in the substance of the body of the cock, as through a hole in the pinule of the graphometer. Of this arm the same may be said as of the Lang revolver ; its essentially good qualities deserved a more harmonious modification of its defects.

By a more simple association of the collect of principles exhibited

in the various systems of revolving fire-arms anterior to the Colt pistol, and by the application thereto of certain original modifications, the Adams' revolver realized more completely the idea of a revolver capable of effecting all that was most required of a fire-arm designed for defence in imminent emergencies.

It presented no point of mechanical structure that in form, or excess, in any way prejudiced the attainment of the result designed; but a type of system that, should it be deemed necessary, would admit of any slight addition or extension of action by way of improvement, without thereby prejudicing the efficiency of the inventor's first conception of a good non-intermittent action, and increasing too much, by an undue accession of new parts, the weight of the whole pistol as a portative fire-arm.

It exhibited, in fact, an exemption from many of the structural defects of the Colt and other revolvers, together with the possession of the majority of the advantages which distinguished them.



The structural parts of the *original* Adams' revolver were five in number only, viz, the barrel, and its adherent body or frame; the cylinder, rotating within that body; the cylinder-pin or axle; the lock; and the stock.

The barrel, in its whole length, represents a cylindrical, regular, hexagonal prism. The bore is larger than that of the Colt of corresponding size, being 32 balls to the lb., and the latter 60. At and in continuation of the posterior part of the barrel is a flat band (called the top strap), which extends above, behind, and below the cylinder, till it assumes an irregular form, and becomes again one with the barrel. The vacuum thus described in the body proper, or frame, of this revolver, represents a quadrilateral triangle.

At the hinder part, this frame is fixed to the stock by three screws; and it is in this part that the lock is seated. In front and

below the barrel, a passage is pierced to receive the axle-pin of the cylinder. At its lower part it is provided with a trigger-guard and trigger.

The rotating cylinder, as in the revolvers of Lenormand, Hermann, Rissac, and Colt, is a cylindrical block of forged iron, in which five small tubes or chambers are bored. Each of these chambers terminates posteriorly in a nipple-vent, forming breech thereto, as in the Colt, and its predecessor, the Mariette pistol. The cylinder-pin is simply an iron stem upon which the cylinder revolves; it is therefore, at one and the same time, its axis and its axle during the rotatory movement. Its extremity imbeds itself in the hinder part of the pistol body, and its anterior part is forged with a flat circular head, cut into on the side next the barrel, of an analogous shape, so that the barrel seems to rest on this factitious groove, which serves only to admit of an easy extraction of the cylinder-pin, to take out the cylinder. This pin traverses the anterior lower part of the pistol body, and then the cylinder, to assume its other resting-point in the posterior part of the body. It is furnished with two jags, or notches, cut inversely to each other; the one fixes it in the back part of the pistol body, and the other is intended to prevent it escaping from its lodgment, for which purpose, upon the right hand of the fore part of the pistol body, a small spring is established, the pin of which becomes engaged in this second notch as in a catch. But in spite of this, if the intention were exhibited, no great exertion was required to draw out the cylinder pin.

The lock is remarkable for its simplicity; it is adherent to the massive part of the rear and lower substance of the pistol body. It consists merely of a cock, a main and a sear spring, a swivel, a lifter, and a trigger.

The lower part of the cock acts as tumbler, the upper part as hammer. In order to strike the cap, the nose of the hammer passes into a hole pierced in the metal of the back part of the pistol body. The tumbler end of the cock is connected with the main-spring by the swivel. The trigger communicates with the lifter, and, on being pressed by the finger, imparts to the latter the faculty to set the cylinder in motion, by means of a ratchet established on the rear of the cylinder, and by which it moves and checks it, in such manner that each nipple is brought opposite to the hammer nose, at the moment when the cock escapes from the full-cock bent to give fire. When the shot is fired, the pressure of the finger on the trigger is diminished, in order to permit the trigger to engage itself anew—a movement instantaneously effected; and as soon as the trigger has

returned to its primitive place, a further pressure only is required to bring each nipple successively and rapidly under the stroke of the cock-nose.

The admirable part of this combination is, that the same movement which releases the hammer, after having cocked it, imparts the rotary motion to the cylinder in such manner that the axis of the chamber whose cap is to receive the stroke of the hammer, becomes one with that of the barrel—all of which is simultaneously rapid. The stock or hand of the revolver resembles that of the ordinary pistol.

On the left face, and towards the back of the pistol body, an exterior spring is established. This spring is furnished with a small pin, which on a slight pressure passes through a hole practised in the face of the body, and places itself under the jaw of the cock so as to form a check and rest for that limb. When, either for the purpose of capping the nipples, loading the chambers of the cylinder, or to prevent the hammer from coming down on the caps, it is required to place the cock upon this rest, the cock is slightly raised, the spring pressed, and the cock let down on the pin of the spring: this being done, the cylinder can be rotated *ad libitum*.

To load. Having flashed a cap upon the nipples to clear them and the chambers from any dust, the cylinder-pin is drawn, the cylinder taken out, the chambers loaded, and the cock put at the repose on the pin of the side-spring designated above; the cylinder is then replaced, and the nipples capped. If required to load without removing the cylinder, the same mode of proceeding is followed, with this difference, that then the cylinder pin is not touched, neither the cylinder, except to make it rotate.

To carry the revolver safely when loaded, care must be had to leave the pin of the side-spring engaged under the jaw of the cock.

To fire, it is merely necessary to press upon the trigger: the action of the side-spring then immediately ceases, the cock rises and strikes.

To take the revolver to pieces. Press the spring; place the cock at the repose on the spring-pin, in order to rotate the cylinder freely; draw the cylinder-pin from its place, and remove the cylinder.

An important and highly valuable feature of this, the original Deane and Adams' revolver, was that its five chambers could be loaded and fired twice in two minutes by one accustomed to its use. And to this advantageous faculty of delivering ten shots in so short a space of time, this revolver was greatly indebted to the wadded-ball first and still sometimes used with it. The wadded-ball, whether spherical or cylindro-conical, differed respectively from other balls

merely in being cast with a stem upon which the wad was fixed. A special mould was all that was required, The wad of felt, or any other adaptable substance at hand, was readily made with a punch, having a centre-pin adapted to indicate the centre of the wad by imperceptibly perforating it. This wad was fixed to the ball by merely inserting the point of the stem of the latter into the centre of the wad, and clenching that point upon the wad, which thus became part and parcel of the projectile.

The wadded-ball was pressed, wad first, into the chamber upon the powder, and, by the simple pressure of the finger, not alone became fixed with the required adherence upon the powder in the chamber, but the powder, becoming confined by a body that permitted no escape of its gases, and which by its fixity to the ball always preserved a position perpendicular to the axis during its passage through the chambers and the barrel, it became impossible that any escape of the gases could take place ; whence derived the precision, the great range, and percussive force, which distinguished this revolver.

But it was objected, that this revolver had no loading-rod. Yet, since this revolver could be loaded without, by means of the wadded-ball, which gave such results (all that could be required of a portative fire-arm for rapid close aggression or defence), where was the actual necessity for a loading-lever-rod ?

It was furthermore urged—but how when you have consumed your wadded ammunition ? Yet the query of itself instigated the reply after clenching Hibernian fashion, by the counter query—Who carries a fire-arm for use without the necessary ammunition ? Besides, in case of emergency, any other kind of ball of the same diameter, with a pellet of paper on the powder, and another on top of the projectile, would have answered the purpose with this revolver.

Comparisons are said to be odious ; nevertheless, this odious propensity appears to be one of the number of those things inherent in our kind ; hence they must be natural, and can be conceived in that unamiable light only when their result affects personal interests.

The comparison of the intermittent, Colt, and non-intermittent, Adams' revolvers, has nevertheless been, and still is, an oft-mooted subject. Considering the difference of intent which their rotatory principle exhibits, the comparison, in our opinion, is scarcely fair to the former ; but as that comparison has been rather instituted as between revolver and revolver, be it so ; we will compare them in that generic sense, but, for the sake of impartiality to both, not with the so-called improved Adams, but as the latter first gained its prestige, and as the Colt was and still remains.

Spherical, cylindro-conical, or other balls, are used respectively with both. The Adams revolver has its three sizes, corresponding to the holster, belt, and pocket pistols of Colt : but they are neither so long nor so heavy as the latter, a natural result from the absence of the lever-ramrod, of the hemispherical shield, and the unpleasing brass furniture which overloads these.

The bore of the Adams revolver is much larger, as we have already elsewhere observed. The fire of Adam's pistol is of course much more rapid, from its differential character. The Colt must be cocked for each discharge ; the Adams is always ready for an instantaneous multiple fire ; for the movement by which its trigger releases itself serves also to cock the hammer. The merit of this combination was to be found in the Mariette revolver.

The Adams revolver is loaded more rapidly than the Colt. To load the latter, the lever must be released from its catch ; the rod must be set in motion to force the balls into the different chambers of the cylinder. A simple pressure of the finger sufficed to set the wadded-ball in the chambers of the Adams pistol. The latter has but five chambers, one less than the Colt ; but that advantage is counterbalanced by the greater bore of the Adams, its incontestible greater rapidity of discharge, and shorter process of loading.

Though less heavy, the Adams revolver is more solid than the Colt, for it never becomes shaky from the defective connection of the wood with the lock and body of the pistol.

Artistically speaking, it is more elegant ; and form, as well as attitude, has its attraction for the eye. The form in this case makes it more pleasant and convenient to the hand, and thus also for carriage, whether in the holster, belt, or pocket. This form of the Adams revolver admits also of the adaptation of a convenient magazine for caps in the butt of the handle ; a convenience which the metallic band surrounding the wood in the Colt pistol handle wholly excludes.

In the Adams revolver, the space between the rear of the cylinder and the rear of the pistol body is too narrow to admit of the cap splinters becoming lodged. The shell-like form of the separations which cut off all communications between the nipples being sufficiently cored out to allow the cap broken by the stroke of the cock-nose to fall off on the right of the pistol at each discharge, there is no risk of misfires, and the rotation of the cylinder is never interrupted. The Colt pistol cannot claim exemption from these inconveniences.

With all these distinguishing features of excellence, the original

Adams' revolver, depicted in the foregoing wood-cut, had some peculiarities of action and of external form which, though not positive defects in the non-intermittent principle of its design, were objectionable, and their co-existence with so much of intrinsic merit the more subject of regret.

To the gunmaker who, with a fair amount of skill and tact, possessed also an equal knowledge of pistol practice at the target, these exceptionable peculiarities were soon manifest, and as readily suggestive of means of correction. On firing the Adams revolver, a certain vibration accrued to the pistol during the triple, though almost simultaneous operation of cocking by the trigger, aiming, and firing; this was a consequence of the duplex cocking and releasing action given by the trigger to the hammer. This entailed a certain liability to deviation in shooting, further increased by the necessity of a too protracted pressure of the finger on the trigger, to determine the fall of the hammer. In which act of pressure, the finger soon got fatigued, and the hand became unsteadied.

Nevertheless, it is just to say, that with some practice in the pull of the Adams revolver, this was to be overcome. By pressing, for instance, so much only on the trigger while raising or inclining the barrel in the direction of the bull's eye, as to bring the cock nearly to the release; when, without sudden stress, but by an almost insensible pressure of the finger, the shot could be fired.

The exceptionable part of the form adverted to, lay alone in that of the trigger, but that was a real defect. It was so concave that it was almost semicircular, and instead of admitting the pressure of the finger in the way usual with a trigger, slightly curved at the tail only, it forced a half-bent position on the finger, and, of a consequence, the necessity of a too decided effort in the pull, which, communicated from the finger to the hand, gave, as matter of course, an unsteadiness to the pistol in the hand.

The eventual correction of this defect attested, at least, to its tacit admission, and the pistol was improved by it, *bon gré, mal gré*.

Much previous to this, however, the general recognition of the merits of the non-intermittent action carried out in the structure of the Adams revolver, induced other gunmakers to the application of various means, to constitute it *intermittent in action also*, at will. In England, Mr. Tranter, of Birmingham, imparted to it this valuable duplex action, by means of his well-known patented double trigger; in Belgium, the half-cock and full-cock action, without interruption of the non-intermittent principle at will, were given already in 1854 to the Adams revolver manufactured at Liège. And

early in 1855, the Mangeot-Comblain Revolver, with the duplex action at will, made its appearance in that country, not only as a new and formidable rival to the Colt pistol, but as the most dangerous competitor to the Adams revolver which had yet any where appeared. These improvements could not long remain a secret, and in the following year the Beaumont patented double-action followed in England, with the addition of another sear spring, which gave nevertheless a complexity to the Adams' normal lock parts which they had not before, and which, from its facility of derangement, effects often indifferently what has recently been infinitely better effected, without resort to the agency of another lock limb of so delicate a nature.

In the following tabular form, as we did with the breech-loading fire-arms, we have endeavoured to give a synoptical view of the most known of the modern revolver genus, or fire-arms with rotatory chambered cylinder.

1820-1	Collier . . .	London	. . .	Shot-gun	
	Lenormand . . .	Paris	Non-intermittent action.	Pistol	5 shot.
	Devisme . . .	Ditto	Ditto	Pistols and Guns	7 shot.
	Hermann . . .	Liège	. . .	Pistols	
	Mariette	Non-intermittent	Ditto	A revolving group of barrels, no cylinder, hammer acting underneath.
	Rissac	Ditto	Ditto	
1842	Philip Mathieu	Ditto	Shot-gun.	
1851	Colt . . .	U.S.	Intermittent	Pistol and carbine	
	Lang . . .	London	Ditto	Pistol	
	Barnett . . .	Ditto	Non intermittent	Pistol and carbine	
	Adams . . .	Ditto	Ditto	Ditto	Modified with double action by Tranter, Birmingham; Mangeot, Brussels; Beaumont, London; Brazier, Wolverhampton. Hammer at the side.
1854	Comblain . . .	Liège	Intermittent	Pistol	
	Haken Plomdeur . . .	Ditto	Ditto	Ditto	Do. lifting barrel, 6 shot, 3 bents to tumbler, vertical nipples. Simplified lock action.
	Mangeot-Comblain	Brussels	Non intermittent	Pistol and carbine	
	Loron . . .	Versailles	Ditto	Ditto	Charge a fulminant of special composition.
1855	Devisme . . .	Paris	Intermittent	Pistol	
	Lefaulcheux . . .	Ditto	Ditto	Ditto	
1856	Genhart . . .	Officer of Swiss artillery.	. . .	Ditto	Horizontal rotation of cylinder, barrel moved forward and back by a lever; admitting of replacement of second cylinder in 3 seconds, to keep up a sustained fire without reloading.

To cite the various patterns of revolvers that have since made their appearance would extend too much a subject which has already exceeded our limits; but that such should be the case indicates sufficiently that the revolver pistol—the arm which on its appearance in this country in 1851 was considered by the great majority more in the light of a curiosity better calculated for the private collection of an amateur of fire-arms than for real ordinary use—will eventually take the place of the percussion pistol, and banish the latter to that seclusion which was considered reserved for this new effort of mechanical art.

With respect to the value of revolvers as conveniently portable and efficient fire-arms for war purposes, it must be admitted, that whether of intermittent or continuous action, they are in their respective degree alike admirably adapted for attack and defence, and infinitely superior to the pistols they have superseded.

This was alike incontestibly proved by the Colt pistol in the Mexican war, and by the Adams and other revolvers in the Crimean and more recent Indian campaigns. As an arm for cavalry it is infinitely superior to the cumbersome carbine, whether smooth bore or rifle. For the defence of their guns it will give the artillery a reliable and deadly weapon at close quarters, and in cases of boarding furnish seamen with a far more energetic means of attack and defence. In fact, in every circumstance where the pistol has hitherto been resorted to as a weapon, in the hands of those who shall make themselves proficient in its use, it will prove of far more efficient service. But the necessity for this requirement is more especially a feature of the revolver than of any other arm; for as peculiarly *the* arm for critical conjunctures, and adapted more especially for rapid execution in the most sudden contingencies, it cannot be submitted to the same appliances for the regulation of its fire, and for the attainment of a precise calculation of distances, as the rifle. Hence a more thorough knowledge of the arm itself, of its manual, and a practised rapid appreciation of distances, is pre-eminently required, to turn the possession of a revolver to good account.



MUZZLE-LOADING FIRE-ARMS WITH GROOVED OR RIFLED BARRELS.

WE now arrive at a class of fire-arm which, but a few years only previous to the outbreak of the Russian war, had attained to a degree of improvement in the mechanical elements of its structure and adaptability to the general purposes of war, that, more than any yet effected in modern times, threatened subversion to the established notions of the Military world.

That arbitrator of modern battles, the Artillery arm, was menaced in its long-vested monopoly of range and precision, with the prospective establishment of an equilibrium in hands it had never dreamed to find it. The fire element of modern wars was about to receive an equally terrible exponent in the Infantry arm; one which not alone would curb the wonted dash of field-batteries to *within* the "shortest range," but impress a more than wonted respect upon the best led and most daring cavalry for the thinnest formation of that arm which it had hitherto been taught to despise.

The greater range and precision of fire obtained by barrels grooved interiorly, either parallel with the axis of the bore, or in a spiral, over ordinary or smooth-bore fire-arms, were things, as we have already observed, long since discovered. In our chronological notice of this kind of fire-arm, we expressed a dissonance of opinion with Captain Panot, as to the invention of the grooving or rifling of fire-arms being the result more of accident than theory.

That the loss of the powder-gas by windage and the consequent loss of ballistic force to the projectile, must have been a very early observation of the devoted amateur arquebuseers of Germany of the 16th century, in their constant target practice, is scarcely to be doubted. As probably, also, numerous attempts to alleviate or prevent these, would have resulted from that observation, and led first to an increase of the diameter of the ball, and to the resort to a means of facilitating loading, with a projectile which, by its increased diameter, decreased the ordinary facility of loading rapidly, as with the customary ball of less calibre than the bore of the barrel. The means resorted to as the most natural, were by forcing the ball with the stroke of a

mallet or very heavy ramrod ; and this process would, of a necessity, be followed by the observation, that a ball fitting so tightly in the bore of the piece, opposed a much greater resistance to the action of the gas of the charge of powder before it could be projected from the barrel. This would have led also, of a natural consequence, to the discovery of the necessity of giving a greater thickness of metal to the breech, where the pressure of the powder gas first impinged on the inert weight of the tightly fitting projectile. The further simply rational sequence, was the establishment of a heavy fire-arm, of great solidity of metal at the breech, loaded by a forcing process, to which the name of Carbine was eventually given ; for that name was first applied to *smooth* bore fire-arms of those characteristics, and not to a grooved or rifled fire-arm.

The further and somewhat later idea of grooving such arms in the line or direction of the axis of the barrel, to receive the residuum or deposit of the powder, and thereby not only facilitate the loading of the powder, but to increase both the bite or forcing of the ball, by impressing upon it the shape of the grooves, and to maintain it during its whole passage through the barrel in a direction more in harmony with the line of fire, was doubtless a conception established upon *no previous* existing theory or practice now to be traced ; but was born of that suggestiveness which in the individual founds for itself a theory based upon the likelihood of possible results. For we take all theory in its norm to be no more than the effort of a mental interrogation, wherein the suppositor of a new idea questions the possibility of any result he may have conceived as likely to ensue from such or such an act, form, or appliance—the primitive idea of which may have arisen from one or more circumstances considered analogous in some respect to the subject or principle imagined. The eventual successful test of such a conception, may incontestibly become the foundation of a theory, which though not worked out at the time by further research, would exist nevertheless as a dawning sentimentousness of principles not to be lightly disputed.

Upon trial, also, of the straight grooves to the barrel of the now become grooved or rifled-carbine, a greater precision for short distances would have been observed than with the smooth bore. This must of itself, therefore, have led to the establishment of a certain grade of theory, which it was endeavoured to amplify by various means, such as increasing the number of grooves ; of changing then the inclination of groove from the straight line to the spiral, with the view of creating a still further increased resistance to the gases—the effect of which form of groove, in considerably elongating the

spherical projectile would have been discovered on firing it into a sack of bran, sawdust, or any other yielding matter; and the superior precision of fire and range derived therefrom readily ascertained.

To deem the practised crack shots and armourers of a time when target practice was the constant recreation of the citizen and his pride to excel in, were so brainless as to conceive no theory (unelaborated though it may have been), and that all their even now admired efforts in gunnery, to which, without acknowledgment, we constantly recur for first principles—were the products of pure accident, is therefore scarcely a rational supposition.

Beyond the results adverted to above, as reasonable and sequential inferences, such as would have been made under the circumstances, we have no reason to believe they had yet progressed, nor that they were at once acquainted with the *duplex* movement given to the elongated projectile, and the assistance of that movement to preserve that precision which became well known only to some men of science at the end of the last century, to be again lost sight of or disregarded, until, under more favouring circumstances, it became in the present day the basis of a new and closely studied theory.

That in those days the results which we have seen achieved, were not attained to, was as much in the order of nature and reason as that we ourselves, with all our present advantages, shall leave much for posterity to elaborate and improve upon; which the self-glorification of that posterity may also assume as proof that *we* had but indifferently understood what we were about.

As a yet imperfect creation of the gunmaker's art, therefore, the rifled-carbine remained in comparative neglect, and, in some parts of Germany the arm only of the amateur sportsman and the hunter of the chamois, &c.; for which uses even, when like other fire-arms it was sought to make them lighter, to fire without the crutch, being compelled to diminish the charge yet more to prevent the bursting of the piece, and to diminish the recoil that would have been both insupportable and have prejudiced the precision of fire, the range became, of course, diminished, and the precision reliable only at short distances.

At frequent intervals, nevertheless, in the 17th and 18th centuries, the endeavour had been made to introduce the rifled-carbine of the hunter as an infantry and cavalry arm; and, as we have already shewn, some rifled fire-arms were introduced in the Bavarian army at the end of the thirty years' war by the Elector Maximilian; and Marshall Puysegur strenuously recommended the adoption of *rifled*

muskets in the French infantry of his day, at least of a certain number in each company throughout every regiment. Eventually the whole of the French carbineers (cavalry) regiments established by Louis XIII. received rifled-carbines, and several per company were given by Louis XIV. to other corps.

In the Seven years' war they appeared again in the field among the Austrian light troops, in which Frederick the Great imitated his antagonists by organising a corps of Jägers, armed also with the rifle. At the close of the last century, this description of troops had been established in the armies of all the greater and lesser states of Germany; and in the war of American independence, the rifle, there long established as the national arm for the chase, exhibited its superiority as a war arm also, over the smooth-bore musket of the British line infantry, in so sensible a manner, that we were constrained to oppose to the American hunters the subsidised riflemen of Hesse, Hanover, and Denmark.

In achieving the important position obtained by this arm in the present day, it has nevertheless effected no more than was predicted of it by Leutmann, the academician of St. Petersburg, in 1728, by Euler, Borda and Gassendi, and by our eminent but hitherto forgotten countryman, Robins, who in 1747 urgently called the attention of the government and the public to the importance of this description of fire-arm as a *military* weapon, and sought, both by his experiments and advice, to impress upon the military world his conviction of the advantages which must accrue from a closer study and development of the rifle principle in fire-arms. But neither the recommendation of the great mathematician, nor the dear-bought experience of the American war, were able to make any impression upon the unbending routine notions of the military authorities of that and the ensuing day, and with the exception of a lame imitation of the German organization of light infantry, and an eventual adoption of the heavy German rifle for the regiments now known as the Rifle Brigades, up to a very recent period we had made no attempt towards the study, and therefore improvement in the construction of this arm.

In order best to show the degree of improvement that has been made of late years in this arm, and especially in its most important feature, the disposition of the breech and the system and inclination of the grooves, we will first advert to the general condition presented by the rifle at the end of the last century.

As a sporting arm, excepting for large game, such as the chamois in Switzerland and the Tyrol, the bear and wolf of the north and east of Europe, and the furred game of America, its weight was still

always a great drawback upon its use ; requiring a greater thickness and weight of metal than ordinary barrels. Some were rifled with straight parallel grooves, but the majority in a spiral line, sometimes of half a turn, sometimes three quarters of a turn, and seldom more than the whole turn in a length of 2, 2½, and 3 feet ; deviations based, as it would seem, upon no principles transmitted to us as derived from attentive study and experiment, but arguing, nevertheless, a decided research for principles on which to establish a theory ; a conviction that we have been led to by an attentive examination of a great number of ancient rifles, in the numerous collections of arms that have at various times come under our personal notice, and from nothing so much as the fact that we have found in them tokens of research of a kind not only not met with or resorted to in the present day of multifarious imaginings, but *every one of those configurations of the spiral and forms of groove, &c., &c.*, which have been arrogated as modern conceits and discoveries !

The so-called *American "freed bore"* and "*gaining twist*" were not only among these antique tools, in all their boasted varieties of sharp breech-twist decreasing to the muzzle ; sharp muzzle-twist decreasing to the breech ; but a twist which we have never yet seen claimed by modern originality, viz., an increase of twist in the *middle* of the barrel, decreasing at both the extremities.

The grooves of the whole turn were nevertheless considered the most perfect spiral, which must be inferred from the greater number of ancient rifles presenting that turn. Their number, on the other hand, depended greatly on the fancy or caprice of the workman or amateur. Few were made with less than five, the greater number with seven, eight, nine, and even more. The depth of groove varied, but the deepest were considered the best, arguing from the same inference, that this is found in the greater number of ancient arms ; in which also prevails more the rounded groove, over those of triangular, rectangular, and indefinite form—all of which exist.

With all these attestations that a certain amount of knowledge respecting the real office performed by the grooves in the barrel had been acquired, and was still transmitted among those who continued the use of these arms in Europe ; yet was it still so little generally known, that it was a dubious question with many, whether, in a carbine rifled on the spiral, the ball, which to enter and take its place upon the charge was forced by repeated blows of the ramrod to assume the impression of the grooves, and follow their direction on its exit, did *actually* follow that same direction on issuing from the barrel. That this should have been a matter of doubt is, neverthe-

less, scarcely surprising, since the conviction of the fact is only of late years generally established; though the researches of Leutmann and Robins, at both extremities of Europe, had clearly demonstrated it. But, at the end of the last century, both in France and England, many gunmakers were persuaded of the contrary.

So much, indeed, was it then mooted as a matter of doubt in the former country, that in a public journal, called the *Affiche des Provinces*, of January 18th, 1775, a subscriber having asked through the medium of its columns, "Upon what principles of theory it was thought that the barrels of fire-arms, rifled straight or on the spiral, carried farther and straighter than smooth-bore barrels; the interrogator thinking, on the contrary, that the smoother and more polished the interior of a barrel, the less the impulsion given to the ball by the powder would suffer prejudice from friction, in the same manner as a ball driven along upon a very smooth sheet of glass, would be impelled much farther than upon the ground by the same force."

To this question, in the paper of the 15th February ensuing, the following reply was made:

"The effort of the powder increases in proportion to the resistance opposed to it. The ball driven with force into a rifled barrel, on the supposition and as should be, that it is of a somewhat larger calibre than the barrel, requires a greater force to displace it, goes farther, and is also better directed; because being engaged in the straight grooves which have impressed their form on the ball in expelling it from the barrel, it experiences no *beatings* from side to side in passing out, whereas in a smooth polished bore, the windage or the difference between the ball and the calibre of the barrel always affords it room to deviate more or less from the line of fire. With respect to arms rifled spirally it is an *absurdity*, for the leaden ball, driven into an ordinary carbine [we must hence suppose that straight rifling was the most ordinary method at that time] with a small ramrod of six or seven inches long and a mallet, the only way in which an ordinary carbine can be loaded, takes the impression of the groove on entering; so that the ordinary ramrod suffices to drive it afterwards upon the charge; but if the grooves are spiral, it is clear that the ball, *which can only be driven down in a straight line*, will receive no impress of the grooves, neither on its exit, *which can only be in a straight line*."

From the above, a tolerable idea may be formed of the general knowledge of the effect of spiral rifling at that period; though men like Leutmann and Robins had already both given very efficient reasons why *they* believed in this so-called *absurdity*.

In the earliest treatise which Robins published, "New Principles

of Artillery," speaking of cannon rifled spirally—for that method was then in use for artillery, though that has also been of late claimed and considered as a quite *modern* invention (the projectiles it will be readily understood were leaden balls)—he points out the advantages of those rifled pieces, for their precision of fire; but absolutely denies the increase of range attributed to them; and affirms from his own experiments, that if the persuasion exists that arms rifled spirally carry farther than others, it is solely because a target may be struck with those arms at distances twice or three times greater than with ordinary ones; not for want of range in the latter, but for want of precision of fire; and he thus explains this precision peculiar to rifled barrels:

In those that are not rifled, or whose bore is smooth and polished, the projectile acquires, from the friction experienced against the sides of the barrel, a movement of rotation, besides its progressive movement, or movement of translation. The position of the axis of this movement of rotation in relation to the movement of translation, is continually changed by the unequal pressure of the resistance which the air opposes to the anterior part of the ball; a resistance which Robins proved to be much more considerable than was believed before his time; and this change of position of the axis of rotation deranges the axis of the ball, by impelling it sometimes to one side, sometimes to the other, both above and below. Such is not the case with spirally-rifled barrels: in these the denticulated zone of the ball follows the inclination of the grooves; and this ball acquires, besides its movement of translation, a movement of rotation *round the axis of the cylinder*; a movement which it still retains after issuing from the barrel, and which perfectly and constantly agrees with its line of direction; so that the pressure exercised by the resistance of the air is equal on all the parts of the surface which first present themselves.

The development of the principles of this theory, therefore, is not the novelty it has been so generally considered; and Robins exhibited them long since in a masterly manner. Among other experiments by which he elicited them, it may not be uninteresting to our readers to cite the following, which served to prove to demonstration in this country, so long ago, that a ball fired from a rifled arm follows the inclination of the grooves; though it was not precisely undertaken by him with that intention, but only to ascertain, if in a spirally-rifled cannon, the semisphere of the ball which first presents itself from the mouth of the gun preserves that same position throughout its whole movement.

Robins took a rifled cannon (a six-pounder), and instead of a leaden ball, he loaded it with a ball of soft but elastic wood, which readily received the impression of the grooves without breaking. Firing this ball against a wall at a distance sufficient only to ensure the ball did not break on striking it, he always found that the part of the ball which first presented itself at the mouth of the gun, continued to move in the same position, and without any sensible declination, as it was easy to recognise, by observing the impression of the grooves of the cannon, and that of the blow with which it had struck against the wall. Were it necessary to convince any one of this in the present day, he might satisfy himself very easily by firing a ball from a rifle into a sack of bran or wool, when the ball would be found without the disfigurement it would receive on entering a hard body.

As regards barrels rifled with straight grooves, they may perhaps be considered to have very little advantage over smooth-bore barrels, when the windage in the latter is reduced to the minimum, and the ball somewhat tight and near to the calibre of the bore; but although they do not, like the spiral-grooved rifles, impart the movement of rotation round the axis (called in the modern French School of Musketry the normal movement of rotation), coinciding with the line of fire; which prevents it deviating from it, and which makes it bore its passage through the air like a screw; yet the straight-grooved rifle has at least the advantage, that it prevents the movement of rotation common to the ball of the smooth-bore, and which is so prejudicial to its direction.

This kind of rifle has been used by some sportsmen, particularly in Germany, to fire small shot, from the idea that it massed the charge better and threw it farther; a result which may be questioned where the circumstances and conditions are such as we have suggested above, between the smooth-bore barrel and its ball.

Up to the second decennium of the present century, the rifled fire-arms in use, both as sporting and military arms, were, in fact, to be met with almost exclusively in Germany and the United States. In the former they were, for the most part, shorter in the barrel, thicker in metal, rifled with from six to nine grooves turned in a flat spiral, on the average inclination of one turn in three feet, chiefly throughout the whole length of the barrel from breech to muzzle. They may be thus divided:—

1. The Stützen, or Rifled Carbine, restricted to some men in the flank sections of squadrons of regiments of cavalry, and the especial arm of the peasants of the Tyrol; from twenty-four to thirty inches in length.

2. The Rifle of the Jäger (light infantry riflemen), which fired from half to one ounce of lead at the utmost.

3. The Wall or Rampart Rifle of the same calibre as the Wall Musket, i.e., throwing from one to two-ounce leaden balls, to from 400 to 800 paces, with great precision, with from six to twelve grooves; weight from twelve to twenty-four lbs.

Despite the superior accuracy of fire of rifled arms over the smooth-bore flint musket then in use throughout the European armies, they retained still the special defect of their class: the process of loading them was slow, and difficult without great practice; hence their fire was slow, and did not fulfil those conditions of celerity required in an infantry arm. Rapidity of fire, more than precision, was therefore universally considered *the* desideratum in a military fire-arm; and every known means of structure in the proportion between the bore of the barrel and the ball, even to the establishment of a most prejudicial windage, was adopted to ensure speedy loading for the soldier's musket.

The general peace of 1815 brought with it the usual results of a general suspension from a long state of active warfare. The minds of men settled down once more everywhere to the more peaceful pursuits of life, commerce and the arts: but not to the latter only in their most peaceful occupation; for, strangely anomalous as the thing may appear, in the bosom of profound peace the minds of men, as though instinctively presentient of the uncertain duration of that blessing, address themselves unfailingly and more steadily to the improvement of the means of war. This was, nevertheless, evinced earlier on the Continent than in this country.

The attainment of a better fire-arm for light infantry than the slowly loading rifle and the smooth-bore musket had become a fixed idea with many foreign officers, who had become deeply impressed during the Napoleonic battles with the great inferiority of infantry fire, as compared with that element of modern war in the artillery arm: and already in 1816, General Rogniat urged the arming of the light companies in the French infantry regiments with double-barrel guns, in order to obtain a greater celerity of fire for the light infantry than was afforded by the rifle and ordinary musket; by which, not without reason, he imagined to give the skirmisher more confidence when opposed singly, or in small groups to the attack of cavalry, and to put a curb upon the audacity of the latter, with the ever ready and reserved fire of the second barrel, in moments of isolated and extreme peril.

In Germany, some few years after, an officer of the name of

Klipstein had brought forward, with the same object, a smooth-bore musket with rotating barrel ; and Percussion fire-arms were fast exhibiting a development which, as we have already shewn, promised a successful extension of their principle to military arms and the musket of the infantry soldier.

The proofs which numerous incidents had furnished during the Peninsular War of the value of the Rifle as a military arm, in a broader point of view than had been usually taken of it, were still fresh in the minds of the Hanoverian officers of the German Legion who had fought out those campaigns with us ; and with them, also, they made a more lasting impression than they had done with our own military men. One of these demonstrative incidents we will here cite, which had it been recalled to mind might have proved corrective of the notions into which our routinists had relapsed, with respect to the capabilities of light troops and riflemen in the character of Line's-men.

When, in 1812, the rear-guard of the Anglo-Portuguese army was pursued and attacked upon the retreat from Burgos to Valladolid by a numerous French cavalry, on which occasion two English cavalry brigades were brought into some confusion, the two light brigades of the King's German Legion became also engaged with the French Dragoons. These battalions had been 1000 strong, and one-third of these armed with the rifle. But the judicious principle had been pursued by their commanding officers throughout the operations, to keep the *rifled* arms as much as possible by the battalions ; for which purpose all sick, wounded, and other absentees from the ranks, left their rifles in exchange for a smooth-bore musket. Upon the retreat in question, the battalions were so much reduced in strength that the mounted officers could not be taken into the squares. Almost all the men were thus armed with the rifle ; yet did they, nevertheless, repel the frequently reiterated charges of the French cavalry ; and his Majesty the late King of Hanover, upon constituting from the débris of those battalions the present Hanoverian Jäger Regiment of the Guard, conferred upon them, as a memorial of their brilliant feat of arms in the Peninsula, the permission to wear the name of the place (Venta del Pozo) under the royal arms. Major Jacobi, of the Hanoverian service, in his critical remarks upon this arm, in 1829, proved also amply, that even in its then condition, it yielded in nothing, in the hands of those *who knew how to use it*, to the line musket, with all its boasted celerity of fire.

That this may not be deemed the citation of a mere isolated case, we will refer here, also, to the action at Montmirail ; where two

companies of Prussian riflemen, posted near Jeanvilliers, were suddenly threatened by a numerous body of cavalry, which had already broken some Prussian battalions of the LINE. Captain Neumann, the commanding officer of the Prussian Jägers, numbering 230 men only, in order to give his countrymen breathing time to re-establish their order, advanced with sword-bayonets fixed, and a loud hurrah against the enemy's cavalry. The latter immediately detached a squadron against them, which charged down upon the Riflemen. But so well-directed, and *so well-sustained*, was the fire of the latter who first opened, upon the word of their commandant, at fifty yards, that the cavalry were obliged to clear the front, right and left. Some few, it is true, closed upon the riflemen, and struck the sword-bayonets from their rifles, and one Jäger had his czako cut from his head. But not a dragoon could get into the little Jäger column, and the cavalry retired. Could the smooth-bore and its vaunted bayonet have effected more ?

The application of the percussion-lock to smooth-bore sporting guns, which, by the commencement of the third decennium of the present century, had wholly superseded the flint lock, had been resorted to with no less advantage to sporting rifles ; but beyond that improved method of ignition, the rifle had remained stationary, and the alleviation of the still existing difficulty and tediousness of loading that fire-arm had not suggested itself to any one ; until, in 1826, led thereto by that intuition which is the peculiar characteristic of genius, a French infantry officer, M. Gustave Delvigne, captain in the 2nd regiment of the Royal Guard—who had directed his attention to that very part of the rifle which it was generally considered would neither admit of nor required modification—drew the attention of the French military authorities to a remarkable improvement which he had effected in its interior structure.

Establishing his method of loading the rifle upon a totally different principle from that which had hitherto every where prevailed, he rendered that process more simple, easy, and speedy, than it had yet been ; and its prospective practical use in war became so obvious, that a greater interest was created in behalf of the long-neglected rifle than had before been entertained for it by military men.

As not only in France a strong disposition was evinced to detract from M. Delvigne's merit for this first step in modern times to improve the rifle, but also, at a later period, in England, when the principles laid down by Delvigne had been so successfully elaborated by French artillerists and others as to establish the fame of the improved *rifle-musket*, and its adoption in ten battalions of light

infantry specially organized and trained to its use—to dispute even the merit of all that had been subsequently effected in regard to the improvement of the rifle in France, although those results were known to us through, and had only been obtained by, the application, labours, and expenditure of twenty-five years on the part of the French military authorities, we think it just and due, previous to detailing Delvigne's improvements, to point out in this place the strange confusion of ideas and claims which have prevailed and been made in reference to this subject.

With regard to the hostile spirit long encountered by Delvigne in his own country, a disposition which he was as well prepared to expect as he was able to contend with, arising from that traditional jealousy with which the artillery in every service contemplates a suggestion to improve any thing which considered to belong to their special domain they would see emanate only from their own corps, that was a clear and intelligible sentiment; and, as the result has proved, one which more than any other led to that direct study of Delvigne's primitive thought which brought to bear upon it the united intelligence of the ablest artillerists and officers of his time and country.

But, on our side, actuated by that too frequently senseless national pride which submits with ill grace to the acknowledgment of a priority of merit for any discovery in art or science in the individuals of another nation, there were those who either invidiously sought to depreciate the merit of what had been done, or whose patriotic zeal went so far as at once to claim the merit not only of the first thought but of the first practical resort to its illustration in all the phases through which it had passed! The axiom that "men are but boys of another growth" was, indeed, never more truthfully illustrated than by the boisterous declamation and confusion of subject and things that distinguished here the discussion of the modern improvements effected in the rifle. Yet nothing, after all, was so susceptible of a clear exposition, assigning to each and to all their respective due, had the zeal of the disputants partaken of less of the mendacious personal vanity which forms so marked a feature in the clap-trap patriotism of our time.

What, in point of fact and truth, if those *were* the real objects sought to attain and to promulgate, respecting the modern improvements made in this ancient system of fire-arm, what was the primary and cardinal point to consider and discuss? What, in fact, had led to the important change which had brought that quasi repudiated weapon to the front, in supercession of the time-honoured smooth-bore musket?

To hear and to read the effusions of the claimants who sprung up on all hands on this side of the channel, a stranger to the matter would have thought, and might even still think, that the discovery of, or the return to the use of, the "*elongated projectile*," was *the* origin of or *the* first step made towards this important modern improvement in fire-arms ! And yet, though the Minié ball, in all its multitudinously diverse English conceptions, representations, and misrepresentations, or, in fine, every imaginable shape of solid, or hollow, or plugged, cylindro, conical, conoidal, ogivale, &c., &c., projectile, were the subjects put forward as though *they* had led to all that had been done, and were discussed and disputed as though the honour of the country depended upon a loudly claimed title to their respective invention—these, nor any one of these, constituted the real subject for consideration, *the* GENERATIVE IDEA, which gave the impulsion, to the development of which the elongated projectile *was only a subsequent accessory*. That generative idea, that something worth claiming the paternity of, was DELVIGNE'S ; and to him will it be assigned by history, when the clamorous crowd of original ball inventors, together with their pretensions, will have quietly subsided into oblivion.

Thus, as we have endeavoured to show, a conglomeration of the two very distinct subjects, the improvements in the interior structure of the arm itself, and the subsequent essays with and modifications of the projectiles adopted (re-born, if we may so express it, of the former), was and is still made by the great majority of persons when adverting to the modern improvements in the rifle. Though this may be excusable in those who are unconscious of the facts relating thereto, yet others who it might be presumed cannot plead such ignorance, have evinced an unwillingness to institute that clear severance of the two subjects which really belongs to them in the order of time, and which alone can facilitate the reduction of the question and its merits to their proper elements.

We will now proceed to describe the fundamental idea conceived by M. Delvigne, the correctness of which was confirmed by experience ; which has completely changed the method of loading the rifle, and established a more defined conception of the requisite co-relation of the several elements of its structure, to render it applicable to the general purposes of an Infantry arm.

In the early campaigns of the first French Revolution, the greater accuracy of fire of the German Sharpshooters, armed with the old rifle, was of such frequent remark that several attempts were made to re-introduce it in the French armies, in which it had long been

abandoned on account of the difficulty and slow process of loading it. Its re-introduction was nevertheless not effected, from a variety of causes, and it had therefore fallen wholly into disuse in France as a Military arm, until under the Restoration, M. Delvigne drew attention thereto by the remarkable change he had effected in its interior structure.

Previous to this, as already adverted to, it had been customary to load the rifle with a ball nearly of the same diameter as that of the bore of the barrel inclusive of the depth of the grooves. By means of a ramrod and mallet, this ball was forced into the muzzle of the piece, on entering which, the lead was stripped as it took the impress of the grooves, and then driven down the barrel upon the charge of powder. This operation was a long one, requiring a very strong ram-rod and the mallet aforesaid.

The spherical ball thus forced into the old rifle became, as a matter of course, elongated about the depth of a finger, and assumed a *cylindrical* form. It thus became in reality an *elongated projectile*; the fire and range of which became the more accurate and greater from the fact of its having become thinner, meeting thereby with less resistance from the air in its flight.

Strongly impressed with the defectiveness of this method, so long resorted to, of forcing the ball; by which, in effecting its dilatation, the full expansion of the force of the charge was impeded, the powder itself deteriorated in strength by excessive compression, and the ball deprived moreover of that harmony of form which is so necessary to its precision of motion; M. Delvigne, without deviating from the cylindrical form of the barrel, contracted the breech part of the barrel in the form of a cylindrical chamber of somewhat less diameter than the bore, for the reception of the powder charge. The powder being poured into this chamber, he introduced a ball admitting of very little windage, but nevertheless of a calibre small enough to enable it to *roll down* the barrel until it took its place on the shoulder of the powder-chamber. The ball having thus found a solid bearing or lodgement for that part of its periphery which rested on the edge of the chamber, M. Delvigne, with two or three strokes only of an ordinary ramrod, flattened the ball in such manner that it took the form of the grooves in the barrel, which it filled, excluding all windage, without having been previously stripped and disfigured in its forced passage down the bore as in the old process of loading.

Those whose unenviable idiosyncrasy it is to detract from the merits of the living, and to concede to the dead only their praise, for that these, can no more emulate or eclipse them, may urge that

the establishment of a chamber in the breech of a gun-barrel was by no means a new idea. Neither was it in mortars, as we have shewn, but it was a wholly new application to a *rifle*, and one which alone admitted of loading it with a ball that would roll down the barrel unforced. And it is incontestible that M. Delvigne made known a method of loading the rifle such as no one before him had applied thereto, to adapt it to the purposes of war.

The idea furthermore suggested itself to M. Delvigne, to avail himself of this invention to discharge explosive projectiles, the anterior part of which was furnished with a detonating cap, which, exploding upon coming in contact with any hard body, could be successfully applied to any purposes in war. These rifles and their projectiles were submitted to trial at the siege of the Chateau de l'Empereur in the French expedition to Algiers.

Though the rifle was an arm of ancient date and is still in use in many countries, the conditions on which it should be established, in order to effect in an efficient manner all that was required of it as a Military arm were but very little if at all known. No definite data existed, in fact, respecting the inclination of the spiral of the grooves, their number, depth, or breadth, conformable with the bore, the length of the barrel, the weight of the charge, &c., &c.

M. Delvigne, in his study of the pre-existing rifled arms, had detected with remarkable intelligence the constant want of harmony between the movement of normal rotation and the movement of translation given to the ball; a defect derived from an ill-grounded and superficial intelligence of the degree of inclination of the spiral proportionate and proper to a given length of barrel.

It was also during his unremitting application to the improvement of his rifle for the projection of the ordinary regulation or spherical ball (for at that early period of his labours no other form was deemed admissible), that he achieved a near solution of those points in the structure of a rifle, over which had always hung a mist of doubt and uncertainty. He succeeded, in fact, in constructing a rifle, with which, with a certain inclination of spiral and number of grooves, with a certain charge, and a ball of given weight, he could strike the bull's-eye with remarkable precision, even at a greater distance than that where all precision with the infantry smooth-bore musket entirely ceased.

It was, as we have said, previous to 1826, that M. Delvigne first laid the product of his studies before the notice of the French military authorities; but, not until 1849, twenty-three years afterwards, had he at length the satisfaction to find *one* eminent French

artillerist render him justice by the admission, that the "Delvigne carbine had changed all the old-established ideas of rifled fire-arms." But he had not achieved this at one bound ; it had been the result of a progressive development of a correctly-conceived idea ; and for this reason, as it passed through its different phases, it received the usual treatment of a new idea, it was declared unsound and worthless, or at any rate not new ; though it was he who, two years previous to the conquest of Algiers, had solved the problem of centuries, *how to load the rifle as rapidly as the smooth bore !*

As researches attended with great difficulty and labour are not unfrequently made in order to trace out the origin of important inventions, we think that a clear and concise exposition of the principal facts which led to a change in our time so important and interesting to the art of war, will be deemed as justifiable in the opinion of our readers as we are disposed to consider it. We will, therefore, trace back and pursue this subject through the different phases it has assumed up to the present moment.

The trials carried out at Vincennes in 1829, with twenty rifles made at the personal expense of M. Delvigne, presented a superiority of precision over the Regulation smooth-bore musket in the ratio of 7 to 1 at a distance of 200 metres. The charge of powder was 5 grammes, instead of $9\frac{1}{2}$, with less recoil, but also with less initial velocity imparted to the ball. On increasing the charge of this new rifle to $7\frac{1}{2}$ grammes, it acquired a superiority of initial velocity, but the range was less.

In point of fact, the rifle established up to this period by M. Delvigne, though loaded by a very easy process, with a weak charge and a spherical ball of very slight windage, and giving a remarkable precision at no very great distances, and for a certain number of rounds only, did not preserve the same percussive force as the ball of the infantry musket at those distances, though without any precision whatever. The ball, moreover, having little windage, did not pass down the barrel with the same facility after a certain number of discharges, although its introduction was nevertheless always facilitated by the grooves, which became the receptacle of the powder residuum. In the chambers, also, after frequent firing, a residuum collected, which eventually left the powder less room in the chamber, and of a necessity it then reached above the shoulder of the latter ; so that the ball found its place directly on the powder, instead of upon the shoulder of the chamber itself, whereby it was not so effectually dilated by the stroke of the ramrod into the grooves, which, being also clogged with the residuum of the powder, could not

exercise their function so well upon the ball, which was therefore driven from them readily, and the precision of the fire greatly impaired.

Other means were suggested to remedy this defect, in 1833, by Lieut.-Colonel Poncharra, of the Artillery, who proposed a modification of the Delvigne system. One was by means of the introduction of a thin greased patch (canepin) introduced with the ball at every loading, so that the grooves became cleaned after each discharge, and were thereby enabled to resume their function. This thin patch was subsequently fixed to a small sabot, or cylindrical wad of wood, of the length of half the diameter of the bore (suggested by one Brunel). The patch was attached to that end of the sabot which was placed upon the powder, which sabot, assuming its place upon the shoulder of the chamber, became the resting-point upon which the ball was forced, to dilate into the grooves.

By the interposition of this non-malleable substance between the chamber and the ball, for the reception of which it was sometimes somewhat coned out on one side, the forcing of the lead into the chamber was prevented; but several inconveniences attended its use. The sabot frequently broke during the operation of ramming down the ball. The Delvigne-Poncharra rifle was of the weight of 7lbs. 14oz., instead of 10lbs. 2oz.; and the cartridges having the sabot and patch, required special tools for their making, and were therefore of a complicated character.

Thus far had things progressed, when in 1838 the Duke of Orleans, with his royal father's permission, organised at Vincennes the first experimental company of Chasseurs à Pied, armed with the Delvigne-Poncharra rifle; and this troop received a specially characteristic training in every respect. At the end of that same year, provisionally increased to one battalion, the military value of such an organization became so apparent that in the autumn of 1839 it was made permanent, and received by general award the designation of the Tirailleurs de Vincennes. Sent to Algeria in the beginning of 1840, it achieved for itself, by its service against the Arabs, a pre-eminent position in the general estimation of the army. The threatening prospects of war in 1840 induced a general augmentation of the French army, and in September of that year the formation of ten battalions of Chasseurs was resolved upon. Upon this the primitive or normal battalion was recalled from Africa to serve as model-troop for the organization of the new nine battalions.

The wish expressed by that experienced soldier, Marshall Soult, in

1839, that France might soon have thirty such battallions, was fast progressing to fulfilment.

In the pattern of the Delvigne-Poncharra rifle established by Captain Thierry of the Artillery, for these ten battallions, designated two years afterwards by the name of their founder, the Chasseurs d' Orleans, some change was introduced. It was of the same weight and bore as the Line Infantry musket, with four broad grooves of one turn in six metres, and fired the cylindro-spherical ball.

By dint of practice with an arm of such precision, not only was a remarkable skill in shooting developed in this new description of light infantry, but a far higher influence in a military point of view was visible in the development and perfection given to the instruction or rather to the expertness of the soldier. The establishment of the Chasseur battallions gave rise to that of the new School of Musketry, which gradually led to the foundation of a method of instruction in the use of the rifle which was at once simple and of easy application, not only to teach the use of the elevating sight, but how to shoot with a precision hitherto unknown in the infantry ; and which, eventually propagated throughout the whole of the French infantry of the Line, could not but become of the most essential service.

As it may not be uninteresting to the reader to be informed of the degree of shooting skill already attained at this time by the troops adverted to, with an arm as yet only in one of its earliest phases of improvement, the following table of the target practice of the men of one year's service only, in these battallions, may prove acceptable.

At 200 metres 40 per cent. in a rectangular surface of 2m. by 0·57			
300 50	2 ·14
400 40	2 1·71
500 25	2 2·58

When on service in Africa, nevertheless, the precision of fire of these troops could not always be available, on account of the difficulty to supply them everywhere with the special cartridges then required for the arm ; which serious inconvenience was shortly to be dissipated by the further improvement introduced by Colonel Thouvenin of the Artillery.

We will here for a moment turn our eyes to Germany, where the attention of military men to the perfection of the muzzle-loading rifle had received no small impulse from the success which had so far attended the researches of the French military Commissions on the new principles of structure and loading developed by M. Delvigne.

In Germany, the nearest approach to a practical application of the improvements in the infantry arm was made, as we have elsewhere noticed, by Captain Berner, 1835, whose rifled musket, with *elliptical* bore, was considered by the Royal Hanoverian Commission admirably adapted for the Jäger corps.

In England, nothing had yet been done towards a progress in this direction, save and except a resuscitation of the rifle with two straight grooves, and the belted spherical ball, by Mr. Lovell, the late and ultimate inspector of small arms to the British Board of Ordnance; a rifle then in use in the Brunswick Jägers, some of which pattern were supplied to the Euphrates expedition; and subsequently, in 1837, Lord Vivian being Master-General of the Ordnance, to our Rifle regiments, in substitution for the old eight and ten-grooved rifle of the Peninsula War. This, the so-called Brunswick Rifle, was an arm of precision at no great range, and was furnished with a back sight for 200, and a leaf sight for 300 yards.

Reverting in the order of time to the improvements taking place in France, we arrive at that of Colonel Thouvenin, in 1844, the now well-known and war-tested, Pillar-breech-rifle, which in the hands of the French Chasseurs-à-Pied in Algeria, at the siege of Rome, and lastly at Bormasund and in the Crimean campaign, gave a flat contradiction to the wisdom of its detractors in this country. Carrying out Captain Delvigne's primitive idea of the dilatation of the *spherical* ball, though that officer had urged the study and application of elongated projectiles (the second cardinal feature in his patent of invention), after the favourable results he had obtained from them in 1830 at Vincennes; and the very accessory by which he had reiteratedly proposed not only to give his rifle a greater *range* than the musket, but as great a precision at that range as his rifle had given at a less range with the Regulation spherical ball, to which he had been officially restricted in his first labours; and further, despite his recommendation of the use of the third element of his primitive conception, the HOLLOW CYLINDRO-CONICAL bullet, by which, without the stroke of the ramrod to produce dilatation, he effected that operation by the action of the powder gases themselves, upon the base of the bullet, forcing it thereby more effectually on the discharge, by the very action of the powder itself, without the flattening of its anterior part by the stroke of the ramrod: all features recapitulated in his additional patent of 1841, four years before Colonel Thouvenin's modification. Yet did the latter officer, faithful to the regulations of routine, first address himself to the use of and the

retention of the *spherical* ball, with his modification of breech of the Delvigne rifle.

The result of this adhesion to antique military prescription, was that Colonel Thouvenin's modification of the breech, was on the point of being rejected; had not Captain Minié of the Chasseurs d'Orleans, and Captain Tamisier of the Artillery, come to the rescue. The two latter officers, the one Inspector and the other Professor of the School of Musketry at Vincennes, engaged for several years in the practice and study of those improvements in the rifle to which Delvigne had given the impulse, had acquired a great experience and knowledge of the subject. M. Minié had moreover acquired no little extension to that knowledge from having assisted at M. Delvigne's frequent experiments with his hollow cylindro-conical bullet. The spherical ball was therefore abandoned, and M. M. Thouvenin, Minié, and Tamisier, resorted to the use of a cylindro-conical bullet; but *solid*, or, in other words, without a hollow at the base, as used by Delvigne for his chamber, since the solid projectile was best adapted to take its place upon the steel pillar, which screwed into the breech plug of an ordinary rifled barrel, performed the office of the shoulders of Delvigne's chamber, to procure the dilatation of the projectile when forced down by the ramrod.

The resort to this configuration of an elongated projectile, effected therefore, by a different means only, the object preconceived by Delvigne; and that officer was yet more justified in the correctness of the views which he had advocated so much in 1830. He had the consolation at least to see that no less than three features of his primitive suggestion had been compulsorily resorted to. The dilatation on the breech of a projectile fitting easily in the base of a rifle, though the conformation of that breech might be different; the adoption of an elongated projectile, and of the very inclination of spiral which he had established in *his* rifle, the result of his long study of that especial element to the attainment of a just accord with the other structural conditions constituting a good arm of the class.

In the new modification of the rifle thus established by Colonel Thouvenin, a steel pillar, of the length of 48mm. = $1\frac{1}{2}$ in, 10mm, or $\frac{2}{3}$ of an inch of which, are screwed into the breech-plug, the axis of which pillar, coincident with that of the barrel, permitted the powder to take its place round it, and then formed the bearing-point upon which the cylindro-conical projectile, called the primitive ball of Captain Minié, was dilated in its posterior part into the grooves, by the strokes of the ramrod. The Delvigne chamber, which had been

adhered to in the French pattern rifle of 1842 was therefore suppressed, and the pattern of the musket of that year, with a plain flat breech, adopted, or rather applied to the adjustment of the steel pillar of the Thouvenin system ; a circumstance which, in a financial point of view, presented an indisputable economical advantage ; that namely, of the easy transformation of the ordinary musket of the French army, and indeed of all smooth-bored muskets, to pillar-breeched rifles. Nothing more was required than to screw a steel pillar into the base of the breech, and to rifle the barrel ; things of easy execution.

In the French muskets, nevertheless, one obstacle seemed to present itself to the latter process. Some years previous to the appearance of the Delvigne system, the barrels of all the French muskets had been bored to a larger calibre, in order to fire the spherical ball of 17mm., instead of the former ball used of 16mm. 3. This was greatly regretted, after the skilful labours of Captain Tamisier had shewn the means by which a usually constituted musket barrel might be rifled with a *progressive depth* of groove ; although had this decrease of the thickness in the French muskets not have been effected, it is probable that Captain Tamisier would not have directed his study to remedy that defect in the conversion of those arms to rifles by that new process. To effect this, without too much weakening the barrels of the old muskets, transformed to the new calibre of 18mm. (the same as that of the new pillar-breech rifle), the thickness of the metal at the muzzle of which was only 1.70mm., Captain Tamisier imagined the progressive decrease of *depth* of the grooves, so as to preserve it greater at the breech than at the muzzle. This mode of groove,* which presents very remarkable advantages, even for the precision of fire, was adopted. The improvement produced in the precision of fire by this mode of rifling appears to arise from the circumstance, that by this method the lead of the ball *impinges against the bottom of the grooves during the whole of its movement* of translation through the barrel.

In the barrel rifled upon the Tamisier system, the depth of the grooves is uniform from the posterior part of the breech as far as 0m. 40 from the muzzle, progressive as far as 0m. 20 farther, and lastly, nil for the space of 0m. 20 : by this means, the weakest part of the barrel is left intact ; that, on the contrary, which begins to have some consistence, is grooved but slightly ; and, lastly, the solid part only, the breech, is rifled to the depth of 0m. 5.

To this mode of rifling an objection was nevertheless started at the

* It must not be confounded with another form of groove, called the progressive spiral or twist.

time, to which, as is so frequently the case, more importance was attached than it merited. It was considered that the friction at the muzzle of the arm—the part where it was not rifled—would greatly diminish the velocity of rotation; and the forcing of the ball, which then increases on its passage, if it were very considerable, would even arrest that movement. To obviate this inconvenience, it was first suggested to prefer a spiral turn of 1m. 00 (3ft. 3in.) to that established by Captain Thierry of 2m. 00 (6ft. 6in., or half a turn in 3ft. 3in.); and here the justification, tardy though it was, of Captain Delvigne's *original* turn of one in 6ft. 6in., was involuntarily made evident; for the deviation of the ball became so sensible, arising from too great a velocity in the movement of rotation, that it was concluded the friction at the muzzle had little or no influence, and a return was made to Captain Delvigne's inclination of the spiral.

Another method of rifling was now invented by Captain Minié. This consisted in the introduction of an iron cylinder, of the same calibre as the arm, and 0m. 10 in length, into the barrel. Four bands of iron, each 7mm. in length and 0mm. 4 in thickness in their centre, were taken off this cylinder with the file. The cylinder, the upper part of which is on the same level or plane as the section of the muzzle, leaves between the barrel and itself four spaces, represented by the quantity of iron that has been taken off, and their direction is that of a fraction of the spiral of a turn in 1m. 50.

By means of an instrument constructed for this purpose, the barrel being compressed in such a manner that every part of it, from the muzzle up to 0m. 10 distance from it, coincides perfectly with the cylinder; grooves are obtained in relief, which impress themselves on the ball, and give it the required normal movement of rotation. It is indispensable that the parts taken off the cylinder should gradually decline in depth, and not have the same depth everywhere; so that the fields or smooth spaces of the barrel may agree with the grooves, without forming any unevenness or abrupt rise.

The pillar-breech rifle of 1846, which had thus replaced the chambered-breech rifle of 1842, exhibited a precision of fire and range greatly superior to those of all the officially devised arms which had preceded it. But it must not, therefore, be presumed that the Delvigne rifle, using the cylindro-conical ball of its inventor, was surpassed in precision and percussive force at long ranges, for the following table will concisely shew to what he had attained with his rifle at trials made in July and August, 1844, in the presence of the Official Commission and of M. M. Arago and Seguier of the Academy of Sciences.

Firing with the elongated ball called cylindro-conical, of the weight of 47 grammes, not quite 1½ oz. English, charge of powder, 4½ grammes, = 1 dr. 3 gr. English.

Distances fired in metres.	Average distance in Eng. yards	Dimensions of targets in feet, &c.				Number of boards behind each other.	Number of hitting balls per cent.	Number of boards pierced.
		Height in feet.	Breadth in feet.	Thickness in lines.	Surface in square feet.			
400	440	6	12	10	72	5	83	5
500	550	6	12	10	72	5	62	5
600	660	6	12	10	72	5	51	5
700	770	6	12	10	72	5	31	5
800	880	6	18	10	108	5	32	5
900	990	6	18	10	108	5	31	4
1000	1100	6	30	10	180	5	34	3
1100	1210	6	30	10	180	3	32	2
1200	1330	6	30	10	180	3	12	2
1300	1440	6	30	10	180	3	8	1

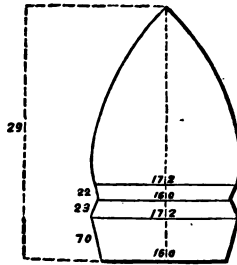
By the sixth column of the above table, it will be seen that the target which served as point of sight to M. Delvigne's rifle varied according to the distances; that its greatest superficies in square feet did not exceed 130 feet at the distance of 1440 yards; and that his rifle drove home 32 per cent. at 1210 yards.

The elongated projectile suggested by Captain Minié for Colonel Thouvenin's pillar-breech rifle required a specially counter-sunk ramrod, adapted to fit the anterior part of the bullet so precisely that no disfiguration of that important part should ensue on ramming it down the barrel. The formation of this cavity in the heel of the ramrod was and is one of the most delicate parts of this rifle; and it is required to be so nicely cut, that the ramrod when capping the bullet on forcing it down the rifle, should fit exactly upon and embrace the apex of the projectile with the very bottom of the cavity. The salient horns or sides of the cavity and contour of the heel of the ramrod are rounded off.

The anterior part of the first elongated bullet proposed and used by Captain Minié, was ogival* or lanceolate in form, the posterior part in the form of a truncated cone; these two parts were united by a neck. Its weight was about 47 grammes, its diameter 17mm. 2, its height or length, before it was forced down the barrel, 29 mm.; after forcing, that height was reduced to about 26mm. 8. This ball

* So called from its resemblance in anterior outline to the architectural form of the upper part or apex of windows in the ecclesiastical structures of the 13th and 14th centuries, termed *ogivale* by French architects. This would be perhaps well expressed by the English word lanceolate, were it more curt to express.

was *solid*, and the appended diagram will best illustrate its conformation.



We have been thus particular in our detail of this projectile, for the purpose of convincing our readers of the error which has been and is still customary with most persons in this country, to affix the name of "Minié" not only to the improved rifle-musket introduced in France, but to the cylindro-conical type of bullet generally, which in reality he had imitated from Delvigne's hollow projectile of that form, and of which hollow projectile he subsequently produced the modification with the well-known *iron cup*, bearing of right his name, with the *solid* primitive ball above depicted, of his adoption for the pillar-breech rifle.

Yet so general was the misapprehension on this subject, that the iron-cupped Minié was considered his only creation as regarded projectiles; and we found that this limited idea prevailed even at Enfield as late as 1852; and those who had designed and patented modifications of *solid* elongated projectiles for their rifles, assumed to themselves that they were first in the field with the idea of *solid* elongated bullets, though these in every variety of shape were generally known as in established use in Belgium, Prussia, various other parts of Germany and Switzerland, for the flat-breeched so-called Minié Rifle, from 1842 to 1848.

No greater evidence of the little attention that had been addressed to this subject in England could well be adduced; yet was it one that throughout the Continent we had found a general subject of experiment and research, while as far as we could ascertain, one solitary British gunmaker, Mr. Greener, distinguished for his intelligence and zeal in all that related to the craft of gunnery, had in 1841 introduced an expanding projectile of a nearly spherical form, the dilatation of which was produced by means of a plug.

Reverting to our present main subject, the pillar-breech rifle and its projectiles, to the assiduous theoretical and practical study of

which by the highly-gifted Tamisier, the modern Science of the Rifle, as we may now verily designate it, is so greatly beholden ; and who, with his able colleague in research, Minié, has achieved with Delvigne an inseparable trinity of repute, as historical names in the annals of fire-arms. We will address the reader's attention to a summary of the results obtained in the experiments prosecuted by him under the order of the Minister of War.

Of these experiments, which extended over a period of several years, Captain Tamisier was instructed to note every consecutive fact elicited, and to connect them as much as possible by theory. In combination with his collaborators, he concentrated all the powers of his perspicuous intelligence upon the subject, and introduced in those experiments that order and method which were necessary to obtain for them a permanent and substantial result.

There was, nevertheless, not only a want of geometrical symmetry in the neck of the Minié solid cylindro-conical projectile, but at great ranges, and these extended up to 1300 metres, its deviations became frequently so great that it was considered objectionable.* Tamisier was induced to the study of more simple forms. The neck-like feature in this bullet had been resorted to to facilitate both the dilatation of its posterior part in the grooves by the stroke of the ramrod furnishing as it did a less thickness of metal, and therefore less resistance at that part, and to serve as a receptacle for the greased ligature which kept the ball in its place in the made-up cartridge. A wholly regular cylindro-conical form was therefore tried, and of this form of bullet he varied successively the length of the cylindrical part and the angle of the cone. Having remarked that these variations greatly influenced the precision of fire, he sought for the causes of those effects, and the explanation which he found led him to practical consequences, which Captain Favé of the French Artillery adverts to in the following words.†

“ The ball while in motion in the trajectory, describes a curve, the element of which changes in its direction every moment. In order that the elongated ball may maintain its point directed forward, it is necessary that its axis should change in direction, in proportion as the element of the trajectory changes its direction, in order to remain, or rather to be brought back always, in the direction of the tangent of the trajectory.

“ The mind does not easily grasp this idea of the necessity that the

* On the other hand, this ball fired from a flat-breeched rifle, shewed a great superiority of precision at 200 metres, over the spherical bore.

† Notices Historique sur les Nouvelles Carabines.

axis of the ball should follow the changes in the direction of the trajectory. It might be believed, on first consideration, that the axis of the ball ought to preserve, during the whole duration of the movement, the direction it had at its departure; which neither is nor ought to be the case. We will suppose, in fact, that the axis of the ball remains parallel to the position it had at its departure, from which it would result that the angle made by that axis with the element of the trajectory, or with the direction of the movement, would change every moment. The action of the resistance of the air would change at the same time as the surface presented by the projectile. The point of impact of this force would not always pass through the centre of gravity, and a movement of rotation would ensue different from that with which the ball was originally impressed. This effect, on the other hand, *cannot be completely avoided*, but it is necessary that the axis of the ball should always tend to *return* upon the element of the trajectory. Hence there exists the necessity of an *action of the air, to assist in guiding or directing the ball.*

“When the ball passes from one element to the other of the trajectory, its axis is inclined in regard to the new direction of the movement; then the existence of the neck and the movement of rotation concurring to render the friction on the posterior part of the ball more considerable on the side to which it inclines, that friction reliefs it, and tends every moment to bring back its axis in the direction of the tangent to the trajectory. M. Tamisier, starting from the principle that the more energetic the cause which tended to replace thus the axis of the ball on the element of the trajectory, the greater would be the hope of obtaining a precision in firing, was led to an invention which gave a new phase to the question of rifle projectiles.”

As the long series of practical studies made by Captain Tamisier to ascertain the correctness of this conceived principle are of the highest interest, we will advert to them here as succinctly and clearly as our space will permit; for we consider that they should be as generally known as possible; and for the further reason, that we have seen some very weak, yet dogmatical attempts at argument resorted to, to throw doubt upon the value of labours which tended so materially to the increase of what we do know of correct in the theory and practice of the rifle, and threw a light upon the subject such as never would have shone from the small lamps which kindled at his beacon have thought to eclipse his brightness.

It must moreover be considered, that the researches made by him

and his colleagues were not carried out upon the narrow limits which the pecuniary means of a private individual only can appropriate to such labours, but they were prosecuted under the encouraging auspices and with the liberally granted means of an eminently military government, that had called into life a description of troops—a real *light infantry*—whose organization had fixed the attention and admiration of the most military continental powers; and whose perfection and increase bade already fair to become an important state interest of France.

In order to increase the precision of fire of elongated projectiles Captain Tamisier thus bethought him that it was necessary to establish as much as possible certain faculties of resistance behind their centre of gravity. To this effect, he first endeavoured to bring his centre of gravity as far forward as possible; but in order to do this he had been led to a flattening of the anterior part of the ball, which increased greatly the initial resistance of the compressed column of air in the barrel on the projectile's passage out, and to its whole movement of translation through the air. Upon mature reflection on this subject, he conceived the idea of resorting to another means of lifting the ball at every movement throughout its flight; this was to create resistances which should act in those circumstances when the axis of the ball does not coincide with the direction of the movement. He therefore established on the cylindrical part of the ball, in place of the neck, as many circular channels,* of 0m. 0007 in depth, as that cylindrical, or rather very slightly conical part, would admit of. What was the result? Why, the precision of fire was immediately increased.

Here the practice did justify the theory, and a theory which, so borne out, we have seen repudiated. By what? Not by the test of practice, but by ill-argued and lamely-supported theoretical deductions only! There exists no generally acknowledged truth which could not be assailed after such fashion; but how it recoils on the disputant we need not observe.

M. Tamisier instituted a great number of trials in this sense, and he discovered that it was necessary to render the posterior surface of the channels, as *sharp* as possible, to increase the action of the air; but as, on the other hand, he found these channels become deformed

* We have retained, or rather literally anglicised, the French terms *canneles*, & *cannelures*, because we have considered the English explicative of these words has not been thoroughly rendered by the words *grooved*, with *grooves*. *Channelled* or *chamfered* are the words which, to our thinking, best convey the idea of the sharply angular conformation of the cylindrical part of Captain Tamisier's projectile.

from the yielding nature or malleability of the lead under the stroke of the ramrod, it was requisite to proceed cautiously, and step by step, to arrive at the establishment of the form of ball most advantageous for practical use.

By the application of this new principle, the use of balls of any length and form could from this moment be resorted to. The primitive type of the Minié (cylindro-conical solid) ball, which could not be modified without depriving it of its properties, could now be departed from. A *certainty* had now been achieved of the practicability of firing oblong balls on a larger scale; for it was now known that it was necessary to retain as valuable the sharp edges of the channels, while before that, no great account had been made of the form of the neck, the utility of which, beyond what we have adverted to already, was not known. It is therefore not improbable, that the use on a large scale of the advantages since derived from the cylindro-ogival channeled ball of Captain Tamisier, would have been lost to the French battalions armed with the pillar-breech rifle, or at least indefinitely deferred.

In order to convey a somewhat distinct idea of the phenomenon which had been observed by Captain Tamisier in his experimental researches; and which presented itself to his mind in the form of a principle which, if not new, had at least not been remarked nor studied in its bearings by any one before him—we will, to use Captain Fave's words, "resort, if not to a comparison, at least to an analogy with a well-known fact," and express it as succinctly as possible. When a top falls to the ground, to which a very rapid rotary motion has been imparted, though at first much inclined, it is seen to steady itself by degrees, and to turn upon its axis, now become quite vertical, in such a manner as to seem without all motion. What is it that lifts thus and steadies the inclined peg-top, and that prevents it from falling? Its movement of rotation. For every body knows without that movement the top would fall. In what manner does the rapid rotary movement effect the lifting and steadying of the top? Apparently by the action of a force derived from the resistance of the air, and engendered by that rotatory movement. When the top inclines while turning rapidly, the elements of the lower part of its surface strike successively, in virtue of the double movement with which they are animated, the strata of air which they meet; on the other hand, the elements of the upper part of the surface of the top are brought by their movement of inclination into a part of the space previously occupied by the body of the top, and they have no resistance of the air to overcome to assume their new position. Thus

the force engendered at the lower part, or rather at the inclined part of the surface of the top, is not neutralised by an equal force engendered at the opposite side. The resistance of the air tends to relift the top, and that resistance is the greater the more rapid the movement of rotation.

If we would account for the movement of the ball which turns on its axis in the air, we must not consider it as being immoveable at the point, like the top; because it is impressed at the same time with a movement of translation, which the top has not.

We now arrive at another analogy of Captain Tamisier's, which we have seen, and in one instance only, an attempt made to prove wholly incorrect and inapplicable.

M. Tamisier says, let us now consider an arrow which is only impressed with a movement of translation, and enquire how it is constructed so that the resistance of the air does not exercise an unfavourable action against its movement. In the first place, its weight is almost wholly at the point, and consequently its centre of gravity is very near to it. At the opposite extremity, feathers—substances so light as scarcely to displace the centre of gravity, and which engender *resistances behind*—prevent the arrow from easily changing the direction imparted to it. Those feathers prevent the arrow from taking at any time a movement of rotation perpendicular to its great axis, and maintain it in the direction of the movement. This difficulty which the arrow experiences to change its direction, must also concur to prevent it from descending as rapidly as it otherwise would, in obedience to the action of its weight or gravity; and no less to render its trajectory more flat. It is not necessary to say, that the elongated form of the arrow is specially designed to render the resistance of the air to its movement of translation as little as possible.

The sharp-edged channels, as designed by M. Tamisier, concur to combine the two modes of action of the resistance of the air defined in his analogies of the top and the arrow, to ensure and maintain the direction of the ball. For as regards the movement of translation, the channels established behind the ball produce somewhat the effect of the feathers of the arrow, since experience has made it evident that they tend to prevent the axis of the ball from deviating from the direction of the movement, and in the same manner, as regards the movement of rotation of the ball upon its axis; those analogous channels in the top, first spoken of, increase the surface on which depends the action of the air.

This may be verified in respect to the top by the sceptical, by

resorting to two tops turned of equal weight and size, with pegs of the same weight, length and depth of insertion, but turned one with a greater number of sharp-edged circular channels, and the other with channels not extending so high up as the first ; for on spinning these two tops with equal force, the top having the channels reaching highest up to the breadth of the shoulder will lift itself soonest from the incline on being thrown to the ground, and retain its rotatory velocity more steadily and longer than the top with the fewer channels.

Now with respect to the analogy sought by M. Tamisier in the arrow, and the kind of argument we have seen employed to prove his theory erroneous—a theory, as we have already observed, borne out *by practice* of a most lengthened and efficient character.

A soi-disant “practical archer and rifleman”* asserts that the feathers of an arrow, adverted to by M. Tamisier, are not placed on the shaft to create resistances. In support of this assertion, various citations from writers upon archery are made by him, calculated, he doubtless considered, to justify the correctness of his negation.

The first of these, from Roger Ascham, 1544, is as follows : Roger Ascham objects to the use of certain gay feathers as being too heavy ; as “ they do seldom keep up the shaft either straight or level, they are so rough and heavy ; so that men who have taken them up for their gay appearance, laid them down again for the sake of utility.” “ If the shaft-hand is high, and the bow-hand low, or the contrary, the shaft, if it is small, will start ; if great, it will hobble.” “ In letting the arrow loose, it must be done so quick and hard that it may be without twitche ; so soft and gentle, that the shaft fly not wabbling, as if it were sent from a bow case.”

We doubt if any reader of the above passages can infer from them that the feathers on the arrow are *not* to create resistances. The first citation is the only one which has a very slight bearing upon the subject. Feathers of too great weight are objected to by Roger Ascham. And why ? For the very sensible reason that they would disturb by that *too great* weight the proper balance of the arrow, and oppose an *excess* of resistance to the movement of translation. But it appears nowhere that Roger Ascham says, feathers are *not* placed on arrows to create resistances. By his condemnation of *heavy* feathers, he does not disclaim the resisting agency of all feathers, but rather recommends light feathers, on account of their better assorted lighter resistance to the air, or, in fact, of the lighter directive agency of their resistance ; a resistance so necessary to the

* Boucher. Treatise on Rifled Projectiles, 1856.

steady and sustained flight of the arrow in its movement of translation, that without them and their moderating resistance, the arrow could *not* be impelled at any distance in a direct manner.

His citation from Robert's "English Bowman" has less still to do with the subject.

That from Waring as little.

But that from Hansard rather weakens than strengthens his argument that the feathers are *not* to create resistances. For Hansard's cited remark is—"The most celebrated fletchers or arrow-makers were very careful in selecting *strong light feathers*, so as not to affect the balance of the arrow, or cause any obstruction to its velocity." Here we find again, as in Roger Ascham, lightness of feather recommended for the same reason as by the latter; but that they should combine with lightness, **STRENGTH**. Now strength in a light material, such as feathers, which is a frequent combination, was recommended by this author for the very reason that those combined qualities furnished a qualified and appropriate resistance, without obstructing too much the velocity of the arrow. But in this recommendation of Hansard's, there is nothing that affirms the feathers on an arrow were placed there *not* to create resistances.

The last citation of the disputant of Captain Tamisier's theory is from Moseley's Essay on Archery, to the following effect—"The appearance of an arrow on the wing, viewed from one side, is singularly interesting. Its *steady sailing* movement, the curve it describes, its ascending and descending motion, its velocity, &c." Does any reader see herein aught that affirms that feathers are not placed on the arrow to create resistance? Where would be the *steady sailing* movement described by Mosely *without* the *strong light* feathers of Hansard and their smooth resisting agency upon the air, and of the air upon them? How much more irregular and short would be the "curve it describes"? Where would be "the ascending and descending motion"? Where "its velocity," after a short interval?

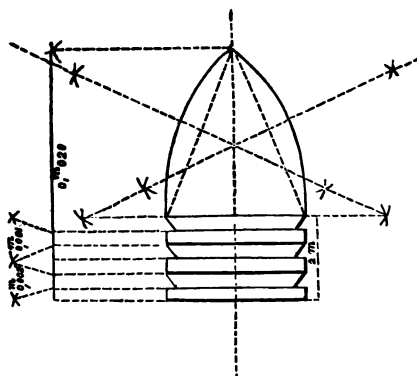
We think the reader will consider, with ourselves, that such authorities have been but ill understood by the "Practical Archer and Rifleman," and that his assertion that the feathers on the shaft of the arrow were *not* intended to *create* resistance, is much more readily demolished than the theory of Captain Tamisier, transferred with such acumen, in practice, to the elongated ball.

In the course of the experiments carried out by Captain Tamisier, in verification of his theory, and to attain a clear intelligence of all its bearings, in respect of the form and proportions of the several elements of the ball best adapted to the Thouvenin system of breech,

as of the barrel, charge, &c.. numerous modifications were tried. These led eventually to a correction of pre-existing defects, and improved in many respects, the new rifle was classed among the military fire-arms of France, under the designation of the Rifle Pattern of 1846.

It is at this time scarcely necessary to say, that the elongated form both of the cylindro-conical and cylindro-ogival shapes, experience much less resistance from the air than spherical balls, and the mass of the former, being much greater, the loss of velocity is much less.

The following diagram exhibits the cylindro-ogival channeled projectile of M. Tamisier, adopted since the date indicated, for the pillar-breech rifle, the special arm of the French battalions of Chasseurs à Pied, and since of several other continental light infantry corps.



The great advantage in the use of the channeled elongated projectile of this form, when of appropriate coincidence of structure, length and weight with all the other elements of the rifle and charge, is derivable from the use made of the air to maintain it always point forward in its movement of translation, even at the greatest distances. Hence the motive agent which increases the *deviation* from the line of fire of every other form of projectile, is in this case made the agent to maintain it therein !

We think, national prejudices apart, this admirable utilization of an element hitherto found so antagonistic to a reliable correctness in ballistic calculations, merits the admiring rather than the depreciatory tone, even in a country where an ethnical pre-eminence in every faculty dispensed by God to man is arrogated.

We would have it well understood, that it is the *corrective* influence over the deviation obtained by Captain Tamisier in this structure of

projectile that we advert to ; for it must not be believed that the constant deviation of projectiles discharged from any fire arm or piece of artillery can be wholly overcome. But that it was susceptible of some controul or alleviation, as other of nature's physical laws, had not yet been clearly established.

The circumstance of the more regular and defined character of the deviation in the fire of rifled arms proffered doubtless a greater facility to establish this alleviation ; and Captain Tamisier's success, qualified as it was, and as all such in this respect will ever be, is but a greater proof of the correct view taken by Leutmman and our countryman Robins, in their day, that the study of rifled fire-arms was a subject worthy of the attention of governments.

It is now, we believe, pretty generally known to those who have given any attention to rifled fire-arms, whence this more regular and defined deviation of its projectiles derives ; but as it should always be borne in mind that the knowledge of a few is not that of all ; that new aspirants to its attainment present themselves daily ; and that the knowledge of the modern rifle is one that by its very improvements has been made more necessary of special acquirement in the future than was ever the case with the smooth-bore musket which it has superseded, we will curtly explain this feature.

In rifled fire-arms, the inclination of the spiral of the grooves impresses mainly on the projectile the direction of the deviation, which is then further influenced, more or less, by the external deflective influence of the wind, and the attraction of the earth or of water. In barrels rifled from left to right, the deviation is impressed towards the right of the line of fire : in those rifled from right to left, the deviation takes place to the left. Either directions of deviation become greater the more rapid the movement of rotation that is imparted to the projectile by the degree of inclination of the spiral ; generally speaking, the effects of this deviation impressed by the grooves are very sensible only beyond 300 or 320 yards. In the pillar-breech rifle of the French Chasseurs, as also of the Belgian, who use the same turn of groove, the deviation is very little.

It was observed by Captain Tamisier, in his experiments with the ball of this rifle (see preceding diagram) that the height of the cone, or ogival, might be varied from 10mm. = $\frac{7}{16}$ of an inch to 15mm. = $\frac{10}{16}$ of an inch, without seriously affecting the precision of fire. And no more practically convincing proof can be cited of the correctness of the theory of Captain Tamisier, so infirmly disputed as we have shewn, than the results he obtained in his endeavours to carry out its test. To verify the value of this principle of resistance at the

posterior part of the bullet, and to see how far its application could be carried, he resorted to a yet further elongation of the projectile; and he found it possible to fire from the pillar-breech rifle, with precision, at great ranges, bullets much longer than had before been believed possible. Inasmuch, that he fired with great accuracy, projectiles as much as seven times the diameter of the bore, i.e., of a length of 0m 126; and that officer possesses a rifle of 12mm. bore, = $\frac{1}{2}$ inch, which fires a bullet having seven channeled grooves, and of the length of 48mm., = $1\frac{3}{4}$ inch. This bullet ranges with precision to a distance of 1000 metres and beyond, or upwards of 1083 yards, with a penetration of 6 centimetres, = 2 $\frac{3}{4}$ in. into deal plank, at that distance. To this channeled projectile, which we have seen, the name has also been aptly applied on the Continent, of Tamisier's *arrow-bullet*.

The conical counter-sunk cavity of the ramrod adopted was 12mm. in depth; and by slightly rounding off the apex of the ball, and the angle of the bottom of the cavity in the ramrod, the projectile was less subjected to disfigurement, and the ramrod cavity more readily cleaned, while a better hold was obtained for the worm to withdraw a ball that had been driven home.

While on the subject of cleaning, adverted to above, we recall to mind, that a major objection was urged against the pillar-breech rifle because of the great difficulty that would be experienced in the cleaning of the breech of this arm. But in 1854, when the Belgian Chasseurs à Pied were at the camp of Beverloo, we directed our enquiries repeatedly upon this subject to officers and privates, to ascertain if such were the case; when by the former, and by the men themselves, we were assured such was not the case—"that from practice they could clean it as speedily and effectually as the flat-breeched rifle of the Regiment d'Elite." This information was subsequently corroborated to us by French Chasseurs à Pied at the close of the late war. The more sensible disadvantage of this arm was and is, that on account of the weight of the ball, fewer rounds can be carried than heretofore in the cartouche-box or giberne.

In immediate coincidence of time (1846) with this new step in progress of the French military authorities to the establishment of a better arm for the infantry than the percussion-improved musket, generally introduced in France but a few years before only, i.e., 1840; though already the Saxon and other German troops had progressively adopted them from 1835; what had we done in the direction of the rifle? Nothing.

Some dawning, nevertheless, of a certain necessity to move, was

evinced by our military authorities of the time; and they proceeded to obtain some definite knowledge of the capabilities of the percussioned smooth-bore, then recently introduced in our service.

These trials took place in the year aforesaid at Chatham; and what had they elicited? Any thing but a reliable efficiency to compete with the kind of infantry musket which was becoming part of the established armament of our immediate neighbours. Some tolerably definite idea may be formed of the ballistic merits of the percussion smooth-bore musket of our infantry in 1846, from the results which those trials exhibited.

Degree of Elevation.	Ranges.				Difference between the least and extreme ranges.	Remarks.
	Point-blank range. Yards.	Deflection. Feet.	Greatest range. Yards.	Least range. yards.		
Under $\frac{1}{2}$ deg. on the outside line of barrel	75	great	218	116	102	The lateral deviations were yet greater than these differences, and no trace whatever could be found of many of the balls.
Ditto.....at	100	4ft. 8in.				
Ditto.....	200	9ft. 9in.				
Ditto.....	300	19ft.				
$\frac{1}{2}$ deg.	300	126	174	
1 deg.	398	186	207	
$1\frac{1}{2}$ deg.	533	261	272	
2 deg.	583	258	825	
3 deg.	632	422	210	
$3\frac{1}{2}$ deg.	686	408	278	
4 deg.	665	525	140	
5 d.g.	797	488	309	

We need scarcely say, that the great irregularity of fire of the smooth-bore musket, derived chiefly from the excessive windage given from persistent custom to the spherical ball, to facilitate rapid loading, and therefore rapid fire; though, anomalous as it may seem, when a really rapid fire was attained by improvements in breech-loading, it was then condemned, just as Bell's paddle-wheel had been objected to by departed naval authorities, as inapplicable to ships of war. From this excessive windage of the ball resulted, furthermore, the ricocheting of the ball from side to side in its movement of translation, which was vastly prejudiced again by the whereabouts of the ball's last impingement previous to its exit from the muzzle. This last point of impact, which gave the decisive stroke of inclination to the direction in which the ball left the muzzle, might be anywhere, and its angle of exit therefore always variable.

To this, also, was chiefly attributable the difference between the fire of two consecutive shots with the same charge of powder, at the same elevation, which difference was shewn to be nearly half the extreme range at the farther distances; while the lateral deviations,

operated by other auxiliary deflective agencies, the wind, earth's attraction, &c., was greater than the difference between the greatest and least range obtained under the same circumstances of charge and elevation.

As a further resultant of those trials, the knowledge was acquired of the average ranges of this musket, which with powder-charge of $4\frac{1}{2}$ drachms (afterwards varied to 4), the compressed spherical ball of 488 grains, of 0.68 diameter, 0.76 bore, and 0.08 windage, without paper, gave as follows :—

Average Ranges.		Difference in yards of each degree of elevation.
Degree of elevation.	Distance.	
1	241	
2	397	156
3	510	120
4	599	89
5	645	46
6	680	35
		And so forth.

So that it was discovered, no greater range could be obtained by the late smooth-bore infantry arm by any increase of elevation beyond 8 or 9 deg., but quite the reverse, a less range only !

These defects and their results in this arm, had been demonstrated with no little persistence by Mr. Greener, the gunmaker already adverted to, in a book on fire-arms dedicated by him to the late Duke of Wellington ; and in the so-called professional journals of the day. But the *qui bono*, both of those experiments at Chatham and Mr. Greener's well-intended efforts, had not elicited itself in any manner ; for three years afterwards, as per Blue Book evidence given before the select committee of the House of Commons on the army and ordnance expenditure of the year 1849, it was officially laid down, that with 6 deg. of elevation, the range of the smooth-bore percussion musket was " from 1700 to 1800 yards."

Independent of the publicity given to the improvements effected in the rifle in France, by the scientific and military periodicals of that country, in which the merits of M. Delvigne's labours, and those of the Artillery Commissions were zealously argued, pro and con, and the experimental results made known in all their phases throughout Europe—there were not wanting frequent intimations on the part of British officers and others visiting Paris, of the propriety of taking some steps to apply the new principles which had been elaborated so successfully at the expense of the French government, to our own advantage.

The recurrence of these spurts of wholesome pressure from without, notwithstanding the ill-grace with which they were received, like drops of water that, falling continually on one spot, wear out the heart of granite, was eventually attended with that success which perseveringly reiterated exposition of improvement called for, or of grievance to be redressed, obtain only from official bodies.

A more direct and decided influence was set in motion, and, in 1848, the late Duke of Wellington was instructed by the government, to institute inquiries in order to obtain a more effective kind of arm than the percussion musket.

A somewhat intimate knowledge of the subject also had been acquired by the late Mr. Lovell already adverted to, who in different visits to Paris had made himself acquainted with all the particulars of the different elements of the Delvigne system, of that of Thouvenin, and Tamisier, and of Minié, who, in 1849, had introduced his hollow plain cylindro-conical ball, with *iron cup*, for use with the flat-breeched rifle with the Delvigne inclination of spiral, and groove of progressive depth, called by his name the Minié rifle. Mr. Lovell had, moreover, presented himself to M. Delvigne as the Inspector of Small Arms of the British Board of Ordnance; and M. Delvigne, but too much flattered by the seeming prospective importance of a visit from such an official, a visit which he inferred could not but arise from special instructions, not only gave Mr. Lovell every necessary information on the matter, but politely furnished him with models of all his productions, in the fond hope to experience in return somewhat more generosity of feeling, at least, towards him for the services he had rendered to science, than he had experienced from his own government. But M. Delvigne, like many other amiable enthusiasts, indigenous as well as foreign, who have entertained a very exalted idea of the expansive generosity and capabilities of Britannic official departments, found that he had been led to make a false estimate of their exceptional repute for those attributes; and that, observant of a custom by no means peculiar to the latitude of Pall Mall, they also exhibited a greater disposition to the acquisitive than the donative impulse, especially when the former could be gratified without cost, and converted in some shape to the semblance of merit emanating from the bosom of the department itself.

Sir F. Smith, the present member, being in Paris at the time the French government were experimenting upon the improved rifle musket, very properly considered it a subject meriting some attention at home, and he therefore reported the facts to Sir J. Burgoyne. The latter officer, of course, forwarded Sir F. Smith's report to the

Marquis of Anglesea, then Governor-general of the Ordnance ; who submitted the same to the Woolwich authorities ; who thought no rifle was superior to that used by our rifle corps (the 2-grooved Brunswick rifle already spoken of). The opinion expressed by the Woolwich authorities was then communicated by the Marquis of Anglesea to Sir F. Smith ; who, in support of the opinion he had expressed, furnished the Marquis of Anglesea with the corroborative opinions of Marshall Marmont and others upon the subject, to the effect that "in future wars our Artillery was to be careful to keep out of range of the improved French weapon."

Coming from a soldier like Marmont, one so likely to have some cognizance of the merits of the subject treated so slightly by the Woolwich authorities of that day ; the Marquis of Anglesea, more alive to the duties of his office, thought proper to doubt their wisdom at thus prejudging the case before trial, and resolving to ascertain if the admonition conveyed in the Marshall's words was founded upon such cogent reasons as might possibly impose a deference so humiliating on our big guns, he requested an application to be made through our ambassador to the French Minister of War for a musket. This request was very politely complied with ; and a musket of the Belgian adopted pattern for the "Regiment d'Elite," the flat-breeched Minié, was also procured ; and thus models, either for direct adoption or imitation, as might be, were obtained.

During the polemic that was carried on on the one part between the military opponents of all change—many of whom, war-experienced soldiers of the Peninsula campaigns, who in their day of youth and vigour had learned it under circumstances of success, in the elements of which in their life's decline they could brook no change—and on the other, the advocates for enquiry, and the adoption of a fire-arm suited to place our troops in proper equilibrium with those of the rest of Europe, every state being assiduously engaged in prosecuting experiments and establishing a better weapon for their infantry. The press brought its weight to bear upon a subject of such vital national interest, and to the efforts of the *Times* especially, and its ever ready admittance into its columns of communications from military men well acquainted with the practical demonstrations of the superiority of the French improved rifle at the schools of musketry of Vincennes and St. Omer, the British army and the country were greatly indebted for being placed on the road to a prospective position of advantage in the event of any hostilities.

The result of all these auxiliary circumstances was, the production of the then called new "Regulation Minié Musquet" pattern, in

1850-51; a flat-breeched rifle. For this arm, in the first instance, by some instigation or other, either to express that dignified spirit of independence which, though constantly imitating, scorns to make a close and therefore servile copy of a foreign production, even though such an adherence to the original might be desirable or really necessary for the attainment of the object required; or though, with an unconscious ignorance of the subject, impelled by the inspiration to improve upon the model, a very imperfect form of bullet was adopted; namely one of a conoidal shape, or perfectly conical throughout its length, so that unless the musket was held in a perfect vertical position when loaded, the ball would seldom assume its place on the charge with its axis coincident with that of the barrel, so that in its movement of translation up the barrel, it became inclined to one or the other side, and an escape of the gases of the charge ensued on that side of the projectile which had started thus lifted before the other side had left the muzzle, giving therefore, *ab ovo*, a deviation.

The iron-cupped Minié bullet, replaced this; that is to say, the *English* pattern Minié with iron cup; for it differed from Captain Minié's *balle à culot en tôle* of 1849 in external form; though this is not generally known, even up to the present day. The English Minié cupped ball was cylindro-conical, like the former, but it had not the two sharp-edged circular channels on the cylindrical part; that important feature of the true Minié cupped projectile. But on the introduction of these elongated projectiles in England, from the want of previous systematic study of the different systems of foreign projectiles, every elongated bullet was called a Minié, cupped or uncupped, solid or hollow; as indeed obtains generally to this day. In the then Regulation Minié musket, the Delvigne inclination of spiral, one turn in 6ft. 6in., had been imitated, and the number of grooves, four. But, in obedience to our military prejudices of that day in favour of a large bore, the whole arm was established too heavy, notwithstanding the objections raised to the weight of the ordinary musket, and that on all hands proof and modern examples were urged, of the military effectiveness of a smaller bore with elongated projectiles.

Nevertheless, this first step was something gained; and before the lighter and handier Enfield had been suggested, those few companies of regiments who had been provided with the Anglesea "Regulation Minié," in the Kaffir war, soon furnished evidence sufficient that there was something in the new principle not to be despised; "the *Minny*" did not get foul so soon as "*old Bess*," and the Kaffirs begau

to evince an astonishment that soon assumed the character of deference for the unusual distance at which they were brought down; and dispersed more frequently than hitherto before our troops, without waiting for closer contact. It is also but the just due of this our first tribute to the rifled musket expediency, to add that this same arm, with the subsequently adopted English modification of the Minié iron cup bullet, did, before the Enfield had made its appearance in number sufficient for supply to our troops at the outbreak of the Russian war, again prove most effectively at Alma and Inkermann, that no very great mistake had been perpetrated by the gallant Marquis of Anglesea for not having contentedly submitted to the opinion that "the rifle used by our rifle corps" was superior to all else.

Succeeding the Marquis of Anglesea to the post of Master-general of the Ordnance, Lord Hardinge zealously followed out, in 1851, the prosecution of the now becoming fixed idea—the general adoption for the British infantry of a pattern rifled musket, which should combine that lightness which would contribute to the much required alleviation of the weight of arms and accoutrements of our infantry, with that solidity and efficiency as an arm of precision and superior range which had now been considered indispensable. In 1852 he invited the gunmakers of the country to join in the research for the object desired, and to exhibit concurrently their ability in the production of an arm which should combine those structural features considered indispensable to the establishment of a rifled musket suited for general military use.

To cite the number and the names of those who competed to this effect, as also to describe their respective distinguishing features, would occupy too much space. Meanwhile, a somewhat definite conviction had been arrived at, that a decrease of the diameter of the bore was desirable, and the Ordnance authorities produced a sample of their own skill at combination in the Enfield Rifled Musket.

The experiments on the comparative merits of this rifle and those submitted by some of our most eminent gunmakers, were assiduously carried out at Enfield in 1852, and the preference was given to the Enfield arm.

The Brunswick rifle, that of our rifle corps, was proved in these trials to be inferior in range to all the new competing arms, and the process of loading it always found one of difficulty, became yet more obvious from the facility of loading all the other rifles submitted for trial; so much so, that astonishment was expressed that our rifle regiments should have been permitted to retain it so long.

The establishment of the Enfield Pattern Rifled Musket, achieved for our military authorities the merit of having set the example of decreasing the bore of the infantry arm, without thereby necessarily decreasing the weight of the bullet ; satisfying at the same time the condition required by military usage, the retention of sixty rounds of ammunition per man, yet with the advantage of a reduced weight, both in the arm itself and in the ammunition, as compared both with the old Regulation smooth-bore and the Anglesea "Regulation Minié."

Of the competing rifles submitted by gunmakers upon the occasion of the Enfield trials, the rifles of Lancaster, Wilkinson, and Purday claim most attention. Though the length of barrel (39 inches) was, so to say, a condition prescribed by official authority as a *sine qua non*, the other elements of these rifles represented the systems considered by their makers as best adapted for a military arm, and varied from each other, as a matter of course.

The following table of the principal dimensions of these arms, and of the Enfield musket, will most correctly exhibit them.

LANCASTER.	WILKINSON.	PURDAY.	ENFIELD.
<i>Weight with bayonet,</i> 9lbs. 9oz. 9lbs. 5oz. 9lbs. 1½oz. 9lbs. 8oz.
<i>Barrel—</i> Weight, 4lbs. 14oz. Length .. 3ft. 3in. 4lbs 1oz. 3ft. 3in. 3lbs. 15½oz. 3ft. 3in. 4lbs. 2oz. 3ft. 3in.
<i>Bore—</i> Smooth and elliptical Conical Cylindrical.... Cylindrical
<i>Diameter of bore—</i> Greater axis at muzzle550in. Do., breech .557in. Lesser axis at muzzle.... .540in. Do., breech .543in.	At muzzle.. .530in. At breech .. .581in.	Diameter .. .650in.	Diameter .. .577in.
<i>Grooves—</i> Elliptical, with in- creasing twist....	5, with a regular twist of one turn in 6ft. 6in.	4, with an increasing twist commencing at one turn in 6ft., and ending at one turn in 4ft. 9in.	3, with a regular twist of one turn in 6ft. 6in. Width of groove; .262in depth of groove; .014in. 2¼dr. F.G. Solid, expanding
<i>Charge—</i> Powder, 2¼dr. F.G. Bullet, expanding by plug 2¼dr. F.G. Solid, expanding, with two deep grooves .537in., of the shape of the 3-grooved Tam- i-er bullet, with the exception of the base, the cylindrical sides of which are not vertical to the base throughout their length 2¼dr. F.G. 1, the English iron- cupped Minié, and 1 of same form, with a plug. English Minié .643 in., plug 643in.568in.
Diameter... .582in. 1.075in. 500grs. 185yds. 0ft. 3 ⅓ in. ¹⁰	.910in., 1.050in. 48 7grs. 610grs. 180yds. 2ft. 4in., with plug bullet960in. 520grs.
Length .. 1.125in. Weight .. 542grs. <i>First Groove, or point blank, 194yds. 0ft. 11in.</i>			

LANCASTER.			WILKINSON.			PURDAY.		
Angle of Elevation, for 100yds... 0deg. 11m.		 0deg. 14m. 0deg. 15m.		
200	0	26 0	28	0	40	
300	0	49 0	47	0	57	
400	1	9 1	5	1	17	
500	1	34 1	25	1	47	
600	2	2 2	0	2	21	
700	2	32 2	29	2	58	
800	3	1 2	44	3	41	
			1000	4	81			

Weight of the Enfield Musket, &c.

	lbs. oz. dr.
Musket, with bayonet	9 8 0
Sixty rounds of ammunition	5 3 11
	<hr/>
	14 6 11
Bayonet scabbard	0 4 8
	<hr/>
	14 11 3

Trajectory of the Enfield Musket at 100yds.

Distance of muzzle.....	50 75 100 yards.
Height of bullet above line of aim	9 6 $\frac{1}{2}$ 0 inches.

Trajectory of the Enfield Musket at 200 yards.

Distance of muzzle.....	50 75 100 125 150 175 200 yards.
Height of bullet above line of aim	11 $\frac{1}{2}$ 14 $\frac{1}{2}$ 19 21 20 $\frac{1}{6}$ 10 $\frac{1}{2}$ 0 in.

Trajectory of the Enfield Musket at 300 yards.

Distance of muzzle	50 75 100 125 150 175 200 225 250 275 300 yds.
Height of bullet above line of aim	17 $\frac{1}{2}$ 26 $\frac{1}{2}$ 33 40 $\frac{7}{12}$ 42 $\frac{1}{2}$ 43 39 32 24 14 0 in.

At paragraph 38, page 61, of our Historical Retrospect, it will be perhaps remembered, we adverted to the *elliptical* principle of bore, applied in 1835 to the musket, by the Brunswick Captain Berner. As an English appropriation of that structure of bore, it may not be uninteresting to many of our readers unacquainted therewith, to be informed of its character in the Lancaster rifle, which competed upon the occasion just adverted to, and which has since been supplied to our Sappers, and we believe to some other corps of our service.

The cardinal feature in the structure of this rifle, is that the bore of the barrel is smooth, instead of being cut into grooves; and in order to produce the effect of the grooves in the ordinary rifle, the bore of the barrel in this arm, instead of being circular, is cut into the form of an ellipse, in which the greater axis exceeds the lesser by .005 of an inch. Upon being expanded by the force of the powder-

charge, the bullet is forced into the greater axis of the ellipse, which thus performs the office of grooves, rifling the projectile, and imparting to it the spiral or normal movement round its own axis.

An increased precision of fire was sought to be given by Mr. Lancaster to this arm by adopting what we have shewn (at page 221) is erroneously called the American plan of "a gaining twist," or increasing spiral. Further advantages were also considered to be derivable from this feature: less recoil, prevention of the side-twist which a ball gives to the rifle in the hand of the person firing, when its ball starts with a rapid spiral, which side-twist of the barrel in the hand is either to the right or left, as the turn of the grooves may be: and a decrease of the supposed tendency of a ball to "strip" when first it receives the impulsion of the charge.

The increased precision which this form of spiral is affirmed by its partisans to impart to the projectile is explained by them by an hypothesis merely, and one somewhat difficult of apprehension. They suppose, and take indeed for granted, that because a ball has been impressed with an increasing rapidity of rotation upon its axis *in* the barrel itself, it must, as a *sequiter*, having passed from the muzzle of that kind of barrel, perform the same evolution of increasing its rotatory movement round its axis in the air during its flight. How a projectile upon its exit from the muzzle of a barrel of this kind, and no longer submitted to the original "physical force" change of turn impressed upon it so long as it was *in* the barrel, can achieve or perform for itself this *gaining twist* during its flight *through the air*, we leave for the apprehension of that numerous class of persons who sooner credit the wonderful than the plain matter-of-fact, and who find more attraction in the improbable, or even impossible, than in the sober probability or the possible. Every art, like every trade, has its chicanery; that the art of gunmaking should be exempt from it is therefore not to be expected. Besides, the enunciation of ideas and principles beyond the ordinary comprehension, finds numerous attentive listeners, who believe in them the more readily because they are surprising, and that they understand them the less.

But to the second feature in the advantages recited. The recoil would doubtless be less in a gaining twist, for that the less *initial* resistance to the force of the powder to start the projectile, would give less re-action, than a greater initial resistance imparted to the ball by a close spiral turn of groove at the breech. But that resistance and its resultant recoil, even with a sharp-breech spiral, are but very little sensible, with projectiles expanded on the now generally

adopted Delvigne's (second system) dilatation of the base of the bullet by the force of the powder—but with the solid projectile, without the neck of Delvigne's and Minié's solid cylindro-conical bullet, or without Tamisier's deep channeled grooves, would give a very sensible recoil to a sharp spiral at the breech.

As to the "gaining twist" correcting that tendency of the bullet to twist the rifle in the hand of the operator, which was so sensible in the sharp turn of spiral formerly given to rifle grooves; that was one of the defects in the old system of rifling that M. Delvigne corrected, after long study, by the now every where adopted spiral of one turn in 6ft. 6in.; which was further improved upon by Captain Tamisier's mode of establishing a progressive depth to them; and which, with the elliptical system adopted by Mr. Lancaster, and his *long cylindrical expanding* bullet, always experiencing a different conformation as it passes up his bore, his rifle would be better without.

This, we believe, was notified to him on the competitive trial of his rifle; when a smooth-bored rifle with a regular twist, was found to shoot better than his arm with the gaining twist, though the bore of the former was .3 of an inch larger, and the projectile fired from it 50 grains lighter, than his.

Lastly, in reference to the less likelihood with the "gaining twist" of a bullet to "strip," or pass over the grooves and out of the barrel without rifling itself in the grooves, being conducted progressively from the breech to the increased twist of the spiral towards the muzzle: it may be affirmed, that in no well-constituted rifle, that is upon the improved principles of the Delvigne chambered, the Minié flat-breeched, and Thouvenin's pillar-breech systems, or their modifications, the bullet will become "stripped." The old-fashioned "gaining twist" of the end of the sixteenth century is therefore a recurrence only to an erroneous principle, presenting to the projectile a continually increasing resistance and friction at the very moment of time when it is experiencing the increasing development of the force of the powder, which under the more favourable circumstance of a regular spiral of groove, would take the best effect upon the bullet, and impart to it a less disturbed movement of translation and precision of fire.

Rapidly imparted and developed though it be, yet in reality, as we have already shown when treating of the length of gun barrels, page 96, is the impulsion given progressively to a projectile in an arm where a just and appropriate relation exists between the length of barrel and the charge of powder; and the velocity of impulsion increases as the ball advances to the muzzle. Then therefore, also, is

the very time when the projectile, yielding to the full force of the charge, and in the moment of its maximum velocity of translation, is about to leave the muzzle ; that it would be and is capable of passing over the grooves and out at the muzzle, in defiance of their gaining twist towards and at that part. Of what avail then a gaining twist, especially in an elliptical or nearly smooth-bore barrel, in which the directive elements impressing the spiral movement on the projectile are so lightly defined throughout the bore to what they are even in a shallow circular-grooved rifle, that their guiding hold upon the bullet is too slight to impress their increased spiral to its movement at the moment of its maximum impulse of translation out of the barrel.

With regard to the projectile of this arm as then used—a plug bullet, it was inapplicable to a military arm, both on account of its complex form, and its disposition to nip the paper of the cartridge under the expanding action of the powder. The projectiles now used by our Sappers for this rifle—two of which are now before us, of cylindro-conoidal form, one with a flat wooden plug, the other with the iron cup—are, we should say, much more eligible.

Advantageous as the elliptical or smooth-bore rifle may seem at first, in respect to the little wear and tear which its bore may suffer from the action of the ramrod, yet we are disposed to think, that little, would be very effective after some service, as the directive edges of the spiral being so slightly defined, they must sooner suffer from the friction of the ramrod and bullet, than the edges of the ordinary groove ; and though with the greased bullet the effects of fouling may be less apparent, yet they would be sooner evident than in grooved rifles, which take up the powder residuum better, and therefore also with greased projectiles would remain longer clean. On the other hand, all rifles that will permit of loading and use after 100 rounds, as those tried upon this occasion are, in that respect at least, adapted equally to military service.

Passing to the Wilkinson rifled-musket, that arm presented the advantage of using a solid cylindro-conical projectile, of the figure described in the preceding table. This bullet, used without paper or patch, the two channeled grooves being merely filled with grease, enabled the arm to be loaded in the same manner as before usual in our rifle regiments ; the powder being made up by itself in a small cartridge, and put into the piece before taking the ball from the ball pouch. To facilitate the reception of the bullet in the muzzle previous to ramming it down, the muzzle is countersunk. All these features are advantages in a military point of view.

With equal precision to any other then tried, its trajectory was

flatter than any other at all ranges from 300 to 800 yards. At the 100 and 200 yards' range, this musket, as seen by the table, required a higher angle of elevation than the Lancaster musket, but a lower at 300 yards and beyond. In regard to celerity of loading and firing, the Lancaster and Wilkinson were found equal, and superior by a few rounds, to the Regulation Minié and Mr. Purday's.

The latter carbine had the so-called patent-breech, considered unnecessary to a military musket, and its fire was of great precision, though its trajectory was higher than that of any other arm.

We will now address our attention to the labours of Lieut.-colonel John Jacob, of the Bombay Artillery—an eminently practical officer of that arm of our Indian service, who for many years devoted a special and zealous attention to the study of the rifle.

The results obtained by Lieut.-colonel Jacob in a long series of experiments, carried out at considerable personal expense, at Jacobabad, Upper Scinde, from 1853, were communicated in their progressive phases, at different intervals, to the Bombay government, and subsequently submitted to the personal notice of his Excellency the then Commander-in-Chief and Staff, on the Bombay flats, in April, 1856; all of which were made public in a pamphlet published in the same year in this country.

To those of our readers to whom the latter may be unknown, we have no doubt some information respecting the convictions obtained by Lieut.-colonel Jacobs during those experiments, and the features of the system of spiral and projectile which he adopted, as giving most efficient results, will be acceptable.

With the same view that contemporaneously actuated the military authorities at home, viz, to establish a rifle musket upon principles of structure and projectile, such as would admit of easy loading and of general adoption for the infantry and rifle regiments, in lieu of the smooth-bore musket and two-grooved rifle, Lieut.-col. Jacob, with local and circumstantial facilities that peculiarly favoured his researches, applied himself to a series of experiments, which eventually enabled him to establish an arm of great range and precision, though differing in many respects from the rifles recently described, and further illustrative of the truth of the observations of M. Delvigne and the officers of the French Artillery Commissions, since established as axioms—that in the proportion of the change of any one structural feature of the arm, so must other elements thereof, and of the projectile, be submitted to a co-relative change.

The bore of the light pattern rifle since proposed by Lieut.-colonel Jacob to the Indian Government for the army, was 24, or, in the

general sense of that denomination, of the gauge of 24 spherical balls to the pound ; a plain or flat-breeched barrel, of the length of 30 inches, rifled with 4 grooves of one turn in 3 feet ; the barrel attached to a full stock by bands, as adopted in the Enfield musket ; the ramrod with counter-sunk head to fit exactly the anterior part of the bullet ; a 2 ft. long sword-bayonet, front sight and spring folding-back-sight, with slide : of the whole weight of 9½lbs.

The charge of powder for this arm is 2 drachms, with a cylindro-ogival projectile, the cylindrical part of which is cast with four ribs, or projections, corresponding with and fitting into the grooves of the barrel.

Experiments instituted by Lieut-colonel Jacob with a rifle of the weight of 10½lbs., of the same internal structure as the above, sighted up to 1200 yards, had shewn such precision of range as to enable a tolerable shot to strike an object the height and size of a man at 1000 yards, with a full effective range of nearly 2000 yards.

From the shewing of Lieut.-colonel Jacob, he, in common with all who address their attention to improvements or the establishment of any advantageous change, arrived by degrees only at the establishment of the arm described.

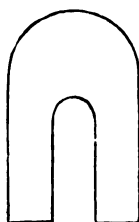
He first sought for and obtained, in 1845, a more easy method of loading than presented by the 2-grooved, and so-called poly-grooved rifles, by adopting a double or 2-zoned cylindrical ball to a 4-grooved rifle, with the advantage of greater range and precision, derived from the more equal and firmer hold of the ball in the four grooves, in its passage up the barrel, when even though the ball was cast of a diameter to drop into the barrel, and the spiral of the grooves of the arm greater than usual, it followed that spiral exactly.

At this stage of his progress he submitted, in 1846, a 4-grooved rifle, with the two-banded spherical ball, to the Indian government. It was rejected, for the reason that the Brunswick rifle being considered "good enough for the Royal army, was good enough for that of the Hon. E. India Company's."

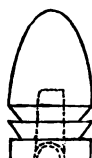
Lieut.-colonel Jacob now changed the shape of his projectile, adopting a perfect cone, the posterior part of which, carrying out the idea of the two intersecting bands of his spherical ball, was cast with four square projections, opposite to each other on the broad periphery of the cone, to fit into the four grooves of the rifle. The base of the cone was circular ; a form of conical projectile used and called "a picket" in the United States, and used also in several of the German states. This, of course, he found superior to his 2-banded spherical ball. He then adopted for trial what he calls the Minié ball, of

which he gives the form in a diagram, under the appellation of the "Original Minié ball with iron cup."

This projectile, he says, never equalled or approached the conical ball just described. Neither are we surprised such a result should have been found ; for, with the exception that it shews the existence of an iron cup, it resembles in no feature the "original Minié" projectile with the iron cup, of that officer. As a juxtaposition of things best bespeaks their similitude or difference, we subjoin them for the reader's comparison ;



Original Minié ball, with iron cup
as depicted and fired by Lieut.-
colonel Jacob.



Balle Minié,
à culot en tôle.
The original.

who, we think, will readily conceive the reasons why the Minié ball was so unsuccessful in those trials. Lieut.-colonel Jacob was evidently led into error by some gunmaker, who furnished him with the mould of *such* a Minié ball.

This circumstance is another illustration of the injustice that may be unwittingly done to a principle of some merit, by a misapprehension of its real and constituting elements ; to which misapprehension the name of the original idea has been given. If the truth were known, how many popular prejudices might be traced to a similar source !—a general misconception of a thing, or of some one or more of its elements of form and principle ; an abortive imitation, stamped with the name of the real thing. Experience proves this imperfect product to be a failure, and the discredit of that failure falls upon the general principle and its real exponent.

Other pure conical cylindrical forms without cups, but with the hollow at the base to produce expansion, and with the side projections described before, were then tried by Lieut.-colonel Jacob ; one of which proved superior to the conical "picket" described. Prosecuting his experiments in the modification of these projectiles, he

arrived at a much more likely shape to produce the result he sought, viz., at the cylindro-ogival ball depicted below.

AB 2 diameters.

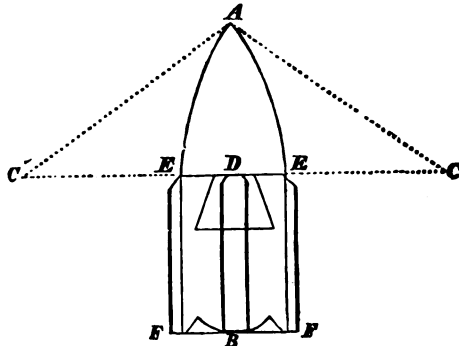
CD 2 ,,

AC $2\frac{1}{2}$,,

BD $\frac{1}{2}$,,

From E to F cylindrical.

From A to E defined by arcs of circles described from centre C , with radius CA .



Having, of course, found with this better form of projectile a less resistance to its translation, and more precision at yet greater range, Lieut.-colonel Jacob found also that it required half the charge of powder of the 2-banded spherical ball he had submitted to the authorities in 1854. He then, as M. M. Delvigne, Norton, and Thiroux had done in Europe, applied this shape to a percussion rifle shell, which of course gave, like their products of the kind, the desired result; and following the example of Major Cavalli who, in 1848, had practically applied this very form of projectile, the ogivo-cylindrical, with *ailettes*, or side-projections, to rifled cannon; Lieut.-colonel Jacob suggested such an application of his projectile, combined with a wooden bottom, to artillery.

In the course of his experiments with this projectile, Lieut.-colonel Jacob found, as had been found in Europe, that, despite the care taken to counter-sink his ramrod to preserve the anterior form of his projectile perfect, it was nevertheless forced back upon itself—fairly shrunk up—by the resistance of the column of air in the barrel; and though that deformation took place with a certain regularity and preservation of the original outline, in as far as a reduced cone may be considered to represent the elements of the ogival form, a faint retention of form which the specific character of lead is alone favourable to when the compressing agent is air in a cylinder; he resorted to the adoption of a steel point to the projectile, and found those of the kind he used—"Manton's steel points"—made the matter worse instead of improving it; for these points, dove-tailed into the apex of the projectile to a slight depth only, became, under the action of the air, a small but solid lever, which, acting on the side of the anterior part of the projectile where the

lead might be interiorly weakest, turned the front of the bullet on one side or the other, and wholly destroyed all precision in its flight. Lieut.-colonel Jacob resorted therefore to a metal already used for the same purpose, zinc, and found also the advantage therein, for the preservation of the anterior form of elongated projectiles under the opposing forces of the impulsion of the powder-charge and the resistance of the atmosphere in the piece.

The ranges of these bullets were found, says Lieut.-colonel Jacob, effective up to 2000 yards, and their penetration at that range four inches, and nearly twelve at 1000 yards in very hard dry cutcha brick.

The elements of Lieut.-colonel Jacob's system, well combined in their co-relation or harmony of agreement, as he eventually succeeded in establishing them, are now to be considered in the view for which he laboured to attain them, viz., for a military musket for infantry generally. We have no doubt, that had the arm he submitted to the Indian government in 1854 been such as he thus eventually succeeded in establishing, a different opinion would have been entertained of it than of his 4-grooved rifle with two banded spherical ball. But he had not progressed so far; hence that could not be.

But it is also necessary to consider, in the face of all that has been done, not only so far, but what may hereafter be done; for we may of right question whether all has yet been effected for the rifle system of which it is susceptible? What are the conditions on which a rifled musket for Line infantry should be established, to fulfil its purpose as an improved efficient war weapon for general adoption and use? To this we reply: it may be laid down as an axiom, that the utmost possible simplicity of form and structure, combining lightness with strength, and those ballistic properties of precision and range that a just accord of all its elements of rifling, charge, and projectile can alone impart to it, are the conditions which a rifled infantry musket should satisfy. With precision at 600 and 800 yards' range, comprised in these characteristics, as far as concerns the piece itself, no Line infantry musket for the general purposes of the fire-fight, even under that improved element of modern war, can well be required.

The next things to be considered are its projectile and ammunition. The former, like the arm itself, must in its form and other elements combine the utmost simplicity, consistent with the precision and range required, with the further least liability to deformation in the transport, and the easiest *manufacture*; for it is in the latter broad sense that the making of the projectile must be considered. The

arm that best comes up to the above enumerated conditions is, according to our judgment, the best rifle musket for infantry.

Hence we consider, that Lieut.-colonel Jacob's arm, like the Lancaster, the Wilkinson, the Corsican carbine, and a host of others we could mention, are more the arms for Special corps, or for field sports, than for Line infantry muskets ; and that the Enfield, in the latter respect, as a muzzle-loading rifle, is a more appropriate arm. In expressing this opinion, nevertheless, we have thought and still think, that while reducing the bore of the infantry musket, as in the case of the Enfield, it would have been better also to have reduced the length of barrel of the Enfield 3 inches, which would have facilitated the act of loading, and have more favoured the placing of the arm in that vertical position which in loading the rifle facilitates better the vertical forcing of the bullet down the barrel by the ramrod, and enables the soldier both to have more command over his piece in that act, and to take up less room than his 39 inches of barrel now permits when loading and firing in close order.

Rifles of the greater ranges of 1200, 1400, and 2000 yards, and of which, projectiles of complex make, metals, and form, constitute part and parcel of their system and efficiency, are better suited for special corps and the lovers of sport among the larger furred game and the denizens of the forest and sea-shore. The feats of the rifle-pits before a Sebastopol can doubtless be better performed with such arms, in the hands of troops well organized and trained to their special use.

With such arms, and by such troops, a greater deference will be imposed upon field batteries, despite their case shot and shrapnel, than has hitherto been evinced by that arm for infantry. Masses of infantry, and of cavalry especially, will no longer be able to move, nor occupy positions with impunity, at distances where hitherto the range and little reliable precision of artillery was for them a qualified annoyance only. No longer will cavalry be so safely kept "ready at hand" in first line, to be let loose upon infantry or field batteries ; and the ever-memorable, ill-advised, and disastrous "Charge of Balaclava," will illustrate for all time that the spirit of the principles of the brilliant school of Seidlitz, are no more applicable in the presence of a faculty of dislocation and repulsion such as was unknown and undreamt of in the days of Zorndorff and Friedberg.

Victory, which was once the special work of that costly and favorite arm of the European aristocracies, will be no more its prerogative. The improved and still improving "small arm," the rifle-musket, favoured by physical and mechanical laws, which circum-

scribe the safe application of the same principles to those mighty engines "whose rude throats mock Jove's thunders," is destined to restrict the sphere of action of cavalry to combats *inter se*, to the now far more perilous pursuit, to the maintenance of communications, the duties of the outpost, of the reconnaissance, and of the escort of the supplies for the other arms. Though recently so much in demand in the Sepoy war, in Anglo-Indian phrase, "to polish off the niggers of Oude," and "to pot Pandies," cavalry will find such exploits less easy of performance in the fields of Europe, upon the infantry of modern days, with their matchless, not matchlock muskets.

Before we close this subject, we think we shall best satisfy the wishes or anticipations of many of those readers who have followed us thus far, by devoting a few lines to their aid and guidance towards a just conception of the principles or structural features upon which a rifle, be its system what it may, must be established to fulfil those conditions which have now been made of possible attainment, with a well-constituted modern rifle.

To effect this, we shall eschew the parade of that personal opinion which, on this subject, come from whom it may, is sure to ruffle the sensitiveness of the diverse creeds which prevail thereon ; and which we think are best met with the indisputably authentic practical experience acquired in ordeals of the greatest diversity of character, time, place, and atmosphere, in a War-test more severe than the modern rifle systems are likely to be called upon to give of their ballistic merits for some time to come.

The muzzle-loading rifle of the present day may be divided into two categories or systems—that in which the dilatation of the projectile is produced from above downwards by the forcing of a solid projectile upon a pillared breech ; and that in which the dilatation is produced upwards, by the force of the powder-charge on the base of a more or less hollow projectile, set down upon the shoulders of a chambered breech, or upon the powder-charge in a flat-breeched barrel.

A difference in things applied to much the same purpose, always engenders its degrees of comparison, and the question—which is the best?—and these, though too frequently instituted and decided in a much too arbitrary manner, derivable from prejudice or from other circumstances, in rifles as in most things, perpetuate that confusion of notions which obtains so commonly : while a clear conception of the purpose for which it is specially required, and of its faculty to fulfil that object, would economise much time, with a saving of less disputation and its concurrent unpleasantness.

A rifle may be considered under two general aspects ; as a military or as a sporting arm. But as a good rifle should, of all arms, be alike efficiently applicable to both purposes, it will of course differ only as a fire-arm in that mechanical finish and artistic ornamentation which is the stamp in degree of the arm of the amateur.

Although for both these purposes we have not yet attained to that perfection of structural combination which will justify the dogmatical code of principles and rules which too many persons are disposed to lay down for every thing, yet, thanks to the labours of men of science, who have addressed themselves to the study of this arm with minds unshackled by prejudice and free from the taint of pedantry or charlatanism, we have arrived at certain definite and correct notions of what is absolutely requisite to achieve such results as *have* been obtained ; and what to avoid.

As we have already shewn when treating of smooth gun barrels, experience had already long established the knowledge that a just relative accord should exist between the length of barrel and the charge of powder and shot, in order to derive the most efficient and reliable results from that arm. In the shot-gun, or ordinary smooth-bore, the elements between which to establish this harmony are fewer in number than in the rifle, and a proportionate diversity of attention is consequently necessary to bring the greater number of elements in the latter into that just relative agreement so pre-eminently indispensable to its efficiency.

The discovery of the above-defined new methods of dilating the bullet in the grooves, was, as we have shewn, the key to all the rest. The just co-ordination of these became, then, the real subject of study ; though here, in too many instances still, prejudice, pedantry, or caprice, exert their modifying influence.

With these, however, we have nothing to do, and recommend them as little to our readers ; for the greatest obstacle to real progress and to the attainment of eminence in any art, lies less in the difficulties incidental to the study and acquirement of the art itself, than in the idiosyncracies of the individual.

As a tried basis from which to start, we will first consider the rifle, which, as a war-arm, in Africa, at the siege of Rome, and in the last crowning instance in the Crimean campaign, has indisputably acquired and established the greatest repute for its system, viz., the pillar-breech rifle of the French Chasseurs à Pied already adverted to, and since adopted for special corps in the Russian, Belgian, Saxon, Bavarian, Oldenburger, Nassau, Mecklenburger, and other services.

The merits of this rifle-musket were for some time and are even

yet contested, by some in this country. In common with most inventions, it was condemned chiefly upon supposition; but the hypothetical phases of this ground of opposition have none of them been justified in the most arduous service.

Though not a type of perfection—that quality in human productions which never yet was established—it is nevertheless the best muzzle-loading military rifle known and in use up to this time.

The defects which were affirmed to be inherent in this system, were never yet evinced in the fire and military uses of this arm, in the hands of the battalions of the French Foot Chasseurs; which refuted alike the objections of the theorist and the practician. To the arguments resorted to by these, USE, in severely successive and protracted service—that most clenching of all replications to every theory, gave a practical denial to the enunciations of the scientific and to those who made pretensions thereto.

Beside the supposed difficulty to clean this arm to which we adverted, and of which we disposed, on the good authority of those who carry and can use them, it was urged that the mode of forcing or of dilating its solid three-channelled projectile upon the pillar would annul all the advantages derivable from those channels round the bullet of the Tamisier system, in their corrective influence on its deviation.

Yet what has severe war-practice shewn, carried out under all the influences of rapid movement and great emotion? That nothing of the sort occurred even under the most unfavourable circumstances. And what was the fact?—

That while the charge of powder took its place round the steel pillar fixed in the breech of this arm, without suffering from any subsequent abrasive compression from the forcing down of the ball upon the breech, it retained without disturbance a position highly favourable to the free evolution of the gases of every grain of the charge; the expansion of which was favoured by the interstitial atmospheric air confined, as in a chamber, between the base of the bullet and the upper part or strata of the loose powder-charge—circumstances highly auxiliary to a full and quasi simultaneous evolution of the whole force of the powder-charge to start the projectile. So far for the charge of powder.

And how was and is it with the projectile?

Three strokes of the ramrod given with a regularity of vertical force, rendered the more easy to impart from the length of barrel, $34\frac{1}{4}$ inches only, or $4\frac{3}{4}$ inches less than the Enfield, force the projectile upon the top of the pillar. The compression that takes

place upon the bullet thus forced by the ramrod upon the pillar, produces at one and the same time two different effects, namely, at the centre of the flat base of the bullet brought into contact with the flat circular face of the pillar, the lead is driven in to a slight depth, or, in other words, the bullet sinks at that part to a certain depth upon the top of the pillar, expanding at the same time, and by the same agency, the base of the projectile into the grooves. Furthermore, the strokes of the finely counter-sunk ramrod, which embraces and bears equally upon the front of the ogival-cone, produce a swelling of the shoulder of the ogival just above the anterior channeled groove of the cylindrical part, which serves to protect the grooves of the bullet from the abrasions or strippings which the edges of the grooves of the barrel might otherwise produce on them; thus preserving their directive efficiency to the posterior part of the projectile, although sufficiently effecting its expansion into the grooves. Moreover, the projectile being started, the slightly deep circular hollow, punched as it were in the base of the bullet by the head of the pillar, serves now all the purpose of the hollow base expressly established in projectiles on the Delvigne-Minié principle; and, submitted to the force of the gases during the whole of the passage of the projectile up the barrel, assists the further expansion of the base of the bullet into the grooves during the whole of its interior movement of translation; so that in the grooves of this rifle, of the progressive depth already described, the projectile always fills the grooves until it arrives at the muzzle, where the rifling is nil, and the projectile departs with the whole developed strength of the powder-charge, without oscillation. The security from injury to the sharp channeled edges of the grooves of this projectile is, therefore, best insured by a slight increase of the diameter of the shoulder-part of the ogival, just in front of the grooves on its cylindrical part.

The degree of spiral or inclination adhered to for this arm, after experiments instituted with several others, was that established by M. Delvigne for his chambered-breech rifle, and adopted in the Enfield flat-breech, viz., one turn in 6ft. 6in.; an inclination impressing quite sufficient normal rotation of the projectile upon its own axis to give it great range and precision, and obviating that twist of the rifle in the hand, and that stripping of the ball, which in rifles with a sharp twist will sometimes ensue, even with greased cartridges or greased projectiles; to secure himself from which, with the rapid spiral established by Lieut.-colonel Jacob for his musket, of one turn in 3 feet, he was obliged to resort to the side projections established on his bullets, features which contribute to the complexity

of their structure, further increased by the necessity to compose them of zinc for the anterior part ; ordinary leaden bullets requiring a great diminution of the charge to prevent them receiving too great a deformation from the resistance of the high atmospheric pressure against that part of the projectile while passing up his barrel, resulting in part from the influence of so sharp a spiral.

In the establishment of four grooves instead of three in this arm (the pillar-breech rifle), a greater regard for that equilibrium which is most advantageous to establish in the appliance and action of all the mechanical forces, was had, than evinced in the adoption of three grooves in the Enfield rifle. We have already explained some advantages of the four over the three grooves in another place, but will here expatiate further on the subject.

There can be little doubt, that a more regular-balanced action or equality of the rotatory movement, is imparted to the projectile by four grooves than by three ; and in the friction arising from a movement imparted from the first, and continued throughout so equally, the impress of that equilibrium of the rotatory movement must blend equally and favourably with the movement of translation ; or, in other words, no oscillation can take place in the latter movement of the bullet up the barrel, nor on leaving the muzzle with the full impress of the initial velocity.

A reference to the action of two grooves in a rifle, especially where there exists no equality of groove and land, will illustrate how insufficient that number of grooves is to prevent the oscillations of the bullet on its passage up the barrel, an unsteadiness which remaining impressed upon it during its flight, becomes a potent accessory cause of deviation. In the case of three grooves, though they are better than two, yet they do not impart a perfect equilibrium of the rotary force to the projectile, even though an equal breadth of groove and land be established ; and for the reason that a 3-square bite, in which the grooves are opposite to the lands, does not impress such an equilibrium, either of pressure or of the rotatory force, as a perfect square, where the bite of each groove is directly opposite a corresponding motive and directive agent. With three grooves there is therefore, though in a less degree than with two, a less perfect equilibrium of the rotatory forces than with four, and a certain degree of oscillation of the projectile in the barrel which influences prejudiciously both the movement of translation and rotation. This effect of the three grooves is, moreover, more sensible in its influence on the deviation of a hollow projectile that has not a great cylindrical bearing in the barrel ; and where this is in excess,

the centre of gravity will no longer be where it should be in the elongated projectile, i.e., as much forward as possible.

In a 3-groove rifle, with equal land and groove, there will be more land than in a 4-groove of equal bore, and in the necessarily greater breadth and flatness of groove in the former, there will be more liability of the projectile to oscillate, from the want of an opposite equilibrium of the twisting forces. Oscillation entails friction of an irregular nature ; hence the friction, and a prejudicial one, is greater in a 3-groove than a 4-groove rifle. Though this may appear militant to the notion entertained by many, of the greater friction in a 4-grooved rifle than in one of 3, it will seem less so, when it is simply considered that, whether by an excess of powder-charge or other cause, the bullet is driven in its movement of translation over the grooves, without following the spiral in a regular manner, it experiences in some measure a wabbling movement, analogous to the beatings of the spherical ball in its passage up a smooth bore ; and it is influenced in the same manner by the last impingement at the mouth of the barrel, which impresses upon it a movement of rotation either from beneath, upwards, or *vice versa*. If its last impingement be on the right side, the rotation will be from left to right, and if on the left side of the barrel, from right to left.

In a 4-groove rifle, whether the grooves and lands be equal in breadth or not, there is still an equilibrium of the movement of rotation and of the friction, for the projectile is equally, regularly, and solidly expanded into the four grooves ; the hold of these upon the projectile is therefore more equal and efficient to impress the rotatory movement ; and it can experience oscillation from no agency whatever during its translation up the barrel, even though forced over the four grooves by an excessive charge. Hence the projectile is subjected to deviation by *one cause the less* in the 4-groove than in the 3-groove rifle.

Beyond the number 4, the additional disturbance given to the surface outline of the cylindrical part of the projectile by more grooves, though equal in number, is so much the more prejudicial to the form of the bullet, and therefore deteriorative to its precision of flight.

The Enfield authorities, or Mr. Westley Richards, doubtless thought differently, when in adopting the same spiral as the French arm, they rejected the four grooves, and established their arm with three. The deviation in this latter respect evinced a difference of opinion ; and that with some minds argues both independence and originality, even though not justified in the event.

To give the Enfield four grooves, to take off the three superfluous inches of barrel, and place a little more metal at the breech, would, to our thinking, be no detriment to it, but the other way. A further advantage would accrue to the soldier in thus shortening the barrel and giving the slighter thickness indicated at the breech ; he would have a better command of his arm with the bayonet fixed at the end of a shorter lever, which then would be quite long enough ; but if a pike-like length is considered so indispensable in a British musket, give that length in increase to the bayonet, which could be effected without giving the end weight at present in the 39-inch barrel and fixed bayonet.

The exaggerated importance given by military men themselves, and by the civilian public generally to the infantry musket in this sense, was a great error. To this false estimate of its importance as an arm of close combat in substitution of the pike, its real value as a projectile-arm, even before its present improvement, was sacrificed ; and its little precision still more prejudiced by the prescriptive rule to fire in all cases with the bayonet fixed, to say nothing of the increased unsteadiness given to the arm while firing, by that increase of its weight and leverage. The real strength of modern infantry lay in its fire, and *will now, yet more so*. That the experience of all modern wars, and common sense, had not long since corrected this false estimate is surprising ; for what real capacity for successful defence would a line of infantry with expended ammunition present, having nothing but an arm projecting at the utmost but 3ft. 3in. beyond the men of the front rank, to a charge of cavalry ? No cavalry were ever yet repelled by infantry with the bayonet. The weight of each horse and rider, taken at 500lbs., apart from the impulse of the horse's muscular strength, which equals at least that of seven men, coming with a force, the effect of which increases with that of the rapidity, would overwhelm a 3-line formation, or square of the best infantry in the world, if that cavalry has not been previously shaken by their *fire*. In the attack of intrenchments, villages, assaults, or the like circumstances, where the soldier may be required to fight hand to hand, the bayonet assumes its real importance only ; and if the full advantage be taken, as should be, of the precision and range of the Modern Infantry Rifle-Musket, those who first discontinue the old practice of firing with fixed bayonets in all cases, will first evince their just estimate of the real character and importance of the musket as an arm of battle.

We need scarcely say, that rifles of great range and precision are also established on the Delvigne chambered-breech system, and

on the more simple flat-breeched Minié principle. But on whatever system, or modification of system, the dilatation of the projectile be produced, and whatever the form and structure of projectile adopted, the same fundamental necessity applies to all, of a just and harmonious agreement of the inclination of the spiral with the length of barrel, the charge of powder, and the weight and form of the projectile, and unless there is a primary equilibrium established in these elements, the faculties of range and precision in the arm can attain no definite and reliable standard of excellence. A disproportion of one of these elements to the rest produces a prejudicial effect upon the agreement of all, and infallibly influences the results in a disadvantageous manner. To establish that accord, therefore, is indispensable in every modification of the structural elements of a rifle; and, once established, to vary either one or the other, without carrying out that change in the rest, is subversive of all accord.

These elements well established, a certain ulterior perfecting of their relative harmony can frequently be produced by such further modifications in one or more of them as do not affect or militate against their general accord. But in attempting this, the greatest caution must be observed; they must be got at step by step only, and with a careful practical test of the degree of modification admissible.

In conjunction with Mr. Whitworth of Manchester, the designer of the Enfield arm has since established another system of muzzle-loading rifle, which in the trials made of it at Woolwich and Hythe, exhibited a great superiority over his (Mr. Richards) first essay, the Enfield.

The distinguishing feature of this, the Whitworth-Richards Rifle, consists in the form of the bore. But as much of that repulsive craft-mystery for which private artisans in gunnery were so much and justly reproached in the olden time, has been exhibited in the instance of this production and its trials, little respecting it has hitherto been permitted to transpire.

Nevertheless, as far as report has spoken, the bore of this arm—instead of being spherical in the norm, with grooves subsequently established throughout its length—is hexagonal, or six-sided; which hexagonal form of bore is carried out spirally, and constitutes at the same time the rifling agencies: in other words, an hexagonal twist of and in, the interior superficies of the bore, performing the office of as many ordinary grooves. The results of the application of this principle—which we have heard both greatly decried for its immense friction (that bugbear of the old smooth-bore partisans), and greatly

lauded for its surprising absence of friction and recoil—appear to be, that, with a projectile of the same weight and form, and with the same charge as the Enfield, it has a superior range and precision to that arm ; is better at 800 yards than the latter at 500 ; and instead of the maximum range of the latter of 1100, has a maximum range of 2000 yards.

Our readers will doubtless consider, with ourselves, that in so far as excelling the Enfield, by no means the best of modern war rifles, the Whitworth-Richards rifle has not effected more than has already been achieved and which is performed by the Delvigne, the pillar-breech, the Corsican, and the Jacob's rifles, the establishment of which were certainly not so costly.

The feature which will doubtless be eventually considered the most remarkable one of this arm, at least in the eyes of foreigners, is indeed the cost at which the principle of its construction has been so far established. £10,000, for such is the sum specified by common and accredited report, will no doubt appear a considerable investment, even in the eyes of natives accustomed to pay dearly for most things, for a rifle which exhibits no greater range nor precision than the pre-existing arms above indicated.

In this matter, by some means or other, the workings of which would doubtless furnish fruitful and instructive materials for illustrating our national idiosyncrasies, it would seem our ethnical commercial propensity to obtain a thing at a lower rate than any one else, has led to the same result which has been special to us, i.e., that we have paid more for it than any one else would have paid ; and if the ordeals of time and service-experience do not render a good account of it, we shall at least merit the flattering astonishment, that English liberality is generally so suggestive of to other nations.

We have frequently heard it remarked by persons desirous either to purchase or to order a rifle, that despite all the information that has been acquired and made known by modern experiment, so many conflicting opinions and dicta still exist, not only among their own acquaintance, but among gunmakers themselves, respecting the best system or the most appropriate structure of this arm, that they are at a loss how to decide before making an outlay so considerable as that usually required for a rifle, constituted for efficiency and put out of hand as it should be.

As relates to those general elements of structure which should distinguish a modern muzzle-loading rifle, it may be roundly affirmed, that the knowledge of those principles has been now some time placed alike beyond the arbitrary dogmas of speculative and untried

theory, as of the individual prejudices or pedantry of the craft. The modern rifle has, in fact, been brought to its present phase of excellence by a series of scientifically conducted practical studies, carried out, not for the advantage of an individual or trade only, but for higher State advantages, such as within the same period no other fire-arm has had directed to it, since their first introduction. The line of road to the acquirement of its knowledge may therefore now be said to have been marked out by finger-posts of so legible and immutable a character, that those who go or permit themselves to be led astray will have themselves alone to blame.

In a word, both a clear conception and a distinct designation have been obtained and given of the general principles upon which this arm must be established for efficiency; and with almost as clear a comprehension and definition of the physical laws and phenomena which govern and affect their application. It may therefore be laid down, that those who vary the least from these way-marks will best obtain the objects required of this arm, viz. precision combined with a good range.

In order to facilitate a clear comprehension of the constituent elements of a good rifle, we will adopt a catechetical formula, as one equally well adapted to elder understandings requiring clear notions of a subject.

What were the chief defects of the rifle of the past?

A deformation of the projectile, prejudicial to its flight; derived from an imperfect mode of loading and dilatation of the bullet. A less range and percussive force than the smooth-bore musket, though with more precision for short and intermediate distances.

The two first derived from the ill agreement or want of equilibrium that existed between the movement of translation impressed upon the bullet by the powder-charge, and the movement of rotation impressed upon it by the grooves of the rifle.

How was the first remedied?

By an improved mode of loading and dilatation of the bullet.

How the second?

By establishing a better harmony between the charge of powder giving the movement of translation, and the inclination of the spiral or twist of the groove that gives the rotary movement.

What are the other elements of its structure, and of the projectile, which by their improvement have been made auxiliary to the above results?

The improvement in the form and depth of the grooves or factors of rotation, and in the form of the projectile.

What have these discoveries led to?

To an advantageous resort to *elongated* projectiles ; and the knowledge of a further valuable accessory to the advantages obtained by the improvements above cited, viz., of the weight and length of the projectile which best harmonises both with the force of the powder, or translating factor, and the inclination of the spiral of groove harmonising with the latter.

In constructing a muzzle-loading rifle, therefore, on which ever modern improved system, whether for the use only of solid, or hollow projectiles, or both ; in each and all, equilibrium must be established between the movement of rotation and movement of translation of the projectile : the greater or more intimate the accord of these, the greater will be the facility to obtain a co-relative harmony in all the other elements of the arm ; and the more perfectly this general equilibrium of forces and resistances be established, the more effectually will the arm fulfil all the conditions of a good rifle.

As regards those features which may be considered auxiliary to the attainment of this standard, it may be argued, that if speed and facility in loading be a cardinal advantage for a military rifle, it is no less so for a sporting rifle ; and this is best established by a barrel of intermediate length. From 30 to 36 inches barrel as the maximum, with a total length of the whole arm of 4ft. 3in., will better facilitate this than a barrel of 39 inches with its proportionate greater length of arm. Ease and regularity of loading, which so much contribute to an equable dilatation of the bullet, will be best afforded by the lengths indicated. We will consider the bore under the following points of view.

As the use of elongated projectiles has permitted a decrease of the bore of the rifle, and an advantageous return to the diameters in use in the rifles of the sixteenth century, the advantages derivable therefrom in the modern rifle systems are : solid elongated bullets can be used ; a greater thickness and strength of barrel can be established with less weight of metal ; a greater strength of stock with less wood ; a greater number of rounds of ammunition can be carried ; and with equal weight to the spherical ball of a larger bore barrel, a greater penetration is obtained, rendering the rifle of the sportsman (although of small diameter of bore) applicable to the purposes of war. To the length of barrel above indicated, a bore of the diameter of $\frac{3}{8}$ of an inch, or 26 gauge, will therefore be a good intermediate calibre.

On the breadth given to the grooves must naturally depend their number, for the broader they are the fewer will the bore admit of.

If number be the object, they must therefore be established very narrow, which then renders the cleaning of the arm a matter of greater difficulty.

The best depth to be given to the groove is decided by experience only. Deep grooves cut into the bullet, and raise round it corresponding ridges of the lead, which form prejudicial resistances, and greatly decrease the movement of rotation and range. They, moreover, weaken the barrel; sooner contribute to impair its efficiency; render the dilatation of the projectile more difficult to effect, either by the stroke of the ramrod or the powder gases, or by both; the lead penetrating seldom, or unequally, to the bottom of the grooves, loss of the powder gases and force of translation ensue. They must, nevertheless, be of sufficient depth to impart the movement of rotation effectually, and to receive the powder residuum readily, so as not to foul the lands and obstruct the shooting.

Four grooves of a rounded form, of equal breadth with the lands, of a regular spiral for hollow-expanding bullets (with which the increasing spiral often occasions deformation of their cylindrical part); of a slightly progressive depth, i.e., gently decreasing in depth upward from the breech, for solid or slightly hollowed bullets, dilated by the ramrod on a chamber or on a pillar (for which projectile this mode of establishing the groove is very favourable), with a regular spiral of one turn in 5 feet, and a powder-charge of $2\frac{1}{2}$ drachms—may be assigned as presenting that proportion of structural elements which would constitute an efficient sporting rifle. The total weight of such an arm need not exceed $8\frac{1}{2}$ lbs. The ramrod countersunk accurately to fit the anterior form of the bullet used; and furnished with a stop or projection similar to that used in the Swiss Federal Rifle, to prevent ramming down the ball too much.

At the risk of some iteration, so difficult to be guiltless of in treating on a subject of this kind, we will conclude with a few of those notifications which experience has stamped with the impress and form of Maxims, well to remember; from which, corollary or inferential conclusions may be readily arrived at, and likewise become impressed on the mind.

Although the grooves in rifled fire-arms modify *deviation*, and give more regularity to the trajectory of their projectiles, it must never be forgotten, that they also put difficulties in the way of impressing great velocities and ranges on their projectiles. The velocity of these depends especially, as already frequently observed, upon the degree of inclination of the spiral, the breadth and depth of the grooves, and the force of dilation of the projectiles.

The greater or more rapid the inclination of the spiral, the more rapid the movement of rotation ; but the less velocity in the movement of translation ; and unless with an appropriate charge of powder and greased cartridge or projectile, the recoil will be very sensible, and the results indifferent. The precision, or accurate shooting of rifled arms depends, therefore, on the accord of all these elements, and on the determination of that accord between the two Factors of Impulsion and Direction, which experience best affords.

When impressed with a limited force of translation and velocity, the projectiles of rifled arms experience more resistance from the air than is experienced by the spherical ball from the smooth bore. In rifled fire-arms, the reverse again of the smooth bore, the greater range and penetration is not necessarily to be obtained by increasing the size of the bore. The decrease of the bore, and the increase of the length of the projectile merely, with a co-relative or proportionate variation of the other elements of the arm, will achieve these more advantageously.

But that which sets limits to these faculties of increased range and penetration in modern rifled arms, is not the calibre or bore, as in former arms ; but the RECOIL, and the limit imposed by the resisting power or thickness of the barrel.

The increased length and weight of the projectile does not necessarily require an increase of the charge of powder. Though that may vary but little, yet when the length and weight of the bullet are increased, the action of the powder-charge against the barrel, and, its resultant, the force of the recoil, will be increased likewise.

An excess of powder-charge is less prejudicial to good results with a slow, than with a rapid twist of groove, and the recoil less. But if the charge be too weak, though the bullet follow exactly the twist of the grooves of either kind of spiral, it effects this with a force inadequate to overcome the resistance or friction of the grooves in the barrel ; and, on issuing from this, too little initial force is impressed upon it to attain a good range.

The shorter the barrel of a rifled fire-arm adapted to a small charge of powder, the sharper should be the twist of the grooves, and those of little depth. In a pistol, for instance, destined for target practice or general use, loading with weak charges, the twist of the grooves should be sharper than in a holster pistol ; and in the latter, sharper than in a carbine or rifled musket ; the latter arms, from their greater weight, length of barrel, and weight of projectile, requiring a stronger charge, with a less rapid spiral of groove.

No elongated bullet wholly constituted of lead preserves its form

unaltered until it strikes the target, or object at which it is fired ; for both the anterior and posterior part of the bullet receive a change of form, and that impressed on the anterior part is very prejudicial to its precision, range, and penetration. The causes of the change of form on the anterior part of the wholly leaden bullet are, the susceptibility of damage to that part in the carriage, from the inherent softness of the lead—the compression of that part of the bullet by the ramrod in loading, if the latter be not well counter-sunk to its shape, and more than all by the compression experienced by the front of the bullet by the resistance of the condensed air in the barrel, as it is driven out. The change of form impressed on the anterior part of the bullet, though great, is nevertheless not so prejudicial to its precision, as the deformation of the sides of its posterior or cylindrical part, which in too deeply-hollowed expanding bullets, fired from a rifle with grooves too deep, and with too sharp a spiral, not unfrequently occurs. But, as in the rifle of the amateur, the restrictions of economy are not so arbitrary in respect to the material of the projectile for the attainment of the results desired ; this defective property of leaden bullets can be obviated by various means, such as the use of zinc or iron for the conical part of the projectile ; but, better than either, by giving at the same time a homogenous character and density to the metal of the bullet, with *great elasticity*, by infusing quicksilver into the lead. Projectiles thus composed would present weight with a reduced size, a less readily prejudiced precision, great penetration, and would not lead the barrel so much. Antimony can also be applied to a similar purpose.

To the acquirement of skill in shooting with the rifle the same may be said as of the art of equitation, and every other. Some individuals are by nature better adapted thereto than others, but the possession of certain inherent physical faculties to its acquirement, together with a certain natural tact or judgment, are pre-eminently necessary to make a good rifleman.

As a ready and correct appreciation of distances is indispensable to success with this arm, a good faculty of sight must go hand in hand with judgment, and both must be practised unremittingly. In the exercise of these, must be acquired : a ready aptitude to regulate the back sight by the front sight ; a good method of bringing the rifle to the shoulder ; a well-tempered regular pressure of the finger upon the trigger, so as not to disturb the steadiness of the arm from the line of aim ; and a well-timed suspension of the breath just previous to and during the whole act of firing.

The pursuits and town-life habits of the majority in the present day, are not favourable to the exercise of a good sight, even though possessed; but if this exist, the judgment or tact to use it with advantage may be developed by practice. An ordinary or indifferently good sight may be strengthened by exercise and training; and this must be done by him who would become an expert shot with the modern rifle. The acquirement of this faculty to its successful use can be obtained generally where the disposition exists; and the study of this art can be made to impart an additional interest to every walk into the country, by estimating mentally the distance of different objects as they present themselves, and ascertaining the correctness of that estimate by regular admeasurement, or by the ordinary walking pace computed at 2ft. 2in.

The exercise of the eye and judgment in this practice, carried out under different states of atmosphere, time of day, over level ground or intersected by water, up hill and down, will soon impart a facility to appreciate distances correctly, and carried afterwards into practice with the rifle in the hand, as far as the individual is concerned, will develop, sooner or later, the necessary ability to become a good shot with the rifle.

While speaking on this important acquirement—one the possession or practice of which was hitherto considered more in the demesne of the sportsman than of the soldier—we cannot refrain from the expression of our admiration of the generous encouragement held out to the soldier by the distinguishing badges and pecuniary emolument for skill in the use of the improved musket, which the recent judicious Regulations of His Royal Highness the Commander-in-Chief promulgated, in whom, in all that concerns the military efficiency and social position of the soldier, with rare exceptions, since the days of the Marquis of Granby, the British soldier may be truthfully said to have found a real “soldier’s friend.” So long as the prescriptions of the Regulations adverted to are faithfully and fairly followed out in their spirit and practice, it may reasonably be anticipated that no infantry will excel the British in the use of the new arm, and that, as heretofore, when all were in near equilibrium as regards fire-arms, their acknowledged prestige for the use of an inferior weapon, will be yet more established in transfer to the rifled musket.

However well constituted a rifle may be in all its elements of length, structure, and charge, the degree of precision to be obtained by it depends upon the manner in which it has been *sighted*; and as the most just coincidence of action must be instituted between their front and back, or elevating sights, even to a mathematical regularity, the sighting of the rifle is a matter of great delicacy.

To many of our readers it will doubtless be well known, that though the individual or isolated action upon the arm, of the front and back sights is wholly dissimilar, yet by an harmonious property of amalgamation that difference of individual action tends to rectify itself one by the other, and produces the *aim*. The front and back sights of rifled arms, in use from an early date, have, in common with the progress made in the arm itself, assumed a variety of forms almost innumerable.

As regards the front sight, its height should be exactly equal to the difference between the thickness of metal at the muzzle and that at the breech. When the arm is placed in a perfectly horizontal position, this sight in its entirety—foot, stem, and summit—should be in the vertical plane of the axis of the barrel, which vertical plane must also pass through the bottom of the notch in the back or breech sight. The front sight should be carefully established of a size, such as on taking aim does not wholly cover the notch in the back sight. The existence of such a defect disables the eye of the person shooting from ascertaining whether the front sight corresponds with the centre of the target, &c.; and constant deviations to the right or left of the object would ensue therefrom. On military rifles, in order to admit of fixing the bayonet, the front sights are generally placed at from $\frac{3}{8}$ to $\frac{1}{2}$.an inch from the muzzle; at other times close to the muzzle. This sight is sometimes made moveable or sliding, and of various forms, with a pin-like head, or in the shape of a half-moon, &c. The back or breech sight is also either fixed or moveable; slide-sights, leaf-sights, screw-sights, telescope-sights, &c., &c., according to the fancy of the maker or the special desire of the amateur; for though the rule is, that the front and back sights should always be established in the vertical plane of the axis of the barrel, there are, nevertheless, exceptional circumstances in which this must be departed from, and without which divergence from the general rule, all precision of shooting would be impossible.

The faculty of vision is not the same in all men; and, according to the individual's knowledge of the irregularity of character of his own faculty of sight, the deviation from the rule must be variously established. He whose fault of vision, or whose contracted habit, disposes him when aiming at the object to incline the piece to the right or to the left, or to see the object aimed at higher or lower than it really is, will not find those defects remedied or met by the most perfect disposition of all the structural elements of the arm.

It is alone, therefore, in the co-relative form and well-established

harmony of the front and back sights adapted to his particular vision, that he can rectify his personal imperfection of sight or defective habit.

The result of the defects adverted to would be : knowing that he sees the object to the right, he will move the front sight to the right, in order to leave the axis of the barrel to the left, by which means the rifle will shoot more to the left : and if he sees it to the left, he will put the front sight to the left ; which will bring the axis of the barrel to the right of the front sight.

Should he always see the object aimed at too low, the back sight must be high, and the front sight short : this disposition of the front and back sights lifts the shot. If, on the other hand, the object appears to him too high, the back sight should be low, and the front sight high : by this means the shot will be low.

This deviation or defect of sight in different individuals is, of course, a very frequent and sensible impediment to the development by training of an equal skill in shooting in the soldiers of the same company, and as naturally extends throughout every regiment. This might, nevertheless, be greatly alleviated by a very reasonable deviation from the rule of one general system of sighting the rifled musket for the whole army. This might be deemed impossible or inexpedient to effect on a large scale. But we do not suggest it to such an extent ; and if not for the Line regiments, at least we think it admissible in our Rifle regiments ; in which the issue of a certain number of rifles, with moveable or sliding front and back sights, would greatly contribute to neutralize those individual defects of vision which are to be met with more or less throughout a company, as well as to remedy those deviations in some arms which result from a greater or less degree of accuracy in their shooting qualities.

Furthermore, we think it would evince much more good sense on the part of the Military clothing authorities, to discontinue the use and issue of the comic, charity-boy, peakless caps to the troops ; in which, with eyes unshaded from the sun and light glare, and unprotected from wind and rain, they are marched out to rifle practice ; and, under disadvantages existing in no other Service, expected to achieve an equal skill in shooting with the rifle. The person or persons who suggested a peakless Huzzar busby for the head-dress of our Sappers—a body of troops as eminently requiring eye-shade from their head-gear as do Riflemen—appear wholly to have ignored the nature of the obstacle they were imposing upon their acquisition of skill in the use of their elliptical bore carbines. We greatly doubt whether the Sardinian Bersagliari, the French, Belgian, and other

Carabiniers à Pied, &c., &c., would have acquired their repute as riflemen, with eyes bared to every atmospheric influence, as is the absurd practice adhered to in our service, and which as little illustrates taste in style, as it does a military conception of the requirements of troops from whom a proficiency is expected in the use of the arms they carry.

Having adverted to the difference in the faculty of sight in the men of one and the same regiment—a difference which in the practice at the butt must soon make itself obvious to every intelligent instructor of musketry, if not to the recruit himself—we will lastly remark upon another important deviation in the physical conformation of individuals, which having been wholly disregarded when the old musket was in use, does not appear to have received a whit more attention since the issue of the improved weapon, although one which for its efficient use, pre-eminently requires a suitable adaptability to the personal build of the individual.

Short-armed and short-necked men (characteristics of make which frequently go together), though otherwise well-proportioned and with excellent vision, are very frequent in a corps. Yet the rifle-muskets issued are all *of one length of stock*. To expect the same quickness of adjustment and precision of fire from the short-armed men, with the weapon suited to men of average or of long length of arm, is now a much more salient error than heretofore. The remedy to this will be in the issue of rifles of at least two different lengths of stock, differing from $\frac{1}{2}$ of an inch to 1 inch from each other.

This suggestion will doubtless find its opponents. But, at least, no plea of additional expense can be urged as ground on which to object to such an innovation; one that would be found favourable to the development of a more equalized individual skill with the new arm throughout regiments; to say nothing of a great saving of time and trouble in the instruction of the recruit, and the futile endeavour to obtain from him the same aptitude, with a piece not suited to his build, as from his comrade with no better faculty of sight, but to whose length of arm the fixed regulation length of stock is suited. That which was deemed of little import with the old smooth-bore, and the system which then prevailed—more exactive of simultaneity of noise and smoke from a line of infantry, than well-levelled arms fired with aim—assumes a much graver importance with an arm of precision: and if we would exact from all some degree of parity of skill in its use, it is but consistent to furnish the means for its attainment, when it can be done at no extra cost.

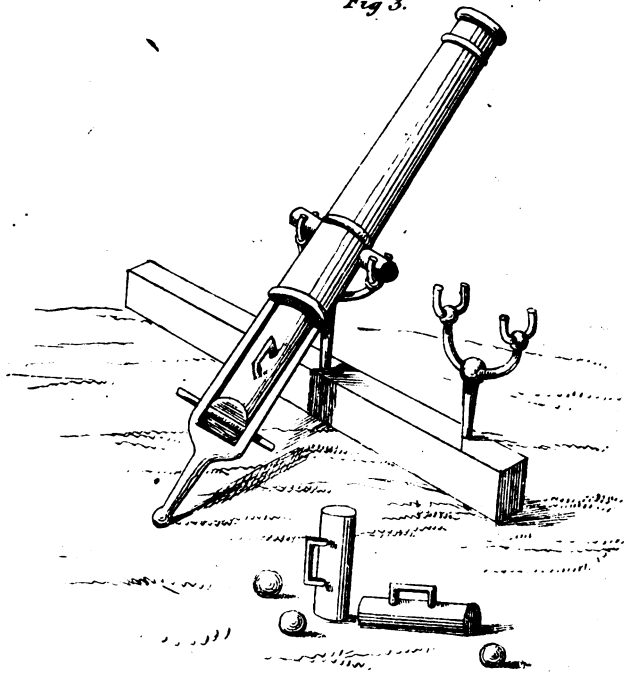
The RIFLE, the arm for which Napoleon I. entertained so much

dislike, and considered "the worst weapon that could be put into the hands of a soldier," is in the present day a weapon such as would doubtless have induced that great Commander to forego his prejudice against it. And as far as relates to the progress made in this and other arms, great as it has been, we think it may be doubted that the muzzle-loading rifle has reached the limits of that perfection of which it has been proved susceptible after the lapse of so many centuries. In their further progress, as in that of every branch of mechanical art and science, and indeed as in the progress of civilization and national improvement itself—all depends on the spirit in which these are understood. All alike will be best achieved by the rejection of prejudice, and a generous and due appreciation of individual merit and worth, regardless of clime and country. Genius is the prerogative of no family, race, or nation; and we are as much beholden for the progress we have made in art and science to the labours of foreigners, as foreigners have been and are to the illustrious men whom these islands claim as countrymen.

In the contemplation of the works of art and scientific skill, of the phases of their progress, and of the labours of those who contributed thereto, and are still giving their aid, let therefore the meed of merit be assigned to all to whom it of right belongs. Those are the greatest retarders of real improvement who, from a misunderstood sentiment of nationality, contribute to that *distortio* or "*suppressio veri*," which misleads where its observance should guide aright. And if it should be considered by any, that we have spoken somewhat plain in some instances in the present Treatise on the History and Science of Fire-arms, we make our reply in the words which Count Cavour but recently expressed to those who deemed him unpatriotic—"The best mode of proving one's love of country is to proclaim truths."

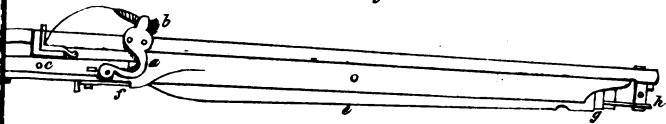


Fig 3.



Breach loading Pierrier of 11 Century.

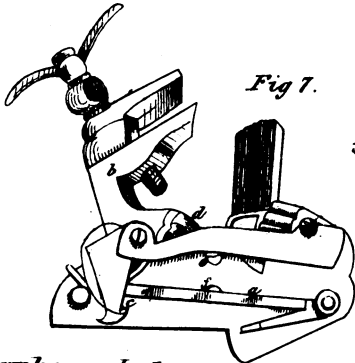
Fig 5.



The Match Lock end of 14 Century.

Fig 7.

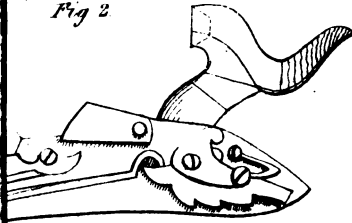
of size



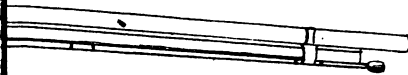
Snaphame Lock, with German Wheel Lock.



Fig 2

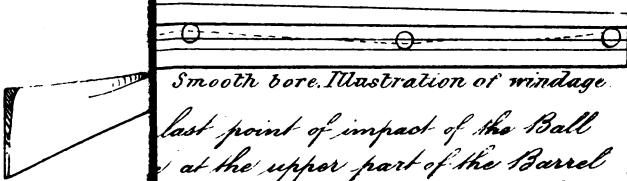


Percussion Lock.



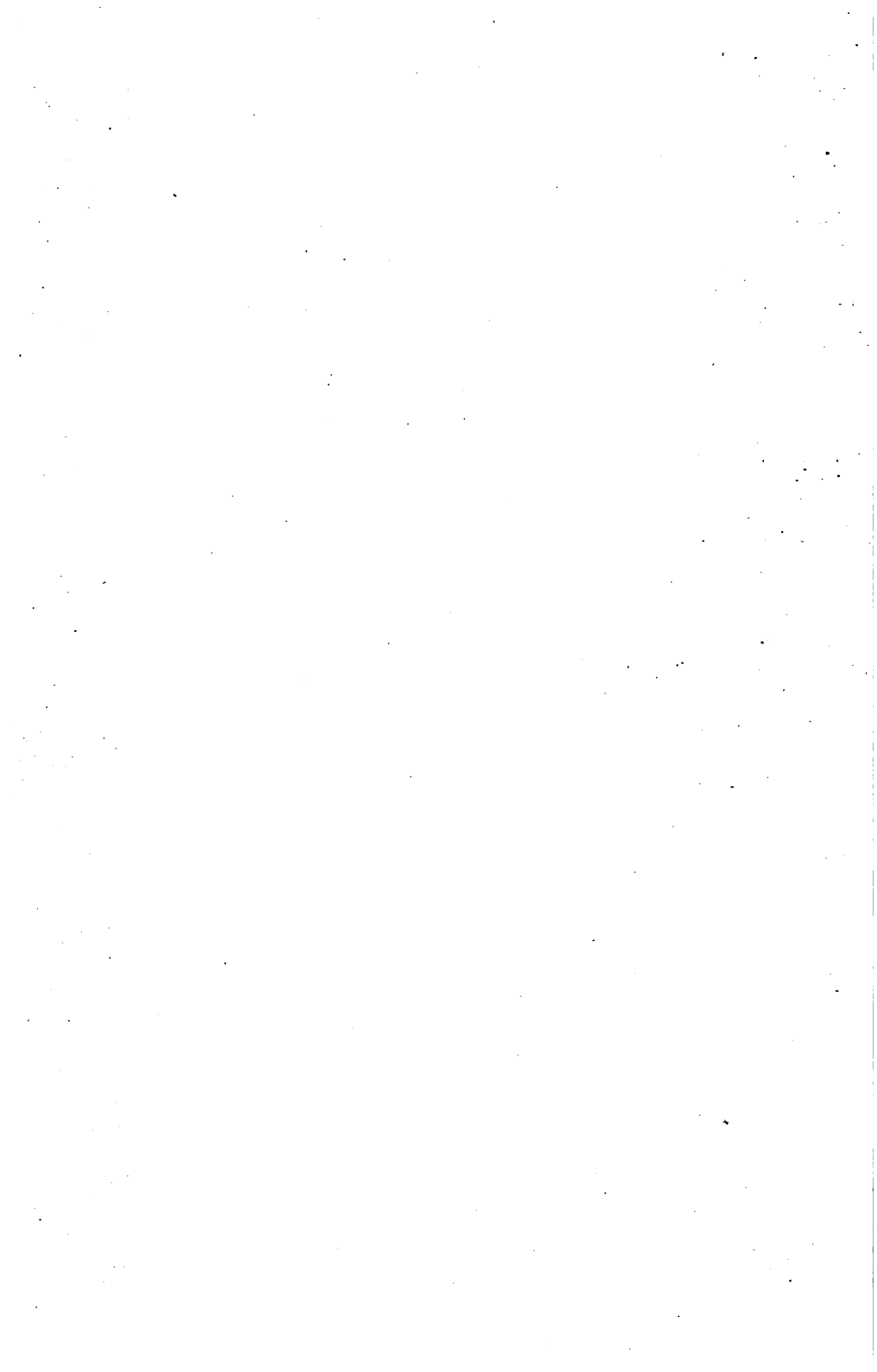
revolver.

Fig 5.



Smooth bore. Illustration of windage.

last point of impact of the Ball
at the upper part of the Barrel
ent of rotation takes place from
ards; and vice versa when the
it is against the lower part of the



COMPARATIVE TABLES

OF

FRENCH AND ENGLISH WEIGHTS AND MEASURES,

Of frequent citation in the present work.

LONG MEASURE.

FRENCH.		ENGLISH.						
Metre.	Millimetre.	Mile.	Furlong.	Pole.	Fathom.	Yard.	Foot.	Inch.
0 · 025 $\frac{1}{2}$	1
0 · 304	1	
0 · 914	1		
1 · 828	1			
5 · 029	1				
201 · 164	1					
1609 · 314	1						

AVOIRDUPOIS WEIGHT.

Gramme.	Centigramme.	Ton, or 20 cwt.	Cwt., or 112lbs.	lb., or 16oz.,	oz., or 16drs.	dram.
1 · 77	1
28 · 33	1	
453 · 41	1		
50,782 · 46	1			
1,015,649 · 20	1				

TROY WEIGHT.

Grammes.	Centigrammes.	lb.	oz.	dwt., or 24grs.	grain.
0 · 06	1
1 · 55	1	
31 · 09	1		
373 · 09	1			

SYNOPTICAL
TABLE OF CONTENTS.

	Page
Preface	5
Introduction	11
The Bow and Cross-bow	17
Synchronological and Historical Retrospect of fire-arms and inventions in gunnery and projectiles	26
Gunpowder	65
Ignition and combustion of	66
By weight and by measure	68
Residuum after combustion	69
Force and action of	70
Circumstances modifying the action of	71
The modern discoveries in Explosive Agents, and their application to fire-arms	75
Fulminating cotton	87
Concluding remarks	88
The general principles on which the construction of fire-arms is based	94
The weight of gun-barrels	95
The length of gun-barrels	96
Charge of powder	97
Windage	98
The Trajectory, or line of translation described by projectiles	101
Point blank and point blank range	103
Use of breech or back sights	104
The manufacture of fire-arms	105
Double-barrel guns	115
The Sporting or shot-gun, its choice, &c.	118
Of the trial of the gun	122
The keep-in-condition and cleaning of the gun	128
The cleaning of the lock	129
Of the trigger	131
Of the interior polish of gun-barrels	138
Of the breeches of guns and their different kinds of chamber	137
Nipples and caps	143
Of gun-wadding	146
Shot-gun cartridges	149

	Page
Shooting accoutrements	152
The powder-flask	152
The shot-pouch	154
The Pigeon and Duck gun	256
On Accidents with fire-arms	160
The causes of the bursting of gun-barrels	162
Fire-arms of Aberrant Form	164
The majority of the "new inventions" of modern times, resuscitations of earlier efforts of the gun-maker's art	165
The Breech-loading principle	166
Earliest recurrence to in the present century	<i>ib.</i>
Successive modifications	171
The Needle musket	<i>ib.</i>
Modern types of breech-loading principle for sporting purposes ..	174
Merits and disadvantages as compared with muzzle-loading guns ..	175
The breech-loading principle as adapted to the arms of Special corps of light infantry	177
The lance-fusil of the Cent-guard, and other military types	178
Prince's system	181
Synoptical table of modern systems, foreign, American and English ..	188
The Revolving-breech principle	190
Ancient types of	191
Early resuscitations of in the present century	192
Incorrectly attributed to Colonel Colt	193
Anterior American, French, and Belgian types	194
The Colt revolver	197
Lang's, Barnett's, and Adams' revolvers, with a comparison of the Colt and Adams' systems	199
Tabular list of most known systems of Revolver	215
The Revolver pistol as a Cavalry arm	216
Muzzle-loading rifles	217
Dissonance of opinion with Captain Panot respecting the origin of the rifling of fire-arms	<i>ib.</i>
The early intelligence of a certain degree of theory made evident in the great variety of structural form exhibited in ancient rifles	219
The so-called "American freed-bore" an ancient German conformation of groove of early and frequent occurrence	231
Modern instances of the worth of the rifle as a military arm before its present improvements	222
The Delvigne system	228
Modifications of Lieut.-colonel Poncharra	233
The Delvigne-Poncharra system, modified by Colonel Thouvenin ..	234
The Minié modification of projectile for Thouvenin's pillar-breech rifle	235
The improvements of Captain Tamisier in the projectile and rifling of the pillar-breech musket	236
Tamisier's theory justified by practice	237
Invalidity of the objections made to the Tamisian theory	238
Results of experiments at Chatham to ascertain the efficiency of the English percussion smooth-bore musket	251
The Marquis of Anglesea introduces the new Regulation Minié musket	254
Application thereto of an English pattern so-called "Minié bullet," expanding, with iron cup	255

	Page
Enfield trials of Lancaster, Wilkinson, Enfield, and other muskets, with descriptive table	257
Respective merits described	258
Lieut.-colonel Jacob's labours and system of rifle-musket	262
His misapprehension of the "original Minié bullet" elucidated	264
His elongated projectile	265
Long-range rifles of complex system and projectile less calculated for Line infantry than Special corps	266
Future influence of the improved Infantry fire-arm to limit the sphere of action of Cavalry	267
The modern rifle systems reduced to their simplest distinguishing characteristics	268
The defects imputed as inherent in the pillar-breech rifle not realized in the experience of the war-test	270
Comparison of the relative superiority of three or four grooves	273
Long-existing and general misapprehension of the real importance of the Infantry musket	274
The Whitworth-Richards rifle	275
Guide to the choice or construction of a rifle	176
Indispensibility of a correct Appreciation of distances	281
The Sighting of the rifle, rules for and exceptions to	282
Suggestion for the alleviation of differences of vision in the men of a regiment	284
Napoleon the First's opinion of the rifle as a military arm	285
A misunderstood sentiment of nationality retards progress in the arts and sciences	ib.
Comparative Tables of French and English weights and measures	287

F I N I S.

GEORGE T. THOMASON,
Illustrative Printer,
80, UPPER THAMES STREET.

