

Reprint

QP

31

S65

1965

LIBRARY  
NEW YORK STATE VETERINARY COLLEGE  
ITHACA, N. Y.





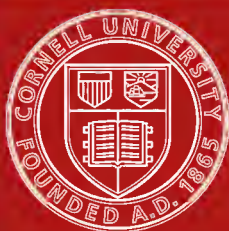

# Cornell University Library

The original of this book is in  
the Cornell University Library.

There are no known copyright restrictions in  
the United States on the use of the text.

<http://archive.org/details/cu31924000350045>

H. R. Ryder  
Chicago.  
N.Y. Ill.



# THE PHYSIOLOGY

OF THE

# DOMESTIC ANIMALS

A TEXT-BOOK FOR VETERINARY AND MEDICAL STUDENTS  
AND PRACTITIONERS.

BY

ROBERT MEADE SMITH, A.M., M.D.,

PROFESSOR OF COMPARATIVE PHYSIOLOGY IN THE UNIVERSITY OF PENNSYLVANIA;  
FELLOW OF THE COLLEGE OF PHYSICIANS AND ACADEMY OF THE  
NATURAL SCIENCES, PHILADELPHIA; OF THE AMERICAN  
PHYSIOLOGICAL SOCIETY; OF THE AMERICAN SOCIETY  
OF NATURALISTS; ASSOCIÉ ÉTRANGER DE LA  
SOCIÉTÉ FRANÇAISE D'HYGIÈNE, ETC.

---

WITH OVER 400 ILLUSTRATIONS.

---



CHICAGO  
ALEXANDER EGER  
PUBLISHER  
1905

17 = 7485

---

Entered according to Act of Congress, in the year 1889, by

F. A. DAVIS,

In the Office of the Librarian of Congress, at Washington, D. C., U. S. A.

All rights reserved.

---

QP  
31  
S65  
1765



TO MY FRIEND AND TEACHER,  
CARL LUDWIG,  
IN  
HUMBLE RECOGNITION OF THE MANY FAVORS  
CONFERRED ON THE AUTHOR.



## PREFACE.

---

In lecturing in the Veterinary Department of the University of Pennsylvania the author has found it a serious disadvantage that the students are compelled to rely solely on the notes that they may be able to take during the lectures. While French students have access to the encyclopædic work of Colin, and those familiar with the German language to the admirable works of Schmidt-Mülheim, Bruckmüller, Munk, Ellenberger, Gurlt, Thanhoffer, Müller, and others, English-speaking students have absolutely no work to which they can turn to obtain any application of the laws of physiology to the functions of the domestic animals. Commenced originally as outline notes for the author's own use in lecturing, this work has been published at the request of his students, in the hope that it may supply them with an exponent of the laws of modern physiology applied, as far as possible, to the functions of the domestic animals, and that a recognition of its shortcomings may stimulate investigation of this much-neglected branch of physiology.

It is surprising, in view of the ceaseless activity of physiological students throughout all the world, that more attention has not been devoted to the application of improved methods of research to the study of the functions of animals so important in the domestic economy. Unfortunately, investigators in this domain may almost be counted on the fingers, and the field which is yet untouched is almost unbounded. The author, therefore, has been compelled to assume that in many cases the laws of the physiology of man, which, to be sure, have been deduced from experiments

on animals, are applicable to the vital processes of the domestic animals.

Modern physiology rests on the application through experimental research of the laws of physics and chemistry. The fundamental principles of these sciences in their relation to biology have been, therefore, discussed somewhat at length. Experience has taught that a comprehension of the laws of life in the higher mammals is best attained after a familiarization with the vital operation of lower forms. The first part of this book, therefore, deals with the general laws of life, while in the second part these principles are applied to the study of the vital operations in the domestic animals, the study of each function being introduced by a sketch of the mode of development of the mechanism by which that function, in passing from lower to higher forms, is accomplished.

As far as possible the author has acknowledged in the text his indebtedness to various authorities for the matter or manner of his subject, though references to publications, as tending to confuse the student, have been omitted.

For illustrations the author is indebted to the liberality of the publisher, Mr. Davis, and to Messrs. Blakiston and H. C. Lea & Co., of Philadelphia; Appleton, Wm. Wood & Co., and Macmillan, of New York; Ferdinand Enke, Stuttgart; Engelmann and F. C. W. Vogel, Leipsic; Paul Parey, Berlin; W. Braumüller, Vienna; Carl Winter, Heidelberg; Hachette & Cie, Baillièrè & Fils, Asselin & Cie, Paris; Simpkin, Marshall & Co., London; Moritz Perles, Vienna, and Hirschwald, Berlin.

ROBERT MEADE SMITH.

# TABLE OF CONTENTS.

INTRODUCTION, . . . . .	PAGE I
-------------------------	-----------

## PART I.

### GENERAL PHYSIOLOGY.

#### THE PHYSIOLOGY OF ANIMAL CELLS.

##### SECTION I.

###### THE STRUCTURE OF ORGANIZED BODIES.

I. THE GENERAL PROPERTIES OF CELLS, . . . . .	12
II. THE ORIGIN OF CELLS, . . . . .	14
III. THE MODIFICATION IN THE FORM OF CELLS, . . . . .	26
IV. THE DEVELOPMENT OF TISSUES AND ORGANS, . . . . .	31

##### SECTION II.

###### CELLULAR PHYSICS.

I. THE PHYSICAL PROCESSES IN CELLS, . . . . .	37
1. Cohesion, 38 ; 2. Adhesion, 40 ; 3. Capillarity, 40 ; 4. Solution, 43 ; 5. Imbibition, 44 ; 6. Filtration, 48 ; 7. Diffusion of Liquids, 49 ; 8. Osmosis, 51 ; 9. Diffusion of Gases, 56 ; 10. Absorption of Gases, 58.	
II. THE PHYSICAL PROPERTIES OF THE TISSUES, . . . . .	61
1. Cohesion, 62 ; 2. Elasticity, 65 ; 3. Optical Characteristics, 68 ; 4. Electrical Phenomena, 70.	
III. MECHANICAL MOVEMENTS IN CELLS, . . . . .	70
1. Motion Produced by Imbibition in Cells, 70 ; 2. Protoplasmic Move- ments, 72 ; (1) Movements in Protoplasmic Contents of Cells, 73 ; (2) Ciliary Movement, 77 ; (3) Movement in Specialized Contractile Tissues, 81.	
GENERAL CONDITIONS GOVERNING PROTOPLASMIC MOVEMENT, . . . . .	82
1. Temperature, 82 ; 2. Degree of Imbibition, 82 ; 3. The Supply of Oxygen, 83 ; 4. Various Chemical and Physicel Agents, 84.	

## SECTION III.

## CELLULAR CHEMISTRY.

	PAGE
I.	
THE CHEMICAL CONSTITUENTS OF ORGANIZED BODIES, . . . .	85
A. NITROGENOUS ORGANIC CELL-CONSTITUENTS—PROTEIDS AND THEIR DERIVATIVES, . . . . .	88
Class I. Albumens, 92; (1) Serum-Albumen, 92; (2) Egg-Albumen, 93; (3) Vegetable Albumens, 93.	
Class II. Globulins, 96; (1) Vitellin, 97; (2) Myosin, 97; (3) Para- globulin, 97; (4) Fibrinogen, 97; (5) Globulin or Crystallin, 97.	
Class III. Fibrins, 98.	
Class IV. Derived Albuminates, 98; (1) Acid Albumen, 98; (2) Alkali Albumen, 101.	
Class V. Coagulated Proteids, 102.	
Class VI. Amyloid Substance or Lardacein, 102.	
Class VII. Peptones, 103.	
ALBUMINOIDS, . . . . .	104
1. Mucin, 104; 2. Collagenous Albuminoids, 105; ( <i>a</i> ) Collagen, 106; ( <i>b</i> ) Gelatin, 106; ( <i>c</i> ) Chondrogen, 107; ( <i>d</i> ) Chondrin, 107; 3. Elastin, 108; 4. Keratin, 109.	
DECOMPOSITION OF ALBUMINOUS BODIES, . . . . .	109
FERMENTS, . . . . .	110
B. NON-NITROGENOUS ORGANIC CELL-CONSTITUENTS, . . . . .	112
I. CARBOHYDRATES, . . . . .	112
( <i>a</i> ) Starches, 112; (1) Starch, 113; (2) Cellulose, 115; (3) Dextrin, 116; (4) Glycogen, 116; (5) Inulin, 116.	
( <i>b</i> ) Glucoses, 117; (1) Grape Sugar, 117; (2) Lævulose, 118; (3) Inosite, 118.	
( <i>c</i> ) Saccharoses, 119; (1) Cane-Sugar, 119; (2) Maltose, 120; (3) Lac- tose, 120; (4) Arabin, 120.	
II. HYDROCARBONS OR FATS, . . . . .	120
C. INORGANIC CELL-CONSTITUENTS, . . . . .	123
1. Water, 124; 2. Sodium Chloride, 128; 3. Potassium Chloride, 129; 4. Sodium and Potassium Carbonates, 129; 5. Calcium Carbonate, 130; 6. Magnesium Carbonate, 130; 7. Alkaline Phosphates, 130; 8. Calcium Phosphate, 133; 9. Magnesium Phosphate, 134; 10. Sodium and Potassium Sulphates, 135; 11. Hydrochloric Acid, 135.	
II.	
THE CHEMICAL PROCESSES IN CELLS, . . . . .	136
1. The Vegetable Cell, 137; 2. The Animal Cell, 142; 3. Fermenta- tions, 145; 4. The Consumption and Development of Force in Cells, 147.	

## PART II.

## SPECIAL PHYSIOLOGY.

## BOOK FIRST.

## THE NUTRITIVE FUNCTIONS.

## SECTION I.

## FOODS.

	PAGE
I. VEGETABLE FOODS, . . . . .	161
1. The Cereals, 163; 2. The Leguminous Plants, 173; 3. Bulbs and Roots, 174; 4. Grasses, 175.	
II. ANIMAL FOODS, . . . . .	188
1. Milk, 188; 2. Meat, 188.	
III. INORGANIC FOODS, . . . . .	191
1. Water, 191; 2. Nutritive Salts, 192.	
IV. THE DIET OF ANIMALS, . . . . .	193

## SECTION II.

## DIGESTION.

I. GENERAL CHARACTERISTICS OF THE DIGESTIVE APPARATUS, . . . . .	203
II. PREHENSION OF FOOD, . . . . .	226
1. Prehension of Solids, 226; 2. Prehension of Liquids, 236.	
III. MASTICATION, . . . . .	238
1. Movements of the Jaws, 241; 2. Action of the Teeth in Mastication, 245; 3. Determination of Age by the Teeth, 255; 4. Action of Tongue, Lips, and Cheeks, 264.	
IV. DIGESTION IN THE MOUTH, . . . . .	268
The Salivary Secretion, 268; 1. The Parotid Secretion, 274; 2. The Submaxillary Secretion, 279; 3. The Sublingual Secretion, 283; 4. General Characters of the Salivary Secretion, 284; 5. The Quantity of Saliva, 286; 6. The Physiological Rôle of the Saliva, 287; 7. The Mechanism of Salivary Secretion, 293.	
V. DEGLUTITION, . . . . .	307
VI. RUMINATION, . . . . .	316
VII. VOMITING, . . . . .	331

VIII. GASTRIC DIGESTION, . . . . .	337
1. Chemistry of the Gastric Juice, 342; ( <i>a</i> ) Pepsin, 346; ( <i>b</i> ) Milk-Curdling Ferment, 347; ( <i>c</i> ) The Acid of Gastric Juice, 349; 2. The Action of Gastric Juice on the Food, 351; 3. The Secretion of Gastric Juice, 356; 4. Gastric Digestion in Carnivora, 360; 5. Gastric Digestion in Omnivora, 363; 6. Gastric Digestion in Solipedes, 368; 7. Gastric Digestion in Ruminants, 374; 8. Gastric Digestion in Birds, 379.	
IX. DIGESTION IN THE SMALL INTESTINE, . . . . .	382
I. Bile, 382; 1. The Chemical Characteristics of the Bile, 383; ( <i>a</i> ) Mucin, 384; ( <i>b</i> ) The Bile Acids, 384; ( <i>c</i> ) The Coloring Matters of the Bile, 387; ( <i>d</i> ) Cholesterin, 389; ( <i>e</i> ) The Inorganic Constituents of the Bile, 390; 2. The Secretion of the Bile, 391; 3. The Physiological Action of the Bile, 393.	
II. The Pancreatic Secretion, 396; 1. The Chemical Composition of the Pancreatic Juice, 402; The Pancreatic Ferments, 404; 2. The Action of the Pancreatic Juice on Food-Things, 405; ( <i>a</i> ) Action on Carbohydrates, 406; ( <i>b</i> ) Action on Fats, 406; ( <i>c</i> ) Action on Proteids, 408; 3. The Secretion of Pancreatic Juice, 412.	
III. The Intestinal Juice, 416.	
IV. Fermentative Processes in the Small Intestine, 418.	
V. Intestinal Digestion in Different Animals, 419.	
X. DIGESTION IN THE LARGE INTESTINE, . . . . .	423
1. The Functions of the Cæcum, 423; 2. The Functions of the Colon, 429.	
XI. THE COMPARATIVE DIGESTIBILITY OF DIFFERENT FOOD-STUFFS,	432
XII. THE COMPOSITION OF FÆCES, . . . . .	445
XIII. THE MOVEMENTS OF THE INTESTINES,	448
XIV. DEFÆCATION, . . . . .	451
SECTION III.	
ABSORPTION, . . . . .	453
1. Venous Absorption, 453; 2. Absorption by the Lymphatics, 456:	
SECTION IV.	
THE CHYLE, . . . . .	459
SECTION V.	
THE LYMPH, . . . . .	463,



## SECTION VI.

PAGE

THE BLOOD, . . . . .	469
1. The Red Blood-Corpuscles, 471; 2. The White Blood-Corpuscles, 479; 3. Blood-Plasma and Blood Coagulation, 483; 4. The Blood-Serum, 489.	

## SECTION VII.

THE CIRCULATION OF THE BLOOD, . . . . .	491
1. General View of the Organs of Circulation, 491; 2. The Action of the Heart, 499; 3. The Hydraulic Principles of the Circulation, 516; 4. The Circulation in the Arteries, 523; Blood Pressure, 525; Velocity of the Blood, 530; The Pulse, 533; 5. The Circulation in the Capillaries, 536; 6. The Circulation in the Veins, 539; 7. The Influence of the Nervous System on the Heart, 540; The Inhibitory Nerves of the Heart, 549; The Accelerator Nerves of the Heart, 551; 8. The Influence of the Nervous System on the Arteries, 552.	

## SECTION VIII.

RESPIRATION, . . . . .	561
1. General View of the Organs of Respiration, 562; 2. The Mechanical Processes of Respiration, 574; 3. The Rhythm of Respiration, 579; 4. The Chemical Phenomena of Respiration, 587; 5. The Nervous Mechanism of Respiration, 598; 6. The Influence of Respiration on the Circulation, 605.	

## SECTION IX.

THE MAMMARY SECRETION, . . . . .	609
1. The Physical and Chemical Properties of Milk, 610; 2. Casein and Milk Coagulation, 614; 3. Milk-Sugar, 616; 4. Fat and Cream, 617; 5. The Inorganic Constituents of Milk, 619; 6. Variations in the Quantity and Composition of Milk, 619; 7. The Secretion of Milk, 624; 8. Milk Analysis and Inspection, 631.	

## SECTION X.

THE RENAL SECRETION, . . . . .	635
1. The Physical and Chemical Properties of Urine, 635; 2. The Mechanism of Renal Secretion, 640; 3. The Mechanism of Micriturition, 648.	

## SECTION XI.

THE CUTANEOUS FUNCTIONS, . . . . .	651
1. The Sweat Secretion, 652; 2. The Sebaceous Secretion of the Skin, 655; 3. Cutaneous Absorption, 656; 4. Cutaneous Respiration, 656; 5. The Lachrymal Secretion, 658.	

SECTION XII.		PAGE
NUTRITION, . . . . .		659
I. THE FATE OF THE ALBUMINOUS FOOD-CONSTITUENTS, . . . . .		660
II. THE FATE OF THE FATTY FOOD-CONSTITUENTS, . . . . .		664
III. THE FATE OF THE CARBOHYDRATE FOOD-CONSTITUENTS, . . . . .		666
IV. THE STATISTICS OF NUTRITION, . . . . .		672
1. Tissue Changes in Starvation, 674; 2. The Nutritive Processes in Feeding, 680; (a) Feeding with Meat, 680; (b) Feeding with Fat, 682; (c) Feeding with Carbohydrates, 683.		
V. THE FOOD REQUIRED BY THE HERBIVORA UNDER DIFFERENT CONDITIONS, . . . . .		684
VI. HUNGER AND THIRST, . . . . .		692
SECTION XIII.		
ANIMAL HEAT, . . . . .		693

## BOOK SECOND.

### THE ANIMAL FUNCTIONS.

#### SECTION I.

THE PHYSIOLOGY OF MOVEMENT, . . . . .	701
1. The Contractile Tissues, 701; (a) Chemical Composition of Muscle, 704; (b) Muscular Irritability, 709; (c) The Phenomena of Muscular Contraction, 710; (d) The Electrical Phenomena in Muscle, 721; 2. The Applications of Muscular Contractility, 722; 3. Animal Locomotion, 731; 4. The Gaits of the Horse, 739; (a) The Walk, 744; (b) The Amble, 746; (c) The Trot, 748; (d) The Gallop, 749; 5. Other Movements in the Horse, 750; (a) Rearing, 750; (b) Kicking, 753; (c) Lying Down and Rising Up, 754; (d) Walking Backward, 754; (e) Swimming, 755; 6. Special Muscular Mechanisms—The Voice, 757.	

#### SECTION II.

THE PHYSIOLOGY OF THE NERVOUS SYSTEM, . . . . .	765
I. THE CHEMICAL AND PHYSICAL CHARACTERISTICS OF NERVOUS TISSUES, . . . . .	774
II. NERVOUS IRRITABILITY, . . . . .	776
III. THE ELECTRICAL PHENOMENA IN NERVES, . . . . .	779
IV. GENERAL PHYSIOLOGY OF THE NERVE-CENTRES, . . . . .	781
1. Reflex Action, 782; 2. Automatism, 784; 3. Inhibition, 785; 4. Augmentation, 785; 5. Co-ordination, 785.	

	PAGE
V. THE FUNCTIONS OF THE SPINAL CORD, . . . . .	786
(a) The Spinal Cord as a Collection of Nerve-Centres, 789 ; (b) The Spinal Cord as an Organ of Conduction, 795.	
VI. THE FUNCTIONS OF THE BRAIN, . . . . .	803
1. The Medulla Oblongata, 810 ; 2. The Course of the Fibres of the Medulla Oblongata, 818 ; 3. The Pons Varolii, 821 ; 4. The Cerebral Peduncles, 821 ; 5. The Corpora Quadrigemina, 822 ; 6. The Functions of the Basal Ganglia, 822 ; 7. The Functions of the Cerebral Lobes, 823 ; 8. The Functions of the Cerebellum, 825.	
VII. THE CRANIAL NERVES, . . . . .	832
VIII. THE SYMPATHETIC NERVOUS SYSTEM, . . . . .	835
IX. GENERAL AND SPECIAL SENSIBILITY, . . . . .	837
A. THE SENSE OF SMELL, . . . . .	841
B. THE SENSE OF SIGHT, . . . . .	846
1. The Dioptric Mechanisms of the Eye, 851 ; 2. Visual Sensations, 864.	
C. THE SENSE OF HEARING, . . . . .	875
D. THE SENSE OF TASTE, . . . . .	893
E. THE SENSE OF TOUCH, . . . . .	897

---

### PART III.

THE REPRODUCTIVE FUNCTIONS, . . . . .	901
---------------------------------------	-----

#### SECTION I.

THE REPRODUCTIVE PROCESSES, . . . . .	903
1. The Reproductive Tissues of the Female, 908 ; 2. The Reproductive Tissues of the Male, 913.	



## INTRODUCTION.

---

PHYSIOLOGY treats of the functions or actions of living beings.

When these actions or functions occur in a disturbed or irregular manner, they constitute disease, or abnormal life, and become the subject of abnormal physiology or pathology. Normal physiology is the basis of pathology, and a knowledge of the one must precede the intelligent study of the other: just as an acquaintance with the functions of the component parts of a machine must precede the recognition of disordered movement and the provision of means of repair.

Since the functions of the animal body are resident in the various tissues and organs of the body, an acquaintance with the forms and structure of those organs and tissues must precede the study of their functions. The study of anatomy and histology, or microscopic anatomy, must therefore precede the study of physiology.

GENERAL PHYSIOLOGY treats of the functions of organized beings in an abstract manner,—that which regards the general laws of life, whether seen in the animal or vegetable world. Although for the purposes of practical life physiology is divided into several provinces, yet the knowledge of general physiology is essential even to special students, since the relation between the different forms of life is very close.

VEGETABLE PHYSIOLOGY is concerned solely with the consideration of the vital actions or functions of plants.

COMPARATIVE PHYSIOLOGY treats of the functions of animals below man, with a consideration of the means by which different functions are accomplished by different animal forms.

SPECIAL PHYSIOLOGY is confined to the consideration of the vital phenomena of a single species, single genus, or it may deal with the consideration of a special function. In this book special physiology will refer mainly to the study of the vital phenomena of the domestic animals.

HUMAN PHYSIOLOGY treats exclusively of the vital phenomena of man. But, while this branch of physiology is of greater importance to the physician than the other divisions, in consequence of its relations to human pathology and therapeutics, it should not be made the exclusive subject of study; for the physiology of man cannot be properly understood without a previous acquaintance with the vital phenomena of

the lower animals and plants. For the veterinary physician the study of life in the domestic animals must be of the greatest importance.

Every living body is organized,—that is, composed of instruments or organs each one of which is destined to fulfill some special office in the organism called its function, the sum of which functions constitute the life of the individual. Other bodies met with in nature, and not so constituted, are called unorganized, or inorganic, *e.g.*, the mineral.

**DISTINCTIONS BETWEEN ORGANIZED AND UNORGANIZED BODIES.**—Organized and unorganized bodies have few or no correlative points, but stand opposed to each other in almost every characteristic trait.

Unorganized matter is only subject to the forces whose generality of action constitutes physical and chemical laws. Organized matter is also controlled to a certain extent by the same laws, and, although there are a great many actions manifested by living bodies which are not readily explicable by the ordinary physical laws, and for which the term “vital phenomena” is conveniently employed, it does not by any means follow that we have here to deal with any entirely distinct series of laws. The attempt to reduce the so-called vital phenomena to physical and chemical laws has already succeeded in demonstrating the dependence, on physical and chemical principles, of many functions previously regarded as purely vital in nature, and the hope may be reasonably held for continued progress in this direction. The sciences of physics and chemistry are therefore the foundation-stones of modern physiology.

Nevertheless, organized and unorganized matter differ to such an extent that their consideration forms entirely distinct branches of study. The forms, the forces, and the laws of unorganized matter are the subjects embraced by physics and chemistry. The forms and forces of living organized matter are the objects of physiological science, or biology.

Organic bodies differ from inorganic—

1. *In their Origin.*—The former spring from a parent, or from previously-existing living matter, either by splitting, budding, seeds, or eggs. The latter have no such origin, but may arise from the combination, under the influence of chemical affinity, of the elements which compose them. Spontaneous generation, though claimed by some, has not been satisfactorily established.

2. *In their Form.*—Organized bodies are usually determinate in their form, rounded in their outline, and, in their simplest expression, either spherical or spheroidal in shape. Unorganized bodies, on the other hand, are irregular in their outline (amorphous), or, if determinate in form, are bounded by plane surfaces and straight lines.

3. *Duration of Existence.*—Organized bodies have a definite time to live, pass through distinct stages of development and growth, and ulti-

mately die. But the inorganic body may continue to exist until some disrupting force separates the inorganic elements of which it is composed, and enables them to form new combinations; but so long as uninfluenced by such an agency it may remain unchanged for an indefinite period.

4. *Size*.—Organized bodies have a definite limit to which they may attain, varying, however, among individuals of the same species. And when they exceed the average size of the species it is not by the increased size of the individual, but by the continued production of new individuals or a repletion of parts already existing. The unorganized body, on the other hand, is as indeterminate in size as in duration, continuing to grow so long as fresh particles are brought together.

5. *Chemical Constitution*.—Of the sixty-five simple elements found in nature but about twenty enter into the composition of organized bodies, and of these but four are to be regarded as essential, viz., C.O.H.N., of which at least two are found in every organic compound. The remaining elements are called incidental. Unorganized bodies may be simple in their composition, or binary, ternary, quaternary, or higher; but binary is the most usual combination.

The molecular constitution of the organic body is also different from the inorganic in being much more complex, both in the number of elements which it contains and the number of atoms, or combining equivalents of those atoms, which exist in a combining equivalent of the compound. Thus, albumen, which forms an important constituent of nearly all organized bodies, may be represented as  $C_{240}H_{392}N_{65}O_{75}S_3$  (Schützenberger), while ammonium carbonate, an inorganic compound containing the same elements, with the exception of sulphur, may be written as follows:  $(NH_4)_2CO_3 + H_2O$ .

From the large number of elements which enter into the composition of organic bodies, and the large number of atoms constituting an organic molecule, arises the great tendency to decomposition by which they are characterized; for, “the greater the number of atoms of an element which enters into the formation of a molecule of a compound, the less is the stability of that compound.”

Inorganic compounds are therefore stable; organic bodies, unstable.

It was formerly supposed that organic compounds could only be formed under the influence of vitality, and that they could be decomposed by the chemist, but not recomposed. But this has been shown to be an error, some of the organic acids, alcohols, organic coloring matters, and some of the secondary organic components, such as uric acid and urea, having been synthetically prepared by the chemist. It is thought, therefore, not to be impossible that some of the higher organic compounds, such as albumen, may ultimately be also made in the same

manner, though thus far all attempts in this direction have been unavailing. All those compounds which have as yet been made by synthesis are allied to those which result from a long-continued series of chemical changes in the organism, produced by the action of oxygen upon products of disintegration.

6. *In their Mode of Growth.*—Organized bodies grow by assimilation,—the internal deposit of materials by which the unlike become the like. Unorganized bodies grow, or increase in size, by external deposit or accretion. The organized body is dying from the moment of its birth, and requires new materials to repair those losses and for the increase in size. The unorganized body, as the crystal or the stalactite, continues to increase in size so long as fresh particles are deposited upon it. Every part of an inorganic body is therefore alike and independent of the rest, and exhibits the same properties as the whole. The organized body, on the contrary, is made up of a number of dissimilar parts, each of which is more or less dependent upon the others, and each of which requires different materials for its growth and reparation. In the unorganized body a small portion serves to determine by analysis the constitution of the whole; in other words, it is homogeneous. In the organized body each part is more or less dependent on the remainder, and differs from it in chemical composition; in other words, it is heterogeneous. Organic compounds, moreover, from the large quantity of fluid they contain, are usually soft and ductile, while the inorganic body is hard, rigid, and inflexible, and when once the affinities of its chemical elements are satisfied it remains an inert mass. Within the organized living body all is change. Death and repair are ever taking place. From the commencement of its existence its growth, its progress toward maturity, its decline, decay, and death are all made up of an incessant series of changes. It is the constant round of these actions which constitutes life; their study is the subject of physiology.

It is thus seen that organized are distinguished from unorganized bodies by three cardinal characteristics: 1. *The law of nutrition*, the most fundamental of all vital laws; since in virtue of it the organism continues to exist as an active being, and increases from infancy to maturity. 2. *The law of development*, or differentiation, which causes the organism to pass through the definite cycles of change constituting what we call ages, and leading inevitably to the final changes which we call death. 3. *The law of reproduction*, another aspect of the first law, in virtue of which the organism gives origin to similar organisms from one generation to another.

In no example of inorganic matter can any of these characteristics be found. When inorganic bodies are said to grow, their growth is a process of mere aggregation, one part adhering to another similar part.



The growth arises from no internal necessity, as in organic bodies. The bulk is not increased by a process of assimilation which converts the unlike into the like. Minerals do not feed; they cohere. Nor have they any power of development. They pass through no definite cycles of change; they have no stages of growth, no ages, no power of reproduction.

The constant round of actions, therefore, in the organized structure called life, in them is wanting. They occupy space, but have neither birth nor death.

**DISTINCTION BETWEEN PLANTS AND ANIMALS.**—Organized bodies are divided into two classes,—animals and vegetables,—constituting two separate kingdoms, which, though capable of ready recognition when studied in their higher members, seem almost to overlap in their lowest expression. Hence, while the differences between the higher animals and higher plants are so striking as not to need mention, when we examine the lowest forms of life the greatest difficulty will sometimes be met with in the attempt to decide whether the organism is an animal or a vegetable. For when the protozoa, or lowest animals, are compared with the protophyta, or lowest plants, all the differences which are so striking between the higher animals and plants are completely wanting; yet the protozoa are as truly animal as are the vertebrata, and the protophyta just as surely plants. Consequently the definition of an animal or a plant, to be of any scientific value, must include the lowest as well as the highest forms.

We found, in our comparison of organic and inorganic matter, that differences in form could be clearly made out. The external characteristics of plants and animals are, however, inadequate to distinguish them. Many animal forms, such as the hydrozoa, are essentially plant-like in their external form, growing from fixed points and even reproducing themselves by “budding,”—a process almost universally holding in the vegetable kingdom. So also the well-known coral polyps and the sponge closely resemble plants in external configuration, and, though undoubtedly animals, were long placed by naturalists in the vegetable kingdom.

Then, on the other hand, many plants, examined in respect to their external form alone, would often be confounded with animals. Thus, the germs of many algæ, the ciliated zoospores, are scarcely to be distinguished from infusorial animaleules.

It was at one time thought that the power of motion was a proof of animality; but many of the lowest plants, such as volvox and the diatoms, possess the power of motion, of changing their location, the instruments being the same as in many animals, viz., cilia. Nor is the power of moving in response to an irritant peculiar to animal life: witness the *Mimosa pudica*, the sensitive plant, which closes its leaflets

on irritation; the *Dionæa muscipula*, the Venus' Fly-Trap, the extremities of whose leaves have the power of closing on insects or other bodies brought into contact with them. Plants are also possessed of internal motion: witness the circulation of the sap and the circulatory motions in the interior of many vegetable cells. They also turn spontaneously to the light and extend their rootlets to the most nutritive soil.

Again, all animals are not possessed of the power of motion. Sponges, coral polyps, hydroid zoophytes, sea-mats, etc., are entirely destitute of locomotive power, and spend their entire existence rooted fast to some immovable object. Hence, the possession of motor power is not characteristic of animal life, and its absence does not prove the organism to be a vegetable.

Chemical analysis helps us but little more in the attempt to distinguish animals from vegetables. Carbon and nitrogen compounds form a large proportion of the constituents of each, and a large number of complex combinations found in animal tissues are represented by entirely similar compounds in vegetable matter. There is therefore no one chemical compound whose presence is characteristic of animality or vegetable nature; for "cellulose," the substance out of which wood-fibre and the walls of plant-cells are formed, has been ascertained to form the greater part of the external coverings of certain molluscous animals (*ascidians*). So also chlorophyll, the green coloring matter of plants, is the cause of the green color of many infusorial animalcules and of *Hydra viridis*, while starch has been found in the ventricles of the brain of animals, and is represented by glycogen, a body closely analogous to starch and manufactured by the animal economy. Such examples, therefore, show that chemical examination can give us no definite aid in separating plants and animals.

The microscope is also powerless to give us an infallible rule which will enable us to distinguish animal from vegetable tissue. In other words, plants and animals are built up on the same general plan; their intimate structure closely coincides. Both originate in cells, consisting, in their typical form, of a cell-wall, cell-contents, or protoplasm,—nucleus and nucleolus,—and in both the parent cell undergoes subdivision and results in the birth, growth, and development of myriads of other cells, constituting the tissue of the plant or animal, and differing no more from each other than almost any mature animal or vegetable cell does from the germ from which it originated.

Nor is the possession of a digestive cavity, mouth, or alimentary tube characteristic of animals; for there are vegetables which possess a stomach, as the *Nepenthes*, or Pitcher-Plant, which has a cavity corresponding to a stomach, in which digestive fluids are poured out, and in which digestion and absorption take place. On the other hand, many

animals among the protozoa, such as the amœba, have no stomach, the general surface serving not only for the purpose of digestion, but also for absorption, an extemporaneous stomach being formed by wrapping a part of the external general body surface around the substance to be digested.

So also in the tape-worms and other parasitic forms of animal life, there is an entire absence of any special aperture for the entrance of nutritive matter, such organisms living by the simple imbibition of nutritive matter in solution.

When, however, we examine into the nature and mode of assimilation of food, the nutritive processes occurring in the interior of the organism, and the results of the conversion and assimilation of food, then only have we any reliable scientific data for distinguishing animals from plants. In the first place, the food of animals differs from that of plants in its nature. Animals require organic food; plants live on inorganic or mineral matter. The nutritive processes in the two kingdoms are also diametrically opposed: the plant absorbs water, ammonia, carbon dioxide and certain salts, and out of these manufactures the albuminoids, carbohydrates and hydrocarbons found in vegetable tissue. The animal feeds on these complex vegetable compounds,—and this holds whether the animal be herbivorous or carnivorous,—and returns to the soil and atmosphere the inorganic matter from which they were manufactured by the plant; and in the same form, *i.e.*, carbon dioxide, water, ammonia, and certain salts. The plant therefore converts simple inorganic compounds into complex organic compounds, while the animal reduces complex organic matter to its simple inorganic constituents.

A further point of distinction between animals and vegetables, and one closely connected with the nutritive processes, is their behavior to the atmosphere. The animal requires for the processes of reduction already mentioned as constituting its mode of nutrition a constant supply of oxygen, which is withdrawn from the atmosphere and returned to it in the form of  $\text{CO}_2$ , representing one of the end products of oxidation of the carbon of its tissues and food. Plants, on the other hand, absorb  $\text{CO}_2$ , and under the influence of sunlight, by the action of their chlorophyll, break up this  $\text{CO}_2$ , fix the carbon in their tissues, and set free oxygen into the air. The plant thus absorbs what the animal excretes, and the animal absorbs what the plant excretes. We thus see that animals and plants offer striking points of contrast as to the character of their food and the nature of their nutritive processes, and, although there are several apparent exceptions to the general outline here given, their consideration may be deferred to the chapters on the Chemical Processes in Cells.

We have found now that all objects in nature must be either organic

or inorganic, and we have considered the means by which these bodies may be separated: we, therefore, here leave the inorganic world (the domain of physics, chemistry, mineralogy, etc.), to confine our studies to the animal kingdom. But here, from the fact that there was great difficulty in separating the lower forms of animal from vegetable life, it must be recognized that animals and plants possess many vital functions in common; and as the simplest expression of these functions must be in the simplest organisms, the study of those functions may best commence in the simple, uncellular organisms, whether animal or vegetable. General physiology will thus deal with the Animal Cell: its form, origin, modifications, constitution, and the various chemical and physical processes concerned in its nutrition, growth, development and reproduction.

It will, then, be shown that the higher animals are mere associations of such simple organisms, in which the modification in the characters of the various constituent cells leads to a division of labor. In other words, development of tissues leads to a specialization of function, and Special Physiology will deal with the study of the development of function, especially as seen in our domestic animals. The functions of animals are divided into the Vegetative Functions, the Animal Functions,—or the functions of relation,—and the Reproductive Functions.

The Vegetative Functions include everything which relates to the nutrition of the animal in its widest sense. As the blood in higher animals is the organ of nutrition, under this head are included (1st) the additions to the blood,—therefore, the description and modes of prehension of Food; Digestion, or the preparation of food for absorption; and Absorption, or the means by which nutritive and other matters enter the blood. The Blood will, then, be considered as a tissue of nutrition or as a carrier to and from the various organs of the body by means of its Circulation. As a boundary between the additions and (2d) the losses to the blood Respiration will demand attention, while under the latter head come the functions of Secretion and Excretion. The means by which the identity of the individual is preserved concludes the subject of Nutrition and deals with the nutritive value of different foods and their combinations, the adaptment of foods to the different demands on the animal economy, and the subject of Animal Heat. The Animal Functions, or those by which the body is brought into relation with the external world by means of sensation, power of movement, consciousness, and volition, include the study of the Muscular and Nervous Systems, while finally the Reproductive Functions lead to the preservation of the species, and include the subjects of Generation and Development, or Embryology.

# PART I.

---

## GENERAL PHYSIOLOGY.

---

THE PHYSIOLOGY OF ANIMAL CELLS.

Dr. H. P. Ryder.  
Chicago,  
Ill.

## SECTION I.

### THE STRUCTURE OF ORGANIZED BODIES.

CHEMICAL ANALYSIS has shown that all organized bodies are capable of resolution into simple chemical elements which in themselves do not differ from the elements out of which all matter is composed: in other words, that the simple elements of which organized bodies are built up are universally distributed throughout nature, and that no one element is peculiar to organized matter. The characteristic of organized bodies is, therefore, not to be found in any peculiarity of the matter of which they are composed, but in the manner in which the atoms composing that matter are grouped. In an inorganic body we are accustomed to attribute its chemical properties to the nature, number, and mode of association of its constituent elements, while its physical properties are attributable to the mode of arrangement of its molecules.

Analysis of organized bodies shows that in them we have certain elements constantly present in certain definite proportions: it is therefore warrantable to assume that the chemical properties of organized bodies are, as in the case of inorganic matter, due to the number, nature, and mode of association of their elements. Further, we find in all organized living bodies a certain identity of physical properties: it is therefore warrantable to assume that the physical processes seen in organized bodies are dependent on the mode of arrangement of their constituent molecules. The elements constantly associated in living matter are carbon, nitrogen, oxygen, hydrogen, and sulphur, forming a complex combination, to which the term *protoplasm* has been applied. This matter, protoplasm, whether found in the tissues of the highest animals or plants, or in the lowest unicellular members of either kingdom, has always the same composition and is always possessed of nearly the same attributes; with the restriction that we have already referred to as to the difference in functions possessed by animals and plants,—differences which will probably in the future be cleared up, and found not to be in contradiction to the statement that protoplasm is the universal basis of organization.

All organized bodies are built up of associations of masses of protoplasm, which from their appearance are termed *cells*, or, from the functions which they fulfill, *elementary organisms*: and as the physical properties of inorganic matter are dependent on the arrangement of

their molecules, so the physiological peculiarities of organized bodies are dependent on their cellular structure.

Physiology is therefore the study of the properties of cells. Cells possess the properties of Nutrition, Reproduction, Growth, Development, and in many cases their contents are capable of Motion and manifesting Irritability.

### I. THE GENERAL PROPERTIES OF CELLS.

Microscopic examination teaches that every living object, from man down to the smallest animalcule invisible to the naked eye,—from the largest tree down to the most microscopic plant,—is built up on the same general plan. In each the same element of organization is found, and every living form is built up of associations of these microscopic units, each of which, even in the most complex forms of life, may be regarded as separate individual organisms.\*

For even in complex organisms cells to a certain extent carry on a separate and independent existence. We see

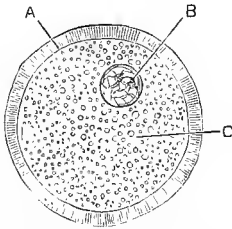

FIG. 1.—TYPICAL ANIMAL CELL. RIPE OVUM OF CAT. (Klein.)

A, Zona pellucida; B, germinal vesicle; C, protoplasm.

separate cells originate separately, grow, reproduce themselves, become diseased and die without the entire organism as a whole taking any part in these different stages of existence of its component parts. The individual life of each separate cell is recognized in the different activities of different cells: the activity of the organism is the result of the sum of these separate existences.

In their typical form both animal and vegetable cells consist of closed vesicles, with homogenous or striated walls, a viscid albuminous contents, termed *protoplasm*, containing an aggregation of granules called a *nucleus*, within which again is a still denser formation called a *nucleolus*. The cell-contents is frequently vacuolated, *i.e.*, contains minute cavities filled with a clear fluid.

The *contents* of the cells, which we shall find to be functionally the most important, is called protoplasm. It is a transparent mass in which numerous granules are suspended, and which possesses in all young cells the property of contractility. It is often seen to be reticulated. In older cells the quantity of fluid diminishes and the cells become firmer and drier, while vacuoles often form and contain fluid. This change in the physical properties of cells is often associated with a visible change in their chemical nature,—thus, with a deposit of coloring matter, starch

\* Such units of organization are termed *cells*, from the resemblance which microscopic sections of young tissues, whether plant or animal, bear to a honey-comb.



granules, fat globules, or granular matter. All substances which coagulate proteids have the same effect on protoplasm. The vital properties of protoplasm will be studied later.

A *membrane* is usually present in all mature cells, though always absent in embryonic forms. It may therefore be assumed that the membrane results from a condensation of the outer layers of the cell-contents. The membrane is apparently homogeneous, or may be porous.

The *nucleus*, the size of which is generally in proportion to that of the cell, and which is usually oval or spherical, is never absent in early forms of active cells, though it may disappear when the cell reaches maturity. In its mature stage it is generally reticulated,—that is, composed of an investing cuticle within which the contents are arranged in the form of a fibrillar net-work. The presence of a nucleus, which is often difficult of recognition on account of its minute size, may be demonstrated through the action of certain reagents, especially dilute acids and staining fluids. Dilute acids render the protoplasm of cells transparent without affecting the nucleus, which consequently becomes more prominent; while staining fluids, such as carmine, hæmatoxylin, and the anilin dyes, color the nucleus deeper in tint than the cell-contents. The nucleus appears to be especially important in the reproductive functions of cells, since when cells multiply by division the division always commences in the nucleus.

The *nucleolus* is simply a closer aggregation of the granules which constitute the nucleus, and is very frequently absent.

Both cell-wall and nucleus may be absent from the lowest elementary organisms.

As our conception of the structure of the higher animals and plants is an association of elementary organisms invariably taking origin from a single cell, our definition of such a simple organism or cell must be modified so as to apply to the description of the simplest conceivable organism capable of carrying on an independent existence. And as we have seen that of the constituents of a typical cell but one, the cell-contents, or protoplasm, is essential; and as we know that there are organisms capable of carrying on an independent existence in whom neither cell-wall, nucleus, or nucleolus is to be detected, a cell may be defined as a more or less homogeneous mass of organized material,—protoplasm,—possessing development, growth, reproduction, nutrition, and automatism.

The best known of such undifferentiated forms of cell life is the *amœba*,—one of the simplest examples of an animal organism.

In its lowest form the *amœba* (*Protamœba primitiva*, Haeckel) consists of a mass of jelly-like, structureless, albuminoid substance (protoplasm), which, so far as its chemical composition and general attributes

are concerned, cannot be distinguished from the contents of all active forms of cells (Fig. 2).

The amœba is capable of spontaneous motion, both as regards change of external form and of progressing from place to place. Motions may also be evoked by various stimuli; hence, free protoplasm, in common with muscular fibre and ciliated organisms, is *contractile*. The peculiarity of protoplasmic motion, as seen in the amœba, is that motion does not occur around a fixed point, but rather is a flowing motion, such as might occur in the particles of a fluid. Thus, in an amœba the changes in form and location are effected through the thrusting out of lobe-like prolongations of the periphery (pseudopodia), and their subsequent withdrawal or the flowing into these extensions of the remainder of the body.

Occasionally one or more of these pseudopodia become gradually more and more constricted, until, finally, a portion becomes entirely separated from the original mass, increases in size, and itself possesses all the properties of the parent stock; hence, protoplasm is *reproductive*, and possesses the power of *growth*. Moreover, the movements of an amœba are not necessarily the consequences of external stimuli, but may be self-originating; hence, protoplasm is also *automatic*.

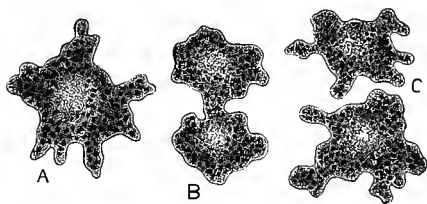

FIG. 2.—A NON-NUCLEATED CELL, THE PROT-AMŒBA PRIMITIVA, AFTER HÆCKEL. (*Wundt*.)  
A, original condition; B, commencement of reproduction by fission;  
C, after complete separation.

If watched for some time, an amœba will often be seen to take into its interior, by flowing around them, small vegetable organisms, of which portions are dissolved and converted into the substance of its body, while the undigested remainder is extruded; therefore, protoplasm, even in the absence of all digestive organs, possesses the power of *nutrition*.

The amœba requires for its existence an atmosphere of oxygen, which is absorbed, and which it again partly exhales as carbon dioxide. Protoplasm is therefore *respiratory*.

## II. ORIGIN OF CELLS.

We have seen that in the amœba a simple mass of undifferentiated protoplasm possesses the powers of reproduction, contractility, respiration, irritability, nutrition, and automatism. Every form of life commences its existence in the form of just such a simple mass of protoplasm. Starting with the ovum, and ending with the nucleated elements found in the organs and tissues of the embryo and adult, there is one

uninterrupted series of generations of cells, each cell becoming so modified as to specialize certain functions which are together possessed by all forms of undifferentiated protoplasm. Thus, in the higher forms certain cells will be found to have become so modified as to have the function of reproduction especially developed; they will therefore constitute the reproductive tissues. In other cells the nutritive functions will become most prominent; they will therefore form part of the tissues whose function is to preserve the nutritive balance of the organism. Specialization of function is therefore the explanation of the development of tissues; the result is a physiological division of labor. We will have to return to this subject again.

The germ of every animal and vegetable organism is a *cell* which owes its existence to some similar, previously-existing cell. Neglecting the origin and development of cells in the vegetable kingdom, every cell which forms part of the organs or tissues of all forms of animal life originated in and developed from a germ-cell or ovum.

The ovum of man and other mammals is a minute mass of protoplasm, corresponding in its general appearance with the description of a typical cell. The protoplasm, or cell-contents, is surrounded by a delicate, striated membrane, the *Zona radiata*, or *vitelline membrane*. Within the cell-contents, in addition to numerous minute particles,—the so-called yelk-globules,—is a collection of denser particles of protoplasm,—the nucleus, or *germinal vesicle*, and within that, again, one or more still more solid masses,—the nucleoli, or *germinal spots*.

The cell-contents is identical in nature and properties with the substance of the amœba, and before and immediately after fertilization may even be the seat of spontaneous movements of contraction and expansion. When mature, its diameter in the domestic animals and man varies from the  $\frac{1}{200}$  to the  $\frac{1}{120}$  of an inch (0.18–0.2 mm.).

Fertilization leads to a cleavage of the protoplasm into two parts, the nucleus being first divided, so that two new elements originate from the ovum, each consisting of protoplasm and each containing a nucleus. Each of the two new cells thus formed again subdivide into four, these into eight, and so on through many generations, until a large number of new cells, the so-called “mulberry mass,” results from the subdivision of the original parent cell.

According to Schleiden and Schwann, the founders of the cell doctrine, organic forms of life may originate in one of two ways,—either by the aggregation of granules in a previously-existing homogeneous fluid

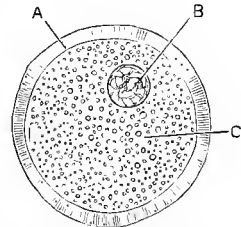

FIG. 3.—TYPICAL ANIMAL CELL. RIPE OVUM OF CAT. (Klein.)

A, Zona pellucida; B, germinal vesicle; C, protoplasm.

(the blastema), forming the so-called "free cell-formation," or by the subdivision of a previously-existing cell,—the "endogenous cell-formation."

According to the first of these views, which may be compared to the formation of crystals in a saline solution, granules first develop in a fluid which contains all the chemical constituents of the organism, forming the nucleolus of the future cell. Around this other granules are gradually deposited until the nucleus is formed, and the cell-contents and membrane gradually consolidate around this. The first objection to this theory, which, it is seen, implies spontaneous generation, lies in the fact that no one has ever been able to demonstrate such a cell-formation or to discover the so-called cytoblasts. It was then shown that all the cells of the embryo originate in the segmentation

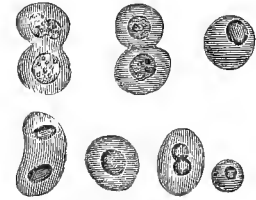

FIG. 4.—BLOOD-CORPUSCLES IN DIFFERENT STAGES OF DEVELOPMENT, SHOWING REPRODUCTION BY FISSION. (Ranke.)

spheres of the ovum, and the falsity of this doctrine of free cell-formation is further proved from analogy by the manner in which the connective-tissue cells take part in the development of pathological new formations. There is now no more firmly-established dictum in physiology than the statement that every cell originates from a previously-existing cell. (*Omnis cellula e cellula.*)

The other view, which was also to a certain extent advocated by Schwann, as to the origin of cells by subdivision of a parent cell, is exemplified in the mode of reproduction of many of the lower forms of life. Cells may reproduce themselves by simple division of the parent cell or by endogenous division.

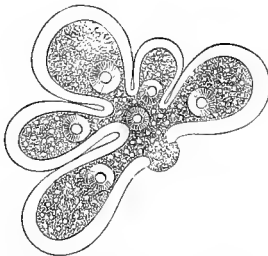

FIG. 5.—GEMMATION. A BUD-DING GERM-CELL OF GORDIUS, AFTER MEISSNER. (Wundt.)

Cell reproduction always starts in the nucleus. In simple division the nucleus first becomes marked with a furrow, which gradually deepens until the nucleus is divided into two. The protoplasm of the cells is then modified in the same way, until two new cells are formed by the division of the parent cell. This process may be followed in the reproduction of the nucleated red blood-corpuscles of the embryo of the chick and even in mammals (Fig. 4). A modification of this form of cell reproduction is sometimes described as "budding." This process also starts with the nucleus. A number of nuclei are first formed by the subdivision of the nucleus; these gradually separate; the protoplasm

collects around them so as to form projections from the periphery of the cell, which become more and more constricted until they finally separate (Fig. 5). During division the nuclear membrane disappears, and the nucleus usually divides before the cell-protoplasm, but not directly, by simple cleavage, as was formerly supposed, but indirectly, by *karyokinesis* (from movement of nuclear fibrils). This is an exceedingly complicated process. Its different stages may be divided about as follows:—

1. The nuclear fibrils become very distinct, while the nuclear membrane disappears and the fibrils of the nuclear net-work become twisted and bent into a more or less dense convolution, while the entire nucleus enlarges.

2. The fibrils unravel into loops arranged around the centre as a wreath or rosette.

3. The peripheral points of the loops become broken and a star-shaped figure of single loops is obtained. This is termed the *aster*, or star.

4. The loops separate into two groups or new centres. This is the *diaster*, or double star.

5. The two groups of threads become farther apart, as if attracted by opposite poles, but still remain connected by fine pole-threads, which represent the interstitial nuclear substance. In this stage the figure resembles a spindle.

6. The connection between the two sets of threads is broken.

7. The threads of each set become convoluted.

8. A membrane forms for each set, and thus new daughter nuclei result. (See Fig. 6.)

The cell-protoplasm may commence to divide at any stage between the one when the threads aggregate around the two centres and the one when two distinct nuclei are present; or the division of the nucleus may be followed by division of the cell, so giving a cell with two nuclei. It is not proved that this is the universal mode of divisions of nuclei, though it has been observed in all kinds of cells in the embryo, and to a limited degree in the adult. On the contrary, it is probable that amoeboid cells divide by the direct method and that other nuclei may also undergo direct division, or Remak's division, by simple cleavage, though all the cases in which constriction of nuclei is observed need not be cases of commencing division, as the change in shape may be due to pressure of cell-protoplasm, or to nuclear contractions. (Klein).

The second form of cell-formation is termed by Kölliker "endogenous cell-formation," and consists in the formation of cells within the membrane of the parent cell, which ultimately bursts and discharges its progeny of young cells. The division of the mammalian ovum, the growth of cartilage, and many pathological cell-formations are types of

this mode of cell reproduction. The latter example furnishes many instances in which a number of cells with entirely different attributes from the parent cell develop in the interior of a cell, such as the develop-

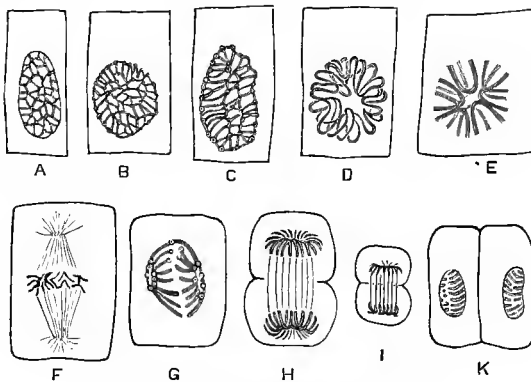

FIG. 6.—KARYOKINESIS. (*Klein.*)

A, ordinary nucleus of a columnar epithelial cell; B, C, the same nucleus in the stage of convolution; D, the wreath, or rosetta form; E, the aster, or single star; F, a nuclear spindle from the Descemet's endothelium of the frog's cornea; G, H, I, the diaster; K, two daughter nuclei.

ment of pus-corpules in the interior of different tissue-cells in inflammation (Fig. 7).

The best object for the study of cell reproduction by division, and the one of most interest for us, is found in the fertilized ovum of mammals.

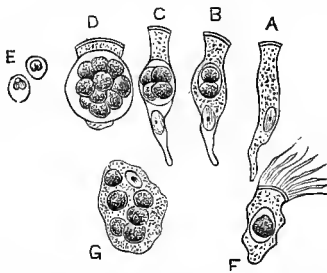

FIG. 7.—THE FORMATION OF PUS-CORPUSCLES IN THE INTERIOR OF EPITHELIAL CELLS, SHOWING ENDOGENOUS CELL-FORMATION. (*Ranke.*)

A, single cylindrical cell from the human bile-duct; B, a similar cell containing two, C containing four, and D numerous pus-cells; E, isolated pus-corpules; F, a ciliated epithelial cell from the human respiratory tract, containing a single pus-corpule; and G, a pavement epithelial cell from the urinary bladder of man, containing numerous pus-corpules.

As the ovum approaches maturity, even before impregnation takes place, the germinal vesicle becomes obscure and more and more irregular in outline, its membrane and reticulum disappear, and the germinal spot is broken up. What remains of the germinal vesicle becomes converted into a striated, spindle-shaped body, which moves to the surface of the ovum, to there undergo division into two parts. One part becomes extruded from the ovum to form what

is known to embryologists as the polar cell, and is soon followed by a second similar cell, while the portion of the spindle remaining within the ovum forms a new nucleus, the female pronucleus, from which, in conjunction with the male elements, the future embryo is developed.

In the unimpregnated ovule spontaneous contractions are generally seen in the protoplasmic cell-contents. When the egg becomes fertilized these contractions become so modified as to cause the germinal vesicle (or the body resulting from the union of the male and female pronuclei), and then the cell-contents to split into two parts contained within the cell-membrane, which takes no part in this division. These segmentation spheres, as already mentioned, continue to subdivide until an immense number of minute, nucleated, membraneless cells are contained within the vitelline membrane (forming the so-called mulberry mass).

From these elements, which become progressively smaller as cleavage goes on, all the tissues of the embryo are formed. At first they all possess mobility (amoeboid movements), showing their analogy to the simple amoeba, but at birth this property is only retained by certain cells. Like amoebae, they also grow in size and divide into new individuals.

At first all the cells resulting from the segmentation of the ovum are exactly alike: they then undergo certain modifications in arrange-

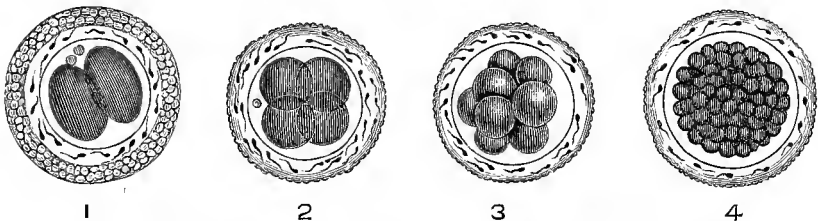

FIG. 8.—OVA OF THE DOG FROM THE FALLOPIAN TUBE, SURROUNDED BY THE ZONA PELLUCIDA, IN WHICH ARE FOUND NUMEROUS SPERMATOZOA, AFTER BISCHOFF. (Ranke.)

1, ovum with two segmentation spheres, the Zona pellucida being surrounded by the Membrana granulosa; 2, ovum with four segmentation spheres; 3, ovum with eight segmentation spheres; 4, ovum with innumerable segmentation spheres, forming the mulberry mass.

ment and form, different in different classes of animals, from which the different tissues of the embryo are developed.

The ova of animals are divided into two classes,—those in which the entire yolk is concerned in the production of the embryo, and those in which a part only serves for this purpose,—while the remainder of the cell-contents is drawn upon for the nutritive needs of the embryo. The first of these which undergoes total segmentation is termed a *holoblastic egg*; the second undergoes only partial segmentation, and is termed a *meroblastic egg*. The ovum of mammals serves for a type of the former class; the ovum of birds is typical of the second class. As already mentioned, the mammalian ovum represents a typical cell; the ovum of the bird differs in many points. Beneath the yolk-membrane is a layer of minute flattened cells, which gradually disappear during the maturing of the egg; while the yolk consists of two parts, one serving for the development of the embryo, the other for its nutrition. The part from

which the embryo is formed is a small, white disk lying directly beneath the vitelline membrane and termed the *tread*, the *blastoderm* or *cicatricula*. In the hen's egg this disk is about four millimeters in diameter, and is always found in the upper surface of the yolk. If a hen's egg is hardened by boiling, and then cut in two by a vertical section so as to bisect the yolk, the latter will be found not to be perfectly homogeneous. The yolk is clothed externally by a thin layer of different material, which at the edge of the blastoderm passes beneath it and becomes thicker so as to form a bed on which the blastoderm rests, to become connected by a narrow neck with a mass of similar matter occupying the centre of the

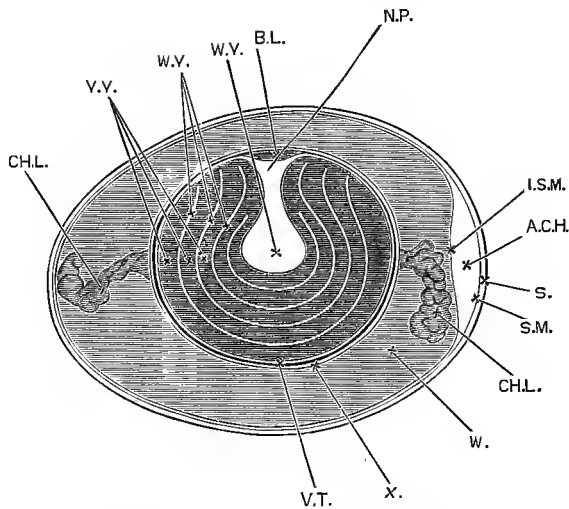

FIG. 9.—DIAGRAMMATIC SECTION OF AN UNINCUBATED FOWL'S EGG, AFTER ALLEN THOMPSON. (*Foster and Balfour.*)

BL, blastoderm; WY, white yolk—this consists of a central, flask-shaped mass and a number of layers arranged concentrically around this; YY, yellow yolk; VT, vitelline membrane; X, layer of more fluid albumen immediately surrounding the yolk; W, albumen, consisting of alternate denser and more fluid layers; CHL, chalazæ; ACH, air-chamber at the broad end of the egg—this chamber is merely a space left between the two layers of the shell-membrane; ISM, internal layer of shell-membrane; SM, external layer of shell-membrane; S, shell; NP, nucleus of Pander.

yolk, which nearly always remains partially fluid in the hard-boiled egg. Within the yolk again are several concentric layers of this white yolk, separated from each other by layers of yellow yolk. The yellow yolk is composed of comparatively large, unnuceated cells filled with highly refractive granules, and containing vitellin, lecithin, and various fatty bodies. The cells which form the white yolk are much smaller, are nuceated, and often a large cell will be seen to contain unnumerous similar but smaller cells.

When the egg is laid by the hen it has already undergone changes which result from fertilization. We will first describe the characters of



the blastoderm when the egg is first laid, and then the changes which have preceded it.

The blastoderm of an unincubated fertilized egg may be recognized by the naked eye, when viewed from above, to consist of two parts: an opaque, white circumference, the *area opaca*, and a central transparent portion, the *area pellucida*. In the unfertilized egg these divisions are not marked. They are due simply to the way the blastoderm, which is itself entirely transparent, rests on the white yolk. The opaque, circular ring is where the blastoderm is directly in contact with the white yolk, while the central clear portion is due to the fact that the blastoderm is separated from the yolk by a layer of liquid. The white spot often seen in the centre of the blastoderm is the central column of white yolk shining through the transparent membrane (*Nucleus of Pander*).

When the blastoderm is hardened and cut into vertical sections, it is found to be composed of two layers of cells: the upper, small, nucleated, cylindrical cells adhering closely together in a single layer and

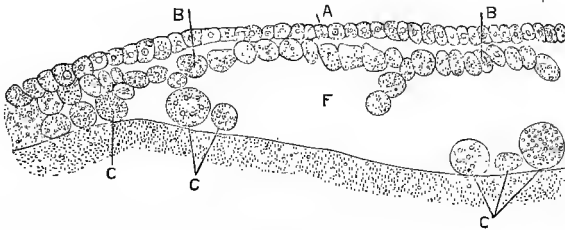

FIG. 10.—SECTION OF AN UNINCUBATED BLASTODERM OF CHICK. (*Klein*.)  
A, cells forming the ectoderm; B, cells forming the endoderm; C, large, formative cells; F, segmentation cavity.

resting on the white yolk; the lower, an irregular net-work of larger cells which are not nucleated, apparently; but which contain numerous highly refractive granules. These are probably identical with the white-yolk spheres already referred to, and are spoken of as formative cells.

The processes which in the hen's body result in the formation of such an egg are about as follow:

In the capsule of the ovary the yolk alone constitutes the egg. It then, just before bursting its capsule, consists of a minute, yellowish, ellipsoidal, cellular body, with a delicate membrane, the vitelline membrane, immediately below which in a granular cell-contents, the yolk, lies a lenticular mass of protoplasm, the germinal disk; within this again is a nucleus, the germinal vesicle, containing a nucleolus, or germinal spot.

When the ovum becomes mature the ovarian capsule bursts, and the ovum (representing the yolk of the egg as laid) escapes into the oviduct, undergoes impregnation by the spermatozoa found in the upper portion of the oviduct, and has deposited around it the accessory

portions of the egg through secretions from the walls of the oviduct. Thus, the layer of albumen surrounding the yolk is first deposited in the passage of the ovum through the second, tubular portion of the oviduct, the chalazæ (see Fig. 9), or twisted, denser portions of the albumen, being due to the rotatory motion of the egg against the spiral ridges of the oviduct. The shell-membrane is formed by the organization of the most external layers of albumen, and the shell is formed in the third portion of the oviduct, or the uterus. The walls of this portion of the tube secrete a viscid fluid which surrounds the egg, and in which inorganic particles are deposited. The egg remains in the uterus for from twelve to eighteen hours, and is then expelled through the cloæa, narrow end downward, by its muscular contractions.

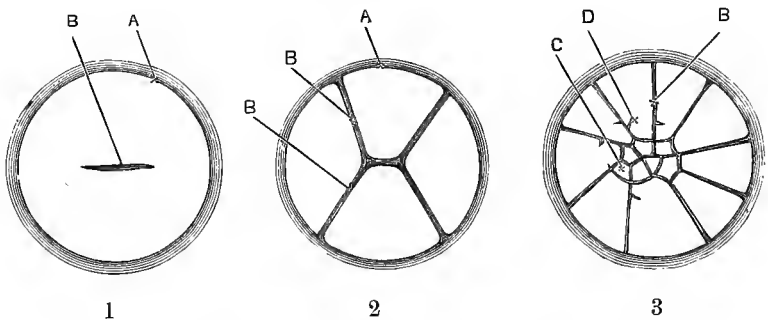

FIG. 11.—SURFACE VIEW OF THE EARLY STAGES OF SEGMENTATION IN A FOWL'S EGG, AFTER COSTE. (*Foster and Batfour.*)

1 represents the earliest stage. The first furrow, B, has begun to make its appearance in the centre of the germinal disk, whose periphery is marked by the line A. In 2 the first furrow is completed across the disk, and a second similar furrow at nearly right angles to the first has appeared. The disk thus becomes divided somewhat irregularly into quadrants by four (half) furrows. In a later stage, 3, the meridian furrows, B, have increased in number, from four, as in 2, to nine, and cross-furrows have also made their appearance. The disk is thus cut up into small central, C, and larger, D, peripheral segments. Several new cross-furrows are seen just beginning, as *ex. gr.*, close to the end of the line of reference, D.

About the time the shell is being formed, provided impregnation has taken place, changes occur in the blastoderm, which, though analogous to the process of segmentation already mentioned as taking place in the mammalian ovum, yet differs from it. The germinal vesicle first disappears, and a furrow is then seen to run across the germinal disk, dividing it into two halves. This furrow is then met by a second running at right angles to the first; this is then crossed by another, and division of the segments proceeds rapidly by furrows running in all directions until the germinal mass is cut up into an immense number of minute masses of protoplasm, smaller toward the centre than at the periphery of the disk.

The furrows thus formed are not merely superficial, but extend through the entire thickness of the germinal disk: hence the germinal disk is cut up into minute masses of protoplasm. In other words, a

large number of cells has resulted from the segmentation of the parent cell.

These cells arrange themselves into an upper layer, with their long

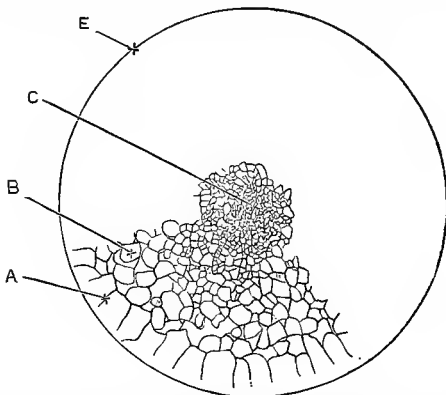

FIG. 12.—SURFACE VIEW OF THE GERMINAL DISK OF A HEN'S EGG DURING THE LATER STAGES OF SEGMENTATION. (*Foster and Balfour.*)

At C, in the centre of the disk, the segmentation masses are very small and numerous; at B, nearer the edge, they are larger and fewer; while those at the extreme margin, A, are largest and fewest of all. It will be noticed that the radiating furrows marking off the segments, A, do not reach to the extreme margin, E, of the disk.

The drawing is complete in one quadrant only. It will, of course, be understood that the whole circle should be filled up in a precisely similar manner.

axes vertical, their nuclei become distinct, while the lower cells remain large and granular and irregularly placed, forming in this way the unincubated blastoderm already described. (See Fig. 10.)

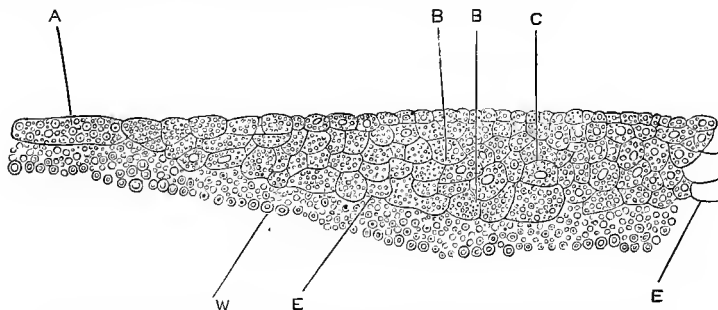

FIG. 13.—SECTION OF THE GERMINAL DISK OF A FOWL'S EGG DURING THE LATER STAGES OF SEGMENTATION. (*Foster and Balfour.*)

This section, which represents rather more than half the breadth of the blastoderm (the middle line being shown at C), shows that the upper and central parts of the disk segment faster than those below and toward the periphery. At the periphery the segments are still very large. One of the larger segments is shown at A. In the majority of segments a nucleus can be seen; and it seems probable that a nucleus is present in them all. Most of the segments are filled with highly refracting spherules, but these are more numerous in some cells (especially the larger cells near the yolk) than in others. In the central part of the blastoderm the upper cells have commenced to form a distinct layer. No segmentation-cavity is present.

A, large peripheral cell; B, larger cells of the lower parts of the blastoderm; C, middle line of blastoderm; E, edge of the blastoderm adjoining the white yolk; W, white yolk.

As a result of incubation a third layer of cells makes its appearance between the two layers of the blastoderm just described, forming an upper, a middle, and a lower layer, or the *epiblast*, the *mesoblast*, and the

*hypoblast* (Fig. 14). From these three layers of cells the embryo is developed.

Leaving at this point the changes which occur in the egg of the bird, we have now to follow the analogous changes in the mammalian ovum.

We have already seen that in the mammalian ovum one of the first evidences of impregnation is the division of the protoplasm of the ovum progressively into smaller and smaller segmentation spheres, until the cell-membrane becomes filled with an immense number of minute masses of protoplasm. The general character of this process in its earlier stages is probably identical in all the mammalia. The ovum of the rabbit has been most studied, and the sketch here given is based mainly on Balfour's summary of the early stages of development in the rabbit's ovum.

The ovum first divides into two nearly equal spheres, of which one

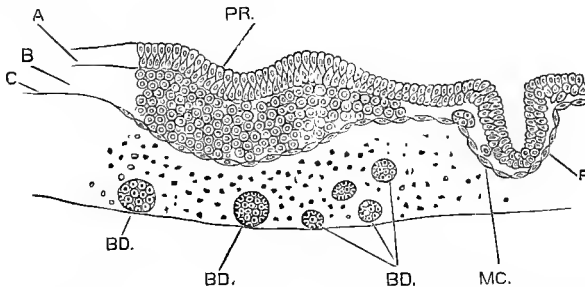

FIG. 14.—SECTION OF A BLASTODERM OF CHICK, AT RIGHT ANGLES TO THE LONG AXIS OF THE EMBRYO, AFTER EIGHT HOURS' INCUBATION, ABOUT MIDWAY BETWEEN FRONT AND HIND ENDS. (*Foster and Balfour.*)

A, epiblast; B, mesoblast; C, hypoblast; PR, primitive groove; F, fold in the blastoderm produced accidentally; MC, mesoblast-cell,—the line points to one of the peripheral mesoblast-cells lying between epiblast and hypoblast; BD, formative cells.

The section shows: (1) the thickening of the mesoblast under the primitive groove, PR, even when it is hardly present at the sides of the groove; (2) the hypoblast, C, early formed as a single layer of spindle-shaped cells; (3) the so-called segmentation cavity, in which coagulated albumen is present. On the floor of this are the large formative cells, BD.

is slightly larger and more transparent than the other. The larger sphere and its products will be spoken of as the *epiblastic* spheres; the smaller one and its products as the *hypoblastic* spheres. Both these original spheres soon divide into two, and each of these into two more, thus making eight. At first these spheres are spherical, and arranged in two layers formed of four epiblastic and four hypoblastic spheres. Soon, however, one of the hypoblastic spheres passes into the centre, and the whole ovum becomes spherical again.

In the next stage each of the four epiblastic spheres divides into two, followed by the division of the hypoblastic spheres into two. The ovum is then made up of sixteen different spheres, nearly of the same size. Of the eight hypoblastic spheres four soon pass to the centre, and are surrounded by the eight epiblastic spheres, arranged in the form of a cup. Division of both sets of spheres now continues, the epiblastic layer con-

tinuing to surround the central hypoblastic spheres, both sets continuing to subdivide, until finally the ovum consists of an almost solid mass of hypoblastic spheres surrounded by a layer of epiblastic cells.

When the process of segmentation is complete the epiblastic cells are clear and have an irregularly cubical form, while the hypoblastic cells are polygonal and granular and somewhat larger than the epiblastic cells.

The blastodermic vesicle next forms. This results from the formation of a narrow cavity between the epiblast and hypoblast, which increases in size until it entirely separates these two layers, except at the point where the blastoderm was last in forming (the *blastopore*). As the cavity increases in size the ovum also enlarges, so that soon it exists in the form of a large vesicle, formed of a thin wall of a single layer of

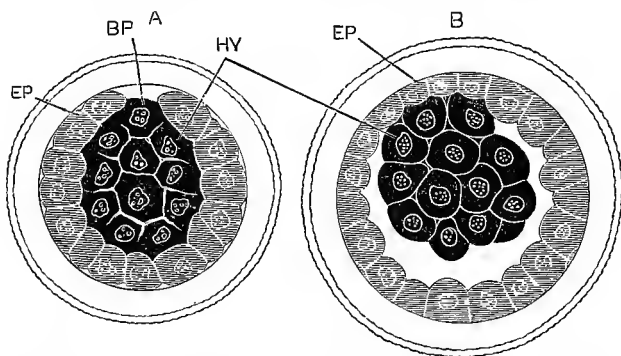

FIG. 15.—OPTICAL SECTIONS OF A RABBIT'S OVUM AT TWO STAGES CLOSELY FOLLOWING UPON THE SEGMENTATION, AFTER E. VAN BENEDEN. (*Balfour*.)

EP, epiblast; HY, primary hypoblast; BP, Van Beneden's blastopore. The shading of the epiblast and hypoblast is diagrammatic.

cells,—the epiblastic cells,—with a large cavity, the hypoblastic cells forming a small, ventricular mass attached to the inner side of the epiblastic cells (Fig. 16). The ovum of the rabbit has now increased in size from 0.09 mm., its size at the close of segmentation, to about 0.28 mm. It is inclosed by the vitelline membrane and a mucous layer deposited by the walls of the Fallopian tube.

As the vesicle continues to enlarge, the hypoblastic cells spread out beneath the epiblast, though remaining thicker in the centre than at the edges, where the cells still possess the power of amœboid movement. The central, thicker portion, which is the commencement of the embryonic area, forms an opaque, circular spot on the blastoderm.

The primitive hypoblast now becomes divided into two layers, the lower continuous with the peripheral hypoblast and formed of flattened cells, while the upper is formed of small, rounded elements,—the meso-

blast. The superficial epiblast, again, is formed of flattened cells, which soon become columnar and appear to unite with the rounded elements below, except at the lower part of the embryonic area. Here the blasto-

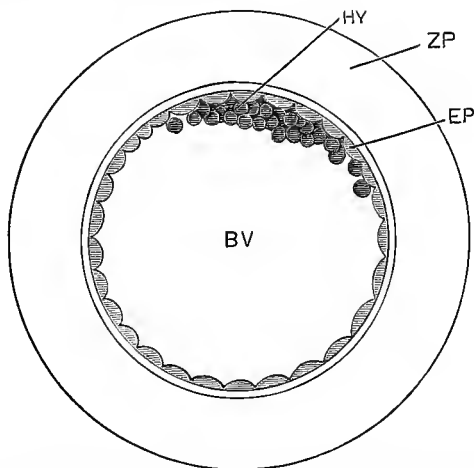

FIG. 16.—RABBIT'S OVUM BETWEEN SEVENTY TO NINETY HOURS AFTER IMPREGNATION, AFTER E. VAN BENEDEEN. (*Balfour.*)

BV, cavity of blastodermic vesicle (yolk-sac); EP, epiblast; HY, hypoblast; ZP, mucous envelope (*Zona pellucida*).

derm, as in the chick, is constituted by three layers,—the epiblast, the mesoblast, and the hypoblast.

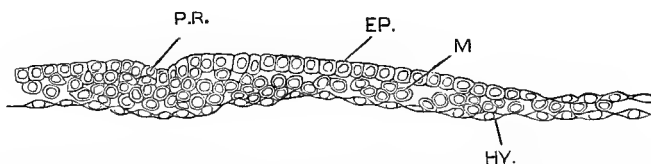

FIG. 17.—SECTION THROUGH THE OVAL BLASTODERM OF A RABBIT IN THE SEVENTH DAY, THROUGH THE FRONT PART OF THE PRIMITIVE STREAK. (*Balfour.*)

EP, epiblast; M, mesoblast; HY, hypoblast; PR, primitive streak.

The subsequent changes in the development of the blastoderm form the subject of Embryology, and for their consideration the reader is referred to text-books on anatomy.

### III. THE MODIFICATION IN THE FORM OF CELLS.

We have seen that originally all the cells formed by cleavage in the egg are absolutely alike. Like the original egg, they are typical cells, consisting of a cell-membrane inclosing finely granular protoplasm, in which a nucleus and nucleolus may be recognized. They only differ from

the original cell in size and in as yet unmarked individual characteristics which in the specialization of function of the organism will cause them finally, for the most part, to lose all morphological resemblance to the parent cell.

These differences in cells produced in the development of the organism are very numerous.

First, as regards their size, we find cells varying from the red blood-cell  $\frac{1}{3500}$  to the large ganglion-cell,  $\frac{1}{200}$  of an inch (Figs. 18 and 19).

In nearly all instances where a collection of cells develop into an organ or tissue the original spherical form is lost, often merely from mutual pressure and from alteration in the cell-contents, by which the most varied forms are produced. Thus, instead of the spherical form, cells may take on an oval, elongated shape (Fig. 20), or may be cylindrical (Fig. 21), or again from mutual pressure may form regular hexagons. Others may have long, thread-like attachments developed, as in the sperm-cells (Fig. 22), or even a number of such prolongations, which as long as the cell is alive continue in active movement (ciliated cells). (See Fig. 21.)

Often the nucleus deviates from its spherical form, and may become oval or irregular in outline, or, as in certain cells of the marrow of bone and in

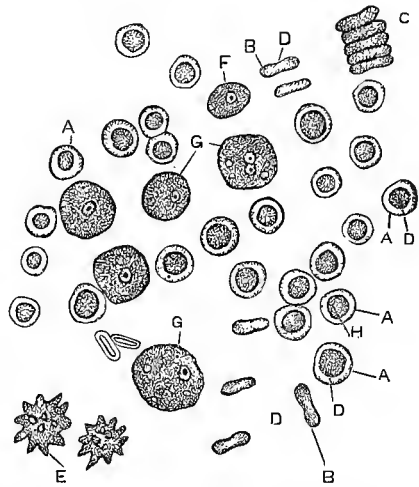

FIG. 18.—RED AND WHITE BLOOD-CORPUSCLES, ENLARGED SIX HUNDRED DIAMETERS. (Ellenberger.)

A, surface view of red corpuscles; B, profile view; C, rouleaux of red corpuscles; D, central depression in red corpuscles; E, crenated red corpuscles; F, small, and G, large white corpuscles.

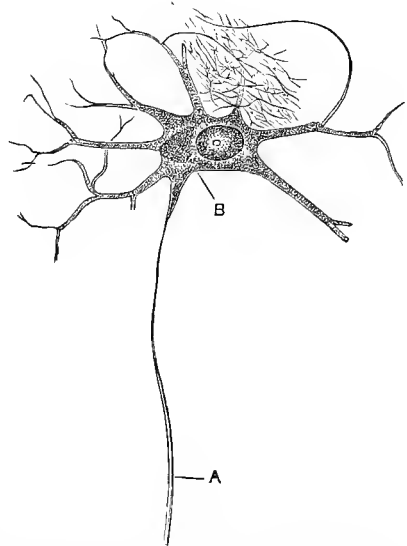

FIG. 19.—AN ISOLATED GANGLION-CELL OF THE ANTERIOR HORN OF THE HUMAN SPINAL CORD, AFTER GERLACH. (Klein.)

A, axis-cylinder; B, pigment. The branched processes of the ganglion-cell break up into the fine nerve net-work shown in the upper part of the figure.

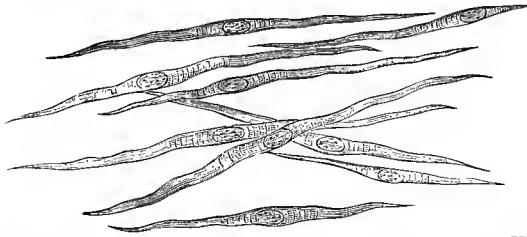

FIG. 20.—NON-STRIATED MUSCULAR FIBRES, ISOLATED. (*Klein.*)  
The cross-markings indicate corrugations of the elastic sheath of the individual fibres.

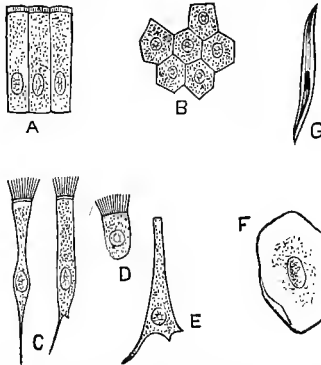

FIG. 21.—VARIOUS KINDS OF EPITHELIAL CELLS. (*Klein.*)

A, columnar cells of intestine; B, polyhedral cells of the conjunctiva; C, ciliated conical cells of the trachea; D, ciliated cell of frog's mouth; E, inverted conical cell of trachea; F, squamous cell of the cavity of the mouth, seen from its broad surface; G, squamous cell, seen edgewise.

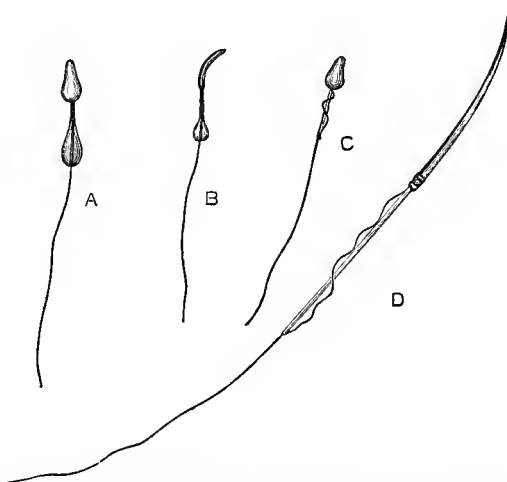

FIG. 22.—VARIOUS KINDS OF SPERMATOOZA. (*Klein.*)

A, spermatozoon of guinea-pig not yet matured; B, the same seen sideways, the head being flattened from side to side; C, a spermatozoon of the horse; D, a spermatozoon of the newt.



striped muscle, may undergo reduplication without division of the cell (Fig. 23).

The cell-contents, or protoplasm, particularly as regards its granular constituents, may undergo the greatest variation. Often true crystalline

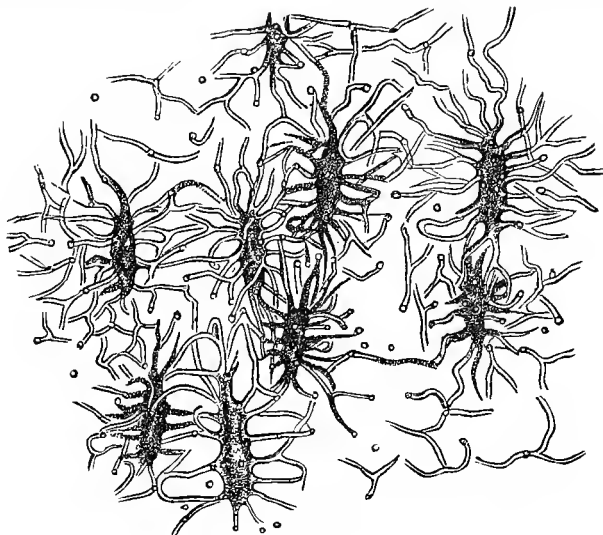

FIG. 23.—BONE-CORPUSCLES, WITH THEIR PROLONGATIONS, AFTER ROLLETT.  
(*Funt.*)

formations are included in the cell-contents; or vacuoles may form in which different fluids, sometimes watery, sometimes fatty, may collect, to again disappear in later stages of the life of the cell.

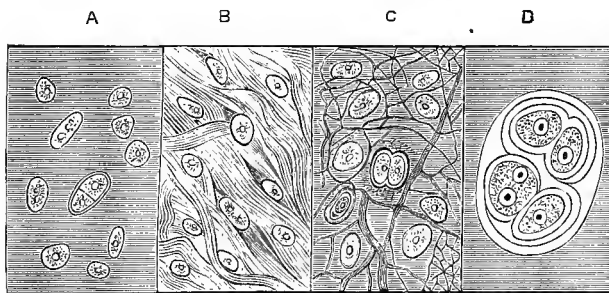

FIG. 24.—DIAGRAM OF DIFFERENT FORMS OF CARTILAGE. (*Ellenberger.*)  
A, hyaline; B, fibro-cartilage; C, elastic cartilage; D, secondary cartilaginous capsule, containing the primary capsule.

Another modification in the form of cells consists in the alteration of the border layers of protoplasm, so that the cell is surrounded by a more or less chemically or morphologically different area, or intercellular

substance, which may present the greatest variety as to quantity. The cell-membrane and so-called cell-capsule belong to these forms of protoplasmic modification. In cartilage and loose connective tissue this intercellular substance exists in such amount that the still actively moving protoplasmic cells appear to be forced apart by it. (See Fig. 24.)

Since the more active vital movements can only originate in the semi-fluid protoplasm of cells, it is evident that the more or less rigid intercellular substance could only take a slight part in organic processes if there were not some means by which it could be brought into close

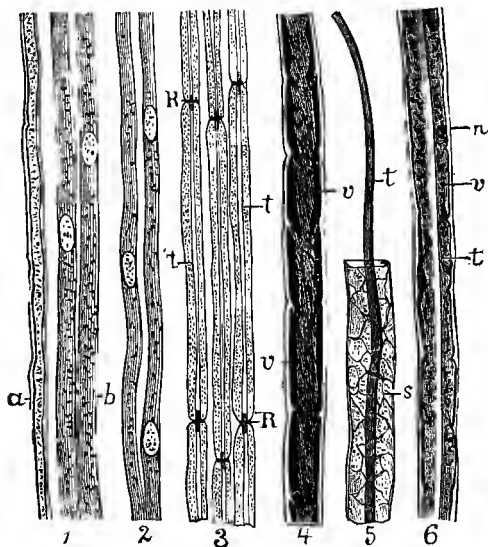

FIG. 25.—NERVE-FIBRES. (*Thanhoffer.*)

1, a, medullated nerve-fibre; b, non-medullated nerve-fibre from the sympathetic of the ox (after Schultze); 2, non-medullated nerve-fibre from Jacobson's organ in the sheep (after Schultze); 3, nerve-fibres with Ranvier's nodes (R), from the sciatic of the frog; 4, funnel-shaped arrangement of medulla from sciatic of frog, treated with osmic acid; 5, nerve-fibre from frog, with axis-cylinder (t) and so-called horny mesh-work; 6, diagram of medullated nerve-fibre; n, neurilemma; v, medullary sheath; t, axis-cylinder.

association with the active vital processes constantly occurring in the interior of cells. Consequently we find the entire intercellular substance pierced of a mesh-work of fine canals, through which the cells send prolongations of their outer layer, which, after numerous subdivisions, serve to connect neighboring cells.

By means of these juice-canals interchange between the contents of the various cells is possible and the intercellular substance receives its necessary supply of nourishment, while the connection of cell with cell is an illustration of the loss of individuality of cell-life. Often we find

cells connected by branching prolongations: in other cases the extensions of the cells—which, to be sure, have a very different function and structure from those already alluded to, but which, nevertheless, serve as connections between cells—so overbalance the cells in extent and number that the latter often appear only as rounded swellings in the extensions (*e.g.*, in the nerves). (See Figs. 25 and 26.)

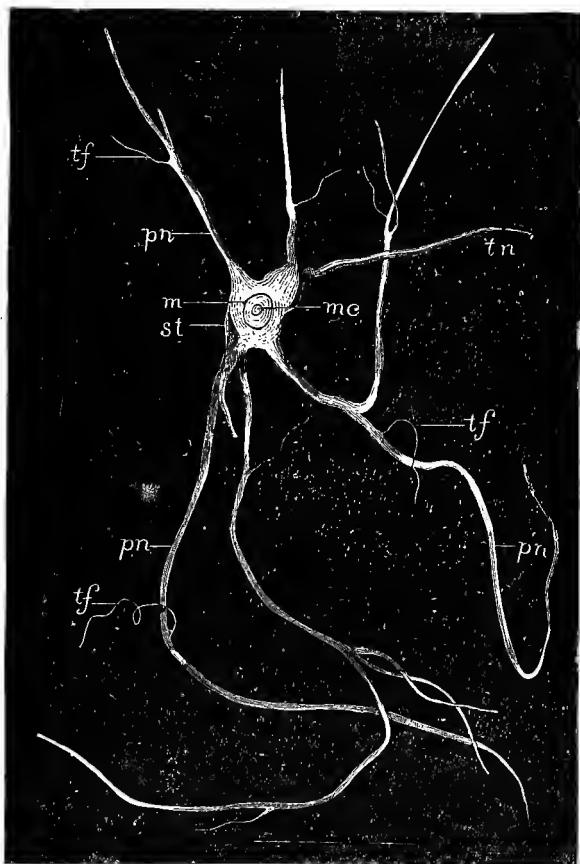

FIG. 26.—NERVOUS GANGLIONIC CELL AND BRANCHING FIBRES, AFTER KRAUSE. (*Thunhofer.*)

*st*, cell body; *m*, nucleus; *mc*, nucleolus; *pn*, protoplasmic prolongations; *tf*, axis-cylinder fibres; *tn*, axis-cylinder prolongations.

#### IV. THE DEVELOPMENT OF TISSUES AND ORGANS.

The final result of the metamorphosis of cells is the formation of tissues out of which the various organs of the body are built up.

The development of tissue starts in the earliest stages of development of the egg.

We have seen already that, as a result of fecundation, the egg divides into a number of minute segmentation spheres which at first form a solid, mulberry-like mass, and we have now to consider the changes occurring in the mass of simple, undifferentiated cells which result in the development of the tissues and organs of the completed organism.

In their early stages, as in the amœba, each of these cells possesses the powers of development, reproduction, growth, assimilation, respiration, and contractility. As the organism passes to a higher stage we find that many of these cells lose these general properties possessed in their entirety by undifferentiated protoplasm, while certain of them are put aside to carry on specific individual functions. Thus, in the young embryo, as in the amœba, all the cells possess the power of contractility; as the organism develops, this property becomes restricted to cells forming constituents of certain tissues, the contractile tissues, or the muscular system. The amœba, which we have already seen may be regarded as representing one of the units of which the higher organisms are built up, possesses the power of irritability and automatism. In higher forms this property of undifferentiated protoplasm is restricted to a single tissue, the nervous system. The amœba has no part specialized for the various processes of nutrition; any part of its substance may take in nutritive matter, may digest out the portions capable of supplying its nutritive needs, may remove the undigestible residue: any portion of the amœba is capable of carrying on the metabolic processes by which the matter absorbed as food is converted into protoplasm like itself, and any portion is capable of absorbing the gases necessary for these complex chemical processes and of getting rid of the effete products of its nutritive processes. In the higher organisms certain cells are set aside to form the organs concerned in the prehension of food; others have for their sole function the secretion of solvent juices which will digest out the nutritive matters of the food; others are the carriers of the matters absorbed to remote corners of the organisms; and the sole business of certain other cells is to get rid of the useless matter and the products of the waste of the economy. In the amœba any portion may divide off from the parent stock and so originate a new individual; in the higher animals certain tissues or collections of cells have for their sole office the reproduction of cells which shall constitute the starting point of a new organism. In the amœba, therefore, specialization of function has not commenced; each minute particle of the protoplasm which constitutes it is capable of carrying on all the vital functions. In the higher organisms, however, the elementary organisms of which they are built up are so arranged that there may be a division of labor. These collections of

cells, marked by a more or less exclusiveness of function, are termed *tissues*. It must not be overlooked, however, that, though certain functions are accentuated in individual tissues, they all possess remnants of all the functions originally seen in undifferentiated protoplasm. Thus, many besides the muscular tissues possess the power of contractility: it is not the nervous system alone which retains the property of responding to irritants. All the tissues are capable of reproducing themselves in part, and all possess the power of carrying on their own nutritive processes if suitable food is supplied to them.

We have seen that fecundation of the ovum leads to the development of an immense number of new cells, and we have referred to the modifications in form to which these segmentative spheres may be subjected.

Tissues are formed from these segmentative spheres in three different ways (Wundt):—

1. Through formation of layers of cells.
2. Through union of cells.
3. Through excretions by cells.

Often all of these methods are united in the formation of a compound tissue which is functionally active as a unit. Such a tissue is called an organ. The classification of tissues is based on anatomical grounds; of organs, on physiological grounds.

1. To the first group belong the *epitheliums*. In most of these the only modifications which occur in the form of the cells are due to mutual pressure from close contact. Such cells are therefore polygonal or flattened, or, when growth is most marked in one axis, cylindrical. The epitheliums, in series of layers or in single rows, cover the external surfaces of the body as well as the coatings of the digestive, urinary, genital and respiratory tracts which communicate with it, the ducts of glands, and the closed serous sacs. In the latter locality they are called endothelia, in the former epithelia. The hair and nails are modifications of these tissues formed of small elongated cells grown together into almost homogeneous tissues. The terminal portions of the organs of special sense are also epithelial in nature.

Epithelial cells are connected by a thin layer of an albuminous cement substance, which during life is in a semi-fluid condition. The shape of the cell may be columnar or squamous. Spindle-shaped and club-shaped cells, as well as goblet cells, ciliated cells, epidermic cells, and prickle cells, are all modifications of these shapes. Endothelial cells are always of the squamous variety, arranged in single layers of flattened, transparent cells with oval nuclei. When their form approaches the columnar, as occasionally is the case in certain serous membranes, they are then in an active state of division, are called germinating cells, and

the small spherical lymphoid cells which result are carried to the circulation to become white blood-corpuscles.

*Glandular tissue* is also epithelial in nature. Cells are the essential secreting organs of glands, though numerous other tissues enter into their composition. Such cells are usually rounded or polygonal, and are soft in consistence. Frequently the cells rapidly partially break down and are carried off as constituents of the secretion, as colostrum cells, or mucoid corpuscles (moulting); or the destruction of the cell form may be complete and the constituents of the cell enter the secretion in the form of a solution.

*Muscular tissue* forms the third of the group. In the muscles the muscular cells are always closely associated with connective tissue. Such cells may be of two different kinds, different in structure and in function,—the striped and unstriped cells. Muscle-cells are contractile, like amœboid cells, but contractility is only possible in one definite direction, that of their long axis; muscles, therefore, become shorter and thicker during contraction.

2. To the second group of tissues formed by union of cells belong two tissues in which, in their development, the cells have become greatly elongated, and after absorption of the cell-wall become converted into fibres or tubes; these are the nerves and capillaries.

In the nervous tissues certain cells retain their primitive character, the nerve-cells, and only nerve-fibres properly belong to this group of tissues. Nevertheless the nerve-cells are in continuity with the nerve-fibres.

The capillaries in a similar manner originate from the arrangement of nucleated, spindle-shaped cells in rows, which become hollowed out through the formation of vacuoles. The formative cells manifest a tendency to send out sprouts which connect with other forming or mature capillaries by which the net-work of capillaries is formed. Lymphatic capillaries are developed in the same way as the blood-vessels.

3. Tissues formed by excretions from cells, forming the third group, may also be called intercellular tissues. Connective tissue is a type of this class. Connective tissues serve to bind together all the organs of the body; they exist in various forms, which are to a certain extent mutually convertible; they all yield allied chemical products.

Connective tissue originates in spherical cells, with very soft protoplasmic nucleated contents, which ultimately may form a perfectly homogeneous, laminated, or fibrous intercellular substance.

The cells themselves may exist in various different forms, either as tendon-cells, when they are flattened, oblong masses of protoplasm arranged in rows, with round nuclei lying in bundles of fibrils of white connective tissue; as branched cells, found in the cornea, serous mem-

branes, and subcutaneous tissues, which, under certain conditions, preserve their power of movement; as pigment-cells, which are branched cells filled, with the exception of their nucleus, with granules; as fat-cells, in which the protoplasmic cell-contents are replaced by a drop of oil, which forces the flattened nucleus against the cell-membrane; and as migratory cells, which are formed in the spaces of fibrous tissue, and which possess the power of amœboid movement.

The form of connective tissue in which least change is produced in development is the so-called mucoid or gelatinous tissue. In some of the invertebrates, as in mollusks, this tissue forms the greater part of the body. It consists of a soft, semi-fluid, intercellular substance, in which numerous granules and broken down membraneless cells are suspended. Many of these cells possess the power of amœboid movement.

From this tissue in vertebrates the fibrillar connective tissue is developed by the condensation of this intercellular substance into bundles of fibres, held together by an albuminous cement substance, in which the forms of the cells become much changed, becoming flattened and elongated by mutual pressure until the diameter of the cell is not greater than that of the nucleus.

The elastic tissues are formed out of the fibrillar connective tissues, which become so modified chemically as to yield elastin and not gelatin. The fibres of elastic tissue are bright yellow in color, usually anastomose, and are sometimes straight, but more often coiled up in bundles.

The different forms of development of connective tissue, especially of the intercellular substance, depend upon its different chemical metamorphoses. Thus, the gelatinous tissues owe their properties to a semi-fluid albuminous body, the connective tissue proper to gelatin-forming bodies, cartilage or chondrin, and the elastic tissues to elastin, etc.

Bone is characterized by the deposit of inorganic compounds in its intercellular substance. This hardened tissue then incloses the partially broken down cells, which form the lacunæ or bone-corpuscles, in which the thickened membrane and nucleus are often visible, though they disappear in old bones and their place is then taken by serous fluids, etc.

The bones are also rich in vessels which traverse the Haversian canals.

As the deposit of salts occurs partly from these and partly from the external membrane, the bones become laminated in structure, some layers being parallel with the canals, others with the exterior.

Cartilage is characterized by a sparse intercellular substance which yields chondrin, and by large cells which are often the seat of endogenous multiplication. As in bone, so in cartilage, the intercellular substance becomes arranged in the form of capsules around the cells, and may either remain homogeneous (hyaline) or become fibrillar (fibro-

cartilage or elastic cartilage, in which a dense net-work of elastic fibres occupies the intercellular matrix). Most cartilages, except on articulating surfaces, are covered by a fibrous membrane, the perichondrium, supplied with blood-vessels, lymphatics, and nerves. •

Bone is surrounded by a fibrous membrane, the periosteum, with an inner layer of oblong nucleated cells, which, from the fact that the bone is developed from them, are termed osteoblasts. Similar cells are also found in the marrow of bones.

The *organs* of the animal body are always composed of several tissues; they may be of three classes, in each one of which some one tissue is especially prominent in function:—

1. Organs whose chief function depends upon tissues of the first class (cells without intercellular substance).

*a. Glands*, which always in addition to the epithelium contain nerves and blood-vessels. The epithelium is the essential part of glands, skin, mucous and serous membranes.

*b. Muscles*. In these are found muscle-cells as the functionally prominent tissues, though associated with them are connective tissue, blood-vessels, and nerves.

2. Organs whose chief function is manifested through tissues of the second class.

*a. Compound vessels*, arteries, veins, and lymph-vessels. Although the capillaries are formed by union of cells, in larger trunks this mode of formation only applies to the endothelium, on which the other tissues—elastic tissue, connective tissue, and pale muscular fibres—subsequently develop in layers.

*b. The organs of the nervous system*. Nerve-cells and nerve-fibres, formed by union end to end of cells, here form the essential tissues, though blood-vessels and connective tissue are associated with them.

3. Organs whose function is due to intercellular substance. The bony skeleton is the only representative of this group, and the modification of connective tissue known as bone, or its antecedent cartilage, is the characteristic tissue; as secondary tissues, connective tissue and blood-vessels and nerves, representatives of the second class, are also met with.

For the mode of development of the compound organs in the embryo the reader must be referred to text-books on anatomy or embryology.



## SECTION II.

### CELLULAR PHYSICS.

#### I. THE PHYSICAL PROCESSES IN CELLS.

As the tissues and organs of the animal body originate in cells, we should expect that the functions of the higher organisms, which we know to be identical with those of the most elementary forms of life, would to a certain extent be accomplished by the same general processes. We have already divided the functions of animal life into the vegetative, or nutritive, functions and the functions of relation, and have called attention to the attempt which has been made to reduce the working of these processes to physical and chemical laws. Although in many points this endeavor fails, the operation of the ordinary physical and chemical laws serves to explain many of the complex phenomena of animal life. This is especially seen in the maintenance of the nutrition of the organism.

That cells may retain a nutritive balance it is requisite, in the first place, that they be supplied with a proper pabulum, which must pass from the exterior to the interior of the cells. We have found that the typical cell is surrounded by a homogeneous or striated membrane, which, like all other organic tissues, contains a large amount of water closely associated with the ultimate molecules of which that membrane is made up. Hence, the cell-membrane may be regarded as a porous partition whose pores are filled with water, and which separates the cell-contents from the surrounding media. These media may be either gaseous, as the atmosphere; fluid, like the lymph and blood in higher animal forms, or water in aquatic forms of life; or semi-fluid, like the more or less solid intercellular substance.

This passage of nutriment from the exterior to the interior of cells is mainly accomplished by purely physical means, not only in simple unicellular organisms but also in higher forms of life, where digestion, or the preparation of food for absorption, has for its object the reduction of food into such forms that the operation of the physical laws of imbibition, capillarity, filtration, diffusion, and osmosis, aided perhaps by chemical affinity, will be sufficient to enable the nutritive matters to pass to the interior of cells.

When once in the interior of the cells the raw food-products must be transformed into protoplasm similar to that of which the cell-contents

is composed. This is a purely chemical process, is accompanied by the liberation of force, and requires for its performance the free access of oxygen. Gases, also, must therefore pass from the exterior to the interior,—a process which the laws of absorption and diffusion of gases are quite sufficient to explain. Again, the chemical processes concerned in the assimilation of food result in the formation of carbon dioxide, urea, kreatin, and other crystalline bodies which are no longer of use and which must be removed; or the cell activity may take on the form of a secretion,—that is, the cell-protoplasm may, from the matter supplied to it, manufacture certain substances which in the higher organisms have to be used elsewhere. In either case the products of the protoplasmic operations must be removed. Here, also, physical laws are all sufficient. Gases are removed under the laws of gaseous diffusion and absorption. All crystallized products are eliminated by equally simple means. The absorption of fluid by the cell-contents through imbibition leads to increase of volume, and hence to increased pressure on the cell-membrane. Filtration thus comes into operation. Or, if the pressures within and without the cell are equal, interchange of matters in solution may take place through diffusion and osmosis. All these processes may occur equally well in membraneless cells; for, in all cases, to permit interchange the dividing membrane must be capable of absorbing the fluids or solutions with which it is in contact. The conditions, then, are analogous to those of a body containing fluid by imbibition in contact with another fluid.

We have now to consider some of the physical processes concerned in these operations. The chemical processes will subsequently receive attention.

The explanation of the physical processes in cells is to be found in the molecular forces which fluid molecules exert on each other and on solids with which they may be in contact.

1. **COHESION** is the force which binds together adjacent molecules of the same nature; for example, two molecules of water or two molecules of iron. This attractive force is strongly exerted in solids, less so in liquid, and is absent in gases. It is measured by the force which is required to tear a body asunder. The closer the molecules of a body are together, the greater their cohesive force.

Cohesion varies inversely with the square of the distance which separates the molecules; anything, therefore, which drives the molecules apart will tend to weaken their cohesive force. When bodies are heated the expansion which they undergo is due to the separation of their molecules. Hence, when solids are heated their molecules are further and further separated until finally their cohesive force is balanced by the repulsive force, and the bodies pass from a solid to a liquid state. This

occurs in all cases, provided the heat to which they are subjected does not cause them to undergo chemical change. If a body which has been fused by heat has its temperature still further raised its molecules become so much further separated that the force of cohesion is not sufficient to keep them in contact, and the body then becomes vaporized.

In liquids the force of cohesion is not great; hence their molecules are readily displaced and a mass of liquid assumes the shape of the vessel which contains it; in other words, the force of gravity overcomes the force of cohesion. Cohesive force is, nevertheless, present in liquids, and may be demonstrated by the difficulty with which a plate of glass placed horizontally in contact with the surface of water is removed vertically upward. This difficulty is due to the fact that the adhesion of the glass to the water being greater than the cohesion of the water, the molecules of water must be violently separated to permit of the removal of the glass.

The spheroidal form assumed by small masses of liquid, as in a drop of dew, a globule of mercury, is due to the working of the force of cohesion of the molecules of the liquid. In a small drop of mercury placed on a surface for which it has no adhesion, as wood or glass, the sum of the mutual attractions of all its molecules being greater than the force of gravity acting on them, the globule assumes the spherical form. If, however, the drop of mercury is large, then the force of gravity increasing with the mass of the body becomes greater than its cohesion and the drop becomes flattened.

The molecules of all liquids attracting each other, it is evident that the molecules in the free surface of a liquid will be attracted by and will attract those below them, but will exert or will be subjected to no external attraction. At the surface of liquids, therefore, there is always an inward attraction, which is called surface tension. Of course, in these considerations external accidental pressures and attractions to which the liquid may be subjected are neglected.

The surface tension of liquids is well illustrated by blowing a soap-bubble on the end of a glass tube; as long as the other end of the tube remains closed the elastic tension of the air in the bubble balances the surface tension of the soap-film, but when the end of the glass tube is opened the tension of the film leads to the contraction and final disappearance of the bubble. So also insects can move on the surface of water without sinking, for the water, not being able to wet their feet, forms a depression, and the elastic reaction of the surface supports them. The case is similar when a sewing-needle is floated on water; as the needle is coated with a thin film of oil the water does not adhere to it, the surface becomes depressed, and its increased tension serves to support the weight. Washing the needle first in alcohol, ether, or potash causes it at once to sink.

The importance of these facts will be seen in the explanation of capillary phenomena.

2. **ADHESION** is the molecular attraction exerted between the surfaces of bodies in contact; it may be manifested between solids (as between two freshly-cut surfaces of a leaden bullet, or two pieces of plate-glass), between solids and liquids (as when a drop remains clinging to a glass rod which has been dipped in water), and between solids and gases (as shown by the bubbles of air which adhere to a glass or metal plate when immersed in water).

The adhesion of liquids to solids, which alone of the above will receive attention at present, is greater than the cohesion of liquids, as already mentioned. Thus, when a drop of water is placed on a glass surface it does not assume the spheroidal form, but becomes flattened out, showing that the adhesion of the water to the glass is greater than the cohesion of the water. If, however, the glass plate be greasy, then the drop of water will exert no adhesion to the glass and will remain spheroidal. This adhesion of liquids to solids is not universal, but

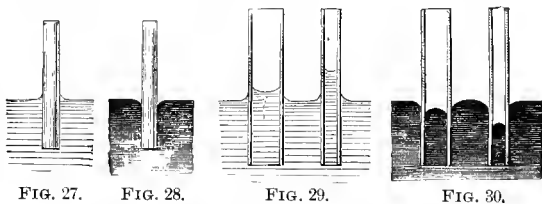

FIG. 27. FIG. 28. FIG. 29. FIG. 30.  
CAPILLARY PHENOMENA. (Gannot.)

depends on the nature of both the solid and the liquid. Certain liquids are capable of adhering to, or *wetting*, certain solids and not others; and a solid to which one liquid will adhere will be inert, or even repulsive to another. These facts also are of importance in the explanation of *capillarity*.

3. **CAPILLARITY**.—When a solid body is placed in contact with a liquid the phenomena (attraction or repulsion) which result are termed capillary phenomena from the fact that they are best seen when capillary tubes (*capillus*, a hair) are immersed in liquids.

As already stated, water is capable of adhering to glass. When a glass rod is dipped into water, the water is raised up against the sides of the rod to form a concave surface above the level of the water, as if no longer subject to the laws of gravity (Fig. 27). If, on the other hand, a glass rod be dipped into mercury, which does not adhere to it, the mercury is depressed around the rod, forming a convex surface below the level of the surrounding fluid (Fig. 28). If glass tubes with narrow bore are immersed in water and mercury, in the former

the water will rise within the tube considerably above the level of the water outside, and the surface of the water in the tube will be concave (*concave meniscus*); while the mercury will be depressed in the glass tube below the level of the mercury on the outside and the surface of the mercury within the tube will be convex (*convex meniscus*) (Figs. 29 and 30). If any two bodies, such as two glass plates, are immersed sufficiently near to each other in a liquid, the liquid will rise or be depressed between them, according as the liquid has or has not any adhesion to the plates (Fig. 31), the degree of elevation or depression being one-half what it would be if a tube of glass whose diameter equals the distance between the two plates were immersed in the same liquids. If a drop of water be placed in a conical glass tube of small angle and horizontal axis, each end of the drop will have a concave meniscus and it will move from the large to the small end of the tube: if the liquid be mercury, each end will have a convex meniscus and it will move in the reverse direction (Figs. 32 and 33).

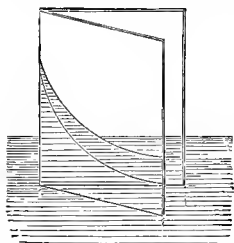

FIG. 31.

In the explanation of capillary phenomena two causes deserve attention: first, the cause of the curvature of the surface, and, second, the cause of the ascent or depression of the liquid within the tube.

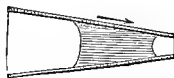

FIG. 32.



FIG. 33.

The form of the surface of a liquid in contact with a solid depends on the relation between the attraction exerted by the solid on the liquid and the mutual attractions of the molecules of the liquid. Any molecule of a liquid in which a solid is immersed is acted on by three forces: 1st, gravity; 2d, the attractive force of the solid for the liquid molecule; and 3d, the cohesive attractions of the other molecules of the fluid.

According to the relative intensities of these forces their resultant may occupy one of three positions:—

*First.*—If the attraction of the solid balances the cohesive attraction of the fluid, the resultant of these two forces will coincide with the force of gravity and the surface of the fluid will be horizontal; for to be in equilibrium the surface of a liquid must be at right angles to the direction of the resultant of all the forces acting on that liquid (Fig. 34).

*Second.*—If the attractive force of the solid for the fluid increases, or if the cohesive force of the liquid diminishes, the resultant will fall outside of the line of gravity or between the line of attraction of the

solid and the line of gravity, and the surface of the liquid being at right angles to that resultant will be concave (Fig. 35).

*Third.*—If the attraction of the solid for the liquid decreases, or the cohesive attraction of the liquid increases, the resultant will fall to the other side of the line of gravity, or between the line of cohesive force of the liquid and the line of gravity, and the surface of the liquid, being perpendicular to that resultant, will be convex (Fig. 36).

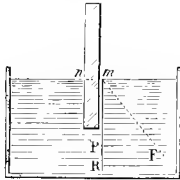

FIG. 34.

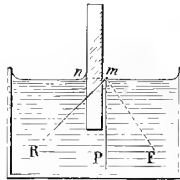

FIG. 35.

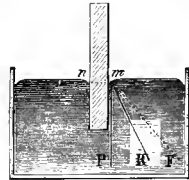

FIG. 36.

DIAGRAMS ILLUSTRATING CAUSE OF CURVATURE OF LIQUID SURFACES IN CONTACT WITH SOLIDS. (*Gannot*.)

The molecule  $m$  is acted on by gravity, in the vertical line  $mP$ ; is attracted by the plate  $n$ , in the line  $mF$ , and by the liquid  $F$ , in the line  $mF$ . The direction of the resultant  $mR$  will depend upon the relative intensities of these forces. If  $n$   $m$  and  $mF$  balance, the resultant is vertical,  $mR$  (Fig. 34), and the surface is horizontal. If  $n$   $m$  increases, or  $mF$  decreases, the resultant  $R$  is within the angle  $mP$ , and the surface is concave (Fig. 35). If  $mF$  increases, or  $n$   $m$  decreases, the resultant  $R$  is within the angle  $PmF$ , and the surface is convex, for the surface of a liquid is always perpendicular to the resultant of forces acting on its molecules (Fig. 36).

The ascent or descent of liquid within a capillary tube is dependent on the manner in which the curvature of the surface modifies the principles of hydrostatic equilibrium.

When a tube of large calibre is immersed in a vessel containing liquid the conditions of equilibrium are the same as in two communicating vessels containing the same fluid. Equilibrium is only possible when the

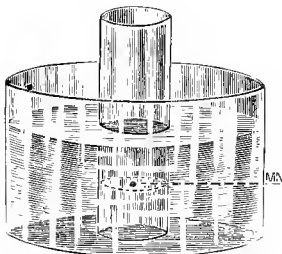

FIG. 37.—DIAGRAM ILLUSTRATING LIQUID PRESSURES.

surface of the liquid in both vessels is on the same horizontal plane. For, take any molecule in the plane  $MN$  (Fig. 37). It will be subjected to a downward pressure equal to the weight of a column of the same fluid, the height of which is equal to the distance of that molecule from the surface of the fluid within the tube. It will also be subjected to an upward pressure which is equal to the weight of a column of liquid whose height is equal to the distance of that plane from the surface

of the liquid without the tube. These weights are, however, equal. Therefore every molecule in the plane  $MN$  will be subjected to equal and contrary pressures, and will consequently be in equilibrium.

Suppose, however, the tube have a diameter less than one millimeter. The concave surfaces produced by the adhesion of the fluid to the

walls of the tube will then intersect, and the surface of the fluid within the tube will be a concave meniscus. In other words, every portion of the surface of the liquid within the tube will be under the attractive influence of the walls of the tube. A certain portion of the fluid within the tube will so be held up by adhesion to the tube, and will hence exert no downward pressure. As a consequence the downward pressure within the tube will be less than the upward pressure of a column of fluid of the same height without the tube. Any molecule on any plane below the surface of the fluid in the tube would so be subjected to two unequal pressures, a greater upward pressure and a lesser downward pressure; the column of liquid will therefore rise within the tube until these two pressures are equal.

When, however, the force of cohesion of the liquid is greater than that of adhesion to the walls of the tube, as already explained, the surface becomes convex and the surface tension is increased. Since the molecular forces are greater than gravity, the downward pressure in the tube is greater than the upward pressure to which any plane is subjected by the weight of the liquid outside of the tube. The fluid then is depressed in the tube until these two pressures are equal.

Capillarity partly explains the ascent of the sap in trees, the ascent of oil in a lamp-wick, to a certain extent the movement of the blood and lymph in the capillaries, but more especially the entrance of fluid into porous bodies,—a fact of the greatest importance as underlying the explanation of imbibition, filtration, and osmosis.

4. SOLUTION.—That a substance may enter the interior of cells it must, as a rule, be in a state of solution; though we shall find, when we study the process of absorption, that there are several exceptions to this statement.

The process of solution of solids in fluids is of very general occurrence in cell life. Almost all food-stuffs are solid, and to be of nutritive value must first be reduced to the form of a solution; even the consumption of organic matter in the vital processes of a cell results in the formation of a watery solution, as in the formation of urine, sweat, and the various secretions.

When a solid dissolves in a liquid, the cohesion of the molecules of the solid is broken by their adhesion for the molecules of the liquid. When, therefore, the attraction of the liquid for the solid is greater than the cohesion of the solid, the latter is said to be soluble and its molecules separate. The limit of solubility is reached when the attractions of adhesion and cohesion are balanced.

Anything that reduces the cohesion of a solid favors its solution; thus, heat accelerates solution by separating solid molecules through the expansion which it produces, and, by increasing the distance between

the molecules, thereby weakens their cohesive force. Pulverizing, by mechanically separating the molecules to a certain extent, also assists solution.

Heat is always essential to the conversion of a solid into a solution. Ordinarily the heat is abstracted from the surrounding media, and is rendered latent in the solution, thus explaining the mode of action of freezing mixtures. The amount of heat so rendered latent in forming a solution is nearly always equivalent to the amount required to melt the body.

In certain cases, however, instead of the temperature being lowered in the process of solution, it actually rises, as when caustic potash is dissolved in water. This depends upon the fact that two contrary processes are going on at the same time; the solution, which tends always to produce a reduction of temperature, and the chemical union of the potash with the water, which, like many other chemical processes, tends to cause an increase of temperature. Consequently, as one or the other of these processes predominates the temperature will fall or rise; or, if the two balance, will remain unchanged.

Solubility varies greatly in different bodies and in different liquids. Some solids are soluble only in hot media, and are deposited on cooling; others only in cold liquids, and are thrown out of solution when the temperature of the liquid is raised. As a rule, bodies dissolve in liquids which have similar properties; thus crystalline bodies are soluble in water, fats in oil, metals in mercury, and resins in alcohol.

“When two or more salts are dissolved in water without chemical action on each other, three conditions result: 1st. The quantity of each salt held in solution is *less* than when it alone is present, though the combined quantity is greater than when only one salt is used. 2d. The quantity of each is as *great* as when one only is used; then the total quantity dissolved is the sum of that taken up in each single solution. 3d. The quantity dissolved is greater than when one alone is used, the addition of the second salt in this case increasing the solubility of the first, and often the first increasing also the solubility of the second” (Draper).

When the cohesion of the solid and its adhesion for the liquid molecules balance, the solution is then said to be *saturated*. In the case of certain fluids, like alcohol and water, there is no limit to solubility; their molecules will freely mingle with each other, and the resulting liquid is said to be a *mixture*, or an *emulsion*. On the other hand, two liquids may offer an example of true solution, one being only capable of passing to a certain degree between the molecules of the other, as in the case of volatile oils and water, where the limit of solubility is readily reached.

5. IMBIBITION.—Every porous solid may be considered as formed of



a collection of capillary tubes. When such a solid (*e.g.*, a piece of chalk) is immersed in a fluid which is capable of wetting it, the fluid will enter into the pores of the solid through capillarity, and will remain even after the body is removed from the fluid. The solid is then said to have absorbed fluid by imbibition. Organic bodies also are capable of absorbing fluid by imbibition, but the process is somewhat different from that of the inorganic porous body.

Every organic body, no matter what its consistency, contains always a large amount of water in its composition, to which fluid, as we shall find later, many of the physical properties of the tissues are due. When inorganic bodies contain fluid, that fluid is held in one of two ways,—either chemically united with the body, as in hydrates, or as water of crystallization; or mechanically in the pores of the solid. Organic bodies occupy a mean between these two. The water in their composition is not in a form of chemical combination, nor is it held mechanically in pores, as in the porous inorganic body, though the conditions are somewhat similar to the latter case. That there is a difference, however, is proved by the different effects of the abstraction of water from organic and porous inorganic bodies. The physical characters of porous, inorganic solids, such as baked clay, are not seriously altered by the removal of water contained in their pores. The abstraction of water from semi-solid organic bodies, on the other hand, entirely changes their physical and physiological properties. A piece of connective tissue in its fresh condition is soft, white and glistening, flexible, extensible and elastic. When the water which it contains is removed by drying, it shrivels up, becomes rigid, yellowish in color, brittle, and loses weight. If it be then immersed in water its previous characters will be restored. This difference in the manner in which the water entering into the composition of organic and inorganic bodies is held is explained by the assumption that in the porous inorganic body the water occupies comparatively large spaces between particles of solid, while in the organic body the water surrounds the ultimate molecules of the body. Organic tissues may therefore be defined as bodies whose intermolecular spaces are filled with fluid.

As the fluids are held in a different manner in inorganic and organic bodies, it is natural to find that the way in which the fluid is absorbed differs in the two cases.

When a dry, porous, inorganic body, such as a piece of chalk, is thrown into water, the water enters the pores of the chalk by capillarity and displaces the air which was contained in its pores. It increases in weight by the addition of the weight of the absorbed water, but does not increase in volume. When a dry organic body, such as a piece of gelatin, is thrown into water no air is displaced, and yet many times

its own volume of water may be absorbed. The gelatin must therefore increase in volume. The fluid in organic imbibition passes into the intermolecular spaces and separates the molecules. That an organic body may imbibe fluid it is consequently necessary that its molecules be freely movable.

The power of imbibition possessed by the organic tissues is especially due to their albuminoid constituents. Protoplasm is, therefore, above all capable of imbibition, and the rapid formation or disappearance of vacuoles in protoplasmic cells may be due to rapid changes in imbibition.

Every organic substance has a limit beyond which imbibition is impossible. This limit is lower when the water contains solids in solution, provided the solids are not chemically acted on by the tissues, from the fact that imbibed water is held with greater tenacity by the tissues than are the substances held in solution in the water. Thus, when a tissue saturated with a salt solution is subjected to pressure, the solution first pressed out is more concentrated than that which is forced out when the pressure is subsequently increased; and in general the fluids lose in concentration in imbibition. Organic tissues therefore absorb water with greater readiness than saline solutions. The importance of this fact will be seen in the explanation of osmosis.

The extent of imbibition depends, therefore, on the membrane and the nature of the fluid with which it is in contact. Thus it has been found by Liebig that one hundred parts of ox-bladder absorb, of—

Water,	.	.	.	.	268 volumes.
Salt solution (1.204 sp. gr.),	.	.	.	.	133 "
Alcohol (84 per cent.),	.	.	.	.	38 "
Marrow oil,	.	.	.	.	17 "

Membrane, therefore, has less affinity for a salt solution than for water. This may also be shown by soaking a bladder in water, wiping it dry, and then sprinkling it with common salt. The salt comes in contact with some of the water in the bladder, dissolves, and forms a salt solution. But as the membrane can contain less salt solution than water, some of the solution is expelled and the bladder shrivels up. So also a moistened bladder thrown into alcohol shrivels up, because the alcohol mixes with the water in the bladder; and as the bladder, as shown above, can only absorb one-seventh as much alcohol as water, the solution is driven out. This is the explanation of the use of alcohol and various saline solutions for hardening tissues for making microscopic sections.

In the nutrition of animal cells the process of imbibition is an important factor. Every substance which is soluble in water is capable of being appropriated by the protoplasm and may, through imbibition,

obtain access to the interior of cells, to there undergo the transformations which the needs of the economy necessitate. In cells which possess a closed membrane, capillarity may also be concerned; for there is reason to suppose that the striated appearance which is seen on examining most cell-membranes with a high power under the microscope is in reality due to the presence of minute apertures, or caualiculi. Fluid will therefore enter the pores in the membranes of cells, and so obtain access to the protoplasmic cell-contents. The passage of fluids, however, through the cell-membrane is not necessarily dependent on capillarity. For the cell-membrane, like other organic tissues, is capable of absorbing water by imbibition in the same way in which water is absorbed by gelatin, *i.e.*, by entering into its intermolecular spaces. The state of affairs is thus similar to the conditions described in the experiment with the bladder and salt. We have an organic tissue soaked with a fluid in contact with a substance (protoplasm) having an affinity for that fluid greater than the affinity of the membrane for the fluid; the fluid, therefore, leaves the cell-membrane to enter the protoplasm by organic imbibition.

The affinity of protoplasm for water is never satisfied during life: or, in other words, the maximum amount of water capable of being absorbed by cell-contents is never reached. Cells will, therefore, always absorb fluid when brought into contact with it, and by so doing will tend to increase in volume. As, however, the extensibility of cell-membranes is in most cases very limited, the increase in volume of the cell-contents will tend to cause *filtration* of the fluid contained in the meshes of the protoplasm back through the cell-membrane to the exterior.

These facts which we have learned in reference to the imbibition of fluids by organic tissues give but an imperfect idea of the processes of imbibition which take place in living cells. Many fluids which are absorbed by dead tissues are perfectly indifferent to living cells, and there can be no doubt but that imbibition in living tissues is largely governed by the nature of the chemical affinities caused by the chemical processes continually taking place in the interior of active cells. Thus, living tissues (museles) are incapable of absorbing dilute solutions of sodium salts; the same tissues when dead will absorb it in large amounts. Potassium salts, on the other hand, are rapidly absorbed by the same tissue and almost instantly cause its death, though even in this case the power of imbibition for the potassium salt is greatly increased after death. Again, we shall find that the prolonged activity of many tissues, especially the museles, is manifested in the production of an acid reaction in the cell-contents; under such circumstances, sodium solutions, which are indifferent to these tissues at rest, will now be absorbed by them.

The following figures represent the behavior of the muscular tissue to solutions of different salts (Ranke):—

MAXIMUM IMBIBITION.		
1 PER CENT. Na Cl.		1 PER CENT. K Cl.
Living, resting muscle,	0	Positive, but not capable of estimation, as the muscle instantly died.
Living, tetanized muscle,	13	Positive: not to be estimated, for the same reason as above.
Dead muscle,	35	136 per cent.

Perfectly analogous observations have also been made in the case of the nervous tissues.

It would, therefore, appear that living tissues only absorb by imbibition when their vital forces are diminished in energy. In the organism the cells are continually bathed in a fluid which contains the matters necessary for the nutrition of the cells. If the cells have been at rest their nutritive equilibrium has not been disturbed and imbibition does not take place. If, however, they are exhausted by previous activity, imbibition is then inaugurated, nutritive substances enter, the results of cell activity are extruded (acids, etc.), nutritive equilibrium is restored, and imbibition not only ceases, but from the increased volume of the cell-contents pressure is produced on the cell-membrane and the excess of fluid is forced through again to the exterior by filtration. Consequently cells which are most weakened by prolonged activity are the cells which carry on, as a direct result of the chemical affinities created by that activity, the most active imbibition. By these peculiarities in the conditions which govern imbibition in living cells is to be explained the peculiar distribution of the inorganic salts in the animal body,—sodium in the fluids, potassium in the solid organs of the body. For, as we know, sodium solutions are indifferent fluids and are not absorbed by the tissues unless they have undergone some depression in energy, while potassium salts in solution are rapidly absorbed and lead to the death, the drowning out of protoplasm.

6. FILTRATION OR TRANSUDATION is the passage of fluid through a membrane dependent upon inequality of hydrostatic pressures; but that a fluid should so pass it is essential that the membrane be capable of absorbing the fluid by imbibition.

The greater the affinity of the fluid for the membrane (see *Imbibition*) the more rapidly will the fluid under a moderate pressure pass through the membrane: thus water, or even a saline solution, will filter more rapidly than oil. Filtration will occur more rapidly through a thin than a thick membrane.

The rapidity of filtration is, further, in direct proportion to the pressure which the fluid exerts on the membrane, and increases with increas-

ing temperature. Solutions of different salts pass almost unaltered through membranes, though the filtrate, from the fact that the membrane keeps back some of the water of solution, may be more concentrated. The reverse is true in the filtration of colloids (bodies like glue); there the filtrate contains a smaller percentage of the colloid than the original fluid,—from the fact that the membrane allows more water to pass than gum, albumen, etc.

This explains the fact that colloid bodies, perhaps on account of the great size of their molecules, are with great difficulty removed from the pores of animal and vegetable tissues, especially since it has been found that if the fluid which contains colloids in solution also contains crystalloids, less colloid will filter through than if the crystalloids had been absent, and the filtrate is richer in crystalloids than the fluid in the filter. Crystalloids, therefore, hinder the filtration of colloids; and as protoplasm is always associated with certain saline bodies, the latter prevent the loss of the albuminoids of the cell-contents.

Many of the phenomena of filtration may be explained under the working of the laws of capillarity, especially when the filter is an inorganic, porous solid. When, however, it is an organic membrane, as of course is always the case in the animal or vegetable cell, there the laws of imbibition are of prime importance.

Cell life furnishes many examples of the process of filtration. When the cell-contents increase in bulk through imbibition the pressure on the interior of the cell-membrane is greater than on the exterior; substances in solution within the cell may then pass through the cell-membrane. The formation of the saline constituents of the various secretions is probably accomplished in this way. When the flow of blood is obstructed in a vein the pressure back of the obstruction becomes greatly increased, and the water and saline constituents of the blood pass through the walls of the vessel. In this way œdema and dropsies are produced. In the liver, so long as the pressure in the bile-ducts is low, the bile filters from the liver-cells into the bile-ducts. But if the flow of bile is interfered with so as to make only a slight resistance in the bile-ducts, the bile then filters into the hepatic parenchyma, from there into the lymphatics, by which it is carried throughout the body, and jaundice is produced.

When the renal secretion comes under consideration it will be found that the process of filtration there fills a very important rôle.

When fluids pass from the interior to the exterior of cells, or the reverse, they usually come into contact with other fluids. Under certain circumstances these fluids will mix; under others mixing will not occur. Those conditions now demand consideration.

7. DIFFUSION OF LIQUIDS.—The molecules of liquids, as has been already seen, are held together by a force of attraction, or cohesion; the

molecules of liquids are also capable of exerting an attractive force on solids, or adhesion. In addition to these two modes of manifestation of molecular force, molecules of liquids are capable of attracting molecules of other liquids. If in two different liquids brought into contact the cohesive force between the molecules of each liquid is greater than the attractive force between the molecules of the different liquids, the liquids remain separate and apart, and are said not to be miscible. Water and oil furnish examples of such liquids.

If, however, the attraction between the molecules of the different liquids is greater than the cohesive force of either, then the liquids will mix, even against gravity, until the mixture becomes uniform. Such a process of mixing is called *diffusion of liquids*. It follows, therefore, that whenever two chemically indifferent fluids are brought into contact with one another they mix, even without any disturbing cause, until a perfectly uniform mixture results.

Diffusion may be illustrated by filling a small bottle with some saline solution and then placing it in a large jar, which is then carefully filled with distilled water, so poured in as to cover the mouth of the small jar which contains the saline solution, at the same time avoiding any mixing of the fluids by movement.

If a small portion of the water in the large jar is then drawn off carefully from time to time with a pipette, it will be found that the water will contain a gradually increasing quantity of the salt, until finally the jar will be filled with a perfectly uniform saline solution.

From such experiments it has been found that the rapidity of diffusion increases with the extent of surfaces in contact, with the temperature, and with the difference in concentration of the two fluids; it is, therefore, more rapid at the beginning of the experiment, when the outer jar contains distilled water, than later, when it contains a saline solution. The rapidity of diffusion also varies with the chemical nature of the solutions; thus, potassium salts diffuse much more readily than sodium salts,—a point which we shall later see is of great importance. Acids diffuse very rapidly; alkaline salts and sugar slower, and colloids, perhaps from the fact that they cannot form true solutions, scarcely at all, though colloids in solutions with crystalloids do not interfere with the diffusion of the latter; while, when two salts undergo diffusion together, the least diffusible salt diffuses more rapidly than it would alone.

In the different animal tissues, in addition to the intermolecular spaces filled with fluid, we have also larger spaces, or sensible pores, which contain fluids, and which form a system of more or less fine canals traversing the different parts of the body (lymph-spaces, lymph- and blood-capillaries). Therefore every internal part of the animal body is continually bathed in liquid into which fluids leaving the cells are

capable of diffusion. In most cases, however, these fluids are in constant motion, and the purely physical phenomena of diffusion are of little importance, particularly when the extreme slowness of ordinary diffusion is remembered. As the composition of the fluids of the body is continually changing, diffusion, greatly aided by the motion of the fluids, will, nevertheless, serve to maintain a certain degree of constancy of composition.

It has been already shown that when watery solutions are found on different sides of a membranous partition, as in the case of the cell-contents of two neighboring cells whose contents are more or less fluid, the membrane does not serve to keep the fluids apart. For, the membrane being capable of absorbing liquids by imbibition, the liquids fill the intermolecular spaces of the membrane, and so come in contact with each other; the phenomena of diffusion then commence, though the process is very greatly modified by the behavior of the intervening membrane. As already mentioned, diffusion, with the exception of the part it plays in distributing fluids uniformly through the interior of cells, fills quite a secondary rôle in the physical processes of the animal economy. Diffusion as modified by the passage of liquids through an animal membrane occupies a much higher position in point of importance.

8. Osmosis.—When two liquids capable of mixing are separated by a membrane which possesses the power of imbibing these liquids, a gradual union of the two liquids takes place through the membrane.

This interchange, which is called osmosis, continues until the two liquids are equally mixed; consequently, the final result is the same as if no membrane separated the two liquids, though the process is essentially different; for the diffusion currents must be modified by the molecular forces which the molecules of the membrane exert on the liquids in contact with them. If two liquids are

pooured into the arms of a U-tube (Fig. 38) so that they are in contact at A they will mix, but the level will remain the same in both tubes, *i.e.*, equal portions of each liquid pass into one another in equal time; if, on the other hand, a membrane is placed at A the liquids will

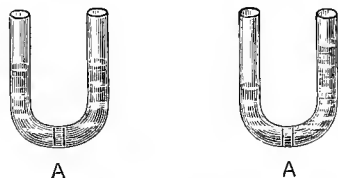

FIG. 38.

mix, but the column of liquid will rise in one tube above the original level and sink to a corresponding amount in the other. From which it follows that in the mixing of liquids through a membrane the interchange is unequal, *i.e.*, more of one liquid passes than of the other. The current through the membrane is a double one. Thus, if a saturated salt solution is placed in one arm of the tube and an equal quantity of distilled

water be placed in the other, the salt solution will soon be found to have increased in volume and the water to have decreased. If the character of the two liquids is then examined it will be found that the distilled water is no longer pure, but that it contains salt; while the saline solution will be no longer saturated, but of much less density. Salt has therefore passed through to the water and water passed through to the salt solution. There has been, however, as is evident, a difference in the rapidity with which the two substances have traversed the membrane. That this process is not at all analogous to filtration—in fact is directly opposed to it—is seen in the continued ascent of the column of liquid in one arm of the tube, showing that the water passes to the salt solution even against a continually increasing hydrostatic pressure. The tendency is therefore for filtration currents to form in the opposite direction to the osmotic current. If one liquid is water and the other salt solution, the amount of water passing to the salt solution for each equivalent of salt passing to the water is called the osmotic equivalent of the salt. The osmotic equivalent is dependent upon the chemical nature of the body and the concentration of its solution.

Thus, for sodium chloride it is 4.3, meaning that for every gramme of salt which passes through the membrane 4.3 grm. of water will pass in the opposite direction to the salt. For sodium sulphate it is 11.6; potassium sulphate, 12; magnesium sulphate, 11.7; alcohol, 4.2; sugar, 7.1.

In general the osmotic equivalent increases with the temperature, and varies very greatly with the concentration of the solutions.

The rapidity with which different bodies diffuse through a porous membrane is independent of their osmotic equivalent, but is directly dependent upon their chemical nature and solubility, increasing with solubility; and bodies nearly related as to their chemical composition are also nearly related as to rapidity of diffusion. The rapidity also increases with increasing difference of concentration between the two liquids and with increase of temperature.

When two solutions of the same substance but of different densities are allowed to diffuse into one another, the denser decreases in density and the lighter increases, and the same alterations of volume occur as would be the case were one of the liquids pure water. The osmotic equivalent is in both cases the same, but in the former case the rapidity of osmosis is much less.

If two solutions of substances of different chemical composition are allowed to diffuse, the rapidity will increase with increase in the chemical affinity between the two substances.

All colloids pass with difficulty through organic membranes, but as they have a strong affinity for water they draw it with vigor through organic membranes; hence, their osmotic equivalent is very high, though



the current of water to the colloid is very slow, possibly because the large molecules of the colloids readily stop the pores of the membrane. Albumen in solution passes more readily through a membrane to mix with salt solution than with water. A very concentrated solution of salt, however, prevents osmosis of albumen by simply removing the water from the albuminous solution.

When a solution of a diffusible substance, together with a solution of a colloid, is placed on one side of a membrane and pure water on the other, at first none of the colloid passes through the membrane, but simply water to the colloid and the diffusible substance to the water; hence, albumen may be freed of its salts by diffusion (dialysis), or, if a mixed solution of sugar and gum is subjected to dialysis, only the sugar passes through the membrane.

An exception to this is seen when albumen and salts dialyze with water. First the salts pass, then the albumen passes into the salt solution.

Just as we found there were two kinds of imbibition,—the capillary and molecular,—so are there two kinds of osmosis, which differ somewhat according as the partition between the two fluids is a porous, inorganic solid, or an organic tissue capable of absorbing liquid by imbibition. In the case of a porous, inorganic partition the phenomena of osmosis are entirely governed by capillarity and the laws of diffusion of liquids. Certain liquids have a greater tendency to enter capillary tubes than others. When, therefore, two miscible liquids are separated by a porous solid, which may be regarded as a collection of capillary tubes, the liquid which has the greater affinity for the walls of the tube will enter to a greater extent than the other, and will meet the other fluid advancing in the opposite direction, but with less force on account of its lesser affinity. The two liquids thus coming into contact with each other will diffuse into each other, and the pores will be occupied with a mixture of two liquids, for one of which the walls of the tube will have a greater affinity than for the other. Then, although diffusion will take place from this mixture into the liquid of greater affinity, the latter continually forcing out some of the mixture, the liquid of lesser affinity will continually increase in volume.

In the case of organic membranes, the power possessed by the membrane of imbibing different liquids enables osmosis to take place, while the direction of the current is governed by the affinity of the liquids for the membrane. Whichever liquid has the greater affinity for the membrane will pass in greatest amount. Here, for the sake of simplifying the matter, we may assume that the liquid which has entered the intermolecular spaces of the membrane is, to a certain extent, governed by the same conditions which apply to the entrance of liquids into capillary tubes.

When an organic tissue has absorbed liquid by imbibition, its intermolecular spaces being filled with that liquid, the liquid, which becomes superficial on the far side of the membrane, is in direct continuity with the body of the liquid having the greater affinity for the membrane, and in direct contact with the liquid of lesser affinity. Diffusion phenomena therefore commence.

When a membrane has a tendency to imbibe water, it will absorb more water than salt solution, if placed between water and a salt solution, and will increase in volume. In every pore or intermolecular space of the membrane, therefore, the layer of liquid in contact with the sides of the pores, or with the solid molecules, will contain less salt than water.

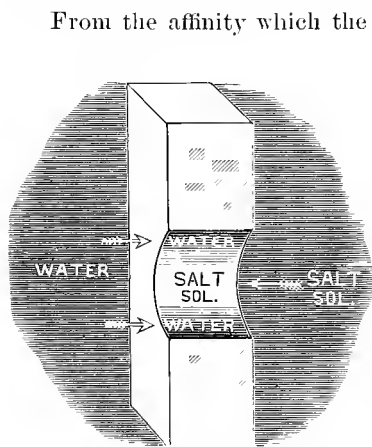

FIG. 39.—DIAGRAM ILLUSTRATING OSMOSIS.

This figure represents a diagrammatic section of a single, capillary pore in an organic membrane separating salt solution and water. From the greater affinity of the membrane for water than for salt solution, the former passes in a layer in contact with the circumference of the tube, while the salt solution passes only in the centre of the tube. Therefore, more water than salt solution will traverse the membrane.

Therefore, the greater the concentration of the salt solution the higher will be the osmotic equivalent, since the difference of affinity of the membrane for the water as compared with the salt solution will be the more marked. This, however, only applies to salts whose solutions are also imbibed by the membrane; where this is not the case increased concentration produces a decrease in the osmotic equivalent, for in the latter case there will be more tendency for the membrane to hold the layer of water in contact with the walls of its pores.

Different membranes will consequently modify the osmotic exchange of liquids taking place through them.

From the affinity which the two liquids exert on one another this condition will not remain constant, and the rapidity with which the interchange takes place will depend upon the affinity of the two liquids for one another; but the interchange will not occur in the same manner as if no membrane were present, *i.e.*, equal quantities of salt solution and water will not substitute one another. Such an interchange will only occur in the centre of the pore, while on the wall of the pores only water will pass; consequently the salt solution will increase in volume and the water will diminish correspondingly, while the rapidity of motion along the walls will be less than in the centre of the pores on account of the attraction of the walls for the water.

Thus, dry membrane will show a higher osmotic equivalent than fresh membranes or dried membranes moistened, from the fact that the membrane retains more water by imbibition, while the passage of the salt is facilitated.

If an animal membrane separates water and alcohol, the water will pass in much greater amount, for membrane absorbs water much more readily than alcohol or a mixture of water and alcohol.

Rubber or collodium membranes, on the other hand, allow alcohol to pass with greatest readiness, as such membranes absorb alcohol more readily than water.

The general phenomena of osmosis may be well illustrated by the *egg-osmometer* (Fig. 40). This is prepared by picking off a little of the shell from one end of an egg, taking care to leave the shell-membrane intact, while a glass tube is cemented around a small hole pierced through both shell and shell-membrane at the opposite end. The end at which the shell has been removed and the membrane left undisturbed is then immersed in distilled water. After a time it will be found that water has passed from the outside to the interior of the egg, as shown by the increased volume, the white of the egg being forced up into the tube cemented on the open end of the egg. At the same time the addition of nitrate of silver to the water in which the egg was immersed will show, by the white precipitate formed, that the chlorides have passed from the inside to the outside of the egg. No trace of albumen, however, is to be seen in the distilled water. The salts of the egg, or its crystalloids, have thus passed by osmosis through the egg-membrane, water has also passed, while the egg-albumen, a colloid, has been retained.

These facts, already alluded to, that crystalloids in solution will pass through an animal membrane, while colloids will not, has been made use of in a process which is frequently employed by the chemist to separate bodies of these two classes. Thus, albumen, or any other colloid, may be entirely freed from crystalloids, such as salt or sugar, by placing it on one side of a membrane with a large quantity of distilled water, which is frequently renewed, on the other. The salts pass through the membrane to the water, their place being taken by water, while the albumen, with the exception of becoming more diluted, remains unchanged. This process is termed *dialysis*.

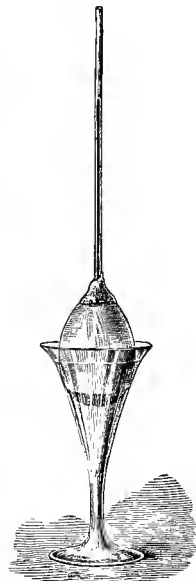

FIG. 40.—EGG PREPARED SO AS TO ILLUSTRATE OSMOTIC ACTION. (Fintl.)

Osmotic phenomena, consequently, may be referred to the following causes (Wundt):—

1. The affinity which the two liquids exert on one another.
2. The relative affinity which the membrane exerts on the two liquids.
3. On the narrowness of the pores through which the liquids diffuse.
4. On the overcoming of the adhesion of the liquids to the walls of the pores through increase of temperature.

The importance of this process in the action of the animal organism is very evident. Nearly all animal tissues are, during their entire life, in

a state of tension from imbibition (swollen); therefore, all tissues permit the entrance of watery and saline solutions, and prevent entrance of liquids not miscible with water. The absorption of most of the dissolved food-stuffs, and the removal of deleterious matters, etc., by the glands from the blood rest on osmotic processes. The results as to the different osmotic equivalent of different substances; the behavior of different membranes to diffusion; the different capability of animal matter for imbibing different solutions, all point to the way in which the glands remove different substances from the blood where no other explanation can be found but a membrane and cells capable of absorbing certain solutions. The presence of certain salts in the contents of certain cells is without doubt instrumental in shaping the capability of those cells for absorbing definite solutions.

9. DIFFUSION OF GASES.—In the living organism, in the cell, the vital activities are only carried on when there is an unbroken supply of oxygen conveyed to the cells either in the form of a free gas or in hæmoglobin. And, on the other hand, the organism cannot exist unless there is some provision made for the removal of  $\text{CO}_2$ , continually formed in physiological oxidation, and which itself is a deadly poison to cell activity. These two gases are, therefore, the most important which have to be considered.

In pulmonated, air-breathing animals there is also a continual exhalation of watery vapor; there is also a continual circulation of N in the lungs of animals, as N forms four-fifths of the atmosphere.

Gaseous interchange in the organism rests mainly on the laws of diffusion and absorption of gases, though these laws are subject to some slight modification as contrasted with their application to inorganic matter.

By gaseous diffusion is meant the mutual mixing of two or more free gases; and, as in liquid diffusion, it results in a uniform mixture.

Gases which pass into a vacuum fill it completely and uniformly; this is also the case when the space into which a gas streams is already occupied by a gas which is chemically indifferent to the first; a space filled with an indifferent gas behaves to another gas precisely like a vacuum.

If two flasks, each provided with a stop-cock, are connected, one vertically above the other, and the upper one filled with hydrogen, the lightest of gases, and the lower one with carbon dioxide, a heavy gas, if the stop-cocks are now opened, in a short time it will be found that half of the hydrogen, in spite of its lighter specific gravity, has descended into the lower flask, while half of the carbon dioxide has ascended against gravity into the upper flask, so that each flask will contain a uniform mixture of the two gases (Fig. 41). Each gas has diffused into the other as into a vacuum, and what holds for the diffusion of two

gases applies also to the diffusion of several gases; so that the general rule may be formulated: If a number of gases exerting no chemical influence on each other are allowed to enter a space, each gas will diffuse itself uniformly through that space.

If the amount of gas in any given space is small or large, or, in other words, no matter what the gaseous pressure may be, another gas will enter that space precisely as if it were a vacuum.

The importance of these laws in explaining the mechanism of gaseous interchange in respiration is very evident. The atmosphere is composed of a mechanical mixture of about  $\frac{4}{5}$  nitrogen and  $\frac{1}{5}$  oxygen. In the process of inspiration a variable amount of this gaseous mixture is drawn into the lungs. It then meets with a gaseous mixture which contains less oxygen than the atmosphere (for a certain amount of the oxygen taken in in previous inspirations has been removed by the blood), and which contains a considerable volume of carbon dioxide removed from the blood.

Phenomena of diffusion, therefore, at once commence between the air already in the lungs and that which has entered in inspiration. The air in the lungs becomes gradually poorer in oxygen and richer in carbon dioxide, as the air-cells are approached. Diffusion tends to equalize this difference; the oxygen of the inspired air diffuses into the deeper portions of the lungs, the carbon dioxide diffuses from the deeper to the upper portion, the process being a constant one; for the difference in the relative volumes of the two gases in the upper air-passages is maintained by repeated expirations, by which  $\text{CO}_2$  is removed, and inspirations, by which more oxygen is brought into the lungs.

The  $\text{CO}_2$  formed in respiration by animal organisms, and thus removed from them in respiration, distributes itself uniformly through the atmosphere, so that there is everywhere a uniform percentage, unless there is a local temporary increase; but then this soon becomes equalized by diffusion, permanent increase being prevented by the absorption processes in the vegetable kingdom.

The tension of O in the atmosphere is far greater than that of  $\text{CO}_2$ , as the O is present in far larger proportion, and conversely.

Diffusion leads finally to the theoretical result, that all gases in any given space, as in the atmosphere, exist under the same pressure; when, therefore, there is anywhere a temporary increase in the tension of a gas, diffusion commences and tends to continue until there is a uniform distribution and mixing of the different gases.

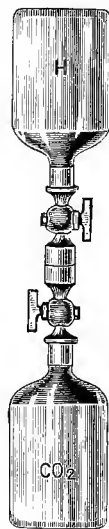

FIG. 41.

If two different gases are separated by a porous partition, the gases will mix through that partition. The phenomena under such circumstances are similar to what has been described in the case of liquids under osmosis; that is, that different gases pass with different degrees of rapidity through the partition, so that the volume of gas increases on one side of the partition and decreases on the other. If an unglazed, porous, earthenware cup (such as is used in a Grove battery) is closed with a cork through which passes a long, vertical, glass tube, whose end dips into a vessel below containing water, and the cup is covered with a bell-jar containing hydrogen or illuminating gas, the hydrogen will pass through the walls of the cup to the inside faster than the air from the inside can diffuse out. The volume of gas in the interior increasing, bubbles of air will escape through the water from the end of the tube.



FIG. 42.

If now the bell-jar be removed the hydrogen will diffuse out from the cup faster than the air can enter, the volume of gas within the cup will decrease and the water will rise, from atmospheric pressure, within the tube. If oxygen be used within the cup instead of atmospheric air, it will be found that the hydrogen will diffuse four times as fast as the oxygen. The density of hydrogen is 1.; that of oxygen 16.; therefore, the law has been made that the rapidity with which different gases under similar conditions (equal pressures) diffuse through thin, porous partitions into a vacuum or into other gases is in inverse proportion to the square root of the density of the gases (Graham's law).

These general facts may be illustrated by another very simple experiment. If an unglazed earthenware cup be closed by a cork in which a water-manometer is inserted and then placed in a larger glass vessel containing vapor of ether, the air from the inside of the cup will diffuse out faster than the five-times-heavier vapor of ether will diffuse in, and the water in the open arm of the manometer will sink (Fig. 42).

There is, however, here a marked difference from osmosis, for in the diffusion of gases through inorganic partitions or dry organic membranes the nature of the partition is without influence on the rapidity of diffusion. The rapidity of diffusion depends only on the specific gravity of the gas.

10. ABSORPTION OF GASES.—Exactly as gases diffuse into spaces already occupied by other gases, so also will they diffuse into the intermolecular spaces of liquids, without any chemical attraction between the gas and the fluid being essential. If a glass tube, closed at one end, is filled with dry, ammoniacal gas, its open end immersed in mercury, and

then a small quantity of water introduced into the tube, the water will almost instantly absorb the gas, which will entirely disappear, and the mercury will rise in the tube, and, with the water, entirely fill it.

Just as without so also within liquids, gases exert no pressure on each other; so that a number of gases may diffuse at the same time into any given liquid.

We meet, in this solution of gases in liquids, with laws analogous to those which govern the solution of solids in liquids. Every liquid absorbs at any given temperature a fixed quantity of any given gas, just as a certain quantity of liquid will only dissolve a given quantity of a salt. The volumes which a given liquid at a fixed temperature will absorb of different gases are very different, the most readily-liquefied gases being most readily absorbed. The volume of any gas that may be absorbed by a liquid varies greatly with the temperature. As the temperature increases capability of absorption decreases, until at  $100^{\circ}$  C. water absorbs no gas at all. The exact opposite holds in the case of solutions.

The *co-efficient of absorption* is the volume of gas which a liquid in free communication with a gas can absorb. It varies with every liquid, every gas, and every temperature. According to Bunsen, a unit of volume of water absorbs—

Gas.	Temperature.	Volume.
CO <sub>2</sub>	{ 0°	1.7967
	{ 20°	.9046
N	{ 0°	0.02034
	{ 20°	0.01401
O	{ 0°	0.04114
	{ 20°	0.02838
H	0°	0.0163

With every increase of pressure the liquid will absorb uniformly-increased amounts of gas.

Gases absorbed by liquids do not lose their power of diffusion. Hence, if we bring a liquid which contains a gas under a definite tension, *e.g.*, H<sub>2</sub>O with CO<sub>2</sub>, in communication with a space containing another gas, H, the CO<sub>2</sub> diffuses out of the H<sub>2</sub>O into the space containing the H. CO<sub>2</sub> will continue to leave the water until it exists in equal pressure without and within the liquid; so, also, H will diffuse into the water until it has a uniform tension without and within the liquid. An absorbed gas is therefore given up when the tension of the gas is less in the space in communication with the liquid than the tension of the gas in the liquid. When two or more gases are mixed together their absorption by a liquid is proportional to the relative volumes of the gases present in the mixture, or to the different gaseous tensions.

In the cell in the animal organism this gaseous interchange occurs

through the cell-wall or the walls of capillaries, etc. These organic tissues, which we have seen to be always filled with liquid, offer very little resistance to the passage of a gas. The animal fluids communicate through these delicate moist tissues almost directly with the gases of the atmosphere.

Gases formed by cells, or gases which pass from the exterior to the interior of cells, or even the passage of gases through the membranes of the lungs or gills of animals, are not governed by the law of the diffusion of gases given above, but their transfer through an animal membrane is governed by the co-efficient of absorption of that tissue for the different gases. This may be illustrated by a very simple experiment devised by Draper, who does not appear, however, to have appreciated its application to gaseous interchange in the animal body. The law of the diffusion of gases through porous partitions is that the rapidity of the diffusion is inversely as the square root of the density of the gas. If the finger be dipped in soap-water and then rapidly passed over the mouth of an empty bottle so as to leave a horizontal film, and the bottle then placed under a bell-jar filled with carbon dioxide, the film soon swells up into an almost hemispherical dome. Or, if the bottle be filled with carbon dioxide, and then exposed to the atmosphere after its mouth has been covered with a soap-film as before, the film is promptly depressed into a deep concavity and bursts. Now, if the film is regarded as a porous partition, the air, being of many times less density than the  $\text{CO}_2$ , should diffuse much more rapidly, according to Graham's law. The reverse, however, is the case. Water, however, of which the film consists, has a much higher co-efficient of absorption for  $\text{CO}_2$  than it has for oxygen or nitrogen. The  $\text{CO}_2$  is therefore absorbed more rapidly by the film than the gases of the atmosphere, and from its solution in the film diffuses rapidly into the atmosphere. The state of affairs is similar in the case of gaseous interchange in animal cells.

The membranes of cell are not porous partitions, but are tissues whose molecular interspaces are filled with liquids. That a gas may pass through such a membrane it is necessary, therefore, that the gas be first absorbed by the liquid in the cell-membrane. The readily-absorbed gases, such as  $\text{CO}_2$ , will thus diffuse through cell-membranes more rapidly than those with a lower co-efficient of absorption, such as N, H, or O, the rapidity of absorption being further governed, not only by the co-efficient of absorption, but by the gaseous tension and the temperature. After having passed through the cell-membrane gases will, of course, diffuse into the liquid or gaseous media surrounding those cells, according to the tension of those gases already present.

In the case of terrestrial animals this medium is the atmosphere, which is composed of 21-volume per cent. of O and 79 per cent. of N,



with traces of  $\text{CO}_2$ . If we imagine in the first place that the tissues are at first free from gas, according to the co-efficients of absorption and pressure, they will absorb definite volumes of these gases.

If we assume that the co-efficient of absorption of the animal liquids for these gases is the same as water, as is actually nearly the case, the co-efficient of absorption for O will be nearly double that of N, and the volumes absorbed will be as 34.91 to 65.09. This is actually the case in large bodies of water, as lakes, etc.

Under the conditions we have imagined, of course, only a trace of  $\text{CO}_2$  would be absorbed. We know, however, that  $\text{CO}_2$  is a constant result of cell life; therefore the tension of  $\text{CO}_2$  in animal fluids is far in excess of that in the atmosphere; consequently, instead of an absorption of  $\text{CO}_2$  by the tissues from the air, we will have an exhalation taking place. Similar conditions apply in the case of watery vapor.

Hence, the gaseous interchanges between the organism and the atmosphere under the laws of absorption and diffusion are as follow:—

Absorption of O and N.  
Exhalation of  $\text{CO}_2$  and  $\text{H}_2\text{O}$  vapor.

In animals, however, by far the greater part of O and  $\text{CO}_2$  are carried in chemical combination with hæmoglobin, and not in mere solution in the fluids of the body. These conditions, as well as the mechanism of gaseous interchange in the lungs and tissues, will be considered in greater detail under the subject of *Respiration*. At present enough has been said to show that the laws of diffusion and absorption are the fundamental principles which underlie these processes.

## II. THE PHYSICAL PROPERTIES OF TISSUES.

We have found that the different animal tissues furnish illustrations of both the solid and liquid forms of matter, varying from a perfect fluid to a solid of almost mineral consistence, and that midway between these extremes what may be termed the semi-fluid tissues are of the greatest importance in the physical and chemical operations of the organism. We know, further, from analysis of the organic tissues, that, no matter what their consistence, they all contain a large proportion of water in their composition; it is to the amount and the manner in which this water is held by the tissues that nearly all the physical properties of the tissues, particularly of the semi-solid tissues, are due.

We have already seen that in inorganic bodies, though they may be rich in water, the water is either chemically united to that body, or is held mechanically in capillary pores; while in organic matter the water occupies the intermolecular spaces. The tissues, therefore, resemble solutions in this respect; thus, in a salt solution the water occupies the

intermolecular spaces of the salt. In solutions, however, the solids are bound to the water; in tissues, the reverse.

Since all fresh, organic tissues contain water, their specific gravity must be comparatively low; drying, by driving off the water, while decreasing their weight by the amount of water displaced, will increase their specific gravity, though even then, like all organic bodies, they will be specifically lighter than most minerals. The specific gravity of different tissues will also vary according to the nature of their special constituents; thus, adipose tissue will represent one extreme, bones and teeth the other, and tissues which are rich in fat, like the nervous tissues, will be of less specific gravity than those which contain inorganic matters.

As the specific gravity of the tissues depends upon their constituents, it will vary according to the relative proportions of those constituents at different ages, in different individuals, and in different nutritive states. No fixed figures can, therefore, be given to represent the specific gravity of the different tissues, but, though not constant, the following represents the average specific gravity of the most important tissues of the human body:—

Bones, . . . . .	1.656
Elastic tissue and tendons, . . . . .	1.12
Muscles, . . . . .	1.073
Arteries, . . . . .	1.096
Veins, . . . . .	1.05
Nerves, . . . . .	1.046

1. COHESION.—It follows from what has been said as to the freedom of molecular movement in most organic tissues, as shown in their capability of imbibition, that their cohesion must be less than that of most inorganic solids. It is highest in the bones, lowest in glands and brain, though it is comparatively high in nerves. Cohesion is there due to the fibrous envelope (neurilemma) and not to the nerve-fibre; and as these sheaths relatively increase as the nerve-trunks subdivide, the cohesion of the fine nervous twigs of the skin is relatively higher than that of the nerve-trunks.

The greater the amount of water contained in a tissue the less its cohesion, for the wider apart will be the molecules, and the molecular attraction decreases as the square of the distance which separates them. Consequently desiccation increases cohesion. The order of cohesiveness is inversely as the quantity of water; thus, the following list is arranged with tissues of greatest cohesion and least water first, and as water increases cohesion decreases:—

- |             |              |                |
|-------------|--------------|----------------|
| 1. Bones.   | 4. Muscles.  | 7. Intestines. |
| 2. Tendons. | 5. Veins.    | 8. Glands.     |
| 3. Nerves.  | 6. Arteries. | 9. Brain.      |

In youth the tissues have less cohesion than in adult life, from the greater preponderance in the former period of water; while the cohesion again declines in old age, especially in bone and muscle, even though the proportion of water present also diminishes, from changes in the quantity of inorganic elements.

The cohesion of any tissue is not uniform in all directions, but, as is well known, certain tissues may be ruptured in one direction more readily than in another; thus, a costal cartilage is more readily broken transversely than longitudinally. This is even more marked in fibrous tissues, such as a tendon, where it is much easier to separate the longitudinal fibres than it is to rupture them by traction. This may be explained by the fact that the cohesion of any tissue is the resultant of the forces which holds the ultimate molecule of the tissues together, as in a single fibre of connective tissue, and of the adhesive force, which through the mediation, ordinarily of cement substance, holds several collections of similar molecules together.

The forces which may act on a tissue to destroy its cohesion may operate in four different ways: by traction, by pressure, by flexion, and by torsion. All the different tissues behave differently to each of these modes of action.

The resistance to *traction* is measured by the force required to tear apart the molecules of any tissue; hence, the force required to produce tearing in any tissue must increase with the cross-section of the tissue subjected to strain, and when the cohesion of two different tissues is compared in this respect the comparison must always be reduced to a unit of cross-section. Thus, in the following table the numbers represent the breaking weight in kilogrammes for every square millimeter of surface (Wertheim):—

Bones,	7.76
Tendons,	6.94
Muscles,	0.054
Nerves,	0.93
Arteries,	0.16
Veins,	0.12

This resistance to traction is of great importance in the mechanics of the organism. The cohesion of the bones, tendons, ligaments, and muscles permits of the accomplishment of mechanical work, while the resistance to distension of the different membranes of the body, such as the aponeuroses, fibrous membranes, etc., is of great value in numerous physiological operations.

The resistance to *pressure* is especially seen in the bony skeleton, articular cartilage, and intervertebral disks. In the bones this is especially very marked. Thus, it has been found that from 1110 to 2300 kilo were required to crush a cube of bone from the compact substance of the

bones of the extremity 5 millimeters thick, while only 100 kilo were required to crush a cube of the same size from the spongy substance. The cohesion of the compact substance measured in this way decreases to about the same degree when either the organic matter or the lime salts are removed; it also decreases greatly when the water is removed, showing a deviation from the general statement above made. This resistance to pressure plays an important rôle in the support of the body in standing, walking, and jumping, and in the protection from injury of such important organs as the brain, spinal cord, lungs, and heart.

The resistance to pressure in the osseous system decreases with age. Thus, Fick has found that a prism of bone 1 square millimeter in size from a man 30 years of age was crushed by a weight of 15.03 kilo, while a similar piece from a man aged 74 years would not sustain a weight of 4.33 kilo. The bones of different animals also show great differences in their resistance to pressure.

The resistance to *flexion* and *torsion* possessed by the different tissues of the body also comes into play in certain physiological operations. Thus, in inspiration the ribs and costal cartilages undergo a slight amount of twisting and bending through the action of the inspiratory muscles, and regain their position during expiration. So, when a weight is lifted and held horizontal by the hand the resistance to flexion prevents bending of the bones of the arm.

The cohesion of the tissues is always greatest in the direction in which the forces which act on those tissues is usually exerted. Thus, when tissues are ordinarily subjected to the force of traction, their cohesive force is most developed in a longitudinal direction, and such tissues, like tendons and ligaments, are fibrous in structure. When the pressure or force to which tissues may normally be subjected does not lie in any one but in many different directions, as in the resistance which serous membranes and aponeuroses offer to distension, such membranes are also fibrous in structure; but the fibres, instead of being parallel to each other as in tendons, in which traction is the only force to which they are subjected, are interlacing and cross each other in every direction. Finally, when pressure is the force which must be resisted, we find the tissues taking the form in which such resistance may be best offered; the compact bony tissues are therefore arranged in arches, as in the head of the femur, or in the form of hollow tubes, as in the shafts of the long bones,—two forms which, with the greatest economy of material, offer the greatest resistance to pressure. In the case of the femur its upper end is not only subjected to pressure from the weight of the body, but also to flexion; for the head of the femur is not in a line with the long axis of the bone, but lies to one side and is connected with the shaft of the bone by an oblique neck. The

arrangement of the compact substance of the bone is especially fitted to overcome these direct or indirect pressures (Fig. 43).

2. ELASTICITY.—The elasticity of the tissues varies in the same way as their cohesion. The moist tissues have, as a rule, a very slight elasticity; that is, they offer slight resistance to external forces which tend to change their form, and in most of the tissues which are rich in water, as the brain and glands, the elasticity is incomplete; that is, the original form is not regained after the distorting force ceases to act. On the other hand, in the elastic tissues and muscles the force must be excessive to produce permanent distortion.

The cohesion of a body is its resistance to tearing forces; elasticity is developed as resistance to alteration in form, and refers to the property by which the original form is regained. The elasticity of a body is therefore great when a great force is required to produce change in form, and *vice versa*; while the completeness of the elasticity is expressed by the perfection with which the original form is regained after the distorting force ceases to act. Thus, the elasticity of lead is great but incomplete; of rubber, is small but perfect.

Elasticity cannot be measured by stretching force alone, but compressing, twisting, and bending forces must also be considered. The resistance to each of these forces is the same. The less extensible a body is, the less compressible is it also, and the more rapidly it vibrates when bent from its position of equilibrium.

Organic tissues which are poor in water, as wood and bone, and which possess high elasticity, behave to stretching weights like inorganic bodies, *i. e.*, the increase in length is proportionate to the weight. In the soft tissues, of less but more complete elasticity, the increase in length produced by heavy weights is proportionately less than that due to smaller weights. The cause of this lies in the greater extensibility of such tissues, through which they are more stretched by small weights than is possible in rigid bodies. because in the latter a much smaller extension would exceed the limit of cohesion; though the use of weights of very great difference shows that the extensibility of rigid bodies is probably also governed by the same laws.

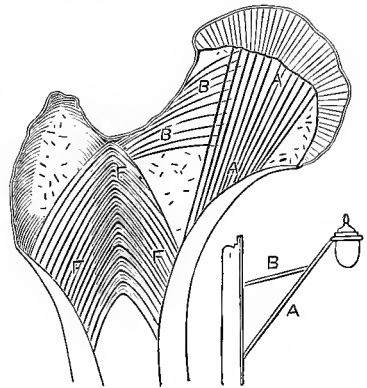

FIG. 43.—DIAGRAM OF THE STRUCTURE OF THE NECK OF THE HUMAN FEMUR. (Ward.)

The fibres, A, by their rigidity, and the fibres, B, by their tenacity, tend to the support of the weight, as illustrated in the bracket, while the latter fibres interlace with the arciform fibres, F.

The laws for elastic changes in form of all bodies, including the soft organic tissues, is expressed in the diagram given below (Fig. 44).

The spaces on the line A B represent the extending weights. The spaces on the line B C represent the increase in length. Thus, if the extension of any given tissue by any given weight equal the ordinate, A D, the increase in extending weight by regularly increasing amounts will not produce a proportional increase in length. Each increase will be less than that produced by the previous lesser extending weight, and the line which connects the limits of extension will be a curve which gradually tends to form a horizontal line,—in other words, a hyperbola. In a corresponding figure, representing the extension of an inorganic body, the line D C, instead of being a curve, would be a straight line, and the spaces on the line B C from B to C would be equal, showing that the extension increases regularly with uniform increase in extending weight,

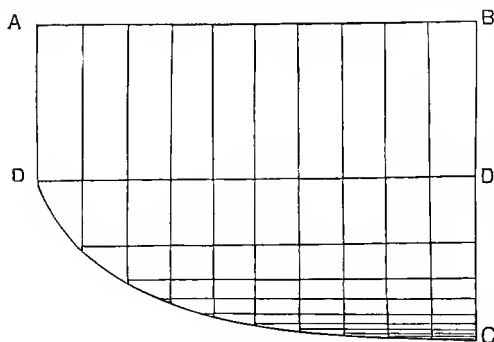

FIG. 44.

with the exception above alluded to, when very great difference in extending weights is made use of. This difference between organic and inorganic bodies is, without doubt, attributable to the greater extensibility of the former.

The organic tissues have still another characteristic which distinguishes them from the inorganic bodies, viz., when a tissue has been extended by a weight, if the weight is allowed to remain the extension gradually increases, and may not be complete for days or months; this is called elastic after-working. It is present in all elastic bodies, though in rigid bodies it is much less marked, and its limit is sooner reached.

The weight which will stretch a prism one square millimeter in area and one meter long one meter, provided the limit of cohesion is not thereby passed, is called the co-efficient of elasticity.

The following figures, according to Wundt, give the co-efficients of elasticity of some of the more important organic tissues:—

Bones, . . . . .	2264.
Tendons, . . . . .	1.6693
Nerves, . . . . .	1.0905
Muscles, . . . . .	0.2734
Arteries, . . . . .	0.0726

The smallness of these co-efficients is recognized when it is remembered that for cast-steel it is 19881.

Elasticity is a property of the tissues of the animal body which is of great importance in many physiological operations. It is a force which acts either against constant forces, such as gravity, or temporary forces, such as muscular action. Thus, the intervertebral disks, through their elasticity, serve to deaden the shock given to the spinal column in jumping; the elastic ligaments of the spinal column serve to preserve it in its normal position without there being a constant strain on the muscles, and in animals in whom the backbone is horizontal it serves to counteract the weight of the abdominal viscera. In the herbivorous animals the yellow elastic tissue of the ligamentum nuchæ serves to assist the muscles in supporting the head.

In expiration the elasticity of the costal cartilages and ribs, together with that of the lungs,—forces which have to be overcome in inspiration,—tend to restore the thorax to its natural form, and thus drive the air out of the lungs.

The elastic tissue of the arteries tends to aid the intermittent propelling force of the heart in producing a constant forward motion of the blood. When the heart contracts it drives a definite quantity of blood into the arterial system, already filled with blood, and thus still further distends the arteries. During the pauses between the contractions of the ventricles the elastic tissue recoils, from the removal of the distending force, on the contents of the blood-vessels, and, backward motion being prevented by the closure of the semi-lunar valves, drives the current of blood forward in the vessels. This point will again be alluded to in more detail under the subject of the *Circulation*.

In addition to these properties most of the tissues of the animal body are also *flexible* and *extensible*, the degree varying greatly according to the structure of the parts. Flexibility and extensibility must not be confounded. Flexibility means capability of being bent or twisted; extensibility means capability of being increased in length. Thus, the tendons are flexible, but not extensible; were they capable of being increased in length it would be at the expense of the force developed by muscles. Tendons are, however, very flexible; they adjust themselves to the position the part may occupy, so that sometimes they transmit muscular force at right angles to the line in which the muscle acts. Ligaments, again, are flexible, and also somewhat more extensible than tendons. In joints they permit of the free play of one bony surface on the other, and yet by their inextensibility serve to keep the articular surfaces in apposition. In dislocations the articular ligaments are rent, and the bony articular surfaces are no longer in contact: in sprains the limit of elasticity of the ligaments has been passed; that is, they have been stretched beyond the point at which their elasticity enables them to regain their original form, and partial ruptures take place.

All the connective tissues are originally flexible and extensible; these properties become greatly modified in the subsequent development of the tissues of this group. Thus, in cartilage and bone, extensibility has very largely disappeared, especially in the latter, but they are of high elasticity. In dense fibrous tissue, such as aponeuroses, flexibility remains, but extensibility has become greatly reduced; hence the intense pain produced in inflammation below such tissues; for being inextensible swelling is restrained, and the pressure produced by the products of inflammation on the nerve-endings is greatly increased.

3. OPTICAL CHARACTERISTICS OF TISSUES (Wundt).—(a) *Refraction*.—All organic tissues possess a higher refractive index than water. By this is meant that when a ray of light passes obliquely out of one medium into another of different density, it is bent out of its path in a straight line at the surface of separation of the two media, the ratio between the angle of incidence and the angle of refraction being the index of refraction. Though comparative measurements of the different tissues have not been made, we can recognize the difference by the sharpness of outline in microscopic examination. Thus, cell-wall, nucleus, and nucleolus are recognized by their difference in refractive powers. When two tissues have the same refractive power they cannot be distinguished by the eye, and if no refractive power is possessed they are homogeneous.

Fat, elastic tissue, and horn have the highest refractive power. Watery solutions, as in the vacuoles of plant-cells and in secretions, have least refractive power. Albuminous matters, gelatin-giving intercellular substance, and mucin have about the same refractive index.

(b) *Power of Absorbing Colors*.—In very thin sections most vegetable and animal tissues appear colorless. In thick sections, when examined by transmitted light, the different colors are absorbed in different degrees. Vegetable tissues absorb the most refractive rays; therefore, in sections of increasing thickness they appear at first yellow and then red. The same rule applies to animal tissues, even when freed from blood, *e.g.*, epithelium and cartilage. Many tissues owe their color to deposits in them of special coloring matters. When this is intense many rays of light are entirely extinguished, and in the spectra of such bodies portions of the spectrum are either entirely absent or dark absorption-bands appear in different parts of the spectrum.

The points of occurrence of these absorption-bands are definite and characteristic for each different substance. The spectra of certain bodies of physiological importance, such as the blood, biliary coloring matters, etc., will be referred to under their appropriate headings in the sections on Special Physiology.

(c) *Double Refraction*.—A large number of bodies of crystalline structure have the property of splitting a single incident ray of light pass-



ing through them into two rays; hence, when an object is seen through such a crystal it appears double, the bifurcation of the ray of light being spoken of as *double refraction*.

Many of the animal tissues are doubly refractive, though this property is weaker in fresh tissue than after drying. Double refraction is only faintly developed in connective tissue, especially in its youngest stages. Elastic tissue is more highly doubly refractive, as are also cartilage, bone, nerves, muscles, nails, and hair.

Double refraction permits the recognition of the molecular structure of organized tissues. A body whose molecules in all directions are arranged in the same manner produces only single refraction; one whose molecules are arranged in different directions in different proportions produces double refraction, *i.e.*, splits the ray of light into two rays, which are polarized perpendicularly to one another, and whose vibrations are therefore in two planes perpendicular to one another. Simple glass is a single refractive medium, but if compressed or stretched in one direction it becomes doubly refractive. The double refractive body can either, as in the last example, refract the ray more or less in one direction than in the direction perpendicular to it, or the light can be transmitted in three perpendicular directions with different velocities. In the inorganic world crystals furnish examples of all three cases.

Crystals of the regular system (tesseral) are isotropic (singly refractive). In tetragonal and hexagonal forms, which possess an unequal axis and two or three perpendicular equal axes, the refraction is either greater (positive) or less (negative) in the direction of the unequal axis, and such bodies are said to have a single optic axis. Other crystalline forms have three axes, characterized by the transmission of light with different velocities. They have two optic axes not coinciding with the axes of crystallization.

In organized bodies all of the above cases are also met with. Most mature tissues are doubly refractive. The optic characteristics are not, however, changed by pressure or stretching.

We must conclude from this that the doubly-refractive tissue-molecule is suspended in a singly-refractive medium, and that this molecule is unaffected in pressure or stretching just as it remains unaffected in imbibition. Organic tissues are therefore analogous to crystals in their molecular arrangement; and this view is strengthened by the fact that many organic substances which are apparently anything but crystalline in their structure, such as albumen, gluten, and chondrin, possess the power of rotating the plane of polarized light.

The most important examples of double refractive power are seen in the muscles and nerves. These will be considered under their special headings.

4. ELECTRICAL PHENOMENA.—Electrical phenomena may occur in animal and vegetable tissues under various conditions.

Frictional electricity occurs when dry epidermal tissues (hair, outer epidermis) and other bodies of rough surface are rubbed together, as on the skin and clothing. It has no physiological significance.

Currents produced by chemical differences in tissues may be seen in plants when a point of the exposed interior is connected with a point of the external surface, the internal section being negative to the exterior. Such currents probably only exist when contact by conductors is made between these two surfaces.

In certain animal and vegetable tissues there appear to be elementary parts, which are actively efficient in developing an electrical current. Among such phenomena belong the electrical phenomena observed in certain plants, as the *Dionæa muscipula*; in certain animals, as the torpedo and electric eel, and in the currents developed in muscles and nerves of all animals. The latter will receive consideration under the subjects of Nerve and Muscle.

### III. MECHANICAL MOVEMENTS IN CELLS.

It has been seen that the processes by which cells absorb and give up liquids and gases are reducible to purely physical laws. We have further alluded to the fact that the characteristics of the nutritive processes in animal as distinguished from vegetable cells is the reduction of complex organic compounds in the former to simple, inorganic substances; while in the vegetable cell, simple, inorganic, elementary compounds are built up into complex organic matter. In vegetable cells force is, therefore, rendered latent; in animal cells force is liberated.

In the animal cell this liberation of energy may take on the form of animal movements from the contractility of protoplasm; or it may result in the development of heat or of electricity. The consideration of the processes which lead to this liberation of energy will be deferred until after the chemical constituents of cells have been discussed, while heat-formation and the development of electricity will be studied under their appropriate headings in Special Physiology.

The movements seen in animal and vegetable organisms may be the result of external causes, such as friction, heat, or chemical action, or they may be apparently spontaneous.

Two classes of movement may be distinguished:—

1. Those which are produced by varying tension in the cell-membrane, from varying degrees of imbibition of the cell-contents.
2. Those which are peculiarly protoplasmic in nature.

1. MOTION PRODUCED BY IMBIBITION IN CELLS.—The first of these is especially illustrated by many of the forms of motion which occur in the

vegetable kingdom, such as the turning of leaves toward or away from the light, the regular motion of certain algæ, such as diatoms, desmidia, oscillatoria, as well as the irritative motions of certain plants, such as the sensitive plant (*Mimosa pudica*), or the Venus' Fly-Trap (*Dionæa muscipula*); all of these motions depend upon a change in the physical state of imbibition of certain cells. In the *Mimosa pudica*, the plant in which motion is most marked, and apparently most closely analogous to that occurring in the animal kingdom, motion of three different parts may be recognized.

While at rest during the day-time the leaf-stems of the sensitive plant form an acute angle with the main stem, the secondary leaf-stems diverge, and the leaves are opened out so that they form a plane surface. When evening comes the leaf-stem sinks downward, the leaves approach each other, as when the fingers of the open hand are adducted to the middle finger, and the leaflets themselves close up so that the surfaces which during the day-time are the uppermost now come in contact with each other. If the entire plant is shaken the same changes occur as have been just described to take place during the night; or if the under part of any one of the leaf-stems is gently touched, the closing motion is localized in that part of the plant. If, however, the upper portion of the leaf is touched, no change is produced in the position of the leaves or of the stem. The under part of the leaf-stem is seen to be cylindrical in shape, and this represents the sensitive portion of the plant.

Brücke, to whom we are indebted for the explanation of the mechanism of this movement, has found that this cylindrical structure which underlies the leaf-stem is composed of a bundle of vessels running through the centre, and between it and the outer green bark there is a layer of very succulent cells, which on the upper and non-sensitive side of the stem are comparatively thick walled, while on the under side the cells are provided with very delicate membranes. If a portion is cut out of this cylindrical stem, the ends immediately become retracted so that each extremity takes on a funnel-like form. If such a cylindrical piece is then divided in the direction of its long axis, each part becomes bent in the form of a bow, so that the external epidermal side is longer than that bounded by the vascular bundle. This change in tension of the cells is due to a change in distribution of the cell-juice. When the membrane of the under portion of the leaf-stem is touched the cell-juice flows from the lower to the upper cells and into the intercellular spaces; the tension of the upper cells therefore becomes increased, while that of the lower cells becomes reduced. The stem, therefore, sinks and the leaves close. Movement occurring in the mimosa as a consequence of mechanical irritation, therefore, depends upon differences in degree of

turgescence of certain cells, and has nothing in common with animal motion.

The *Dionæa muscipula*, or Venus' Fly-Trap, furnishes another illustration of movement of parts occurring in the vegetable kingdom. The form of the bilobed leaf, which is the movable part of this plant, is shown in Fig. 45. The two lobes stand at rather less than a right angle to each other, and on each of the inner surfaces are three minute filaments projecting inward. The margins of the leaf are prolonged into spikes, into each of which a bundle of spiral vessels enters. When any one of these filaments is touched, even by so slight a pressure as would be produced by contact with a hair, the leaves instantly come into apposition, and the spikes interlock like the teeth of a rat-trap. The upper surface of the leaf is covered with minute glands, which furnish a secretion having the power of digesting organic substances. When

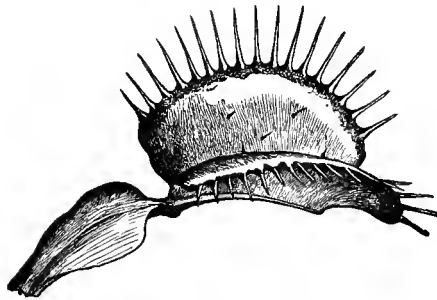

FIG. 45.—VENUS' FLY-TRAP (*Dionæa muscipula*).  
LEAF VIEWED Laterally IN ITS EXPANDED  
STATE. (Darwin.)

insects come in contact with these filaments, the leaves close so as to imprison them, and the insects are digested by the acid secretion stimulated by their contact, and absorbed.

In this plant the chief seat of the movement is in the thick mass of cells which overlies the central bundles of vessels in the mid-rib. When any one of these filaments on the internal surface of the leaves is touched the impulse travels in

all directions through the cellular tissue, independently of the course of the vessels, to the cells at the mid-rib. Fluid thus flowing from the upper cells to the lower, the lower cells greatly increase in tension, while the upper ones become relaxed and the leaves come into apposition. Opening of the leaves is accomplished by a reverse process. In this plant there is therefore to be seen not only a mechanical irritation, which produces mechanical motion by purely mechanical means, but also a chemical irritation through contact of various substances with the leaf, which results in the production of a digestive secretion.

2. PROTOPLASMIC MOVEMENTS.—Protoplasmic movements, which may be seen in both the animal and vegetable kingdoms, may be of various kinds. We may meet with movements of free protoplasm, or of protoplasm while contained within cell-walls.

The peculiarity of protoplasmic motion lies in the fact that the particles of the contractile mass do not move around any fixed point,

but that all the particles, as in a liquid, are capable of mutual rearrangement of position. Further, the stimulus to motion is not invariably applied from without, but may be self-originating in the interior of the mass. Protoplasm is thus contractile, irritable, and automatic.

Protoplasm, wherever found, is a transparent, colorless, apparently homogeneous mass, refracting light somewhat more strongly than water, but less than oil. Where protoplasm may be separated into layers, as in the ectosarc and endosarc of some of the lower animalcules, protoplasm may be doubly refractive, and when the direction of motion of the protoplasm is constant the optic axis coincides with the line of motion. Protoplasm, as previously indicated, possesses considerable power of imbibition, moderate cohesion, and great extensibility, the degree of each of these physical attributes varying in different forms of protoplasm, and at different times and under different conditions for the same protoplasm.

Protoplasm also usually contains a variable number of granules of foreign matter, which are passive in the motions of protoplasm, but which themselves may manifest oscillatory movement (Brownian motion). The reaction of protoplasm is usually faintly alkaline or neutral.

Protoplasm may produce movement by means of prolongations of cells, or by the contraction of organized matter resulting from the metamorphosis of cell-contents. We have therefore to consider—

*First.*—Protoplasmic and cellular motion, whether limited by a cell-membrane, or occurring in free protoplasm.

*Second.*—Motion of the protoplasmic prolongations of cells, as seen in ciliary movement; and

*Third.*—The contraction of substances resulting from the metamorphosis of cell-contents, as seen in muscular tissue.

1. *Movements in Protoplasmic Contents of Cells.*—In addition to the Brownian movement, or oscillatory movement of granules which is seen whenever minute particles, whether organic or inorganic, are suspended in a fluid, and which are simply due to varying currents produced by differences of temperature, the motion in the protoplasmic contents of cells may be either circulatory (cyclosis) or may result in changes of form. Circulatory movements are seen in numerous vegetable cells, particularly when the protoplasmic contents have decreased somewhat in amount so as not to fill the entire interior of the cell; the protoplasm is then heaped up against the walls of the cells, and sends prolongations across the interior. These cell-contents may then manifest movements, either of changes of form or of circulation of starch granules, etc., which are imbedded in the protoplasm.

If a cell of the *Tradescantia virginica* is examined under the microscope, the protoplasmic cell-contents will be found to be arranged in the

form of an irregular net-work, as represented in Fig. 46. These protoplasmic threads are the seat of changes, both of form and position. The single filaments may become thicker or thinner, or a new filament may spring out from and enter and unite with adjoining filaments, or may undergo division into several others, the process being analogous to that already described as characterizing the amœba. In addition to this motion in the cell-contents, rotatory movements may also be seen to take

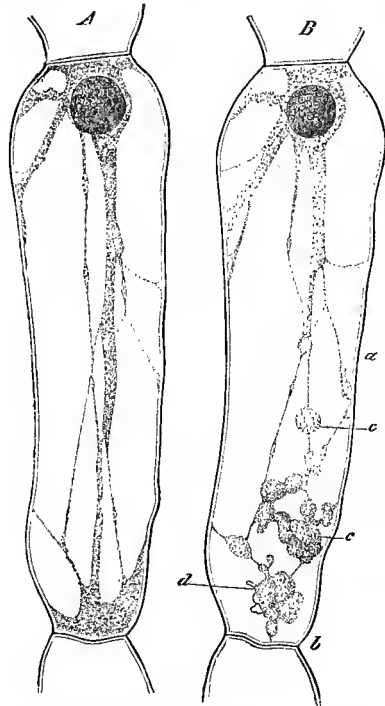

FIG. 46.—TRADESCANTIA CELLS, AFTER KÜHNE.

*A* represents the fresh cell suspended in water; *B* the same cell after moderate, local electrical stimulation. The irritated region extends from *a* to *b*, the protoplasm being collected into clumps, at *c* and *d*, as a result of the stimulation.

place in the protoplasm which is in contact with the walls of the cell, rotation occurring in a constant direction and with almost uniform rapidity around the cell-nucleus, the imbedded chlorophyll and starch-granules rotating in a mass without any decisive change in their relative positions. Such rotatory movements are seen in the leaf-cells of the Vallisneria, and various other plants. Similar motions are also seen in the paramœcium and other infusoria.

In young animal cells the same character of movement is often present; often when a membrane is absent or is very flexible the protoplasmic movements cause a change in the entire shape of the cell, and the motion so produced cannot be distinguished from those of free protoplasm.

Occasionally protoplasm becomes free by escaping from the interior of cells, such as the so-called plasmoids of myxomycetes, in which not only an internal granular movement but also a change of external shape may be made out. Similar phenomena are also seen in those organisms which consist of masses of free protoplasm, such as the monera, rhizopods, polyps, and infusoria. Such protoplasm possesses in an eminent degree the property of contractility.—a term originally applied to striped and unstriped muscles. The changes in form of masses of free protoplasm is identical in nature with that observed in muscular contraction.

place in the protoplasm which is in contact with the walls of the cell, rotation occurring in a constant direction and with almost uniform rapidity around the cell-nucleus, the imbedded chlorophyll and starch-granules rotating in a mass without any decisive change in their relative positions. Such rotatory movements are seen in the leaf-cells of the Vallisneria, and various other plants. Similar motions are also seen in the paramœcium and other infusoria.

In young animal cells the same character of movement is often present; often when a membrane is absent or is very flexible the protoplasmic movements cause a change in the entire shape of the cell, and the motion so produced cannot be distinguished from those of free protoplasm.

Occasionally protoplasm becomes free by escaping from the interior of cells, such as the so-called plasmoids of myxomycetes, in which not only an internal granular movement but also a change of external

The contractility of protoplasm may be manifested by either partial or total contractions, the latter tending to cause the protoplasm to assume a spherical shape. Partial contractions are much more common, and consist in contractions along certain circumferences of the mass of protoplasm, and thus lead to the production of irregularity in outline. Movements so produced are described as amoeboid movements from the fact that they are best seen in the amoeba.

Amoeboid movements have already been described, and are exemplified in many of the cells of which the bodies of the higher animals are made up. Thus, the colorless blood-corpuscles, lymph-cells, and corneal corpuscles possess throughout their entire life the power of changing their form in a manner entirely similar to that possessed by the amoeba (Fig. 47).

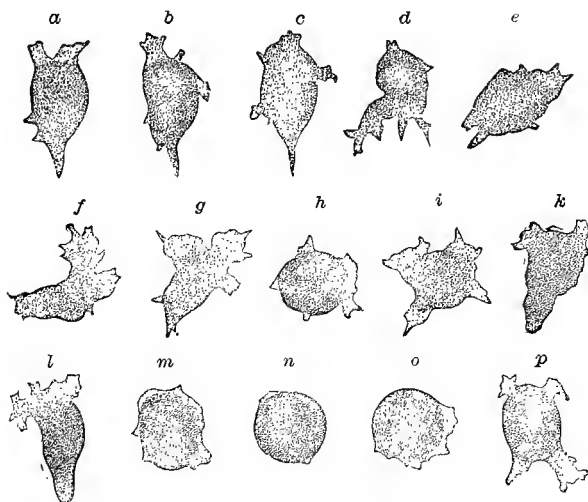

FIG. 47.—AMOEBOID MOVEMENT IN A COLORLESS BLOOD-CORPUSCLE OF THE FROG. (*Engelmann.*)

The temperature was gradually raised from *a* to *m*, and then gradually reduced.

The most striking illustration of this form of protoplasmic movement, seen in adult animals, is exemplified in the motions of pigment-cells in the skin of the chameleon. As is well known, the chameleon is capable of changing the hue of its skin, and this is simply due to the varying degrees of contraction of the pigment-cells, which are situated below the epidermis. When these cells send out branching prolongations to the exterior, the skin surface of the chameleon, from the larger amount of pigment exposed, will take on a dark hue. In the different stages of contraction of these pigment-cells the tint of the skin will vary according as the pigment-cells are seen through a thicker or thinner layer of yellowish or almost colorless epidermal cells.

The two extremes of position of these pigment-cells are represented in Figs. 48 and 49.

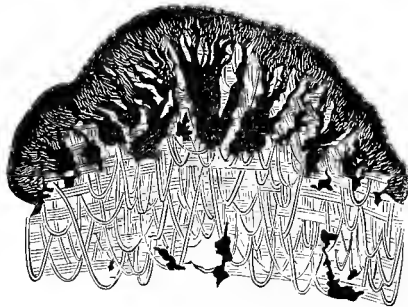

FIG. 48.

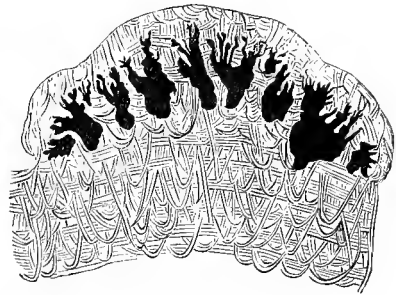

FIG. 49.

PIGMENT LAYER OF THE SKIN OF THE CHAMELEON IN DIFFERENT DEGREES OF CONTRACTION. (*Brücke*.)

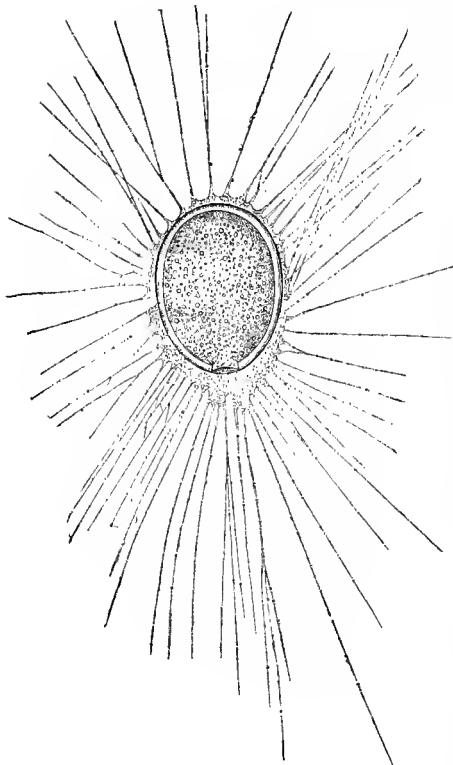

FIG. 50.

The frog also, as is well known, is another illustration of a change of tint produced by precisely similar processes.

From the fact that the movements of these pigment-cells appear to be under the control of the nervous system, they offer an illustration of a transition stage between the independent, automatic movement of free protoplasm, as in the body of the amœba, and the specialization of the function of movement in the nervous ganglia, nerves, and muscle-cells of higher animals.

In certain of the low forms of life protoplasmic motion may take on the form of minute contractile threads thrown out from the body of various rhizopods and monera, which differs from the amœboid movements just described. In this case long and thin protoplasmic threads in great number extend in every direction from the central mass; these threads, on whose surfaces fine granules are often seen in active



motion, are not themselves, usually, the seat of any active change in form, although they slowly and gradually become longer or shorter, or perhaps even divided. They are also capable of being entirely withdrawn into the contractile body-mass. Such a form of motion, or rather the forms resulting from such motion, are represented in Fig. 50.

2. *Ciliary Movement*.—By ciliary movement is meant the pendulum-like motion possessed by protoplasmic prolongations of fine hair-like threads of numerous animal and vegetable cells.

In many of the infusoria the entire external body surface, or a certain limited portion of it, is supplied with minute hair-like appendages, which, by their oscillation, serve as organs of propulsion. In vegetable spores cilia are distributed in a similar manner, and likewise serve as propulsive organs.

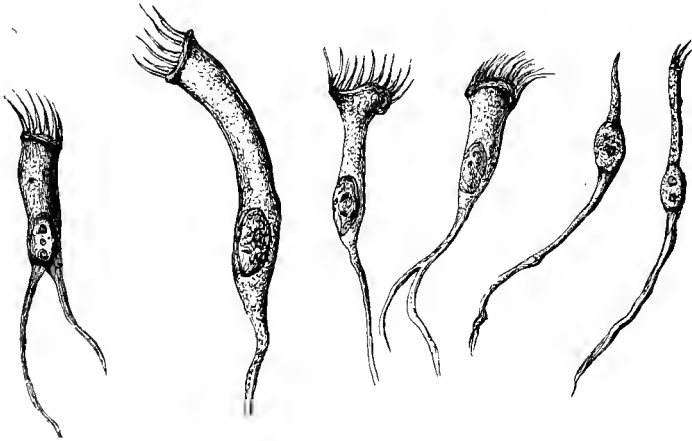

FIG. 51.—CILIATED EPITHELIAL CELLS FROM THE NASAL MUCOUS MEMBRANE OF THE COW, MAGNIFIED 500 DIAMETERS. (C. F. Müller.)

In the animal kingdom ciliary movement is seen under numerous forms on ciliated epithelial cells lining the nasal passages, antrum, tear-duct and sacs, pharynx and Eustachian tube, middle ear, trachea, bronchi, uterus and Fallopian tube, vas deferens, epididymus, central canal of the spinal cord and brain-ventricles, while cilia also serve as the organ of movement in spermatozoa.

The form of the cilium is, as a rule, that of a narrow, hair-like thread. In all of the ciliated epithelial cells of the higher animals, as well as in most spermatozoa, and in many of the lower animals and plants, the length of such cilia may vary from 0.05 mm. to 0.005 mm. (Fig. 51). They are structureless in appearance and colorless, and possess a considerable amount of flexibility and elasticity. Under the influence of various agents they may either swell up by imbibition or

shrivel when desiccated, and their appearances then undergo the same changes as will be described under the alterations of protoplasm. The solutions which coagulate albuminoid bodies also coagulate the ciliate prolongations of cells. Caustic alkalies and most of the concentrated acids dissolve them. In fact, cilia behave to all reagents in a very similar manner to protoplasm. All cilia are invariably connected with a protoplasmic base, and are never on firm membranes. Therefore, when cilia are found in the higher animals on epithelial membranes the free surface of the cell possesses no membrane, but the protoplasmic cell-contents, in a manner similar to that which is found in the epithelial cells of the villi of the small intestine, is somewhat condensed, apparently non-contractile, homogeneous, or striated, and not capable of imbibition. Such a surface might therefore be described as a protoplasmic cuticle.

Cilia pass through this condensed layer of protoplasm to be directly in contact with the protoplasmic contents of the cell below. On each cell of a ciliated epithelial membrane, from ten to twenty such cilia will be distributed over the external surface. In lower forms of animals, as in the spermatozoa of all vertebrates, ciliated cells may possess but a single cilium, as seen in many of the unicellular algæ and flagellata.

Ciliated epithelial cells are always cylindrical in shape and are nucleated. When a portion of ciliated membrane such as that obtained from the mouth or nasal pharynx of the frog, or from the nasal chamber of almost any animal, is placed under the microscope, the thread-like prolongations of these cells will be found to be in constant motion, by which the cells of one locality make a rapid bending motion in one direction, and then more slowly bend themselves back to their original position. The amplitude of these oscillations varies greatly with the character of the cell and certain external conditions, but on all cylindrical epithelial cells taken from the same locality is about equal, and, although the bending may be as much as  $90^{\circ}$ , it usually varies from about  $20^{\circ}$  to  $50^{\circ}$ . The rapidity of oscillation of each cilium may be about six or eight in the second, although under certain circumstances it may be considerably higher, since it is influenced by a number of external conditions, such as temperature, amount of water contained by imbibition, etc.

The mechanical force exerted by this pendulum-like motion of the cilia is very considerable. In cells which, like the spermatozoa, are supplied with a single cilium (Fig. 52), the screw-like motion of this appendage is sufficient to produce rapid motion of the entire organism. In the case of ciliary membranes, the vibration, having a greater intensity in one direction than in another, is sufficient to produce forward motion of light bodies brought in contact with them. Thus, if the mucous membrane is dissected from the pharynx of the frog and fastened by pins on

a board, any light bodies placed in contact with the ciliated surface of the membrane will be moved comparatively rapidly forward in the direction of oscillation of the cilia; or if the body of the frog is bisected, and a glass tube passed in the mouth and out the œsophagus, which is cut off at the point where it enters the stomach, the motion of the ciliated epithelium lining the pharynx and œsophagus will be sufficient to cause

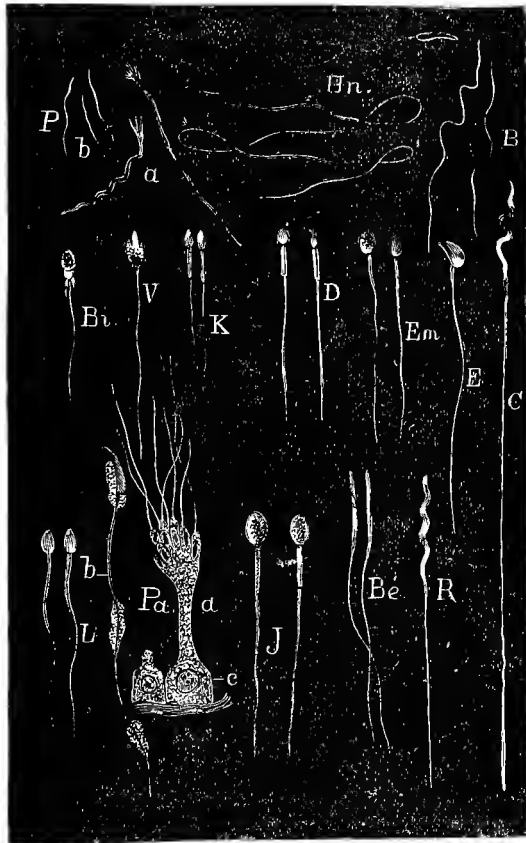

FIG. 52.—SPERMATOZOA OF DIFFERENT ANIMALS. (*Thanhoffer.*)

P, b, a, spermatozoa of *Paludina vivipara*; Bn, of *Helix nemoralis*; B, of *Blaps mortisaga*; Bi, of bull; V, of mole; K, of dog; D, of bat; Em, of man; E, of mouse; C, of canary-bird; L, of horse; Pa, b, of rat, with spermatoblasts; J, of sheep; Be, of frog; R, of *Raja batis*.

the body of the frog to advance at a comparatively rapid rate,—as much possibly as one millimeter in the second, or even more. It has been estimated that, in oblique or vertical upward movements, each square centimeter of ciliated membrane can perform in one hour 6.8 gramme millimeters of work, or the cells can lift their own weight more than four meters high (Bowditch). This motion of bodies placed in contact with

ciliated surfaces is evidently dependent upon the fact that the intensity of motion is greater in one direction than in the other; otherwise, of course, the effect would be negative.

Since ciliated epithelium, as has been already shown, lines most of the tubular structures of the animal body, the effect of the vibratory motion of the cilia will be to propel onward fluids and light particles in contact with the surfaces of the membrane. Thus, the cilia of the Fallopian tube, by their vibrations, serve greatly to assist the onward passage of the ovum through the oviduct.

Ciliary motion persists only as long as the cilia are in contact with the protoplasmic contents of cells, although Brücke has found that it is not necessary that the entire cell be in contact with the cilia; for if the free surface of a ciliated membrane is carefully shaved with a sharp knife and the portions cut off examined under a microscope, it will be found that many of the ciliated cells have been divided, and yet, provided a certain portion of the cell-contents is still in contact with the cilia, the latter will still manifest their normal movements. Ciliary movement may persist after the death of the individual where that ciliary motion is not concerned in producing movement of the entire organism; thus, in the ciliated infusoria anything which destroys the life of the animalcules will arrest ciliary movement; but, in the higher animals, in the cold-blooded groups, motion of ciliated epithelium may persist for days after the death of the animal; while, even in the warm-blooded animals, a number of hours after the death of the organism, the cilia will still be in vibration. This indicates that, in the first place, ciliary movement is not under the control of the nervous system; and, secondly, that it is independent of the state of the entire organism,—at any rate, in the higher forms of life,—since it may persist long after the irritability of nerves and muscles has disappeared. Temperature produces the same effects, nearly, on ciliary movement as it exerts on other protoplasmic movements; thus above 45° C. ciliated motion ceases, while at 0° C. it also is arrested, to, however, return again when the temperature is raised.

Increase of temperature between these two limits produces increase in the rapidity of oscillation of cilia, while decrease of the temperature produces retardation.

Every alteration in degree, of watery imbibition of epithelial cells exerts an influence on the ciliary movement; especially on the degree of frequency and amplitude of vibration. Increasing the amount of water in the epithelial cells above the normal amount may, at first, increase the vigor of oscillation, but when a certain maximum is passed motion is gradually arrested, as in heat-tetanus; the cilia coming to rest while bent forward, both cells and cilia being swollen and more transparent, and the nucleus appearing as a distended, watery vesicle. When such a con-

dition is reached the normal condition of the cells may be again restored through the use of desiccating agents, such as salts, which have an affinity for water, provided the watery distension has not lasted too long, nor has passed a certain degree. Abstraction of water again, on the other hand, reduces the rapidity, amplitude, and mechanical force of movement, while the cells and cilia become shriveled and motion is arrested. Like all other evidences of protoplasmic activity, a certain supply of oxygen is necessary for the maintenance of ciliary motion, and here again the same conditions may be determined as will be described under the conditions necessary for protoplasmic movement. So also various chemical influences, alkalies, acids, anæsthetics, and poisons produce disturbances of motion dependent upon their influence on the protoplasmic contents of the cells. The influences of electricity on ciliary movement have not been, as yet, very clearly made out, although they also appear to be in accord with the results obtained from the action of electricity on protoplasm.

These facts serve to show that ciliary movement is a form of protoplasmic movement; for, not only is such motion dependent on the connection of the cilia with the cell-contents, but all cilia on a single cell vibrate synchronously, and their motion is dependent upon the condition of the protoplasmic contents of the cells. Anything which interferes with the manifestations of force in protoplasm will interfere with ciliary motion. Ciliary motion, nevertheless, differs from other forms of protoplasmic movement in that it occurs in definite directions, and, with the exception of the spermatozoa and other ciliated organisms, on fixed surfaces.

Cilia are contractile but not automatic or irritable, while the contents of ciliated cells have apparently lost their power of independent contractility. Cilia may, therefore, be regarded as the organs of movement of certain cells. They, consequently, represent a certain stage of specialization of function.

3. *Movement in Specialized Contractile Tissue.*—In the contraction of muscular tissue, specialization of function has advanced a step farther. Free protoplasm originates its own stimulus to contraction, is therefore automatic, and is itself contractile. In ciliated cells the contractile impulse originates in the protoplasmic contents of the cells, which, however, have lost their power of contractility, and transfers the stimulus to contractile organs, the cilia, which are not themselves automatic.

In muscular tissue movement depends upon three histologically different tissues: the *nervous ganglion*, which is automatic and originates the contractile impulse; the *nerves*, which conduct this impulse to the *muscles*, which, like cilia, are contractile but not automatic.

The phenomena of muscular contraction will be considered under Special Physiology.

## GENERAL CONDITIONS GOVERNING PROTOPLASMIC MOVEMENT.

The motions of protoplasm are governed by a large number of conditions which are similar for protoplasm, whether of animal or vegetable origin. This fact therefore points to the identity of protoplasm of animal and vegetable forms of life.

1. *Temperature*.—For every variety of protoplasm there is an upper and lower temperature beyond which spontaneous motion ceases. The minimum temperature at which motion is possible is usually  $0^{\circ}$  C.; the maximum is  $40^{\circ}$  C. Between these limits the rapidity of motion usually increases with the increase of temperature, and the temperature at which the motions are most active usually lies several degrees below the maximum temperature, at which point heat-tetanus, or heat-rigor,—in other words, universal contraction of protoplasm,—occurs, resulting in the assumption of spherical forms analogous to the condition produced by prolonged mechanical, chemical, or electrical irritation. If the temperature is then reduced, the protoplasm may regain its power of spontaneous contractility. At the maximum temperature no optical changes occur in the protoplasm, but if the temperature is raised above this point the protoplasm becomes shriveled and opaque from the coagulation of the albuminoids of protoplasm. Vacuoles often form, and the power of contractility is permanently lost. As the temperature is reduced toward the minimum the movements become slower, and contractility is finally extinguished. No optical changes are, however, so produced, and an increase of temperature will now renew the power of contractility. Contractility is therefore destroyed by an excess of heat,—is suspended by a low temperature.

The changes in shape, as a consequence of change in temperature, are represented in Fig. 53. From *a* to *c* the temperature was  $12^{\circ}$  C. The protoplasm—the white blood-corpuscles of the frog—during that time changed its form but little. The preparation was then placed on the warm stage of the microscope and heated to  $50^{\circ}$  C. Almost immediately the movements became more active, passing through the forms as shown from *d* to *l*. At *m* commencing and at *n* complete heat-rigor is shown, while at *o* and *p* are shown the commencing movements restored by subsequent cooling.

2. *The Degree of Imbibition*.—The amount of water held in composition by the protoplasm is also of influence on the capability for spontaneous motion. For every form of protoplasm there is a maximum and minimum quantity of water of imbibition beyond which movement ceases. Contraction is impossible when, as a rule, less than 60 per cent. or more than 90 per cent. of water is held by protoplasm. Within these limits the rapidity of contraction increases with the amount

of water, and consequently with the increase of volume and decrease in the index of refraction of the protoplasm. As the maximum amount of water becomes approached the spherical form is assumed; so that, therefore, distilled water, as pointed out in the section on imbibition, kills protoplasm, possibly by the extraction of the salts which are necessary for the life of protoplasm. Thus, salt-water fish are killed by placing in fresh water; the fresh water is then found to increase in its inorganic constituents, which thus evidently must be extracted from the tissues of the animals with which it is in contact. So also desiccation produces shriveling of the protoplasm and an entire disappearance of all power of movement, although in the lower forms of life vitality is not destroyed,

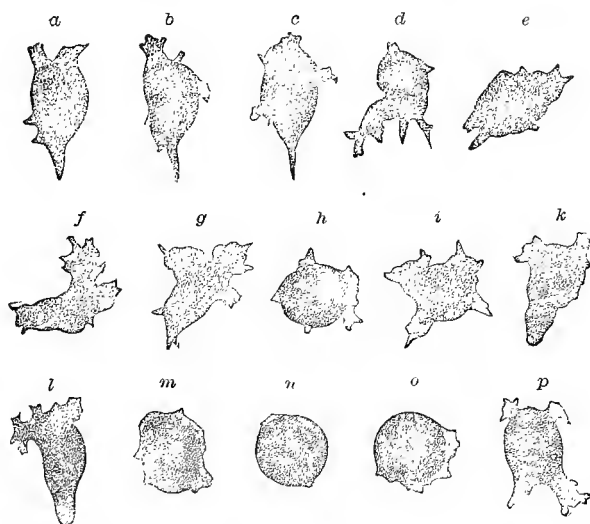

FIG. 53.—AMOEBOID MOVEMENT IN A COLORLESS BLOOD-CORPUSCLE OF THE FROG. (*Engelmann*.)

The temperature was gradually raised from *a* to *m*, and then gradually reduced.

but becomes latent; and when the proper percentage of moisture is again supplied the protoplasm will regain its power of contracting.

This is seen in the infusoria and various low forms of animal and vegetable life, which may be preserved indefinitely when desiccated, and may be restored to active life by placing them in a condition to absorb moisture.

3. *The Supply of Oxygen*.—Protoplasmic movements require the constant supply of oxygen, although they may continue to live in a medium of much lower oxygen-tension than is seen in the atmosphere. Higher tensions of oxygen than are found in the atmosphere will reduce the motions of protoplasm, which are, however, again renewed when the

pressure of oxygen is diminished. All protoplasmic motion is rapidly arrested in a vacuum.

4. *Various Chemical and Physical Agents.*—Various chemical agents are capable of modifying the contractility of protoplasm. Thus, a slight excess of acid or of alkali will arrest protoplasmic movement; hence, protoplasmic motions in the cells of various vegetable organisms, such as *cara*, will be arrested, after two or three minutes, in a one-tenth of one per cent. soda solution. Dilute acids cause coagulation of protoplasm, and will perhaps explain the poisonous action of carbon dioxide and the necessity of its removal from cells as rapidly as formed. Various poisons, such as ether and chloroform, interfere with the activity of protoplasm of all forms, and the similarity of action serves to still further demonstrate the identity of protoplasm. Thus, the alkaloid veratrine produces effects on all forms of protoplasm similar to those so well marked in muscular tissue.

Protoplasm, also, like muscular and other irritable tissue, responds to various forms of artificial stimuli, though the degree of susceptibility to such stimuli may vary in different forms of protoplasm. Electrical currents, when powerful, are capable of killing protoplasm, causing it to assume a spherical shape, and to become opaque, shriveled, and granular. Feeble currents slow the spontaneous motions of protoplasm, while strong currents arrest them. Where the contractile tissue is inclosed in tubular sheaths and the assumption of the spherical form so rendered impossible, as in muscular tissue, an attempt is made to approach the form as nearly as possible. Such protoplasmic cylinders when stimulated become shorter and thicker.

Sudden changes of temperature are also capable of producing either increase or decrease in the contractility of protoplasm, the change being more marked the more rapidly the variation in temperature occurs.

Absence of light also serves finally to arrest protoplasmic motion, while its presence will lead to increased vigor of contraction, as already referred to in the changes in the contractile pigmented cells of the skin of the chameleon and frog.



## SECTION III.

### CELLULAR CHEMISTRY.

#### I. CHEMICAL CONSTITUENTS OF CELLS.

IN the consideration of the structure of organized bodies we found that, no matter how complicated their form, all organized matter was capable of being resolved into a unit of organization, which we termed, with Brücke, an elementary organism or cell.

Cells, therefore, are the simplest schematic form to which all the various forms of organized bodies are capable of being reduced. Chemical investigation of organized bodies further shows that they are equally simple as regards their elementary composition. Of the sixty-five chemical elements only seven enter with any degree of constancy into the formation of organic compounds; these are oxygen, nitrogen, hydrogen, carbon, sulphur, phosphorus, and iron. By far the greatest number of all organic compounds are composed only of the three elements, carbon, hydrogen, and oxygen, varying in the different relative proportions of each. In one group, represented by the organic acids (succinic acid,  $C_4H_6O_4$ ), even if we assume that all the hydrogen present is associated with oxygen in the proportion to form water, there always remains a considerable excess of oxygen unaccounted for. In the second group, represented by the carbo-hydrates (glycogen,  $C_6H_{10}O_6$ ), we have twice as much hydrogen as oxygen, or, in other words, the oxygen and hydrogen exist only in the proportion to form water. In the third group, composed of these elements, carbon, hydrogen, and oxygen, and represented by the fatty acids (oleic acid,  $C_{18}H_{34}O_2$ ), if we suppose that all the oxygen is united with the hydrogen in the proportion to form water, we have still a considerable excess of hydrogen unaccounted for. Such bodies are, therefore, termed hydro-carbons.

In another group of organic compounds, and one of the most important of the constituents of cells, we find nitrogen associated with carbon, hydrogen, and oxygen. Such a group we would therefore term the nitrogenous, in contradistinction to the non-nitrogenous.

To this group belong the highly complex organic products (complex as regards their molecular arrangement), which contain sulphur and occasionally phosphorus, and still more rarely iron, and which are represented by the albuminous bodies; the nitrogenous organic acids and bases, the

organic alkaloids and indifferent crystalline bodies, some of which contain sulphur, are other members of this group. As yet only three substances of organic origin are known to contain phosphorus; these are lecithin (found in the blood, bile, and serous fluids), glycerin-phosphoric acid (derived from the former, and found in the same localities), and nuclein (found in pus-corpuscles, yelk of egg, and semen). In the living organism these organic compounds are in a state of solution in a relatively large amount of water, and either associated or chemically united with a small percentage of inorganic matter, which modifies, in all probability, the nature of the former, and is itself not without value in the vital processes.

All organic compounds are readily decomposable, either through the action of various chemical reagents, elevation of temperature, or through the processes of fermentation and putrefaction. As the result of all these changes in organic matters simpler compounds are produced. The more complex the molecule of organic matter, the more readily is it subjected to decomposition. The character of these changes, as well as the nature of some of the substances which result from change of various kinds in organic matter, will be subsequently discussed.

Of the inorganic constituents of cells by far the most abundant is water, which forms the great bulk of organic bodies. Many vegetable matters may contain as much as 90 per cent. of water, while the animal tissues may contain 75 per cent. or more, though the percentage is by no means constant, and may vary in single tissues according to different physiological or pathological conditions. The inorganic constituents of cells are taken up by the cells already preformed, and, as a rule, again leave the cells in the form in which they entered it. The most prominent exception to this rule is found in the case of carbon dioxide and sulphuric acid; the former originating in the oxidation of the hydrogen contained in the water of organic constituents, and the latter coming from the oxidation of the sulphur contained in albuminoids. The inorganic constituents of animal and vegetable cells in no way differ from similar bodies found in inorganic matter. When found as constituents of cells they have invariably been derived from the atmosphere or the earth, have been absorbed, often without undergoing any change, by vegetable cells, and have passed from the latter into the interior of animal tissues. Inorganic matter is found in all animal fluids and tissues, although with great variation as to amount. Certain inorganic constituents—such, for example, as water and sodium chloride—are found invariably in all animal tissues and fluids, while other of the inorganic cell-constituents are limited to the cells of certain special tissues.

The inorganic constituents of cells may exist either in the form of gases, salts, free acids, or in certain forms of combination whose exact arrangement has not yet been made out.

In addition to the elements which have been already mentioned as forming part of the organic constituents of cells, and which, of course, may exist in other forms, we find also, when organic matter is subjected to combustion, chlorine, fluorine, silicon, potassium, sodium, calcium, magnesium, manganese, iron, and occasionally copper and lead, in the ash. Of the other elements of organic bodies in incineration the carbon is converted into carbon-dioxide, part of which remains in the form of carbonates in the ash, part of the hydrogen uniting with oxygen to form water. Another portion unites with nitrogen to form ammonia, while the phosphorus and sulphur remain as oxygen compounds, sulphuric and phosphoric acids, united with different bases also in the ash.

Of the various chemical compounds which are found in the interior of cells, and which have entered it, either from accidental contact or as foods, or as resulting from the chemical processes in cells, we may make three different groups :—

1. Those which, already formed, exist in inanimate nature, are absorbed, and again leave cells without undergoing any change while forming constituents of organized bodies. Such substances are represented by the inorganic constituents of animal cells.

2. This group comprises those which are already formed exterior to the cells, and which, in the process of assimilation by the cells, undergo a change simply in their mode of molecular arrangement, without undergoing any profound chemical metamorphosis. Such constituents are seldom, if ever, removed from the cells in the form in which they entered it, and are, in the chemical process occurring in the interior of the cells, always reduced to simpler forms. The organic constituents of cells form this group. They may be either nitrogenous or non-nitrogenous in composition.

3. We meet also with a class of compounds which are themselves developed in the vital processes in cells, as the result of the metamorphosis of either the organic constituents of cells or of the food-products which have been assimilated by the cells. Such bodies may be removed from cells either as complex, organic, excretory products (as types of which urea and kreatin may be mentioned), or they themselves may undergo more profound decomposition before being removed from the interior of the cells. The examination of protoplasm, wherever found in the animal or vegetable kingdom, will show that it contains examples of each of these three classes of compounds.

The chemical constituents of organic bodies may, then, be divided into two different groups,—the organic and the inorganic. The organic may again be subdivided into the nitrogenous and the non-nitrogenous. Proteids, with their derivatives, represent the nitrogenous group; the hydro-carbons and carbo-hydrates, with their derivatives, the non-

nitrogenous group. Water and various salts belong to the second, or inorganic group. These will be taken up in turn:—

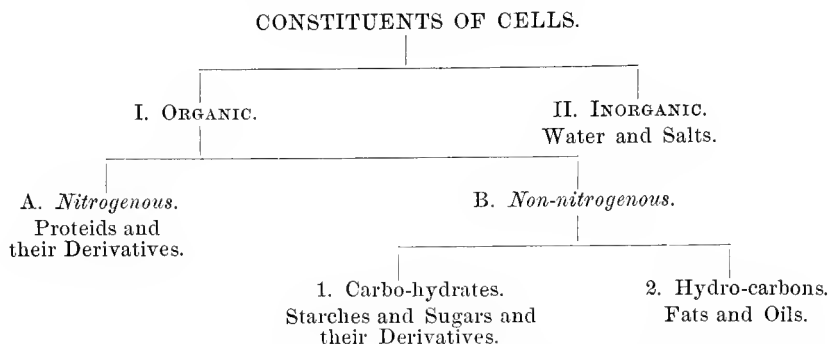

#### A. NITROGENOUS ORGANIC CELL-CONSTITUENTS—PROTEIDS AND THEIR DERIVATIVES.

*General Characteristics of Proteids.*—Proteid, or albuminous bodies, is the name given to a number of neutral, nitrogenous products of complex nature widely distributed throughout the animal and vegetable kingdoms, and agreeing more or less in chemical composition and properties with the white of an egg. They are found dissolved in the fluid media of the animal body, as constituents of the digestive juices, and in different degrees of solidity in the various tissues. They are never, during health, eliminated from the body in excretions. They are present during all periods of life. The higher plane of organization of man and the higher animals depends mainly upon the abundance and variety of the albuminous constituents of their tissues; for, while in plants the cell-walls are largely composed of non-nitrogenous matter, such as cellulose, in animals analogous parts are formed of various complex albuminoids.

Proteids are organic, colloidal bodies, composed of carbon, hydrogen, oxygen, nitrogen, sulphur, and occasionally phosphorus. They are absolutely essential to life, whether animal or vegetable, but are exclusively of vegetable origin; that is, although they may be assimilated and modified by the vital processes occurring in animal cells, they must first have been preformed by the chemical processes occurring in vegetable cells. When found as constituents of the tissues of carnivorous animals they have been derived directly, with but slight modification, from the herbivora which have served for their food, while the herbivorous animals find them invariably ready formed in the tissues of vegetables which serve as their food, and which require but slight modification to be converted into the constituents of the

animal tissues. Animals, therefore, do not have the power of manufacturing albuminoids, although they may transform albuminous bodies of one kind into those of another. Thus, casein may be transformed into the albuminous constituents of muscle-tissue; it may be combined with other substances so as to form, for example, the hæmoglobin of the blood-corpuscles, or may become so modified as to form what are termed the derived albuminoids of the different tissues.

After serving the purposes of the organism such bodies are excreted, not as proteids, but as products resulting from their retrograde metamorphosis. All albuminous bodies are so intimately associated with inorganic matter that their isolation in a pure state is a matter of the greatest difficulty, or, it may be, impossibility; consequently the incineration of albuminous bodies—a process which is accompanied with the development of an odor like burning horn—always leaves an ash composed of potassium and magnesium phosphates and small quantities of carbonates. If sulphur is regarded as a constant and normal component of proteids and not as an occasional accidental addition, they all possess a very high molecular weight. In all forms of proteids the percentage of chemical elements entering into their composition is only subject to slight variation in the different classes. Thus, according to Hoppe-Seyler, C. may vary from 52.7 to 54.5 per cent.; H., 6.9 to 7.3 per cent.; N., 15.4 to 16.5 per cent.; O., 20.9 to 23.5 per cent.; S., 0.8 to 2.0 per cent.

*Physical Properties.*—When dry, albuminous bodies form perfectly amorphous, yellowish, brittle masses without odor or taste, and closely resembling gums in appearance, and, like gums, hygroscopic to a high degree: they rotate the plane of polarized light to the left, and in watery solutions, which are nearly always opalescent, are not, as a rule, capable of osmosis,—a fact, which seems to show, as Brücke has pointed out, that their condition in the form of fluid is more one of particulate suspension than of true solution. When shaken with fluid oils, the latter are mechanically separated into minute particles, each of which is surrounded by a layer of the albuminous solution (emulsion). Some are soluble in water, others not; nearly all are insoluble in alcohol and ether; most are soluble in strong alkalis and acids, but in the process of solution undergo chemical change. Most of the albuminous bodies may exist in two modifications, either in a soluble or in an insoluble form. They exist usually in the soluble form in animal and vegetable cells, but become insoluble by the action of heat and various chemical reagents.

When watery solutions of albuminous bodies are evaporated in a vacuum, or at 40° to 50° C., a yellowish, brittle, soluble residue is left; in other words, albumen may be recovered unaltered in general properties in the dry form from solutions when subjected to evaporation by

gentle heat. When heated much above this point albuminous bodies then pass into the insoluble form (coagulated proteids).

*Chemical Properties.*—Proteids are precipitated out of their solutions by the following reagents: the stronger mineral acids, acetic acid and potassium ferro-cyanide; acetic acid and sodium sulphate, lead acetate, mercuric chloride, tannic acid, powdered potassium carbonate added in bulk to saturation, alcohol, ether, and several other substances.

Iodine stains most proteids yellow,—a point which may aid in their recognition under the microscope.

Their presence in solution may be recognized by the following processes:—

First, by *coagulation*. When solutions of albuminoids are gently heated, provided the amount of albumen contained is at all appreciable, a firm coagulum results when the solution has been warmed up to 60° or 70° C. The temperature at which coagulation occurs will vary in different forms of albuminous bodies, and according to the reaction and chemical characteristics of the solvent. If a small amount of a dilute acid is added to a solution of an albuminous body coagulation will be found to occur at a lower temperature than if the solution be neutral; while, on the other hand, the presence of a small amount of alkali will prevent coagulation occurring until the temperature has been raised above the point at which it occurs when the solution is neutral. If a large amount of alkali be present coagulation by heat will be rendered impossible. Neutral salts in small amount in albuminous solution will also lower the temperature of coagulation, whether the solution be faintly acid, faintly alkaline, or neutral. The coagulation of albuminous bodies by heat is only possible when they are in solution, and therefore seems to show that the change from the soluble to the insoluble form produced by heat is not so much dependent upon the heat as upon the heat combined with moisture; for if the albumen be separated from solution by evaporation below the point of coagulation, the dried albumen so obtained will still possess the power of solubility in water: and yet, if placed in a perfectly dry tube the temperature of the albumen may be raised far above the point of coagulation without any change occurring in the albumen, *i.e.*, without its losing its power of subsequent solubility in water, and of being coagulated when that solution is raised to the coagulating point.

Second: If a solution which is supposed to contain albumen is acidulated with acetic acid, a few drops of potassium ferrocyanide then added, and the fluid boiled, albuminous bodies will be precipitated.

Third: If the fluid is acidulated with acetic acid and a small quantity of a strong solution of sodium sulphate then added, and the fluid then boiled, a firm, white coagulum will result.

The first and third of these tests may be used for separating albuminous bodies from other substances in solution,—a process which is often necessary in the examination of organic fluids. So also if the fluid is acidulated with acetic acid, and then added to a large bulk of strong alcohol, albuminous bodies may thus be coagulated, and their separation from other ingredients of the solution rendered possible.

A precipitate produced by boiling alone is not a sufficient proof of the presence of albumen, since certain substances, such as calcium phosphate in human urine and calcium carbonate in the urine of herbivora, will be thrown down by boiling. If the precipitate is permanent on the addition of nitric acid after boiling, albumen is present, since the salts above mentioned will be redissolved by the acid. Alkali may also hinder the coagulation of albumen by heat, and an acid reaction is therefore essential for the employment of this test.

Occasionally albumen is present in solution in amount too small to be detected by any of the preceding tests. The detection of traces of albumen is then rendered possible by various color reactions.

*The Biuret Reaction.*—When a small amount of caustic potash solution is added to a dilute solution of cupric sulphate a precipitate of cupric hydrate will be thrown down. If an excess of potash is now added, the precipitate will be redissolved and the fluid take on a light-blue color. If, however, albuminous bodies be present in solution, and this procedure be carried out, on solution of the precipitate of cupric hydrate the fluid will take on a violet color instead of a blue. This test may be used to detect the presence of albuminous bodies in extremely small amount in solution. It may be also used for the recognition of the albuminous nature of solids. If a solid body which is supposed to contain albuminous bodies be touched first with a drop of cupric sulphate solution, then with a drop of potash solution, and then washed with water, the spot so treated will be found to have a violet color. This test is also used for the recognition of peptone. A solution of peptone so treated will become red instead of violet.

*Xantho-proteic Reaction.*—When albuminous bodies in solution are boiled with nitric acid, the solution and coagulum, if one be present, take on a yellow color. If the solution be then allowed to cool and strong ammonia added, the upper layers of the solution, or the coagulum, if any be present, will become orange colored.

*Millon's Reaction.*—If a little Millon's reagent\* be added to a solution which contains albumen, if the albumen be present in considerable

\* Millon's reagent is prepared by dissolving mercury in its own weight of nitric acid by the aid of gentle heat. The solution is then poured into a glass vessel, and twice its volume of water added; a crystalline precipitate will separate in a few hours, and the yellowish supernatant fluid, which may be readily decanted off, is Millon's reagent.

quantity, a dense, white precipitate will be formed, and when subjected to heat the precipitate will become condensed into the form of a firm coagulum, and will turn red. If but a trace of albumen is present the fluid will simply take on a pinkish color.

*Schultze's Test.*—When albuminoids in solution are treated with a cane-sugar solution in small quantities and concentrated sulphuric acid then added a beautiful red color is formed.

*Adamkiewicz's Test.*—If a solution of an albuminous body is strongly acidulated with acetic acid and sodium chloride added in bulk, and then strong sulphuric acid, the fluid will gradually assume a violet-blue color, slightly phosphorescent, and gradually turning dark purple.

*Fröhde's Test.*—When a mixture of sulpho-molybdic acid is added to a solution of albuminous bodies a dark-blue color is produced.

Of the above tests the xantho-proteic and Millon's reaction may be used for the microscopical detection of the albuminoids.

Albuminous bodies may be divided into the following classes:—

I. ALBUMENS.—Albumens are bodies which are soluble in water, and when in solution are coagulated by heat (about  $70^{\circ}$  C.). They are not precipitated from their solutions by dilute acids, carbonates of the alkalis, sodium chloride, or platino-hydrocyanic acid. When dried at about  $40^{\circ}$  C., or if evaporated at a lower temperature in a vacuum, they leave a yellowish, friable, inodorous, gummy mass, which is still soluble in water, and whose solutions possess all the properties of the original solution. Albumens are precipitated from their solution by alcohol, if alkaline salts are present. Albumens may exist in three different forms,—serum-albumen, egg-albumen, and vegetable albumen.

1. *Serum-Albumen.*—Serum-albumen is found in blood, serum, lymph, serous transudations, and animal secretions.

Serum-albumen may be obtained from blood-serum, or any serous transudation, by adding dilute acetic acid, drop by drop, until a flocculent precipitate forms. This precipitate is then filtered off, and the filtrate, after neutralization with a little sodium carbonate, is evaporated in a shallow dish to a small volume, not allowing the temperature to rise above  $40^{\circ}$  C. The salts may then be removed by dialysis, changing the water frequently outside of the dialyzer, and again evaporating at  $40^{\circ}$  C. to dryness.

So obtained, serum-albumen always contains a slight percentage of salts, but is soluble in water, forming a clear solution, which is somewhat tenacious when concentrated.

In the dry condition it is a yellowish, brittle, transparent body capable of being redissolved in water, and its solutions are then coagulable by heat. Its solutions are opalescent, and possess a specific lævotation for yellow light of  $-56^{\circ}$ . It is precipitated out of its solutions by alcohol, the precipitate being partially redissolved when the alcohol is immediately poured off, but is not coagulated by ether. Most of the



salts of the heavy metals precipitate serum-albumen, as do the mineral acids in large quantities, especially nitric acid. Its point of firm coagulation is from  $72^{\circ}$  to  $73^{\circ}$  C., although turbidity sets in at about  $60^{\circ}$  C. The presence of acetic or phosphoric acids, sodium chloride, or other neutral salts, lowers the coagulation-point of serum-albumen, while the presence of sodium carbonate necessitates a higher temperature. It is precipitated by the strong mineral acids from its solution in dilute acids, and the precipitate is readily soluble in concentrated acids; egg-albumen is not.

2. *Egg-Albumen*.—In many points egg-albumen, which is contained in the meshes of the fibrous net-work of birds' eggs, closely resembles serum-albumen. The points of contrast are that its specific rotation is only  $-35.5^{\circ}$ , and when agitated with ether it is gradually precipitated. When injected into a vein or the connective tissue, or when introduced in large quantities into the stomach or rectum of an animal, egg-albumen is found unaltered in the urine, while the injection of serum-albumen produces no such albuminuria.

A solution of comparatively-pure egg-albumen may be obtained for testing by breaking the whites of several hens' eggs into a beaker, cutting up the membranes with scissors so as to free the albumen from their meshes, stirring well with an equal volume of water, and filtering through muslin. The salts may then be removed by dialysis.

Dry egg-albumen may be obtained by evaporating the above solution to dryness at  $40^{\circ}$  C. So prepared, its physical properties agree closely with those of serum-albumen. Its solutions have several properties which enable it to be distinguished from serum-albumen. Hydrochloric acid in small amount produces no precipitate; in larger amount it causes a firm coagulum, which is only with difficulty soluble in excess of acid and in water and neutral salt solutions.

3. *Vegetable Albumens*.—Albuminous bodies are found dissolved in plant-juices and in the form of a solid in various seeds, and form the most important albuminoids for the nutrition of the herbivorous domestic animals. Their general properties agree with those of egg- and serum-albumen, though they present certain variations among themselves in composition and chemical properties. Thus, the coagulable substances which may be extracted from peas and horse-beans dissolve readily in lime-water and acetic acid, while the other vegetable albumens do not.

The vegetable albumens are, as a rule, poorer in carbon but richer in nitrogen than albumen of animal origin,—a fact possibly accounting for their lesser nutritive value and readiness of assimilation. They usually have phosphorus associated with them. Vegetable albumen is soluble in cold water, and its solutions are coagulable by heat; with dilute acids and alkalis it is converted into an albuminate. In the seeds of certain

plants there is contained a variety of albumen which, when extracted with warm salt solution and then allowed to cool, forms octahedral crystals.

Various forms of vegetable albuminous bodies have been described:—

*Vegetable Caseins.*—The seeds of the leguminous plants and oleaginous grains differ from the cereals, properly so called, in that they do not contain gluten, soluble in alcohol, but, in addition to the albuminoids coagulable by heat, various other albuminous bodies which are insoluble in pure water but soluble in alkaline solutions, from which they may be precipitated by acetic acid, the precipitate being soluble in excess. According to Dumas and Cavours, this substance may even be coagulated by rennet, and is therefore closely analogous to the casein of milk, to be subsequently considered. Three different forms of vegetable casein-like bodies have been described. *Legumin*, which forms the greater part of the proteid constituents of the leguminous plants; almonds and the lupins contain a substance analogous to vegetable casein to which the name of *amandin*, or *conglutin*, has been given; while the part of gluten which is insoluble in alcohol is of similar nature, and has been termed *gluten-casein*.

*Legumin.*—The watery extract of the seeds of the leguminous plants often has an acid reaction, without doubt due to the presence of phosphoric acid, which appears to be a necessary component of vegetable casein. Legumin may be obtained by the agitation of powdered leguminous seeds with seven or eight times their weight of a one-tenth of one per cent. solution of potassium hydrate. After about six hours the fluid is decanted and allowed to stand from twelve to twenty-four hours at a low temperature, and the residue which then forms is again washed with water. The washings are then collected and precipitated with dilute acetic acid, and the precipitate, washed again with dilute alcohol, is finally precipitated by concentrated alcohol and ether.

Freshly precipitated legumin is only very slightly soluble in cold water. Legumin may, however, be extracted from the powdered seeds of the leguminous plants by cold water, its solubility in water being then due to the phosphoric acid of the seeds. It is readily soluble in alkaline solutions, from which it is precipitated by acids and solutions of metallic salts. It is soluble in dilute hydrochloric and acetic acids. When boiled with water it becomes coagulated and insoluble in alkaline solutions and in acids. By prolonged ebullition with sulphuric acid it undergoes decomposition, with the formation of leucin and tyrosin and small quantities of aspartic acid. Legumin is also present in oats.

*Amandin*, or *conglutin*, is contained in sweet and bitter almonds, and is separated from them in the same manner as legumin. It is distinguished from legumin by a greater solubility in dilute acids, though

its general properties coincide with those of legumin. It is distinguished from it, however, by being more soluble than legumin in dilute acids. A substance analogous to vitellin has also been found in the seeds of various plants. It is also termed crystallized vegetable casein.

*Gluten*, or *vegetable fibrin*, exists in a large number of grains, particularly those of the cereals, and plays an important part in the nutritive value of vegetable foods. It also exists in the growing parts of plants, and in various vegetable juices. It is a compound albuminous body, which differs from all others in that it is soluble in water and in alcohol when traces of free acid or alkali are present. It is only partly and imperfectly soluble in pure water. It may be readily obtained by washing flour under a stream of water, by which the starch is removed, and the gluten then remains in the form of an elastic, grayish mass. Gluten is only partly soluble in alcohol. According to Ritthausen, gluten contains at least four albuminous substances in addition to vegetable albumen, which has been already described; a body insoluble in alcohol, which is gluten-casein, or the vegetable fibrin of Liebig, and three nitrogenous substances soluble in alcohol, to which the name of gluten-fibrin, gliadin, and mucedin have been given.

1. *Gluten-Casein*.—To prepare this body, fresh gluten is washed first with alcohol, and the insoluble residue is then agitated with two-tenths of one per cent. potash solution, which dissolves out the gluten and leaves an insoluble residue of starch and fatty matters. From the fluid gluten-casein is precipitated in flocculi by the addition of acetic acid sufficient to give a faint acid reaction. It is then washed with water and alcohol, and after desiccation the gluten-casein so prepared is insoluble in hot and cold water. Boiling water, however, causes it to undergo some modification, which renders it insoluble in alkalis and acids. In the fresh state it is soluble in acetic acid, and in alcohol acidulated with acetic acid. All weak alkaline solutions dissolve fresh gluten-casein, and cause it when dry to first swell up and then dissolve. It is precipitated out of these solutions by acids and the mineral salts, forming combinations with the latter. Its properties are very similar to those of legumin and conglutin. It contains more sulphur and less nitrogen than legumin.

2. *Gluten-Fibrin*.—This body is obtained by distilling the alcoholic solution of gluten until the fluid does not contain more than 40 per cent. of alcohol; a mucilaginous mass rich in gluten-fibrin is then deposited, and may be purified by washing with absolute alcohol and precipitating with ether. It then forms a coherent, tenacious mass, insoluble in water. Its separation from the gliadin and mucedin of gluten depends upon the fact that all are soluble in dilute alcohol, and that gluten-fibrin is almost insoluble in water and very weak alcohol. As the alcohol is distilled off

the gluten-fibrin separates. It dissolves in warm, dilute alcohol, and forms a brownish-yellow solution. When such solutions cool, and as they undergo evaporation, a white or grayish pellicle forms on the surface, which disappears on agitation. It is more soluble in absolute alcohol than either gliadin or mucedin. Gluten-fibrin is readily dissolved in dilute acid and alkaline solutions, and is precipitated from these solutions by neutralization, or by the addition of metallic salts.

3. *Gliadin, or Vegetable Gelatin*.—This body is one of the principles of gluten which is soluble in dilute alcohol. It is obtained by agitating gluten with strong alcohol, which removes gluten-fibrin, dissolving the residue in 1 per cent. potash solution, and, after having precipitated the solution with acetic acid, by extracting the precipitate with alcohol of 75 per cent. at a temperature of 38° C. By this means only gliadin is dissolved, while the mucedin remains. Vegetable gelatin then separates, as the fluid cools, in the form of a gelatinous mass. It may be purified by dissolving in acetic acid and neutralizing the clear solution with potash; the precipitate is then again washed with alcohol and ether. In the fresh state vegetable gelatin has the consistence of a thick mucilage. Absolute alcohol causes it to contract to a hard and yellowish-white mass. Cold water causes it to again swell up and dissolves part of it, and the solution may be precipitated by tannic acid. Submitted to long boiling with water, gliadin becomes insoluble and undergoes partial decomposition. Dilute alcohol dissolves it more readily than pure water. It is insoluble in absolute alcohol. It is very soluble in acids and dilute alkalies, and while in solution in alkalies may be precipitated by the metallic salts, but its solution in acetic acid is not precipitated by mercuric chloride. It contains a considerable percentage of sulphur.

4. *Mucedin*.—This substance has been but little studied, and is only to be distinguished from vegetable gelatin by its greater solubility in water. Its method of isolation has been already indicated in the preceding paragraphs.

These substances approach one another very closely in chemical composition, and it would appear from the processes employed in their isolation that it is by no means certain that they have been obtained pure. On the other hand, their analogy to corresponding bodies of animal origin is not sufficiently striking to justify an analogous nomenclature.

For the preceding account of their properties we are indebted mainly to Würtz (*Chimie Biologique*).

II. GLOBULINS.—Globulins are bodies which are insoluble in water but soluble in dilute solutions of sodium chloride. They are coagulable by heat when in solution, and, while soluble in dilute acids and alkalies, are in the process of solution changed into derived albumens. They are

precipitated by alcohol and by carbonic acid, and by the addition of a large quantity of water to their solutions; sodium chloride added in bulk to their solutions, as a rule, precipitates them.

Five different kinds of globulins have been reeognized.

1. *Vitellin*.—Vitellin is found in the yolk of eggs and in the crystalline lens. It may be prepared by shaking the yolks of eggs with separate portions of ether until all the yellow color is removed, dissolving the residue in dilute sodium chloride solution, filtering and precipitating the filtrate with excess of water. So obtained, it always contains lecithin. It is not precipitated by the addition of sodium chloride in substance to its solutions. It is soluble in dilute acids, and is readily converted into syntonin, and by neutralization and re-solution with alkalis into alkali albuminate. Its point of coagulation ranges from 70° to 80° C. It is also coagulable by alcohol.

2. *Myosin*.—Myosin is formed in the rigor mortis of museles, and probably also in the gradual death of all forms of protoplasm. It is precipitated from its solutions in dilute sodium chloride by the addition of common salt in excess. It is also precipitated from its solutions by excessive dilution with water. Its general properties will be more closely considered under the chemistry of muscles.

3. *Paraglobulin*.—This substance will be described under the consideration of the coagulation of the blood. Hammarsten states that a very much larger quantity of this body is found in the blood of domestic animals than has been heretofore supposed. According to him, more than half of all the albuminoids in the blood consists of paraglobulin.

4. *Fibrinogen*.—This is also a globulin found in the blood, and its consideration will likewise, for the present, be deferred.

5. *Globulin*, or *Crystallin*, is contained in the crystalline lens, and it resembles vitellin in that it is not precipitated from its solutions by saturation with sodium chloride, but it is readily precipitated by aleohol.

Representatives of the group of globulins are also found in the vegetable kingdom. According to Dr. Sidney Martin, vegetable globulins may be divided into two elasses, namely, vegetable myosins and vegetable paraglobulins. The myosins, obtained from the flour of wheat, rye, and barley, have similar properties; they are all readily soluble in 10 to 15 per cent. sodium chloride solution, and are precipitable from this solution by saturation with sodium chloride or magnesium sulphate. They are soluble in 10 per cent. magnesium sulphate solution, and are coagulated in this solution at a temperature of 55° to 60°. If the salt is dialyzed away from the saline solution of myosins, the latter is precipitated; but the precipitate is no longer a globulin, since it is insoluble in saline solutions. It is soluble in dilute acids and alkalis (0.2 per cent.); it is precipitable from these solutions by neutralization, the precipitate

being soluble in excess of alkali or acid; that is, the myosin has been converted into a proteid having the properties of an albuminate. If the saline solution of myosin be placed in an incubator at a temperature of  $35^{\circ}$  to  $40^{\circ}$ , in twelve to eighteen hours a fine flocculent precipitate falls, while the globulin disappears from the solution; this takes place more rapidly if the saline solution is diluted. The precipitate exhibits the same properties as the precipitate of the globulin by dialysis; that is, at a temperature of  $35^{\circ}$  to  $40^{\circ}$  the globulin is transformed into an albuminate. The ready transformation of the soluble globulin of wheaten flour into an insoluble albuminate is one of the phenomena which take place during the formation of gluten.

The second class of vegetable globulins, the paraglobulins, is in distinct contrast with that of the myosins. Two proteids of this class have been found, one in papaw-juice, the other in the seeds of *Abrus precatorius* (jequirity). Both these globulins exhibit the following properties: they are soluble in saline solutions, and are precipitated by saturation with sodium chloride and magnesium sulphate. In a 10 per cent. solution of magnesium sulphate, they coagulate between  $70^{\circ}$  and  $75^{\circ}$  C. When precipitated from their saline solutions by dialysis, they are still soluble in solutions of sodium chloride and magnesium sulphate of 10 to 15 per cent., not being transformed into albuminates. Nor are they precipitated by long exposure (over three days) to a temperature of  $35^{\circ}$  to  $40^{\circ}$ .

III. FIBRINS.—Fibrins are solid albuminous bodies insoluble in water and sodium chloride, and which swell up to a stiff jelly in dilute acids. When so treated fibrin is coagulable by heat. The fibrin of the blood is produced in the process of coagulation of the blood; its properties will be studied with the subject of blood coagulation.

IV. DERIVED ALBUMINATES.—Derived albuminates are bodies which are insoluble in water or sodium chloride solutions, but are readily soluble in dilute acids or alkalis. Their solutions are not changed by heat. When neutralized they are precipitated from their solutions, the precipitate being soluble in excess. Derived albuminates may exist in two different forms,—acid albumens and alkali albumens.

1. *Acid Albumen*.—When a native albumen in solution is subjected to the action of a dilute acid, such as hydrochloric acid, at a tolerably warm temperature its solutions readily lose their power of coagulating when boiled. If, however, the acid is exactly neutralized by the addition of any alkali the albumen is at once precipitated, and the precipitate is again redissolved by an excess of alkali. The native albumen is thus converted into a form of albuminous body which has become insoluble in water and uncoagulable by heat.

When acid albumen is precipitated out of its solution by the

addition of an alkali and then subjected to heat, the acid albumen so suspended in water becomes coagulated, and is then indistinguishable from any other coagulated proteid. After precipitation by neutralization, if the precipitate be then dissolved in lime-water, its solution in lime-water will be coagulable on boiling. Acid albumen is precipitated out of its solution by the neutral salts, such as sodium chloride, and by gallic acid and metallic salts.

The conversion of albumen into acid albumen from the action of a dilute acid is a gradual process. If a solution of egg-albumen be acidulated with dilute hydrochloric acid, and subjected to a temperature of about  $40^{\circ}$  C., it will be found, if tested from time to time, that a coagulum still occurs on boiling. The amount of proteid so coagulated by heat will steadily decrease, and the amount of precipitate obtained by neutralization will increase correspondingly. After only ten or fifteen minutes it will be found that if the solution of acid albumen is exactly neutralized all the albumen will have been converted into acid albumen, and if the precipitate is then filtered off and the filtrate tested with the various proteid tests it will be found that all the proteid has apparently disappeared; or, in other words, has been converted into acid albumen.

A certain degree of temperature is necessary for this conversion. If a mixture of albumen solution and dilute acid be surrounded by ice, the process of conversion into acid albumen will be extremely slow. If warmed up to about  $40^{\circ}$  C., or, in fact, any distance below the temperature of coagulation of the albumen, the process of conversion will be very much more rapid.

If finely-chopped muscle is washed in water so as to remove all the soluble albuminous bodies and blood, and the remainder be covered with a large quantity of dilute hydrochloric acid (0.2 per cent.), and kept for about twenty-four hours at a temperature of  $40^{\circ}$  C., it will be found that the greater part of the muscle will be dissolved; if the supernatant fluid be filtered off and neutralized, an abundant precipitate of acid albumen will be thrown down in flocculi, which will gradually settle. The acid albumen in this case is derived from the myosin of the muscle, and indicates that the globulins as well as the albumens are capable of being converted into derived acid albumen. Acid albumen so obtained from muscle is frequently spoken of as syntonin, but is apparently identical in its general behavior under the different tests to the acid albumen derived from either egg- or serum-albumen. So also in the preliminary stages of gastric digestion of proteids a product is first formed which appears to be identical in character with acid albumen, or syntonin, and is termed parapeptone. It also is precipitated from its solutions by neutralization, and is apparently formed solely through the action of the acid of the gastric juice on proteids.

Any of the coagulated proteids may be converted into acid albumen through solution in the mineral acids. If a solution of albumen is gently heated to boiling with dilute hydrochloric acid, no coagulum will be formed, from the fact that in the gradual elevation of temperature the albumen in solution has had time to be converted quickly into acid albumen through the action of the acid. If, now, a small quantity of a concentrated mineral acid, especially hydrochloric, be added, an abundant precipitate will form, and this precipitate is soluble in an excess of mineral acid, especially if subjected to heat.

It is thus shown that acid albumen is soluble in concentrated mineral acids. It is insoluble in them when they are moderately concentrated, and it is soluble again when they are very dilute. Egg-albumen, in certain respects, differs from serum-albumen in its behavior to dilute acids. If dry serum-albumen is dissolved in a concentrated mineral acid, it is readily converted in its process of solution into acid albumen. If this solution of serum-albumen in concentrated acid is then diluted with twice its volume of water, acid albumen will be precipitated, and if the precipitate is filtered off it may readily be dissolved in water, from the fact that it still holds clinging to it enough acid to make a dilute acid solution. Therefore, it is not a solution of acid albumen in water, but in dilute acid. Egg-albumen is less soluble in concentrated nitric acid or hydrochloric acid, and when precipitated from such a solution it is less readily dissolved in water.

Fibrin also is soluble in concentrated mineral acids, and is rapidly converted into syntonin; therefore, it may be said that all proteids are capable of being converted into derived albumens.

Syntonin, dissolved in dilute hydrochloric acid, rotates the plane of yellow light  $-72^{\circ}$  to the left, and this degree of rotation is independent of the concentration of the solution, but may be increased to  $-84.8^{\circ}$  if the solution is heated. Syntonin contains sulphur, as may be readily shown by dissolving some syntonin in liquor potassæ, and adding a solution of lead acetate and boiling; the fluid will then become brown from the formation of lead sulphide. When precipitated from its solutions by neutralization acid albumen forms a white, gelatinous substance insoluble in water and sodium chloride solutions, but soluble in lime-water (in which solution, as already stated, it undergoes partial coagulation when boiled), and in dilute acids and alkaline solutions. If, to the solution in lime-water, after having undergone partial coagulation through boiling, magnesium sulphate be added, a still further precipitation will be caused. Cold solutions of acid albumen are not precipitated by magnesium sulphate, even if the acid albumen be dissolved in an alkaline solution. If, however, the solution of acid albumen and alkali be warmed, it is then precipitated by the addition of magnesium sulphate or calcium chloride,



indicating that, in all probability, the boiling has served to convert the acid albumen into an alkali albumen. Acid albumen shows all the reactions of proteids already described. It may be separated from liquids in which it is dissolved by boiling with hydrated oxide of lead.

2. *Alkali Albumen*.—If any native albumen in solution is subjected to the action of a dilute alkali, such as sodium or potassium hydrate, it will undergo changes somewhat similar to those produced by the action of an acid. Alkali albumens, or alkali albuminates, may, therefore, be described as albuminous bodies which are insoluble in water or sodium chloride, but readily soluble in dilute acids or alkalies. Their solutions are not changed by heat. When neutralized they are precipitated from their solutions, the precipitate being soluble in excess of acid, unless alkaline phosphates are present; an excess of acid is then required to produce reprecipitation. In this conversion heat facilitates the process, and, as in the case of formation of acid albumen, the conversion is a gradual one. When alkali albumen is precipitated from its solution in alkalies by neutralization with an acid, if an excess of acid be added it is again rapidly dissolved, through its conversion into acid albumen or syntonin. This conversion of alkali albumen into acid albumen is more readily accomplished when the alkali albumen has been freshly precipitated. If some time has been allowed to elapse after the precipitation by neutralization, it will still be converted into syntonin by the action of an acid, but not so readily as when freshly precipitated, unless subjected to heat (about 60° C.). If alkaline phosphates are present in the solution the alkali albumen is not precipitated on neutralization, but enough acid must be added to convert the basic phosphate into acid phosphate, and, when this is accomplished, the slightest addition of an acid, even of CO<sub>2</sub>, will then be sufficient to precipitate alkali albumen.

Alkali albuminate may exist either in the form of solution or as a solid. If undiluted white of egg is stirred up with a concentrated solution of caustic potash, or with undissolved caustic potassium hydrate, it will gradually be converted into a stiff jelly. If this jelly is washed with water so as to remove the excess of alkali, it may be dissolved in warm water, and will then behave like alkali albumen obtained by the action of alkalies on albuminous solutions. If, before solution in water, the solid alkali albuminate has been washed until most of the alkali has been removed, passing a stream of carbon dioxide through the solution will be sufficient to cause reprecipitation.

If some pieces of solid alkali albuminate are placed in an acid just strong enough to show an acid reaction after the introduction of the albuminate, the latter will become milky-white, shrivel up, and form an elastic mass, the so-called *pseudo-fibrin*, which will swell up in dilute

(0.1 per cent.) acids without dissolving, but which is soluble in the caustic alkalis, and may be precipitated by neutralization.

Alkali albumen, like other albuminous bodies, is also precipitated from its solutions by metallic salts. With alcohol no precipitate is yielded, and alkali albumen is said to contain no sulphur, the sulphur of the albumen from which it is made being removed by the alkali in the process of conversion. It therefore differs from acid albumen and from casein, which contains sulphur.

Alkali albumen or albuminate is present in all young cells, in blood-corpuscles and blood-serum, in muscle, pancreas, nerves, crystalline lens, and cornea. It would seem that alkali albuminate may exist in various forms, judging by the difference in effect produced on polarized light by alkali albumen produced from different sources. Thus, alkali albumen produced from serum-albumen has a lævo-rotatory power of  $-86^{\circ}$ ; from egg-albumen, of  $-47^{\circ}$ , and if prepared from coagulated egg-albumen it may be as high as  $-58.8^{\circ}$ .

*Casein* is a form of alkali albuminate which is present in milk. It yields potassium sulphide when left to stand with liquor potassæ, and still more quickly when heated with it. It may be prepared from milk by shaking the milk with caustic potash and ether, removing the ether and precipitating the albuminate with acetic acid, and washing the coagulum with water, alcohol, and ether. The other properties of casein will be further studied under the subject of Milk.

Alkali albumen, therefore, differs from acid albumens in its not being precipitated on neutralization if alkaline phosphates be present; by its being precipitated by magnesium sulphate in substance in cold solution, but in not being coagulated when boiled in lime-water; and it contains no sulphur.

V COAGULATED PROTEIDS.—It has already been seen that the action of heat on solutions of egg- and serum-albumen, globulins, or on fibrin when suspended in water, or dissolved in saline solutions, serves to coagulate them and to convert them into an insoluble form. Absolute alcohol produces a similar effect on the same bodies; coagulated proteids are insoluble in water, dilute acids and alkalis and neutral saline solutions, and, although they are soluble in the strong mineral acids, their solubility is dependent upon the fact that through the action of the acid they are converted into derived albumens. They are readily converted into peptones through the action of the different digestive juices (gastric and pancreatic juices). When freshly formed they are white, flocculent, or cheesy masses which, under the microscope, are entirely amorphous; they hold water and salt solutions with great tenacity. Their chemical characteristics have been very little studied.

VI. AMYLOID SUBSTANCES OR LARDACEIN.—This is a substance which

appears to be a derivative of fibrin, and is found as a deposit in numerous of the organs of the body, such as the spleen, liver, etc. It is insoluble in water, alcohol, ether, dilute acids, and alkaline carbonates, and is not dissolved by the digestive juices. When acted on by concentrated hydrochloric acid it passes into solution and is converted into syntonin, which may be precipitated by dilution with water. With sulphuric acid it dissolves when boiled, forming a violet solution, and with strong sulphuric acid it is converted into leucin and tyrosin. In its composition it appears identical with other proteids. It behaves differently, however, to certain of the proteid tests, and must, therefore, be regarded as a modified proteid. Thus, with iodine, instead of the yellow color produced with other proteids, a reddish-brown color is formed. With iodine and chloride of zinc or sulphuric acid a violet-bluish color is produced, thus resembling cellulose in its reaction, to which similarity it owes its name of amyloid, though it must be remembered that this is the only point of similarity between amyloid substances and the starchy bodies; for it contains nitrogen, which is absent from all starches, and it cannot be converted into sugar. Aniline violet on amyloid substance causes a reddish-violet color, and is a test which may be readily used for detecting the presence of amyloid degeneration in various animal organs. Amyloid substance yields the Millon's and xantho-proteid reactions.

VII. PEPTONES.—A peptone is a modified form of proteid which occurs when any of the albuminous bodies, with the exception of lardacein, are subjected to the action of gastric or pancreatic juices, prolonged boiling at high temperature under great pressure, or by the action of heat and dilute acids at moderate temperature. Their general characteristics will be referred to under the subject of Digestion.

In addition to the above classes of albuminous bodies, albumen has been said to exist under two other forms, that of meta-albumen and para-albumen, although as yet very little is known about their characteristics, or in fact whether they are not simply ordinary albuminous bodies modified by the accidental addition of some other substance. Thus, meta-albumen might possibly be regarded as a mixture of albumen and mucin, since it is precipitated by alcohol without undergoing coagulation; it is not coagulated by boiling, although its solutions become cloudy when heated, and it is not precipitated by acetic or hydrochloric acids, or acetic acid and potassium ferrocyanide. It is, however, precipitated by mercuric chloride and gallic acid. It has been found in ovarian cysts, and in the fluid of ascites. When precipitated by alcohol the precipitate is again soluble in water. Para-albumen has also been found in the fluid of ovarian cysts, where its presence was supposed to be characteristic, but has also been found elsewhere. It is precipitated by alcohol, and when so precipitated

may redissolve again in water. It is not completely coagulated by boiling. It is rendered turbid by acetic acid, the cloudiness being removed by an excess of acid or sodium chloride. It is precipitated by nitric acid, potassium ferrocyanide and acetic acid, mercuric chloride, and acetate of lead.

#### ALBUMINOIDS.

In the development of the different tissues of the animal body the native albumens already described, which exist in the ovum and embryonic cells, assume a modified form, the condition under which such a modified albumen is present varying considerably in different tissues; as already pointed out, the difference in the different tissues, especially in the different members of the connective-tissue group, is dependent upon the modification which the albuminous constituents of those cells have undergone. Such bodies have a chemical composition very closely allied to that of native albumens. They are complex, nitrogenous compounds, but they present certain properties in contrast with the true albuminous bodies. As they appear to result from the transformation of those bodies in the animal economy, not as a rule being found in the vegetable kingdom, they may be spoken of as the albuminoids of special tissues.

In the connective-tissue group are included a number of different tissues, such as white connective tissue, elastic tissue, tendon, bone, cartilage, and dentine, which at first sight appear to have few if any points in common. Yet all these tissues fulfill the same subservient function of connection and support, all originate from the same layer of the blastoderm, and in different periods of life are often changed from one form into the other. The cells of all these tissues are capable of developing a more or less homogeneous intercellular substance, whose chemical composition differs in the different members of this group.

When any of the various forms of connective tissue proper are macerated for some days in lime-water or baryta-water, the various elements fall asunder from solution of the connecting cement, which may be precipitated from its solution by dilute acids. This body is mucin. If the ground substance of the different connective tissues after the removal of mucin is boiled in water, they nearly all yield substances somewhat similar to glue; hence they are called collagenous bodies.

We will take these up in turn.

1. *Mucin*.—Mucin, or the cement substance, is found in all mucous secretions as a result of special cell action, and in the tissue of mollusks, and is the substance to which their tenacious character is due. It is found in embryonic connective tissue, and serves to bind together the fibres of tendons, and of connective tissue and epidermis, and is found

in synovial secretions. Mucin may be prepared from the salivary glands by making a watery extract, filtering and precipitating mucin by acetic acid; the precipitate may then be washed with water, with alcohol, and with ether to remove fat. Mucin may also be obtained from tendons by washing well, cutting up into small pieces, extracting them with water to remove soluble albuminous bodies and salts, and then allowing them to stand for several days in lime- or baryta-water. After filtration, acetic acid will precipitate the mucin, which at first is granular, but afterward flocculent in appearance, and which may be washed with dilute alcohol or dilute acetic acid. It also may be prepared from ox-gall by precipitating with its own volume of alcohol to remove the coloring matter and proteids, dissolving the precipitate in lime-water, after washing with fresh alcohol, and precipitating the mucin from its solution in lime-water by acetic acid.

When freshly precipitated, mucin is a glutinous body which may be suspended but not dissolved in water. Mucin is soluble in concentrated but not in dilute mineral acids. It is also soluble in liquor potassæ and lime-water, and the solution is viscid and nearly neutral. When in solution it is not coagulated by boiling, but is precipitated in an insoluble form by acetic acid. Its solutions are precipitated by mineral acids, the precipitate being soluble in a slight excess of acid. It is not precipitated by metallic salts, with the exception of acetate of lead. When boiled for twenty or thirty minutes with dilute sulphuric acid it acquires the power of reducing the ordinary sugar tests. It again loses this power on prolonged boiling. A body similar to acid albumen is formed at the same time. No precipitate is produced with solutions of mucin by acetic acid and potassium ferrocyanide unless other albuminoids are also present. It gives no precipitate with mercuric chloride, and does not give the biuret reaction for albuminous bodies; with Millon's reagent it gives a red color. It therefore possesses several properties which are divergent from those of ordinary albuminous bodies, and is evidently a proteid body modified through the differentiation of the protoplasm of the cells of the connective-tissue group.

Mucin appears to be digested by pancreatic but not by gastric juice. Mucin is not soluble in water or alcohol, but swells up very much in the former, particularly in the presence of certain salts. When the mixture is filtered part of the mucin often passes through, and causes a turbid precipitate. The mixture in water possesses no viscosity; it, however, becomes clearer and more tenacious if sodium chloride is added.

2. *Collagenous Albuminoids*.—Collagenous albuminoids, of which gelatin is the type, are albuminous bodies found in connective tissue, cartilage, and bone. They contain a little less carbon and more nitrogen

than the true albuminous bodies. They are termed gelatinous because gelatin, which is formed by the action of boiling water on these tissues, is the most important representative of the group. It contains—

- a. Collagen.
- b. Gelatin.
- c. Chondrogen.
- d. Chondrin.

a. *Collagen*, or gelatinous substance, forms the organic basis of bones and teeth, and of the fibrous parts of tendons, ligaments, and fascia. It derives its name from the fact that by prolonged boiling it is converted into gelatin or glue (*Κολλά*). Collagen is prepared from bones by soaking in repeated changes of dilute hydrochloric acid; or from tendons by removing mucin by means of lime- or baryta-water, then by repeated washing with water, and finally with very dilute acetic acid. When fresh it is soft, but it shrinks and becomes hard when dry, or when alcohol is added. Collagen is insoluble in cold water; it swells up on dilute acids, and becomes transparent; through the prolonged action of dilute acids collagen dissolves, the solution containing gelatin and acid albumen, the latter, perhaps, being produced by the action of the acid on the residual matter of the connective-tissue cells. It dissolves in liquor potassæ, and in boiling dilute acids or in boiling water it dissolves and is rapidly converted into gelatin.

b. *Gelatin*.—Gelatin is prepared, as already indicated, by boiling collagen, or any of the connective-tissue group, in water, and when the solution cools it forms a jelly the consistence of which depends upon the percentage of gelatin present.

Gelatin, prepared as indicated above, is a product of the transformation of connective tissue by the prolonged action of boiling water. It is favored by high temperature ( $120^{\circ}$  C.), as in Papin's Digester, and the presence of a minute quantity of acid. When dry it forms a yellowish or, if pure, a transparent, tasteless solid, closely resembling a gum in its general appearance and characteristics. It is insoluble in cold water, but when immersed in cold water is able to absorb by imbibition forty times its own weight. It then will form a stiff, tenacious, jelly-like mass. If dry gelatin is boiled in water, it is readily dissolved, and when the solution in water cools the gelatin sets into a stiff jelly if more than 1 per cent. of gelatin is present, the consistence of the jelly depending upon the quantity of gelatin dissolved. When boiled for a long time in water, or if boiled with an acid or alkali, this property of gelatinizing is lost and two peptone-like bodies result.

Gelatin is insoluble in alcohol, ether, and chloroform. It is soluble in warm glycerin, such solutions having the power of gelatinizing when cooled.

In solution gelatin rotates the plane of polarized light to the left ( $-130^{\circ}$  at  $25^{\circ}$  C.). In watery solutions gelatin is precipitated by tannic acid, alcohol, and mercuric chloride; but not by acetic acid, which serves to distinguish it from chondrin; nor by potassium ferrocyanide and acetic acid, which separates it from other proteids; nor acetate of lead, which precipitates chondrin. When boiled with cupric sulphate and potassium hydrate, the blue solution becomes red without depositing oxide of copper. Gelatin readily undergoes putrefaction, and among the products leucin, ammonia, and some of the fatty acids are found.

*c. Chondrogen.*—Chondrogen is found in the intercellular substance of hyaline cartilage, and in the cartilage of bone before ossification. It derives its name from the fact that when boiled with water it forms chondrin,—a point which serves to distinguish it from fibro-cartilage, which, when treated in the same way with boiling water, forms gelatin, and not chondrin. Chondrogen is insoluble in cold water, but if dried beforehand, when immersed in cold water will swell up slightly. It swells very slightly in acetic acid, and may be dissolved by the concentrated mineral acids and caustic alkalis. When subjected to prolonged boiling with water it dissolves and forms an opaline solution, which forms a jelly when cooled.

*d. Chondrin.*—As just stated, chondrin is the result of prolonged boiling of chondrogen in water. When solutions of chondrin in water cool they form a stiff jelly, which is insoluble in cold water, but soluble in alkalis and ammonia. When solutions of chondrin are evaporated, a hard, translucent, yellowish, gummy mass results, which is insoluble in alcohol and ether, swells slightly in cold and dissolves tolerably readily in hot water and solutions of the alkalis. Prolonged boiling of watery solutions of chondrin destroys its power of gelatinizing, though the other properties of chondrin are not thereby altered. It is precipitated from its solutions by alcohol. It differs from gelatin in that it is precipitated by the mineral acids even when they are dilute; an excess of the reagent dissolves the precipitate. It is also precipitated by solutions of sulphurous acid. It is precipitated by acetic acid, the precipitate not being soluble in excess unless some alkaline salt be present. It is precipitated in abundant flocculi by solutions of alum, which readily dissolve in an excess, and the fluid becomes clear and transparent. It is precipitated with acetate and subacetate of lead, nitrate of silver, and cupric sulphate. Tannic acid and chlorine water precipitate it, as in the case of gelatin. It rotates the plane of polarized light to the left. Chondrin also is readily decomposable, and when subjected to prolonged heat with concentrated hydrochloric acid is decomposed, with the formation of nitrogenous compounds which have the power of reducing the cupro-potassium test; a body resembling acid

albumen is formed at the same time. The same changes follow prolonged boiling with dilute sulphuric acid. There are some grounds for supposing that chondrin is not an individual albuminoid, but that it is rather a mixture of gelatin, mucin, and salts, since its general characteristics are similar to what might be possessed by a combination of these bodies. All the connective tissues, therefore, possess a body which may be transformed into gelatin by boiling, and a cement substance, mucin.

The following statements represent in a few words the distinctive characteristics of mucin, chondrin, gelatin, and albumen :—

*Mucin*.—Precipitated by acetic acid, the precipitate is not dissolved by sodium sulphate.

*Chondrin*.—Precipitated by acetic acid, the precipitate is dissolved by sodium sulphate. Precipitated by lead acetate, alum, silver nitrate, and copper sulphate.

*Gelatin*.—Not precipitated by acetic acid, nor by acetic acid and potassium ferrocyanide, nor by lead acetate.

*Albumen*.—Dissolved by acetic acid, the solution is precipitated by potassium ferrocyanide, or by the addition of alkaline salts and heat.

Gelatin and chondrin are mostly to be recognized by their hot solutions forming a jelly when cooled. This, as already mentioned, is not invariably the case, as the property is lost by prolonged boiling, or by boiling with acids.

Closely allied to these collagenous albuminoid constituents of the connective tissues we meet with two other albuminoids which have many points in common with the above, with the exception that they do not form jellies when their solutions cool. These two bodies are *Elastin*, obtained from elastic tissue, and *Keratin*, a nitrogenous body of epithelial origin.

3. *Elastin*.—Elastin is the albuminoid principle contained in yellow elastic tissue. When yellow elastic connective tissue is boiled with water, after mucin has been removed, collagen is dissolved. The residue which remains is mainly composed of elastin. Elastin may be prepared by macerating the ligamentum nuchæ of the ox with ether, and then hot alcohol, to remove the fats; boiling water, to remove collagen and convert it into gelatin, and 10 per cent. caustic soda, and then acetic acid, allowing the boiling in water to continue for at least thirty-six hours, and in the acetic acid for at least six hours. After being subjected to the soda, the remaining tissue is again boiled with dilute acetic acid, well washed with water, and afterward the acid neutralized. After washing with hot water a brittle, yellowish mass is obtained, which recovers its elasticity and fibrous appearance if soaked in dilute acetic acid.

Elastin is insoluble in cold or boiling water, and offers remarkable resistance to chemical agents, unless boiled for a very long time. It is



insoluble in alcohol, ether, ammonia, or acetic acid, but it dissolves in caustic potash. Its solutions, however, do not gelatinize. When once dissolved in caustic potash the alkali may be neutralized without throwing the elastin out of solution. Tannic acid is the only acid which will precipitate it. Elastin gives the xantho-proteic and Millon's reactions, and its place among the albuminoids, therefore, seems warranted. When boiled for a long time with sulphuric acid it undergoes decomposition, with the formation of leucin and tyrosin. Elastin contains no sulphur.

4. *Keratin*.—The epithelial tissues of the animal body—nails, bone, epidermis, and epithelium, as well as horns and feathers—are mainly composed of a substance closely allied to albumen, as it gives leucin and tyrosin on decomposition, to which the name of keratin has been given.

Keratin contains sulphur in loose combination, and is in some respects closely related to elastin. Keratin is insoluble in alcohol and ether, swells up in boiling water, and is soluble in the caustic alkalis. It is not liable to decomposition. When one of the epithelial structures, such as horn, is subjected to the action successively of boiling water and alcohol, ether, and dilute acids, this substance, keratin, remains behind. But when so obtained it has by no means a constant composition, and it is probable, therefore, that keratin is rather a mixture of several nitrogenous bodies than a single albuminoid.

*Decomposition of the Albuminous Bodies*.—As already mentioned, albuminous bodies are the most unstable of all organic compounds, and we have the strongest reason for believing that, even while in the interior of animal and vegetable organisms, the albuminous constituents of protoplasm are continually the seat of various forms of decomposition which result in the production of simpler organic and inorganic forms. As we know but very little as to the molecular constitution of the proteid bodies, nothing positive can be said as to the complex chemical processes which result in the production of simpler organic forms. The subject has been a favorite field of research for organic chemists, but as yet scarcely anything tangible has resulted from their labors. An immense amount of valuable information has been attained, but the applicability of the facts so reached to physiological processes is not as yet clearly assured. The chief end products of the decomposition of proteids in the animal cell, which is essentially one of oxidation, are water, carbon dioxide, and urea. What the nature of the substances are which are intermediary between these end products and albuminoids we do not clearly know, except that certain ones, such as leucin, tyrosin, certain of the carbo-hydrates, such as glycogen and fats, are of constant occurrence and of great importance. The subject of the decomposition of albumen under various chemical and physical agents is an extremely interesting one, but it falls more within the province of works on organic chemistry.

In our study of the processes of metabolism of the animal body, in which we will attempt to trace the course of the food-stuffs after their entrance into the body and in their elimination as various effete products, this subject must necessarily be touched upon; the consideration of the part of this subject which is at all capable of practicable application will be deferred until then.

It may only be mentioned here that the simpler an organism the simpler must be the chemical changes in its constituents. Thus, we find that in the elementary vegetable organisms their entire structure is made up of protoplasm, which is practically almost solely albuminoid; we have then appearing chlorophyll, cellulose, starch, and in still higher forms the various sugar groups, vegetable acids, alkalies, etc. In the animal body a similar state of affairs holds. We may say that the body of an amœba is composed of simple albuminous matter. In the development of organs we have a development of supposed chemical derivatives of protoplasm, and the higher the state of development of the organism the more complex will be the changes which have resulted from the original protoplasm. As we have already mentioned, these cell-constituents are organic, nitrogenous and non-nitrogenous, and inorganic bodies. All of the substances which we have heretofore considered are examples of derivatives or modifications of protoplasm, and as protoplasm is essentially albuminous they are, therefore, the examples of a modification of albumen. In the waste of albuminous tissues we have an immense number of intermediary bodies, partly belonging to the various aromatic series, between albuminous bodies and the simpler end products, water, carbon dioxide, and urea. These bodies result from a progressive series of oxidations, and will receive consideration under the subject of Nutrition.

#### FERMENTS.

Various animal and vegetable cells will often be found to contain a class of bodies which are closely allied in composition to albuminous substances, since they contain carbon, nitrogen, hydrogen, oxygen, and sulphur. From the fact that they are able, under certain conditions, to produce reduction in the complexity of organic compounds with the action of water without acting through the development of chemical affinities, and without themselves undergoing change, such bodies are termed soluble ferments, and are derived directly from modifications of the protoplasm of the living organisms in which they originate. Although they are apparently allied to albuminoids in their chemical constitution, yet when purified they fail to give the proteid reactions; and although we may be pretty sure that such bodies are derived from the physiological splitting up of proteids, we have no exact knowledge as to their structure. When obtained dry by various processes, which

will be considered under the study of the individual ferments in the section on Digestion, they are amorphous, colorless powders, which are highly soluble in water, resemble gums somewhat in appearance, and are precipitated from their solutions by alcohol, corrosive sublimate, and lead acetate. One of their remarkable points of contrast to albuminous bodies is that, when precipitated from solution in water or glycerin by absolute alcohol, if the precipitates are filtered off and dried, they are again perfectly soluble in water, and are still capable of exerting all their actions; hence, their precipitation is more of a mechanical nature than chemical. Further, when the precipitates formed by the above reagents are decomposed by sulphuretted hydrogen a watery extract of the precipitate will still preserve the original properties of the ferment; in other words, the soluble matter is restored to the water unchanged, and still preserves its specific properties. The ferments are with difficulty freed from albuminoids, and it is in all probability the albuminoid which is chemically precipitated from their solutions by the above reagents, and which in this precipitation carries with it mechanically the ferment. Consequently, this property of the ferment of being precipitated by the above reagents is dependent upon the albuminous bodies which are nearly always associated with it. We shall, further, find that this property of being carried down by precipitates from solutions is the basis of nearly all the methods which have been employed for the isolation of the different digestive ferments.

Ferments obtained from the animal and vegetable kingdom may have the most varied functions. We have but little information concerning the soluble ferments from a chemical point of view. We do not even know whether they all have the same chemical composition, and differ only in some unknown manner in their specific activity. They only are active at a temperature below  $60^{\circ}$  C., and when in the presence of water; at the temperature of boiling water they are permanently destroyed; at lower temperatures their activity is suspended. They do not themselves appear to be influenced in the phenomena of fermentation which they inaugurate; ferments are also inactive in the presence of various chemical agents, such as alcohol, the stronger mineral acids, and all the large group of substances which are known as antiseptics. Ferments may be of two kinds; either organized ferments, such as the yeast-plant, malt, vibrios, bacteria, etc.,—substances which are themselves elementary, cellular organisms,—or the so-called unformed ferments, or enzymes, substances which invariably originate in the interior of animal and vegetable protoplasm, and are soluble and not organized.

This latter group comprises all the ferments with which we are particularly interested. Their specific action is in many cases closely analogous to that of the formed ferments. There are, however, several points

of contrast between them. Organized ferments are destroyed by compressed oxygen; soluble ferments are not. Solutions of borax prevent the action of the unformed ferments, but are without influence on the formed ferments. The organized ferments during their action reproduce themselves; the soluble ferments do not act. All the soluble ferments have a high percentage of ash, sometimes as much as 8 per cent. Under the action of ferments, fermentable bodies yield substances whose nature is dependent on that of the ferment. So that any individual fermentable substance under the influence of different ferments will split up into different substances.

The following are the important ferments found in animal organisms: *ptyalin*, found in the saliva and converting starch into sugar; *pepsin*, found in the gastric juice and in the presence of a dilute acid converting albuminous bodies into peptones; the *milk-curdling ferment*, or rennet, found in the gastric juice and coagulating milk in neutral or acid media; the *amylolytic ferment* of pancreatic juice, converting starch into sugar; the *proteolytic ferment* of pancreatic juice, converting proteids into peptones in an alkaline medium; the *fat-ferment* of pancreatic juice, splitting up neutral, fatty bodies into fatty acids; the *milk-curdling ferment*, also said to exist in pancreatic juice; the *invertive ferment*, found in intestinal juice and converting cane-sugar into inverted sugar; and the *liver-ferment*, converting glycogen into sugar. The general subject of the nature of the changes produced by these substances will be considered in the next section; the mode of action of the digestive ferments will be considered under the subject of Digestion.

## B. NON-NITROGENOUS ORGANIC CELL-CONSTITUENTS.

I. CARBO-HYDRATES. — The carbo-hydrate tissue-constituents are composed of carbon, hydrogen, and oxygen, the latter two in the proportion to form water. Although occasionally present as constituents of animal cells, they are almost exclusively produced by the vegetable kingdom, and present many interesting examples of isomerism. They may be divided into the three following groups:—

- (a) STARCHES ( $C_6H_{10}O_5$ ).
- (b) GRAPE-SUGAR GROUP ( $C_6H_{12}O_6$ ).
- (c) CANE-SUGAR GROUP ( $C_{12}H_{22}O_{11}$ ).

The members of the first group may, through the action of dilute acids or the diastatic ferments, be transformed in great part into the second group. The latter undergoes alcoholic fermentation when in contact with malt.

(a) THE AMYLOSES, OR STARCH GROUP  $n(C_6H_{10}O_5)$ .—This group includes starch, dextrin, glycogen, cellulose, granulose, and inulin.

1. *Starch*, or *amylum* ( $n(\text{C}_6\text{H}_{10}\text{O}_5)$  or  $\text{C}_{18}\text{H}_{30}\text{O}_{15}$ ), is almost universally distributed throughout the vegetable kingdom, and is the first evidence of the decomposition of  $\text{CO}_2$  of the atmosphere by vegetable cells ( $6 \text{CO}_2 + 5 \text{H}_2\text{O} = \text{C}_6\text{H}_{10}\text{O}_5 + 12 \text{O}$ ). It is particularly abundant in the cereals, in seeds of the leguminous plants, and in the potato, and in certain roots, tubers, soft stems, and seeds. It forms rounded masses which lie in the plasma of the plant-cells, becoming converted, in the process of germination in seeds and bulbs, into soluble dextrin and sugar. Under

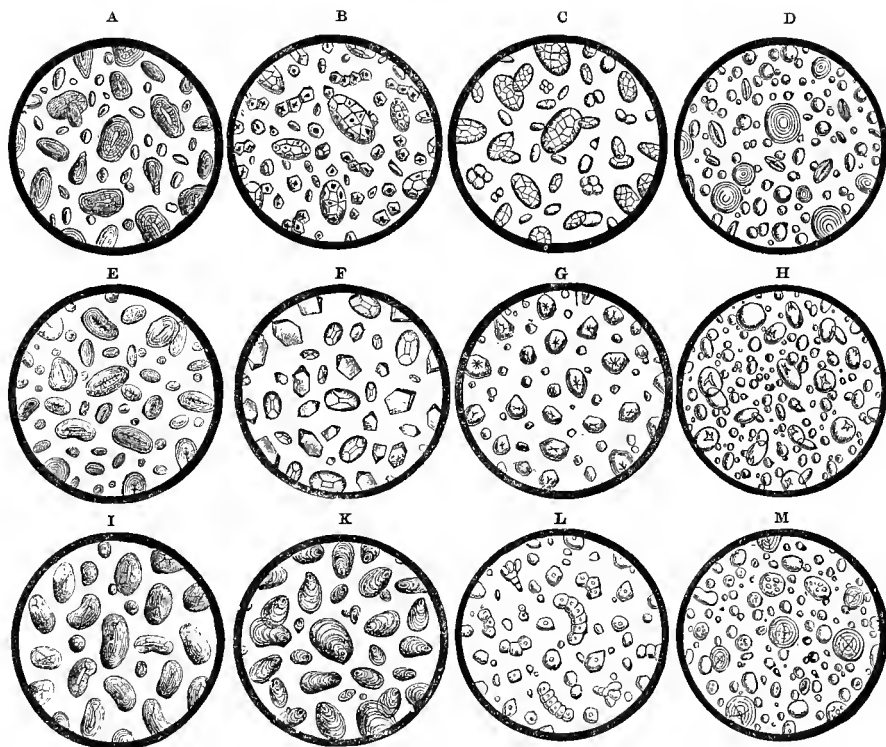

FIG. 54.—STARCH-GRANULES, AFTER LOEBISCH.

A, pea-starch; B, rice-starch; C, oat-starch; D, wheat-starch; E, bean-starch; F, millet-starch; G, corn-starch; H, rye-starch; I, lentil-starch; K, potato-starch; L, buckwheat-starch; M, barley-starch.

microscopic examination starch appears as rounded, glistening granules composed of a series of concentric rings. These granules vary in appearance and size according to their source. In size they may vary from 0.004 mm. in diameter, as when found in beet-seeds, to 0.16 mm., as in potato-starch (Fig. 54).

In the following table (after Karmarsch) the diameter of the starch-granules from different sources is given. Microscopic examination of

different "meals," by the shape and size of the granules, will thus permit of the recognition of adulteration with inferior meals:—

	Mm.
Starch-granules from Potatoes (average),	0.140 (0.10-0.185).
.. " Arrowroot, ..	0.140
.. " Sago, ..	0.07
.. " Beans, ..	0.063
.. " Peas, ..	0.050
.. " Wheat, ..	0.050
.. " Rye, ..	0.036
.. " Oats, ..	0.031
.. " Corn, ..	0.02-0.03
.. " Tapioca, ..	0.028
.. " Rice, ..	0.022
.. " Barley, ..	0.025
.. " Buckwheat, ..	0.009

The striated appearance is due to the fact that starch is composed of two substances,—cellulose and granulose, arranged in concentric layers, the cellulose always being external. Granulose stains blue with iodine,—not by the formation of a chemical compound, but by the deposit of the iodine around the starch-molecules,—and cellulose stains a faint yellow. These two substances may be separated by digesting, at 60° C., one part of starch in forty parts of saturated salt solution containing 1 per cent. of free hydrochloric acid. The granulose then passes into solution, while the cellulose remains. Examined in this way, potato-starch has been found to contain 5.7 per cent. cellulose, wheat-starch 2.3 per cent., and arrowroot 3.10 per cent. Under the action of diastatic ferments granulose is converted into sugar, while cellulose remains unaltered. A third substance has been distinguished in starch which is termed erythrogranulose, and it differs from granulose in taking on a red coloration when treated with iodine. It has a stronger affinity for iodine than granulose. Hence, when starch-mucilage is treated with very dilute iodine solution a red color is produced, but when a large quantity of iodine is added, a deep-blue coloration, from the fact that the reaction of the iodine with the granulose masks the erythrogranulose reaction.

Pure starch is a white, tasteless, and odorless substance which is almost entirely insoluble in cold water. In boiling water the granules swell up from the imbibition of water by the granulose, the cellulose envelopes burst, and the granulose dissolves. It is to the presence of the cellulose envelope that the insolubility of raw starch in cold water is due. When the cellulose membranes are destroyed or comminuted, as by grinding with powdered glass, a part of the granulose is then dissolved in the water, and by repeated washing nearly all the granulose may be removed and the cellulose envelopes alone remain. In boiling water, while the starch is said to be soluble, the condition is more strictly one of a high degree of imbibition of the starch. Like other colloids, starch is incapable of dialysis, and forms a mucilaginous emulsion. A solution

of granulose in water rotates the plane of polarized light strongly to the right. According to Payen, when starch is placed in a saturated solution of potassium iodide, or potassium bromide, it swells up to a stiff jelly and increases twenty-five to thirty times in volume. This mass may then be dissolved in water, with only a slight residue of starch-cellulose. Dilute acids will also dissolve granulose.

The alteration of starch through the action of the diastatic ferments will be described under the consideration of the action of the digestive juices on the different food-stuffs. When starch is boiled with dilute acids similar products result.

When starch is subjected to dry heat at  $150^{\circ}$  to  $160^{\circ}$  C. it is gradually transformed into dextrin. When moisture, however, is present, quite different compounds result, the starch being completely decomposed, with the formation of carbon dioxide, formic acid, etc. In still higher temperatures small quantities of brenzcatechin are formed,—a fact which is of especial interest, as it indicates the possibility of the conversion of carbo-hydrates into members of the aromatic series. Oxalic acid results from heating starch with nitric acid.

The test for starch is iodine, which, with raw starch, or with starch-mueilage, gives a deep-blue coloration which disappears on heating, to return on cooling, if the heat has not been too prolonged. Starch is also precipitated from its solutions by tannic acid in the form of a yellow, flocculent sediment which is dissolved on heating.

2. *Cellulose* ( $C_6H_{10}O_5$ ).—Cellulose forms the wall or cell-membrane of vegetable cells, and may be regarded as the skeleton of plants. It is formed by vegetable protoplasm out of other carbo-hydrates, such as starch and sugar, and is capable of being again reconverted into other members of the same group. It only very seldom occurs in a perfectly pure condition. Young plants contain purer cellulose than older plants; in the latter there is a greater percentage of ash. Cotton and Swedish filter-paper are forms of comparatively pure cellulose. Cellulose is very hygroscopic, but ammoniacal cupric oxide solution (Schneider's reagent) is its only solvent. In sulphuric acid it first swells up and then dissolves and forms a substance which is stained blue with iodine. This substance is termed amyloid, but must not be confounded with the amyloid substance of pathologists, which has been already described under the albuminous bodies. Cellulose is also capable of being converted into the sugar group by prolonged action of acids. Woody fibre is a modified form of cellulose, which is due to the deposit within the cellulose of nitrogenous substances; it then has acquired a greater power of resistance to various mechanical and chemical agents. In woody fibre cellulose has become associated with a body richer in carbon and poorer in oxygen than cellulose, and which is termed lignin; its formula is  $C_{10}H_{24}O_{11}$ . The lignin

constitutes about 50 per cent. of wood, the other half being composed of cellulose, upon which the lignin is deposited. Iodine stains cellulose of a yellowish color unless hydriodic acid, potassium iodide, zinc iodide, sulphuric acid, phosphoric acid, or zinc chloride are added with the iodine. With any of these reagents, combined with the iodine, the cell-membrane or cellulose is stained blue. It is not known, however, in what way these agents assist the reaction.

3. *Dextrin* ( $C_6H_{10}O_5$ ).—Dextrin, or British gum, is the name given to a group of substances which may be regarded as intermediary products in the conversion of starch into sugar. It may also be obtained by boiling starch with dilute acid, although in this operation the sugars are also obtained. There is some doubt as to whether it exists ready formed as a constituent of vegetable cells. In commerce it is manufactured by heating dry starch up to  $400^\circ$ . Through the action of the dry heat the starch becomes yellowish in color and soluble in water. Dextrin is insoluble in alcohol and ether; it should not reduce the sugar test unless, as is apt to be the case, it is associated with sugar. It rotates the ray of polarized light strongly to the right, from which it derives its name (dexter=right), and is readily converted by the action of dilute acids, or the diastatic ferments, into sugar. According to Bernard, dextrin is found in the blood of both the herbivora and carnivora, though in greater amount in the former. When found in the animal body it originates partly from the glycogen of the liver and partly from the food. The test for dextrin is the formation of a mahogany-red color when iodine is added to its solutions. When heated this color disappears and does not return on cooling,—a point of importance as serving to distinguish dextrin from glycogen, another member of this group. Dextrin is precipitated out of its watery solutions, which are always turbid, by alcohol, lime-water and ammonia, and acetate of lead. With iodine in solution in potassium iodide, dextrin gives a violet coloration.

4. *Glycogen*.—Glycogen, or animal starch, or, more properly speaking, animal dextrin, will be discussed at length under the subject of Special Physiology.

5. *Inulin* ( $C_6H_{10}O_6$ ).—In its composition and characteristics inulin is closely allied to starch. It is found in the roots of the *Lobeliaceæ*, *Campanulacæ*, and *Gordeniaceæ*; it owes its name to the fact that it was first discovered in the root of the *Inula helenium*. Dried dahlia-bulbs contain 42 per cent. of inulin. In the autumn inulin is found in greatest amount; in the spring it becomes converted into levulose. Inulin is only found dissolved in plant-juices, and never as a solid deposit; and since inulin by itself is insoluble in water, it must then owe its solubility to the presence of some other substance.

Inulin may be obtained by boiling dahlia-bulbs in water, enough



calcium carbonate being added to neutralize the acid reaction. After filtering and concentration, inulin separates from the extract in the form of crystals. By boiling with dilute acid, inulin is converted into levulose.

(b) **THE GLUCOSES, OR GRAPE-SUGAR GROUP**  $n(\text{C}_6\text{H}_{12}\text{O}_6)$ .—This group comprises grape-sugar, or dextrose, galactose, inosite, and levulose, or sugar of fruits.

1. *Grape-Sugar* ( $\text{C}_6\text{H}_{12}\text{O}_6 + \text{H}_2\text{O}$ ).—Grape-sugar, or glucose, is widely distributed throughout the vegetable kingdom, as a rule accompanying fruit-sugar, and is also normally found dissolved in many of the animal juices. It owes its name to its being found in grapes, where it is associated with levulose. It rotates the plane of polarized light to the right, and is consequently designated as dextrose. As a product of the action of the diastatic ferments on starch and the majority of the carbo-hydrates, it acquires an especial importance for the animal organism. Grape-sugar also occurs in the vegetable kingdom associated with other bodies to form *glucosides*, from which it may be separated by treatment with acids or ferments. Most of these bodies contain only C, H, and O; some, such as solanin and amygdalin, contain N in addition, and in others S is also found. Grape-sugar seldom occurs in well-formed crystals, but ordinarily in crumbly, white masses, which, under the microscope, are seen to consist of small, rhombic tables. It has a sweetish taste, and is soluble in water and alcohol. At  $100^\circ \text{C}$ . grape-sugar melts and loses its water of crystallization. At higher temperatures it becomes brown, and is converted into caramel,  $\text{C}_{12}\text{H}_{18}\text{O}_9$ . At still higher temperatures it is completely decomposed into CO,  $\text{CO}_2$ , marsh-gas, acetic acid, acetone, aldehyde, and other products. If heated with a strong solution of caustic potash grape-sugar decomposes, with heat production, into lactic acid, breuzcatchin, formic acid, and other products, accompanied by the development of a brown color. If nitric acid is then added, an odor of burnt sugar and formic acid is produced. Grape-sugar is readily soluble in water, but less so than cane-sugar. It is also less sweet than cane-sugar. It is very slightly soluble in alcohol and insoluble in ether. Glucose combines with different acids and bases to form glycosates or saccharates. Grape-sugar has a great affinity for oxygen, and it is therefore a powerful reducing agent. This property is seen in the reduction of cupric oxide in an alkaline solution, and has been made use of for a qualitative and quantitative test of its presence. Thus, if one molecule of grape-sugar is mixed with five molecules of cupric sulphate and eleven molecules of sodic hydrate the copper will be precipitated completely, and the filtrate will be free from sugar. In watery solutions grape-sugar is unstable, since it is readily decomposed under the action of ferments. This fermentation, produced under the influence of yeast

or malt, is termed alcoholic fermentation, and is accompanied by the development of carbon dioxide, with small amounts of glycerin and formic acid. The fermentation caused by the lactic acid ferment, or decomposing nitrogenous matter, results in the final development of butyric acid.

Various tests have been proposed for the qualitative and quantitative estimation of grape-sugar. Of these it may be mentioned that in solutions of cupric hydrate in the presence of free alkalis, when subjected to boiling, grape-sugar reduces the cupric oxide into red or yellow anhydrous cuprous oxide (Trommer's and Fehling's test). Basic nitrate of bismuth is reduced by grape-sugar to bismuth oxide (Böttger's test). When boiled with half its volume of liquor potassæ grape-sugar solutions acquire a bright-brown color, due to the formation of melassic acid. If nitric acid is now added, the odor of formic acid is evolved (Moore's test). For the methods of quantitative estimation of sugar solutions and further details as to testing for sugar, references must be made to text-books on physiological chemistry.

2. *Lævulose*.—As with dextrose and cane-sugar, lævulose is also abundantly distributed through the vegetable kingdom, especially in the acid fruits. It forms a colorless, non-crystallizable syrup, with almost as much sweetness as cane-sugar. It derives its name from its property of rotating the plane of polarized light strongly to the left (at  $15^{\circ}$  C. =  $-106^{\circ}$ ). It is as powerful a reducing agent as grape-sugar. When placed in contact with malt it undergoes alcoholic fermentation without first being converted into dextrose. Lævulose is also formed in what is termed the inversion of cane-sugar. When cane-sugar is subjected to the action of dilute mineral acids, or the intestinal juices of animals, it is turned into the so-called inverted sugar, which may be regarded as a mixture of equal portions of dextrose and levulose.

3. *Inosite* ( $C_6H_{12}O_6 + 2H_2O$ ).—Inosite is a saccharine body which is found in the heart-muscle and in most of the organs of the body, especially of the horse and ox. It is also found in certain plants, especially in the unripe fruit of the *Papilionaceæ*. Inosite crystallizes in long, colorless, efflorescent tables, and in cabbage-like aggregations, which when dried break down into a white mass. It has a sweetish taste, is easily soluble in water, but insoluble in alcohol and ether. Its solutions are optically inactive. It does not reduce the copper test for sugar. It is incapable of undergoing alcoholic fermentation, and is not decomposed by caustic alkalis or weak acids. It is precipitated from its solutions by lead acetate and ammonia. If inosite is evaporated almost to dryness on a strip of platinum-foil with nitric acid, and the residue moistened with a little ammonia and calcium chloride solution, and again evaporated, a beautiful red coloration is produced (Scherer's

test). By means of this test it is claimed that the presence of 0.005 grain of inosite may be recognized. In contact with decomposing organic matters inosite may undergo lactic acid or butyric acid fermentation.

(c) SACCHAROSES, OR CANE-SUGAR GROUP  $n(C_{12}H_{22}O_{11})$ .—This group comprises saccharose, or cane-sugar, lactose or milk-sugar, maltose or malt-sugar, and arabin, found in gum arabic.

1. *Saccharose, or Cane-Sugar* ( $C_{12}H_{22}O_{11}$ ).—This substance is found widely distributed throughout the vegetable kingdom in the juices of various plants, trees, and fruits. It is derived from changes occurring in starch in the ripening of the fruits. Cane-sugar is said to be the origin of all forms of vegetable sugar, which in the process of vegetation is partly broken up into glucose and levulose. Cane-sugar crystallizes in large, colorless rhomboidal prisms, which are soluble in one-third their weight of water, the solubility being greatly increased by heat; thus, at  $0^{\circ}C.$ , 100 grammes of a saturated sugar solution contain 65 grammes of sugar; at  $14^{\circ}C.$ , 66 grammes; and at  $40^{\circ}C.$ , 75.75 grammes. The solutions of cane-sugar rotate the plane of polarized light to the right ( $+73.80^{\circ}$ ); with various metallic salts and oxides it forms chemical compounds, which are termed saccharates. When carefully heated to  $160^{\circ}C.$ , it melts into a clear, pale, yellowish fluid, which on cooling forms a transparent, amorphous mass—the so-called barley-sugar. If the temperature of  $160^{\circ}$  is prolonged, cane-sugar is transformed into levulose and glucose. When subjected to a higher temperature with moisture more profound chemical changes are produced. Carbon dioxide is developed, and a firm, carbonaceous mass containing a trace of brenzeatechin and caramelin may result. In the dry distillation of sugar large quantities of carbon dioxide and small quantities of carbon monoxide and marsh-gas are set free, while the distillate contains acetic acid, as well as substances allied to aldehyde and acetone. Under various circumstances, such as the action of dilute mineral acids, ferments, and prolonged heating of a watery solution in a closed vessel, cane-sugar becomes inverted; that is, divided into a mixture of glucose and levulose.

Cane-sugar is not directly fermentable, but when converted into dextrose and levulose may then undergo fermentations similar to those of grape-sugar. Cane-sugar is easily acted on by oxidizing agents, but less readily than is grape-sugar. It does not reduce alkaline eupric hydrate solutions, nor is it precipitated by acetate of lead, although ammoniacal lead acetate precipitates it. Strong sulphuric acid chars cane-sugar, but dissolves grape-sugar. Cane-sugar is not directly assimilable by the animal economy. When introduced into the intestinal canal it is first changed into invert sugar before being dissolved. When injected into the veins it is eliminated unchanged by the kidneys.

2. *Maltose*.—Maltose is the form of sugar which results from the action of a diastatic ferment, or dilute acids with heat, on starches. It resembles cane-sugar in many respects, but has the power of reducing alkaline solutions of cupric hydrate, although its reducing power is one-third less than that of dextrose. It rotates the plane of polarized light strongly to the right, even more so than dextrose ( $+150^{\circ}$ ). It is capable of undergoing fermentation, and, through the action of dilute acids with heat, may be converted into dextrose. It is this form of sugar which in all probability invariably results from the digestion of the carbo-hydrates in the animal body under the influence of an amylolytic ferment, and will be again alluded to in the chapters on Digestion.

3. *Lactose, or Milk-Sugar* ( $C_{12}H_{22}O_{11} + H_2O$ ).—Lactose resembles cane-sugar closely in its properties, but is more stable, and, like dextrose, has the power of reducing the sugar tests. It rotates the plane of polarized light to the right, the degree of the rotation diminishing with the age of the solution. It is found only in milk; it crystallizes in hard, white, rhomboidal prisms; is soluble in six parts of cold and two and one-half parts of hot water; insoluble in alcohol, ether, and only slightly sweetish. It is only fermentable with difficulty. It will again be alluded to more at length under the subject of Milk.

4. *Arabin*.—Arabin is capable of being converted by means of dilute sulphuric acid into a sugar which is termed arabinose, and is closely analogous to dextrose. It is the main constituent of gum arabic. It polarizes light to the right, reduces the copper sugar tests, but is incapable of fermentation.

II. HYDRO-CARBONS, OR FATS.—Fats may be either of animal or vegetable origin, and occur either deposited within the interior of cells, or in the form of solution or suspension in animal or vegetable juices. In the animal body fat is especially formed in the cells of the connective-tissue group, either through fatty degeneration of the protoplasmic cell-contents of the connective-tissue corpuscles, or by the absorption of fat brought to them by the cells by a vital process analogous to the feeding of the amœba, or the absorption of fat from the intestinal canal of animals. In the formation of adipose tissue by either of these processes the protoplasmic cell-contents gradually become displaced, the nucleus lying against the cell-membrane, while the cell-contents consist mainly of a globule of oil. During the life of the organism the fatty contents of cells are always of a fluid consistence, and, in the case of animals, only solidify when cooled below a certain point, which is characteristic of the different individual fats. In the vegetable cell the fats remain permanently fluid, with but few exceptions, in the form of oils. As animal fats solidify, a partial process of crystallization into groups of acicular crystals often takes place. When within the interior of cells fats are

stained black by perosmic acid; this reagent is, therefore, a delicate microscopic test for the detection of fats, and, since fat is a constant constituent of nervous tissue, is used as a means of recognizing this tissue. In vegetable cells fat is partly produced directly from  $\text{CO}_2$  and  $\text{H}_2\text{O}$ , and also through the transformation of starch; the latter is its mode of origin in oily seeds and fruits where it is stored up until required for germination and growth.

The natural fats are, without exception, compounds of a triatomic radical, propenyl or glyceryl, combined with three atoms of a monatomic fatty acid, namely, either palmitic, stearic, or oleic acids. The fats formed by the union of these acids with the radical glyceryl are termed palmitin, stearin, and olein.

A few fats contain other glycerin ethers, such, for example, as are found in butter. At the ordinary temperatures, fats are either solid, like tallow; semi-solid, like butter and lard; or fluid, like oils. These differences depend upon the differences in their composition. The more stearin or palmitin there is present, the more the fats tend to solidify; while the more olein there is, the more fluid are they. All fatty bodies become fluid considerably below the temperature of boiling water. In the pure condition fats are odorless, tasteless, and of alkaline reaction. When kept in contact with the air, they become rancid from the setting free of fatty acids and the oxidation of glyceryl, with the resulting production of volatile fatty acids and glycerin. In this process they acquire odor and taste, and have an acid reaction. Fats have a lower specific gravity than water. All fats are completely insoluble in water, but when water contains bodies such as gum or albumen in solution, fats will then remain mechanically suspended in the form of an emulsion, which is merely the breaking up of the oil into minute globules. When fluid, fats render paper which is coated with them transparent (grease-spots). Many of the fats are soluble in alcohol, especially when hot, and all are soluble in ether, chloroform, the volatile oils, benzol, and carbon disulphide. When fats contain small quantities of free fatty acids they will form a permanent emulsion with sodium carbonate solution. This property has been used by Brücke as the means of detecting the presence of free fatty acids, and, in all probability, the production of an emulsion in the digestion of fats by pancreatic juice is due partly to this fact. When subjected to dry distillation, acrolein is formed in conjunction with other acrid and aromatic products. When fats are boiled with alkalies, soap is produced by union of the alkali with the fatty acid, forming a soluble salt, or *soap*, while glycerin passes into solution. The glycerin may likewise be displaced by inorganic bases, such as lead, and glyceryl hydrate or glyceryl alcohol (glycerin) is produced. This replacement of glyceryl by other bases is termed saponification. The presence of glycerin may

be recognized by the development of acrolein when boiled with glacial phosphoric acid. Under the influence of certain ferments fats split up into glycerin and a fatty acid by combining with the elements of water, thus:—

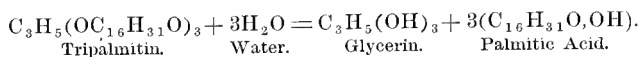

The composition of the four principal fats is represented in the following formulæ:—

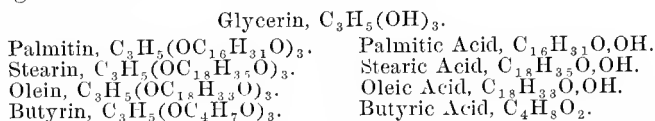

*Stearin*.—Stearin is the chief constituent of the more solid fats. Its melting point varies between  $53^\circ$  and  $66^\circ$  C. It is insoluble in cold alcohol and in ether, but is soluble in both when boiled. It never occurs in the vegetable fats. It crystallizes from boiling alcoholic solutions in brilliant quadrangular plates.

*Palmitin*.—This fat is the chief component of the animal fats, but also is largely found in fats of vegetable origin. It is more soluble in cold and hot ether and alcohol than is stearin. Its melting point is  $45^\circ$  C. It crystallizes in fine needles.

*Olein*.—When pure, olein is a colorless oil which is fluid at the ordinary temperature and solidifies at  $0^\circ$  C. When exposed to the air it absorbs oxygen and becomes yellow. It dissolves all other fats, especially at  $30^\circ$  C. It is soluble in cold absolute alcohol and ether. It is more abundant in vegetable than in animal fats.

*Butyryn*.—Butyryn is found in butter. It is a pungent liquid; and when it decomposes, butyric acid, to which the odor and taste of rancid butter are due, is set free.

*Spermaceti* is found in the cranial sinuses of whales, and is a derivative of cetyl alcohol ( $\text{C}_{16}\text{H}_{33}\text{O}$ ). This is a solid body which melts at  $50^\circ$  C., and when saponified yields in addition stearic, myristic, and lauric acids.

Bees-wax is also a form of animal fat, which is likewise capable of saponification, the radical here being cetyl alcohol. Waxes possess many points in common with the fats, but are not acted on by the digestive juices.

*Margarin*.—Formerly this name was given to a substance which was supposed to be a special fat, but which is now known to be a mixture of stearin and palmitin. It occurs in the form of needle-like crystals which are often found in the interior of fat-cells, and which were supposed to be a glycerin ether of a hypothetical acid,—margaric acid.

The percentage composition of the animal fats varies only within narrow limits :—

	C.	H.	O.
Horse-fat, . . . . .	77.07	11.69	11.24
Ox " . . . . .	76.50	11.90	11.59
Sheep " . . . . .	76.61	12.03	11.36
Pig " . . . . .	16.54	11.94	11.52
Dog " . . . . .	76.63	12.05	11.62
Cat " . . . . .	76.56	11.90	11.44
	The Average.		
	76.5	12.0	11.5
Formula, $C_{62}H_{99}O_6$ .			

Of the different domestic animals, horse-fat is yellow, and begins to melt at 30° C. Its essential component is olein. Ox-fat contains principally stearin and palmitin, and but little olein. It is white, melts at 43° C., and solidifies after melting at 36° or 37° C. Mutton-fat contains principally stearin. Its melting point is 46°. It solidifies at from 35° to 40° C. Pig-fat is white, and contains large quantities of olein; melts at 41°, and solidifies after melting at about 30° C.

Adipose tissue is made up as follows :—

	Water.	Membranes.	Fat.
Ox, . . . . .	9.96	1.16	88.88
Sheep, . . . . .	10.48	1.64	87.88
Pig, . . . . .	6.44	1.35	92.21

### C. INORGANIC CELL-CONSTITUENTS.\*

The inorganic constituents of cells enter them already formed, and, as a rule, leave them without undergoing change. About the only exceptions to this statement are found in the case of carbon dioxide, the water formed by oxidation of the hydrogen of organic compounds, and the sulphur of various excretory products, which, eliminated through the intestines and kidneys, originates in the sulphur of albuminous compounds. The inorganic cell-constituents differ in no way from similar compounds found elsewhere. They originate in the earth and atmosphere, become constituents of vegetable organisms, and then, through absorption in foods, enter into the composition of animal bodies. The amount of inorganic matter found in cells, including of course water, is greater in weight than the organic cell-constituents. The inorganic constituents may exist in the form of water, salts, gases, and certain elements whose exact mode of combination has not yet been thoroughly determined. All the inorganic constituents of the body, in some period of their existence as such, are in the form of solutions. They enter the organism in solution, are deposited

\* In the preparation of this section the author is especially indebted to Gorup-Besanez, "Lehrbuch der Physiologischen Chemie."

as constituents of tissues perhaps in the solid or even crystalline form, but are again eliminated from the body in solution; this applies not only to the salts, but also to the gases and acids. Many of the physical properties of various tissues depend almost solely upon their inorganic constituents. In this connection it is only necessary to mention the bones and teeth. Wherever cell growth is taking place certain salts are essential, since no form of protoplasm is able to carry on its existence without a supply of salts, the nature of which may differ in the case of different cell forms; thus, for example, calcium salts are not only essential for the development of the bone-cells, but accompany the albuminoids of all growing tissue; blood-corpuscles require iron and potassium phosphate, and all forms of cell growth require sodium chloride.

1. WATER (H<sub>2</sub>O).—Of the inorganic constituents of cells water is by far the most abundant, and is the most important. In fact, all organisms may be said to live in water; for if their entire body is not surrounded by water, all contain water in large amounts, and all their vital processes are dependent on watery solutions. Water is destined, by entering by imbibition into solid tissues, not only to preserve the physical condition which is essential to the preservation and manifestations of the vital phenomena of protoplasm, but it holds in solution many of the salts essential to the vital processes of the economy. It also constitutes a large proportion of the fluids of the body, such as the blood, lymph, chyle, and secretions. It is in greater amount in embryonic tissue, and decreases as adult life and old age are reached. In the higher animals it may exist in 70 per cent. or more, while in some of the lower forms of life as much as 90 per cent. may be reached. The amount of water in different organisms, and in the same organism at different times, is subject to very great variation. It not only constitutes the great part of the secretions of the animal body, but it also forms a large proportion of even the densest tissues of the animal or vegetable body. Thus, in the enamel of teeth two-tenths of one per cent. of water is present, while in dentine 10 per cent. and in bones 22 per cent. of water is found.

The following table represents the amount of water in 1000 parts of different animal tissues:—

Organs.	Water.	Solids.
Enamel, . . . . .	2	998
Ivory, . . . . .	100	900
Bone, . . . . .	216	784
Fat, . . . . .	299	701
Elastic tissue,	496	504
Cartilage, . . . . .	550	450
Liver, . . . . .	693	307
Bone-marrow, . . . . .	697	303
White brain-substance, . . . . .	700	300



Organs.	Water.	Solids.
Skin, . . . . .	720	280
Brain, . . . . .	750	250
Muscles, . . . . .	757	243
Spleen, . . . . .	758	242
Thymus, . . . . .	770	230
Nerves, . . . . .	780	220
Connective tissue, . . . . .	796	204
Heart, . . . . .	792	208
Kidneys, . . . . .	827	173
Gray brain-substance, . . . . .	858	142
Vitreous body, . . . . .	987	13
Fluids.	Water.	Solids.
Blood, . . . . .	791	209
Bile, . . . . .	864	136
Milk, . . . . .	891	109
Plasma, . . . . .	901	99
Chyle, . . . . .	928	72
Lymph, . . . . .	983	17
Serous fluids, . . . . .	959	41
Gastric juice, . . . . .	973	27
Intestinal juice, . . . . .	975	25
Tears, . . . . .	982	18
Aqueous humor, . . . . .	986	14
Cerebro-spinal fluid, . . . . .	988	12
Saliva, . . . . .	995	5
Sweat, . . . . .	995	5

The condition of semi-solidity of organic tissues, which we found to be so essential to the carrying out of the physical processes in cell life, is rendered possible by the amount of water and the condition in which it is held by the different cells. A remarkable fact in connection with the manner in which water is held by the animal organism is that there are certain tissues and organs in which the percentage of water found is in excess of the percentage of solids, without the organs assuming the fluid form; indeed, again, there are certain semi-solid organs whose percentage of water is even greater than that of the animal fluids; thus, the kidneys contain a larger percentage of water even than the blood. This shows therefore that the manner in which the water is held by such tissues must be different from that in which it exists in the animal fluids, where it occupies more or less the rôle of a medium of solution. The consistence of many fluids in the animal body is not dependent so much on the amount of water present as on the nature of the substances which are in solution; thus, mucus has a considerably larger percentage of water than blood, and yet is apparently a denser fluid. As already described in the section on Physical Processes in Cells, the water of the semi-solid organic bodies enters their elementary intermolecular spaces, and it is a peculiarity of organized bodies that they may absorb a quantity of water greatly in excess of their own weight without losing their semi-solid condition. In such cases it is not water alone that is absorbed, but water always containing different inorganic salts in solution.

A certain part of the water found in animal tissues is held in combination, as in water of crystallization, both in organic and inorganic molecules. This amount is, however, inconsiderable as contrasted with that held in other manners. Water is also found as a vapor in the air contained in the respiratory organs of animals.

By far the greater part of the water found in the animal and vegetable body has entered from without; in the former case through the food and drink, and in the latter from rain or from the absorption of moisture from the soil. In the case of the animal body a certain amount of water is apparently formed within the animal economy, since it has been found that under certain circumstances the amount of watery vapor exhaled through the lungs and skin, and that passing through the kidneys and intestines, is in excess of the amount of water taken internally, the body still preserving its uniform weight. Again, as we shall find in considering the subject of respiration, the volume of carbon dioxide eliminated through the lungs is smaller than the amount of oxygen taken into the blood in inspiration. Ten to twenty-five per cent. of oxygen disappears in this manner, and must, therefore, have formed other combinations in the body than those whose end product is  $\text{CO}_2$ . Since it is readily conceivable that the hydrogen of hydrogen compounds is set free quite as readily as the carbon of carbon compounds, a certain amount of this hydrogen may evidently unite with oxygen to form water, not by a direct oxidation of the hydrogen, but through the gradual union of the oxygen with a long series of oxidation products whose terminal is  $\text{H}_2\text{O}$ , just as  $\text{CO}_2$  results from the final union of oxygen and carbon, and not by a direct oxidation of carbon in the animal body. Such an origin of water in the economy is further supported by the fact that the amount of hydrogen contained in organic compounds in the excretions is less than that which is contained in similar combinations in the food. Thus, it has been estimated that a man receives daily forty grammes of hydrogen in organic combinations with the food, while only six grammes are discharged in such combinations in the excretions; hence, thirty-four grammes, or about 85 per cent. of the hydrogen so introduced, remains unaccounted for. Since hydrogen does not leave the body as a vapor, nor in any notable amount in any other inorganic compound but water, the surplus must be converted into water. The estimates are that in man about three hundred grammes of water are formed daily in this way,—probably from the decomposition of carbo-hydrates where hydrogen and oxygen are present in the proportion to form water.

Organisms not only live in water, but they may be said to live in running water (Hoppe-Seyler); for they are continually taking in water, which may contain other food-stuffs in solutions, and are continually eliminating water which contains the products of their tissue-waste.

Plants get rid of water through evaporation from their entire external surface, while water is absorbed by their roots.

Water leaves the animal body through the kidneys, skin, lungs, and intestines, that passing daily through the kidneys being about half of the total amount of water eliminated. The relative proportion between the amounts eliminated by these organs is subject to very great variation, and depends upon numerous external and internal conditions, which will subsequently be alluded to. It may, however, be here mentioned that of the water taken as food but a small amount leaves the body in the feces; in man the amount so eliminated is only 4 per cent., while the remaining 96 per cent. leaves the body through the kidneys, lungs, and skin. Water, therefore, does not simply pass through the alimentary canal, but is absorbed by its mucous membranes, enters the blood, and thence becomes a constituent of the different tissues.

Water is a necessary solvent for various organic and inorganic constituents of the body, and it alone, by entering into the condition of imbibition in the tissues, enables the various physical and chemical processes which constantly occur in cells to take place, and occasions their semi-solid state, their elasticity, flexibility, and transparency. Through its evaporation from the external surface and through the lungs it serves to abstract heat, and therefore is, to a certain extent, a temperature regulator. As water is an essential constituent of organic bodies, its loss, which is constantly taking place, must be continually replaced; in the higher animals a demand for an increased supply of water is indicated by what is known as thirst. This will subsequently demand consideration.

The removal of water from lower forms of cell life entirely suspends all evidences of vitality; through desiccation life in such forms is said to be rendered latent. A renewed supply of water will again restore all the phenomena of cell life. None of the higher plants or animals can support loss of water beyond a very moderate amount without causing permanent loss of vitality; seeds and infusoria may be completely dried and recover their vital properties when supplied with heat and moisture. Although water is an essential constituent of all cells, it may, nevertheless, act as a poison if absorbed in too great amount.

Protoplasm of all kinds is killed by immersion in distilled water; this fact may be partly due to the diffusion currents which are thus inaugurated, the essential salts being removed from the protoplasm, and their place being taken by water.

Freezing of various parts of plants and then subjecting them to rapid thawing by exposure to the rays of the sun causes their death by first abstracting water from the solids and causing its aggregation in a crystalline form, and then by sudden melting causes drowning out of neighboring parts while more remote portions still suffer from want of

water. If the thawing is slowly accomplished the water has time to diffuse and restore the normal condition of imbibition. In this way it is to be explained the fact, which may be frequently observed in cold spring and autumn mornings, that of the parts of plants which are frozen those which are exposed to the direct rays of the sun are killed, while those which are protected from the sun's heat thaw out gradually and regain their vitality. So, also, red blood-corpuscles may be frozen and gradually thawed without being destroyed, but if rapidly thawed are dissolved. On this fact, undoubtedly, rests the practical point that frozen animal parts must not be rapidly warmed, but have their circulation only gradually restored; hence, the common practice of rubbing with snow.

2. SODIUM CHLORIDE (NaCl).—Of the saline constituents of cells sodium chloride is the most widely distributed, and is present in larger amount than any other salt in all the tissues of the animal body, with the exception of the bones, teeth, red blood-corpuscles and striated muscle-cell. It is especially worthy of notice that the amount of sodium chloride in most organs, especially in the blood, is almost constant and is independent of the amount of this salt contained in the food. Its distribution in the body is also remarkable. In the blood-plasma it is abundant, while it is almost absent from the blood-corpuscles which are suspended in the plasma. It is abundant in chyle, lymph, saliva, gastric juice, mucus, and pus, and is present in only small quantity in muscle-juice and many glands. Sodium chloride is present in the form of a solution in water, and in the removal of the fluids from the semi-solid tissues by pressure the greater part of the salt is taken away with the water. The relative proportion of sodium and potassium chlorides in different parts of the animal body is about as follows:—

QUANTITY OF SODIUM AND POTASSIUM CHLORIDES IN 1000 PARTS IN THE

	NaCl.	KCl.
Bones,	7.02	
Blood,	2.70	2.05
Bile,	5.53	0.28
Gastric juice, .	1.45	0.55
Sweat,	2.23	
Saliva,	1.53	
Milk,	0.87	2.13
Lymph, . . .	5.67	
Sebaceous matter,	5.00	
Urine, . . .	11.00	4.50
Pancreatic juice, .	7.35	0.02

All the sodium chloride found in the animal body has entered it from without. It leaves the body in the urine and excrement, perspiration, nasal and buccal mucus. By far the greater part is eliminated through the urine, though the total amount eliminated falls short of that taken in the food. A certain amount of the sodium chloride taken in as

food undergoes chemical decomposition in the body, as will be alluded to in the subject of Nutrition. Thus, the potassium chloride of muscles and red blood-corpuscles apparently originates in a double decomposition of sodium chloride and potassium phosphate into sodium phosphate and potassium chloride. Possibly the hydrochloric acid of the gastric juice and the sodium salts of the bile have similar origins.

Sodium chloride is absolutely essential to the manifestation of life; in a physical sense, it is of great importance, from the influence which it exerts over diffusion, particularly in the degree of absorption from the alimentary canal. The conditions which follow the deprivation of sodium chloride, and a more detailed account of its relations to the nutritive processes and body will again be referred to more at length under the subject of Nutrition.

3. POTASSIUM CHLORIDE (KCl).—Potassium chloride is usually a companion of sodium chloride, although in certain tissues, such as the red blood-corpuscles, and in muscles, it occurs in greater amount than the sodium salt, while it is almost absent from the blood-plasma, where a slight excess of potassium salts appears to act as a poison to the heart. A similar toxic effect is also exerted by potassium chloride on muscles and nerves.

In the herbivora potassium chloride is, as a rule, in excess over sodium chloride. The salivary glands and kidneys appear to be the special organs for its elimination.

4. SODIUM AND POTASSIUM CARBONATES ( $\text{CO}_3\text{Na}_2$ ,  $\text{CO}_3\text{NaH}$ ,  $3(\text{CO}_3)\text{-Na}_4\text{H}_2$ ,  $\text{CO}_3\text{K}_2$ ,  $\text{CO}_3\text{KH}$ ).—These salts are found in the ash of various organic substances, where they have probably originated from the decomposition of various organic acid compounds of sodium and potassium. In various animal juices, however, and especially in the blood and urine of herbivorous animals, and in the blood of the omnivora, sodium and potassium carbonates exist already formed. When carnivorous animals are fed on a vegetable diet their urine contains considerable quantities of carbonates of the alkalis, resembling thus the urine of herbivorous animals in reaction and constitution; it will be alkaline in reaction, turbid, and deposit a calcareous sediment, instead of being acid and clear, as is normally the case in the urine of carnivora. It is also interesting, in this connection, to notice that the urine of the suckling calf before being weaned is clear and acid, as among carnivora; when the calf is placed on a vegetable diet the urine becomes turbid and alkaline. Further, if herbivorous animals are allowed to fast, their urine becomes acid and clear, for they are then living at the expense of their own tissues, and are practically carnivorous. Sodium carbonate is also found in the lymph and the parotid saliva of the horse.

These salts, when found as constituents of animal cells and fluids,

come in part from without, and are in part formed within the organism through oxidation processes occurring within the body. Thus, after the ingestion of various vegetable matters containing vegetable acids the urine of omnivorous animals becomes alkaline through the elimination of carbonates of the alkalies, thus explaining the alkaline reaction of the urine of these animals. Carbonates of the alkalies so formed in the animal body, or when taken in foods, may be eliminated in this manner through the urine, or they may themselves undergo decomposition, and their carbon dioxide be eliminated through the lungs. When present in solution they seem to assist in the various processes of oxidation occurring in the body; they appear to assist in the emulsification of fats, and in the blood the neutral carbonates of the alkalies appear to serve in part as carriers of the carbon dioxide of the blood. They further may modify the physical processes of diffusion occurring within the organism.

5. CALCIUM CARBONATE ( $\text{CO}_3\text{Ca}$ ).—Calcium carbonate is a normal constituent of the shell of birds' eggs, of the bones and teeth, the urine of herbivorous animals, the parotid saliva of the horse, and is the principal constituent of the so-called otoliths, or the small, inorganic masses found in the internal auditory organs of man and different animals. In the animal body it is partly in a state of solution and partly deposited in the solid form. In the former condition it is found in the urine and saliva of the herbivora, where its solution is rendered possible by carbon dioxide. In the solid form it is deposited either in amorphous or crystalline form, as in deposits of sediment in the parotid saliva of the dog and in the urine of herbivora. It originates from without, either in the water taken internally or as a carbonate in vegetable food. The latter explains its abundance in the urine of the herbivora, where the calcium salts of organic acids are decomposed into carbonates. Only a part of the calcium carbonate which enters the organism from without leaves it as such. In many cases, as in man, it undergoes decomposition into calcium phosphate. Its importance for the animal economy is not thoroughly understood.

6. MAGNESIUM CARBONATE ( $\text{CO}_3\text{Mg}$ ).—This salt is frequently a companion of calcium carbonate, particularly in the urine of herbivora. Its presence in bony tissue is apparently doubtful. It has been found in human urinary calculi, but only in small amounts. The herbivorous animals in their food nearly always absorb considerable amounts of magnesium phosphate, and since this salt is absent from their urine it would appear that the magnesium carbonate is formed in the animal body from the magnesium phosphate of vegetable food.

7. ALKALINE PHOSPHATES ( $\text{PO}_4\text{Na}_3$ ,  $\text{PO}_4\text{Na}_2\text{H}$ ,  $\text{PO}_4\text{NaH}_2$ ,  $\text{PO}_4\text{K}_3$ ,  $\text{PO}_4\text{K}_2\text{H}$ ,  $\text{PO}_4\text{KH}_2$ ).—Phosphates of sodium and potassium are constant

constituents of all animal fluids and tissues. In the ash of the blood of the herbivorous animals a smaller amount of the alkaline phosphates is found than in the carnivora. Grain-eating animals show a larger amount of phosphatic salts in the ash of their blood. Omnivora occupy a mean between the two. On account of their great solubility in the organism the phosphates must nearly always exist in the form of a solution, especially in the acid fluids, as in urine, muscle-juice, and the parenchymatous fluids of certain glands. In muscles, together with lactic acid, they occasion the acid reaction of the muscle-juice.

Phosphates are taken into the animal body with food, though they may also doubtless originate in the blood through a double decomposition of potassium phosphate and sodium chloride into sodium phosphate and potassium chloride. The alkaline phosphates leave the body through the kidneys and intestines. The former is the case especially in the urine of the carnivora, where it forms twelve-thirtieths of the total amount of these substances eliminated. In the urine of the herbivora but small amounts of phosphates are found, in spite of the fact that in their food phosphates of the alkalies and earthy phosphates are invariably present. This is to be explained by the supposition that the salts of the organic acids, with the alkaline earths, undergo decomposition into earthy phosphates and carbonates of the alkalies, the latter being eliminated through the urine. From their great abundance and wide distribution in the animal economy, it follows that they must be of great importance.

The phosphate of potassium is especially abundant in the blood-cells, ovum, and in muscular tissue. In the latter case, combined with lactic acid, it is the main cause of their acid reaction, while phosphate of sodium is found in blood-plasma. These salts enter the organism as constituents of food, either in the form in which they are found or as the result of decomposition of the earthy phosphates and other alkaline salts. This is especially probable on account of the great abundance of potassium phosphates and potassium chloride in the fluids of muscle and other tissues, while sodium chloride and sodium phosphate, being found in abundance in the blood, it is evident, from the proportion in which these different substances are found in the different tissues, that they have not been derived directly from the blood. Again, it is to be remembered that the herbivorous animals in their food receive almost solely potassium salts, and, since sodium phosphate is necessary for the integrity of their blood, it is clear that this must be formed in the body through the decomposition of potassium phosphate and sodium chloride. In the blood the alkaline phosphates give to the plasma its alkaline reaction, to which its great capacity for dissolving carbon dioxide is apparently due, since it has been found that water, which holds only

one per cent. of sodium phosphate in solution, is able to retain twice the usual amount of carbon dioxide in solution.

The phosphates of the alkalies are eliminated from the animal body through the kidneys, intestines, and skin. In carnivorous animals, whose blood is rich in phosphates of the alkalies, the urine is the main path of elimination. Through the production of acids, such as uric, hippuric, and sulphuric, the latter originating from the sulphur of albuminoids and their derivatives, a part of the base is withdrawn from the alkaline phosphate, and, as a consequence, the alkaline phosphate now becomes neutral or even acid, thus explaining the production of an acid reaction in urine from the presence of dihydrate sodium phosphate ( $\text{PO}_4\text{NaH}_2$ ). Since phosphoric acid, or acid phosphates, in solution give to fluids their power of dissolving calcium and magnesium phosphates, the urine of the carnivora and omnivora is therefore able to hold in solution the earthy phosphates so eliminated. In the case of the herbivora the state of affairs is somewhat different. Here but small amounts of phosphoric salts are found in the urine, although alkaline and earthy phosphates are found in large amount in their food. In this case the phosphates of the food undergo decomposition, and a great part of the base is united with carbonic acid, and so eliminated as alkaline carbonates in the urine, forming thus the characteristic of the urine of herbivorous animals, the earthy carbonates being held in solution by the free carbon dioxide. The phosphoric acid of the phosphates taken in the food of herbivorous animals in greater part unites with calcium and magnesium, and is eliminated through the intestine. Wherever free acid is developed in the tissues of the body acid phosphates are nearly always present and in part contribute to the formation of this acid reaction. This is the more remarkable when it is remembered that these phosphates have originated from the blood, where they always exist in the form of basic or neutral salts. The explanation of the mode in which this alkaline phosphate is in the different tissues converted into an acid salt is to be explained through the development in the tissues of organic acids, which, as already alluded to in the explanation of elimination of the phosphates, takes a portion of the base from the alkaline phosphate, so developing an acid salt.

Phosphates appear to be absolutely essential to the development of tissue. This is indicated in the first place by their great abundance in all forming tissues, and even in organizable fluids, and in the fact that the tissues of herbivorous mammals are quite as rich in the phosphates as that of the carnivora, although in the former case they are nearly absent from the blood, and in the latter case are very abundant. In special tissues, such as the muscles, nerves, blood-corpuscles, and ovum, they appear, from their exceptional abundance, to have some special functions



to fulfill. This seems indicated by the fact that the nervous tissue in solutions of alkaline phosphates may preserve its irritability much longer than when in contact with any other fluid. In the tissues the phosphates of the alkalis occur as acid salts; it therefore would seem that tissues in their growth require the presence of free phosphoric acid. In the case of the blood, on the other hand, an alkaline reaction is essential for its vital phenomena, and it appears that, provided the alkaline reaction is preserved, the salt to which this alkalinity is due is of minor importance. Thus, in the carnivorous animals the reaction is attributable to the excess of alkaline phosphate, in the herbivorous animals to the carbonates. In omnivorous animals the preponderance of these different salts varies according to the character of their diet.

8. CALCIUM PHOSPHATE ( $2(\text{PO}_4)\text{Ca}_3$ ,  $2(\text{PO}_4)\text{CaH}_4$ ).—This salt is present, without exception, in all tissues and fluids of the animal body; in bones and teeth nearly two thirds of their weight is due to the calcium phosphate present. Of all the inorganic constituents of the body, with the exception of water, it is the most abundant. In most of the pathological ossifications and concretions calcium phosphate constitutes the major portion. Thus, nearly all the urinary calculi in the ox are formed by calcium phosphate, and it is also a constituent of the mulberry calculus of man. So, also, calculi which develop around some foreign nucleus are largely calcium phosphate. Calcium phosphate also forms the greater part of the ash of albuminous bodies, with, as far as is yet known, the single exception of elastin. It is present in the tissues of the human body in the following proportions:—

QUANTITY OF CALCIUM PHOSPHATE IN 1000 PARTS IN THE	
Enamel of teeth,	885.
Dentine,	643.
Bones, . . . . .	576.
Cartilage, . . . . .	40.
Milk, . . . . .	2.72
Blood, . . . . .	0.30
Bile, . . . . .	0.92
Urine, . . . . .	0.75

The greater part of calcium phosphate in the organism is deposited in the form of a solid salt in the bones and teeth, in the form of the tricalcium orthophosphate ( $2(\text{PO}_4)\text{Ca}_3$ ). It is also in the same form present in nails, hair, and hoofs. When it is found in solution, as is the case with all of the animal fluids, it being by itself perfectly insoluble in water, its presence is only to be explained as chemically united with albuminoids, although possibly it may be in minute amount in solution in fluids which contain sodium chloride or free carbon dioxide. In the urine of carnivora and omnivora calcium phosphate is present as an acid salt ( $2(\text{PO}_4)\text{Ca}''\text{H}_4$ ), which is in itself soluble in water. In the alkaline

urine of the herbivora but little calcium phosphate is present, and this is not dissolved, but merely suspended, and readily deposits as a sediment. In the solid tissues the lime phosphate appears to be simply deposited in the interstices of the organic bases, and it may be removed—as, for example, from bone—by prolonged maceration in dilute hydrochloric acid, without altering the form of the bone. As Dalton says: “In the bones, teeth, and cartilage the lime phosphate exists in a solid form; not, however; deposited mechanically in the osseous or cartilaginous substance as a granular powder, but intimately united with the animal matter of the tissues, like coloring matter in colored glass, the union of the two forming a homogeneous material. It is not, on the other hand, so combined with the animal matter as to lose its identity and constitute a new chemical substance, as where hydrogen combines with oxygen to form water, but rather as salt unites with water in a saline solution, both substances retaining their original character and composition, though so intimately associated that they cannot be separated by mechanical means. The lime phosphate, therefore, may be extracted from a bone by maceration in dilute muriatic acid, leaving behind the animal substance, which still retains the original form of the bone or cartilage.” The bone so treated preserves its outline perfectly, but has entirely lost all rigidity, and may be twisted up, and the long bones may often be tied into a knot. Calcium phosphate, therefore, gives to bone-tissue its rigidity. Consequently when, either through some faulty process in the organism or through the deprivation of calcium salts from the food, this substance is not deposited in normal amounts in the bones, the latter become soft, flexible, and deformed, forming the affection known as rachitis; or, in adult life, a similar morbid softening of bones may take place from a defective deposit of calcareous matter, and a progressive yielding of the bony skeleton takes place, constituting the disease known as osteomalacia.

The greater part of the calcium phosphate enters the body in the food, being contained in both animal and vegetable articles of diet. In suckling animals the milk contains, in its normal condition, a sufficient amount of calcium phosphate to supply the growing organism with its requisite quantity. When taken in vegetable food, where, of course, it is ordinarily present as a union of calcium with one or more of the organic acids, in the animal body, as already referred to, it undergoes decomposition into calcium phosphate and carbonates of the alkalies.

9. MAGNESIUM PHOSPHATE ( $2(\text{PO}_4)\text{Mg}_3$ ,  $2(\text{PO}_4)\text{MgH}_4$ ).—Like calcium phosphate, magnesium phosphate is found in all the tissues and fluids of the animal body, though in far smaller amount, with the exception of muscle and the thymus gland, where the magnesium phosphate is in excess. The bones of the herbivora contain more magnesium phos-

phate than those of the carnivora. The combination  $2(\text{PO}_4)\text{Mg}''\text{H}_4$  is often found in the urine of the herbivora when fed on grain, and is occasionally met with in intestinal concretions under the same conditions. Its origin, physiological importance, and mode of disposition in the body is apparently identical with that of the alkaline phosphates. Occasionally magnesium phosphate undergoes crystallization, as in the urine of the rabbit and in suckling calves.

10. SODIUM AND POTASSIUM SULPHATES ( $\text{SO}_4\text{K}_2$ ,  $\text{SO}_4\text{Na}_2$ ).—These salts are to be regarded as normal constituents in small amount of most of the animal fluids and tissues. They are not, however, found in the milk, bile, or gastric juice, their presence in the ash being without importance, since in incineration of sulphurous organic compounds the sulphuric acid, liberated in this process, unites with the carbonates and alkaline bases. A certain amount of these salts is held in solution in the blood and in the urine, though they are less abundant than either the chlorides, phosphates, or carbonates. When present in the animal body they are in the form of solution. Only part of the sulphates found in the animal body is derived from without, since it is possible that through the oxidation of sulphur of organic compounds sulphuric acid is formed, which leaves the body united with alkaline bases. These salts are excreted from the body through the urine, where a greater part of the sulphuric acid is not derived from the sulphates contained in the food, but through the internal oxidation of sulphur-holding compounds. This is especially shown by the fact that an abundant animal diet increases the amount of sulphates in the urine hand in hand with the increase of urea, while a vegetable diet decreases it. The sulphates partly contribute to the acid reaction of the urine of carnivora.

The entire quantity of sulphur in the body of an adult man has been estimated at about one hundred and ten grammes, and to keep this amount constant at least one gramme must be taken daily in the food, where it is combined with albuminoids. A part of this sulphur passes into the hair and nails, part is consumed in the manufacture of various complex, sulphur-holding compounds, such as taurin, taurocholic acid, gelatin, chondrin, mucin, etc., while part is eliminated in the form of sulphates.

11. HYDROCHLORIC ACID ( $\text{HCl}$ ).—The presence of free hydrochloric acid has as yet only been shown to exist in the case of gastric juice of mammals. Its origin and importance will be considered under the subject of Gastric Juice.

Oxygen, nitrogen, and carbon dioxide are also constant constituents of animal fluids and tissues, and their importance will be discussed under the subject of Respiration.

A few other inorganic substances have been found as more or less

constant ingredients of animal substances, but they are present in such small amounts, or in such variable quantities, that their importance has not been clearly established. These are magnesium chloride, calcium fluoride, ammonium carbonate, magnesium-ammonium phosphate, calcium sulphate, silicic acid, iron, manganese, and copper.

In vegetable tissues nearly all the constituents of the animal cell are found deposited or in solution. They serve to give greater solidity to the so-called skeleton of plants, and are also without doubt of importance in the vital processes of vegetable protoplasm. Thus, it has been found that the amount of albumen in germinating seeds stands in direct proportion to the amount of phosphate which the plant receives as food; also, that without potassium salts plants cannot grow. Their interest to us as constituents of vegetable organisms is simply dependent upon their rendering such substances suitable for animal foods. They will therefore receive the necessary consideration under the subject of Foods.

## II. THE CHEMICAL PROCESSES IN CELLS.\*

The great mass of organized bodies, both animal and vegetable, are what might be described as carbonic acid compounds, associated in variable amounts with hydrogen, oxygen, and nitrogen. Plants are able, from inorganic substances, such as  $\text{CO}_2$ ,  $\text{H}_2\text{O}$ ,  $\text{NO}_3\text{H}$ ,  $\text{NH}_3$ ,  $\text{H}_2\text{SO}_4$ ,  $\text{P}_2\text{O}_5$ , to develop organic compounds, the difference between such bodies as entering into and as leaving plants depending merely upon the difference in their proportion of oxygen. The inorganic bodies, which serve as food for plants, are what are known as combustion products; that is, they already contain the maximum quantity of oxygen which is able to enter into their composition. Organic bodies, on the other hand, contain in all cases less oxygen than will satisfy the affinities of their constituent elements. They therefore are capable of undergoing further oxidation, or, in other words, may be said to be combustible. The plant-cell, therefore, must be able to deoxidize the inorganic compounds of its food and set free oxygen; and this deoxidizing force must evidently be greater than the affinity exerted by the oxygen for the elements with which it was in composition. This deoxidizing power possessed by plants is only capable of manifestation in the sunlight, and is a function of the green coloring matter, the chlorophyll of plants. The animal cell, on the other hand, in its nutritive operations exhibits the reverse process of oxidation. The inorganic compounds which in the vegetable cell become organic, that is, deoxidized, in the animal cell become again oxidized and

\* For the preparation of this section special acknowledgment is due to Wurtz; "Chimie Biologique;" Wundt, "Lehrbuch der Physiologie;" Gorup-Besanez, "Physiologische Chemie;" Ranke, "Grundzüge der Physiologie;" Hoppe-Seyler, "Physiologische Chemie;" Schützenberger, "Fermentation;" Nägeli, "Theorie der Gärung."

again rendered inorganic, or become combustion products. They are, therefore, restored to the mineral world by the animal in the same form in which they were originally absorbed by the vegetable.

Vegetables and animals are the depositories and agents of life on the surface of the earth. The essential characteristic of the vital operations of the former is their power of elaborating organic from inorganic material. Animals are charged to destroy, after assimilation, the results of the vital operations of the vegetable. The animal kingdom is thus subordinate to the vegetable, and organic life represents a closed circle of metamorphosis of matter. Plants appropriate inorganic matter out of the surrounding inorganic nature, out of the ground and air, and convert it into the constituents of their own tissues. They then become food for animals, are converted into animal tissues, and are again returned to the ground and air as inorganic compounds. Thus, the carbon of the carbon dioxide of the air becomes the carbon of cellulose or starch, of sugar, of fat, of gum, and of albumen in the plant; as food of animals it then becomes the carbon of various animal tissues. In the vital processes of the animal the carbon of the tissues undergoes oxidation, and is returned to the atmosphere through the expelled air as carbon dioxide, or, in other words, in the form in which it originally left the atmosphere. An analogous circle might also be traced for the other constituents of the animal tissues.

We can thus understand how the constituents of animal and vegetable cells may in all essential points be analogous; but, while this is so, the chemical processes in each are very different. Green plants, in their capability of deoxidizing inorganic food elements, are dependent upon power from without—the heat and light from the sun. They therefore store up energy in their tissues. Animal cells, in oxidizing the materials derived from the vegetable world, liberate a force, as in all other forms of oxidation, which in this case represents an equivalent of mechanical energy precisely equal to the force rendered latent in the nutritive processes in the vegetable. In the animal cell this energy may take on the form of heat, electricity, or light, as in certain organisms, or mechanical movement.

1. *The Vegetable Cell.*—The assimilative processes in the vegetable cell are dependent upon the presence of protoplasm, which in its modified form as chlorophyll has the power of making use of the sunlight for purposes of organic deoxidation, and constitutes the most powerful reducing body known. The properties of chlorophyll are not exactly known, as it has probably never been prepared in a perfectly pure state. In the chlorophyll granules are often to be found, the results of its organic activity, such as starch-granules; but their precise mode of formation, or the precise share which chlorophyll has in producing their formation, is

not well known. The optical properties of chlorophyll are very remarkable. Fresh alcoholic solutions in ether, even when very dilute, give a broad band in the red line of the spectrum, and between the red and the orange. The most luminous portions of the spectrum are the red and green parts. When concentrated ethereal solutions of chlorophyll are examined in the spectroscope, only the red rays pass. Concentrated solutions of chlorophyll give a red fluorescence with reflected light. When subjected to the action of light solutions of chlorophyll change their color, probably in a manner similar to that which accompanies the vital processes of the vegetable protoplasm in which chlorophyll is contained.

In all its forms protoplasm, whether animal or vegetable, contains albuminous bodies in a state of solution in water, and associated with compounds of an inorganic nature. Carbo-hydrates, hydro-carbons, and ferments are also nearly invariably present. It may be assumed that the albumen is the highest and last product of the chemical activity of vegetable cells, while starch probably constitutes the first evidence of protoplasm activity, and is the mother-substance out of which other carbo-hydrates, such as cellulose and sugar, as well as fats, are manufactured.

Plants develop various modifications of albuminoids, which are apparently identical with the different forms of albuminous bodies found as constituents of animal cells. Thus, in growing and germinating plants a globulin-like body is found in large amount, as well as a substance similar to myosin and vitellin in combination with lecithin and certain inorganic substances. Albumen is found in especially large quantities, with large amounts of starch, in the seeds of plants; hence, the undeveloped plant finds in these two substances, albumen and starch, material ready prepared for building up its tissues until it reaches a grade of development in which it is able to manufacture these organic compounds from the elements. When the first leaves and roots are formed, then the plant commences its independent existence. The evidences of this, as we have already seen, consist in the appropriation of  $\text{CO}_2$ ,  $\text{H}_2\text{O}$  and  $\text{NH}_3$ , with a corresponding liberation of oxygen.

Since all vegetable matters contain carbon and water, their constituents may be regarded as more or less modified  $\text{CO}_2$  molecules. Thus, sugar may be regarded as  $\text{CO}_2$  in which one equivalent of oxygen is replaced by two equivalents of hydrogen (Liebig).

Carbonic Anhydride.



Grape-Sugar.

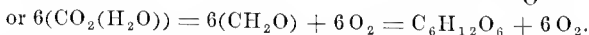

Carbon dioxide, therefore, in the formation of organic matter, may be regarded not as decomposed, but as changing the arrangements of its molecules. We have found that plants in their nutritive purposes assimilate

late carbon, hydrogen, nitrogen, and various inorganic substances. We will attempt to give a general idea as to the processes by which these substances are absorbed by plants, and the way in which in their tissues they are combined to form organic compounds.

First, as regards *carbon*. The carbon of plants is without doubt derived from the  $\text{CO}_2$  of the atmosphere, or in solution in rain-water which is absorbed by the leaves and roots, which under the influence of the sun is broken up in the body, and whose oxygen is liberated. The oxygen given off in the day-time by plants has been found to be somewhat less than that which is contained in the  $\text{CO}_2$  which has been absorbed. This would seem to indicate that  $\text{CO}_2$  is only reduced to  $\text{CO}$ , since it is known that part of the oxygen comes from the decomposition of water. This hypothesis is further rendered more probable by the readiness with which  $\text{CO}$  combines with other bodies. Thus, it unites with  $\text{Cl}$  at the ordinary temperature, and combines directly with hydrogen to form formic acid. Doubled,—that is, united with itself,—the radical oxide of carbon, or carbonyl  $\text{CO}$ , constitutes the oxalic radical  $\text{C}_2\text{O}_2$ , or oxalyl. The acid which contains this radical,—that is, oxalic acid,—can be formed by an incomplete reduction of  $\text{CO}_2$  and  $\text{H}_2\text{O}$  in the presence of mineral bases; various organic acids may thus originate in vegetable cells. Taking the simplest cases, the important acids, formic and oxalic, may be formed in this way, the one with one atom of carbon, the other with two. Thus, with one molecule of water

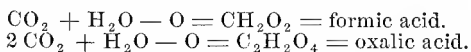

Developing this idea, Liebig has shown that the organic acids once formed may give rise to aldehydes by a subsequent reduction. Formic aldehyde represents formic acid less one atom of oxygen; oxalic aldehyde, or glyonal, oxalic acid less two atoms of oxygen, thus:—

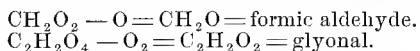

The formation, therefore, of aldehydes in vegetables represents a certain stage of reduction of  $\text{CO}_2$  and  $\text{H}_2\text{O}$ . Even more complex substances, but less rich in oxygen, will result from further decomposition.

The examples above given, especially in the case of formic aldehyde, are particularly important, as there is scarcely any doubt that formic aldehyde plays an important rôle in vegetable synthesis. Thus, six molecules of formic aldehyde will form one molecule of glucose:—

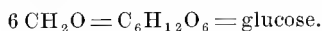

Again, on the other hand, by the dehydration of aldehydes resins may be formed, as it is well known how readily ordinary aldehydes become

converted into resinous bodies by losing water; while, again, ammonia through its combination with aldehydes may give rise to nitrogenous bodies, such as alkaloids. We therefore see that in the appropriation of the carbon and the carbon dioxide of the atmosphere the carbon becomes fixed to form these various bodies synthetically in vegetable protoplasm, while the oxygen is liberated.

As regards the assimilation of *hydrogen* in the synthetical processes occurring in vegetable cells, this evidently occurs from the decomposition of water, as is proved by the circumstance that the oxygen liberated, while sometimes less, is often in excess of that which is contained in the  $\text{CO}_2$  absorbed. Thus, in the vegetable cell the carbo-hydrates, such as cellulose, starch, gum, and sugar, are made by the simultaneous reduction of carbon dioxide and water under the influence of solar radiation.

For *nitrogen*, the atmosphere is the sole source, though it may possibly to a certain extent be derived from the nitrates in the soil. When obtained from the atmosphere it is held in solution in the form of salts, possibly in rain-water. All decomposing organic matters set free ammonia, and therefore nitrates, particularly of potassium, are powerful fertilizers, and increase vegetation by supplying the nitrogen which is essential in the development of albuminous bodies and crystallized nitrogenous vegetable constituents.

Of the minerals which are essential to vegetable life, such as phosphates, silica, salts of lime and magnesium, and alkaline salts, they are obtained partly from the atmosphere and partly from the soil. They are contained in large amounts in all parts of vegetable matter, and will deserve special consideration under the subject of the vegetable diet of the herbivora. The mineral constituents of the soil and atmosphere therefore play an important part in the phenomena of the development of vegetable life. This we have seen to be essentially one of reduction. In separating the oxygen from carbon and hydrogen a portion of their affinity for oxygen is restored to these latter elements. For in  $\text{CO}_2$  and  $\text{H}_2\text{O}$  this affinity is completely satisfied; that is, the energy which resides in the atoms of carbon and hydrogen has not been destroyed by combination and transformation, and when these atoms unite with oxygen this energy is dissipated as heat. To reduce these combinations, therefore, the energy thus latent in the form of heat must be restored to the atoms of carbon and hydrogen. Thus vegetables, in decomposing water and carbon dioxide, making use of the heat of the sun, not only convert atoms of carbon, hydrogen, and nitrogen into organic substances, but have at the same time accumulated chemical energy. For all organic compounds are capable of uniting with oxygen; in other words, are combustible. The energy restored under the name of affinity to the atoms is hence derived from a portion of the solar radiation which is absorbed by plants



and is converted into affinity. This is the indispensable condition of the reduction\* of  $\text{CO}_2$  and  $\text{H}_2\text{O}$  and the elaboration of organic compounds; or, in other words, "there can be no vegetation without the sun."

The process which we have found to take place in vegetable cells only holds good in the case of green plants under the influence of the sunlight, for there is in all cases a double chemical process going on in plant-cells. The assimilation through deoxidation of organic compounds under the influence of sunlight has already been described. This process is, however, limited to the chlorophyll plants, and in them to the time when they are exposed to the sun's light and heat. Another process, however, is continually going on in all forms of vegetable cells. The products of assimilation undergo within the vegetable cells various chemical changes which are not accompanied by a liberation of oxygen, but by a change of molecular arrangement, associated with the absorption of a small amount of oxygen and the setting free of carbon dioxide. These changes are independent of the sunlight, and result in a diminution of the mass of assimilated materials. That a plant may increase in size it is necessary that the deoxidizing activity and assimilation produced in the sunlight should overbalance the loss through oxidation which is continually going on, whether in darkness or light. This latter process in plants, by which they absorb oxygen and set free carbon dioxide, is clearly analogous to the processes of respiration in animals. This respiration in plants is, however, very feeble, and is far overbalanced by the processes of assimilation; therefore, as a rule, although the elaboration of vegetable products is accompanied by accumulation of force, the vital processes in plants which are not connected with assimilation are, as in animals, dependent upon oxidation processes, and may be accompanied by the liberation of heat and electrical movement of protoplasm, and the formation and growth of cells. In the case of the non-chlorophyll-bearing plants, such organisms absorb organic matter already elaborated; the parasitic plants may, therefore, be regarded as a connecting-link between the animal and vegetable kingdoms, especially as some of the lower forms of the former are also possessed of chlorophyll, by which they are enabled to decompose  $\text{CO}_2$  under the influence of the sun. A curious exception to the characteristics of the vegetable chemism is the power which certain plants possess of attracting, seizing, and digesting insects. The so-called insectivorous plants of Darwin and Hooker, such as the *Drosera rotundifolia*, *Darlingtonia*, *Nepenthes*, etc., are supplied with special urn-like vessels, in which the animals are trapped and digested. They are lined with glands that secrete both the sugary fluid to attract the insects and a true digestive juice, containing pepsin and acid, which is poured out when the plants are stimulated by contact with digestible substances. This secretion will turn fibrin into peptone, but

is without action on starches. It therefore closely resembles animal gastric juice.

Still another analogy may be traced between the animal and vegetable kingdoms. Under certain circumstances plants develop heat, as in germinating seeds, or in flowers during fecundation. Sugar is the substance in such cases whose combustion sets free heat. It exists in germinating seeds, and disappears during germination, from the action of a diastatic ferment analogous to the glycogen ferment in animals. The analogy is, however, not perfectly complete, as the plants manufacture their starchy material from inorganic materials; animals must obtain it ready-made.

In the dark the processes of assimilation of plants are entirely suspended. Then carbon dioxide is given off, and oxygen is absorbed, for the processes of respiration or oxidation still continue. During the day the carbon dioxide, which is constantly absorbed by the roots and leaves, is in the leaves broken up into oxygen, which is set free, while the carbon remains fixed. At night  $\text{CO}_2$  is also absorbed by the roots, but is exhaled from the leaves without undergoing change: for, as we have found, for its deoxidizing purposes chlorophyll requires the assistance of sunlight and heat. It is also possible that a part of the  $\text{CO}_2$  which is set free during the night is not only derived from  $\text{CO}_2$  absorbed from the leaves and roots, but also is the result of oxidation by a part of the oxygen which is absorbed.

2. *The Animal Cell.*—The relationship which we have traced between the chemical processes of plants and the atmosphere and soil around them is reversed in the case of animal cells; for, while green plants absorb the inorganic constituents of the earth and atmosphere, and from them build up complex, inorganic compounds, the oxygen of the atmosphere in the animal permits of the reduction of its complex tissues and constituents. For the green plants the atmosphere forms one of their chief foods; for animals it is the great agent which permits their tissue changes, on which all liberations of energy depend. In green plants the chief vital phenomenon is the liberation of oxygen; in animals it is the absorption of oxygen. In plants the liberation of oxygen is an index of increase in weight; in animals the absorption of oxygen leads to a loss of weight. That the animal cell may retain its composition unaltered it must be supplied with its tissue-constituents. Unlike vegetable cells, the animal cell is incapable of manufacturing these tissue-constituents from inorganic elements. The most that the animal cell may do is to transform a member of one class of its constituents into another member of the same group. Thus, the animal cell may transform the albuminoid matters contained in vegetable cells into albuminous bodies which are peculiar to animals. It may transform the

proteids of one class into those of another. It may transform casein of milk into the proteids of blood and other tissues. Animal cells are, however, the seat also of certain synthetical processes, such as the formation of hæmoglobin from albumen and iron, with other inorganic matters, the possible reformation of albumen from peptone, and the building of complex albuminoids, such as mucin. All animal foods, nevertheless, originate in the vegetable kingdom. Even carnivora are dependent on the vegetable kingdom for their sustenance; for the herbivora, feeding on vegetable diet, become the prey of carnivorous animals, which are therefore dependent on the vegetable matters which serve to nourish the tissues of the animals which serve as their food. In the vegetable cell albumen is the end product of its chemical processes; in the animal cell it is the starting point. Albuminoids represent the main or essential type of foods which must be supplied to the animal cell. When introduced into the interior of cells, albuminoids undergo a progressive oxidation and simplification, by which lower complex substances are formed. The mode of decomposition of albuminoids, as well as of all organic bodies in general, is different in different cells. This difference is seen in the very first modification of the albuminous matters of food, which may be converted into casein, myosin, etc., according as the resulting albuminous body is destined to be a constituent of milk, muscle-cell, etc. Then, again, after being deposited in cells the subsequent processes differ in different cases, according to the nature of the cell-membrane or intercellular substance, or the function of the special cells in the organism. Finally, the development of the end products of the oxidation of the albumen of cells differs in the cells of different tissues, though in all cases the chemical processes in cells result in the formation of carbon dioxide, water, and ammoniacal compounds.

The most striking example of the products resulting from the oxidation of proteids is the formation of fat from albumen. In adipose tissue and in fatty degeneration of various organs the protoplasmic contents of cells become replaced by oil, formed evidently at the expense of the albuminoid constituents of the protoplasm. So, also, carbo-hydrates, such as glycogen, may be produced from a splitting of the albuminoid foods. In addition to the carbo-hydrates and fats thus formed, a large number of nitrogenous bodies are liberated in the oxidation of the albuminous molecule, and might be termed ammonia compounds, such as kreatin, uric acid, urea, etc. Such bodies are, as a rule, richer in oxygen than albumen.

The carbo-hydrates and fats are also subjected to progressive oxidation in the animal body, and result, in the former case, in the production of organic acids, such as lactic, formic, and oxalic, and in the latter in the formation of fatty acids. As already several times mentioned, the

chemical processes in the animal cell result in the formation of  $\text{CO}_2$ ,  $\text{H}_2\text{O}$ , and  $\text{NH}_3$  compounds, and hence return to the earth and air the matters originally absorbed by the plant-cell, and in the same form. These end products are, however, only gradually formed as the result of a long series of intermediary oxidation products, which are formed partly through processes of *splitting*, by which complex molecules, usually through hydration, are decomposed into two or more simpler compounds through the action of certain *ferments*. Through these means the organic cell-constituents become progressively poorer in carbon and richer in oxygen and nitrogen, thus losing their organic characteristics and becoming gradually more nearly allied to inorganic bodies, until finally the inorganic end products are reached.

The following table, based on hypothetical formulæ, indicates the manner in which complex albuminous molecules may become gradually reduced to simpler forms (Gorup-Besanez):—

Hæmoglobin,	C <sub>600</sub>	H <sub>960</sub>	N <sub>154</sub>	FeS <sub>3</sub>	O <sub>179</sub>
Albumen,	C <sub>90</sub>	H <sub>139</sub>	N <sub>22</sub>	S	O <sub>30</sub>
Lecithin,	C <sub>42</sub>	H <sub>84</sub>	N	P	O <sub>9</sub>
Taurocholic Acid,	C <sub>26</sub>	H <sub>45</sub>	N	S	O <sub>7</sub>
Glycocholic Acid,	C <sub>26</sub>	H <sub>43</sub>	N		O <sub>6</sub>
Hippuric Acid,	C <sub>9</sub>	H <sub>9</sub>	N		O <sub>3</sub>
Tyrosin,	C <sub>9</sub>	H <sub>11</sub>	N		O <sub>3</sub>
Leucin,	C <sub>6</sub>	H <sub>13</sub>	N		O <sub>2</sub>
Asparagin,	C <sub>4</sub>	H <sub>3</sub>	N <sub>2</sub>		O <sub>3</sub>
Asparaginic Acid,	C <sub>4</sub>	H <sub>7</sub>	N		O <sub>4</sub>
Glutamic Acid,	C <sub>5</sub>	H <sub>9</sub>	N		O <sub>4</sub>
Guanin,	C <sub>5</sub>	H <sub>5</sub>	N <sub>5</sub>		O
Hypoxanthin,	C <sub>5</sub>	H <sub>4</sub>	N <sub>4</sub>		O
Xanthin,	C <sub>5</sub>	H <sub>4</sub>	N <sub>4</sub>		O <sub>2</sub>
Uric Acid,	C <sub>5</sub>	H <sub>4</sub>	N <sub>4</sub>		O <sub>3</sub>
Kreatin,	C <sub>4</sub>	H <sub>9</sub>	N <sub>3</sub>		O <sub>2</sub>
Allantoin,	C <sub>4</sub>	H <sub>6</sub>	N <sub>4</sub>		O <sub>3</sub>
Urea,	C <sub>4</sub>	H <sub>4</sub>	N <sub>2</sub>		O

Urea thus forms the termination of the decomposition series of the organic nitrogenous molecules.

A similar progressive simplification may also be seen in the non-nitrogenous organic constituents. Thus, according to Gorup-Besanez:—

Stearin,	C <sub>57</sub>	H <sub>110</sub>	O <sub>6</sub>
Palmitin,	C <sub>51</sub>	H <sub>98</sub>	O <sub>6</sub>
Olein,	C <sub>57</sub>	H <sub>104</sub>	O <sub>6</sub>
Stearic Acid,	C <sub>18</sub>	H <sub>36</sub>	O <sub>2</sub>
Oleic Acid,	C <sub>18</sub>	H <sub>33</sub>	O <sub>2</sub>
Palmitic Acid,	C <sub>16</sub>	H <sub>32</sub>	O <sub>2</sub>
Butyric Acid,	C <sub>4</sub>	H <sub>8</sub>	O <sub>2</sub>
Succinic Acid,	C <sub>4</sub>	H <sub>6</sub>	O <sub>4</sub>
Grape-sugar,	C <sub>6</sub>	H <sub>12</sub>	O <sub>6</sub>
Glycerin,	C <sub>3</sub>	H <sub>8</sub>	O <sub>3</sub>
Lactic Acid,	C <sub>3</sub>	H <sub>6</sub>	O <sub>3</sub>
Acetic Acid,	C <sub>2</sub>	H <sub>4</sub>	O <sub>2</sub>
Oxalic Acid,	C <sub>2</sub>	H <sub>2</sub>	O <sub>4</sub>
Formic Acid,	C	H <sub>2</sub>	O <sub>2</sub>

Just as urea is readily broken up into ammonium carbonate, or  $\text{NH}_3$  and  $\text{CO}_2$ , so also formic and oxalic acids, the terminals of the non-nitrogenous organic molecules, readily undergo decomposition into  $\text{CO}_2$  and  $\text{H}_2\text{O}$ .

It cannot be pretended that we are familiar with all the intermediary stages of these retrogressive metamorphoses, yet we are possessed of numerous facts, gained through the study of the decomposition of albumen by various chemical agents, which go far to fix the character of these changes. Thus, in the artificial decomposition of albumen by certain chemical reagents, asparagin, glutaninic acid, leucin, and tyrosin are constantly met with; and since these bodies occur in the process of germination in seeds, and the latter two often in the animal body at the seat of rapid break down of albuminoid matter, we may infer that a similar process normally occurs in animal cells. So, also, by various methods of oxidation uric acid is readily converted outside of the body into urea, allantoin, oxalic acid, and carbon dioxide; and there are many facts for supposing that a similar conversion occurs in the animal body. Thus, the administration of uric acid produces not an increase in the uric acid eliminated, but in the urea and calcium oxalate; and since uric acid is normally present in but small amount in the urine of the carnivora, and is absent in that of the herbivora, while we know that in certain organs of both classes of animals it is formed in considerable amount, it must undergo oxidation in the economy. This is further proved by the fact that a reduction in the supply of oxygen leads to an increase in the uric acid and a decrease of the urea in the urine. In a similar way is to be explained the appearance of allantoin in the urine of cats and dogs when fed on abundant animal diet.

A similar line of argument may be made to apply to the decomposition of the non-nitrogenous tissue-constituents.

We are thus, to a certain extent, familiar with the starting point and terminals of the series of decompositions which occur in the animal body, and with a few of the intermediary links in this chain. We shall again have to return to this subject in the study of Nutrition.

3. *Fermentations.*—The word fermentation is derived from *fervere*, to boil, and owes its origin to the appearance presented by sugary fluids when placed in contact with ferments; gas is liberated, the sugar disappears, and the product becomes alcoholic. While the term fermentation was originally restricted to this process, it is now applied to many cases in which an organic body when dissolved is modified, changed, and transformed under the action of formed or soluble ferments. As regards the action of fermentation only the results and processes of the soluble ferments will here demand consideration.

The soluble ferments act on a large number of organic compounds,

their mode of action being largely the same in all. Water is always essential to the processes of fermentation, and the result is acquired by a more or less simple splitting up of the organic molecule accompanied by hydration. The nature of this splitting up is governed by the nature of the body which is subjected to fermentation, and may be explained in most cases by chemical processes in which the intervention of a living organism does not appear. Ferments have been classified as follows in the character of the change which they produce (Hoppe-Seyler):—

#### CHANGE OF ANHYDRIDES INTO HYDRATES.

##### A. *Ferments that Act like Dilute Mineral Acids at a High Temperature.*

a. The conversion of starch into sugar, or glycogen into dextrin and grape-sugar, as by the action of ptyalin, the amylolytic ferment of the pancreatic or intestinal juices, diastase, or the liver-ferment. Thus:—

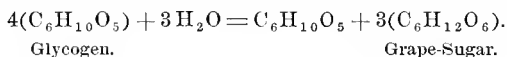

or, in the case of starch:—

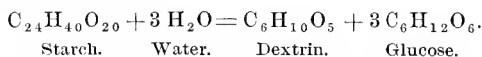

b. The conversion of cane- into grape-sugar, as by the inversive ferment:—

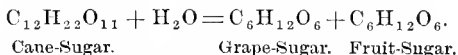

This reaction also gradually occurs through the action of water at 100° C., while starch requires a temperature of 170°, the resulting sugar at the same time undergoing decomposition.

##### B. *Ferments that Act like Caustic Alkalies at a High Temperature— Fermentative Saponification.*

a. Splitting up of fats into glycerin and fatty acids, as by the action of the ferment of the pancreatic juice.

b. Splitting up of amydo compounds by hydration through decomposition products, as

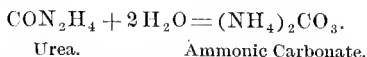

The changes in albuminoids produced by the pancreatic ferment and in decomposition probably fall under this category.

FERMENTATION PROCESSES, WITH TRANSFER OF OXYGEN FROM THE HYDROGEN TO THE CARBON ATOMS.

*a. Lactic Acid Fermentation.*—Under the action of various ferments sugar is converted into lactic acid. This occurs in the milk, and also very probably in sugary solutions within the intestine. In the first stage of this process lactic acid is produced as follows:—

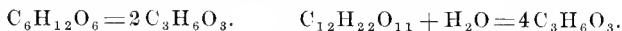

In the later stages butyric acid, carbon dioxide, and hydrogen are formed. Thus:—

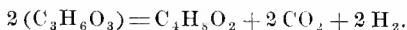

*b. Alcoholic Fermentation.*—Under the influence of various of the formed ferments, such as yeast-plant, grape-sugar undergoes fermentation and results in the formation of carbon dioxide and alcohol.

*c. Putrefactive Fermentation.*—Ferments which cause putrefaction are found in the lowest organisms, micrococci, bacteria, etc. Their action is destroyed by heating above 53° C.

The most important ferments in the chemical processes occurring in the animal body are the *diastatic* or sugar-forming ferments, found in the saliva, pancreatic and intestinal juices, liver, and blood; the *peptone-forming* ferments, found in gastric, pancreatic, and, perhaps, intestinal secretions; the *fat-ferment*, found in pancreatic juice; the *inversive* ferment, found in intestinal juice; and the *milk-curdling* ferments, found in the gastric and pancreatic secretions. All the above ferments, with the exception, possibly, of the last, are so-called hydrolytic ferments; that is, their action is accompanied by a process of hydration. Water is essential to all forms of fermentation; hence, ferments become inert when dried. For the action of the proteolytic ferment of the gastric secretion a faintly acid reaction is essential, as is also the case for the pepsin-like ferment of the insectivorous plants, such as the *Drosera* and *Dionæa*, which have the power of digesting albuminous bodies. An excess of acid will, however, interfere with the action of the proteolytic, as well as of the diastatic, ferments; the same holds good for the caustic alkalies, although an alkaline reaction favors the action of the proteolytic ferment of the pancreatic juice. Salts of the heavy metals, as well as ether, chloroform, and all the so-called antiseptics, prevent fermentation.

Further details as to the action of ferments will be considered under the study of the digestive juices and the putrefactive changes in the alimentary canal.

4. *The Consumption and Development of Force in Cells\**.—The development of force in cells is closely dependent on the chemical inter-

\* Wundt, "Lehrbuch der Physiologie."

changes occurring in the interior of cells. The constituents of all chemical compounds are held together by their chemical affinities, and compound atoms hence exhibit a lesser tendency to form new combinations than do free, uncombined atoms. When, however, a combination is broken up, as by some external force, the separated atoms again tend to unite. There is again a difference in the stability of chemical compounds. In other words, new combinations are more readily formed in some instances than in others. Thus, the loosely-held oxygen atom in hydrogen peroxide ( $H_2O_2$ ) is much more readily given up to form fresh combinations than the closely-held atom of oxygen in  $H_2O$ . Thus, forces which only exist as a *tendency* to produce motion are termed potential forces; those, on the other hand, which actually manifest themselves in movements are actual or kinetic forces. The tendency to combine is, therefore, a potential force, which varies according to the free or combined state of the atoms, and, in the latter case, according as the atoms are held in loose or close combination. The atom released from chemical combination acquires an increased potential force, while an atom which passes from the free to the combined state loses in potential. In every chemical decomposition, or the passage from close to loose compounds, the potential force is developed, while in the formation of other chemical compounds, or the passage from loose to close compounds, the potential is diminished. The separation and union of the elements and formation of chemical compounds are, therefore, movements of the elements; consequently, in their decomposition or composition actual forces are produced. When atoms unite, a part of the force which before existed as a tendency to form combination (the potential force) is converted into actual or kinetic force, and the combination has lost potential to that extent to which the tendency to form combinations is satisfied. In decomposition the exact opposite holds. In order to break up combinations an external force is required, and the amount of potential acquired by the atoms is precisely equal to the actual force employed. It follows from this that in the act of every chemical composition actual force is liberated, and in every chemical decomposition actual force is rendered latent, or is converted into potential. In the first case the force developed is equal to the potential lost in combination, and in the second case the actual force rendered latent equals the potential force developed. Where a loss of potential occurs, it is compensated for by a proportional development of actual force, and *vice versa*.

The same rule applies to all forces in nature. Every development of force is to be regarded as a change from actual to potential force or the reverse, or the transformations of different forms of actual force. This law is known as the conservation of energy. The forms of actual force that we are familiar with are movements of masses, light, heat, and elec-



tricity. All the actual forces have a tendency to be converted into a single actual force, heat; thus, as the motions of bodies decrease through friction and the resistance of the atmosphere, and as the electric current meets with resistance, they are converted into heat. So, also, the form of movement which appears as actual force in the formation of chemical compounds is usually manifested by the development of heat, or occasional light; and the actual forces which disappear in chemical decomposition are again usually represented by heat or light. Nearly all bodies are chemical compounds; that is, their atoms are bound together by their affinity for their atoms. This also applies to the isolated elements which, in their free state, exist as molecules of like atoms. So long as no external force is brought to bear upon chemical compounds, there is no tendency to decomposition or formation of new compounds.

Heat is the most ordinary external force which produces chemical change. The stability of chemical compounds may therefore be measured by the amount of heat required to break up the compound. Every compound, even the most stable, may be broken up if the heat is sufficient. While  $\text{CO}_2$  requires enormous heat to decompose it, the organic compounds of carbon are decomposed at moderate temperature. Consequently, in the latter case the atoms are loosely combined; that is, in the formation of this combination not all the potential affinity is converted into actual energy, but a considerable degree of potential, with a tendency to form compounds, still remains. When to such compounds heat is applied in a degree equal to the amount of actual energy liberated in the formation of the compound, the atoms are liberated and again acquire their original potential energy. If a new combination is now formed, the potential is again converted into actual energy, and the latter, in the form of heat, is proportional to the closeness of the new compound. This is the process which is concerned in the burning of every organic compound. Thus, by the artificial application of heat single atoms of the combustible body and of the atmosphere are separated and their combination results in the liberation of heat, which is itself sufficient to decompose other atomic combinations, and the processes of combustion goes on by itself. The entire amount of heat liberated equals the difference between the amount of heat required to break up the organic compound and the amount liberated in the formation of simpler, closer compounds. If, on the other hand, atoms, if they are separated by considerable force, do not enter into a closer but into a looser compound, more actual energy is lost than is liberated, and a decomposition results in which a certain amount of heat is used up, which in the new combination is present as potential force for future combustions. The amount of potential energy is therefore dependent on the closeness of the chemical combination, and not on the separation of the affinities. As a rule,

the closeness of the combination is inversely proportional to its complexity.

The degree of potential energy of a combination may be measured by the amount of heat liberated in its combustion; thus, a heat unit is the amount of heat required to raise one gramme of water one degree C. So one gramme of carbon yields 8000 heat units, or calories; one gramme of hydrogen equals 34,000 heat units. These numbers are greatly modified when the carbon and hydrogen are combined or enter into combination with other elements. Thus, when pure carbon is oxidized to  $\text{CO}_2$ , the heat developed is less than when, with an equal quantity of O, CO, or combinations of CH and O and  $\text{H}_2\text{O}$  are burned to form  $\text{CO}_2$ . The higher the atomic weight of compounds, the greater the amount of heat given off in combustion. Thus, fats yield more heat than sugar and alcohol; but while equal weights of such high atomic bodies yield more heat in proportion to their weight, when compared with equal quantities of oxygen consumed they yield less than simpler bodies, as sugar or alcohol.

The elementary compounds which are found in animal and vegetable cells in no way differ from those found in inorganic nature. Similar elementary substances are found in the earth and atmosphere, and become constituents of animal and vegetable organisms. In organisms chemical affinity exerts the same sway as in inanimate nature. Acids unite with bases to form salts within cells just as without; no one of the elementary constituents of cells has lost its power of uniting with oxygen, and the products so formed are identical with similar bodies formed elsewhere.

We have already traced the processes occurring in animal and vegetable cells, by which these bodies are converted in the former from simple elementary substances to complex organic bodies, and in the latter again reduced to their simple elementary form. It is evident that the animal and vegetable cells differing in the chemical processes which occur within them will also differ in the transformations of energy which occur within them. Thus, we have seen that vegetable cells containing chlorophyll convert stable oxygen compounds of carbon and hydrogen,  $\text{CO}_2$  and  $\text{H}_2\text{O}$ , with liberation of oxygen, into the looser organic compounds, such as starch, or, less frequently, glucose or fat. They therefore return to atoms of these combinations a portion of their potential energy, which in the original transformation into  $\text{CO}_2$  and  $\text{H}_2\text{O}$  they had lost in actual energy in the form of heat. To accomplish this, plant-cells require the assistance of an external force, namely, the heat and light of the sun, which they convert into a chemical potential force in the resulting organic compounds. The condition is more complicated in cells which possess no chlorophyll. Here, also, the reduction processes require an

external force; but in such a process as the manufacture of fat out of carbo-hydrates, or the synthesis of albuminoids out of carbo-hydrates and inorganic nitrogenous compounds, or the formation of starch, cellulose, etc., out of glucose, the potential energy developed is not derived from an external force, as the light in chlorophyll plants, but from a force inherent in the cell itself. This force is manifested in the oxidation processes occurring in colorless protoplasm, and which are evidenced by the excretion of  $\text{CO}_2$  and  $\text{H}_2\text{O}$  as combustion products. Thus, in the synthesis of higher carbo-hydrates from glucose a combustion results, in which  $\text{H}_2\text{O}$  is formed, and in it the two atoms H and O are more closely united with one another; in this process potential energy is transformed into actual force. In order to comprehend the formation of fat or albuminoids out of oxygen compounds without a simultaneous liberation of oxygen there must also always be an additional combustion of loosely-combined carbon into  $\text{CO}_2$ ; from this it follows that pure oxidation processes occur in such cells, such as the formation of vegetable acids out of carbo-hydrates, volatile acids from fixed fatty acids,—processes which yield a certain amount of actual energy in the form of heat, of which a part is again rendered latent in the formation of chemical potential energy. As a whole, in cells free from chlorophyll the processes accompanied by the liberation of actual forces preponderate over those in which actual energy is consumed. In every such cell, therefore, there is an actual development of heat. A small part of this actual energy, before being converted into heat, may be transformed into the mechanical movements already described. Every independent organism which is free from chlorophyll manifests changes which result in the same transformation of force as described above; such examples are seen in the case of the organized ferments.

The animal cells, on the other hand, directly appropriate highly complex substances, such as albumen, fats, and carbo-hydrates, in which a high degree of potential energy is contained. In the act of forming by oxidation simpler compounds, such as  $\text{CO}_2$ ,  $\text{H}_2\text{O}$ , and  $\text{NH}_3$ , their potential energy is transformed into actual force, partly manifested by heat-production, and by protoplasmic contractile movements. In animal cells, therefore, the main characteristic is the conversion of the potential energy of organic compounds into the actual forces of heat and mechanical movements; the process being much the same as has already been referred to as occurring in the vegetable cells free from chlorophyll, differing mainly in intensity. A reverse process may be also present by which actual force may be consumed and potential energy stored up, as in the formation of complex albuminoids, such as hæmoglobin, or in the re-formation of albumen out of peptones.



# PART II.

## SPECIAL PHYSIOLOGY.



BOOK I.

THE NUTRITIVE FUNCTIONS.





## SECTION I.

### FOODS.

IN comparing the metamorphosis of matter in animal and vegetable organisms it has been found that in both cases there exists a certain relationship between such changes and the surrounding media. In the two classes of organisms, however, these processes are diametrically opposite; for, while we found that the higher plants remove for nutritive purposes  $\text{CO}_2$  from the atmosphere and returned O to it, the animal economy retains a portion of the oxygen of the atmosphere, not remaining fixed as such in the body, but to be again returned to the atmosphere as  $\text{CO}_2$  and  $\text{H}_2\text{O}$ . For plants, consequently, since we found that the carbon of the  $\text{CO}_2$  and a portion of the hydrogen of the  $\text{H}_2\text{O}$  become fixed in their tissues, the atmosphere is a true food; for animals it merely enables tissue metabolism to take place, and permits of the maintenance of animal heat. The development and growth of plants is dependent on the liberation of oxygen and the appropriation of the inorganic constituents of their foods. In animals life depends upon the constant appropriation of oxygen, its union with the different constituents of the body, and final elimination through the lungs and skin as  $\text{CO}_2$  and  $\text{H}_2\text{O}$ , and through the bowels and kidneys in other simple compounds. Therefore, through the absorption of oxygen there is produced no increase in bulk of the animal body, but rather a decrease. To meet this waste of the organism there must be a constant appropriation of tissue-constituents. Such substances are called foods.

Nutrition may be defined as the functions which are concerned in the preservation of the individual. Foods may, therefore, be defined as any substances which may serve nutritive purposes. The body being in a constant state of mutation, the constituents of the organism are little by little eliminated as the result of this mutation, and to preserve the necessary balance must be replaced. There must, therefore, be an exact correlation between the constituents of an organism and the aliments required by that organism. The demand for aliment is governed by the waste; if the supply is not as great as the waste, the body loses weight. If, on the contrary, as in youth, the supply is greater than the waste, the body increases in weight. When the losses of the economy reach a certain degree without a sufficient reparation having taken place, when the disassimilation exceeds the assimilation, the sense of hunger

reveals the wants of the organism and creates a demand for food. If these demands are not attended to, other more serious phenomena result. These, as well as the sensations of hunger and thirst, will be described at a later point.

Not only must the aliments taken to repair waste have a certain weight, but they must also have a definite quality, since nitrogenous and non-nitrogenous material, water and inorganic substances, all escape through the various excretions, and their losses must be supplied by analogous substances in quantities in proportion to the amounts lost by excretion. Under all circumstances the foods of animals are organic, and these foods for the most part contain those inorganic substances already prepared which form the direct constituents of the animal body; they are therefore analogous and equivalent to what they replace. The animal economy does not, as does the plant, supply its nutritive wants by synthesis and condensation of the substances contained in its food; but it requires the constituents of its flesh and blood to be already formed in its food. In the flesh of the herbivora the carnivora consume flesh similar to their own. In plants the herbivora obtain ready-formed constituents of their flesh and blood. The end products of the activity of plant life, vegetable albumen, and other constituents of vegetable tissue, serve directly and without further extensive chemical modification to supply the waste in the animal economy; consequently, plants act as the food-preparing organisms in the general circle of life. Vegetable life must, therefore, first have appeared on the earth, for it is a necessary condition for the existence of animal life; both herbivora and carnivora are dependent upon the vegetable kingdom for food. In vegetable matters are repeated the most complex ingredients of animal tissues. Chemists have been so struck by the similarity of such bodies that they have designated them by the same names. Thus, we have vegetable albumen, vegetable fibrin, vegetable casein, representing the albuminous group. Among the carbo-hydrates we have starches and sugars, and it is well known that fats are abundant in the vegetable kingdom. Animals, therefore, find their tissue-constituents ready-made in their food, whatever be its nature.

The principles of food, whether derived from the animal or vegetable kingdom, and whether appropriated by the herbivora or carnivora, are not retained in the organism in the form in which they are taken as food. They must first be subjected to certain modifications before they can become constituents of the animal tissue or juices; in other words, they cannot fulfill their nutritive purposes until they have been subjected to preparatory modifications in the digestive tube. These modifications are not in general very profound, and usually consist in reducing foods to a soluble form, if not already so, or in reducing them to a state in which

absorption is possible. This is the sole end of digestion. The aliments are in the digestive tract split up into their nutritive elements, which are prepared for their absorption, while the non-nutritive portions are expelled. Thus, the blood of animals is continually receiving additions from the food, which it carries to different organs and tissues. Certain of these are fixed or assimilated, replacing analogous substances rendered unfit for carrying on the vital functions; the others are modified and destroyed. There is thus an incessant movement in the animal economy, a continuous interchange of material, and a double current of entering and expelled materials. This double current is marked by two series of chemical phenomena,—the one terminating in the fixation of the nutritive principles in the economy, in their assimilation; the other in their decomposition, their retrogressive metamorphosis, or their disassimilation. The *ensemble* of these two chemical phenomena constitutes nutrition.

Foods of animals are destined to supply the waste of tissues. They must, therefore, to be complete, embrace all the tissue-ingredients which are liable to waste. The statement, therefore, of these tissue-constituents will be also a statement of the essential food-stuffs. The chief constituents of the blood, flesh, and other tissues, as we have seen, may be classified as follow:—

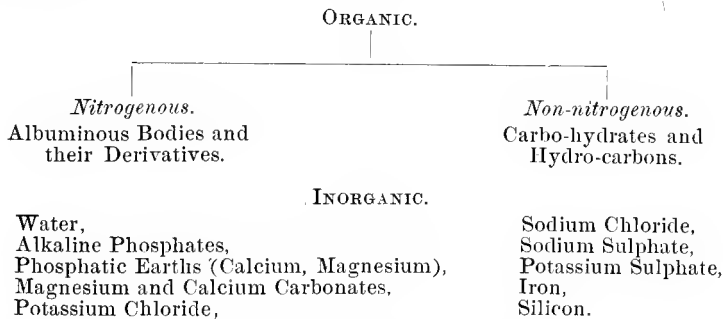

It is rarely the case, however, that these simple nutritive substances are taken separately as food. Ordinarily the alimentary substances are formed of mixtures, in various proportions, of the simple nutritive substances. Thus, water that we drink contains mineral salts in solution. Meat contains water, albuminous bodies, salts, and fats, while milk contains all the alimentary principles. We must therefore distinguish between simple nutritive substances and foods which contain several of these bodies.

In addition to the simple food-stuffs, there are other substances not belonging to any of the above classes which have certain nutritive values, such as alcohol, organic acids, tea, coffee, and essential oils. These are

termed accessory foods, and have but little bearing on the study of nutrition in the domestic animals.

Blood is the chief nutritive fluid of animals. What, therefore, is to be converted into tissue must first be converted into blood; consequently, the substances taken in food must be converted into blood, or, at least, pass into the blood, to be of nutritive value. Blood contains about 80 per cent. of water and 20 per cent. of solids. Of the latter,  $1\frac{1}{2}$  per cent. is organic, consisting of albuminous bodies, fats, and carbo-hydrates, the latter being represented by glucose and occurring in small quantities. Blood, therefore, contains all the constituents of the tissues and the elements for their formation, so arranged as to require but slight chemical modification to transform them into tissue. Blood consequently contains, in suitable form, all the organic elements necessary for the formation of all the animal tissues and fluids. The constituents of the blood and flesh of the carnivora are absolutely identical with the constituents of the blood and flesh of those animals which serve as their food. The nutritive processes of the carnivora consist, therefore, in a simple nutritive conversion of the blood and flesh of herbivora. Suckling animals, whether herbivorous or carnivorous, obtain in milk what might be regarded as the equivalent of the flesh of their mother, since milk contains representatives of all the constituents of blood, casein and albumen representing the albuminous group, butter the fats, and milk-sugar the carbo-hydrates. The same inorganic salts are also found in the milk as in the blood, and water is present in large amount.

In the herbivora the nutritive processes are not less simple, since all parts of plants which serve as their food contain representatives of albuminous, carbo-hydrate, and fatty tissue-constituents which are similar, or almost identical, to those found in the animal tissues. Consequently, the vegetable bodies which serve as foods for animals contain, ready formed, the constituents of animal tissues, and the nutritive value of vegetable foods is in direct relation to the proportion of these substances present. It may therefore be said that animals are dependent upon the inorganic matters of the earth and air for their food-stuffs; for from these inorganic constituents of the earth's surface plants indirectly create the blood and flesh of herbivora, and in the blood and flesh of herbivora the carnivora, in a strict sense, may be said only to obtain matter of vegetable origin with which the former were nourished. Animals, therefore, through the mediation of plants are built up out of  $\text{CO}_2$ ,  $\text{H}_2\text{O}$ ,  $\text{NH}_3$ ,  $\text{NO}_3\text{H}$ , and a few other inorganic compounds (Gorup-Besancz).

What has been said about the renewal of the organic tissue-elements might be repeated for the inorganic tissue-constituents of animals. These are also obtained, ready prepared and ready for assimilation, by both carnivora and herbivora. The inorganic constituents of the blood of the

herbivorous animals are precisely similar to the inorganic constituents of the vegetable matters which serve as their food. The inorganic constituents of the blood are the same as the inorganic constituents of tissues. Herbivora and carnivora therefore find in their foods their necessary inorganic tissue-constituents. The statement above made that animals must obtain in their foods constituents of their blood and tissues ready prepared may be modified in the case of the fats; for it has been found that, so far from being derived from fats taken as food, the greater part of the fats stored up in the body is derived from the breaking up of other organic bodies, especially the albuminoids.

### I. VEGETABLE FOODS.

The nutritive principles of vegetable foods are disseminated in various proportions in different parts of all vegetables; there is therefore no vegetable which is intrinsically incapable of serving as animal food. But all vegetables do not contain these nutritive principles in equal degrees, or in such a state as to permit of their isolation and appropriation by the animal digestive apparatus; nor are they in all the vegetables free from noxious principles. Thus, some vegetables, as the herbaceous plants, contain nutritive principles in all their parts; others, only in their roots, stem, bark, leaves, fruit, or juices. Some may form suitable foods for a large number of different species of animals; others are only capable of nourishing a single species; and some plants which are food for certain groups of animals are poisons to others. The parts of plants above the ground—that is, their stem, leaves, flowers, and fruits—are in general the most nutritious from the time when vegetation is well commenced to the time of flowering, because then the nutritive principles are not yet fixed in the organs of fructification, and the parts in which they are disseminated are soft and tender. Earlier than this the herbaceous plants are too watery and later too dry to prove very nutritious. The stems of leguminous plants are nutritive while young, while their leaves are suitable for food in all varieties of vegetation. The roots of plants, when soft and succulent, serve as food for many animals, such as the hog and bear, the tapir and hippopotamus, and when cultivated form valuable food for man. Soft and pulpy fruits, dried fruits, nuts, hulls, and seeds, which are almost invariably rich in mucilaginous matters,—with sugar, starch, oil, and nitrogenous principles,—are often food for many animals. Under certain circumstances, parts of plants which are usually but slightly nutritive, such as the bark, stems, and roots, or even woody tissue, may serve as foods, especially after having undergone partial decomposition, for many animals, particularly the beaver and other rodents, and various insects.

Vegetable foods differ from foods of animal origin in the respect that the nutritive principles are not present in as concentrated form as in animal foods, and the non-nitrogenous food-stuffs are present in much greater abundance than the nitrogenous; moreover, vegetable foods are, as a rule, very much less readily digestible than animal foods, from the fact that the nutritive principles are inclosed within cellulose capsules, which offer great resistance to the solvent action of the digestive juices, and which necessitates fine comminution before being capable of being digested and absorbed. As a consequence of this the residue from the digestion of vegetable matter is always very much more abundant than from an animal diet, and hence the intestinal excreta of the herbivora are always much more bulky than of the carnivora, or even of the omnivora. Another point of contrast between vegetable and animal food is found in the difference of inorganic constituents of the ash. Vegetable foods are especially rich in potassium and magnesium salts, and comparatively poor in sodium salts, while chlorides are present in extremely small amount, and phosphates in considerable quantities. As already indicated, in vegetable tissues representatives of all the different food-stuffs are to be found; thus, vegetable albumen is present, and in its characteristics appears identical almost with the albumen of animal origin. So, also, are carbo-hydrates, oils, and inorganic salts. The relative proportions of these substances vary in different plants. The usefulness, therefore, of different forms of vegetable food for different nutritive purposes depends upon differences in the relative proportions of these constituents. The vegetable foods may be given to our domestic animals in the fresh state, containing their natural juices, when they are termed *green fodder*, or after having been dried by the sun, when they are called *dry fodder*.

Green fodder always contains a large amount of water in proportion to the solids present, the proportion often being 75 per cent. water to 25 per cent. solids. Of the solids the albuminous bodies may amount to 10 or 20 per cent., the non-nitrogenous extractive matters varying between 50 and 60 per cent., while cellulose is present in large amount. All edible grasses and vegetable tops may serve as green fodder.

Dry fodder consists of the stems and leaves of various grasses and plants after the major part of their water has been removed by evaporation by the sun's heat. The proportion of water to solids in dry fodder is reduced to 15 per cent. of the former to 85 per cent. of the latter. Of the solids of dry fodder cellulose constitutes from 20 to 40 per cent., a moderate amount of albuminoids and carbo-hydrates, less fat, and a maximum of inorganic matter.

Green fodder, as a rule, is more readily digestible than dry fodder. Thus, experiments made by feeding oxen at one time with fresh red clover,

and another time with the same material carefully dried, have shown the following excess of matters digested in favor of the green fodder:—

Solids,	2.3 to 5.5 per cent. more digested.
Proteids, . . . . .	2.7 to 3.2 “ “ “
Carbo-hydrates,	4.1 to 5.6 “ “ “
Fats,	2.4 to 21.0 “ “ “
Cellulose,	2.6 to 6.2 “ “ “

The attempt has been made to attribute these results to the reduction in digestibility acquired in the processes of drying. This is not, however, the case, since there is an actual loss of digestible matter in the processes of fermentation which occur in the act of drying. Green fodder is especially adapted for all ruminants, and for young horses after the completion of the first year. Scarcely any single green fodder is, however, suited for forming the single food of horses or sheep. The percentage of water of most green fodders in every stage of growth amounts to from 70 to 90 per cent., and there are but few green fodders which contain so little water that they may serve without the mixture of any dry fodder for feeding sheep or horses. Cattle, on the other hand, require a watery food, while hogs, on account of the arrangement of their digestive apparatus, are only capable of digesting small amounts of the youngest and most tender green foods. Green fodder, as a rule, is the more nutritious the younger and more tender it is, since, in spite of the greater amount of water contained in this period, it also contains a larger amount of nitrogenous nutritive substances, is more stimulating to the appetite, and is more readily digested. Thus, it has been found that in the English bay grass (*Lolium perenne*) the composition varies as follows (Pott):—

	Water.	Cellulose.	Proteids.
On the 6th of May,	81.2	17.7	27.9
From the 25th to the 27th of May,	83.5	21.4	16.0
On the 10th of June,	82.9	22.4	14.8
On the 24th of June,	82.4	23.6	12.8
On the 10th of July,	82.2	32.5	11.9
On the 22d of July,	76.9	28.6	12.5
On the 15th of August,	74.8	29.7	7.8

Similar results have been obtained in the case of clover and prairie hay. From the fact that green fodder in early spring is so rich in proteids it is advisable in this time of the year to administer it mixed with chopped straw that the fodder be not too rich in nitrogenous compounds.

The following represent the principal vegetable food-stuffs: the seeds of the grains, or the cereals; the hulls and fruits of the leguminous plants; the vegetables, as potatoes, turnips, and beets; and hay, grasses and straw, of the green and dry fodders:—

1. THE CEREALS.—Wheat, barley, corn, rice, and oats belong to this group, and are valuable food-stuffs. Their chemical composition is

subject to variations dependent upon the mode of culture, the nature of the soil, and the climate. They all contain a small amount of water and cellulose in proportion to a large amount of solids (over 80 per cent.) in which non-nitrogenous extractives and inorganic matters are in excess. The following table gives their average composition:—

In 100 parts.	Wheat.	Rye.	Barley.	Oats.	Rice.	Corn.
Water,	13.6	15.3	13.8	13.5	13.2	13.9
Albumen,	12.4	11.4	11.2	11.9	7.8	10.1
Fat,	1.7	1.7	2.1	5.8	0.7	4.8
Carbo-hydrates and non-nitrogenous extractive matters,	67.9	67.8	65.5	57.5	76.4	66.8
Cellulose,	2.7	2.0	4.8	8.1	0.8	2.8
Ash,	1.7	1.8	2.6	3.2	1.1	1.7

The cereal grains, of which wheat may be taken as a type, consist of a number of layers arranged eccentrically. As many as seven different layers have been recognized. Externally there is the external membrane or epidermis; within that the epicarpium; 3d, the endocarpium; 4th, the pigment-layer, or the testa, which in wheat is a reddish-brown membrane, and gives to wheat-grains their characteristic color; 5th, the tegmen, or external nuclear membrane, below which are found a number of dice-shaped cells (the perisperm), which were formerly spoken of as gluten-cells, in which, however, the contents are mainly starch; and it is within the endosperm that the albuminous contents is contained between the starchy granules. For, if a granule of wheat is divided and touched with a drop of Millon's solution, it will be seen that the contents of the endosperm only stain purple, while the shells and the so-called gluten-cells remain unchanged.

When wheat is subjected to the action of a digestive fluid the albuminous bodies of the endosperm are dissolved and the starchy granules become separated, while the hulls and so-called gluten-cells remain entirely unaffected. The hulls contain a certain amount of albuminous bodies, and are employed in bran and in black bread, and have considerable nutritive value. In the so-called gluten-cells a ferment seems to be present which has been called *cerealin*, and which seems to interfere in some way with digestion, and as a consequence, although bran-bread is to a certain extent nutritious, it is yet difficult to digest. In grinding, the external hulls or capsules are bursted and the contents reduced to a fine powder in the mill, and thus become more digestible. Hulls which are separated from the internal contents by milling always contain a certain amount of albuminous matter and starch clinging to them, so that even the chaff, or the hull or bran, contains considerable amounts of nutritive matter, and may be used as fodder. Bran from wheat has been found to contain 13 per cent. water, 14.5 per cent.



albumen, 2 per cent. fat, 53 per cent. carbo-hydrates, and 17.5 per cent. cellulose.

The preparation of bread depends upon the fermentation produced through the action of the yeast-plant in rye- or wheat-meal mixed to a thick paste with water, the so-called dough, and allowed to ferment at about 30° C. Through the action of the yeast part of the starch is converted into dextrin and sugar, of which a part again undergoes further decomposition into carbon dioxide and alcohol. The bubbles of the former serve to render the dough light and porous. In baking the gas-bubbles expand through the heat and render the bread still more

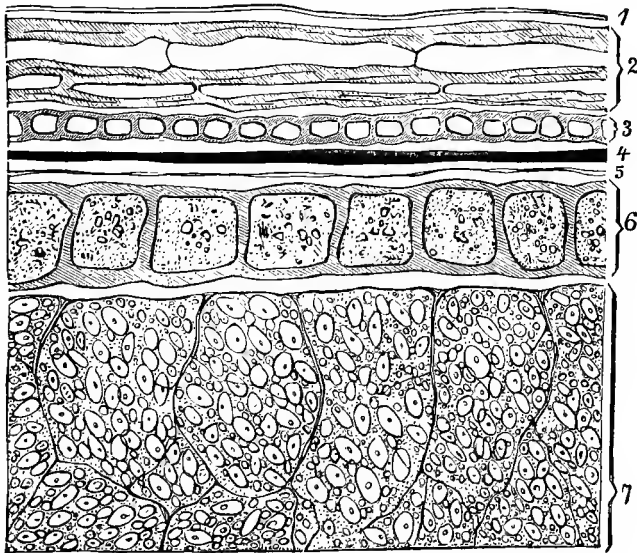

FIG. 55.—SECTION OF A WHEAT-GRAIN, MAGNIFIED 610 DIAMETERS, AFTER PEKÁR. (*Thanhoffer.*)

1, epidermis; 2, epicarpium; 3, endocarpium; 4, testa; 5, tegmen; 6, perisperm; 7, endosperm.

porous, and therefore more permeable to the digestive juices and more readily digestible, while in the action of the heat a certain amount of starch is still further converted into dextrin and sugar. The nutritive properties of bread depend upon the starch, dextrin, sugar, and albumen which are contained within it. Bread, therefore, contains all the nutritive principles in some amount, as a certain amount of oils and inorganic salts are also present, although the carbo-hydrates are present in the largest proportion. It has been estimated that a man, to obtain the necessary amount of albumen required for his daily ration, would have to consume three pounds of bread daily.

Oats, rye, and corn also have their various constituents arranged

in concentric layers, in which also the so-called gluten-cells are to be recognized, as well as numerous free starchy granules. The relative proportions of the different constituents vary in different samples, and hence the nutritive value of these grains depends upon the method of cultivation, etc. Corn and rye are especially rich in starch, but are poorer than wheat in albumen. By soaking in boiling water,—the only way in which rice is used as a food,—the starch-granules become partially converted into soluble starch, through the rupture of the cellulose membrane and solution of the granulose in water. So prepared, the starch of corn and rice is capable of being entirely absorbed, while only 20 to 30 per cent. of the albuminous matter escapes. Barley and oats are food-constituents which are especially valuable for horses when a large amount of nutritive principles in a concentrated form is required. Rye is poorer in albuminous principles than wheat, but is, nevertheless, a valuable food-stuff. From the point of view of the percentage of albuminous matter, wheat occupies the first place in nutritive value of the cereals. In 1000 parts 135.58 parts of albuminous matters are present. The amount of starch of wheat is only exceeded by the carbohydrates found in corn and rice. The following table, after Thanboffer, shows the amounts of these substances present in 1000 parts of the principal cereals, leguminous plants, and tubers:—

In 1000 parts.	Wheat.	Rye.	Barley.	Oats.	Buckwheat-grits.	Corn.
Albumen,	135.37	107.5	122.5	90.5	78.0	70.0
Starch,	558.64	555.0	482.5	503.5	457.0	637.0
Dextrin,	46.5	84.5				
Sugar,	48.5	28.75				
Cellulose,	32.5	49.5	97.5	116.5	233.0	
Fats,					5.9	

In 1000 parts.	Peas.	Beans.	Lentils.	Potatoes.
Albumen,	223.5	225.2	265.0	13.0
Starch,				154.5

From the above table it is seen that the amount of starch present in rye is somewhat less than that of wheat, but that it contains nearly twice as much dextrin; and yet the cellulose, which is almost entirely indigestible, is in larger amount than in wheat. In barley, again, there is usually a larger amount of albuminous matters than in wheat, but also three times as much cellulose, and a considerably smaller amount of starch. Barley grown in Southern latitudes is said to have a higher percentage of albuminous matter than is represented above. Oats, again, contain a smaller amount of albumen, a larger amount of cellulose, and a larger amount of starch than barley. It thus falls considerably below wheat in albuminous and starchy matters, but exceeds wheat in the amount of cellulose present. Rape-seed, again, contains twice as much cellulose as oats, and even less albumen than starch. Corn contains the smallest

amount of albuminous matter of all of the cereals, but a larger amount of starch than any, and also contains a considerable quantity of oil, and is therefore a useful food for fattening purposes. Rice contains only 5 per cent. of albuminous matter and 82 per cent. of readily-digestible starch.

The nutritive value of oats is very largely governed by the character of manure, and other modes of cultivation. The composition of oat-grains, according to Pott, is about as follows :\*

Solids,	86.3 per cent.
Proteids,	12.0 "
Fats,	6.0 "
Carbo-hydrates,	56.6 "
Cellulose,	9.0 "
Ash,	2.7 "

The nitrogenous matters of oats consist in part of albumen (0.46 to 2.3 per cent.), gliadin, the so-called vegetable casein, the latter appearing to be almost identical with gluten-casein and legumin. In addition, oats appear to contain a nitrogenous alkaloid, the so-called avenine, which possesses the property of acting as a nerve stimulant. This is more abundant in darker sorts of oats, its amount depending upon conditions of climate, soil, etc. It may amount to 0.9 per cent. It also has been found by Ellenberger and Hofmeister that oats contain at least three ferments,—an amylolytic, a proteolytic, and a lactic acid ferment. These ferments are destroyed by the temperature of boiling water, but in the stomach of the domestic animals exert their activity, and are to be regarded as important factors in the gastric digestion of these animals. The most active of these ferments is the starch ferment. It has been found that in a digestion of three hours' duration with water 2 per cent. of sugar resulted from the action of this ferment alone. The lactic acid ferment is considerably weaker, and it is stated that in a digestion of three hours' duration 0.1 per cent. of lactic acid was formed, while 0.2 per cent. was formed in seven hours. The proteid ferment is stated to dissolve from 0.5 in three hours to 1 per cent. of proteids in six hours. These results were obtained by the simple digestion of a mixture of oats and water, kept at the temperature of the body. They have a practical application to the subject of digestion as occurring in animals, and point to the fact that in disturbances of digestion in domestic animals the administration of vegetable food in a raw state is preferable to its use after boiling, and will further, perhaps, explain the high degree of digesti-

\*It will be noticed, in comparing the different tables of the composition of vegetable fodders, that there is considerable discrepancy in the percentages given of the different nutritive principles. This is to be accounted for by different effects of cultivation, etc., in the various samples analyzed.

bility possessed by oats. Wolff has found the following amounts to be digested of the different constituents of oats:—

	Proteids.	Fats.	Carbo-hydrates.
Ruminants,	77.3 per cent.	82.4 per cent.	73.7 per cent.
Horses,	86.0    "	77.6    "	76.3    "

The carbo-hydrate constituents of oats are represented principally by starch, although from 3 to 6 per cent. of sugar, 1.25 to 4.51 per cent. of gum and dextrin have been found. Oats are, above all, the best force-developing food for horses,—a fact which is universally recognized. To foals at first only crushed oats should be given, the transition to whole oats being only gradually accomplished. Oatmeal is also a good addition to the food of milk cattle, and is said to increase both the amount of milk and the amount of butter. As a fattening food for cattle oats are not preferable to other cereals. In the natural form oat-grains are not, as a rule, sufficiently masticated by the ruminants, and therefore their maximum nutritive properties are not appropriated. It is therefore the custom to feed oats to these animals either crushed or in the form of oatmeal. Sheep, which as a rule masticate their food better than other ruminants, are for this reason capable of digesting larger amounts of oats. Oats are also a valuable food for birds. In Pomerania geese are fattened almost solely on this food. It has, however, the disadvantage of causing a thin and unpleasant adipose tissue in these animals. In America oats are roasted with suet, and it is stated that hens fed on this food are especially prolific. Oatmeal is richer in cellulose than the other meals, but it is also at the same time richer in proteids and fats. The average composition of oatmeal, according to J. König, is about as follows:—

Water,	10.1 per cent.
Proteids,	14.3    "
Fats,	5.7    "
Sugar,	2.3    "
Gum and dextrin,	3.1    "
Starch,	60.4    "
Cellulose,	2.2    "
Ash,	2.0    "

Oatmeal is especially valuable as an accessory food in the nourishment of young animals, especially young dogs, when it may be mixed with milk.

Oat-straw has the following composition (Pott):—

Solids,	86.6 per cent.
Proteids,	3.3    "
Fats,	1.4    "
Carbo-hydrates,	42.5    "
Cellulose,	33.3    "
Ash,	6.2    "

It is the most nutritious of the cereal straws. Ruminants digest of the proteid matters 40.7, fats 30.1, carbo-hydrates 45.5 per cent.

In the form of chopped fodder it is a valuable addition to the food of the ruminants and horses. Care must be taken that the straw has not been kept in a moist place; otherwise, when fed to milk cattle, an unpleasant taste will be given to the milk.

It has been stated that of all the cereals oats are the richest in oil and albuminoids, according to Mr. Richardson (*Amer. Chem. Journ.*, October, 1886), the average for the former being 8.14, and for the latter 14.31 per cent. The composition may be placed as follows, in its distribution in the kernel and hull:—

	Kernel.	Hull.	Whole Grain.
Water,	4.85	1.57	6.42
Ash,	1.50	1.68	3.18
Oil,	5.70	0.24	5.94
Carbo-hydrates,	46.96	20.41	67.37
Crude fibre,	0.97	5.36	6.33
Albuminoids,	10.02	0.74	10.76
	<hr/> 70.00	<hr/> 30.00	<hr/> 100.00

It is thus seen that Richardson's analysis of American oats differs from that given by other authorities. He places the percentage of water lower than that of other analysts, whilst the principal increase of solids is found in the oil and inorganic constituents, his estimation of proteids agreeing with that of others. The constituents of oats are, however, very greatly subject to the climate in which they are grown, and Mr. Richardson has found the average albuminoids in the grains distributed as follows over the different sections of the United States:—

Northern States,	10.96 per cent.
Southern States,	10.66 "
Pacific Slope,	9.60 "
Atlantic Slope,	10.76 "
Western States,	11.24 "

These figures are, however, dependent upon the percentage of husk, and not on peculiarities of their kernel, and therefore the proportion of husk to kernel and the compactness of the grain prove to be the most important factors, and the weight per bushel the best means of judging of the value of the grain. Oats having the husk are necessarily heavier in weight per one hundred grains. The heaviest oats are from the Pacific Slope, and the South ranks next, owing to the large size of the grain. In weight per bushel, however, the fluffy husk of the Southern grain makes it the lowest in the country, while the Pacific Slope contains the highest weight per bushel, as also in size and weight per hundred, showing the grain to be plump and well-filled. The heaviest weights per bushel determined by Mr. Richardson were found in specimens from Colorado and Dakota, weighing 48.8 and 48.6 pounds. The lightest were from Alabama and Florida, 24.7 and 26.9 pounds, respectively. He found an

average of 37.2 pounds, the common legal weight being 32 pounds to the bushel.

Of the group of *hordeum* (barley) various representatives are useful as green fodder, but more especially their grains and straw. The composition of barley-grains is greatly modified by the locality of growth and mode of cultivation. The following represents about the average composition:—

Solids, . . . . .	86.2 per cent.
Nitrogenous bodies, . . . . .	11.2 “
Fats, . . . . .	2.1 “
Non-nitrogenous bodies, . . . . .	65.5 “
Cellulose, . . . . .	5.2 “
Ash, . . . . .	2.2 “

The proteids of barley consist in a large part of gluten-casein, gluten-fibrin, mucedin, and albumen. No gluten can be obtained from barley-meal. The carbo-hydrates consist of starch, from 1 to 2½ per cent. sugar, and 1 to 7 per cent. dextrin. The digestibility of the barley-grain is placed by Wolff as follows:—

	Ruminants.	Horses.	Hogs.
Proteids, . . . . .	77 per cent.	80.3 per cent.	78.2 per cent.
Fats, . . . . .	100 “	42.4 “	68.4 “
Carbo-hydrates, . . . . .	87 “	87.3 “	90.0 “

The barley-grains are, therefore, readily digestible, and in the form of meal form a food of the first class in nutritive properties for cattle, and are especially valued for the good influence which they exert on the quality and quantity of the milk and butter. For horses also they may be used to a certain extent as a substitute for oats, given in the entire form, mixed with chopped straw. To old horses or foals, on the other hand, barley should be given as meal, or after being crushed. It has been stated that if the barley-grains are swallowed whole they swell up in the stomach, and may produce serious colic. Therefore, the animals should receive water about half an hour before being fed with barley-grains. The Arabs make use of barley almost solely as food for their horses, and administer it in the entire condition. Barley-meal has the following composition:—

Solids, . . . . .	87.7 per cent.
Proteids, . . . . .	11.6 “
Fats, . . . . .	3.6 “
Carbo-hydrates, . . . . .	52.0 “
Cellulose, . . . . .	14.3 “
Ash, . . . . .	6.2 “

Barley-meal is frequently adulterated with various mineral substances, such as clay, chalk, or plaster, which may cause it to prove hurtful. Such adulterations may, however, be readily recognized by microscopic examination. Barley-straw, especially, as is often the case,

if grown with clover, forms one of the best of the cereal straws, the straw of winter barley being, however, the poorest in nutritive substances of any form of straw. The following is the composition of barley-straw:—

Solids,	85.7 per cent.
Nitrogenous matters,	3.4 "
Fats,	1.4 "
Non-nitrogenous extractive matters,	34.7 "
Cellulose,	41.8 "
Ash,	4.4 "

The following is the composition of barley-straw when grown with clover:—

Solids,	85.7 per cent.
Nitrogenous bodies,	6.5 "
Fats,	2.0 "
Non-nitrogenous extractive matters,	32.5 "
Cellulose,	38.0 "
Ash,	6.7 "

Barley-straw, therefore, grown with clover, almost approaches an average hay in nutritive value. The ruminants digest the following amounts of the different constituents of barley-straw:—

Proteids,	20 per cent.
Fats,	41.6 "
Non-nitrogenous extractive matters,	54.1 "

Barley-bran agrees in its general properties with the bran of the better cereals. It contains—

Solids,	85.8 per cent.
Proteids,	3.1 "
Fats,	1.5 "
Carbo-hydrates,	38.5 "
Cellulose,	30.3 "
Ash,	12.4 "

Barley-bran frequently contains large quantities of the barley-bristles, and should then only be given to animals after being boiled or steamed. Given dry, the bristles stick in the tongue, and produce inflammatory reaction. Steamed barley also is a valuable food. By malting, the barley undergoes mechanical and chemical alterations which lead to the increase in its digestibility, and, although the starch is turned into sugar, there is, nevertheless, in the process of malting a loss in nutritive constituents of the total solids, especially of the nitrogenous bodies. In sprouting there is likewise a loss of proteids, carbo-hydrates, and fats.

Buckwheat is often used as a green fodder, and its grain is frequently administered as dry food. The green buckwheat contains—

Solids,	15.0 per cent.
Proteids,	2.4 "
Fats,	0.6 "
Non-nitrogenous extractive matters,	6.4 "
Cellulose,	4.2 "
Ash,	1.4 "

In digestibility the green buckwheat is almost comparable to clover, but contains a much larger percentage of water, and is not, therefore, well suited to constitute the sole food for cattle. When given to cattle not more than fifty kilogrammes per thousand kilogrammes body weight can be given, the remainder of the food consisting of dry food. On feeding with buckwheat the milk and the butter assume a beautiful yellow color. The green buckwheat is entirely unsuitable for sheep and hogs, either freshly mown or for grazing, and in them frequently causes serious disturbances. On account of its large percentage of water it is only suitable for horses as an accessory food. The conversion of the green buckwheat into hay offers great difficulty on account of its large percentage of water. The grains of buckwheat are principally used as food. They contain—

Solids,	86.8 per cent.
Proteids,	10.1 "
Fats,	1.5 "
Non-nitrogenous extractive matters,	59.5 "
Cellulose,	15.0 "
Ash,	1.8 "

They are thus not especially rich in nitrogenous matters and contain large amounts of cellulose, and belong, therefore, to the more indigestible cereals, but form a good additional food for draught horses, sheep, milk cattle, and fattening cattle. When, however, given in large amounts to ruminants and hogs, they are apt to produce very serious disturbances, especially in summer. In winter, on the other hand, the buckwheat is less hurtful a food, though it is advisable to cease its administration at least two weeks before grazing commences. Buckwheat-meal contains—

Solids,	84.0 per cent.
Proteids,	15.0 "
Fats,	3.5 "
Non-nitrogenous extractive matters,	43.0 "
Cellulose,	19.0 "
Ash,	3.4 "

Buckwheat-meal is, therefore, relatively rich in proteids, and in spite of its considerable amount of cellulose is a good fattening food for hogs. It is frequently adulterated with the seeds of various weeds. Buckwheat-straw belongs to the most useful of this class of fodders. It contains—

Solids,	89.9 per cent.
Proteids,	4.1 "
Fats,	1.4 "
Non-nitrogenous extractive matters,	32.9 "
Cellulose,	44.3 "
Ash,	5.0 "

It contains somewhat more cellulose than most of the straws of the different cereals, and is, therefore, perhaps more indigestible, but it is also richer in proteids.



2. The LEGUMINOUS PLANTS stand next in nutritive value to the cereals. They are composed of the peas, beans, and lentils. By boiling with water their hulls become ruptured, and their contents readily subjected to the action of the digestive juices. The leguminous plants are, therefore, principally used in the form of soups or broths.

The hulled fruits contain a maximum of albuminous matters, and the kernels of oily fruits more fats than the cereals.

Beans are seldom used as green fodder, or as the principal article of diet, since they are too rich in nitrogen; they form, however, an admirable addition to the diet of cattle, sheep, and horses.

Peas, both as a green fodder and as grain, form highly nutritive foods. Green peas are especially good as a food for milk cattle, and give a pleasant taste to the butter. Dried peas are also highly digestible and nutritious. They contain—

Solids,	86.8 per cent.
Proteids,	22.4 "
Fats,	3.0 "
Non-nitrogenous extractive matters,	52.6 "
Cellulose,	6.4 "
Ash,	2.4 "

Of these nutritive principles—

	Proteids.	Fats.	Non-nitrogenous Extractive Matters.
Ruminants digest	88.9 per cent.	74.7 per cent.	93.3 per cent.
Horses	83.0 "	6.9 "	89.0 "
Hogs	85.0 to 90	36.0 to 67	95.0 to 99

The grains are best given chopped up with straw, when they form an excellent food for draught horses, of which amounts equivalent to half of the ordinary corn ration may be given. They are also a fattening food of the first rank for hogs, and, like barley, greatly improve the character of their fat and flesh. When given in large amounts to milk cattle, they are apt to make the butter too hard. The straw of peas is also readily digestible, and of good pea-straw ruminants digest 60.5 per cent. of proteids, 45.9 per cent. of fats, and 64.4 per cent. of non-nitrogenous extractives. When in good condition, pea-straw may even serve as a substitute for hay for young cattle. For milk cattle but small amounts should be given, or else the quantity of milk will be reduced. Unfortunately, pea-straw is apt to be contaminated with that of various weeds and fungi.

The following table gives the average composition of the principal representatives of this group, as contrasted with the potato:—

In 100 parts.	Lentils.	Peas.	Beans.	Potatoes.
Water,	12.5	14.3	14.8	76.0
Albumen,	24.8	22.6	23.7	2.5
Fats,	1.9	1.7	1.6	0.2
Carbo-hydrates,	54.8	53.2	49.3	20.2
Cellulose,	3.6	5.5	7.5	0.4
Ash,	2.4	2.7	3.1	0.5

3. BULBS and ROOTS, represented by the potato, beets, etc., constitute another group of vegetable foods.

Potatoes are of very much less nutritive value than either of the preceding groups of foods, from the fact that they contain but a small amount of albuminous matters, but a very large amount of starch. Large amounts of water are present in bulbs and roots which serve as food, with small amounts of solids (86 to 14). Of the solids, the carbo-hydrates constitute 80 per cent. or more, while the other nutritive substances and inorganic salts are in proportionately small amount. Even of the amount of albumen present only about one-fourth appears to be capable of digestion in the alimentary canal.

In the vegetables, such as beets, asparagus, and cabbages, there is a large per cent. of water,—from 80 to 90 per cent.,—but only 2 per cent. of albuminous matter, 2 to 4 per cent. of starch or gummy substances, a small amount of sugar, and 1 to 1.5 per cent. of cellulose. Their nutritive value is therefore slight.

Fodder-beets (*Beta vulgaris*, mangold-beets), of which a large variety is met with, form valuable articles of fodder, those with the round roots being usually more rich in nutritive constituents. The nutritive qualities of beets are further increased by the character of the soil and climate, mode of culture and manuring, and are especially proportional to the slowness with which they are grown. Fodder-beets have, as a rule, the following constituents:—

Solids,	12.0 per cent.
Proteids,	1.1 "
Fats,	0.1 "
Carbo-hydrates,	9.1 "
Cellulose,	0.9 "
Ash,	0.8 "

Sugar-beets contain—

Solids,	18.5 per cent.
Proteids,	1.0 "
Fats,	0.1 "
Carbo-hydrates,	15.4 "
Cellulose,	1.3 "
Ash,	0.7 "

The principal difference, therefore, between fodder-beets and sugar-beets, is found in the larger percentage of solids in the latter, consisting principally in the greater amounts of sugar. The percentage of sugar is further increased by potassium manures, and is greater in beets grown in cold, high localities than in warm places. It also is in proportion to the length of time, after growth is complete, that the beets are kept in the ground, especially when they have sprouted. Nitrogenous manures and manures rich in phosphates increase the proteid constituents of the beets, although all the nitrogen in the beets is not to be recorded as

proteid. Nitrate of potassium, nitric and oxalic acids, magnesia and other alkalies are constituents of beets, and will often explain the purgative action exerted by many forms of beets. As regards digestibility, Wolf has found that the ruminants digest of sugar-beets—proteids 62.0, carbo-hydrates 95.2 per cent.; of fodder-beets—proteids 75.6, carbo-hydrates 95.3 per cent.

These experiments would seem to show that sugar-beets are less digestible,—a state of affairs which hardly seems probable. On account of the large percentage of water beets contain they can only be used as a fodder with certain restrictions. They are best given in the raw state, chopped up into pieces, although the chopping must not be too fine; otherwise mastication and thorough mixing with the saliva will be, to a large extent, prevented. They are especially suited for milk cattle, combined with dry foods, twenty-five kilogrammes being given daily, and will serve to improve the amount and quality of the butter and milk.

Sugar-beets cannot be given in as large an amount as fodder-beets, on account of their higher percentage of nutritive principles. For young cattle, as well as sheep, on account of their large percentage of water, but small amounts may be given. Thus, one-third to one-half of the total food for these animals may consist of chopped-up raw beets. For hogs the beets may serve as the principal food, especially when given boiled, although here also they may act as a purgative, and it is better that the food should not be more than one-half constituted of the beets. For horses, beets, on account of their high percentage of water, are only exceptionally employed. Beets are best preserved by placing under the ground directly after harvesting, care being taken to select a perfectly dry locality. Beet-top leaves are also very frequently used as fodders. Fresh beet-leaves contain—

Solids, . . . . .	10.7 per cent.
Nitrogen matters,	2.2
Proteids, . . . . .	0.4 “
Carbo-hydrates,	4.8 “
Cellulose,	1.5 “
Ash, . . . . .	1.8 “

On account of the large percentage of water and oxalic acid contained within them, beet-tops frequently act as violent purgatives. They are, however, rich in proteids, and are quite as digestible as the best fresh hay, and in their fresh condition are suitable in small amounts for feeding to milk cattle. If, however, they be given in excessive amounts, or constitute the sole food of milk cattle, the percentage of fat in the milk undergoes a rapid decrease. Not more than one-third of the total amount of food, therefore, should be constituted of beet-tops.

4. GRASSES.—In addition to the above nutritive substances, domestic animals may be nourished on the various grasses, hays, bran, and straw.

The following table gives the average composition of different members of this group:—

In 100 parts.	Prairie Hay.	Rye-Straw.		Grass.
		Best.	Ordinary.	
Water,	13.0	13.8	18.6	75.0
Albumen,	9.5	3.9	1.5	3.0
Fats,	3.1	1.0	1.5	0.8
Carbo-hydrates and non-nitrogenous extractive matters,	40.9	34.7	32.4	13.1
Cellulose,	26.7	40.1	43.0	6.0
Ash,	6.8	6.5	3.0	2.1

Esparcet (*Onobrychis sativa*) is one of the most digestible and valuable of the different forms of clover, and may be regarded as a type of this group. Mowed during the blossoming, it contains in the green state:

Solids,	21.5 per cent.
Nitrogenous substances,	3.5 "
Fats,	0.7 "
Non-nitrogenous extractive matters,	8.5 "
Cellulose,	7.6 "
Ash,	1.2 "

According to Wolff, its digestibility in the ruminants is as follows:—

Proteids.	Fats.	Non-nitrogenous Extractive Matters.
72.5 per cent.	66.7 per cent.	78.3 per cent.

Esparcet-hay contains—

Solids,	85.1 per cent.
Nitrogenous matters,	13.3 "
Fats,	2.5 "
Non-nitrogenous extractive matters,	34.5 "
Cellulose,	29.0 "
Ash,	5.8 "

All forms of fodder undergo in time considerable deterioration in the amounts of their nutritive constituents, especially if preserved in localities where they are accessible to the air, moisture, light, and warmth. Fermentative processes are started up by the presence of various forms of the lower organisms and occasion a reduction in both the non-nitrogenous and proteid constituents of fodders. Thus, prairie hay, when fresh, has a nitrogenous percentage of 1.81 per cent., while, if kept for two years, it falls to 1.68. So long a time as this is, however, not necessary for the evidence of considerable loss of nutritive principles. Thus, Wolff has found the constituents of second-crop hay to vary as follows:—

	In December.	In April.
Proteids,	14.36	14.34
Fats,	4.01	4.24
Cellulose,	26.44	27.18
Non-nitrogenous extractive matters,	45.71	44.80
Inorganic constituents,	9.48	9.44

The more the fodders are protected from the air, the less will be the loss. Thus, it has been found that corn kept in an open space free to the air will form in a given time twice as much carbon dioxide as if kept in a closed space,—of course, it being evident that the greater the formation of carbon dioxide, the greater will be the loss. The moister the locality, also the greater will be the deterioration in nutritive qualities. Thus, oats in thirty months will lose 7.2 per cent. more of their solids than oats kept in closed vessels. Similar facts also apply to the preservation of the moist fodders, such as potatoes, beets, and green fodder. Sprouting of potatoes and beets is likewise accompanied by great loss of nutritive substance, and the presence of solanine in a sprout may even cause it to become poisonous. Thus, Krammer has found that in potatoes with the sprout from 1 to 2 cm. long there is a loss of 3.18 per cent. of starch, when the sprout is 2 to 3 cm. long a loss of 5.26, and when it reaches 4 cm. in length there has been a loss of 9.88. Moulding, likewise, reduces the amount of nutritive substances, in addition to the hurtful action of the moulds themselves. Thus, in sound potatoes there will be an average amount of solids of 23.8 per cent., while mouldy potatoes will average only 20.6 per cent. Age of fodders not only occasions loss in absolute amounts of nutritive constituents, but also diminishes their relative digestibility. Thus, Hofmeister has found that sheep which will digest of clover-hay, when half a year old, 68.4 per cent. of proteids and 73.4 per cent. of carbo-hydrates, when one year old will digest only 65.0 per cent. of proteids and 63.1 per cent. of carbo-hydrates, and when four years old 50.7 per cent. of proteids and 40.7 per cent. of carbo-hydrates. The same facts apply likewise to other forms of hay.

The preservation of grain by stowing it in close chambers is a very ancient one. The process of ensilage as at present carried out is performed simply by placing green-fodder crops, such as grass, clover, vetches, etc., in an air-tight chamber of almost any construction, and, after treading the mass down, covering it with boards on which pressure is exerted, either by dead weights or mechanical means. The grass or other substance may be chopped if thought desirable, and salt may also be added. When preserved in this manner grass may be kept for a long time, and will produce, when opened, a food resembling steamed hay which is greedily consumed by cattle. The whole loss occasioned by this process is but small, and the process of change occurring in food so preserved has been carefully studied by Mr. A. Smetham. He found that fermentation of various kinds had occurred, and he was able to detect a small quantity of alcohol, as well as various acids, of which acetic, lactic, and butyric were the chief. The amount of the acids was not sufficiently great to render the silage unfit for food, and the practical results of feeding with it were decidedly satisfactory. By allowing the temperature

to rise above 125° F. the ferments are destroyed and the production of organic acids thus largely prevented, and a sweet silage is produced which possesses the characteristics of old hay to a much more marked extent than by the old or "sour" process. This process is especially valuable in wet seasons as a means of preserving the crop. It is also invaluable for preserving second crops. A succulent food is obtained in place of a dry one with but little loss in nutritive constituents; certainly less than occurs during hay-making in wet weather, although there is but little increase in the digestibility of the grass.

Vegetable matters all contain from two to eight times as much potassium as sodium, and, as we shall again refer to under the subject of Nutrition, explains the fact that the herbivorous animals need an extra ration of sodium chloride.

Straw is difficult to digest, is only but slightly nutritive, and requires large quantities of the digestive secretions for the solution of its nutritive constituents. Straw is somewhat more readily digested by the ruminants than by the horse. Straw, of different kinds, has about the following composition:—

	Barley- Straw.	Oat- Straw.	Pea- Straw.	Bean- Straw.
Water, . . . . .	14.3	14.3	14.3	17.3
Albuminous bodies,	3.0	2.5	6.5	10.2
Fats, . . . . .	1.4	2.0	2.0	1.0
Extractive matter and carbo- hydrates,	31.3	36.2	33.2	32.5
Cellulose,	43.0	40.0	40.0	34.0
Inorganic matter,	7.0	5.0	4.0	5.0
	100.0	100.0	100.0	100.0

Very frequently various forms of vegetable food will produce disturbances of digestion in the domestic animals from the mixing with them of various forms of adulteration, or from various defects in the character or quality of the food. The capability of recognizing this in a general way is, therefore, desirable. Thus, spoiled hay or hay, which has lost its inorganic constituents likewise loses its normal greenish color, and is of a dirty-gray or brown tint; while acid fermentation or putrefaction in all fodders may be recognized by the characteristic odor and taste. Good oats must be clean and composed of perfectly-formed mealy granules, and possess a certain definite specific gravity. Unripe or frozen oats have a less specific gravity and a less nutritive value, while spoiled oats are recognized by a musty smell and an unpleasant, burning taste. The quality of the hay will, of course, depend upon the quality of the ground and its botanical constituents, the time of cutting, and the mode of preservation. In order to judge of the quality and nutritive value of hay it may be divided into three different groups. In the first group are the sweet grasses (*gramineæ*); in the second, the acid

grasses; in the third, all other grasses. The richer the hay is in the sweet grasses, in clovers, and leguminous plants, the better it is. The richer it is in acid, marshy grasses, and the like, the poorer it is. Hay cut in summer is better and more nutritious than that cut in autumn, and so with second crop or after-cut. In the latter also the aromatic hay-odor is wanting. Hay which has been wet by the rain, so losing a large part of its inorganic matters, and that which has been kept for several years, has but little more nutritive worth than straw. Analysis has shown that clover and prairie hays which have been exposed to the rain for one or two weeks may lose as much as 12 per cent. of their nutritive matters. Hay which contains poisonous plants, mud, dust, or worms or caterpillars, or when it has become spoiled by putrefaction or fermentation, is likewise hurtful.

In the manufacture of various food-products residues are often left which may be of considerable nutritive value for our domestic animals. Such residues have a somewhat similar composition, usually, to that of the original parts of plants of which they are formed; the relative proportions of the different constituents will, however, vary, as more or less of certain substances are removed in the process of manufacture. Of the dry residues the various milled foods, such as meals and flours of the different cereals, are the most important. They contain usually 80 per cent. of solids. They are especially rich in albuminoids (over 20 per cent.) and fats (5.10 per cent.), and are, therefore, valuable adjuvants to foods which are poor in these nutritive principles.

The residue from beer-breweries (beer-mash, brewers' grains) is also a valuable food. It contains 20.25 per cent. of solids, composed largely of albuminoids, with a relatively small proportion of non-nitrogenous matters (1:2), somewhat more cellulose, and a considerable amount of fat and inorganic matter.

Chemical analysis of fresh brewers' grains shows the following average composition:—

Solids,	22 3 per cent.
Proteids,	4.6 “
Fats,	1.6 “
Non-nitrogenous extractives,	9.9 “
Cellulose,	5.0 “

Assuming that 73 per cent. of the proteids is digestible, fat 84 per cent., extractives 64 per cent., and cellulose 39 per cent., the average amounts of digestible matters may then be placed as follow:—

Proteids,	3.9 per cent.
Carbo-hydrates,	10.8 “
Fats,	0.8 “

The proportion of nutritive matter may thus be placed as 1:3.4.

The fresh residue from breweries contains a large percentage of

water, and therefore readily decomposes in summer in a few hours, and then is a very dangerous fodder. The only method of permanent preserving is by drying, and this necessitates a complicated and troublesome process. In cool weather the residue may be preserved for one or two weeks under fresh water. Fresh beer residue is an admirable fattening food for both cattle and hogs and for milk cows, though when sour it affects both the quantity and quality of the milk. When fresh this food is not so well suited for sheep and horses as when dried; in the latter condition, from the high percentage of nitrogenous constituents, it is comparable to the cereals.

The residue from distilleries, the so-called distillery mash or swill, forms a valuable article of fodder, but one whose composition is subject to the greatest variations, depending upon the character and mode of treatment of the substance manufactured. All such residues are, in their natural condition, very rich in water; and since in distillation only the starch and sugar serve for the production of the spirits, all the other nutritive substances remain, with slight alteration, in the residue; so that the solids of the latter are relatively very rich in nitrogen. Most of these residues in their fresh condition are readily devoured by the domestic animals, and their nutritive effect is increased by administering them warm and mixed with less nutritive substances, such as dry fodders rich in cellulose, which are less readily taken by cattle. On the other hand, their great richness in water is a disadvantage on account of the increased demand for nutritive substances so occasioned. The high percentage of water, soluble proteids, and other unstable substances in distillery residue leads to their ready decomposition, or souring, in which condition they are, of course, not suited for fodder, on account of the disturbances of digestion and alterations of milk which they produce; the objection to this class of foods is largely due to the danger of using a spoiled article. So also residues from which the spirit has not been entirely removed are likewise hurtful when given as food. The most common of these residues are those obtained from the distillation of potatoes, corn, rye, beets, and malt.

*Potato Residue.*—The residue from the distillation of potatoes will vary greatly in the percentage of nutritive constituents according to the more or less complete extraction of the spirit. The following table illustrates this:—

	Potato Residue.	By Hollefreund's Process.
Solids,	3.8-8.7 average 7.7	6.05 per cent.
Proteids,	0.8-1.9 " 1.1	1.14 "
Fats,	0.1-0.23 " 0.2	0.19 "
Non-nitrogenous extractive matters,	1.1-5.6 " 4.6	3.56 "
Cellulose,	0.5-1.4 " 0.9	0.69 "
Ash,	" 0.7	0.70 "



In the potato residue starch has been largely removed, while the other constituents remain but little unchanged, with the exception that the ferments are, of course, added to the residue, the proteids being to a certain extent changed into peptones. Potato residue is less nutritive than that from the cereals, and is, under all circumstances, unsuitable for constituting the sole article of diet; since it is not only too watery but too poor in inorganic materials, especially of phosphates,—an objection which does not apply to the same extent to the residue from the distillation of the cereals. Fresh potato residue, in which condition it should alone be used, seems to assist in the production of milk, especially when given warm, and may constitute one- or two-thirds of the total daily ration, the remainder being composed of dry fodder. Fattening sheep may receive from two to ten kilogrammes per one hundred kilogrammes of body weight, if given in too large amounts, seriously affecting the flesh of the animal. For horses potato residue is in general too watery, and only animals while at rest, or while doing light work, can stand it. In using this article of food care should be taken that the potatoes have not sprouted, otherwise they will contain solanine, and in consequence be poisonous.

*Corn Residue.*—The residue remaining after the distillation of corn is richer in both proteids and fats than that from potatoes. It contains—

	In a Fresh Condition.	Pressed.
Solids,	9.4 per cent.	28.4 per cent.
Proteids,	2.0 “	8.6 “
Fats,	1.0 “	3.2 “
Non-nitrogenous extractive matters,	4.9 “	12.7 “
Cellulose,	1.0 “	2.3 “
Ash,	0.4 “	1.5 “

The same statements apply for the administration of these substances as food as have already been made concerning the potato residue. Milk cattle cannot, however, receive more than thirty kilogrammes of this daily, since it will, in larger amounts, damage the character of the butter-fats; while they may receive as high as fifty kilogrammes daily of the potato residue.

*Rye Residue.*—The residue from the distillation of rye-whisky is, in consequence of the higher nitrogenous and lesser oily constituents of the rye-grains, richer in proteids and poorer in fats than the corn residue. It contains—

Solids,	9.9 per cent.
Proteids,	2.1 “
Fats,	0.6 “
Non-nitrogenous extractive matters,	5.9 “
Cellulose,	0.9 “
Ash,	0.5 “

This substance is one of the most useful of the various distillation residues, unless, as is often the case, the grain which has undergone the fermentation has contained the seeds of the *Agrostemma githago*, when it will possess poisonous properties.

*Beet Residue.*—The residue from beet distillation contains only 9 per cent. of solids, 0.9 per cent. proteids, 0.1 per cent. fats, 6.2 per cent. non-nitrogenous extractive matters, 1.2 per cent. cellulose, and 0.6 per cent. of ash. It is, therefore, the poorest in nutritive substances and the richest in water.

For preservation of the distillery residues, either they may be dried, especially when mixed with various forms of dry fodder, or they may in the fresh condition be preserved by the mixture of salicylic acid, one gramme for every fifty-four pounds. A process of preservation which is frequently employed depends upon the souring of the fresh residue in the formation of lactic acid fermentation,—a process which is accompanied by great loss of non-nitrogenous and proteid constituents. In spite, however, of this loss in nutritive constituents, this method furnishes a cheap and simple mode of preserving distillery residues.

The residue from the extraction of sugar from beets, from starch out of wheat and potatoes, and that remaining after the alcoholic fermentation of starchy and sugary substances, as in the distillation of spirits, are all valuable food-stuffs. All these substances contain but small amounts of solids, and the proportion of nitrogenous to non-nitrogenous matters is somewhat lower than in the raw material; but inorganic matters and fats are present in considerable amount and render them important accessory foods under certain circumstances.

The diffusion residue from the extraction of sugars from beet-roots furnishes a readily digestible form of food which is richer in water and poorer in inorganic constituents than the sugar-beets. It contains—

Solids, . . . . .	10.2 per cent.
Nitrogenous matters, . . . . .	0.9 “
Fats, . . . . .	0.05 “
Non-nitrogenous extractive matters, . . . . .	6.3 “
Cellulose, . . . . .	2.4 “
Ash, . . . . .	0.6 “

For cattle and hogs as much as one hundred kilogrammes per one thousand kilogrammes of body weight of this fresh residue may be given as food, only larger amounts may be given to animals which are desired to fatten rapidly. Larger quantities of this fodder alter both the character and quantity of the meat and the fat of animals and the character of the milk. For draught cattle it is unsuitable, as is also the case for sheep, with the exception of fattening sheep, which may stand it almost as well as cattle. Horses can only receive small amounts,—ten to twenty kilogrammes per thousand kilogrammes of body weight,—and then only

when not worked. This residue can only be given when in a perfectly fresh condition, or when well preserved.

The residue after the extraction of oil from the seeds of the various members of the cotton-plants (*Gossypium herbaceum*), or so-called cotton-seed cake, furnishes a valuable food for fattening and milk cattle. The seeds are inclosed in a capsule, which bursts as the fruit ripens, and which are covered by white fibres which form the so-called cotton. After the removal of the cotton, the seeds, which have a hard shell, contain an oily, greenish-white nucleus, from which the oil is removed by pressure. The residue from this process of extraction of the oil is by no means constant in its composition, and is therefore not always suitable for a food. For example, many of the cotton-seed cakes contain both parts of the indigestible hull of the seed and considerable cotton, and are therefore only suitable for manures. When such an article is given to cattle serious disturbance of digestion is produced, and may even prove fatal from obstruction and inflammation of the alimentary canal. In England the cake produced from the Egyptian seeds forms a favorite article of fodder. The most nutritious and most readily digestible are the cakes from the hulled seeds. The following table gives their composition:—

	Cotton- Seeds.	Oil-Cake from Unhulled Seeds.	Oil-Cake from Hulled Seeds.
Solids, .	91.1-92.3	85.8-93.4	85.7-92.3
Proteids,	22.7-22.8	18.0-28.3	19.7-49.2
Fats, .	29.3-30.3	4.8- 9.8	5.4-19.7
Non-nitrogenous extractive matters,	7.6-15.4	24.9-36.7	10.5-29.3
Cellulose,	16.0-24.7	17.0-27.0	3.5-11.4
Ash,	8.0	6.6	7.4

The oil-cake from the hulled seeds constitutes one of the most nutritious of all fodders. From digestion experiments on ruminants Wolff has found the following amounts to be digested:—

	Proteids.	Fats.	Non-nitrogenous Extractive Matters.
Hulled cakes, .	84.7	87.6	95.1
Unhulled cakes, .	73.4	90.8	46.2

The higher digestibility of the oil-cake from the hulled seeds is without doubt to be attributed to the large amount of cellulose in the hulls. The oil-cake from the unhulled seeds is of a dark-brown color, while that from the hulled seeds when fresh is greenish, but also becomes brownish with age. Both of these forms of fodder are often contaminated by the accidental mixture of various substances, such as particles of iron from the presses, and when kept in moist places with various forms of moulds which lead to the development of ptomaines and other poisonous alkaloids, and so may explain their hurtful action. The American cotton-seed

TABLE I.  
AVERAGE PERCENTAGE COMPOSITION OF THE ORDINARY FOODS.

FOODS.	According to Kühn.								According to Wolf.		
	Water.	Solids.	Organic Matter.	Nitrogenous Constituents.	Non-nitrogenous Constituents.	Fats.	Cellulose.	Ash.	Digestible Nitrogenous Constituents.	Digestible Non-nitrogenous Constituents.	Fat.
<i>I. Green Fodder.</i>											
Prairie grass, . . . . .	75.0	25.0	22.9	3.0	13.1	0.8	6.0	2.1	2.4	9.9	0.4
Red clover, . . . . .	80.2	19.8	18.4	3.6	8.5	0.7	5.6	1.4	1.7	8.7	0.4
White clover, . . . . .	80.2	19.8	18.45	4.0	8.0	0.85	5.6	1.4			
<i>II. Dry Fodder.</i>											
Prairie hay, . . . . .	14.3	85.7	79.2	9.5	40.3	2.3	27.1	6.5	5.4	41.0	1.0
Clover-hay, . . . . .	16.0	84.0	78.4	13.4	36.4	3.2	25.4	5.6	7.0	38.1	1.2
Oat-straw, . . . . .	14.3	85.7	81.3	4.0	35.6	2.0	39.7	4.4	1.4	40.1	0.7
Bean-straw, . . . . .	17.5	82.5	76.7	9.9	31.8	1.5	33.5	5.8	5.0	35.2	0.5
Wheat-straw, . . . . .	14.3	85.7	81.8	3.1	37.5	1.2	40.0	3.9			
Rye-straw, . . . . .	14.3	85.7	81.6	3.0	33.3	1.3	44.0	4.1			
Barley-straw, . . . . .	14.3	85.7	81.3	3.4	34.7	1.4	41.8	4.4			
<i>III. Roots and Bulbs.</i>											
Potatoes, . . . . .	75.0	25.0	24.1	2.0	20.7	0.3	1.1	0.9	1.2	21.8	0.3
Fodder-beets, . . . . .	88.0	12.0	11.2	1.1	9.1	0.1	0.9	0.8	0.5	10.6	0.1
<i>IV. Grains and Fruits.</i>											
Barley, . . . . .	13.8	86.2	84.0	11.2	65.5	2.1	5.2	2.2	8.0	58.9	1.7
Oats, . . . . .	13.7	86.3	83.6	12.0	56.6	6.0	9.0	2.7	9.0	43.3	4.0
Corn, . . . . .	12.7	87.3	85.6	10.6	65.7	6.5	2.8	1.7	8.4	60.6	4.8
Wheat, . . . . .	14.3	85.7	84.0	13.2	66.2	1.6	3.0	1.7			
Rice, . . . . .	13.7	86.3	86.0	7.8	74.5	0.2	3.5	0.3			
Peas, . . . . .	13.2	86.8	83.4	22.4	52.6	3.0	6.4	2.4			
Beans, . . . . .	14.1	85.9	82.8	25.1	46.7	1.6	9.4	3.1	23.0	50.2	1.4
<i>V. Food-Products.</i>											
Oat-meal, . . . . .	12.0	88.0	87.6	17.7	63.9	6.0					
Corn-meal, . . . . .	9.0	91.0	89.5	15.2	70.5	3.8		0.9			
Rye-meal, . . . . .	14.2	85.8	84.2	11.7	69.3	2.0	1.2	1.6	11.7	69.3	2.0
Rapeseed-cake, . . . . .	11.5	88.5	81.5	31.6	29.3	9.6	11.0	7.0	25.3	23.8	7.7
Wheat-bran, . . . . .	13.0	87.0	81.0	14.5	53.6	3.5	9.4	6.0	11.8	44.4	3.9
Malt, . . . . .	10.1	89.9	82.7	24.2	42.1	2.1	14.3	7.2	12.8	51.6	1.7
Brewers' grains, . . . . .	77.7	22.3	21.1	4.6	9.9	1.6	5.0	1.2	3.9	11.8	0.8
Potato-mash, . . . . .	92.3	7.7	7.1	1.4	4.6	0.2	0.9	0.6	1.0	4.0	0.1
<i>VI. Animal Foods.</i>											
Cows' milk, . . . . .	88.0	12.0	11.3	3.2	4.5	3.6		0.7	3.2	4.5	3.6
Skimmed cows' milk, . . . . .	90.0	10.0	9.2	3.5	5.0	0.7		0.8	3.5	5.0	0.7
Goats' milk, . . . . .	78.0	12.0	11.0	3.4	4.3	3.3		1.0			
Flesh, . . . . .	75.9	24.1	22.8	20.0	1.9	0.9		1.3			
Meat residue (from extracts), . . . . .	11.5	88.5	84.8	72.8		12.0		3.7	69.2		11.2

cake is of a bright-yellow color. If dark in color it has either been subjected to pressure while too hot, or has spoiled from being kept in too moist a place, and hence is of poor quality. In good condition it should have a pleasant, oily smell and a nutty taste, and should be hard and dry. When in good condition such a fodder is readily taken by domestic animals; although, especially if not perfectly fresh and of the first quality, the cattle must be gradually accustomed to it. Under all circumstances it is advisable to administer it dry, mixed up with other forms of fodder. In contact with hot fluids it develops an extremely unpleasant taste. To milk cattle from three to five pounds, to draught oxen three to four pounds, and to beeves six pounds for every thousand pounds of body weight may be given. Sheep and cattle may receive from one-half to one pound, and horses one to two pounds. An additional advantage of this substance as a fodder is its great cheapness.

The table on the preceding page gives, in the first eight columns, the percentage composition of the various forms of food-stuffs which may be employed for the nutrition of the herbivorous domestic animals. The last three columns give the average degree of digestibility of their organic constituents.

TABLE II.

## PERCENTAGE CONSTITUENTS OF SOLIDS IN ORDINARY FODDERS.

FOODS.	Nitrogenous Constituents.	Non-nitrogenous Extractive Matters.	Fats.	Cellulose.	Ash.
Prairie grass, . . . .	12.0	52.4	3.2	24.0	8.4
Red clover, . . . .	18.4	42.8	3.8	28.0	7.0
Prairie hay, . . . .	11.0	46.9	2.8	31.6	7.7
Clover-hay, . . . .	15.7	43.1	3.7	30.0	7.5
Oat-straw, . . . .	4.8	41.5	2.5	46.0	5.2
Bean-straw, . . . .	12.1	38.4	2.0	40.5	7.0
Potatoes, . . . .	8.0	82.8	1.2	4.4	3.6
Fodder-beets, . . . .	9.3	75.6	0.9	7.5	6.7
Barley, . . . .	13.0	76.0	2.4	6.1	2.5
Oats, . . . .	14.0	65.6	7.0	10.4	3.0
Corn, . . . .	12.1	75.0	7.5	3.4	2.0
Beans, . . . .	29.2	54.1	2.1	10.8	3.8
Rapeseed-cake, . . . .	35.7	33.2	10.8	12.4	7.9
Rye-meal, . . . .	13.7	80.5	2.4	1.5	1.9
Wheat-bran, . . . .	15.8	61.8	4.3	11.0	7.1
Malt, . . . .	27.0	46.8	2.3	15.9	8.0
Beer-mash (brewers' grains),	20.7	44.4	7.1	22.4	5.4
Potato-mash, . . . .	18.1	59.8	2.6	11.7	7.8
Fresh milk, . . . .	26.6	37.4	30.0		6.0
Skimmed milk, . . . .	35.0	50.0	7.0		8.0
Flesh, . . . .	83.0	7.8	3.8		5.4
Meat residue (from extracts),	82.2		13.6		4.2



The percentage of starch and sugars in fodders has been recently investigated by Mr. E. F. Ladd, and he gives the following tables as representing his results:—

No.	Substance.	Invert Sugar.	Sucrose.	Starch.	Per cent. of Nitrogen-free Extract as Sugars and Starch.
1.	Fodder-corn, . . .	9.00	0.40	13.87	53.48
2.	Corn-fodder, . . .	2.50	1.43	22.88	53.32
3.	Sorghum, . . .	17.60	3.40	12.19	64.21
4.	Alsike clover, . . .	. . .	. . .	74.63	33.81
5.	Red clover, average for 21, . . .	3.88	2.48	9.38	35.40
6.	Timothy, av. for 21, . . .	2.23	6.21	19.72	55.69
7.	Prickly comfrey, . . .	6.22	0.80	8.14	33.87
8.	Cactus, top, . . .	. . .	5.92	9.96	30.00
9.	Cactus, stump, . . .	2.80	3.60	17.10	41.12
10.	Meadow hay, . . .	. . .	. . .	24.32	49.32
11.	Wheat-straw, . . .	. . .	. . .	22.42	59.52
12.	Oat-straw, . . .	. . .	. . .	23.18	51.14
13.	Oats, . . .	. . .	. . .	53.20	81.05
14.	Wheat, . . .	1.64	2.36	57.91	76.37
15.	Wheat-flour, . . .	3.64	8.36	61.88	86.77
16.	Wheat-middlings, . . .	3.20	6.40	41.44	75.31
17.	Wheat-bran, . . .	1.60	4.40	45.60	83.53
18.	Ship-stuff, . . .	2.08	5.92	41.46	83.07

In red clover the following are the variations:—

Invert sugar,	from 5.20 per cent. to 2.60 per cent.
Sucrose,	“ 3.80 “ 1.20 “
Starch,	“ 13.90 “ 5.58 “

For timothy the following represent the highest and lowest percentages:—

Invert sugar,	from 5.00 per cent. to 2.40 per cent.
Sucrose,	“ 7.60 “ 4.68 “
Starch,	“ 22.61 “ 17.55 “

The percentage of sugars and starch in timothy varies according as the estimations are made: while in full bloom or after the seeds are formed, but before they are fully matured. This is shown in the following table:—

	Invert Sugar.	Sucrose.	Starch.	Per cent. of Nitrogen-free Extract as Sugar and Starch.
Early-cut, . . .	3.72	5.96	18.07	52.73
Late-cut, . . .	2.32	5.40	21.66	60.24

It thus would appear that as hays approach ripeness the per cent. of sugar is diminished, while the starch is increased. Mr. Ladd was unable to trace any relation between the per cent. of sugars and starch and the kind of fertilizer applied to the soil, and was unable to confirm the usual statement that a potash dressing increased the starch-contents of the timothy.

## II. ANIMAL FOODS.

The most important of the foods of animal origin are milk and animal flesh, or meat.

1. MILK will be considered more at length under the Secretions, details being given as to the composition and characteristics of the milk of different animals. It is at present only necessary to refer in outline to its composition to indicate in a general way its nutritive value. Milk contains an average, in 100 parts, of 85.7 parts water, 5.4 parts of albuminous bodies, 4.3 parts of fats, 4 parts of sugar, and 0.6 parts of inorganic salts. Of the inorganic salts, potassium phosphate, calcium phosphate, and potassium chloride are in greatest abundance, while sodium chloride is in smaller amount; iron has also been found to be present. Milk, therefore, contains examples of all the different nutritive principles, proteids, carbo-hydrates, fats, and salts, and these arranged in the proportion which is best suited for nutritive purposes. All mammals, in the earliest period of their extra-uterine life, are nourished solely on milk, and their rapid growth and development in this period is without doubt largely dependent upon the manner in which the different food-principles are combined in milk. Milk, therefore, may be regarded as a typical food. Buttermilk is the name which is given to the fluid which remains after the fats have been removed by churning. It is less nutritious than milk to the extent to which the fats have been removed, but, all the other principles remaining, it may serve useful nutritive purposes. It has an acid reaction, from the fermentation of the milk-sugar into lactic acid. Cheese consists of the casein and fats, the casein being coagulated, either through the spontaneous development of acidity, when it is termed a curd, or by the addition of the milk-curdling ferment from the stomach of the calf. It therefore consists principally of albuminous bodies and fats, the whey, in which the salts and sugar remain dissolved, being largely forced out by pressure. It is hence well suited to form an addition to foods which are poor in albuminoids and fats, as in certain vegetables, such as potatoes and rice. The whey of milk contains the sugar and lactic acid, which is developed from the fermentation of the sugar, salts, and a certain amount of milk-albumen. It also has considerable nutritive value, and seems especially to stimulate intestinal peristalsis, and therefore to be, to a certain extent, laxative.

2. MEAT.—Next in value to milk as food comes the flesh of animals. The nutritive principles of meat are contained within the muscle-fibre; the juice obtained by subjecting muscle to pressure contains myosin and ordinary albumen, inosite or muscle-sugar, and glycogen, as representatives of the carbo-hydrate group, while within the connective tissue



around the muscular fibres fat is nearly always to be found. Meat, therefore, also contains members of the proteid group, carbo-hydrate and fatty food-stuffs, together with a considerable amount of inorganic salts. Hence, meat is also an excellent food. Albuminous bodies are in greatest amount; then come the fats, then the carbo-hydrates, and finally the different salts. Ordinarily lean meat may be said to contain an average of 73.5 per cent. of water, 26.5 per cent. of solids (of which 21 per cent. is albuminous and 1.5 per cent. gelatinous, 1.5 per cent. fats, 1 per cent. carbo-hydrates, and 1 per cent. inorganic salts). Of the latter, three-fourths consist of acid phosphate of potassium, one-seventh of earthy phosphates and iron, and about one-fifteenth of potassium chloride. The flesh of different animals differs in composition, as is shown by the following table:—

In 100 parts Flesh.	Ox.	Calf.	Pig.	Horse.	Chicken.	Fish (Pike).
Water,	76.7	75.6	72.6	74.3	70.8	79.3
Solids,	23.3	24.4	27.4	25.7	29.2	20.7
Albuminous bodies,	20.0	19.4	19.9	21.7	22.7	18.3
Fats,	1.5	2.9	6.2	2.5	4.1	0.7
Carbo-hydrates,	0.6	0.8	0.6	0.6	1.3	0.9
Salts,	1.2	1.3	1.1	1.0	1.1	0.8

It is thus seen that meat is especially distinguished by its high albuminoid constituents, which amount to four times that contained in milk. Chicken-flesh and that of other birds is richer in albuminoids than that of mammals, while the flesh of fish is poorer, though even here 18 per cent. of albuminous bodies is present. Meat alone forms the food of the carnivora only, and, as we shall find that carbo-hydrates may be developed from the decomposition of albuminoids, carnivorous animals will, therefore, require an immense amount of albuminous bodies, and therefore a very great volume of meat. If carbo-hydrates are added to the meat diet of the carnivorous animals the volume of the latter may be very considerably reduced and still the animal preserve its nutritive equilibrium. In a diet of raw meat animals always run a risk of taking entozoa or parasites, such as trichina, into their interior. The preparation of meat by prolonged boiling destroys all the parasites, and therefore serves to render even infected meat harmless. When meat is placed in cold water the inorganic salts and a certain part of the albuminous bodies (about 3 per cent.), together with the so-called extractives of meat, such as kreatin, xanthin, and hippoxanthin, pass into solution along with small amounts of lactic acid. When the water is warmed up to 45° C. a certain amount of soluble albuminoids undergo coagulation and form coaguli, which float on the surface of the water. As the temperature of the water is increased the external surfaces of the meat first undergo coagulation, and so prevent further escape of the muscle-juices. Meat which has been subjected to prolonged boiling thus preserves a

considerable nutritive value, since it contains still 16 or 18 per cent. of the albuminous bodies and a small quantity of nutritive salts, and is readily digestible in the alimentary canal. If meat is placed in water which is already boiling the external surfaces are at once coagulated and but little of the nutritive juices escape, so that, therefore, meat so prepared has a greater nutritive value than meat which is placed in cold water and then gradually subjected to boiling. The more rapidly, therefore, the external surfaces of the meat are coagulated, as, for example, by roasting, the greater will be the proportion of nutritive substances retained. In roasting the hæmoglobin of the blood becomes decomposed, and the meat then takes the characteristic brown color of roast meat, while at the same time a number of aromatic substances, to which the peculiar odor and taste of roast meat are due, are developed. By soaking meat in brine putrefaction is prevented, but meat so salted loses a certain degree of nutritive value from the fact that a considerable quantity of albuminous bodies and extractive matters and salts pass into the pickling solution. Smoked beef is protected from decomposition by the development of phenol in the smoke; this substance is an energetic preventive of decomposition. Beef so dried preserves nearly all of its nutritive principles, only having lost in water. Meat-broth obtained by boiling meat with water has usually an acid reaction, from the lactic acid of meat, and contains a greater part of salts and extractive matters of meat, together with a certain amount of gelatinous albuminoids and a small amount of fat. Meat-broth will contain about 1.4 per cent. of solids, but is of slight nutritive value, since it contains scarcely any albuminoids or carbohydrates, and but an extremely small amount of fats. It consists almost solely of the extractive matters and salts, and is, therefore, simply of value as a means of supplying the inorganic salts of meat. From the extractive matters and the potassium salts present it is to a certain extent a stimulant, since it simply in this way produces a greater secretion of digestive juices. Beef-tea, prepared by putting meat in cold water and gradually raising the temperature, has a higher nutritive value than the commercial beef extracts from the fact that the soluble albuminoids have time to pass into solution in the water before their temperature of coagulation has been reached. The composition of meat will be given in greater extent under the subject of Muscles.

Eggs, especially those of the hen, are also valuable nutritive articles, containing also examples of all the different food-stuffs; thus, one hundred parts of egg, the shells having been removed, consist of 73.9 per cent. water and 26.1 per cent. solids. Of the latter 14 per cent. is albuminoid, 10.8 per cent. fat, a small amount of sugar, and 1 per cent. of inorganic salts, especially sodium chloride, potassium phosphate, and a small amount of oxide of iron.

Eggs are also frequently used as food for calves and stallions when rubbed up with the shells. To fattening calves three eggs may be administered daily, rubbed up, shells and all, with their daily supply of milk, and serve to give an especially pleasant flavor to their flesh. For stallions, ten to fifteen eggs may be given with their usual food.

### III. INORGANIC FOODS.

By inorganic foods are meant those inorganic compounds which are found in the different tissues, secretions, and excretions of the organism, which, being essential to the vital processes of the organism and being continually removed, must be constantly replaced. Inorganic substances are indispensable to a proper nourishment of animals, but they are not usually taken in their simple form, but as constituents of animal or vegetable matter, or in the fluids which are drunk. Of the inorganic foods, water, common salt, salts of lime and potassium, and iron are indispensable, as they are the necessary constituents of the blood, lymph, bones, and different tissues, and are continually being removed in the nutritive processes of the economy.

1. WATER.—Water, as an alimentary principle, is taken into the system, either alone as a drink, or in combination with articles of food; in both of which cases it is also associated with a certain amount of inorganic salts, as animals, unless pressed by great thirst, will refuse to drink distilled water. For certain animals, such as rabbits and kangaroos, which seldom or never apparently drink water, enough fluid for their needs is contained in the succulent vegetables which serve as their food; for if rabbits, for example, are fed on dry food, such as bran, they will then require water, and will drink it like other animals. So also sheep, which, as a rule, require but small amounts of water because of the succulent character of their food, if in dry localities, or if they are fed on dry food, will also hunt for water, like other animals susceptible of thirst. Water not only carries into the system materials capable of solution, but it holds matters in suspension which in some cases may be nutritious, in others poisonous. The purest water is not necessarily the best for animals or man, nor is dirty water necessarily injurious. Drinking-water must possess certain qualities. It must be fresh, clear, without odor, and of a certain taste. It should always contain gases and mineral matter in solution, but be free from organic substances. The presence of the latter, which are always injurious, may be recognized by the addition of a small amount of potassium permanganate solution to the suspected water, when, if organic substances are present, the bright-purple solution will become a dirty brown. Drinkable water should contain from 20 to 30 per cent. of its volume of air in

solution. It also should contain a considerable amount of carbon dioxide, to which the flavor of water is due. The dispersion of these gases by boiling gives to water a flat and disagreeable taste. The inorganic salts held in solution in natural waters may vary within very wide limits, both as to their nature and quantity; ordinary drinkable water contains about twenty-five to one hundred centigrammes of solid residue per liter. Of this, carbonates, sulphates, alkalies, chlorides, and earthy matters are the most constant constituents, although various other substances, such as sulphur, iron, and lime, are contained in waters of different localities, forming the so-called mineral-spring waters, whose composition is subject to the very greatest variation.

2. NUTRITIVE SALTS.—Of the salts which are essential for the nutrition of animals the most important is sodium chloride. This substance enters largely into the composition of all animal tissues and fluids, and when not supplied in proper amount produces great disturbances of nutrition, and a morbid craving for it has often been noticed. The effects of the deprivation of salts, or the so-called salt hunger, will be alluded to under the subject of Nutrition. Even the administration of an extra ration of salt is sometimes of advantage; thus, the experiment has been made of feeding two bullocks on food which in one case contained a daily ration of five hundred grains of salt, while no salt was supplied to the other. For five months no very evident results appeared; but changes then commenced which were very marked, even to the unpracticed eye. In the bullock to which the salt had been supplied the hair was smooth and glistening, and in the other rough and tarnished. This distribution of salt in the diet was continued for a year, when the animal which had been kept without salt had a rough and tangled hide, with patches where the skin was entirely bare, while the other, to whom five hundred grains of salt had been supplied daily, had all the appearance of a healthy, stall-fed animal, was much more vivacious, and would have brought a much higher price in the market.

In addition to sodium chloride, phosphates, carbo-hydrates, and sulphates are also of great nutritive value, and are required for the maintenance of a proper nutritive condition of the animal. Carnivorous animals receive a proper supply of phosphates in the animal foods, especially in bones, whereas the herbivora derive them from the grasses on which they feed. Phosphatic manures owe their value largely to the contribution of phosphates which they make to the soil, and hence to the grasses grown on them. The lime salts, as has been already indicated, are essential for the development of the solidity of bones, and when reduced in amount lead to various deformities of the bony skeleton. Even suckling animals receive in the milk of their mothers when normal a sufficiency of these inorganic matters; thus, a suckling

calf receives daily fifty-two grammes of inorganic matter in the milk of the mother, and a calf six months old appropriates in its fodder an amount of phosphoric acid corresponding to thirty-six grammes of calcium phosphate; while a horse fed on hay and oats receives daily about one hundred and sixty-eight grammes of calcium phosphate. Occasionally animals are seen to eat earth. This, with the exception in the case of birds, where gravel is required to assist in the comminution of the food in the gizzard, is to be explained by the insufficiency of inorganic matter in the food. Thus, the earth-eating Indians in South America are said to consume earthy matters from the fact that their corn is poor in salts.

#### IV. THE DIET OF ANIMALS.

The complexity of food-stuffs is essential to the sustenance of the organism. The food must contain albuminoids for the reconstruction of the tissues, carbo-hydrates and fats for calorification and the formation of adipose tissue, and the saline matters for the different secretions and tissues. If any one of these food-constituents is not represented in the diet, the food, even although in excessive amount, will be incapable of preserving health. Experimentation has proved that single alimentary principles will not sustain life. Magendie showed long ago that dogs fed exclusively on non-nitrogenous substances, such as sugar, gum, olive oil or butter, in a short time died of marasmus, the appetite soon being lost, ulcerations forming on the cornea, and death occurring with all the symptoms of starvation after about four weeks. After death all fat was found to have disappeared from the body; the muscles were atrophied; the urine alkaline and deprived of uric acid and phosphates, so as to resemble the urine of herbivora. Similar results were obtained whether the animals were fed with oil, with gum, or with sugar alone. Any one of these substances was found to be incapable of sustaining life. Objection might naturally be urged against these experiments that the dog being a carnivorous animal, a diet of non-nitrogenous food was not adapted to his nutritive needs; but the repetition of Magendie's experiments by Tiedemann and Gmelin with the goose, by feeding on gum arabic and water, sugar and water, and raw or uncooked starch, overcomes the force of this argument. In all cases death occurred in from two to three weeks with all the symptoms of starvation, even though the examination of the excreta proved that the substances given had been digested. In all cases the appetite gradually failed, diarrhœa set in, and death occurred from exhaustion and starvation. It thus seems clear that, even though digested, a non-nitrogenous diet alone will not sustain life, either in the carnivora or in the herbivora. A similar state of affairs holds for

nitrogenous diet. Dogs fed exclusively on gelatin soon refuse to take it, and die of hunger. Fibrin alone will also not sustain life, death occurring on the fortieth to the eightieth day, while albumen, whether raw or cooked, if given alone, has been found to be incapable of sustaining life even as long as fibrin. Gluten alone has been found capable of sustaining life, probably because it is not a pure nitrogenous matter and always contains starch, vegetable albuminoids, and salts; so that, therefore, the experiments made with gluten, in which nutrition seemed to be tolerably well preserved, will not disprove the general statement that single nutritive principles are not capable of sustaining life. Finally, again, a mixture of nitrogenous matters, such as fibrin, albumen, and gelatin, although more nutritious than when any one of these is given alone, is always incapable of supporting life for more than about four months.

These results show that a simple, easily-digestible substance, whether nitrogenous or non-nitrogenous, alone is incapable of supporting life. An aliment must contain the four groups of nutritive principles given above. Blood, meat, grasses, and grains are aliments, any one of which, when taken alone, will sustain life. Thus, milk contains casein, an albuminoid, together with albuminous bodies allied to serum-albumen, which supply nitrogenous elements necessary for tissue development. It contains sugar and fats for producing heat, and it contains salts in amounts required for the development of all the tissues. Hay, again, and grasses always contain a mixture of several kinds of plants, their stems, leaves, and seeds always containing vegetable albuminous matters, sugar, starch, mineral salts and fats. Observation has, however, shown that the association of different alimentary substances already complex is favorable to nutrition, not only by the different degrees of stimulation which they exert on the different portions of the digestive tract, but by the variety of nutritive matters which they render for absorption. A number of apparent exceptions seem to offer themselves to the truth of this statement; thus, where we find birds feeding almost solely on a single article of food, and always maintaining a high state of nutrition; and yet it only requires a little reflection to show that such foods are invariably themselves highly complex, and contain within them examples of all the different food-stuffs. So, also, the larger ruminants will thrive on a prolonged diet of any one single food; and yet here, also, the only foods on which nutrition may be so preserved must be those which contain examples of all the different food-principles.

It is not only necessary that an aliment should contain all the different food-principles, but that they should be present in considerable quantities and in definite proportions; otherwise nutritive equilibrium will be destroyed. The essential relations between the relative proportions of

these different food-stuffs will be discussed when we consider the nutritive value of foods.

We may, however, here call attention to the fact that in an animal in whom no excessive demands for work are made a proportion of one part of nitrogenous to eight of non-nitrogenous food-stuffs will be sufficient to maintain the body weight. When, however, the animal is worked, then the proportion between nitrogenous and non-nitrogenous food must be increased from 1:5 to 1:3. The following table, after Liebig, shows the proportion of nitrogenous to non-nitrogenous principles in some of the most common foods:—

Cows' milk,	1 : 2 to 1 : 4
Beans and peas,	1 : 2
Ox-flesh,	1 : 1.7
Pigs' flesh,	1 : 3
Calves' flesh,	1 : 1
Potatoes,	1 : 10
Oatmeal,	1 : 5
Wheat-flour,	1 : 4.6
Rye- and barley-meal,	1 : 5.7

The aliment which is well adapted to nourish one species of animal is not necessarily suitable for another. Thus, a vegetable food which furnishes the maximum of its nutritive principles to a ruminant, which is capable of perfectly dividing it and retaining it for a long time in its complicated gastro-intestinal apparatus, will be of little value to such an animal as a horse for the directly opposite reasons. Further, the food which may be nutritive for an animal with a perfect masticatory apparatus will be useless to one in whom the teeth have not appeared or have been lost; or it may serve for a beast of burden which has need of blood and tissue producers, and not for a fattening animal, or a cow kept entirely for milking. The alimentary ration must correspond to the losses of the organism, and must, therefore, be proportionate to the work done and the animal's size; thus, a man under ordinary circumstances requires 20 grammes of nitrogen and 330 grammes of carbon daily, represented by 1000 grammes of bread and 286 grammes of meat. The horse needs 7500 grammes of hay and 2270 grammes of oats, representing 10 kilo of hay and 2 kilo of oats for every 100 kilo of body weight. Loss of weight occurs if this daily ration is reduced only one-tenth. For the dog 40 grammes of meat are necessary for each kilo of body weight, and here also the animals lose flesh if these rations are decreased only one-tenth. If the bodily losses are increased by work or by the secretion of milk, or if the animal is in the growing period, when the size and weight of the body should increase, it is also indispensable that these rations should increase. In cases where extraordinary demands are made on the forces of the animal, as in beasts of burden, the supplementary foods are then to be given in small volume, and should then be of extremely nutritive

nature in concentrated form, so as not to tax the digestive organs. Thus, for workingmen meat should represent the accessory rations; for horses oats is the suitable form. For if the extra food is given to the horse in grasses it becomes impossible to work him because of the overdistension of the alimentary canal necessitated by the greatly increased volume of food required. Again, in fattening animals or in animals kept for milking purposes the diet must be rich in albumen, in fats and carbo-hydrates. Equivalent values of different amounts of different foods cannot be determined by chemical analysis alone, as will be shown when the nutritive values of the different foods are considered. That two foods should have the same nutritive value they should contain equal proportions of nitrogenous matters, carbo-hydrates, salts, etc., in equal volumes. They should possess equal stimulating properties to the digestive tract, and should be of equal digestibility. It is a general rule that animal matters are more nutritive than vegetable matters, bulk for bulk. They are, further, more varied in composition, and are more readily assimilated.

The mode of diet suitable for different animals, the character of their food and its nature, varies very widely in different classes of animals, whether carnivorous, herbivorous, or omnivorous. Each of these classes has a special mode of alimentation, as especially emphasized by Colin, which is governed by the characteristics of its digestive organs. In each of these three groups of animals a number of subdivisions may be established. Thus, among the carnivora there are animals which only eat living prey; others, only decomposing animal matter; others, again, only insects.

Among the herbivora, some only eat grasses; others, only grains; others, roots and leaves, etc. The mode of alimentation suitable to each of these species is closely dependent upon the digestive organs of each, and governs its habits, instincts, and characters, and is dependent largely upon the modes which it possesses of attack and defense.

The *carnivora*, especially those belonging to the group of mammals, have a strikingly characteristic organization. Their incisor teeth are cutting, their canine teeth long and pointed, as are also the cusps of their molar teeth. Their jaws are short; their masseter and temporal muscles enormously developed, lodged in deep temporal fossæ, and attached to highly-curved zygomatic arches; their œsophagus dilatable; their stomachs large; their intestines short and simple, and their cæca small or absent. Their feet are divided and furnished with more or less pointed claws. They are admirably organized for the discovery of their prey by acute sight or acute sense of smell or hearing; their agility or cunning enables them to surprise and seize their prey, and their strength to tear it to pieces; while their jaws are powerful enough to crush the bones, and their gastric juices powerful enough to dissolve them. Such animals



are the lion, the tiger, the jaguar, and all cats. The carnivora which feed on living prey are always ferocious. Those which feed on dead animal matter are usually cowardly, as the vulture, hyena, jackal, etc. As a rule, they seek their prey alone and seldom hunt in flocks or herds. They differ in their manner of searching for food. Some lie in wait for their food and surprise it, others chase it; some feed almost solely on fish, others on mammals. The general rule, however, holds that animals seldom, if ever, feed on their own species. Carnivorous animals invariably devour the herbivorous. There are, however, many exceptions to this; thus, swans have been said to eat their own kind; ducks and ravens are said to have eaten birds of their own species; while it seems well established that wolves and rats both destroy each other for food; so, also, the sow has been known to eat her young; but all these are merely exceptions to the general rule that animals, even when pressed by the most extreme hunger, refuse to devour flesh of their own species. These animals differ greatly in their mode of devouring their food. Some consume their prey when freshly killed; others simply consume the blood; some wait until decomposition has commenced; while many bury the remains, to wait until again pressed by hunger.

Among carnivorous birds we always find a mode of prehension of food suitable to the character of their diet. Insect-eating birds have, as a rule, long, narrow beaks, with prehensile tongues. Fish-eating birds have beaks which enable them to seize and consume their prey.

*Herbivora* are of a very different organism from carnivora. Their molars are flat, or have tuberculated crowns; their jaws are longer, more slender, and less strong; their stomachs are always more ample from the fact that in vegetable food the nutritive principles are in less relative bulk than in animal food; their intestines are larger, longer, and more complicated, and often have special diverticulæ for the retention of food; their senses are not as delicate as those of the carnivora. They, as a rule, want means of aggression, while the instincts, courage, and cunning of the carnivora are absent. While many of them are provided with defensive organs, as a rule they depend upon their speed for their protection.

Herbivorous animals are divided into the grass-eaters, the *herbivora* proper; the *granivora*, or seed-eaters; the *fructivora*, or those which feed on fruits. Of the large herbivora, the solipedes, of which the horse and ass are examples, and the ruminants, are the most prominent examples. In the savage state they live exclusively on herbs and leaves, and never eat roots or fruits. Others, such as the hippopotamus, rhinoceros, and the elephant, prefer roots, but eat leaves and herbs, and in the domestic state all may live on dry forage. Others belonging to this same group, such as the castor and beaver, and the rodents generally, will eat the bark

of trees. All the herbivora are possessed of instincts which enable them to select the vegetable foods which are most suitable for them, and will reject others. Thus, it has been found, as mentioned by Colin, who has made a close study of this subject, and to whom the author is largely indebted, that a horse will eat 262 different kinds of plants, and has been seen to reject 212; the ox will eat 275 and refuse 218; the sheep will eat 387 and refuse 141; the hare will eat 449 and refuse 125; and the pig, which is omnivorous, and yet which can be sustained by vegetable food, has been found to devour 172 different kinds of vegetable matter and reject 171. Different circumstances, such as changing seasons or migration from different localities, may compel them to feed on plants which are otherwise ordinarily refused. Their instinct leads them, further, to avoid venomous plants when mixed with other plants, or unless greatly pressed by hunger. Different plants are poisonous articles of food to some animals, while other plants are poisonous to others. Here it is only necessary to mention that the ox and rabbit may eat belladonna with impunity, the goat hemlock, the horse aconite, while goats and sheep avoid most of the solanaceæ.

The *omnivora* are permitted, by their organization and instinct, to devour both kinds of food, and, as a consequence, their habits are not so sharply characterized as either of the two above-mentioned groups. They may live either on exclusively animal or exclusively vegetable diet, according to circumstances. The pig, the rat, gallinaceous fowls, flat-footed birds, the raven and crow are all omnivorous. Many animals placed among this species from the characteristics of their organization apparently belong to the carnivora, such as the bear, the fox, and dog; and these animals are also omnivorous, although to a less-marked degree than the preceding examples. The hog and wild boar live on roots, insects, and reptiles. Rats and mice, strictly speaking, are omnivorous, since they devour everything that comes within their reach.

The duck, which ordinarily seeks aquatic regions, where it can feed on tender vegetable shoots and small aquatic animals and insects, may also be brought to live on a purely vegetable or even a purely animal diet. Also, the fox will live on fruits when animal food is not accessible. Bears, while distinctly carnivorous in their type of organization, are also omnivorous animals, and will often live exclusively on roots, honey, etc. So the sea-otter may be brought to live on vegetable matter when fish cannot be obtained. The dog, again, is strictly carnivorous in its organization, and yet can live on purely vegetable matter, and in its state of domestication this diet seems to suit him best. A great number of animals belonging to these species have distinct tastes for certain mineral substances, especially common salt; and this is, above all, marked in the herbivora, which perish when deprived of salt, and, as is well known, will

seek salt, and congregate at certain periods of the day at points where salt is to be found, and will eat earth when sodium chloride is not to be obtained. This, as already mentioned, is to be explained by the fact that vegetable matters are poor in sodium salts and rich in potassium salts. So, also, the granivorous birds will devour gravel, stones, and sand from an instinct which leads to their taking such substances into their gizzard to enable them to properly triturate their food; for, in the granivorous birds, the nutritive principles of the seeds are inclosed within dense membranes. They are not provided with teeth for the mastication of food, and, were no means supplied for crushing or triturating their food, would starve to death with their stomachs full of the most nutritious seeds.

The diet most in harmony with the organism, teeth, alimentary canal, etc., of animals may be modified if the force required of animals is increased artificially. Thus, the horse in a state of nature is never granivorous or fructivorous, but only eats herbs; when in the service of man grains are necessary to reduce the bulk of food, for horses cannot work if their stomach or alimentary canal is distended with forage. By the administration of oats the duration of the feeding time and of the period of digestion is reduced. There is economy of the digestive secretions, the stomach is much less distended, and there is less time required for digestion; hence, herbivorous animals in domestication become largely granivorous, and oats form a large portion of their food, for oats are always nutritious in small bulk and readily digested. They contain all the food-elements in suitable proportions; the large amount of nitrogen which they contain render them particularly suitable for repairing waste in the muscular system, especially when work is demanded of them. Oats nourish, therefore, without fattening. Since the process of digestion in the herbivora and carnivora, and the ultimate nature of their food-stuffs is identical, it is natural to suppose that their nutritive habits may be changed; thus, the herbivora may be brought to feed on animal matter, while the carnivora may be led to feed on matters of purely vegetable origin. Numerous facts of this kind have been over and over again reported. The most striking of all is seen in the results of the domestication of the common cat. Here a typical carnivorous animal by education and habit becomes almost herbivorous. So, also, pigeons have been accustomed to eat meat to such a point that they will afterward refuse seeds. In Iceland, where vegetation is sparse, the native horses and oxen have been seen to feed upon fish, and it is even stated that they have been seen to enter the water and fish for themselves. The starting point of this change from the herbivorous into the carnivorous type is found in the fact that all animals after their birth are carnivorous; for in suckling animals there is but little if any difference in their

organism from that of the carnivora. Even in such a typical group of herbivorous animals as the ruminants we find that in them, when newborn, the complex stomach is rudimentary and their alimentary canal differs but little from that of the carnivora, simply foreshadowing what will ultimately be developed when the animals are placed upon a purely herbivorous diet. Among the carnivora the most typical examples will sometimes refuse vegetable nourishment, and the tiger and lion and the eagle have been known to die of starvation rather than touch it; nevertheless, an eagle has been educated to eat and digest bread. The native repugnance to certain foods is often overcome by cooking, and it is without doubt to this circumstance that man is omnivorous in character. Thus, dogs and cats do not eat corn, but they will eat bread. This is, however, in all probability to be explained by the fact that the uncrushed seeds are incapable of digestion by carnivorous animals, since their organs of mastication do not permit of the liberation of the nutritive principles from their undigestible envelopes. Cooking, nevertheless, does lead many animals to eat food which is unnatural to their species; thus, the rabbit will refuse raw meat, but will often willingly accept and digest boiled meat. Certain animals are both carnivorous and herbivorous. This is especially illustrated among the birds, where some are frugivorous in winter and insectivorous in summer; so the small frugivorous monkey will eat insects and seek for eggs and little birds scarcely hatched. Even in the same groups of animals some are carnivorous and some herbivorous; thus, among plantigrades and the cetaceans we have examples of each. It is worthy of notice, however, that when forcing the diet is arrested and animals are restored to their native state, they will again return to their natural food. The herbivora forming the food of the carnivora, and feeding themselves on vegetable matters for the maintenance of their species, must consequently be in excess of the carnivora.

We thus see that the choice of food is controlled by the animal's habits and appetites. Herbivorous quadrupeds graze and consume grasses, bulbs, and grains suitable to the organs of their digestive apparatus, while the carnivora devour the flesh of the herbivora, and show aversion to the carcasses of animals allied to themselves in their habits. An artificial mode of existence forces on animals predilections which in a state of nature are not observed. In nature they are essentially moderate in their desires, but when domesticated will eat what they would in a state of nature avoid, and never appear to be satisfied, devouring much more than when in the field, filling themselves to repletion. In their natural state the exercise connected with the selection of food is of great importance to the health of the herbivora. They cannot fast long, like the carnivora, nor can they in a single meal consume enough to enable them to pass hours or days in a state of torpor

with a distended alimentary canal before again called upon by the demands of hunger. The domestic animals will sometimes kill themselves by overeating when food is continually placed before them, but that is only when they are from their surrounding circumstances relieved from traveling for food and water; where their time is not, therefore, largely occupied in exercise and in watching for disturbing causes. So, if treated artificially, animals should be managed according to their habits. The collection of food further varies in our different domestic animals: one bolts flesh and coarsely-ground bones, to be deposited in a capacious stomach; another rapidly swallows large volumes of food and lodges it for awhile in a crop or paunch, to be again regurgitated and masticated at leisure. The fowl crushes its food beyond the crop or stomach in the gizzard. The ox swallows large volumes of food which have been subjected to scarcely any mastication, to return them at leisure to the mouth to be remasticated. The horse collects and at once thoroughly grinds and mixes food with saliva, and rapidly passes it from its stomach to its intestines without the functions of rumination. Habit, therefore, materially influences the collection of food, its retention, and appropriation to the wants of the animal, and is itself governed by the type of the organization of the digestive tract (Gamage).

On the basis of the above considerations we may indicate in a general way the fundamental principles which must underlie a rational system of feeding. In the first place, it is evident that the daily ration must be appropriate to the normal mode of feeding and digestive peculiarities of the species; further, the digestive power in different animals varies not only in different species for the same food, but it varies in different individuals of the same species of different ages. The capacity of the stomach must be considered, that the appetite may be satisfied without the stomach being overloaded. Experiment has proved that the solipedes should receive daily 2 per cent. of their body weight in solids, and ruminants  $2\frac{1}{2}$  per cent. of their weight.

In the second place, the food must be adjusted with special reference to the demands which are made upon the animal economy, whether for work, fat, or milk production. Special directions for so adjusting the rations will be given after the composition of the food-stuffs and the nutritive changes occurring in different animals in various conditions have been considered. It may be here mentioned, however, that good hay is taken as the type of a food for the larger herbivora, and that it shows a nutritive proportion of one part of nitrogenous matter to 4.8 parts of non-nitrogenous constituents, cellulose being disregarded. This proportion, therefore, represents the normal relation between the nitrogenous and non-nitrogenous matters in the natural diet of the herbivora; and although this proportion under certain circumstances may be widened

to 1:8 or contracted to 1:4, the digestibility, and therefore the nutritive value, of the fodder is interfered with if these limits be passed.

In the case of hay, again, the amount of fatty constituents is to the nitrogenous matters as 1:3.7. If this proportion be contracted to 1:2.2 the horse will still be able to accomplish its normal amounts of work; but if reduced below this for the horse, or below 1:3 for the ox, the full nutritive value of the food will not be appropriated. These figures, of course, refer to the digestible percentages of the fodders, and by referring to the tables of the composition of the different food-stuffs, which will be subsequently given, it will be found possible to construct dietary tables according to the demands on the animal economy.

It may thus be added to the general statements which have been made in the early parts of this section that not only must all animals receive representatives of the different food-constituents, but that the herbivora must not receive more than eight or less than four parts of non-nitrogenous matter to one of proteid, and not less than two parts of proteid to one of fat.

## SECTION II.

### DIGESTION.

#### I. GENERAL CHARACTERISTICS OF THE DIGESTIVE APPARATUS.

DIGESTION is the preparation of food for absorption, and is usually accomplished by the introduction of the food into a special cavity communicating with the exterior, where it undergoes such changes as will enable it to pass through the walls of the blood-vessels. Foods of animals, as already shown, are usually solids; that they may be absorbed and enter into the blood of animals they must first be reduced to a fluid condition; this solution is the object of digestion and is accomplished by means of the different secretions poured out by the alimentary canal. It is evident, therefore, that the alimentary tract must consist of a cavity to contain these digestive fluids; must communicate with the exterior to permit of the entrance of food and removal of indigestible residue; that it must be provided with motor organs for determining the entrance of food, and that its walls must be capable of elaborating digestive secretions and absorbing the results of the digestive process. Digestion, therefore, includes a number of complex processes: the prehension of food and in many cases its mechanical comminution or mastication by special organs; secretion, or the mode of production of the digestive fluids; absorption, or the means of conveyance of the digestive products into the blood stream; and finally defecation, or the expulsion of the non-nutritious residue. If the digestive tract is considered from the point of view of these different purposes, it will be found to be very differently constituted in different members of the animal kingdom, its state of development governing the complexity of all accessory organs.

In the higher animals it consists of the mouth, the pharynx, gullet, stomach, intestine, and anal aperture. In its development it is found to be simply a continuation of the external surface reflected inward as we would turn in the finger of a glove. Consequently, in the gradual evolution of the alimentary canal from its simplest to its most complex form, we find every grade of such reflection, from a mere depression in the external surface, as in the amœba, to the long and complicated intestinal tube of the ruminant. In all cases this is the mode of origin of the alimentary canal; consequently, food, when within the alimentary

eanal, is still practically in contact with the external surface, and, therefore, still outside the body. To enable it to pass through the walls of the digestive cavity into the circulatory system is the object of digestion, and we shall find that this is accomplished by the production of more or less profound chemical changes in the food-constituents.

The length, capacity, and complexity of the digestive canal are governed by the complexity of the food. Vegetable feeders, therefore, of all classes of animals, have a more highly developed alimentary canal than animals of the same class which feed on animal food. With this modification, the statement may be made that there is a gradual increase in complexity of the digestive organs as the animal scale is ascended.

In the amœba we find the simplest possible representative of a digestive function. When alimentary substances come in contact with

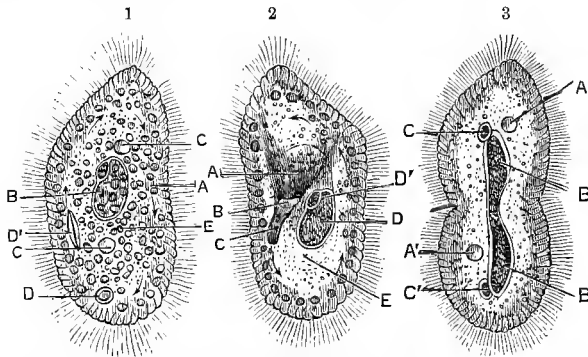

FIG. 56.—PARAMŒCIUM BURSARIA, AFTER STEIN. (Huxley.)

1. The animal viewed from the dorsal side. A, cortical layer of the body; B, nucleus; C, contractile chamber; D D', matters taken in as food; E, chlorophyll granules.
2. The animal viewed from the ventral side. A, depression leading to B, mouth; C, gullet; D, nucleus; D', nucleolus; E, central sarcoele. In both these figures the arrows indicate the direction of the circulation of the sarcoele.
3. Paramœcium dividing transversely. A A', contractile spaces; B B', nucleus dividing; C C', nucleolus.

the soft external surface of the amœba a temporary depression or pocket forms around them, and by the gradual deepening of this depression and closing of a wall around it a cavity is formed and the alimentary substances gradually brought to the interior of the mass. Within this temporary chamber the alimentary substances are removed and appropriated, while the undigestible residue is removed by a process the reverse of that concerned in its introduction. The amœba therefore has, strictly speaking, no digestive organs, but it temporarily develops a cavity at the point of contact with the food.

In certain of the infusoria, such as the *paramœcium*, we have a single portion of the external body surface specialized as the orifice of entrance for the food-stuffs. An oral aperture (which in this illustration



is bordered by cilia) is, therefore, the first point of specialization of the digestive tract. No digestive tube is, however, yet present, but the orifice in the walls of such an animaleule communicates directly with a central body-cavity, and the orifice of entrance and exit of the food is the same (Fig. 56).

In the hydra there is a definite oral aperture, or mouth, leading to a permanent body cavity, and this opening serves also for the inlet of food and the outlet of the undigestible residue. The hydra has, however, advanced a step in specialization, since it is provided with definite prehensile organs (tentacles) for the seizure of food (Fig. 57).

There are apparently, however, no true digestive secreting organs in the hydra, since the internal body cavity appears to be strictly the same as the external surface. Hydræ have even been everted, so as to make

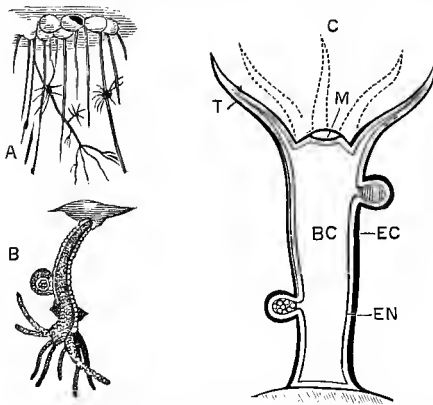

FIG. 57.—HYDROZOA. (Jeffrey-Bell.)

A, hydra viridis attached to duck-weed; B, a single specimen magnified; C, hydra in diagrammatic section.

EC, ectoderm; EN, endoderm; M, mouth; BC, enteric cavity; T, tentacles.

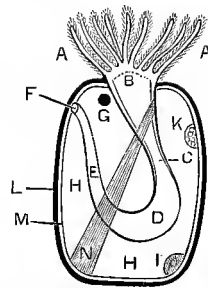

FIG. 58.—FLUSTRA. DIAGRAMMATIC SECTION OF A SINGLE CELL OF FLUSTRA, OR "SEA-MAT" (GREATLY MAGNIFIED). (Wilson.)

A A, ciliated tentacles; B, mouth; C, gullet; D, stomach; E, intestine; F, anus; G, nervous ganglion; H, general body cavity; I, testis; K, ovary; L, ectocyst, or outer membrane of body; M, endocyst, or inner membrane of body; N, retractor muscle, by the action of which the animal can withdraw the ciliated tentacles.

the original outside surface the lining surface of the digestive cavity, and digestion was still quite as efficiently performed. Similar types of digestive organs are seen in sponges and in the jelly-fish. In the latter, however, a step still further has been made in the development of channels for the distribution of the nutritive substances.

A true alimentary canal should have two openings, one for the ingress of food, the other for the egress of excreta. The simplest form of such an organ is seen in the flustra, or sea-mat, and in the sea-urehins (Fig. 58.) In these organisms both the mouth and the vent develop constricting muscles. In the animals of which the worm is the type (Figs. 59 and 60), the digestive tract is either a straight tube running from one end of the body to the other, or it may be divided into little pouches or saccules, as in the leech (Fig. 61).

In the myriapods and larvæ the same general plan is continued, the alimentary canal still being a simple tube passing from one extremity of the body to the other, with an oral orifice and vent, but in these animals showing a division into gullet, stomach, and intestines (Fig. 62). A difference is also met with according as the animals are carnivorous or vegetable-feeders. In the former the canal is narrow and nearly straight,

with a slight dilatation representing the stomach, while in the herbivorous species it is complicated by saccular pouches to delay the onward progress of the food. In the tunicata the division of the alimentary canal into gullet, stomach, and intestines is more marked, since we have in them a distinct œsophagus, stomach, small and large intestines. In the crustaceans there exists a definite digestive apparatus, with the first appearance of distinct glands having for their function the secretion of digestive juices, crustaceans especially having a voluminous liver which secretes a yellowish-green fluid of the nature of bile. In the crustaceans

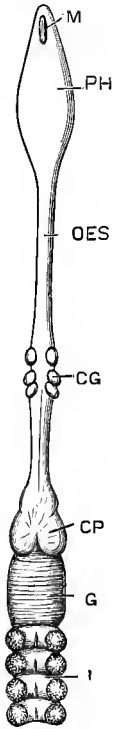

FIG. 59.—DIAGRAM OF THE ALIMENTARY CANAL OF AN EARTH-WORM, AFTER RAY LANKESTER.

M, mouth; PH, pharynx; OES, œsophagus; CG, calcareous glands; CP, crop; G, gizzard; I, intestine.

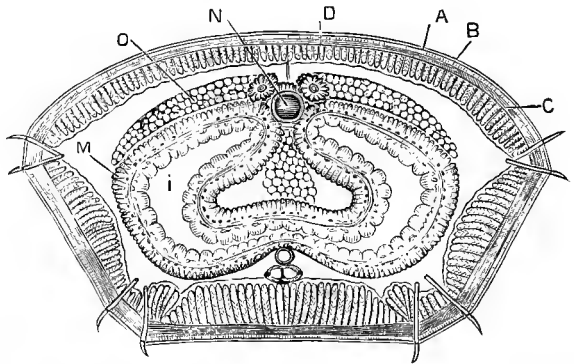

FIG. 60.—TRANSVERSE SECTION OF EARTH-WORM TO SHOW POSITION AND RELATIONS OF THE INTESTINES, AFTER CLAPARÈDE. (Jeffrey-Bell.)

A, cuticle; B, hypodermis; C, layer of circular muscles; D, layer of longitudinal muscles; I, enteric cavity; M, "green layer;" N, dorsal vessel; O, liver.

the liver has become a symmetrical, lobulated organ, instead of the numerous small folliculi which are found in earlier forms around the alimentary canal, and which pours its secretion into the upper part of the intestine. In the higher crustaceans, such as the crabs and lobsters, there is a short, wide sac, provided with internal hard, calcareous denticles, which serves the purpose of a gullet, stomach, and gizzard. The

intestine is short, nearly straight, and simple; sometimes it is also provided with cæca. In insects there is a great variation in the form and length of the canal, depending on the stage of metamorphosis; nearly



FIG. 61.—DIGESTIVE CANAL OF THE LEECH (*Sanguisuga medicinalis*), AFTER NUHN.

oe, œsophagus; v, stomach; v', caecal appendages; r, rectum; a, anus.

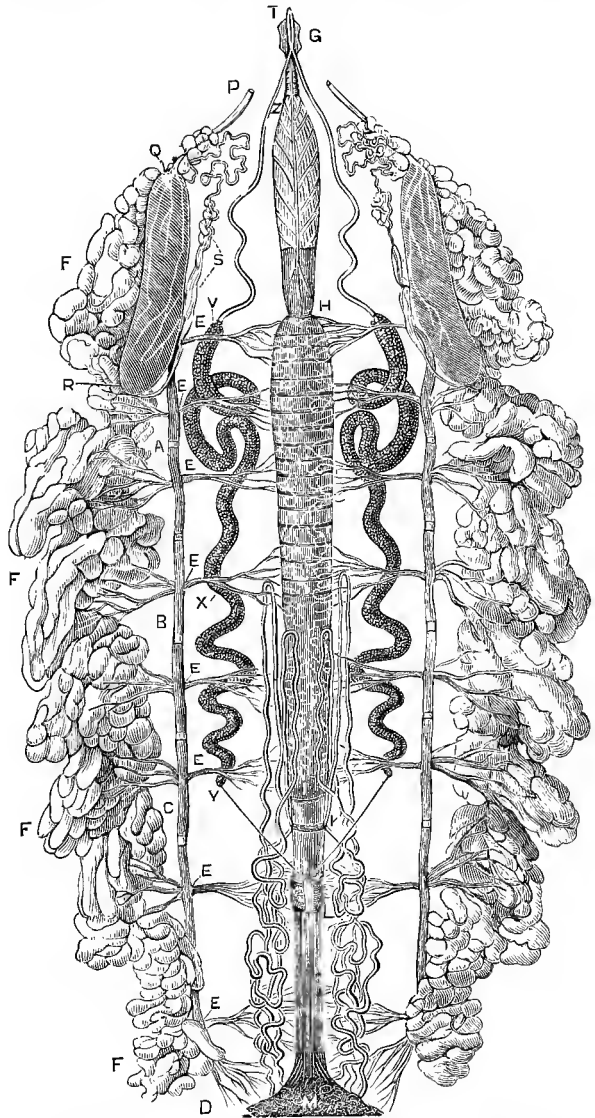

FIG. 62.—VISCERA OF A CATERPILLAR. (Rymer Jones.)

GH, œsophagus; HI, stomach; IM, intestine; K, biliary vessels; QR, salivary glands; P, salivary ducts; ABC, tracheæ; DEEEE, air-tubes; FFF, epiloon, or fat-mass; VXY, cæca.

always, however, a gullet, craw, gizzard, large and small intestines, and numerous glandular appendages may be recognized (Fig. 63).

In the vermiform larvæ the alimentary canal is a straight tube passing from one end of the body to the other, the dilatations which represent the stomach and crop appearing later. Cæca are also then present, and there is hence a division into small and large intestines. In mandibulate

insects, as in the wasps and beetles, the crop and stomach are glandular, and the gizzard, unlike that of birds, is placed above the stomach, and has muscular walls and a chitinous lining-membrane. In insects the form of the liver has again returned to that of long, slender tubes, pouring their secretion into the intestine, and which are believed to represent biliary canals (Fig. 63). In carnivorous insects the crop and gizzard and large intestine are less developed than in those which feed on vege-

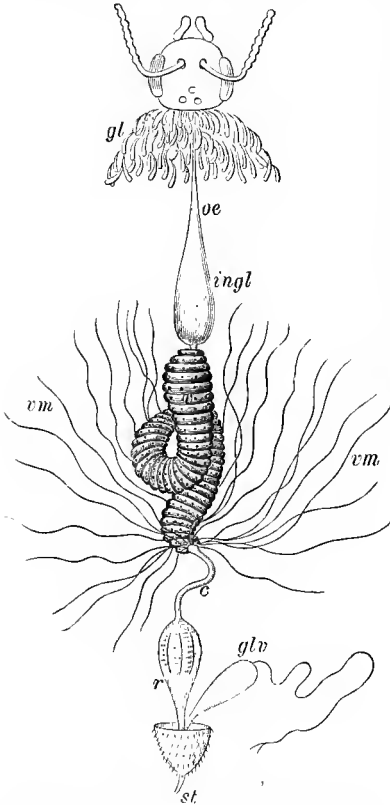

FIG. 63.—DIGESTIVE APPARATUS OF HONEY-BEE (*Apis mellifica*), AFTER LEON DUFUR.

gl, salivary gland; glv, poison-gland; st, sting; oe, oesophagus; vm, vasa malpighii; c, colon; r, rectum; ingl, crop.

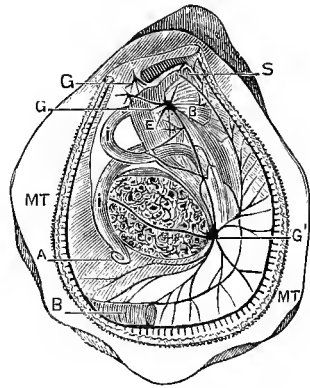

FIG. 64.—ANATOMY OF THE OYSTER. (*Perrier*).

F, mouth; E, stomach; I, intestine; A, anus; G G', nervous ganglia; MT, mantle; B, branchiae.

table food, thus indicating in them the first appearance of the distinction between the herbivorous and carnivorous animals, showing that the complexity of the alimentary canal is in direct proportion to the complexity of the food. The intestine is narrow, convoluted, and but seldom has a mesentery; distinctions between small and large intestines are but imper-

fectly indicated. The intestine terminates in an expansion, the cloaca, into which the reproductive organs open.

In bivalved mollusks like the oyster (Fig. 64) the gullet and pharynx are absent and the mouth communicates directly with the stomach, which is imbedded in a large glandular organ, the liver, and the intestine after making a few turns passes directly through the heart. In univalved mollusks like the snail (Fig. 65) the gullet is long, the crop is frequently present, and the stomach is sometimes double, the anterior portion provided with teeth and serving as an organ of mastication or as a gizzard (Fig. 65). A lobulated liver is also here present; the intestine is convoluted, passes through the liver, and usually terminates in the anterior part of the body. The highest mollusks, such as the cuttle-fish (Fig. 66), show a marked advance in complexity, the highest stage of development of the alimentary canal

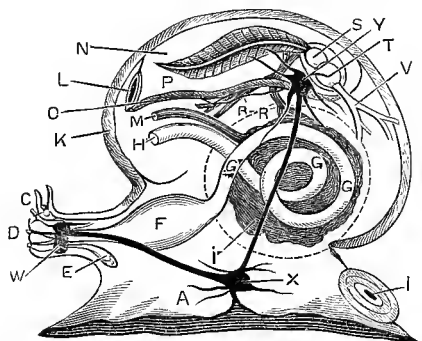

FIG. 65.—DIAGRAMMATIC SECTION OF SNAIL. (Wilson.)

A, foot; B, operculum; C, tentacles; D, mouth; E, salivary glands; F, stomach; G, G, intestines; H, anus; I, liver; L, aperture of gill-chamber; M, oviduct; N, gill-chamber; O, floor of gill-chamber; P, gill of breathing organ; S, T, heart; W, cephalic, X, pedal, and Y, branchial ganglia.

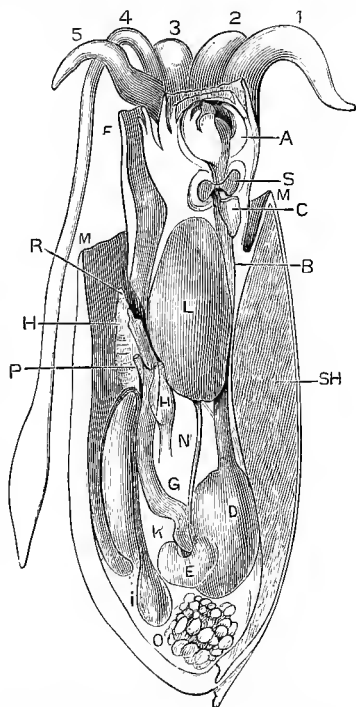

FIG. 66.—DIAGRAMMATIC SECTION OF A FEMALE CEPHALOPOD (*Sepia officinalis*). (Huxley.)

A, buccal mass surrounded by the lips, and showing the horny jaws and tongue; B, œsophagus; C, salivary gland; D, stomach; E, pyloric caecum; F, the funnel; G, the intestine; H, the anus; I, the ink-bag; K, the place of the systemic heart; L, the liver; N, the hepatic duct of the left side; O, the ovary; P, the oviduct; Q, one of the apertures by which the atrial system, or water chambers, are placed in communication with the exterior; R, one of the branchiæ; S, the principal ganglia around the œsophagus; M, the mantle; SH, the internal shell, or cuttle-bone; 1, 2, 3, 4, 5, the margins of the foot, constituting the so-called arms of the sepia.

being accompanied by the appearance of definite organs of circulation and of the nervous system.

In vertebrates the complexity and perfection of the alimentary canal has advanced still further, and we find in them that the buccal cavity, which in fish and amphibians is single, in the reptiles is divided into two divisions,—a nasal or respiratory portion and a buccal or digestive

portion. The teeth here also commence to be especially developed. Fishes have a short, simple, wide alimentary canal and stomach, separated by a marked constriction from the small intestine, but the separation of the stomach from the gullet is less marked, being indicated often only by the difference in structure of the mucous membrane; hence, in these animals regurgitation of food is easy, and is the method which is often employed for the removal of indigestible residue. A form of rumination is also said to occur in certain fishes, the food being regurgitated to the

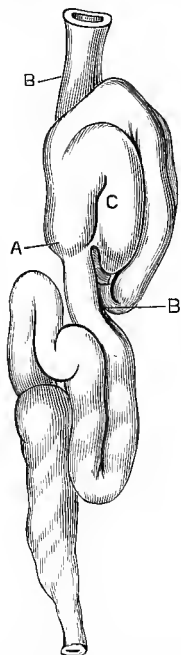

FIG. 67.—INTESTINAL CANAL OF THE STURGEON. (*Carus*.)

BB, pharynx and *cul-de-sac* of the stomach; A, pylorus; C, pancreatic appendices of the pylorus; below are seen the convolutions of the small intestine terminating in the spiral large intestine.

mouth and remasticated by the teeth or pharyngeal bones, as in the carp. In fishes (Figs. 67 and 68) the stomach is usually bent like a siphon, the intestine is straight and short, with but in rare cases any distinction between large and small intestines. There is no distinct ileo-cæcal valve, but sometimes a cæcum is present. The intestine is rarely supported on a mesentery.

In the amphibious reptile the type of the alimentary canal is somewhat similar to that of the fish, though the distinction between the large and small intestines is better marked. The œsophagus is short, dilatible, and muscular, and the stomach is tubular and may be bent upon itself. A distinction between large and small intestines

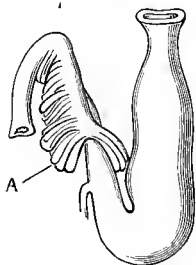

FIG. 68.—STOMACH OF THE SALMON-TROUT (*Carus*), SHOWING THE PANCREATIC APPENDICES OF THE PYLORUS AT A.

is readily made. The influence of the food on the development of the alimentary canal is seen in the long, coiled intestine of the vegetable-feeding tadpole, as contrasted with the short intestine of the insectivorous frog and toad. The crocodile (Fig. 69) has a more complex stomach than any animal lower in the scale. It is a sort of blending of the digestive organ of the euttle-fish and the bird, having powerful muscular walls, with muscular fibres radiating from a central tendon in a manner very closely similar to that seen in the gizzard of the bird. The

crocodile, therefore, forms the connective link in the development of the digestive tube between reptiles and birds. In this animal the duodenum is also first seen, the liver and pancreas emptying into it, and the mesentery first makes its appearance as a constant organ. The alimentary canal of reptiles is simpler than that of birds, but resembles the bird more than the fish. The œsophagus varies with the length of the neck, and is wide and dilatible in the ophidia. It joins the stomach without any constriction, its mucous membrane becoming glandular. In the serpents the cardiac portion of the stomach is long, saccular, and dilatible, while the pylorus is narrow and muscular. The intestines are short and wide in the carnivorous species, but long and furnished with cæca in vegetable feeders.

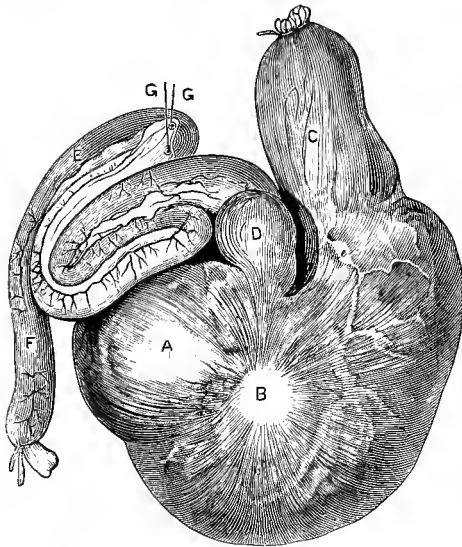

FIG. 69.—STOMACH OF CROCODILE. (*Rymer Jones.*)  
 C. œsophagus; A. muscular fibres of stomach radiating from B, the central tendon, as in the gizzard of the bird; D. commencement of duodenum.

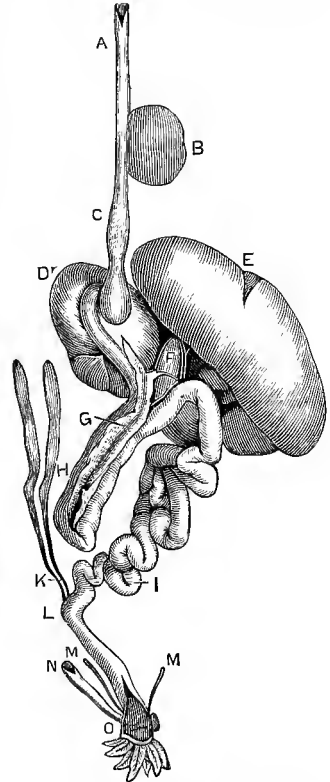

FIG. 70.—DIGESTIVE APPARATUS OF BIRDS.

A. œsophagus; B. crop; C. infundibulum; D. gizzard; E. liver; F. gall-bladder; G. pancreas; H. duodenum; I. small intestine; K. Cæca; L. large intestine; M M, ureters; N, oviduct; O, cloaca.

In birds there is a most marked difference in the length and development of their alimentary canal, dependent upon the nature of their food, the granivorous and fructivorous birds having intestinal tubes of greater length and complexity than those which live on animal diet (Fig. 70). In all cases the stomach is well separated from the œsophagus, the length of the latter being, of course, dependent upon the length of the

neck of the bird, while its width and dilatibility depend upon the nature of the food. In granivorous birds we meet with the first indication of the development of the œsophageal pouches for the retention and maceration of food,—organs which are identical in function with the first three pouches of the mammalian ruminant stomach. The locality and character of these pouches vary in different birds.

In the granivorous birds this organ, which is termed the crop, is located at the lower part of the gullet. It may be double, as in the case of the pigeon, and distinctly arrests the food and retains it in contact with fluids to enable it to become macerated before being passed down to the digestive organs proper. In flesh-eating birds, such as the pelican,

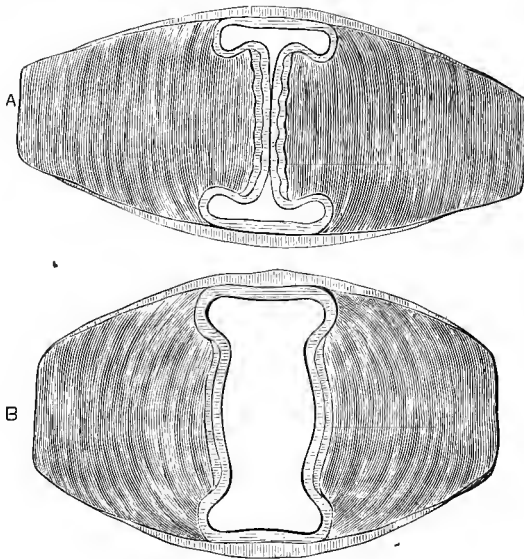

FIG. 71.—HORIZONTAL SECTION OF GIZZARD OF GOOSE, AFTER GARROD.  
A, in contraction; B, in relaxation.

the pouch is located higher up in the digestive canal, ordinarily below the lower jaw, and here seems to be more of a reservoir for storing food than as a distinct commencement of the digestive apparatus. Fruit- and insect-eating birds are not supplied with any such reservoirs, while the turkey, ostrich, goose, swan, and most of the waders, have a highly-developed crop; the pigeon, as before stated, having two, one on each side of the œsophagus. The stomach in birds differs according as their diet is vegetable or animal. Granivorous birds have a small, straight, dilatible stomach, called the proventriculus, communicating above with the gullet and below with a highly muscular organ, the gizzard (Fig. 71), lined with horny epithelium, usually containing gravel or sand,



and which has for its function the crushing and mastication of food. The proventriculus, *ventriculus succenturiatus*, or true glandular stomach, varies in form and size in different birds, being sometimes wide and straight and sometimes round. In the ratorial birds it is wider than the gullet and smaller than the gizzard. Its mucous membrane is thicker than that of the œsophagus, and furnished with tubular glands which secrete an acid digestive secretion. In the grain-eaters these glands are sacculated, or expanded into compound follicles, the disposition of the glands varying in different species. The gizzard, *ventriculus bulbosus*, the third or muscular stomach, is a more or less flattened, ovoid organ, having two apertures at its upper part, one communicating with the proventriculus, the other with the small intestine. The gizzard is feebly developed, or may be even absent in carnivorous birds, such as the crow and the raven, and is there simply a membranous expansion of the stomach, free from secreting membrane, and bearing close analogy and function with the membranous cardiac extremity of the stomach of the horse. The intestines of birds are, as a rule, relatively to the size of the body, shorter than those of mammalia, but longer than those of reptiles. In birds of prey, as a rule, they are not more than twice as long as the body, including the bill, but in the osprey they are eight times as long. In fructivorous and granivorous birds they are much longer. The duodenum forms a loop, embracing the pancreas. The division between small and large intestines is not clearly marked, as villi are found in both. The point of entrance of the cæca, which are most developed in birds feeding on vegetable food, marks the union of small and large intestines.

In all the groups of animals already referred to the stomach occupies a position in the long axis of the body. It is only in mammals that its position becomes transverse (Fig. 72), and we notice that even in these animals this transverse position becomes more accentuated during its state of functional activity. Thus, when fasting the pyloric orifice of the stomach sinks and the organ tends to assume a longitudinal position; when filled with food it undergoes a partial rotation on its own axis, the pyloric orifice ascends, and it now becomes transverse.

In mammals the œsophagus is only destined to convey food to the stomach; it has contractile walls, but few or no glands, and the pouches which we have recognized in the birds are represented in but a single group of mammals,—the ruminants,—and here they are situated so low down in the œsophagus as to be ordinarily described as divisions of the stomach. Their function and structure prove that they may be regarded, nevertheless, as œsophageal pouches. The diameter of the œsophagus varies according to the food which serves as the normal diet for these animals. It is large and readily dilatable in carnivora, which bolt their food entire; it is narrow in the herbivora; and in those animals which

thoroughly masticate their food, as in solipedes, it is narrow and less distensible than in ruminants, where the preliminary mastication is less complete.

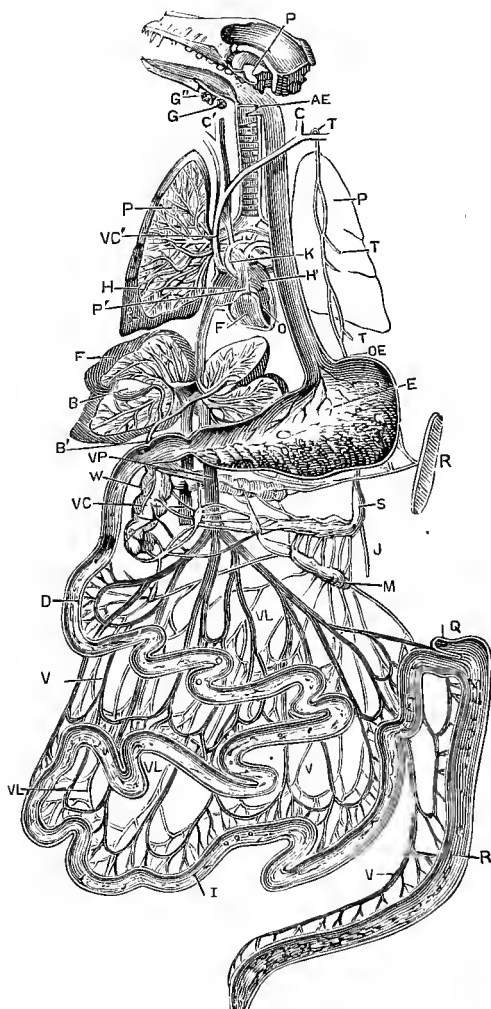

FIG. 72.—DIGESTIVE TRACT OF THE DOG, AFTER BERNARD.

P, parotid gland; G, submaxillary gland; G', sublingual gland; OE, oesophagus, or gullet; C', right carotid; C, jugular vein; P, P, lungs, that on the left opened to show the bronchial tubes, arteries, and veins; VC', superior vena cava; K, aorta; H, right auricle of the heart; H', left auricle; F', right ventricle; O, left ventricle; P', pulmonary artery; T, T, thoracic duct; F, liver; B, gall-bladder, entering the intestine by the duct, B'; E, stomach; R, spleen; S, Pecquet's reservoir; J, lymphatics; M, mesenteric ganglia; VP, trunk of portal vein; V, V, origins of portal vein; W, pancreas; VC, inferior vena cava; D, duodenum; VL, lacteals; I, small intestine; Q, caecum; R, cælen, or large intestine.

The stomach is charged to contain the food until it has undergone the chemical modifications which are essential to its absorption. It forms a reservoir which is in mammals clearly separated from the œsophagus and the intestine, and which, as already stated, occupies a transverse position in mammals, longitudinal in reptiles and the oviparous vertebrates, while its transverse position commences to be indicated in birds. The stomach may be either simple or complex. In carnivora, whose food is easy of solution, it is a single cavity lined with a uniform mucous membrane abundantly supplied with glands which secrete an acid fluid, the gastric juice, which has for its function the conversion of albuminous

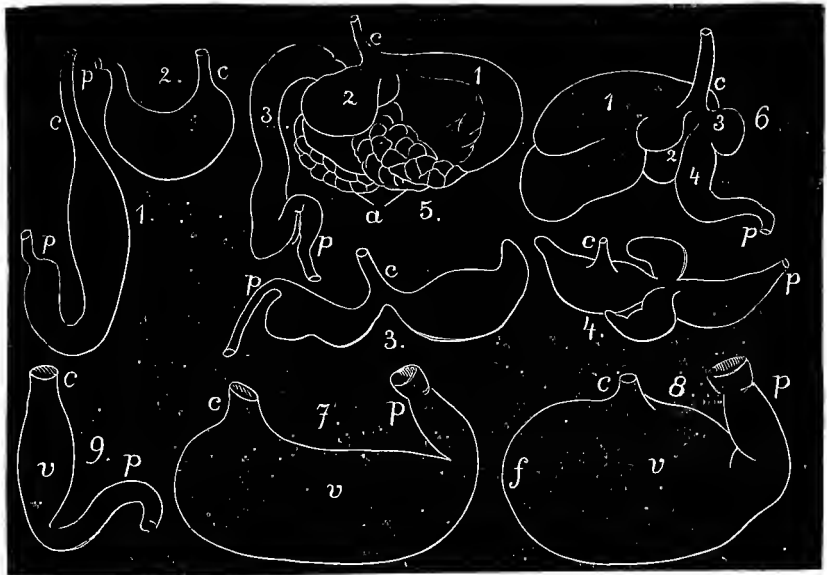

FIG. 73.—STOMACH OF DIFFERENT MAMMALS AND OF A TURTLE. (*Thanhoffer.*)  
 1, stomach of seal; 2, stomach of hyena; 3, stomach of erictus; 4, stomach of manate; 5, stomach of camel; 6, stomach of sheep; 7, stomach of lion; 8, stomach of horse.  
 c, cardia; p, pylorus; 1, 2, 3, 4, 1st, 2d, 3d, and 4th stomachs; v, ventriculus; f, fundus ventriculi.

foods into peptones. The complication of the stomach in mammals progresses in insensible degrees, and in a general way is in proportion to the indigestibility of the food (Fig. 73). At first the division of the stomach into pouches is only indicated by a difference in structure and properties of the mucous membrane of the cardiac and pyloric portions of this viscus. This difference is, to a certain extent, present in all animals, even in the carnivora, where it is confined simply to a histological difference in the nature of the glands of these two portions of the stomach. No difference is, however, evident to the naked eye in these animals. In the horse the separation into a cardiac and pyloric pouch is

indicated by a groove seen on the external surface of this organ and internally by a sharp demarcation between the glandular mucous membrane

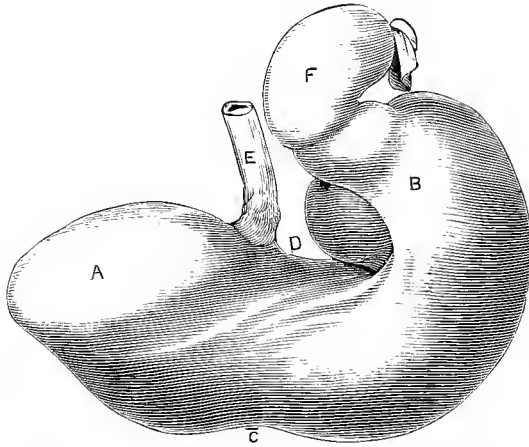

FIG. 74.—POSTERIOR SURFACE OF STOMACH OF HORSE. (*Strangeways.*)

A, left *cul-de-sac*; B, right *cul-de-sac*; C, greater curvature; D, lesser curvature; E, oesophagus; F, duodenum.

of the pyloric portion and the membranous portion of the cardiac end. In the solipedes (Fig. 74), therefore, the general appearance and characters of the stomach correspond with those of the carnivorous birds,

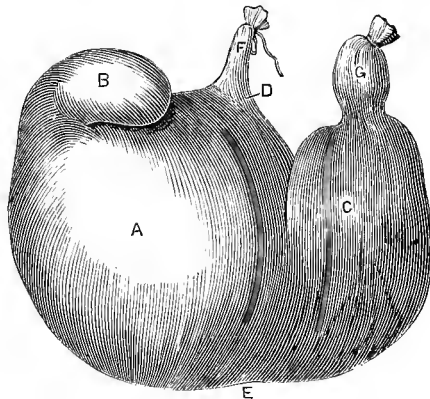

FIG. 75.—STOMACH OF HOG, INFLATED. (*Strangeways.*)

A, cardiac portion; B, its accessory *cul-de-sac*; C, pyloric portion; D, lesser curvature; E, greater curvature; F, oesophagus; G, pyloric orifice.

where we have a separation into a glandular and membranous portion; the difference between these animals consisting in the fact that in such birds it is the cardiac extremity which is glandular, and the pyloric

extremity, or the rudiment of the gizzard, membranous, while in the horse the reverse holds. In the hog (Fig. 75) the division into pouches is more marked by the appearance of a distinct, curved, conical diverticulum at the cardiac extremity of the stomach. In the porcupine three or four contractions are marked, and in the kangaroo, porpoise and other cetaceans, and many rodents a large number of dilatations, separated by marked constrictions, are to be noticed (Fig. 76). In other animals this complication is not only in external form, but also in internal structure, the highest degree of complexity being found in the ruminant, where the stomach, so called, is divided into four distinct gastric sacs, communicating with each other only by small orifices, whose function and structure will occupy us later (Fig. 77). This complication is found not

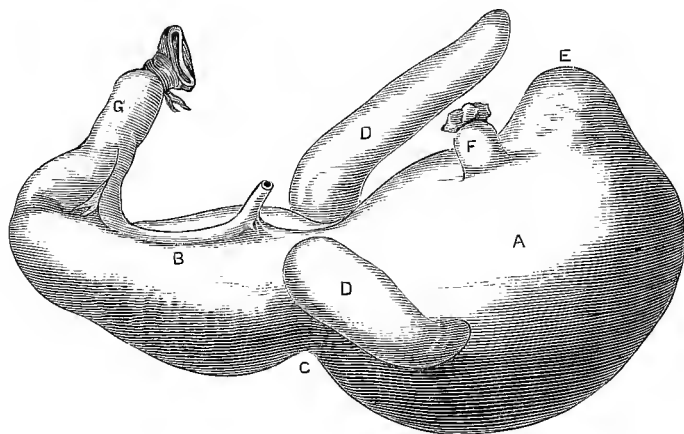

FIG. 76.—STOMACH OF THE DUGONG, AFTER SIR EVERARD HOME.

A, cardiac portion of stomach; B, pyloric portion; C, constriction between the two; D D, tubular prolongations of the stomach; F, oesophagus; G, intestine.

only in mammals, but also in birds; but, whatever may be the external form of the organ, the function is always the same,—to supply an acid secretion for the solution and digestion of certain constituents of the food,—and where reservoirs are present their function is simply to retain food until, as in the case of the ruminant, it may be again masticated; or in all cases to enable the food to undergo preparatory changes before being subjected to the action of the gastric secretion.

The intestine is the prolongation of the stomach, and its shape as a canal is again regained. In its simplest form in the lowest animals it is a short tube of uniform size, with the same structure and properties from one end to the other, as seen in invertebrates, in most reptiles and fishes, and, among the mammals, in the hedgehog and the bat. In the higher

classes it is divided into two forms, the small and large intestines. The small intestine is destined for the absorption of food-products, and for the elaboration of the digestive secretions for the solution of food-stuffs which have escaped the action of the gastric juice. We find its walls, therefore, supplied with tubular glands secreting the so-called intestinal fluid; and emptying into the small intestine we find in all cases two large glandular organs, the liver and pancreas, secreting alkaline fluids which have a greater or less importance in digestion. In the small intestine of mammals are also to be found special organs for assisting the absorption

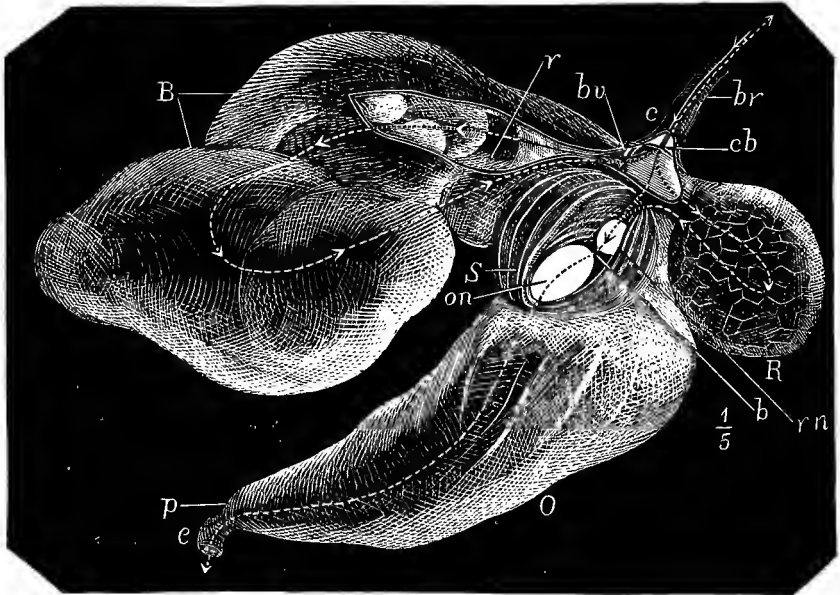

FIG. 77.—STOMACH OF ADULT SHEEP, DRIED AND INFLATED; ONE-FIFTH THE NATURAL SIZE. (*Thantoffer.*)

B, rumen; R, reticulum; S, omasum; O, abomasum; c, cardia; p, pylorus; br, esophagus; bc, cardiac valve; bc, esophageal gutter; r, pillars of the rumen; rn, opening of the reticulum; on, opening of the abomasum, or fourth stomach; b, valve between reticulum and omasum; e, duodenum.

of food, the so-called villi, which are simply conical expansions covered by mucous membrane, whose function, together with that of the folds of the mucous membrane, is simply to give increased surface for absorption. In the higher animals the small intestine is divided arbitrarily into three divisions, the duodenum, or the portion of bowel directly in communication with the stomach, which is always curved and usually free from mesentery. Following this we have the jejunum, so-called because ordinarily found empty, and following that the ileum.

The intestinal canal is supplied with muscular fibres, arranged longitudinally and in concentric rings, being red-striped muscular fibres

in the mouth, pharynx, and anus, and pale, unstriped, involuntary fibres elsewhere. The contractions of these muscular fibres in the small and large intestines serve to cause the onward progression of the food or the so-called peristaltic movement of the intestines. The mucous membrane of the alimentary canal is epithelial in nature in the mouth, pharynx, and gullet, and in the first three pouches of the ruminant stomach, and in the cardiac half of the stomach of the horse. It is free from glands; and is simply protective in nature. In the entire stomach of carnivorous animals, the fourth stomach of ruminants, and the pyloric half of the stomach of solipedes, as well as through the entire extent of the intestines of all mammals, it is glandular, and furnishes a more or less active digestive secretion.

Sensory nerves are supplied to the two extremities of the digestive tube, while the intermediary portions are supplied with nerves whose stimulation seems to lead to secretion, and not, as a rule, to individual sensations.

The extent of mucous membrane varies naturally with the length, diameter, and complexity of the alimentary canal. It is, therefore, less in carnivora, greater in omnivora, and immense in herbivora. The extent of surface, therefore, depends upon the complexity of the food. The more concentrated the food, as in carnivora, the less surface is required for producing secretion, and the less for its absorption. In animals living on a vegetable diet, where the nutritive principles of the food are mixed with a larger amount of non-nutritious residue, a greater surface is required for secretion, greater time is required for digestion, and a greater surface must be supplied for the absorption of digestive matters; we find, therefore, that in herbivorous animals the intestinal tube is always longer, more complicated, and supplied with a larger extent of mucous membrane than in the carnivora. Even in the herbivora we find a difference in the distribution of the mucous surfaces; thus, the horse and ox are both herbivorous animals: the former is a monogastric animal, the latter a polygastric, or ruminant. The former digests little by its stomach, and much by its intestinal tube; the latter readily digests more by its vast and complex stomach than by its narrow and small intestinal tube. Both, however, from the fact that they are herbivorous animals, have a great extent of mucous membrane, which may be twice or three times as extensive as their external body surface. Thus, the cutaneous surface of the horse is about five or six square meters, while its mucous gastro-intestinal surface may be as much as twelve square meters, of which one-thirtieth is represented by the stomach and the rest by the intestines. An ox, on the other hand, of about the same size, has a mucous membrane of about seventeen square meters, of which nine square meters represent the

membrane of the stomach. Consequently, the solipede has a mucous membrane about twice, and the ruminant about three times, as extensive as its cutaneous surface, while the mucous membrane of the stomach alone of the ox is one and one-half times as extensive as the skin surface. In the carnivora—the dog or the cat, for example—the mucous membrane, from the simple character of their food, is very much less extensive in proportion to their external body surface, being only about two-thirds as large as their skin surface. The omnivora, again, occupy a mean between the carnivora and the herbivora.

The length of the alimentary canal, in a less strict degree, however, is also subordinate to the character of the alimentation. In the herbivora the intestinal tube may be as much as twenty-eight times the length of the body, while the intestinal canal of the carnivora is only three or four times as long as the body. There are, however, many exceptions to this rule. Thus, the dromedary has an intestinal tube only five times as long as its body; the ram twenty-eight times as long; the deer twelve times; the rabbit nine; elephant seven; the hyena eight, and the seal twenty-eight times as long as its body length. In these apparent exceptions, as, for example, in the case of the seal, a carnivorous animal, though there is an intestinal tube twenty-eight times as long as its body, we have the proportion of mucous membrane still preserved; for, where in herbivorous animals we have a comparatively short tube, its diameter is always proportionately great, while in the case of carnivorous animals, where the tube is long, its diameter is accordingly small. Thus, the alimentary canal of the horse is shorter than that of the ox, the former being about ninety feet; but it is very much more capacious.

Change in the normal diet of animals leads to changes in the relative dimensions of their intestinal canals. Thus, the alimentary tube of the wild boar is shorter than that of the domestic hog, since its habit in a state of nature is more carnivorous than in domestication. The domesticated cat, living on a mixed diet, has an intestinal tube which is longer than the cat in a state of nature, and the same difference also applies to the domestic ox as contrasted with the buffalo.

The relative capacity of the alimentary canal is even more strictly definable in different species according to their alimentation. The herbivora always have a greater capacity of intestinal tube than the carnivora. In all cases the volume of the stomach is in inverse proportion to that of the capacity of the intestine. Thus, in the horse the stomach is capable of containing from about sixteen to eighteen litres, while the capacity of the horse's intestine varies from one hundred and twenty-five to three hundred litres. In the ox the stomach contains two hundred litres, the intestine one hundred litres. The value of these differences will be studied later. They serve simply to indicate the immense expanse in



the alimentary canal of the herbivora. The extent of surface for absorption in the intestinal tube is still further increased by the formation of plicæ, or folds of mucous membrane, and from what has been said above we would naturally expect that these are more extensive and more highly developed in the herbivora than in the carnivora. This is well exemplified in the case of the ox, whose stomach, which is capable of containing two hundred litres, has only two square meters of external surface, and yet whose internal mucous surface amounts to nine square meters. Such an immense increase of internal over external surface could only be accomplished by the throwing up of the mucous membrane into folds. In the intestine, again, which is capable of holding about seventy-five litres, the square surface externally amounts to fifteen or sixteen meters, showing, therefore, that in the ox the mucous coating of the intestine is more simple.

The carnivora are distinguished by a large, voluminous stomach, coated throughout with a secreting mucous membrane, and the intestine

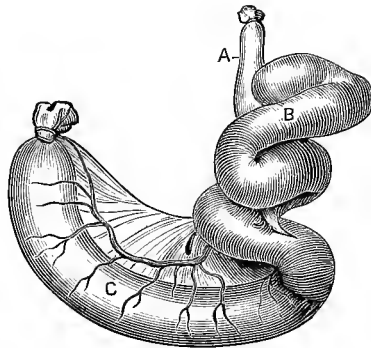

FIG. 78.—CÆCUM OF A DOG, INFLATED. (*Strangeways.*)  
A, ileum; B, cæcum; C, colon.

is simple and deprived of folds. With the exception of the cetacea and a few edentata, the subdivision into a small and large intestine prevails throughout the entire group of mammals. The greater the length of the small intestine, the more is it convoluted. Villi are always absent from the large intestine. A well-marked ileo-cæcal valve, with but few exceptions, is situated at the junction of the small and large intestines.

At this point, also, is almost invariably found a diverticulum, called the cæcum, which varies very greatly in size and functional importance in different animals, these differences also being dependent upon differences in regimen. In the carnivora the cæcum is only a spiral appendix, as seen in the dog (Fig. 78), and the large intestine is divided into the ascending, transverse, and descending portions, as in man; there

is no floating colon, and, while the mucous membrane is sacculated to a certain extent, the folds are by no means as extensive as in the herbivora. In the omnivora the cæcum resembles that of the horse in having three longitudinal bands and transverse constrictions, and has increased in complexity from that of the carnivorous animal. It is absent in the bear and weasel. The cæcum reaches its highest degree of complexity in the monogastric herbivora. In these animals, as in the horse (Fig. 79), it becomes greatly enlarged, convoluted, condensed into folds, has special

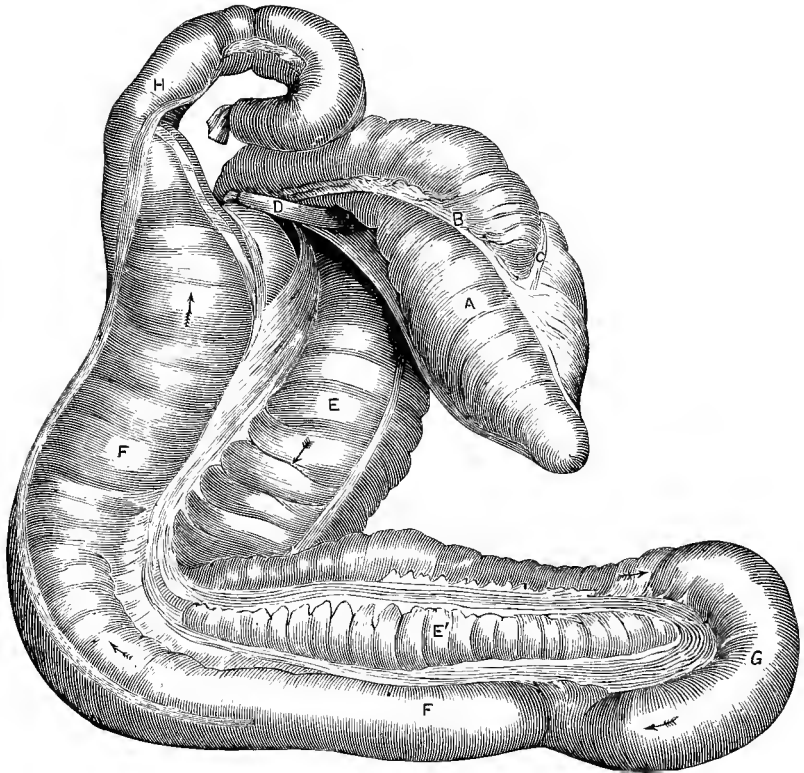

FIG. 79.—CÆCUM AND GREAT COLON OF HORSE. (*Strangeways.*)

A, cæcum; B C, its muscular bands; D, termination of ileum; E, first, E', second, F, third, and F', fourth divisions of colon; G, pelvic flexure; H, origin of floating colon. The arrows indicate the course of the food through the colon.

valves and glands, and in the horse may contain six gallons of fluid, being three times as large as the stomach. In the solipede and rodent the cæcum therefore reaches its highest stage of development, and has special digestive functions to fulfill. In the ox, whose small intestine differs but little from that of the horse, although it is smaller in calibre

and twice as long, from the fact that the increased complexity of the stomach furnishes the necessary differences for the digesting of the food the cæcum is smooth and devoid of longitudinal and transverse bands (Fig. 80). Its free extremity is blunt, rounded, and directed backward, and floats free in the abdomen, while its other extremity, having received the insertion of the ileum, is continuous with the colon, which also is free from bands, and soon becomes constricted, and then, preserving about the same diameter throughout, is arranged in an elliptical coil between the folds of the mesentery. In the ox there is no distinction between the great and floating colon, as in the horse. The total length of the large intestine in the ox, from the cæcum to the rectum, is about thirty-six feet, but its capacity is much less than in the horse.

Further details as to the functions and structure, of the different parts of the alimentary canal in the various domestic animals will be

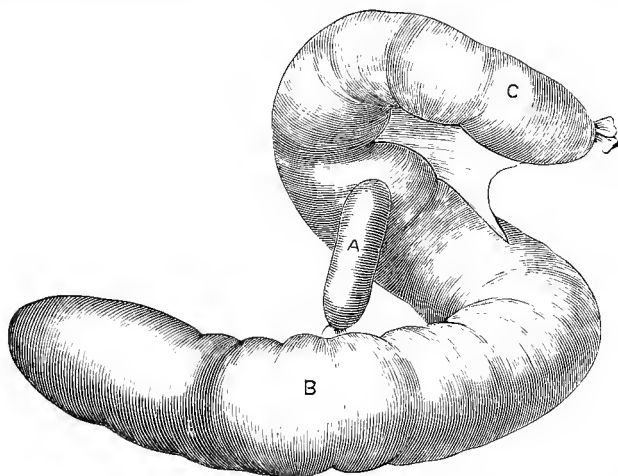

FIG. 80. CÆCUM AND ORIGIN OF COLON OF AN OX, INFLATED. (*Strangeways.*)  
A, terminal portion of the ileum; B, cæcum; C, origin of colon.

given during the consideration of the subject of digestion. So far the aim has been merely to indicate, in a general way, the adaptability of the digestive organs to the character of the food.

The following tables, compiled by Colin, represent the different comparative dimensions and capacities of different parts of the alimentary canal in the domestic animals. They offer confirmation of the statement already made that the functional activity of the stomach and digestive tube being in inverse ratio, in those herbivora with capacious, complex stomachs the intestinal tube will always be less developed than in the monogastric herbivora, where the rôle of the stomach in digestion is secondary to that of the intestine.

LENGTH OF DIFFERENT PORTIONS OF THE INTESTINE COMPARED WITH THAT  
OF THE BODY.

ANIMAL.	Parts of Intestine.	Ratio.	Mean in Meters.	Minimum in Meters.	Maximum in Meters.	Ratio between Body Length and that of Intestine.
Horse,	Small intestine, .	0.75	22.44	16.00	31.60	1:12
	Cæcum, .	0.04	1.00	0.81	1.28	
	Fixed colon, .	0.11	3.39	2.91	4.00	
	Floating colon, .	0.10	3.08	2.35	3.44	
	Total length, .	1.00	29.91	22.07	40.32	
Ass, .	Small intestine, .	0.67	12.00			1:11
	Cæcum, .	0.06	1.02			
	Fixed colon, .	0.17	3.00			
	Floating colon, .	0.10	1.85			
	Total length, .	1.00	17.87			
Mule, .	Small intestine, .	0.70	18.56			1:11
	Cæcum, .	0.05	1.21			
	Fixed colon, .	0.13	3.50			
	Floating colon, .	0.12	3.23			
	Total length, .	1.00	26.50			
Ox,	Small intestine, .	0.81	46.00	41.00	51.00	1:20
	Cæcum, .	0.02	0.88	0.78	1.00	
	Colon, .	0.17	10.18	9.25	11.00	
	Total length, .	1.00	57.06	51.03	63.00	
Dromedary,	Small intestine, .	0.63	31.20			1:15
	Cæcum, .	0.01	0.40			
	Colon, .	0.36	17.72			
	Total length, .	1.00	49.32			
Sheep and Goat,	Small intestine, .	0.80	26.20	15.32	33.00	1:27
	Cæcum, .	0.01	0.36	0.21	0.45	
	Colon, .	0.19	6.17	4.10	8.49	
	Total length, .	1.00	32.73	19.63	41.94	
Hog, .	Small intestine, .	0.78	18.29	14.79	20.14	1:14
	Cæcum, .	0.01	0.23	0.20	0.25	
	Colon, .	0.21	4.99	4.32	5.55	
	Total length, .	1.00	23.51	19.31	25.94	
Dog, .	Small intestine, .	0.85	4.14	2.00	6.10	1:6
	Cæcum, .	0.02	0.08	0.03	0.16	
	Colon, .	0.13	0.60	0.23	1.05	
	Total length, .	1.00	4.82	2.26	7.31	
Cat, .	Small intestine, .	0.83	1.72	1.27	1.94	1:4
	Large intestine, .	0.17	0.35	0.30	0.40	
	Total length, .	1.00	2.07	1.57	2.34	
Rabbit, .	Small intestine, .	0.61	3.56	3.30	3.90	1:10
	Cæcum, .	0.11	0.61	0.50	0.76	
	Colon, .	0.28	1.65	1.41	1.85	
	Total length, .	1.00	5.82	5.21	6.51	

## ABSOLUTE AND RELATIVE CAPACITY OF THE STOMACH AND INTESTINE OF THE DOMESTIC ANIMALS.

ANIMAL.	Parts of Intestine.	Ratio.	Mean in Litres.	Minimum in Litres.	Maximum in Litres.	
Horse,	Stomach, . . . . .	0.085	17.96	10.00	37.50	
	Small intestine, . . . . .	0.302	63.82	38.30	105.00	
	Cæcum, . . . . .	0.159	33.54	16.20	68.00	
	Fixed colon, . . . . .	0.384	81.25	55.00	128.00	
	Floating colon and rectum, . . . . .	0.070	14.77	10.00	19.00	
	Total capacity, . . . . .	1.000	211.34	129.50	357.50	
Ass, . . . . .	Stomach, . . . . .	0.097	10.00			
	Small intestine, . . . . .	0.229	24.00			
	Cæcum, . . . . .	0.201	21.00			
	Fixed colon, . . . . .	0.397	41.50			
	Floating colon and rectum, . . . . .	0.076	8.00			
	Total capacity, . . . . .	1.000	104.50			
Ox,	Stomach, . . . . .	0.708	252.50	215.00	290.00	
	Small intestine, . . . . .	0.185	66.00	56.00	76.00	
	Cæcum, . . . . .	0.028	9.90	8.80	11.00	
	Colon and rectum, . . . . .	0.079	28.00	26.00	30.00	
	Total capacity, . . . . .	1.000	356.40	305.80	407.00	
	Dromedary, . . . . .	Stomach, . . . . .	0.810	245.00		
Small intestine, . . . . .		0.131	39.50			
Cæcum, . . . . .		0.011	3.40			
Colon, . . . . .		0.048	14.60			
Total capacity, . . . . .		1.000	302.50			
Sheep and Goat,		Rumen, . . . . .	0.529	23.40		
	Reticulum, . . . . .	0.045	2.00			
	Manyplies, . . . . .	0.020	0.90			
	Abomasum, . . . . .	0.075	3.30			
	Small intestine, . . . . .	0.204	9.00			
	Cæcum, . . . . .	0.023	1.00			
Colon and rectum, . . . . .	0.104	4.60				
Total capacity, . . . . .	1.000	44.20				
Hog, . . . . .	Stomach, . . . . .	0.292	8.00	7.50	8.50	
	Small intestine, . . . . .	0.335	9.20	8.60	9.80	
	Cæcum, . . . . .	0.056	1.55	1.50	1.60	
	Colon and rectum, . . . . .	0.317	8.70	6.10	11.30	
	Total capacity, . . . . .	1.000	27.45	23.70	31.20	
	Cat, . . . . .	Stomach, . . . . .	0.695	0.341	0.287	0.378
Small intestine, . . . . .		0.146	0.114	0.095	0.127	
Large intestine, . . . . .		0.159	0.124	0.118	0.130	
Total capacity, . . . . .		1.000	0.579	0.500	0.635	
Dog,		Stomach, . . . . .	0.623	4.33	0.65	8.00
		Small intestine, . . . . .	0.233	1.62	0.25	3.00
	Cæcum, . . . . .	0.013	0.09	0.01	0.20	
	Colon and rectum, . . . . .	0.131	0.91	0.07	2.20	
	Total capacity, . . . . .	1.000	6.95	0.98	13.40	

## COMPARISON OF THE GASTRO-INTESTINAL MUCOUS SURFACES WITH THAT OF THE SKIN.

ANIMAL.	Organ.	Partial Mucous Surface in Square Meters.	Total Mucous Surface in Square Meters.	Skin Surface in Square Meters.	Ratio between Mucous Surface of Stomach and Intestine.	Ratio between Skin and Gastro-intestinal Mucous Surfaces.
Horse,	Stomach,	0.40	14.95	5.50	1: 29.87	1: 2.18*
	Small intestine,	4.39				
	Cæcum,	1.50				
	Fixed colon,	4.29				
	Floating colon,	1.37				
Ox,	Rumen,	2.00	17.23	5.80	1: 7.61	1: 2.97
	Reticulum,	0.43				
	Manyplies,	5.56				
	Abomasum,	1.18				
	Small intestine,	5.60				
	Cæcum,	0.46				
Colon,	2.00					
Hog,	Stomach,	0.19	2.81		1: 13.22	
	Small intestine,	1.66				
	Cæcum,	0.11				
	Colon,	0.83				
Dog,	Stomach,	0.12	0.52	0.88	1: 3.36	1: 0.59
	Small intestine,	0.32				
	Cæcum,	0.005				
	Colon,	0.06				
Cat,	Stomach,	0.02	0.12	0.21	1: 4.15	1: 0.58
	Small intestine,	0.07				
	Large intestine,	0.02				

## II. PREHENSION OF FOOD.

1. PREHENSION OF SOLIDS.—By the term prehension of food is meant the different methods employed by animals in seizing their food and conveying it to the oral aperture of their alimentary canal. Many aquatic animals, whose food consists of small particles diffused through water, are supplied with an apparatus for producing currents so as to bring such substances within their reach. This is especially true in the case of fixed forms of life which are unable to go in search of their food. Thus, the sponge and sea-mat, and various other of the lower forms of life, obtain their nourishment by the production of currents in the water through the vibration of cilia lining or surrounding the opening of their alimentary canal. In infusoria, also, we find similar arrangements,

either in the form of cilia or even in tentacles. In the lowly-organized rhizopods and amœbæ, their soft, jelly-like body is simply applied to the food, which then and there enters their body substance. The most marked illustration of the mode of seizing food by means of prehensile tentacles is found in the case of the hydra or polyp,—small organisms whose bodies are not usually longer than one centimeter, and which, as already described, are supplied with a single body cavity, around the single opening of which are long, slender, retractile tentacles, themselves often provided with cilia, and which are capable of grasping small substances which may serve as their food and conveying them to their digestive sac; the adhesive power of these tentacles is increased by a number of minute spiral filaments, the so-called “urticating cysts,” which by some observers are supposed to be offensive weapons, and are used to paralyze the small organisms that serve as their food. The jelly-fish furnishes another example of a similar method of seizing food. These prehensile tentacles may be few and simple, as in the hydra; very numerous, as in the sea-anemone; and often of great length and irregular form, as in the medusæ.

Bivalve mollusks, like the oyster and the clam, employ the vibration of cilia for creating currents to bring the nutritive matters suspended in water within their reach. When the food is solid permanent prehensile organs are usually present, though they may be extemporized, as in the case of the amœba, where any portion of the body surface which is accidentally in contact with food may serve as a prehensile organ to draw matter into the interior of its body. In a higher stage of development we find that tentacles are absent, but that their function is assumed by flexible portions of their body, commonly called arms, which are provided with a number of minute adhesive organs, which serve to seize their food, and whose flexibility enables them to convey it to their oral aperture. This form of prehension of food is seen in the star-fish. In the sea-urchin a considerable advance is seen in the method of prehension of food. The mouth itself is there the prehensive organ, and is provided with five sharp teeth, each standing in a single jaw, and capable of being projected so as to seize as well as masticate the prey. Univalve mollusks, such as the snail, have again another organ, the tongue serving as an organ of prehension. In this case the tongue is long and covered with minute recurved teeth or spines, by which the food is seized and drawn into the mouth, the upper part of which is armed with a sharp, horny plate. In the cuttle-fish, again, the organs of prehension of food have advanced still further in their development. The tongue is still present as a prehensile organ; the jaws, represented by a pair of hard mandibles like the beak of the parrot, and working vertically; and in addition to these several powerful prehensile tentacles, provided with powerful

suckers, or adhesive organs, which serve to grasp its food and to bring it within the mouth.

In the articulates, in addition to the suctorial contrivance already mentioned, innumerable modifications of the mouth are seen, that being the organ which in this group constitutes the main prehensile organ, its modifications corresponding to the character of the food; thus, the earth-worm has a muscular upper lip, by which it secures the earth which contains its food, and which serves to bring it within the mouth. In other worms, again, the gullet is so constructed that it can be turned inside out to form a proboscis for seizing prey. In such instances it is nearly invariably supplied with horny teeth. Millipedes and caterpillars have powerful horny jaws, working horizontally, while the centipedes have a second pair, which are really modified feet, terminating in curved fangs containing a poison-duct. In the crab, the legs and feet serve not only for progression, but also for the mastication of food, as is also the case in the lobster, where the seventh pair of feet are enormously developed and furnished with powerful, crushing pinchers, those on one side of the body being smooth, the other knobbed. Scorpions have, again, a small pair of claws for prehension of food, and a smaller pair of forceps for holding the food in contact with the mouth. In the spider the claws are wanting, and the forceps ends in a fang or hook, which is perforated to convey venom. Biting insects, such as the beetle, have distinct buccal appendages, consisting of two pairs of horny jaws, which open one above, the other below, the oral aperture; the upper are called mandibles or pinchers, the lower the maxillæ, which support the palpi. The former are armed with sharp teeth. The maxillæ are similar, but smaller, and in some insects have appendages which are called palpi or feelers, which not only select but hold the food steady while it is crushed by the mandibles and maxillæ. Such appendages represent a free pair of jaws. All invertebrates move their jaws horizontally.

In all vertebrates the jaws move vertically, and are in many instances the main or sole organ for the prehension of food. In fishes the jaws are always prehensile and often provided with teeth, which, being sharp and curved inward, are prehensile organs; where teeth are absent, as in the sturgeon, the food is drawn in by suction. The hog-fish has a single tooth, which it plunges into its prey and then bores a hole with its saw-like tongue. The fins or tongues of fish are not prehensile.

In reptiles the jaws, teeth, or tongues may serve as prehensile organs, while in reptiles prehensile lips are never present. Thus, the turtle has a mouth provided with horny jaws, the crocodile sharp, curved teeth, and the frog, toad, and chameleon, glutinous tongues for seizing their food. In chelonians the jaws are horny, and are supplied with small teeth in ophidians; in the larger saurians the teeth are powerful, while they are



delicate and complex in the insectivorous species. Serpents crush their prey in their coils before swallowing it.

All birds use their toothless beaks in procuring food. Birds of prey also seize with their claws, while certain birds, such as parrots and woodpeckers, also employ their beaks as prehensile organs. The beak in birds varies in shape according to their food. Thus, it is short and strong in granivorous birds; long and slender in insectivorous birds. In birds which catch their prey on the wing, as the swallows, it is short and gaping; strong and curved in birds of prey which tear their food; long, conical, and of great strength in borers, as in the woodpecker; short and curved in the parrot tribe to enable them to crush nuts; delicate and tapering in humming-birds to allow them to penetrate the corollas of flowers; long, strong, and pointed in most fish-eaters, as the heron, stork, and king-fisher; shovel-shaped in many aquatic birds, such as the duck and goose; or it may be fashioned to hold fish, as in the pelican, albatross, penguins, etc. In the cross-bills the mandibles when closed overlap,—a conformation which enables them to extract the seeds from fir-cones. Finally, in the young pigeon, which feeds by placing its bill in the mouth of the mother-bird, the lower mandible is elongated and boat-shaped, and of greater size than the upper. Hence, it acts as a spoon, and becomes relatively smaller as the pigeon grows. In parrots and woodpeckers the tongue is also prehensile.

The tongue in birds and reptiles, besides being the seat of the sense of taste and an organ of deglutition, is often the sole organ for the prehension of food, the mechanisms concerned in this operation, that is, the extension and retraction of the tongue, differing in birds, reptiles, and mammals. In birds the forward and backward movements of the tongue depend upon the muscles which move the hyoid bone. The horns of this bone in birds are arched and extend up behind the occiput, and give attachment to a muscle which is wrapped around them, and is then inserted in the inferior and posterior surfaces of the rami of the lower jaw. This muscle, which is termed the *conic muscle* of the hyoid bone (Vieq d'Azyr), by its contraction advances the tongue by bending the arches of the hyoid bone, at the same time drawing them forward. Retraction of the tongue is accomplished by the recoil of the elasticity of the hyoid arches, when these muscles relax, aided by the *serpo-hyoid* muscles (Duvernoy). These arches are much larger in the woodpeckers than in other birds.

The mechanism of movement of the tongue in reptiles is much more complicated, and differs somewhat in the four orders of this class. In general it may be said the movements of the tongue in reptiles depend on the two principal means employed separately in birds and mammals; that is, the intrinsic muscles of the tongue and the hyoid muscles.

In the *chelonians* the hyoid cartilage is of variable shape, but in the main resembles somewhat the hyoid bone of the bird, and is moved by a somewhat similar mechanism, excepting that the conic-hyoid muscles are not wrapped around the hyoid arches. The tongue in this species is muscular and glandular, but not extensible.

In the *saurians* (especially in the crocodiles) the tongue resembles that of the chelonians in its slight degree of mobility, and the hyoid bone has a somewhat similar shape. In some saurians the tongue is glandular, in others very muscular and quite extensible.

Most of the *ophidians* have the tongue hidden in a sac, non-glandular, and composed of the union of two muscular cylinders which become separate at the tip, forming the well-known forked tongue of serpents. The tongue is proportionately long and extends some distance down beneath the trachea. The posterior extremity of the sac terminates in two cartilaginous plates, which unite anteriorly and constitute the hyoid arch. By means of muscles which originate from the lower jaw and first ribs, and which are inserted in the hyoid arch, the tongue is extruded from the mouth.

The tongue of the *batrachians*, with the exception of the salamanders, differs greatly from that of other reptiles. Its anterior extremity is convex and is fixed to the arch of the chin, while its posterior extremity is free. To be extended from the mouth it must be reversed, and it is the posterior tip which is extruded, while it is withdrawn by a reversal of this motion. These movements are accomplished by the contraction of the *genio-glossus* and *hyo-glossus* muscles,—the only ones which have any connection with the tongue.

In quadrupeds, although in some cases we find a special contrivance for the seizing of food, as in the trunk of the elephant, the snout of the tapir, the long tongue of the giraffe, and the extensible, viscid tongue of the ant-eater, the teeth are the chief organs of prehension, aided by the lips and, in some cases, the tongue. Such animals as may stand erect on their hind legs, as the squirrel, bear, and kangaroo, use their fore legs for holding food and bringing it to the mouth, but never use one of them alone. Clawed animals make use of their feet in securing prey, but the food is conveyed to the mouth by movements of the head and jaws. In the rhinoceros the upper lip is prolonged into a finger-like point, which in these animals, as well as in the dromedary, is the principal organ of prehension of food.

In man and monkeys the distinguishing prehensile organs are found in the hand, and we find that the first office that the hand instinctively performs in both species is to carry food to the mouth.

Therefore, according to the mode of life for which an animal has been formed, we observe a variety in the arrangement of parts destined to

gather food. In the higher animals we find prehensile organs represented in lower animals by special organs which in different species form a single type of prehensile organ. Thus: in lower forms of life we have tentacles, or the lip may serve as the chief organ of prehension, or the tongue or the jaws; while in the higher mammals we find all these organs together serving the purpose of conveying food to the mouth.

In the latter, which are of the same prehensile type as man, the radius and ulna are isolated and movable, one on the other, and there are distinct fingers, nails, or claws, as in monkeys, carnivora, and most rodents. In all animals which use the fore limbs as prehensile organs, this separation of the radius and ulna is invariably to be found. In the large mammals the anterior limbs are only for support, and such animals are usually herbivorous. In them the radius constitutes the principal bone of the forearm, while the ulna is very small and almost always fused with the radius; so no motion between the two is possible. There are, however, numerous exceptions to this, and in animals where it would be least expected. For instance: in the elephant the volume of the ulna is superior to that of the radius, and its carpal extremity is greater than that of the radius, and both are distinct. This also is the case in the rhinoceros; but in both these animals the motions of pronation and supination are impossible. Most of the herbivora have a forearm terminating in one or two single fingers or phalanges surrounded by a hoof, and in these the radius constitutes the main or sole bone of the fore extremity. The development of the ulna and the fingers are in direct ratio.

In the domestic animals the prehension of food is accomplished by different organs, which have different degrees of usefulness and development in different types. In the dog and cat the fore limbs have independent radii and ulnæ, a certain amount of pronation and supination is possible, and they indicate, to a certain extent, the prehensile power of the hand as seen in man and monkeys. Where, as in the herbivorous quadrupeds, the fore limbs are destined solely for support and progression, a long neck and peculiarly shaped head favor the use of the tongue, lips, and teeth, which in these animals are the sole prehensile organs. The tongue and lips are supplied with muscular tissue: hence the power of motion.

In the horse the upper lip is the principal organ of prehension. This organ is supplied with circular muscular fibres, as well as elevator and depressor muscles, the elevator being especially efficient in curling and elevating the upper lip so as to grasp food. The elevator of the upper lip terminates in a broad Y-shaped tendon, which is inserted in the free part of the upper lip (Fig. 81). The tongue has extrinsic and intrinsic muscles, which favor its protrusion and enable it to grasp

the food and draw it within the mouth. The extrinsic muscles are connected with the hyoid bone and chin, and render possible the protrusion and retraction of the tongue; the intrinsic muscles permit of



FIG. 81.—AFTER GAMGEE AND CHAUVEAU.

1 and 2, auricular muscles; 3, scutiform cartilage; 4, external scuto-auricular muscle; A A, auricular branches of first pair of cervical nerves; B B, anterior auricular nerves; C, terminal fibres of the supraorbital nerve; D, superficial branch of the lachrymal nerve; Y, tendon of muscle to elevate upper lip; Z, naso-transversalis muscle.

the change of shape of the tongue required in mastication and deglutition. The tongue is, further, covered with a mucous membrane, on the dorsal surface of which are numerous more or less horny papillæ,

which in the cat tribe acquire especial hardness. The arrangement of these papillæ is characteristic of the different animals. Four kinds of papillæ have been recognized,—the filiform, or thread-like; the mushroom-shape, or fungiform; the conical; and the so-called circumvallate papillæ, which are in shape similar to the fungiform papillæ,

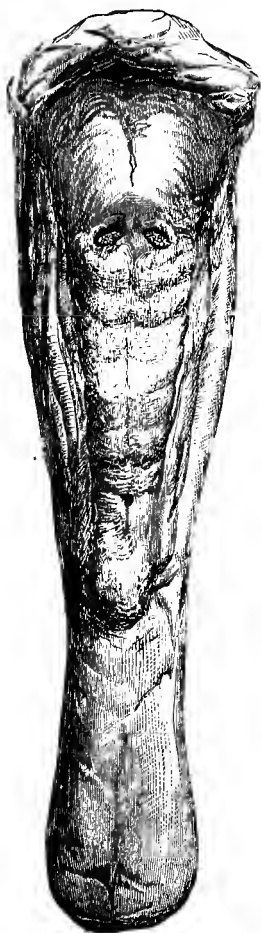

FIG. 82.—TONGUE OF HORSE. (*Gamgee.*)

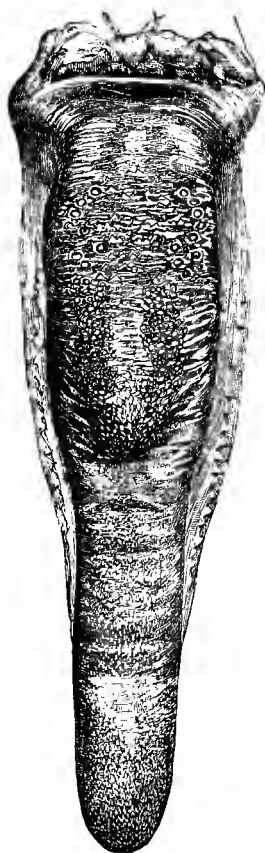

FIG. 83.—TONGUE OF OX. (*Gamgee.*)

but which are surrounded by a circular groove. By the distribution of these papillæ the tongue of the horse can readily be distinguished from that of the ox,—a point of some consequence, since horses' tongues are sometimes sold in the market as beef-tongues. The tongue of the horse is long, with a well-marked middle depression, or raphé, with a

broad, flattened spatula-shaped tip. At either side of the middle line toward the root of the tongue is a very large compound circumvallate papilla (Figs. 82 and 83). In the ox the tongue is pointed, thicker, and

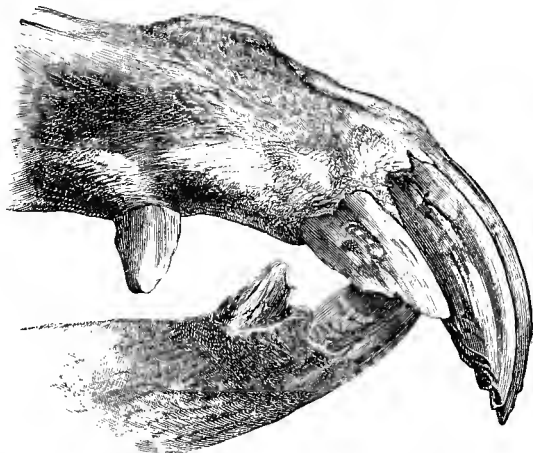

FIG. 84.—THE "PARROT-MOUTH" MALFORMATION OF THE HORSE'S MOUTH. (*Gamgee.*)

deeper, and with two diverging rows of papillæ, each containing from eleven to thirteen papillæ, at the base of the tongue.

In the horse the sensitive and mobile upper lip is the main organ in the collection of food. The nose, aided by the sense of touch, serves to indicate the substances suitable for food; the upper lip serves to carry the food between the incisor teeth, so that it may be firmly held, while by an active jerk and twisting motion of the head the grass is cut, hay pulled from the rick, or branches severed. In stalled animals loose food is taken from the manger by the lips, aided by the tongue. If the incisor teeth are badly formed, as in the projection of the upper incisor teeth over the lower, as in the malformation termed "parrot-mouth," grazing will be prevented (Fig. 84). So also swelling of the gums or of the palate, as in dentition, may act as a mechanical impediment to the action of the incisor teeth and prevent grazing (Fig. 85). The position assumed by



FIG. 85.—PREHENSILE EXTREMITY OF THE JAWS OF THE HORSE. (*Colin.*)

the grazing horse is characteristic. The fore legs are separated, one fore leg usually being advanced, or may be flexed, since the neck is not

long enough to reach the ground: the lips then carry the grass between the teeth. A horse cannot live on very bare pasture, since the grass must be long enough to be grasped by his prehensile upper lip; and he therefore cannot enter into competition with close-biting animals, such as sheep, since they will deprive a field of the best and youngest plants as fast as they come through the ground.

In the ox the tongue is the main organ of prehension of food, since the upper lip is short, has but slight power of motion, and is blended with the cartilaginous, solid muzzle, which is covered by a thick, secreting membrane. The tongue of the ox is, however, provided with great mobile power; it may project far from the mouth, and, curving like a sickle, the animal may seize and draw food into the mouth. It is rough, pointed, covered with recurved, sharply-pointed papillæ so as to strengthen its grasp on bodies with which it comes in contact. In grazing, the tongue is protruded, curved around the grass, which is thus drawn into the mouth and then cut by the pressure of the lower chisel-like incisors against the elastic pad which occupies the position of the upper incisors. The ox also is unable to feed on very short grass.

In the sheep and goat the upper lip has a certain degree of mobile power, more than that possessed by the ox, but not as great as that of the horse. It, however, is unable to grasp food, and merely aids the incisors and tongue in grazing. The tongue is also more freely movable than in the horse, and the combination of the mobile lip and prehensile tongue enables it to feed close to the ground. Here also the upper incisors are absent, and grass is cut by the pressure of the lower incisors against the cartilaginous elastic pad of the upper jaw.

The pig in its native state feeds by rooting out plants, roots, and nuts from the ground, and is provided with a strong and mobile snout, having a bony and cartilaginous basis, and moved by powerful muscles. It acts like a spade in digging up the ground, while the lower lip is short and pointed, and is enabled to gather food loosened by the digging action of the snout. The passing of a ring through the snout of a hog entirely destroys its natural methods of collecting food, and animals so treated are dependent upon artificial feeding, and if left to their own efforts would starve. Pigs are omnivorous, but yet their incisor teeth are so shaped as to prevent them from grazing.

Carnivorous animals, such as the dog and cat, feeding principally on meat and animal matters, fix their food with the forelegs, grasp it between their powerful jaws, using here mainly the canine teeth, and lacerate it by a backward jerk of the head. They are biting animals, and as a consequence their cheeks are loose and ample, their mouths open widely, and their teeth are pointed and curved back. The lower jaw only is used, and it is said that when the lower jaw is fixed carnivorous animals,

with the single doubtful exception of the dog, are unable to close the mouth.

2. **PREHENSION OF LIQUIDS.**—In the lower forms of animal life prehension of liquid is accomplished by absorption through the general external body surface, and in many cases, as, for instance, in the tape-worm, where neither mouth nor stomach are present, the fluids so absorbed carry also the nutritive matters in solution into its interior. Many other animals which live on liquid food are provided with special organs for absorption; thus, in the leech there is a mouth or sucker, provided with minute teeth for piercing the skin of other animals, while in the mosquito there is a sharp, bristle-like tube for piercing the skin, and in the louse there is a sharp sucker, armed with barbs to fix it securely during the act of sucking. In certain insects which live on viscid or fluid food, as the butterflies and moths, the mandibular appendages are modified from their usual form described in the preceding section, and take on the form of a long, spiral tube, the proboscis, which can be unfolded and protruded into flowers. A sucking proboscis also is found in many flies and gnats. In fleas and bugs the mandibles are penetrating and suetorial. In the higher animals no special prehensile organs for the absorption of liquids are present, it being accomplished by means of the apparatus already described for the prehension of solids. Four methods for the prehension of liquids have, however, been described by Colin:—

*a.* Suction, as in the drawing of milk by young animals.

*b.* Pumping, by the immersion of the lips and the piston-like action of the tongue within the mouth, on the principle of the common pump.

*c.* Aspiration, where the vacuum is produced by an inspiratory movement, as well as by the motion of the tongue.

*d.* By lapping or ladling the fluid by the tongue into the mouth.

*a. Suction.*—In suckling, the teat is grasped by the lips, or, it may be, even by the teeth, and the mouth closed around it. The tongue is then pressed against the teat and withdrawn into the mouth, producing a vacuum, and from the atmospheric pressure on the exterior of the breast the milk then enters the mouth. There is, therefore, no danger of milk entering the windpipe, since inspiration is not at all concerned in the process of suckling; hence, aquatic animals, like the cetaceans, may suckle under water. In solipedes and ruminants, during suckling, the tip of the tongue is often fixed between the teeth and the nipple; the vacuum is then made by the reduction in volume of the anterior part of the tongue, while the base becomes applied to the roof of the mouth.

During the act of suckling, the sterno-thyroid and the sterno-omo-, and thyro-hyoid muscles contract together, and so depress the larynx and hyoid bone, while at the same time the hyoid bone is advanced by



the contraction of the genio-hyoid muscle, the root of the tongue being, therefore, likewise depressed and drawn forward. At the same time the genio-glossi muscles, contracting with their antagonists, the hyo-glossi, have the effect of drawing the body of the tongue directly backward, while the organ itself becomes flattened. The cheek-muscles are entirely inactive in the act of suckling.

*b. Pumping.*—The process of drinking by means of pumping with the tongue is employed by the horse and ruminants and most herbivora. The lips are immersed below the surface of the water, which seldom or never rises above the level of the nose; a small space is opened between the lips, and the tongue is withdrawn in the mouth by a mechanism similar to that employed in suckling; the tongue thus acting as a piston, the pressure of the atmosphere on the water without serves to force it into the mouth, and it is then carried by a motion of deglutition to the pharynx and gullet.

That drinking in the horse is not due to the production of a vacuum in the month by inspiration has been proved by performing tracheotomy on a horse, when, of course, the production of a vacuum by inspiration would be impossible, and yet it was found that this operation did not interfere with suction and drinking. So also a case has been reported of a horse who was unable to drink, in whom, on examination, it was found that a second molar tooth of the upper jaw had been lost, and a fistulous tract led through to the nasal cavity. The tongue, therefore, was unable to produce a vacuum, even when the nose was immersed below the surface of the water, from the large nasal chambers and pharynx being in direct communication through the fistula with the fore part of the mouth. Here evidently was sufficient proof of the fact that drinking in these animals was not due to any inspiratory effort. In the case reported, plugging the fistula served to restore the power of drinking. Even without this proof, however, the anatomical relation between the mouth and pharynx in the horse is sufficient to show that in these animals breathing cannot occur through the mouth in drinking, or in any other natural action of the organs situated in the oral chamber; for the soft palate forms a complete partition between the mouth and the throat, and can only be elevated to allow the passage of fluid or solids backward by compression, such as that which occurs in swallowing.

*c. Aspiration.*—In this method of drinking the vacuum is produced by the respiratory apparatus; the mouth, then, is not entirely closed, and air is also drawn in, the water and air together causing a rushing sound, the palate is raised, and both the air and water enter the pharynx, the water being swallowed with a part of the air. This method of drinking is jerky, since it must be interrupted for respiration, as the nose may be immersed in water; and although it has been said to occur

in the pig, and often has been noticed in the horse, there is considerable reason for doubting that this is ever a normal method for the prehension of liquids.

*d. Lapping.*—This method of the prehension of liquids is seen in the carnivora, as in the dog and cat; since their mouths are relatively much larger than the herbivora, they cannot be immersed in water up to the commissure of the lips without also immersing the nose. Such animals, therefore, spoon up water with the tongue, like taking water to the mouth with the hand. The tongue is protruded, its tip rendered cup-shaped by the action of its intrinsic muscles, and a small amount of water lifted up and carried by the repeated protrusion and retraction of the tongue to the mouth. The process is a very slow one, and is seen only in carnivora.

Various other animals have different modes for the prehension of liquids. Thus, in the elephant the trunk is a combined force-pump and suction-pump. The trunk being immersed in water, by inspiratory efforts it is filled with fluid; the tip is then directed toward the mouth and the water is forced through it into the mouth. Birds drink by filling their lower beak with water, elevating their heads and allowing the water to flow back into their pharynx without the production of any motion of deglutition. The single exception to this manner of drinking seen in the birds is in the case of doves and pigeons.

### III. MASTICATION.

The term mastication is given to the purely mechanical operations by which the alimentary matters, through the action of jaws furnished with teeth, are comminuted in the mouth, and is, in most animals, a necessary preparation for the submission of food to the action of the gastric juice. Its importance and completeness differ in different animals, depending upon the nature of their food. Animals, such as the carnivora, which feed on readily digestible matters, do not need this preliminary preparation, and as a consequence the food of carnivora is swallowed in bulk without having been subjected to any, or, at best, to but slight division in the mouth. This applies also to all animals which feed on liquid or soft foods, where a masticatory apparatus is not needed. All animals which feed on grain and other vegetable matters require the process of mastication to render the food susceptible to the action of the digestive juices; for, as we have found in these animals, the food-constituents are inclosed in unyielding envelopes which resist the action of the digestive juices. To enable the nutritive matter to be released from these substances, such foods require mechanical subdivision before they can prove of nutritive value.

In the bird, which is not supplied with a masticatory apparatus as ordinarily understood,—that is, in whom mastication does not occur in the mouth,—we have a supplementary organ, the gizzard, which serves the same purpose in comminuting the food. In these animals, therefore, the operation of mastication is performed in the abdominal organs and is involuntary. Voluntary mastication performed in the month only occurs in mammals, and is seen in its typical form in the herbivora, in a less perfect degree in the carnivora, while the omnivora occupy a mean between the two.

Mastication is a complex act, and requires the action of active and passive organs; that is, the muscles of mastication, the jaws and teeth, while it is aided by the tongue, lips, and cheek. In all vertebrates the jaws move vertically, the nature and degree of the movement varying with the nature of the food. In the carnivora the lower jaw is alone usually movable, and its extent of motion is very much greater than in the herbivora. The lower jaw is moved by five muscles on each side, the temporal, the masseters, the two pterygoids, and digastric muscles, while in the solipedes the stylo-maxillary muscle constitutes an auxiliary muscle of mastication. The action which a muscle exerts is dependent not only on the bulk of the muscle, but on the angle of insertion of the muscle in the bone. The more acute the angle, and the nearer the point of insertion to the articulation, the more extensive will be the excursion of the movable part in the contraction of the muscle, and the greater will be its velocity of movement. The more perpendicular the insertion of the muscle, and the greater the distance between the point of insertion and the articulation, the greater will be the power developed in the contraction of the muscle. The latter is the arrangement which generally characterizes the muscles of mastication; they are inserted perpendicularly in the lower jaw, and at a considerable distance from the maxillary articulation. The arrangement of the parts and the motions in mastication differ in different animals.

In the carnivora the articulation of the lower with the upper jaw is by a transverse condyle fitting into a canal-like groove in the temporal bone, the canine teeth and molars overlap, and, the lower jaw being narrower than the upper, the only motion therefore possible is a simple up and down movement (Figs. 86 and 87).

In herbivora the articulation of the lower with the upper jaw is above the level of the molar teeth, and permits of a forward, backward, and lateral, as well as an up and down, motion. Three distinct types of herbivora, with reference to their mode of mastication, may be recognized.

*First*, the rodents, which have only two kinds of teeth, two highly developed incisors in each jaw; the canine teeth are absent, while the molars, which are compound teeth, have a flat crown and transverse rows of

enamel. The temporal fossæ are small, their zygomatic arches are slight, and the maxillary condyle, instead of being transverse, as in the carnivora, is antero-posterior, and articulates with the glenoid cavity in the same direction, the articulating surface in these animals being a sort of canal or gutter running from before backward (Figs. 88 and 89). The arrangement of the articulation of the upper and lower jaw, as well as the mode of insertion of the muscles, favor a backward

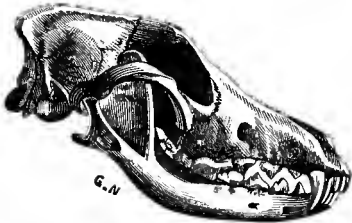

FIG. 86.—HEAD OF CARNIVORA—DOG. (Béclard.)

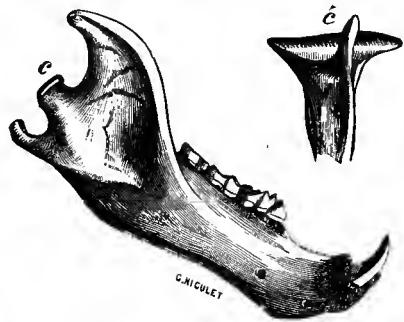

FIG. 87.—INFERIOR MAXILLARY BONE OF CARNIVORA—POLAR BEAR. (Béclard.)  
c, profile view of articular condyle of lower jaw (condyle of right side); c', front view of same condyle.

and forward motion of the lower jaw, which is, therefore, the characteristic motion of rodents.

*Second.*—In the ruminants the jaws are long and feeble, the canine and upper incisor teeth are absent, while the molars are compound teeth with a flat crown, with the enamel arranged in antero-posterior layers. The condyle of the lower jaw articulates with a plane or almost convex glenoid surface of the temporal bone, and this mode of articulation,

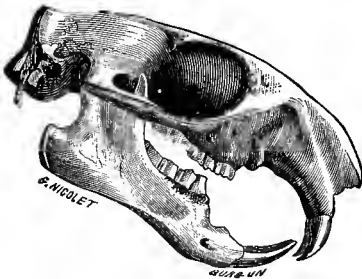

FIG. 88.—HEAD OF RODENT—MARMOT. (Béclard.)

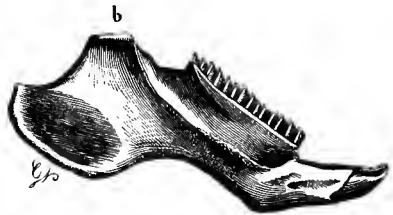

FIG. 89.—INFERIOR MAXILLARY BONE OF RODENT—CAPYBARA. (Béclard.)  
b, right articular condyle of lower jaw.

together again with the arrangement of muscles, permits of a rotatory motion of the lower jaw, which is therefore a characteristic trait in the mastication of the ruminants (Figs. 90 and 91).

*Third.*—In the solipedes and pachydermata three kinds of teeth are present, and both of the above kinds of movement; that is, rotation and

forward and backward motions are possible, but are not present in as great a degree in this case as in the two preceding types of herbivora. These animals, therefore, occupy a mean between the rodents and ruminants (Fig. 92).

1. THE MOVEMENTS OF THE JAWS.—The mouth is opened by depression of the lower jaw, which is effected in all animals by the digastric muscles, aided, in the horse, by the stylo-maxillary muscle, which is in reality a short branch of the former. The lower jaw is depressed very largely by gravity; hence, in all animals we find such a slight muscular power acting as depressor of the lower jaw as contrasted with the large number of powerful muscles which produce its elevation. When the mouth is opened the maxillary condyle turns on its axis and its posterior part, which, when the jaws are closed, is in contact, as in the horse, with the subcondyloid apophysis, leaves this surface and moves anteriorly. In carnivorous animals the condyle being fixed in a gutter-like glenoid cavity, rotation on its axis is the only motion which is noticed.

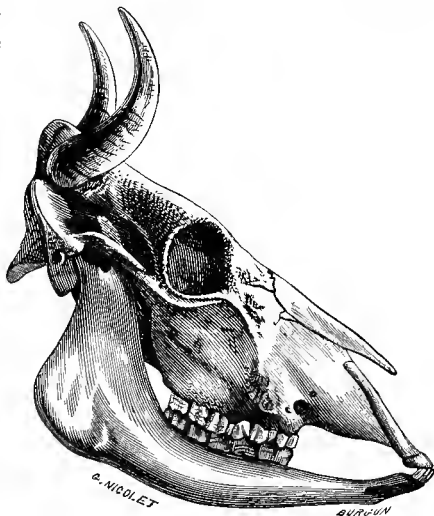

FIG. 90.—HEAD OF HORNED RUMINANT—OX. (Béclard.)

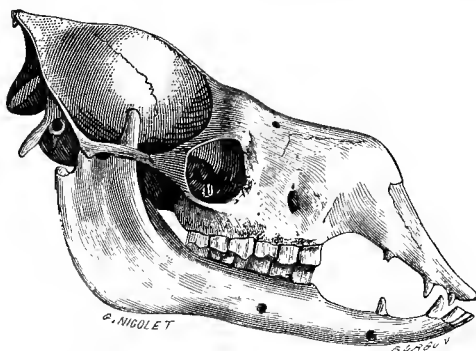

FIG. 91.—HEAD OF HORNLESS RUMINANT—CAMEL. (Béclard.)

In all animals the finger placed below the zygomatic fossa will distinguish the forward and backward motion of the coronary process as the mouth is opened and closed. In carnivora the extent to which

the lower jaw may be depressed is very much greater than in the herbivora; in the latter, as in the horse, eight to ten centimeters being the extent of separation of the lower from the upper incisors. The digastric muscle is comparatively feeble, and would appear to pull the jaw back, but really it tends to advance it, since it is a lever of the third class. In the hare, rabbit, and ox the digastric muscle has only one belly, and in the ox is joined to the same muscle of the opposite side by transverse muscular fibres; in the dog there is no intermediary tendon in the digastric muscle. The development of the digastric depends upon the character of the food of animals. In the horse, sheep, and ox, where it is small, it is a double muscle, and is inserted more anteriorly in the lower jaw than in carnivorous animals, where it is large. The conditions, therefore, are most favorable for its action in herbivora on account of its different insertion. This muscle antagonizes the temporals, masseters, and pterygoid muscles.

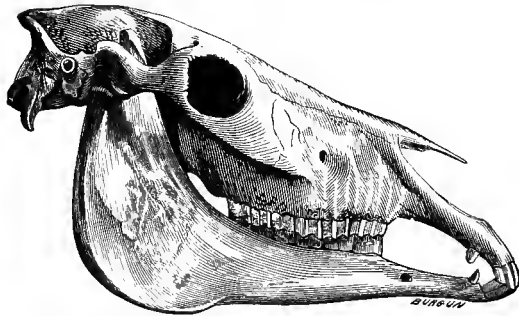

FIG. 92.—HEAD OF SOLIPEDE—HORSE. (Béclard.)

The representative of the digastric in the lower vertebrates, as in reptilia, according to Mr. G. E. Dobson, is a bundle of muscular fibres arising from the occiput and inserted into the posterior extremity of the mandibular ramus, its functions being simply those of drawing the angle of the mandible backward and upward, and so separating the jaws in front. This is also its form and function in birds and most mammals, though in man, monkeys, and rodents the muscle is made up of two bellies with an intermediate tendon, which is often connected by ligament with the hyoid bone. Mr. Dobson has traced an interesting connection between the mode of feeding and the type of the digastric muscle. In the group of animals in which this muscle is connected with the hyoid bone, the species swallow their food while in the erect position, with the head bent forward on the chest and the long axis of the cavity of the mouth at right angles with the œsophagus; in the other this muscle is free, and all the species feed while resting on their

anterior extremities, having the long axis of the mouth in a line with the œsophagus. Thus, among certain rodents and arboreal insectivora, which habitually sit erect while feeding, holding their food between their fore feet, the anterior bellies of the digastrics are large and united, and the intermediate tendons well developed and connected by fascial bands with the hyoid bone, and by their deep surfaces with the mylo-hyoid muscles, as in the rat and the common dormouse. In the water-voile (*Arvicola amphibius*), however, the digastrics are connected together in front by fascia alone, and the upper margin only of their middle part is tendinous, and not connected with the hyoid bone. These animals live on vegetable substances obtained while swimming, and habitually hold the head stretched out in a line with the body.

The mouth is closed by elevation of the lower jaw, and is the reversal of the previous motion. Here powerful muscular action is required, since in the closure of the jaws, in many cases, great force is needed. It is accomplished by the temporals, the masseter, and pterygoid muscles. In carnivora the temporal is the principal elevator of the lower jaw. Its volume is proportionately enormous, the temporal fossæ occupying the entire surface of the parietal bones back to the occipital spine. In herbivora and rodents the masseter muscles are the most highly developed; their origin being from the zygomatic arch and a portion of the superior maxillary bone, and being inserted in the lower jaw, in the solipedes on both faces of the coronoid processes, as far back as the last molars. Both of these muscles act as levers of the third class, as is very evident in the rabbit, where the coronoid processes are much lower than the articulation of the lower and upper jaw. In the carnivora, the coronoid processes being separated by a considerable space from the condyle, the conditions are most favorable for the action of the temporal muscle. From the oblique direction of its fibres it tends to produce drawing back of the lower jaw, where, as in the herbivora, this is possible.

The masseter muscle is developed in inverse proportion to the temporal. It is, therefore, the principal elevator of the jaw in the herbivora and in the rodents. It rises from the zygomatic spine in solipedes, the maxillary tubercle in ruminants, to be inserted in the lower jaw. It is also a lever of the third class; its fibres are directed backward and downward in the herbivora, and it may serve, therefore, as in the rodents, to assist in the forward motion of the lower jaw; its greatest power is developed when the resistance to the elevation of the lower jaw is between the molar teeth, while its origin, being on a plane external to its insertion in the lower jaw, as in the horse and rabbit, it may aid in lateral motion of the jaw in animals where this motion is not rendered impossible by the mode of articulation of the jaws, or by the overlapping of the teeth.

The pterygoid muscles, especially the internal, which is usually the largest, are also elevators of the lower jaw, and are most developed in herbivorous animals; they are also levers of the third class, and are, to a certain extent, concerned in the production of lateral and antero-posterior motion of the lower jaw in animals where these motions are possible. Propulsion of the lower jaw, or antero-posterior motion, is most marked in the rodents, although it is also present to a less degree in solipedes and ruminants, but is impossible in carnivora on account of the shape of the articulation of the jaws. In this motion the maxillary condyles slide forward on the glenoid fossæ of the temporal bone in animals where there may be a subcondyloid apophysis posteriorly and no restricting surface anteriorly. This motion is quite marked in the pig, which has a triangular condyle, but attains its maximum development in the rodent. This motion is accomplished by means of the masseter muscle, aided by the external pterygoids; for in the rodents, and in a less degree in ruminants, the origin of the most posterior fibres of the masseter muscle are in advance of their insertion in the lower jaw. This obliquity in direction of the masseter fibres, in contraction of this muscle, therefore serves to move the jaw forward.

The retraction of the lower jaw, which of course occurs only in animals in which forward motion is possible, is accomplished by means of the temporal muscle, the digastric being not concerned in the process, since backward motion of the jaws only occurs in closing the mouth, while the digastric in its contraction opens the mouth and even tends to advance the lower jaw somewhat.

Lateral movement of the lower jaws is more or less pronounced in all herbivora, but is most marked in the ruminants; it never occurs in the carnivora, as already explained, on account of the shape of the condyles and overlapping molars, and the crossing of the canine teeth. The lateral motion of the lower jaw is not a simple lateral displacement parallel to the axis of the lower jaw; that is, it is not equal at both extremities of the jaw, but is an angular deviation very marked at the incisor teeth, and is a rotation of the lower jaw around one condyle of the inferior maxillary bone, the incisor teeth describing an arc of a circle, whose centre is one condyle, which thus moves very little, while the opposite condyle advances and partly leaves the articular surface, as may be determined by placing the finger in the temporal fossa, when the coronoid process on the side opposite to that toward which rotation is taking place may be felt to move forward. In this lateral motion of the lower jaw the axes of the molar teeth cease to be parallel, the incisor arch passing one-third to one-half its extent to one side of the upper arch or pad which represents it in the ruminants; the molar teeth of the upper and lower jaw are in contact on the side toward which rotation is occurring,



while they cease to correspond on the opposite side. It is, therefore, to a certain extent, a circular motion, in which the axis of the lower jaw crosses that of the upper. A further peculiarity of this lateral motion of the lower jaw is that it is alternative; that is, there is not a deviation first to the right and then to the left, but if the motion is first a deviation to the right in the process of mastication it returns again to its central position and again rotates to the right. This may occur for half an hour or more in solipedes, and in ruminants in both first mastication and in rumination; then the motion may be reversed, and may occur as a left lateral deviation for a similar length of time. The camel is the only animal which furnishes an exception to this method of mastication. In it the lateral motion is alternative; the deviation occurring first to the right and then to the left of the central position. In solipedes this motion is apparently not as marked as in the ruminants, but this difference is merely apparent, it being to a certain extent concealed by the long lips of these animals. It is, therefore, more evident but not actually greater in the ruminants than in solipedes. Lateral motion of the lower jaw is produced by alternate contractions of the pterygoids, especially the internal, the external being very small in ruminants, and by the masseters; when the deviation occurs to the right the motion is produced by contraction of the right masseter and left internal pterygoid muscles. When the deviation occurs to the left it is produced by contractions of the left masseter and right internal pterygoids, the action of the pterygoids being more marked in ruminants than in solipedes from the fact that in the former animals the palatine ridges are nearer together; therefore, the lateral power of the pterygoid muscles is more marked.

2. THE ACTION OF THE TEETH IN MASTICATION.—The teeth are passive organs of mastication, which are imbedded in the alveoli of the jaws. Teeth may be divided into three different parts: the crown, or the part which projects into the mouth above the gum; the neck of the tooth, where it passes through the gum; and the root, which is imbedded in the alveolus. Teeth may be of two different kinds,—either simple, where the entire external surface of the tooth is covered by enamel; or compound, where two different substances, enamel and dentine, compose the free surface. When a tooth is divided longitudinally it is found to consist of three different substances; the hardest, and that which in simple teeth covers the crown, is termed the enamel, and passes over the neck of the tooth, becoming gradually thinner, and only partially covering the fang. The enamel (Fig. 93) is composed of pentagonal or hexagonal prisms, or enamel fibres, of about one five-thousandth of an inch in diameter, closely packed together and arranged in a radiating manner from the surface of dentine below. The enamel contains no nutrient vessels, and when destroyed is not renewed. The bulk of both crown and fang of

a tooth is constituted of what is known as dentine, a section of which reveals it to be formed of a densely packed mass of curving tubes with distinct walls, imbedded in a dense, bone-like matrix, which run from the pulp-cavity to the outer surface of the dentine near which they ramify. The material between the tubules or the matrix of the dentine is a perfectly homogeneous substance, containing nearly the whole of the earthy matter contained in the tooth, arranged in all animals in superimposed layers. The tubules are the one four-thousandth of an inch in diameter, and when fresh contain nerve and vascular processes from the pulp. The third substance found in teeth is known as the cement, or *crusta petrosa*, and in the simple tooth merely covers the fang, whereas it dips in between the layers of enamel in compound teeth on the crown, and when the tooth is wholly inclosed within its cavity also covers the crown (Fig. 94). In carnivora the teeth, as already remarked, are simple; in other words, their crowns are permanently covered with enamel, and when in extremely old subjects the incisor

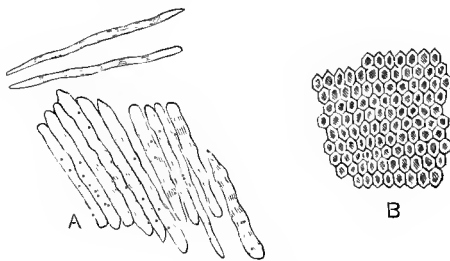

FIG. 93.—ENAMEL PRISMS, AFTER KÖLLIKER.

(Klein.)

A, in longitudinal view; B, in cross-section.

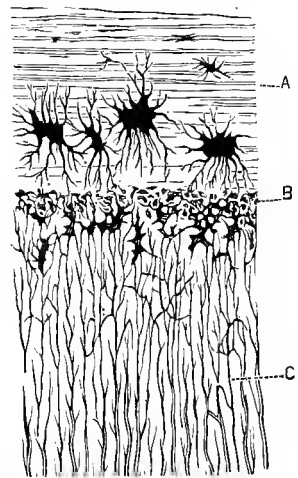

FIG. 94.—SECTION THROUGH A CANINE TOOTH OF MAN, AFTER WALDEYER. (Klein.)

A, crista petrosa, with large bone-corporules; B, interglobular substance; C, dentinal tubules.

teeth and canine teeth wear down,—then only does the dentine of the teeth become exposed. In herbivora compound teeth are invariably met with. In other words, on the free surface of the teeth of herbivora different substances of varying degrees of density and hardness are always met with, the function of which is to insure a constantly rough surface for the purposes of grinding; for a good mill-stone is composed of materials which wear with different degrees of rapidity, and thus, always remaining rough, most effectually grinds the substances over which it passes. In the compound tooth, as found in the herbivora, the cement has originally covered the entire crown, but as the tooth is erupted simply remains on the biting or grinding surface of the tooth. Thus, in the

incisors of a horse, the free surface, with the exception of the crown, is covered with enamel alone (Figs. 95 and 96). On the biting surface of the incisor tooth, when freshly erupted, is always found a central spot composed of cement, the enamel dipping in to form a cavity or depression on the free biting surface of these teeth. By the change in shape

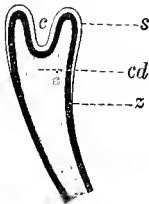

FIG. 95.—DIAGRAM OF FRESHLY-ERUPTED INCISOR OF LOWER JAW OF HORSE. (Nuhn.)

*c*, depression in table of tooth; *z*, cement, which rapidly disappears except from infundibulum; *z*, enamel; *cd*, dentine.

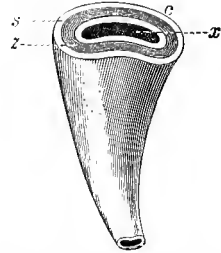

FIG. 96.—LOWER INCISOR TOOTH OF HORSE. (Nuhn.)

*c*, worn-down surface of table of tooth, showing the alternate layers of enamel, *s*; *z*, dentine; and *x*, discolored cement filling infundibulum.

of this central depression in the incisor teeth of the horse, through the gradual wearing down of the surface, an index is furnished of the age of the horse,—a matter which will subsequently be alluded to.

The molar teeth of herbivorous animals are chiefly compound teeth,—that is, the enamel dips down below the surface of the crown, and in some animals, as in the elephant, the compound teeth may be regarded as a series

of flattened teeth arranged side by side in the jaw, and connected only by the cement, or *crusta petrosa* (Figs. 97 and 98). This substance is like that invariably found covering the fangs of teeth, but which only in compound teeth appears upon the crown. The pointed fang or fangs of teeth are pierced by an opening which communicates with a cavity in the centre of the body of the tooth, called the pulp-cavity, which contains blood-vessels and nerves which enter through the opening in the fang, and in the pulp-cavity ramify over a delicate fibro-cellular structure constituting the pulp (Fig. 99).

The pulp is continuous over its surface with an infinite number of small projections which extend into the tubes of dentine in the inner structure of the tooth.

These three different substances, which constitute the substances of

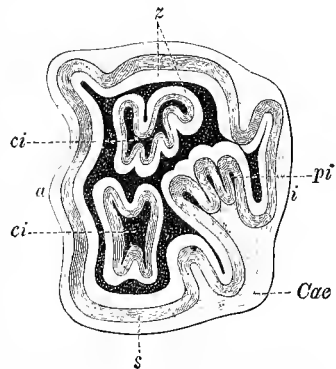

FIG. 97.—SECOND UPPER MOLAR OF HORSE, SHOWING WEAR OF TABLE. (Nuhn.)

*ci*, depression on table; *pi*, depression on side; *s*, enamel; *z*, dentine; *Cae*, cement; *a*, external or buccal surface; *i*, internal or oral surface.

the teeth, vary in their chemical composition, and, as a consequence, in their different degrees of hardness, dependent upon the varying amount of inorganic matter found within them, thus :—

	Dentine.	Enamel.	Cement.
Organic matter, . . .	28.01	3.59	32.24
Inorganic matter, . . .	71.99	96.41	67.76

The sharp angles and prominences on the crown of the compound tooth are formed of enamel, as is the entire free surface of the simple tooth. The deeper hollows in the crown of compound teeth are formed by the wearing of the cement, while the substances varying in hardness between these two are formed by the dentine. The fang of the tooth, where inserted in the alveolus, is further covered by a membranous lining, the periosteum, which is soft and contains vessels and nerves, and which is reflected into the pulp-cavity through the opening in the fang of the tooth. When ossified, this membrane forms osteo-dentine.

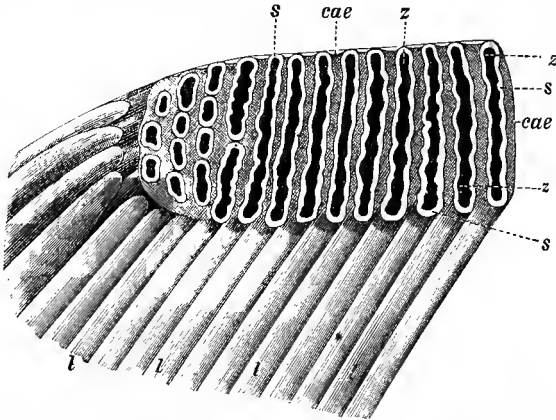

FIG. 98.—HALF OF A FOSSIL TOOTH OF ELEPHANT (*Dens lamellosus*). (Nuhn.)  
*l*, the single segments, or secondary teeth; *s*, enamel; *z*, dentine; *cae*, cement.

Teeth are entirely absent in birds, but are generally present in fishes, amphibia, reptiles, and mammalia. In the latter class alone are two sets of teeth met with: the first, the deciduous or milk-teeth, which are only temporary, fall out and give place to the permanent teeth. With the exception of a few fishes, such as the sheep's-head, and certain herbivorous reptiles, the teeth in fishes, amphibia, and reptiles as a class, are solely prehensile; they serve simply for seizing and dividing their prey into portions small enough to be swallowed. It is only in the mammals that the teeth serve actually as organs of mastication.

The teeth of fishes present greater varieties than those found in any other class. They may be almost innumerable or they may be reduced to a single tooth, as in the lepidosiren, which has only a single dental plate

in each jaw and a small tooth on the nasal bones; or, in many fishes, as in the sturgeon and amphioxus, they may be entirely absent. Their shape is also subject to great variation. In the lowest forms of fish they are short and blunt, and well fitted for grinding sea-weed and crushing shell-fish; such teeth are seen in the ray-fish. But in most fish the teeth are

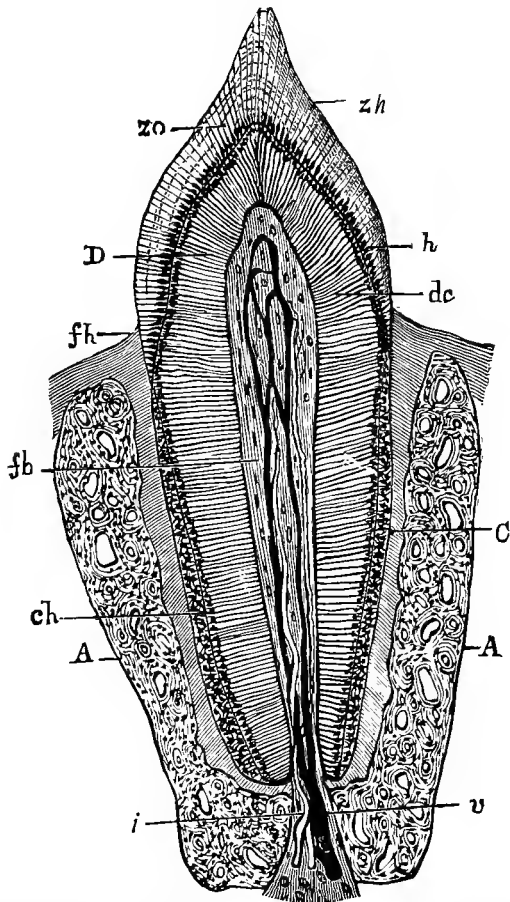

FIG. 99.—DIAGRAM OF PREMOLAR TOOTH OF CAT, WITH ALVEOLUS, AFTER WALDEYER (MAGNIFIED THIRTY DIAMETERS). (*Thunhoffer.*)

A, bony wall of alveolus; zo, enamel prisms; zh, enamel coating; h, spaces in the base of the enamel prisms; D, dentine; dc, dentinal tubules; fh, gum, with alveolar periosteum below it; C, cement; ch, cement spaces; fb, tooth-pulp; i, nerve entering pulp; and v, pulp blood-vessels.

usually small and conical, generally cylindrical, but sometimes flattened, straight, curved, bent sidewise, or even barbed; or their edge may be serrated, as in sharks generally; or the base may be broader than the apex, as in the sharks. The teeth of fishes are by no means limited to the free

maxillary and free mandibular bones, or the lower and upper jaws. In some fishes, as in the carp, all the teeth are in the back of the mouth, while in most fishes there are teeth not only on the maxillary and mandibular bones, but also on the bones around the middle part of the mouth; even, sometimes, being found on the median line of the palate. In certain cartilaginous fishes the teeth depart from the usual rule, in consequence of which they are mostly inclosed in the bone on which they rest, but are attached by ligaments, so as to allow the teeth to be bent backward in the mouth by pressure. In most fishes the enamel and cement substances are absent, the body of the teeth being composed simply of dentine, which on its external surface is more compact than when found in mammals. The teeth of fishes are, as a rule, replaced several times during life, especially in the cartilaginous fishes.

In amphibia, fine, prehensile teeth are found on the upper jaw and palate-bones of the frogs and salamanders; more seldom on the lower jaw also. In toads only palatal teeth are present.

In reptiles the jaws may be either covered with a thick, dense horn, which assists in dividing the food, or they may exhibit the most perfect dentition, as in the saurians.

The number of teeth is always very large, and while in crocodiles and many lizards they are limited to the jaw-bones, they also exist on the pterygoid or palatine bones, and on the roof of the mouth of most ophidians. The typical form of the teeth of reptiles is conical, and they vary greatly in size, from the minute tooth of the blind-worm to the powerful canine-like teeth of the crocodile. They are sometimes cylindrical, but may be flattened, or even have serrated margins. Their surface is smooth, or is notched. In serpents they are relatively longest, and present a remarkable structure in the case of the poison-teeth or fangs, which are strongly curved and contain a canal opening at both ends of the tooth: on the anterior or convex aspect of the teeth above, close to the gums, and below on the concave surface, a short distance from the point of the tooth. These teeth are usually confined to the upper jaw, and the canal serves to convey the secretion of the poison-glands, by the duct, to the substances in which the tooth is imbedded, the poison being forced out by muscles which join the gland-capsule and compress the gland. The poison-fangs are fixed to the superior maxillary bones, but, since these in poisonous serpents are movable, the teeth can when at rest either lie flat upon the gum, or they can be brought into a vertical position in the act of striking. Reptilian teeth always contain dentine and cement, and sometimes, also, enamel and true bone, the dentine differing slightly from that of mammals, its substance being traversed by canals which communicate with the pulp-cavity. As the teeth of the reptile wear away they fall out, and are replaced by an almost unlimited succession of new ones.

In birds teeth are never present as organs of mastication, their place being taken by the muscular gizzard; but the horny coating of the jaws is developed in successive laminae, especially seen in the parrot, which forms the beak, and which serves, in the prehension of food, the same purpose as the prehensile tooth of other animals.

In the mammal the greatest variety is met with in the number, the shape, and external characteristics of teeth. They may vary in number from one in the narwhal to as many as one hundred and ninety in the dolphins. In the elephant there are at most ten, but usually only six, namely, one entire molar, or sometimes parts of two on each side of both jaws, together with the two tusks of the upper jaw. In the rodents the ordinary number is twenty, but there are sometimes only twelve, while in the hare and rabbit there are twenty-eight. In ruminants and commonly among the mammalia there are thirty-two; but forty-four (as in the hog and mole) is said by Owen to be the typical number. When more than forty-four teeth are present, as is occasionally the case in the lowest groups, they are of the reptilian type, as in the porpoise.

Three kinds of teeth, as already mentioned, are met with: the incisors, which are chisel-shaped for cutting and gnawing; the canines, which are longer and conical for tearing food; and the premolars and molars, which are variously cusped and tuberculated, and either flattened at the sides for cutting or broad at the summits for grinding. The incisors are smallest in the insectivora, larger in the carnivora, of great strength in the herbivora, and especially strong in the rodents. These vary in number: the lion has six in each jaw; the squirrel two highly-developed incisors in each jaw; the ruminants none in the upper jaw; the elephant none in the lower jaw; while the sloth has none at all. The canine teeth are prominent, conical, and larger than the other teeth in the dog and eat tribes; but not so in man. They are also large in many non-carnivorous animals, as in the ape, bear, musk-deer, and others where they are used as weapons of offense and defense. There are never more than four, and are wanting in rodents and most herbivora. The carnivorous molars are generally flat, ridged, or tuberculated, the anterior ones being, as a rule, very small; they overlap like the blades of a scissors, and are, therefore, cutting and not grinding teeth in these animals. The more purely carnivorous the species, the fewer the number of molars. The herbivorous molars are provided with tubercles, as in the quadrumana, man, and most omnivora, or are marked with transverse ridges of enamel and dentine in the ruminants, solipedes, pachydermata, and rodents. The premolar teeth are preceded by milk-teeth; the true molars have no predecessors. In mammals the teeth are confined to the jaw-bones, fit closely in the sockets, may have one or more

fangs, each of which has its own socket lined with periosteum. Mammals have, as a rule, two sets of teeth,—the deciduous and permanent teeth; and when the latter are worn down they usually loosen and fall out, since they undergo little or no repair. An exception to this statement is found in the case of the rodents, where the teeth continue to grow from the fact that the fang remains open and the hollow at the base into which the pulp extends—the so-called enamel organ—is persistent, and fresh dentine is constantly being formed within the pulp and fresh enamel upon the anterior surface. The unequal wear of the hard coating of the enamel in front and the dentine behind preserves throughout the whole life of the tooth its chisel-like edge. In many animals sex exercises a remarkable influence on the development of the teeth. Thus, in the anthropoid apes the upper canine teeth in the male are more than twice the size of the analogous teeth in the female; while the tusks of the bear and of the male elephant and musk-deer are larger than those of the female. So also in the solipedes the canine teeth are absent in the female, while in the ox tribe, although temporary incisors appear above the gum in both jaws, the permanent incisors are not developed in the upper jaw, but remain in a rudimentary condition within the bone.

By the formula of dentition, or the dental formula, is meant the convenient method of reproducing in numerals the number and nature of teeth found in different animals. To distinguish these teeth the letter *i* is used to indicate the incisors, the letter *c* the canines, *pm* the premolars, and *m* the molars. The upper rows of figures represent the teeth of the upper jaw and the lower those of the inferior jaw, the formula usually simply representing the teeth on one side of the mouth; doubling the numbers given therefore represents the total amount of teeth. In the dog the formula is as follows:—

$$2\left(\frac{3}{3}i + \frac{1}{1}c + \frac{3}{3}pm + \frac{3}{4}m\right) = 42.$$

That of the cat is:—

$$2\left(\frac{3}{3}i + \frac{1}{1}c + \frac{3}{2}pm + \frac{1}{1}m\right) = 30.$$

Man:—

$$i \frac{2-2}{2-2}; c \frac{1-1}{1-1}; pm \frac{2-2}{2-2}; m \frac{3-3}{3-3}; = 32.$$

In herbivora the incisor teeth vary in importance in our grass-feeding animals, and are absent in the upper jaw of ruminants, where their place is occupied by the fibro-elastic pad already referred to. Ruminants have thirty-two teeth,—eight incisors and twenty-four molars. In the horse there are two pairs of tusks, or canine teeth, and twelve large



molars in the upper and lower jaws. In front of the molar teeth there are sometimes rudimentary teeth, which are called wolf-teeth. In the horse the molar teeth have their grooves produced by the cement arranged longitudinally on the crown. In the stallion there are twelve incisors,—six in each jaw, of which the upper are the longest, while the central are the largest and the corner teeth the smallest,—four canine teeth, and twenty-four molars; in all forty. In the mare there are thirty-six teeth, the canine teeth being wanting. The free surface of the incisor teeth, with the exception of the table, is covered with enamel, while the fang is covered with cement. As the incisor tooth comes through the jaw the cement which originally covered the entire body of the tooth remains on the table of the tooth in a depression which is called the infundibulum. As the enamel of the table of the tooth wears away around this central infundibulum the dentine of the body of the tooth within is gradually exposed. We, therefore, have three different substances composing the table of the incisor teeth of the horse (see Figs. 95 and 96),—the outer ring of enamel; within that, concentrically, the exposed dentine; and within that again the more or less triangular ring of enamel which composed originally the wall of the infundibulum, and which was continuous with the enamel covering the crown of the tooth. Within this, again, is a more or less circular or triangular portion of cement by which the infundibulum was originally filled. Occasionally in front of the infundibulum a still denser substance than the dentine will be met with, which is called osteodentine, and which is due to the exposure of the ossified covering of the pulp-sac. This is also called the dental star. Two sets of teeth are found in the horse, of which the first, or milk-teeth, are wider and have distinct necks, are convex and are grooved posteriorly. The incisors at first are almost perpendicular, but become more and more horizontal as the teeth wear down; the lower permanent incisors have one groove, the upper two.

In ruminants thirty-two teeth are met with, the incisors being found only in the lower jaw. Eight incisors and twenty-four molars are met with. The incisor teeth in the ruminant are always somewhat loose, their table is always inclined, and the anterior border sharp (Fig. 100). The molars are compound teeth which wear down and continue to grow even to an advanced age of the animal. The inferior molars have their tables inclining outwardly, the upper incline inwardly, while, as in the solipedes, the molars of both sides cannot be in apposition at the same time, since



FIG. 100.—INCISOR TOOTH OF RUMINANT. (*Nuhn.*)  
s, enamel; z, dentine; cd, pulp-cavity.

the molar arches of the upper jaw are wider apart than those of the lower jaw: and when the molars are in contact the incisors do not touch, thus saving unnecessary wearing.

In the omnivora, as represented by the hog, there are forty-four teeth,—twelve incisors, four canine or eye teeth, twenty-four grinders, and four so-called wolf-teeth.

In the carnivora three kinds of teeth are met with. They are the incisors, which are twelve in number, are sharp and cutting, and when first erupted have three cusps on their free extremity, the lateral cusps being on a lower plane than the central cusp. They thus, therefore, resemble a *fleur-de-lis*. In carnivorous animals the two central incisors are smaller than the next two, and these smaller than the next teeth. The canine teeth are four in number, two in each jaw, and attain considerable length, being larger in the upper jaw than in the lower, are pointed and curved backward. The molars are variable in number, augmented in volume from the first to the penultimate, which has large cusps and is termed the *dens sectorius*. The teeth of carnivorous animals, with the exception of the incisors, preserve their pointed form unaltered.

In the dog the first three molars of the upper jaw do not come in contact with the first four molars of the lower jaw, which correspond to them, even when the mouth is closed. The highest cusp of the *dens sectorius*, however, rests on the posterior surface of the first tuberculated molar of the upper jaw. The incisors are cutting teeth, the canines tearing, and the molars crushing or cutting, like scissors, but not grinding in function.

The character and shape of the teeth vary in the different members of the carnivorous group; in the bear, which is essentially in type carnivorous, but which is an omnivorous animal, the molars are less pointed than those of the pure carnivora, and approach in nature the shape of the teeth of omnivora, of which man may be taken as a type. In the cat tribe all the teeth are very pointed.

The teeth are mechanical instruments without sensation, but serve as conducting organs of sensibility, like the hair; since in man they are sensitive to cold, therefore they are also probably sensitive in other animals. They transmit sensations of resistance, which must be less acute in animals, such as the carnivora, which are accustomed to crush bones, and thus convey information as to the solidity of matters between the teeth and regulate the degree of muscular effort required in mastication. The articulation of the teeth with the alveoli is in the form of a pyramid whose base is external. In mastication, therefore, pressure is transmitted to the bony walls of the alveoli, and the sensitive pulp is protected, unless the teeth are loose in their sockets, when mastication becomes painful.

## TO DETERMINE THE AGE OF THE DOMESTIC ANIMALS BY THE TEETH.\*

It is chiefly by the incisor teeth that we can tell how old a horse is, and it is important to consider the change in shape and general appearance which these teeth undergo. There are temporary and permanent incisors. The first have a broad crown, flattened somewhat from before back, with a wearing surface far wider from side to side than from behind forward. They have a distinct neck, and a narrow, sharp fang. The appearance of the temporary teeth is shelly, and there is a well-marked depression or infundibulum on the upper aspect. The front of the tooth is of a pearly white, and is grooved or fluted. The permanent incisor is much larger than the temporary tooth; its crown thicker, of a duller color, and the cavity or infundibulum is deeper. The neck of the tooth is not so well defined, and as the animal acquires age we find a very remarkable change in the shape. This is seen in Fig. 101, B, which represents different sections of the permanent incisor, as its surface appears from progressive wear. It is from birth to the age of eight years that from the condition of the "marks" or dark cavities in the table of the incisors we can determine the age of the horse. *There are, however, deceptive cases.*

The molar teeth are rarely looked at in determining the age of the horse, but they furnish valuable corroborative evidence, especially in young animals. They are not easily examined, but it is their number which in the colt confirms or negatives the opinion expressed as to the animal's age. The recently-formed molar has a shelly character (Fig. 101, C) and prominent tubercles of enamel, which soon wear down to form a broad, grinding surface, and then the young and old teeth are not easily distinguished.

The horse has six incisors above and six below. They are compound teeth, as shown in Fig. 101 at A, and the cavity extends downward, having beyond and a little in front of it the pulp-cavity, which in old horses as the teeth wear down is indicated by a dark, hard structure, which then fills it, and which is called osteodentine.

The temporary incisors are in perfect apposition as the colt approaches two years, and not seldom an animal, especially a pony, has been bought for five years of age from the temporary teeth being mistaken for the permanent incisors. The temporary incisor is gradually displaced by pressure from the permanent. The latter advances, and has a shelly aspect, seen in *a*, Fig. 101, at B. At *b* the incisor tooth indicates two years' wear; at *c* five years', at *d* nine years', and at *e* about

\*This chapter is taken from Gamgee, "Our Domestic Animals in Health and in Disease."

seventeen years' friction.

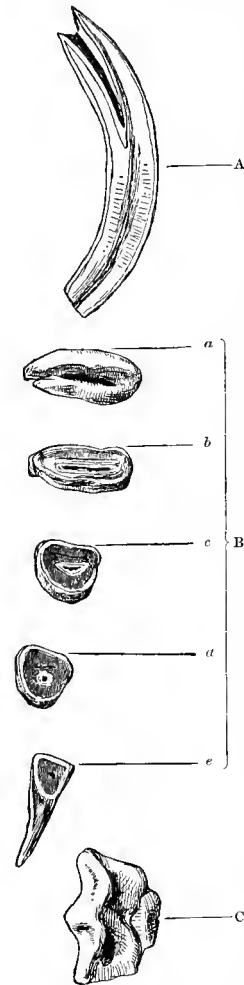

FIG. 101.—TEETH OF HORSE. (*Gamgee.*)

A. Longitudinal section of permanent incisor of horse shortly after eruption.

B. Transverse sections of permanent incisor of horse, showing the way the table becomes triangular from wear. *a*, on eruption; *b*, at two years; *c*, at five years; *d*, at nine years; *e*, at about seventeen years of age.

C. Table of molar tooth of horse, showing longitudinal arrangement of cement in grooves.

The shape of the wearing surface of the tooth is of great importance in determining approximately the age of the horse. Before eight years the eruptive changes and periodic appearances of the teeth are very regular and valuable in indicating age. The foal at birth indicates the fast approaching eruption of the two central incisors. Sometimes these are through the gum when the animal is foaled; if not they appear within the first month. Three molar teeth on each side of both upper and lower jaws are prominent, and in apposition for wear at the same time. One incisor on each side of the two central appears at six weeks, and then time is allowed for the jaw to grow. The cavities of reserve with teeth forming in them grow behind the teeth first formed, and by nine months the corner incisors appear, and gradually grow until the animal is a year old, when all the colt's incisors are in full use. Within one and two years of age little can be seen beyond a gradual wearing down of the temporary teeth, and the protrusions through the gums of the fourth molar on each side of the two jaws. At two years the worn aspect of the incisors indicates the approaching displacement of the central ones, and the fifth molar protrudes through the gums.

Between two and three years the central permanent incisors displace the temporary, and are readily recognized by their size, yellowish color of enamel, and dark infundibulum. At this age the middle incisors are often knocked out to make the horse look "three off" or "coming four." This often retards their eruption, which is always complete at four years, when the sixth molar tooth on either side of both jaws is also advanced through the gum. By this time the three temporary molars, or grinders, which are noticed shortly after birth, have given way to permanent teeth. The lower tushes are felt through the membrane between the corner and first molar as early as three years of age, but they only appear above it between four and five. It is at this age that the horse's mouth becomes

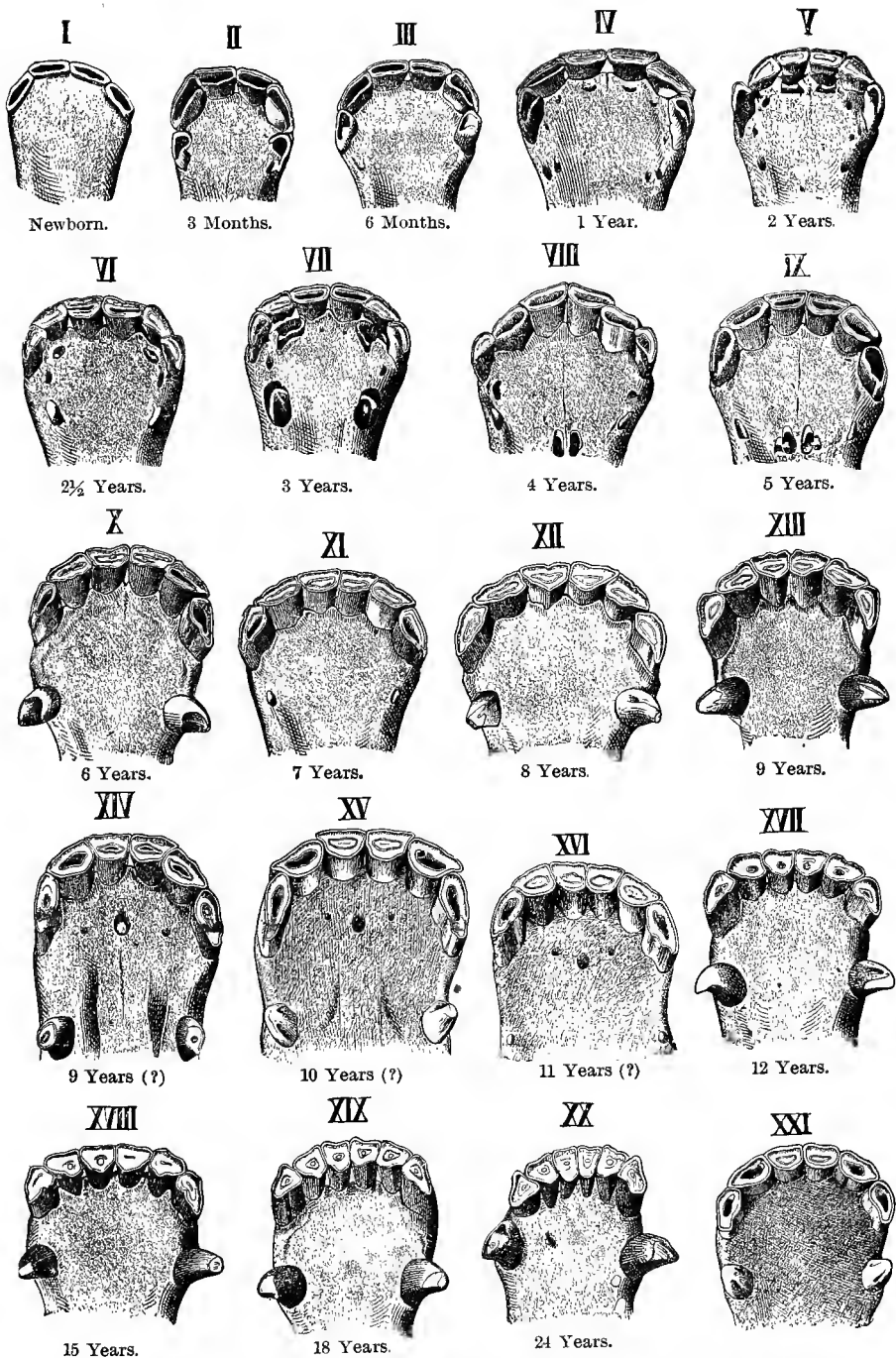

FIG. 102.—CHANGES FROM AGE IN THE INCISOR TEETH OF THE HORSE. (Wilckens.)

fully furnished, and by five the whole of the incisors are in full wear, and indicate the extent to which they have been worn proportionate to the period since their eruption. The central incisors then appear as shown in *b*, Fig. 101, B, whereas the corner teeth, having just protruded, are shelly, as shown in *a*.

At six the central incisors lose their mark; at seven this occurs with the middle one, and at eight all the infundibula are worn out, and the plate of the tooth is clean and only very slightly marked in the corner teeth. Beyond this period the horse is stated to be aged. The incisors protrude straighter from the reeding jaw; the teeth become narrower, and their wearing surface becomes triangular, as seen at *c*, *d*, and *e*, Fig. 101, B. This distinguishes the old animal.

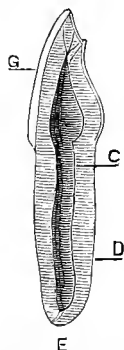

FIG. 103.—LONGITUDINAL SECTION OF INCISOR TOOTH OF RUMINANT. (Ellenberger.)

C, tooth-cavity; G, enamel; E, pulp-canal; D, dentine.

The table on the preceding page, taken from the "Encyclopädie der gessamten Thiérheilkunde," indicates the wear of the incisors of the horse at different ages (Fig. 102).

*Dentition in the Ox.*—The incisor teeth of the lower jaw of the ox are simple, and eight in number (Fig. 103). From the periods of eruption of both temporary and permanent teeth being regular, the latter being much the broader, the age of the animal is readily determined. Further, the sharp teeth become more and more blunt and narrow, until in old cattle they are reduced to very small stumps.

The wear of the incisors commences on the free border, both in the deciduous and permanent teeth, the enamel being worn gradually from the table of the tooth, from the anterior border posteriorly, the dentine being exposed in zigzag lines, which at the sides extend further toward the neck of the teeth than in the middle. When the enamel is all gone from the table of the incisors (after the tenth year), the entire crowns of the teeth wear down until, in extreme age, only the necks are left. The following table gives the succession of changes in the ox:—

SIMONDS. TABLE OF EARLY AVERAGE (IMPROVED BREEDS).			SIMONDS. TABLE OF LATE AVERAGE (IMPROVED BREEDS).			GIRARD. TABLE OF LATE AVERAGE (UNIMPROVED BREEDS).		
Yrs.	Mos.	No. of Teeth.	Yrs.	Mos.	No. of Teeth.	Yrs.	Mos.	No. of Teeth.
1	9	2 permanent incisors	2	3	2 permanent incisors	2	3	2 permanent incisors
2	3	4 " "	3	9	4 " "	3	0 4	" "
3	9	6 " "	3	3	6 " "	4	0 6	" "
3	3	8 " "	3	9	8 " "	5	0 8	" "

The following figures, from the "Encyclopädie der gessamten Thierheilkunde," indicate the changes occurring with age in the incisor teeth of cattle (Fig. 104).

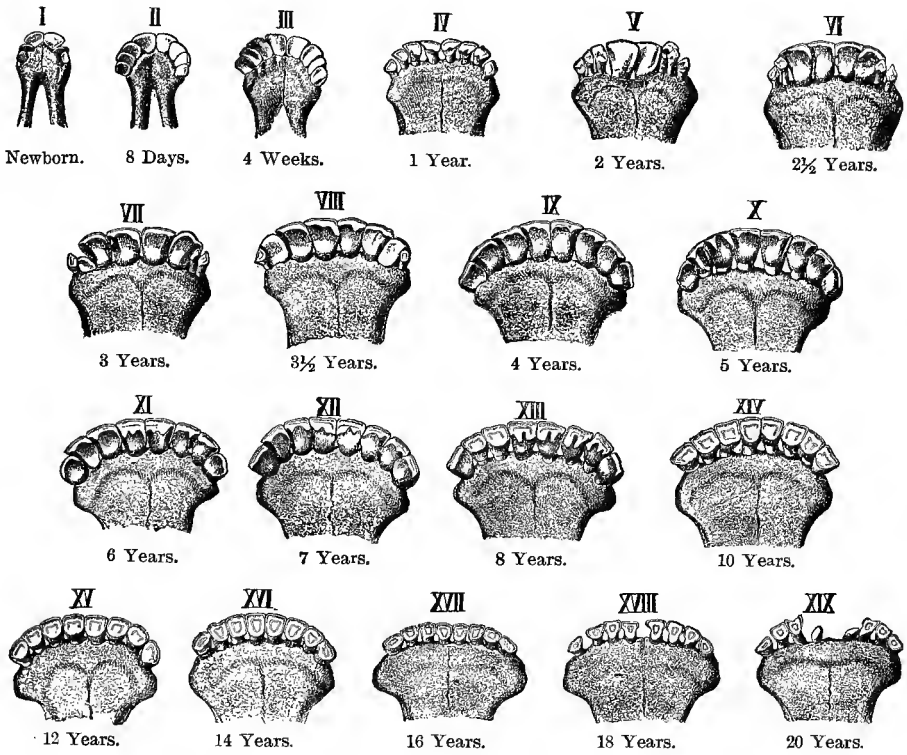

FIG. 104.—CHANGES FROM AGE IN THE INCISOR TEETH OF THE OX. (Wilckens.)

*Dentition of Sheep.*—In the sheep it is by the displacement of temporary and eruption of the permanent teeth that the age of the animal is determined.

TABLE OF EARLY DENTITION.			TABLE OF LATE DENTITION.		
Years.	Mos.	No. of Teeth.	Years.	Mos.	No. of Teeth.
1	0	Central pair of temporary incisors replaced by permanent.	1	4	Two permanent incisors.
1	6	Second " "	2	0	Four " "
2	3	Third " "	2	9	Six " "
3	0	Fourth " "	3	6	Eight " "

These changes are also indicated in the following diagrams from the "Encyclopädie der gessamten Thierheilkunde" (Fig. 105).

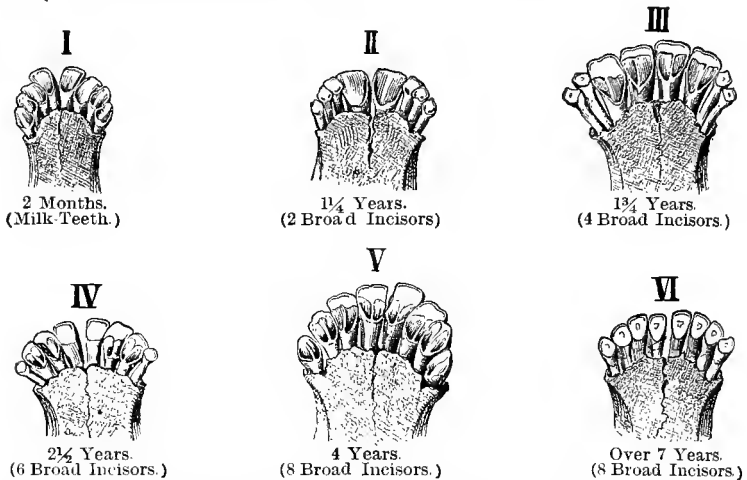

FIG. 105.—CHANGES FROM AGE IN THE INCISOR TEETH OF THE SHEEP. (*Wilckens*.)

*Teeth of Carnivora.*—All the carnivora have simple teeth; *i.e.*, covered entirely over the crown by white enamel. There are three pairs of incisors, one pair of canines, and a certain number of molars. It is the last premolars, or the first true molars, which are employed in chewing flesh; they are prominent and sharp. Behind these, especially in the dog, the teeth are armed with round tubercles on their surface, destined for crushing or grinding action, and in breaking bones or gnawing long grass the dog may be seen to push the substance between these back molar teeth.

*Dentition in Dog.*—

$$\text{Incisors } \frac{6}{6}; \text{ canines } \frac{1-1}{1-1}; \text{ molars } \frac{6-6}{7-7} = 42.$$

The dog is born with his eyes shut; they open on the tenth or fifteenth day after birth. The whole of the milk-teeth are usually cut then, or very shortly after. Between two and four months the central incisors and often even the middle ones of both upper and lower jaws drop out, and speedily the whole of the permanent teeth are fully developed, so as to complete the mouth by eight months.

The inferior incisors begin to wear by fifteen months. Fig. 106 shows the milk-teeth in a puppy two or three months old; Fig. 107 in a year-old dog. At eighteen months, or two years, the inferior central incisors are much worn, and between two and three years the middle ones also (Fig. 108); the worn incisors bear a striking contrast to the



young teeth, as seen in Fig. 107, where the edge or border of the tooth is divided into three lobes, of which the most prominent constitutes the point of the tooth. Between three and four years the upper central incisors are worn, and between four and five the whole give indications of much use (Figs. 109 and 110). Beyond this age the teeth are very uncertain. The bluntness and yellow color of the tusks and other teeth offer the best signs of increasing age.



FIG. 106.—MILK-TEETH IN A PUPPY 2 OR 3 MONTHS OLD. (Gamgee.)

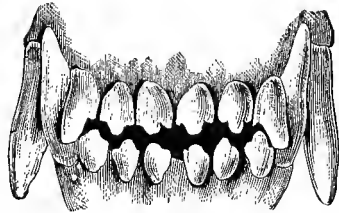

FIG. 107.—DENTITION IN A YEAR-OLD DOG. (Gamgee.)

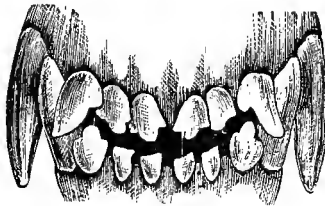

FIG. 108.—DENTITION IN A TWO-YEAR-OLD DOG. (Gamgee.)

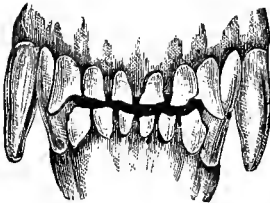

FIG. 109.—DENTITION IN DOG BETWEEN 3 AND 4 YEARS OF AGE. (Gamgee.)

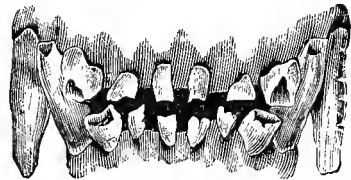

FIG. 110.—DENTITION IN DOG 4 OR 5 YEARS OF AGE. (Gamgee.)

*Dentition in the Pig.*—The pig is born with eight teeth, which are foetal incisors and foetal tusks. At one month four incisors are cut, besides three temporary molars on either side of each jaw. Two more temporary incisors are added to each jaw at three months, and all the milk-teeth are then in position. The jaws and teeth grow, and at six months in most animals, but not in all, a small tooth comes up on either side of the lower jaw, behind the temporary tusks, between them and the molars, and in the upper jaw directly in front of the molars. These teeth have been mistaken for tusks. The fourth molar in position

appears through the gum also at six months. The corner incisors are displaced and permanent ones cut at nine months. The permanent tusks are also cut at this period, as well as the fifth molar on either side of each jaw. At one year the middle incisors are changed and the tusks appear of considerable size. The deciduous molars are likewise shed at one year and succeeded by permanent. At eighteen months the dentition of the pig is completed by the cutting of the lateral incisors and the last or sixth molar. The succession of teeth in the pig is shown in the following table:—

	At Birth.	One Month.	Three Months.	Nine Months.	Twelve Months.	Eighteen Months.
Fœtal } Incisors,	4	4	4			
} Tusks,	4	4	4			
Temporary incisors,		4 central.	8 central and lateral.	8 central and lateral.	4 lateral.	
Permanent incisors,				4 corner.	8 central and corner.	12 central, lateral, and corner.
Permanent tusks,				4 ( <i>cutting</i> ).	4	4
Total in both jaws,	8	12	16	16	16	16

*Other Signs of Age in Domestic Animals.*—In horned animals the horns grow annually a certain length, and this is shown by the appearance of an extra ring every year at the root of the horn. For the first two years the rings are so indistinct that, in calculating the age in an animal five or six years old, the first ring indicates a three-years' growth, so that an animal with six rings must be regarded as eight years old.

Fraud may be practiced to destroy the marks of age. Angularity of form, sharpness of bones and gray hair are not easily disguised, but teeth can be filed and marked and horns scraped. Making false marks on teeth is called "bishoping." Gray hairs may be painted, called "gypping." In old horses the remarkable depressions behind the orbits are sometimes prieked and blown up with air; this is called "puffing the glym."

Some of the abnormal conditions of the teeth are the persistence of temporary teeth, so that twelve incisors may be present in the lower jaw, or the permanent teeth may fail to develop. One or more teeth may be absent, from removal or from faulty development.

In the following table the order of dentition of the domestic animals is recapitulated:—

KREUTZER'S TABLE OF DENTITION IN THE DOMESTIC ANIMALS.

	HORSE.		RUMINANTS.		PIG.		DOG.	
	Eruption.	Change.	Eruption.	Change.	Eruption.	Change.	Eruption.	Change.
<i>I. Incisors.</i>								
Central.	Before or a few days after birth.	2 years.	Before or a few days after birth.	1½ years.	3 to 4 months.	2½ to 3 years.	4 to 6 weeks.	3 to 4 months.
Middle.	4 to 6 weeks.	3½	14 days after birth.	2½ 3½	"	"	"	"
Outer middle.	6 to 9 months.	4½ years.	2 to 3 weeks.	4½	Before or a few days after birth.	1 year.	"	5 to 6 months.
Corner.	4 to 5 years.							
<i>II. Tusks.</i>								
<i>III. Molars.</i>								
1	Before or a few days after birth.	2½ years.	Before or a few days after birth.	1½ years.	"	"	3 to 4 months.	5 to 6 months.
2	"	3 years.	"	2½ 3½	"	"	"	"
3	10 to 12 mos.		6 to 9 months.		5 to 6 months.	2 years.	4 to 5 months.	
4	1½ to 2 years.		2½ years.		1 year.	"	5 to 6 "	
5	4 to 5 "		4 to 5 years.		3 years.	"	5½ to 6½ "	
6								
7								
Number of Teeth.	Horse, Mare, Ramnants.				40 36 32	Number of Teeth.	Pig, Dog, Cat.	44 42 30

3. The TONGUE, LIPS, and CHEEKS are accessory organs of mastication, and act by maintaining the food in its position between the teeth. In many animals, particularly the horse, as already mentioned, the lips have a high degree of prehensile power, and when the upper lip is paralyzed, as by section of its motor nerve, prehension of food in the horse is impossible. When the lips and cheeks are paralyzed, again, even in animals in which these organs do not serve for prehensile purposes, mastication is impossible, or at least rendered extremely difficult, from the fact that their loss of motor power prevents their keeping the food between the teeth; their loss of sensibility prevents the determination as to when the food has acquired the proper degree of comminution, and their insensibility prevents these organs avoiding being themselves lacerated by the teeth. This especially applies to the occurrence of mastication between the molar teeth. Here, when the buccinator muscles are paralyzed, through paralysis of the facial nerve (seventh pair), the food collects in the pouches formed by the relaxed cheeks, and cannot be properly masticated. The sensibility of the lips and cheek is derived from the fifth pair of nerves.

The tongue is also an important organ of mastication; it serves in a large group of animals for the prehension of solids and liquids; it is of great importance in starting the process of deglutition, and in man it is one of the principal organs of articulation. By its high degree of sensibility it aids in mastication in determining the degree of comminution of the food, and in keeping the particles of food between the teeth during their mastication; its mobility enables it to act as a sort of hand in the necessary movements of the bolus of food in the mouth. Its muscles are striped and voluntary in nature and arranged in four different layers; an upper and lower layer, passing from the root to the tip of the tongue, and an upper and lower oblique layer. These muscles form a complicated net-work of fibres which, by varying degrees of partial contraction, permit not only changes in the shape of the tongue, but also in its position within and without the mouth. The extension of the tongue is accomplished by the muscles passing from the chin to the body of the organ, the *genio-glossus* muscles. The retraction of the tongue is accomplished by means of the muscles arising from the hyoid bone and styloid process,—the *hyo-* and *stylo-glossus* muscles,—and by the longitudinal fibres in the body of the tongue. The different alterations in shape of the tongue are accomplished by the contraction of its intrinsic muscles. Thus, when the upper longitudinal fibres of the tongue contract the tip of the tongue is elevated. When those of the inferior layer contract the tip of the tongue is depressed, and by contraction of the upper oblique layers the tip of the tongue is formed into the spoon shape which is so useful in the prehension of liquids in the cat tribe. The motor power

of the tongue is derived from the hypoglossal nerve; its sensation is derived from the lingual branch of the fifth nerve and the glosso-pharyngeal, both of these nerves being also concerned in the special sense of taste.

We see from the above that the act of mastication differs very decidedly in nature according to the type of organization of the animal, and its characters result from the configuration of the jaws, the play of the muscles, and the form of the teeth. Thus, we find that the movements of mastication in carnivorous animals are restricted to a simple elevation and depression of the lower jaw, this mode of mastication being dependent upon the mode of articulation of the lower with the upper jaw and the overlapping of the upper molar and canine teeth. Mastication, therefore, in these animals is reduced simply to a process of section, laceration, and crushing. The incisor teeth have but slight functional importance, and are confined in their action to cutting. The canine teeth are the principal organs of mastication, and exert a lacerating or tearing function, while the molars are crushing in function and, from the fact that they are highly tuberculated on their free crown surface, no process at all analogous to grinding can occur between them. When in these animals bones are crushed, such an operation only occurs on one side at a time. In animals of the cat tribe, from the highly pointed character of their molar teeth, crushing of hard articles of food is performed with greater difficulty than in animals in whom the molar teeth have a more blunt, tuberculated crown. Thus, animals allied to the dog can more readily crush bones than the cat tribe. When the molar teeth are brought into play, as in crushing a bone, the substance is usually fixed by the fore paws, while the flesh is torn from the bones by the canine teeth, and then the bones are drawn between the molar teeth by the action of the tongue, the lips being loose and pendulous and enabling the mouth to be opened back beyond the level of the molar teeth: so that, therefore, even large bones may partly be placed between the molar teeth, while the remainder remains without the mouth. Crushing is then accomplished by powerful contractions of the temporal and masseter muscles on one side of the jaw at a time, and are accompanied by motions of the head on the side on which mastication is taking place, and usually by the closure of the eye on the side in which this operation occurs.

In the herbivora the movements of mastication are much more complicated, and, as we find, differ in nature, the most marked extremes being found in the rodents and the ruminants. In all herbivora the lower jaw is always the narrower, and therefore both sides cannot act at once. The jaw is longer, less powerful, and we find among the herbivora differences in the series of movements for the necessary complete comminution of the food with which these animals are sustained.

A cutting motion is required, fulfilled by the incisor teeth, which are consequently most highly developed in the rodents; and a grinding motion, accomplished by the molars. As we have already found, the lower jaw is capable not only of elevation and depression, but also of advancement, retraction, and rotation, and all these motions are required in the mastication of food by the herbivora. This motion is unilateral, and may occur continuously on one side for fifteen minutes, and then alternate to the opposite molars, and we shall find that the secretion of the parotid salivary gland coincides with the side on which mastication is taking place. This peculiarity of secretion is seen in all ruminants and most herbivora, and has been even claimed to take place in man.

The duration of mastication depends upon the natural group to which the animal belongs, on its age, and therefore the condition of its teeth, and the character of its food. Carnivora require but slight mastication of their food, and, in fact, mastication, as seen in the herbivora, may in them be said to be entirely absent, the movements of mastication in carnivora being simply confined to tearing the food into pieces small enough to be swallowed. The herbivora, from the nature of their food, need a longer time for reducing it to a condition of fine comminution, and we find among the herbivora differences in the duration of mastication, according as the animals are ruminant or non-ruminant. The non-ruminant animals, such as the horse, chew their food thoroughly and once for all. It has been estimated by Colin that a horse will require one and one-fourth hours for the mastication of four pounds of dry hay, and of this amount will make sixty to sixty-five boluses, and, accordingly, sixty to sixty-five motions of deglutition, while the rate of mastication will be about seventy to eighty strokes of the teeth per minute. If anything interferes with the secretion of saliva the duration of mastication will be very much prolonged. One of the main objects of mastication in the herbivora is to aid in the maceration of the food. Where, as in the solipede, the food must be thoroughly macerated and comminuted before reaching the stomach, the duration of mastication will naturally be much longer than in the ruminant, where the food is simply subjected to a few strokes of the teeth and then swallowed, to then undergo prolonged maceration in the rumen of these animals, and to be again subjected to a second mastication in the mouth. In both animals, although in a more marked degree in the horse, suppression or interference with the flow of saliva will prolong mastication; again, the drier the food the greater will be the amount of mastication necessary before the food can be comminuted and macerated sufficiently to be swallowed. Therefore, grazing animals will require a less degree of mastication of their food than those which are fed on grains or dry fodder. In the ruminant the first mastication is three times as fast as the mastication

in the horse for the same amount of food, while the second mastication is proportionately lengthened. As the teeth become worn away, mastication becomes more and more difficult, and proportionately more and more prolonged. In the horse the molar teeth are used up faster than the incisors, and if it were not for the fact that the incisors become more and more horizontal, the molar teeth could no longer come in apposition. The influence of the secretion of saliva on mastication has been determined by Colin experimentally, by making a fistula of the duct of the parotid glands and allowing the saliva to escape externally from the mouth. His results are shown in the following table :—

No. of Boluses.	ALL THE SALIVA POURED INTO MOUTH.		SALIVA OF ONE PAROTID ESCAPING.		SALIVA OF BOTH PAROTIDS ESCAPING.	
	Duration of Mastication of One Bolus.	No. of Strokes of Teeth.	Duration of Mastication.	No. of Strokes of Teeth.	Duration of Mastication.	No. of Strokes of Teeth.
1	35 Seconds.	39	30 Seconds.	33	45 Seconds.	38
2	33 "	42	29 "	30	43 "	47
3	25 "	31	37 "	44	35 "	35
4	27 "	36	33 "	36	80 "	79
5	30 "	39	47 "	42	115 "	114
6	35 "	41	45 "	38	60 "	63
7	25 "	37	23 "	33	110 "	101
8	25 "	34	33 "	35	95 "	95
9	42 "	47	40 "	45	100 "	101
10	40 "	40	25 "	30	65 "	68

As regards the importance of thorough mastication, it is hardly necessary to add anything further. We have found that its importance, of course, varies in accordance with the nature of the food. Carnivora, as has been mentioned, require mastication simply to be perfect enough to tear their food into pieces small enough to be swallowed, and in the herbivora we reach the opposite extreme, and find there the group of animals in whom a thorough mastication is of the utmost necessity. From our considerations of the nature of vegetable foods we know that the nutritive principles of these foods are contained within resisting, tenacious envelopes. To enable these substances to be acted upon by the digestive juices, and therefore to be absorbed, these envelopes must be first mechanically ruptured, and this in the herbivora is the main object of mastication.

Where we find mastication imperfectly performed, we have, as an invariable sequence, imperfect digestion, and we find that the grasses and seeds, and so on, which escape mastication pass through the intestinal canal entirely unaltered and are found in the excreta unchanged, and, in the case of seeds, without even having lost their power of germination.

They are, therefore, perfectly inert as regards any action to which they may be subjected by the digestive juices. In the omnivora we find mastication occupying a mean as regards importance between the herbivora and the carnivora. Where an omnivorous animal feeds on vegetable diet the performance of mastication is as important as in the herbivora; while when on a meat or animal diet its importance becomes reduced to the secondary degree in which it is seen in animals of a purely carnivorous type.

#### IV. DIGESTION IN THE MOUTH.

**THE SALIVARY SECRETION.**—The salivary glands appear in most vertebrates as tubular glands, as in insects, but in the mollusks they take on the lobular form which characterizes them in the vertebrates. In birds the salivary glands are small in the species which live on soft animal food (waders and web-footed species), while they are larger in the granivorous birds. In birds the saliva is mainly to assist in deglutition by lubricating the food, as buccal mastication does not occur in these animals. In certain birds, as the woodpecker, the salivary secretion assists in the prehension of food. In the fishes, from the nature of their food, which requires no mastication, we find the salivary glands almost entirely absent, even in such groups as the cetaceans which belong to the general division of mammals. Here, also, we find that their food requires no preliminary subdivision before being swallowed. As has been already mentioned, one of the uses of the saliva is to assist in mastication; where, therefore, mastication is not performed we have in such animals a correspondingly rudimentary condition of the salivary glands. On the other hand, in nearly all animals which possess buccal or pharyngeal teeth there is usually a glandular apparatus whose secretion, by macerating the food, is destined to facilitate mastication and deglutition. In a general way it may be said that in most cases where there are permanent prehensile organs salivary glands are also present (Letourneau). Thus, the fly emits on the particles it is about to draw in a brown liquid which dilutes them. In reptiles the salivary glands become very highly developed, and in certain of them their secretion acquires a poisonous character. In chelonians and saurians the salivary apparatus consists principally of lingual glands. In the chameleon they are located in the tongue and secrete the sticky fluid which is of importance in their mode of prehension of food. Their maximum development is, however, reached in mammals, with the exception of the cetaceans, as already alluded to, where the lacrymal glands are also absent, and is especially marked in the herbivora, whose food requires the finest comminution in the mouth. In the ant-eater the salivary apparatus is enormously developed, the glands covering the fore part of the neck and even extending to the chest,



and a special reservoir, or salivary bladder, exists beneath the mouth. In these animals also the saliva, through its viscosity, assists in the prehension of food. In the carnivora mastication is incomplete; since the food of carnivorous animals contains a large quantity of water, the salivary glands of these animals are therefore relatively small, and their function is confined to the production of a secretion which may act simply as a lubricant and assist in deglutition. In the herbivora, on the other hand, from the necessity for perfect subdivision required by their food, they are relatively very large. The salivary glands thus reach their highest development in the rodents, the pachyderms, solipedes, and ruminants.

Colin has divided the salivary glands into two different types. The anterior system, or the mucous type, which empty their secretions into the mouth in the neighborhood of the incisor teeth, comprise the submaxillary and sublingual glands; these glands are most developed in carnivora and in aquatic animals, whose food must be lubricated for deglutition, but not masticated. The posterior system, or serous type, which empty their secretions into the mouth near the molar teeth, are most developed in animals whose food requires thorough mastication, as in the herbivora, and especially in non-ruminants. The parotid is the type of this system. The glands which form these two systems are not all developed in the same proportion. Thus, in the anterior system, composed of the submaxillary, sublingual, and the gland of Nuck, the sublingual may be very small and the submaxillary very large, the former being rudimentary in the dog. Again, they are rudimentary in the dromedary, and are extremely highly developed in the ox. Again, as regards the posterior system, in the horse the parotids are enormous, while the submaxillary glands are rudimentary. In the ox the reverse is the case. In herbivorous animals these glands have their largest volume, but there is no relative proportion between the volume of the glands and the volume of the secretion which they produce. Thus, in the ox the weight of the salivary glands will amount on an average to six hundred and twenty-four grammes; the horse to five hundred and nine grammes; the pig, three hundred and five; sheep, eighty-three; dog, twenty-five; and the cat, ten. The parotid is the largest salivary gland in all animals with the exception of the dog, and here the submaxillary gland is the largest. In the pig, ox, and sheep the sublingual glands are sometimes double, the one part emptying its secretion by a long duct opening at the papilla at the side of the frænum of the tongue, the other by a number of coiled ducts at the side of the floor of the mouth.

In addition to these large salivary glands the fluid in the mouth is also poured out by glands located in its mucous membrane, forming the so-called buccal, lingual, palatine, and pharyngeal glands. The secretion formed by all these glands combined is termed mixed saliva.

It is evident from the varied sources of the buccal fluid that the saliva is by no means a homogeneous fluid. If collected from the mouth by expectoration, or in the lower animals by holding the mouth open and stimulating the surface of the tongue and the cheeks by any sapid substance, as by the vapor of ether or acetic acid, or even mechanically, the fluid poured out will be found to be opalescent or more or less turbulent; with a decided froth on its surface, from the air-bubbles retained through its viscidty, and when allowed to stand in a glass will deposit a sediment of epithelial cells and the so-called salivary corpuscles. It will, therefore, form three different layers: the lower one composed of this deposited sediment; the middle, of a clear, though opalescent, watery fluid; while the uppermost layer will be more or less frothy. Where a specimen of saliva remains standing for two or three days exposed to the air the froth will disappear, and its place be taken by a thin pellicle of carbonate of lime. When filtered, saliva forms a watery fluid with alkaline reaction. Occasionally, where it appears to have an acid reaction, the acidity is due to the fermentation of some retained fragments of food in the mouth, as occurs after prolonged fasting in diabetes and other pathological conditions; the secretion of the salivary gland is invariably alkaline. Frerichs states that 0.15 gramme sulphuric acid is necessary to neutralize the alkalinity of human saliva collected during smoking.

The specific gravity of mixed saliva varies somewhat in different animals. It has been placed at 1004.5 in the horse; 1010.2 in the pig; 1010 in the cow; 1007.1 in the dog; and from 1002 to 1006 in man. Deprivation of water is said to cause the saliva to acquire a higher specific gravity; thus, in the horse the normal specific gravity of 1004.5 or 1005, may be raised to 1007.4 after the animals have been deprived of water for twelve hours.

The amount of saliva varies very largely according to a number of different conditions. Colin places the average daily secretion of saliva in the horse at eighty-four pounds, and in the ox at one hundred and two pounds; while in the dog Jacobowitsch obtained in a hour 49.19 grammes of parotid saliva, 38.94 of submaxillary and 24.84 of sublingual saliva. We will, however, again return to the volume of saliva and the different conditions modifying the rapidity of secretion when we come to consider the secretion of the separate glands.

When examined under the microscope mixed saliva is found to contain numerous epithelial cells from the cavity of the mouth, often *débris* of food, inorganic particles of tartar from the teeth, various forms of minute bacterial organisms, and the so-called salivary corpuscles. The latter closely resemble white blood-cells in appearance, but are somewhat larger, and are nucleated protoplasmic cells without a cell-membrane.

When placed on the warm stage of the microscope they may often be seen to be the seat of anœboid movement, and to contain numerous granules which exhibit the Brownian movement.

The chemical composition of the mixed saliva varies somewhat in different animals. The solids are epithelium and mucin, ptyalin, serum-albumen and globulin, and salts. The following table represents some of the different analyses which have been made of this secretion in different domestic animals. According to Lassaigne, mixed saliva contains as follows :—

<i>Horse.</i>		
Water,	.	992.00
Mucus and albumen,	.	2.00
Alkaline carbonates,	.	1.08
Alkaline chlorides,	.	4.92
Alkaline phosphates and phosphate of lime,	.	traces.
		1000.00
<i>Cow.</i>		
Water,	.	990.74
Mucus and albumen,	.	0.44
Alkaline carbonates,	.	338.00
Alkaline chlorides,	.	2.85
Alkaline phosphates,	.	2.49
Phosphate of lime,	.	0.10
		1000.00
<i>Sheep.</i>		
Water,	.	989.00
Mucus and albumen,	.	1.00
Alkaline carbonates,	.	3.00
Alkaline phosphates,	.	1.00
Alkaline chlorides,	.	6.00
Phosphate of lime,	.	traces.
		1000.00
<i>Man.</i>		
Water,	.	995.16
Solids,	.	4.84
Mucus and epithelium,	.	1.62
Soluble organic matter,	.	1.34
Sulpho-cyanide of potassium,	.	0.06
Inorganic salts,	.	1.82
<i>Dog.</i>		
Water,	.	989.6
Solids,	.	10.3
Soluble organic matter,	.	3.58
Inorganic salts,	.	6.79

The following represents the quantitative composition of the ash of the saliva of man and the dog (Jacubowitsch) :—

	Man.	Dog.
Salts,	1.82	6.79
Phosphoric acid,	0.51	0.82
Sodium,	0.43	
Lime,	0.03	0.15
Magnesium,	0.01	
Alkaline chlorides,	0.84	5.82

The salts consist mainly of phosphates of sodium, potassium and magnesium, and alkaline chlorides. One of the most remarkable constituents of the saliva is the sulphocyanide of potassium which is found in small amounts in many but not in all salivary secretions. Treviranus in 1814 first made the observation that when saliva is mixed with a solution of oxide or chloride of iron and hydrochloric acid a bright-red coloration is produced, which was recognized by Gmelin to depend upon the presence of the sulphocyanide of potassium. It is said by Gmelin to be present in largest amount in the saliva of the dog; it is almost constantly present in the saliva of man and in the saliva of the horse. It probably, however, may be detected in the saliva of all animals by distilling the saliva with phosphoric acid and catching the first drops that pass over on filter-paper treated with dilute hydrochloric acid and ferric chloride, and then dried. Its presence may also be recognized by the fact that paper, impregnated with tincture of guaiacum and then dried, with an almost colorless solution of sulphate of copper, is colored blue by the saliva. The reaction by which potassium sulphocyanide is recognized—that is, the red color which it forms with an iron salt—is possessed also by meconic acid; the two substances may be distinguished, however, in a very simple manner. If a few drops of a solution of mercuric chloride, or if a few mercuric chloride crystals, are added to saliva which has been colored red by the perchloride of iron, the color is at once discharged. When, however, the red color is due to the presence of meconic acid and an iron salt, the red coloration is permanent, even after the addition of corrosive sublimate.

The origin of this salt is not known, although the majority of authorities seem to attribute its presence to a spontaneous decomposition of the saliva, since saliva which has been standing for some time will give the reaction in a more marked degree than when entirely fresh. This view is still further strengthened by the fact, determined by Ellenberger and Hofmeister, that extracts of the salivary glands of all the domestic animals, whether made from dried or fresh glands, with water, carbolized or alkaline water or glycerin, entirely fail to show this reaction. Absolute data as to the origin of this salt are entirely wanting. Its use in the economy is also clouded in obscurity, as it is eliminated unchanged through the kidneys and may be recognized in the urine. The chlorides in saliva may be recognized by filtering and acidulating strongly with nitric acid; the addition then of a few drops of a solution of nitrate of silver to the saliva will cause quite a decided white precipitate which is readily soluble in ammonia.

Of organic constituents, saliva contains albuminous bodies, as may be recognized by the xanthoproteic and Millon's reaction; it contains mucin, as may be determined by precipitating with acetic acid; and it

contains a substance of the nature of a ferment, which is termed animal diastase or ptyalin, whose presence may be demonstrated by the power possessed by the saliva of converting starch mucilage into sugar. Of the albuminoid bodies, serum-albumen and a globulin-like body which may be precipitated by carbonic acid are the representatives.

The most important constituent of the saliva is the ptyalin. This substance belongs to the group of soluble ferments, and is a product of the cells of the salivary glands. It may be obtained, according to the method of Cohnheim, by adding a little phosphoric acid to mixed saliva and then stirring with milk of lime until the alkaline reaction is restored; the white precipitate is then filtered off, and the filtrate shows scarcely any albuminoid reaction, while it still possesses in an almost undiminished degree its diastatic power. A considerable quantity of the ptyalin still remains clinging to the albuminoid matters deposited in the precipitate, and if this is washed with water the ptyalin is extracted, while it leaves the albuminous matters still on the filter. If alcohol is added to the watery extract of this precipitate, a flocculent, whitish precipitate is formed, which may be collected by decantation and dried over sulphuric acid. A grayish-white powder is thus obtained, which consists of ptyalin mixed with phosphates; the latter may be removed by dissolving in water, precipitating again by absolute alcohol, washing the precipitate with dilute alcohol and then with a small quantity of water, and drying at a low temperature. Ptyalin so obtained is a nitrogenous substance, but not an albuminoid. It is readily soluble in water and glycerin and possesses the power of converting starch and glycogen into maltose, and this property is exerted whether in a neutral or very faintly acid or alkaline medium. An excess of alkali or of acid, as will be again referred to, prevents its activity. The ferment may also be extracted from the salivary glands by mincing fresh glands and covering them with glycerin. As the ferment is soluble in glycerin, it is extracted from the gland-tissue, and may be precipitated again from the glycerin extract by alcohol.

The saliva contains appreciable volumes of different gases in solution, as determined by Pflüger in the case of the submaxillary gland of the dog. He estimates the different amounts of gases contained in the saliva as follows:—

Oxygen,	.	.	0.4 to 0.6	volume per cent.
Nitrogen,	.	.	0.7 to 0.8	“ “ “
Carbon dioxide,	.	.	49.2 to 64.7	“ “ “

It is thus seen that saliva is the richest in CO<sub>2</sub> of any fluid in the animal body. Only a small proportion of the above amount, however, can be extracted with the gas-pump, showing that the remainder is held in chemical combination. The amount capable of being pumped out

varies from 19.3 to 22.5 c.c., while from 22.9 to 42.5 c.c. of  $\text{CO}_2$  are liberated on the addition of phosphoric acid.

The secretions of the different glands of the salivary system present several distinguishing points which will be alluded to in turn.

1. *The Parotid Secretion.*—

In order to study the pure secretion of the parotid gland, the saliva must be collected before it reaches the mouth to be mixed with fluid from the other glands. This may be accomplished, in man or in the dog, by catheterizing the parotid duct, an operation which is readily performed. It is only necessary to open the mouth and evert the cheek, when the papilla of entrance may be recognized on the inner surface of the cheek, on a level with the second molar tooth of the upper jaw. A slender glass tube or silver cannula may be readily inserted within the orifice of the duct and the fluid collected as it flows through the tube. Where studies as to the

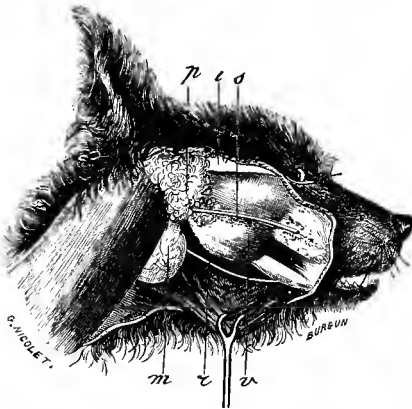

FIG. 111.—PAROTID AND SUBMAXILLARY GLANDS OF THE DOG, WITH THEIR EXCRETORY DUCTS. (Béclard.)

*p*, parotid gland; *m*, submaxillary gland; *s*, duct of Steno; *r*, duct of Wharton; *v*, masseter muscle; *t*, temporal muscle.

mechanism of secretion have to be made, or where a considerable quantity is to be collected, a more convenient method is to make a fistulous

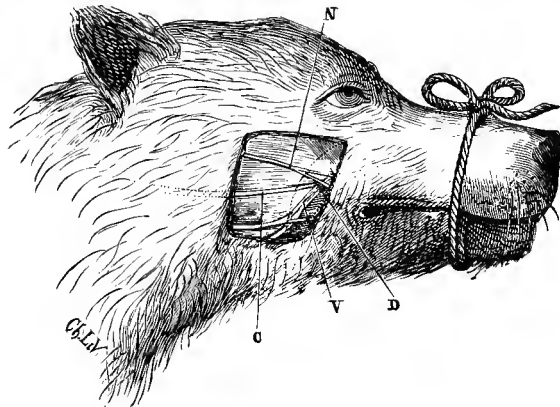

FIG. 112.—RELATIONS OF THE PAROTID DUCT OF THE DOG WITH THE FACIAL VESSELS AND NERVE, AFTER BERNARD.

The dotted line indicates the line of incision for finding the duct at the apex of the angle formed by the vessels and nerve. *V*, vaso-nervous fasciculus forming the inferior side of the angle; *N*, vaso-nervous fasciculus forming the upper side; *D*, point of junction of these two fasciculi; *C*, duct of Steno bisecting this angle.

mechanism of secretion have to be made, or where a considerable quantity is to be collected, a more convenient method is to make a fistulous

opening into the parotid duct before it reaches the mouth. This may be readily performed in the horse or dog (Fig. 111).

To make a parotid fistula in the dog, the animal usually employed in these experiments, the hair is first shaved from the cheek, between the eye and the angle of the mouth. On running the finger along the lower border of the zygomatic arch, just before it is inserted into the superior maxilla, a slight notch is felt. It is just at this point that the duct passes into the mouth. After chloroforming the animal, an incision is made through the skin from this point, cutting obliquely in a direction from the inner canthus of the eye to the angle of the mouth, passing through the subcutaneous cellular tissue, when the facial artery and vein, branches of the facial nerve, and parotid duct are found together, the duct pearly white in hue, passing horizontally across the fibres of the masseter muscle parallel to the nerve, usually about a quarter of an inch below it, while the artery and vein run from above downward (Fig. 112). The vessels and nerves must be carefully removed from before the duct, which is to be isolated and closed as near the mouth as possible with a clip. A cannula may then be inserted into the duct. If it is decided to retain the fistula permanently, the duct must be freed from the connective tissue for as long a distance as possible, divided, and then brought out at the angle of the wound, which is to be closed with sutures, one passing through the duct to retain it in position. After a few days, when the wound is healing, the duct will mortify and drop out, leaving a fistulous track to the gland, which must be kept open by the daily passage of a fine probe, as it has a decided tendency to close. A similar operation is readily performed upon the horse or ox, where the large size of the duct renders it easily recognizable. After a cannula has been inserted into the duct of the animal, its free extremity may be connected by a piece of rubber tubing with a rubber bulb or glass bottle, in which the saliva may be collected (Figs. 113 and 114).

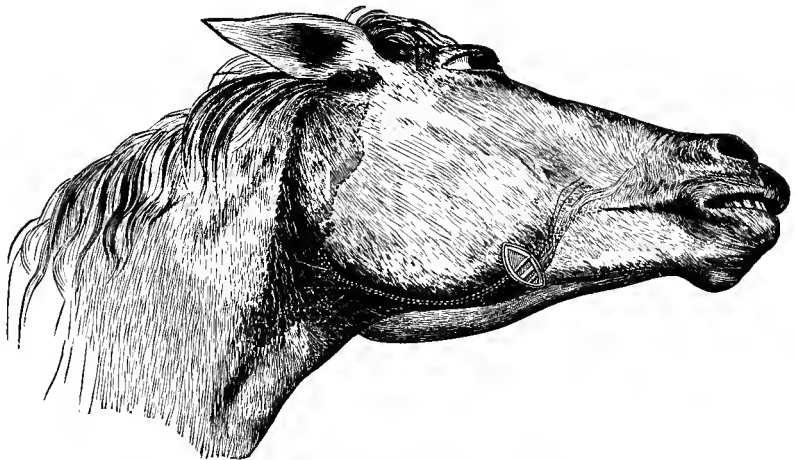

FIG. 113.—PAROTID DUCT IN THE HORSE. (Bernard.)

The dotted line indicates the contour of the gland and the course of the duct of Steno.

The parotid gland of the horse is only in activity when the animal is masticating food, while the parotid glands of the ruminants are continually secreting. The parotid glands constitute almost entirely the posterior or serous system of the salivary glands, and furnish by far the largest amount of the fluid which impregnates the food. The parotid

glands secrete alternately during mastication, both in the horse and ruminant animals, and, in all probability, also in the omnivora, the

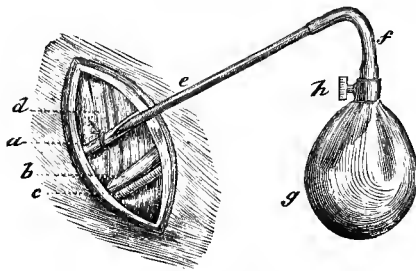

FIG. 114.—PAROTID FISTULA IN THE HORSE.  
(Bernard.)

a, duct of Steno, with cannula inserted, and rubber bag for collecting the saliva.

secretion occurring on the side on which mastication is taking place. Thus, when mastication is taking place between the right molar teeth, then it is the right parotid alone, in the horse, which secretes, and it is the right parotid in the ruminant which has the highest activity. Experiments conducted by Colin,

by making a fistula of the parotid ducts in the horse and the ass, have demonstrated the truth of these statements. The following tables represent some of his results :—

Experiment.	Time in Minutes.	Right Parotid.	Left Parotid.	Side of Mastication.
1. Horse,	15	910 grammes.	200 grammes.	Right.
"	15	580 "	320 "	Right.
"	15	250 "	700 "	Left.
2. Horse,	15	570 "	620 "	Left.
"	15	510 "	820 "	Left.
"	15	500 "	800 "	Left.
"	15	480 "	750 "	Left.
"	15	720 "	420 "	Right.
"	15	540 "	800 "	Left.
"	15	600 "	740 "	Left.
3. Horse,	15	620 "	260 "	Right.
"	10	320 "	200 "	Right.
"	5	200 "	120 "	Right.
"	15	410 "	230 "	Right.
"	10	60 "	320 "	Left.
"	5	20 "	150 "	Left.
"	15	130 "	520 "	Left.
4. Horse,	5	160 "	85 "	Right.
"	6	150 "	235 "	Left.
"	4	160 "	40 "	Right.
"	4	115 "	70 "	Right.
"	4	95 "	165 "	Left.
"	6	80 "	210 "	Left.
5. Horse,	3	50 "	110 "	Left.
"	6	200 "	50 "	Right.
"	4	30 "	100 "	Left.
"	5	200 "	30 "	Right.
6. Ass,	15	120 "	10 "	Right.
"	15	110 "	60 "	Right.
"	15	80 "	170 "	Left.
"	15	150 "	15 "	Right.
"	15	30 "	160 "	Left.
"	15	55 "	135 "	Left.
"	15	50 "	165 "	Left.



These results must not be regarded as absolutely correct, since, even in the horse, the operation of making a fistula interferes with the normal sequence of mastication, as it is always longest on the side which is opposite to the fistula.

Ellenberger and Hofmeister found that the parotid of one side in one horse secreted 1000 grammes in half an hour, the same amount in another horse in a quarter of an hour, and in a third horse 4000 grammes in two hours—oats, hay, and chopped straw being given as food. During the pauses between the acts of mastication, the parotids of the horse, contrary to what is the case in the ruminant, are quiescent.

In ruminant animals this alteration of activity of the parotid glands, although depending upon the side of mastication, is less readily determined than in the horse; for when a fistula is made the ruminant animal will continuously masticate on the opposite side to that in which the fistula is present, and the maximum activity of secretion is therefore taking place on the side opposite to the fistula. On the other hand, if two fistulæ are made the animal will change the direction of mastication two or three times a minute, and the process of mastication is much interfered with and the character of secretion altered. The inequality of the secretion according to the side on which mastication is taking place is also seen in the ruminant animal during the second period of mastication in rumination.

These experiments seem to show that mastication is the normal stimulant of the parotid glands, though they also secrete during the pauses of rumination. Further, these glands are insensible to other stimulants, such as salt, acids, etc., brought into contact with the mucous membrane of the mouth. Such stimuli produce no sensible secretion in solipedes and no increase in the constant secretion of ruminants. So, also, sight and odor of food have no effect on the secretion of the parotid, even if the animals are in a state of great hunger.

The character of the parotid saliva also differs from that of mixed saliva and that of the other salivary glands. It is thin, limpid, contains, with the exception of a few epithelial cells, scarcely any formed elements, and is invariably alkaline, except after prolonged fasting, when the first few drops may have a slightly acid reaction from the contained carbon dioxide. Great variation exists in the estimates of its specific gravity, it having been said to vary from 1003 to 1012. It contains scarcely any mucin; when heated to boiling it becomes turbid, as also occurs after the addition of alcohol or mineral acids, showing the presence of an albumen-like body. It becomes clearer when  $\text{CO}_2$  is passed through it. It contains ptyalin. Sulphocyanide of potassium has been said to be absent from the parotid saliva of the horse. The parotid saliva of the dog has a specific gravity of 1004 to 1007, and when heated deposits a slight

sediment of calcium carbonate. When allowed to slowly evaporate on a glass plate, crystals of sodium chloride and calcium carbonate are formed. It is said to contain no diastatic ferment.

The parotid saliva of the horse contains large quantities of lime, and when allowed to stand in the air deposits beautiful crystals of the carbonate of lime. The parotid saliva is largest in amount; the two glands of the ox are said to produce in an hour eight hundred to twenty-four hundred grammes of saliva. As already stated, this secretion is intermittent in the horse and constant in ruminants, where it is closely concerned in the phenomena of gastric digestion.

The diastatic action of the parotid saliva is very active in rodents, but little active in ruminants; absent in the sheep, though in the latter animal, as in the case of the horse and ass, watery infusions of the parotid salivary glands will convert starch into sugar. In carnivora the parotid gland is relatively smaller in amount and is almost inactive.

The following analyses have been made of parotid saliva:—

<i>Man.</i>	
Water, . . . . .	993.16
Solids, . . . . .	6.84
Organic matter, . . . . .	3.44
Chlorides and carbonate of lime, . . . . .	3.40

<i>Dog.</i>	
Water, . . . . .	995.3
Solids, . . . . .	4.7
Organic matter, . . . . .	1.4
Potass. sulphocyanide and alkaline chlorides, . . . . .	2.1
Calcium carbonate, . . . . .	1.2

<i>Horse.</i>	
Water, . . . . .	992.92
Solids, . . . . .	7.08
Epithelium and calcium carb. . . . .	1.24
Soluble matter, . . . . .	5.84
Alcoholic extractives, . . . . .	0.98
Soaps, . . . . .	0.43

<i>Cow.</i>	
Water, . . . . .	990.7
Mucin and soluble organic matter, . . . . .	0.44
Alkaline carbonates, . . . . .	3.38
Alkaline chlorides, . . . . .	2.85
Alkaline phosphates, . . . . .	2.49
Calcium phosphates, . . . . .	0.10

<i>Ram.</i>	
Water, . . . . .	989.0
Mucin and soluble organic matter, . . . . .	1.0
Alkaline carbonates, . . . . .	3.0
Alkaline chlorides, . . . . .	6.0
Alkaline phosphates, . . . . .	1.0
Calcium phosphates, . . . . .	traces.

The parotid saliva of the dog contains 1.818 and 1.701 pro. mil. volumes of combined  $\text{CO}_2$ .

Salivary calculi are formed most usually in the parotid duct from the deposition of lime salts, and contain no other ingredient of the saliva.

2. *The Submaxillary Secretion.*—The saliva of the submaxillary gland may be collected in man by inserting a small cannula in the opening of the duct in the papilla of entrance at the side of the frænum of the tongue, or by aspirating it by a small syringe whose nozzle will grasp the papilla air-tight. In animals the maxillary saliva may be collected by means of a permanent or temporary fistula of the duct of Wharton.

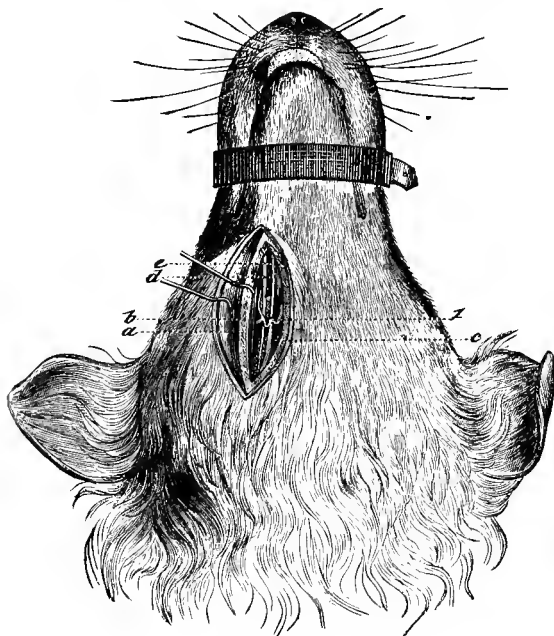

FIG. 115.—OPERATION OF ISOLATING THE DUCT OF THE SUBMAXILLARY GLAND IN THE DOG. (Bernard.)

*a*, digastric muscle drawn to one side; *b*, mylo-hyoid muscle divided and drawn to one side; *c*, duct of Wharton; *d*, duct of the sublingual gland; *l*, lingual nerve.

To discover the submaxillary duct before its entrance into the mouth, after etherization, the hair is shaved from the under surface of the lower jaw, an incision made along the inner border of the ramus of the lower jaw from the anterior insertion of the digastric muscle forward for about two inches, dividing the skin and platysma, every vein that comes into view being tied with two ligatures and divided between them. The mylo-hyoid muscle is then in view, and is to be very cautiously divided at its middle, avoiding the mylo-hyoid nerve, which lies upon it. If the portion still in connection with the ramus of the jaw is elevated, the submaxillary and sublingual ducts will be found running forward

side by side, near to the ramus of the jaw, to enter the mouth, the submaxillary duct being somewhat the larger and lying nearer the jaw; the ducts are crossed by the lingual nerve. Either duct may then be isolated or divided and treated as in making a permanent parotid fistula (Figs. 115 and 116). In the horse, ruminants, and rabbits the operative procedure is about the same as in the dog (Fig. 117).

The submaxillary saliva obtained by catheterization or from fistula

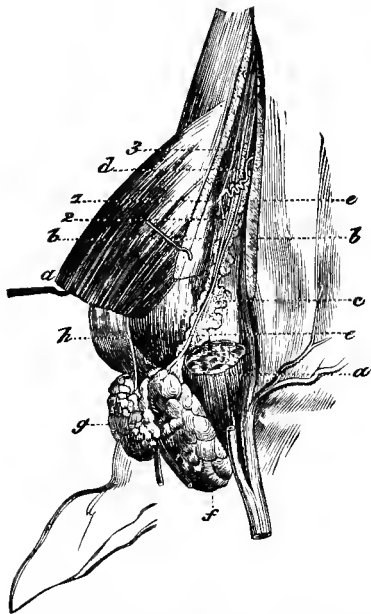

FIG. 116.—ANATOMY OF THE SUBMAXILLARY AND SUBLINGUAL GLANDULAR REGION IN THE DOG. (Bernard.)

*a a*, digastric muscle; *b b*, mylo-hyoid muscle; *c c*, sublingual gland; *d*, sublingual duct; *e*, submaxillary duct; *f g*, submaxillary gland; *l*, lingual nerve; *z*, chorda tympani.

is a limpid, viscid fluid of alkaline reaction. Its density is said to be greater than that of the parotid or mixed saliva, and may rise to 1025 after feeding. According to Eckhard, the submaxillary saliva becomes more consistent when exposed to the air, and will precipitate a flocculent deposit. Corrosive sublimate causes it to become almost gelatinous without becoming turbid. It contains a considerable quantity of mucin, to which this viscosity is due. Albumen seems to be almost absent from the submaxillary saliva, or to be present only in traces, although the xanthoproteic reaction will demonstrate the presence of proteids. The diastatic power of the submaxillary saliva of the dog appears to be but slightly developed in the fresh saliva, although it acquires this property by standing one or two days in the atmosphere. The following tables, after

Lassaigne and Herter, represent the analysis of this secretion—

*In the Horse.*

Water,	992.5
Solids,	7.5
Salts,	2.575
Organic matter,	4.925

*In the Cow.*

Water,	951.14
Mucin and albuminous matter,	3.53
Alkaline carbonates,	0.10
Alkaline chlorides,	5.02
Alkaline phosphates,	0.15
Phosphate of lime,	0.06

*In the Dog.*

Water, . . . . .	994.4
Solids, . . . . .	5.6
Organic matter, . . . . .	1.75
Mucin, . . . . .	0.66
Soluble ash, . . . . .	3.59
Insoluble ash, . . . . .	0.26
Carbonic acid in combination, . . . . .	0.44

The submaxillary saliva of other animals has been less studied than in the dog; that of the rabbit, according to Heidenhain, is clear, not viscid, and alkaline. It does not become turbid when exposed to the atmosphere, contains albuminoids, but no mucin or ptyalin. It contains 1.23 per cent. of solids. The submaxillary saliva of the sheep is strongly alkaline and slightly viscid. The first few drops are turbid, but it then becomes limpid, to again become turbid when exposed to the



FIG. 117.—PAROTID AND SUBMAXILLARY FISTULÆ IN THE HORSE, AFTER COLIN. (*Thanhoffer and Tormay.*)

K K', rubber bulbs for collecting saliva; cs, cannula in the parotid duct.

atmosphere; it contains considerable quantities of albuminoids and a variable amount of mucin, but always less than in the saliva of the dog. The submaxillary saliva of the pig contains no ptyalin. The saliva of the calf and other herbivora, with the exception of the rabbit, is said to be rich in ptyalin. In the submaxillary saliva are found the so-called morphological elements or salivary corpuscles, which appear to be identical with the white blood-corpuscles and possess amœboid movements.

The secretion of the submaxillary glands is not unilateral, as in the case of the parotid, and the side on which the greatest secretion is taking place does not appear to be modified to any great extent by the locality of mastication. The largest amount of submaxillary saliva is secreted at the commencement of a meal and almost ceases during abstinence,—a point of contrast with the parotid saliva. The stimulation of the sense of taste by sapid substances is of the greatest influence on the amount of submaxillary saliva. The following table, compiled by Colin, illustrates these facts:—

*Right Submaxillary Fistula in the Horse.*

Time in Minutes.	Amount in Grammes.	Side of Mastication.	Food.
15	31	Left.	Hay.
15	26	“	“
15	24	“	“
15	22	“	“
15	17	Right.	“
15	23	“	“
15	19	“	“
15	22	Left.	“
15	31	“	“
15	50	“	Oats.
15	23	“	“
15	26	Right.	“
15	26	Left.	“

*Right Submaxillary Fistula in the Cow.*

Time in Minutes.	Amount in Grammes.	Food.
15	110	Hay.
15	85	“
15	65	“
15	70	“
15	80	“
15	85	“
15	70	“
15	90	“
15	70	Salt.
15	20	Juniper-berries.
15	40	Pepper.
15	80	“

*Right Submaxillary Fistula in the Ram.*

Time in Minutes.	Amount in Grammes.	Food.
15	27	Hay.
15	20	“
15	25	“
15	15	“
15	26	“
15	27	“
15	20	“
15	24	Salt.
15	4	Hay.
15	2	Fasting.
15	8	Pepper.
15	28	Salt.
15	28	“

The diastatic power of the submaxillary saliva varies very considerably in different animals. It is active in all the herbivora, with the exception of the rabbit and guinea-pig. In the sheep the submaxillary saliva is more active than that of the parotid, while it is faintly active in the horse, and is almost inactive in the dog when freshly secreted. The general characteristics of the submaxillary saliva vary in different animals under different conditions, and are therefore subject to much contradiction. The secretion reaches its excess during mastication following prehension of food. It is suspended entirely during the mastication of rumination (Colin, Ellenberger, and Hofmeister),—a fact which is very remarkable when it is recollected that the chemical stimulation of the nerves of taste must be then much more marked than in the hurried first mastication. The submaxillary glands are also nearly quiescent in the intervals of rumination; its secretion is called forth by pilocarpine injections, but to a less degree than in the case of the parotid.

It seems almost incomprehensible that the submaxillary, which during rumination remains quiescent, should secrete actively during the

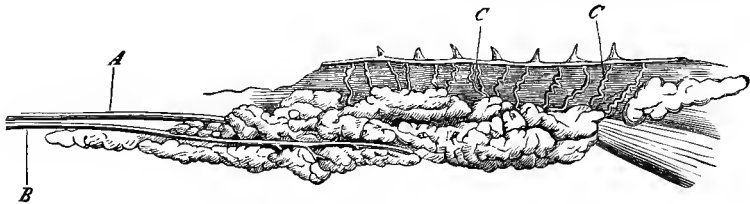

FIG. 118.—SUBLINGUAL GLAND OF THE OX. (*Colin.*)

A, submaxillary duct; B, inferior duct of the sublingual gland; C C, superior sublingual ducts.

mastication of a tasteless foreign body, such as a piece of string or wood (Ellenberger). This fact can scarcely be explained but by supposing that the products of fermentation occurring in the rumen exert an inhibitory influence on the secretory nerves of the submaxillary glands. Its principal function seems to be to assist in the appreciation of the sense of taste, and to act as a lubricant to aid in the first deglutition.

3. *The Sublingual Secretion.*—The collection of pure sublingual saliva is accomplished in the same way as the submaxillary, although in general it is more difficult, excepting in the case of the ox, where the large size of the duct renders the operation very easy. In most animals, however, it is extremely difficult to obtain it in a state of purity, as the gland, especially in the ox, has a number of excretory ducts (Fig. 118). The characters of sublingual saliva may partially be determined by preventing the parotid and submaxillary secretions from entering the mouth by ligating their ducts, and then collecting the fluids in the mouth

by an opening in the œsophagus. Such fluids, of course, are composed of the sublingual saliva, together with the secretion of the buccal glands. The sublingual saliva, obtained in man by the introduction of a fine cannula, is secreted in isolated, clear, very viscid, alkaline drops; hardly enough, however, has been collected to determine its properties. In animals it is very transparent, thick, and so viscid as scarcely to deserve the name of a liquid, and when a cannula is inserted in the duct it flows from the orifice in a continuous thread. It contains 2.75 per cent. of solids, according to Heidenhain, while according to Kühne the proportion may rise to 9.98 per cent. Mucin and sulphocyanide of potassium have been detected in it. It apparently contains no bicarbonate of sodium, as it does not effervesce when acids are added to it. The sublingual secretion is constant, though it is augmented greatly during feeding, and the principal stimuli which call it forth are those which pass through the sense of taste.

In addition to the above secretions, fluid is also poured into the mouth by the various buccal glands. Its characters can only be studied by ligating all the salivary ducts. When this is accomplished in the dog the mucous membrane in the mouth only remains moist as long as the mouth is closed. Dry food is then only with the greatest difficulty masticated and swallowed, and the thirst of such animals is consequently greatly increased. It follows from this that the secretion of the mucous glands of the mouth must be very slight, and, in fact, only one or two grammes may be collected with the greatest care in an hour. It has an alkaline reaction, and has been determined by Bidder and Schmidt to contain 9.98 per cent. of solids. Attempts have been made to study the properties of the secretions of the buccal glands by making aqueous infusions of these glands after death. The superior molar glands, which have been termed the accessory parotids in the ox, give a viscid extract with water, while such an extract of the inferior molars is much less viscid. Very little has been determined as to the properties of these secretions.

4. *General Characteristics of the Salivary Secretion.*—Although it has been seen that each gland differs somewhat in its manner of secreting and in the results of that process, nevertheless, the general salivary system has certain distinguishing characteristics, which have been carefully studied by Colin, according to the principal conditions in which animals may happen to be; thus, the conditions may vary, according as the animal is feeding, ruminating, fasting, or whether stimulating substances are in contact with the mucous membrane of the mouth. During feeding two of the glands secrete actively, though unequally; as has been seen, the parotid on the side of mastication gives double or treble as much saliva as the opposite gland. The amount is also greater



when mastication is rapid, and is therefore greatest at the beginning of a meal, unless after a very prolonged fast, when a certain amount of time seems to be required by the glands to reach their maximum activity. The submaxillary glands secrete together, and each give about the same quantity of saliva, although this amount is not one-third of that secreted by the parotid, even in animals in which these glands appear to be of about the same size. The linguals also secrete together, and the same may be assumed of the molars and other glands. These characters may be determined by making fistulæ of the different excretory ducts of the glands, and so conveying certain portions of the saliva out of the mouth and then weighing the increase of weight in the food in its passage through the mouth to a fistulous opening in the œsophagus. During rumination the parotids have been found by this method, as well as by the production of parotid fistulæ, to pour out a large quantity of fluid, even although the food has been already comminuted and thoroughly moistened in the first mastication and during its sojourn in the rumen. The quantity of saliva is very little less than that poured out by the first mastication, and here also the parotids preserve their alternate, intermittent action; but the food does not pass between the incisor teeth in the second mastication, so these teeth are inactive, and the anterior salivary system remains almost quiescent. Though they continue to secrete, they do not give any more fluid during this time than during abstinence. This is a peculiarity of the salivary secretion during rumination, and shows the relative independence of the different glands. During abstinence new features are met with, which vary in different animals. In the fasting horse the parotids are inactive, and the submaxillaries give only a few drops of fluid, but the mouth is always moist, and the horse will often be seen to swallow the fluids which collect in the mouth, even after fistulæ have been made for both parotids and both submaxillary glands. Hence, by exclusion, the fluid must have come from the linguals, tonsils, and palatine glands. In the fasting ruminants the parotids are not inactive. They pour into the mouth during abstinence about one-eighth or one-fourth as much as they secrete during mastication. Here, also, the submaxillaries secrete little fluid, but the sublinguals, superior molars, and palatine glands, judging by the viscidness of the fluid, must be more or less active. This continued salivary secretion in the ruminant we will find later to be of great importance in aiding the function of rumination. Finally, when stimulated by sapid substances we find marked differences in the response of different glands to these stimuli. The parotids are not sensibly affected, and the glands, which furnish a viscid saliva, are all more or less stimulated, according to the chemical character and intensity of the excitation, and the extent of surface to which it is applied, and its duration.

5. *The Quantity of Saliva.*—As regards the total quantity of saliva and the amounts contributed by the different glands, certain data may be determined in all domestic animals by means of œsophageal fistulæ. To accomplish this, the food is first weighed, then the time of mastication determined, and finally the food is weighed again as it escapes from an œsophageal fistula. By subtracting the weight of the food when given from the weight as it is collected from the œsophagus, the amount of fluid added may be determined. In this way Colin found that a small horse secreted five thousand grammes of saliva in an hour, a medium-sized horse five thousand two hundred grammes, and a large horse in the same time eight thousand eight hundred grammes; from which it may be concluded that a horse feeding on hay secretes from five thousand to six thousand grammes of saliva per hour. If oats are given as food, the amount of saliva poured out is one-third less than the above; only one-half as much is secreted when green fodder constitutes the food, and only one-third as much when roots, such as beets or turnips, are given. Further experiments have shown that dried fodder absorbs four times its weight of saliva, oats a little more than their own weight, meal twice its own weight, and green fodders half their own weight. Hence, the amount of the salivary secretion varies with the amount of moisture contained in the food. It is believed that after twenty-four hours' fasting the salivation is more active at the commencement of the meal than when hunger commences to be satisfied. The reverse, however, is the case for the parotids, as they do not at once reach their maximum activity after a long fast. The above statement, however, seems to hold for the submaxillaries, as they are never completely inactive. But as the parotids secrete the greatest volume of fluid, the food first swallowed is drier, and therefore swallowed with more difficulty than later when the parotids have acquired their maximum activity. Then the quantity of secretion decreases with the activity of mastication.

The quantity of saliva poured out in twenty-four hours may be estimated by means of the preceding data. For if hay absorbs more than four times its weight of saliva, and the horse swallows one hundred grammes of saliva each hour during fasting, it is easy to estimate the total amount secreted. A horse which consumes five thousand grammes of hay and five thousand grammes of dry fodder will require forty thousand grammes of saliva for the deglutition of its food, to which must be added about two thousand grammes for the eighteen hours of abstinence, making in all forty-two thousand grammes, or eighty-four pounds. In the ruminant the total amount of saliva secreted in twenty-four hours is much larger. If we assume that an ox takes three hours in a day to feed and five hours to ruminate, it is found that in six or eight hours forty thousand grammes of saliva are secreted, and during

the sixteen hours of abstinence sixteen thousand grammes are secreted ; in all, fifty-six thousand grammes, or one hundred and twelve pounds. This is certainly an inside estimate. In these animals, also, a less amount is secreted with wet and green food. This immense amount of fluid is again absorbed, and is, therefore, not lost to the economy. The part which each gland plays in the secretion of this volume of fluid is also determinable, and is a point of interest, since we already know that the chemical composition and the function of the different secretions are not uniform. The volume of saliva poured out depends on the dryness of the food, and not, as has been claimed, upon the amount of starch which it contains, indicating that the mechanical uses of the saliva are of greater importance than its chemical functions.

The volume of the special salivary secretions cannot be computed from the volume of the glands. Thus, the parotids of the horse are four times as large as the submaxillary glands, and yet they secrete twenty-four times as much saliva. The parotid of the ox is scarcely as large as the submaxillary, and yet it secretes four or five times as much saliva as the latter. In the horse the parotid furnished seven-tenths of the total amount of fluids poured into the mouth, a fact which may be readily determined by means of œsophageal fistulæ, conjoined with closure of the parotid duct. The submaxillary has been determined by the above method to furnish about one-twentieth of the total salivary secretion. These figures cannot, of course, be taken as being rigorously correct, since the necessary operative procedures must more or less modify the activity of the glands. In the non-herbivora the quantity of saliva is much less. It has been estimated at fifteen hundred grammes in twenty-four hours for a man, while in the dog the parotid has been calculated to contribute twenty-four grammes, the submaxillary thirty-eight, and the other glands twenty-four grammes in twenty-four hours.

6. *The Physiological Rôle of the Saliva.*—The uses of saliva are both mechanical and chemical. Mechanically, it assists in the formation of the bolus of food, after having previously aided its mastication, and acts as a lubricant in its passage to the stomach. It aids the appreciation of taste, and by lubricating the surfaces of the mouth and teeth prevents the adhesion of viscid substances, and in man permits the movements of rapid articulation. In the ruminant animals the entrance of saliva into the paunch is essential for the proper maceration of food, so as to enable its regurgitation to the mouth in rumination.

The chemical action of the saliva on the food was discovered by Leuchs in 1831, who found that the saliva was capable of converting soluble carbohydrates into dextrin and sugar. The cause of this property of saliva lies in the presence of ptyalin, the diastatic ferment of

the saliva, which we have already found to exist in the saliva and the aqueous extract of the salivary glands of most groups of animals.

Experiments as to the diastatic action of the saliva may, therefore, be made either with fresh, filtered saliva, with an aqueous or glycerin infusion of the salivary glands, or with an aqueous solution of pure ptyalin. A mucilage for testing the diastatic action of saliva may be made by mixing one grain of powdered starch into a thin paste with a few drops of cold water, and then adding the paste to 100 cubic centimeters of boiling water and allowing it to boil for ten minutes. Then, after standing until the sediment has settled, the clear supernatant fluid is filtered off and is ready for use. Equal quantities of cold starch-mucilage are poured into three test-tubes, which are numbered one, two, and three; tube No. 1 contains starch-mucilage alone; to tube No. 2 a few drops of filtered saliva are added; an equal quantity of saliva is boiled thoroughly for a few minutes and added to No. 3; in tube No. 4 is poured a small quantity of saliva alone. The four test-tubes are placed in the hot-water bath or an oven at a temperature of about 38° or 39° C. After a few moments the tubes may be removed for testing. If to tube No. 1, which contained starch-mucilage alone, a few drops of dilute iodine solution are added, a characteristic blue color is developed, showing the presence of starch, while Fehling's solution will demonstrate the absence of sugar. If to tube No. 2, which contains starch-mucilage and saliva, a few drops of the same solution of iodine are added, no blue color will be developed, showing the absence of starch, and the fluid will either remain colorless or may take on a more or less marked reddish tint from the presence of dextrin, showing that the starch has disappeared. If to another portion of the same fluid contained in tube No. 2 a few drops of Fehling's solution are added and the fluid boiled, a copious yellowish-red precipitate, due to the reduction of cupric to cuprous oxide, will be formed, showing the presence of a considerable quantity of sugar. Sugar has, therefore, in this test-tube replaced the starch. If a few drops of iodine are added to the fluid of test-tube No. 3, which contained starch-solution and boiled saliva, the reaction of starch will still be developed, and Fehling's fluid will show the absence of sugar. Boiling, therefore, has prevented the conversion of the starch by the saliva into sugar. The fluid of test-tube No. 4, which consists of saliva alone, will give no reaction with iodine, while no sugar will be found with Fehling's test, though the blue color may be turned to a violet from the presence of proteids.

Starch-mucilage, when subjected to the action of saliva at a temperature about that of the blood for a few moments, is converted into sugar. This conversion is not instantaneous, although it was taught by Bidder and Schmidt that momentary contact with saliva and starch was all that was necessary to turn starch into sugar. An experiment which has been long used to substantiate this view, and which appears at first to demonstrate its truth, is really by no means conclusive. The experiment is as follows:—

If into a beaker which contains a little saliva warmed up to 40° C. is added, drop by drop, a solution of starch which has been colored blue by iodine, as each drop falls it is decolorized. The view, however, that the loss of color is due to the conversion of the starch into sugar is erroneous, as was pointed out by Schiff. He showed that the decolorization was due to the conversion by the saliva of the iodine into hydriodic acid, and that many other organic fluids which would not convert starch into sugar would decolorize the iodide of starch; thus, the addition of morphine solution or of dog's urine to the iodide of starch

discharges the blue color of the latter. In neither of these substances is there the property of converting starch into sugar, but the result is due to oxidation of the iodide. There are two practical points to be drawn from this demonstration: first, since the starch is not instantaneously converted into sugar upon contact with the saliva, even though mastication be prolonged, by no means all of the starch in the food can be converted into sugar in the mouth; and, second, starch cannot be considered as a conclusive test for iodine in the various secretions.

It is often desired to test urine for iodine, as in cases of iodism, and all that is deemed necessary is to add a solution of starch-mucilage to the suspected fluid, and if the characteristic blue color does not appear it is concluded that no iodine is present. This procedure is doubly fallacious, not only because these fluids have the power of decolorizing solutions of the iodide of starch, but even when iodine is present it is not in the form of free iodine but of hydriodic acid, the very agent through which this decolorization is effected. If, therefore, iodine is present in such organic fluids, its presence can only be detected by the starch test by first deoxidizing the hydriodic acid. This may be accomplished by soaking a piece of filter-paper in starch-mucilage, drying, moistening with the suspected fluid, and then allowing a drop of nitrous acid to fall upon it. If iodine is present in the form of hydriodic acid, it will be deoxidized by the nitrous acid, and the free iodine will form the characteristic blue color with the starch-paper.

The old view as to the saccharification of starch was based upon the assumption that the diastatic ferment first converted the starch into dextrin, and that then dextrin through hydration was converted into dextrose. This view has been shown to be erroneous by Musculus, who found that the subject is very much more complex. He stated that in the conversion of starch into sugar all the starch was not first transformed into dextrin and then into sugar, but that these two bodies were simultaneously formed, and he gives the following formula as representing this conversion:—

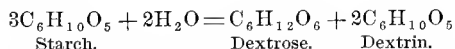

Even this view has, however, been modified by subsequent observation. According to the view of Musculus, only 33 per cent. of sugar could originate from the action of the diastatic ferments on starch, but it has been found that dextrin also is converted partially into sugar, and from 20 to 30 per cent. of sugar may be formed in this way. Estimates of the actual amount of sugar developed through the action of the diastatic ferment on starch show that, instead of 33 per cent., over 50 per cent. of sugar will actually form; so that, therefore, while the starch may first be split up into dextrin and sugar, this dextrin also undergoes partial conversion into a fermentable sugar. Consequently, through the action of ptyalin, starch is first converted into dextrin and sugar, and then the dextrin itself, through the action of the ferments, undergoes subsequently a progressive hydration and results in the

formation of a further quantity of sugar. In this conversion a number of by-products are formed, which behave differently to iodine and to the sugar tests, and in their action on polarized light. The following table shows these changes in outline:—

	Rotation.	Reducing Power.	Behavior with Iodine.	Other Tests.
1. Soluble starch,	218°	6	Blue.	Precipitated by tannic acid and alcohol.
2. Erythrodextrin,	. .	. .	Red.	Not precipitated by tannic acid and alcohol.
3. Achroodextrin,	210	12	Colorless.	“
“	190	12	“	“
“	150	28	“	“
4. Maltose,	150	61	“	“
5. Grape-sugar,	58	100	“	“

If a little saliva be added to warm, thick starch-paste, in one or two minutes the thick mucilage will be converted into a thin, watery fluid, which will not yield either a dextrin or sugar reaction; it will still give a blue with iodine. This is, therefore, the first stage in the diastatic action of saliva on starch—the formation of soluble starch. If a longer time is allowed to elapse before the testing is performed, sugar may then be found in the fluid, even though it gives a distinct blue with iodine. A few minutes later, testing will show the presence of a larger quantity of sugar, and if iodine be added a blue color will be produced; but on diluting this and adding more iodine a violet color will appear, showing the presence of erythrodextrin, together with soluble starch and sugar. After a short time iodine ceases to give a blue, but yields a deep-red color, which later still yields to a yellowish-brown color, and finally no color at all on the addition of iodine, while all the time the quantity of sugar goes on steadily increasing. These reactions show that the soluble starch gives place to erythrodextrin, giving a red with iodine, and finally to achroodextrin, which has no color reaction with iodine; while, from the fact that the sugar continually increases as these substances disappear, it is evident that the sugar results from the progressive conversion of these different forms of erythro- and achroodextrin into dextrose, or some other form of sugar. Musculus and O'Sullivan have proved that the sugar which results from the action of diastatic ferments on starch is *maltose*, which is a fermentescible sugar belonging to the group of saccharoses, having a formula of  $C_{12}H_{22}O_{11}$ . This substance rotates the plane of polarized light  $150^\circ$  to the right, while dextrose has only a rotatory power of  $+58^\circ$ , while it has a reducing power for the cupric oxide sugar test of  $61^\circ$ , as compared to grape-sugar, which may be placed at  $100^\circ$ .

In order to explain the above results it is necessary to assume that the molecule of soluble starch is a composite molecule, composed of

several members of the starch group  $C_{12}H_{20}O_{10}$ , and the assumption that the molecule of soluble starch has the formula of  $10(C_{12}H_{20}O_{10})$  greatly facilitates the comprehension of the progressive hydrolysis of starch by diastase (Brown and Heron).

According to this view, the composite molecule of soluble starch is resolved through the action of diastase into two molecules of achroodextrin and eight molecules of maltose by the following succession of steps:—

$$\text{One molecule of soluble starch} = 10(C_{12}H_{20}O_{10}) + 8(H_2O) =$$

1.	Erythro-dextrin,	<i>a</i>	$9(C_{12}H_{20}O_{10}) + (C_{12}H_{22}O_{11})$	maltose.
2.	“	<i>β</i>	$8(C_{12}H_{20}O_{10}) + 2(C_{12}H_{22}O_{11})$	“
3.	Achroodextrin,	<i>α</i>	$7(C_{12}H_{20}O_{10}) + 3(C_{12}H_{22}O_{11})$	“
4.	“	<i>β</i>	$6(C_{12}H_{20}O_{10}) + 4(C_{12}H_{22}O_{11})$	“
5.	“	<i>γ</i>	$5(C_{12}H_{20}O_{10}) + 5(C_{12}H_{22}O_{11})$	“
6.	“	<i>δ</i>	$4(C_{12}H_{20}O_{10}) + 6(C_{12}H_{22}O_{11})$	“
7.	“	<i>ε</i>	$3(C_{12}H_{20}O_{10}) + 7(C_{12}H_{22}O_{11})$	“
8.	“	<i>θ</i>	$2(C_{12}H_{20}O_{10}) + 8(C_{12}H_{22}O_{11})$	“

The final result is thus represented by the equation:—

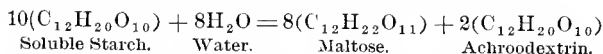

Through the action of the diastatic ferment, therefore, the large molecule of gelatinous starch is first separated into its component molecules of soluble starch, and if we assume that this composite molecule of soluble starch is composed of an aggregation of ten groups of the radical  $C_{12}H_{20}O_{10}$ , then progressively each one of these radicals assumes one atom of water and becomes a molecule of maltose, the remainder of the starch molecule, at the withdrawal of each radical, constituting one molecule of the intermediary dextrin series. The dextrin molecule thus becomes smaller and smaller, that is, contains fewer and fewer component radicals, the higher dextrans giving a red with iodine, while the lower dextrans give no reaction with iodine (Roberts).

In order that starch should be converted by saliva into sugar, it is necessary that the fluid be kept at the temperature of about 39° or 40° C. A temperature elevated above this will prevent conversion by destroying the ferment, while a lower temperature will retard it, and the temperature of freezing will prevent it completely, although the power is not lost and may be regained when the temperature is again elevated. This transformation is produced in a neutral or feebly alkaline medium, and also, though to a much less degree, in a weak acid medium. An excess of alkali, or even a slight degree of acidity (half of 1 per cent. of hydrochloric acid), will prevent it completely. This is a point worthy of note, since it indicates that the degree of acidity present in the gastric juice during active digestion is sufficient to interrupt the action

of ptyalin on starch. It will be found, however, that hydrochloric acid does not appear in the gastric juice of the horse until the latter stages of gastric digestion, the acidity in the early stages being due to the presence of lactic acid. It has further been proved that lactic acid, even when present in 2 or 3 per cent., will not arrest the conversion of starch by the saliva. Therefore in the horse starch may still be converted in the stomach into sugar. In the ruminant animal all the starch is probably converted into sugar in the rumen, where the reaction is alkaline, and here also, therefore, the acidity of the gastric juice does not interfere with the digestion of starch, even though it may not take place in the stomach, whatever starch escapes the saliva being acted on by the pancreatic juice. In carnivora, where the gastric juice is highly acid, starchy matters seldom enter into the composition of their food, while in the omnivora, man especially, the saliva possesses a higher diastatic power than in other animals; therefore the conversion of starch in the mouth will be much more rapid, and even though suspended in the stomach, is again resumed in the small intestine under the action of the pancreatic juice. So, also, when the amount of sugar formed reaches from  $1\frac{1}{2}$  to  $2\frac{1}{2}$  per cent., saccharification is arrested, but will be renewed when the fluid is diluted. The transformation of boiled starch mucilage is very much more rapid than that of raw starch. This is due to the fact that it is only the granulose of the starch granules which is converted into sugar. In the raw starch granules the granulose is contained in an unyielding cellulose envelope, and is not accessible to the salivary ferment. When starch is boiled the cellulose envelopes are ruptured; the granulose then passes partly into solution, and is then readily acted on by the saliva.

The diastatic action of the saliva of different animals varies very considerably. In almost all it is less active than in man, with the possible exception of the saliva of the herbivora. The latter appears to be more active on raw starch than that of the carnivorous animals. Thus, it has been found that the saliva of the horse will convert crushed raw starch into sugar in one-quarter of an hour, and it has been proved experimentally that in the horse the conversion of raw starch into sugar, through the action of the saliva, takes place in the stomach. It is worthy of note that the individual salivary secretions of the horse appear to possess this amyolytic power to a less degree than the mixed saliva. It has been, however, found that, in addition to acting on starch, the saliva of the horse is also capable of converting cane sugar into grape sugar. The saliva of the horse is further inactive on the cellulose of hay.

Examination of the substances escaping from an œsophageal fistula in the horse fed on starchy food shows that practically no conversion of starch into sugar occurs in the mouth. This, indeed, would be ex-



pected from the fact that raw starch requires several minutes' contact with the saliva of the horse to be converted into sugar. It is not to be therefore concluded that the amyolytic power of the saliva is of no practical value, since it will be found that in the horse the chemical action of the saliva may continue in the stomach.

In the ruminants the diastatic action of the saliva is probably about the same as that of the horse, but the conditions for the conversion of starch into sugar are more favorable, since the saliva is constantly being secreted, constantly swallowed and carried to the rumen, where it meets with the most favorable conditions for acting on the starch—in other words, an alkaline medium considerably diluted and an elevated temperature.

Of the other animals, the following series represents the diastatic action of the saliva, it being most marked in the first animal and least in the last: hog, rat, rabbit, cat, dog, sheep, and goat. In all the domestic animals the parotid saliva possesses the highest degree of amyolytic power. The orbital gland of the dog appears to produce no amyolytic ferment. All the so-called antiseptics and stronger chemical agents prevent the action of the salivary ferment. The duration of the action of human saliva on raw starch before the presence of sugar can be detected is as follows: On potato-starch, after two to four days; on starch from peas, after one and one-third to two hours; on wheat-starch, after one-half to one hour; on barley-starch, after ten to fifteen minutes; on oat-starch, after five to seven minutes; on rye-starch, after three to six minutes; on corn-starch, after two to three minutes.

If raw starch is finely comminuted, as by grinding with powdered glass, the time of the reduction is considerably reduced.

Extracts, or the secretion of the different salivary glands in the domestic animals, are entirely inert on fats, proteids, and cellulose.

7. *The Mechanism of the Salivary Secretion.*—The numerous investigations which have been undertaken to explain the mechanism of salivary secretion have yielded results of far more importance than that which they possess as bearing upon the secretion of saliva alone. It is from the results of these experiments that has been deduced all our knowledge of glandular secretion, its dependence upon the nervous system, and its relation to the circulation. In the case of the saliva it has already been mentioned that, under ordinary circumstances, in all animals the secretion of the saliva is either remittent or intermittent. In other words, as a rule but enough saliva is poured into the mouth during abstinence to keep the surfaces moist. When, however, food is taken into the mouth and the process of mastication commenced, or in the ruminant animal during the process of rumination, the secretion of the salivary glands is at once greatly increased in activity. Further, allusion has been made to the fact

that the quantity of saliva poured out varies under many different circumstances, as to the character of the food, and the side on which mastication is taking place. It might be already concluded from this, that the secretion of saliva is a reflex action and is under the control of the nervous system. As long ago as 1832 Mitseherlich, from studies made on a patient with a salivary fistula, first suggested that the salivary secretion was under the influence of the nervous system, and in support of that statement alluded to the fact that while the secretion of saliva was independent of the will, it might be called forth by stimulation of the mucous membrane of the tongue and mouth, either chemically or

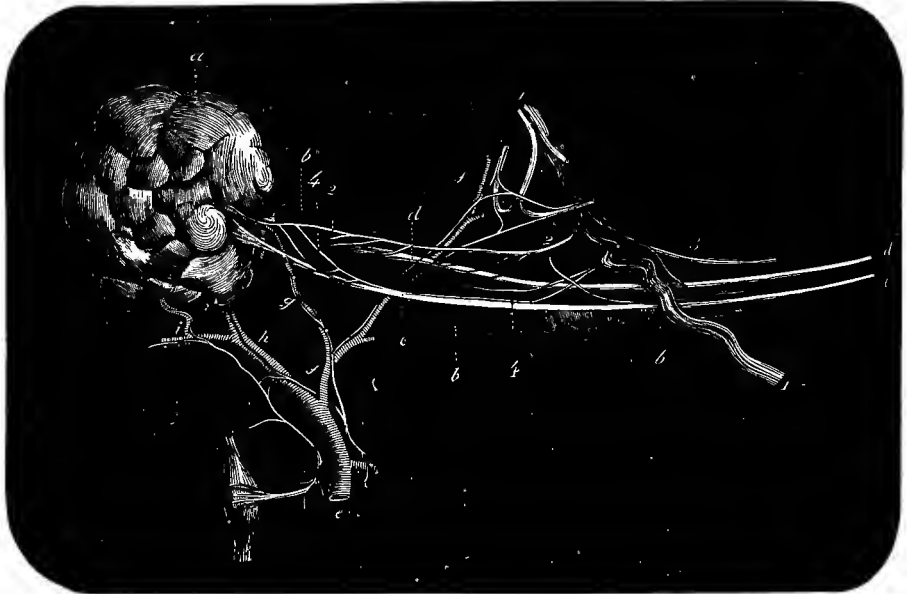

FIG. 119.—NERVES OF SUBMAXILLARY AND SUBLINGUAL GLANDS. (Bernard.)

*a*, submaxillary gland; *c c*, duct of Wharton; *i h g*, arterial branches to the submaxillary gland; *b*, sublingual gland; *d d*, sublingual duct; *1 l*, lingual nerve; *2 2*, chorda tympani; *e*, carotid artery, on which ramify fibres coming from the superior cervical ganglion; *f*, internal maxillary artery.

meehanically, stimulation of the nerve of smell, or stimulation of the gastric mucous membrane by the food. It thus is clear that the secretion of saliva is a reflex action, for which there must be an afferent fibre, an independent nerve centre, and an efferent fibre. From the fact that the submaxillary gland is the most exposed, and, therefore, the most readily operated on, the influence of the nerves on the secretion of saliva has been most studied in the case of this gland. The afferent nerve fibres of this reflex circle, in the case of the submaxillary gland, are the lingual branch of the fifth pair and branches of the glosso-

pharyngeal—the nerves of taste. The centre is in the medulla oblongata and the efferent fibre is the chorda tympani, a branch of the seventh—the facial—nerve (Fig. 119). The influence of these nerves on the secretion of saliva is readily proved by experiment.

The animal on which this experiment is usually performed is the dog. The operation is performed as follows :—A large dog is chloroformed and fastened in Bernard's dog-holder. The hair is shaved from the lower surface of the jaws and the side of the neck, and an incision made along the lower border of the lower jaw, commencing about its anterior third and extending back to the transverse process of the atlas, dividing the skin and platysma muscle. After clearing away the connective tissue and fat, carefully avoiding the veins, the submaxillary gland comes into view just below the angle of the jaw. It is then seen that the gland lies in the angle formed by the junction of the two veins which go to make up the external jugular vein (Fig. 120), one branch coming from above downward directly behind the gland, and usually receiving a small vein from the gland itself, while the lower branch runs horizontally below the gland, and is formed by the junction of two other branches, one coming from above and the other from below. The horizontal branch also very constantly receives a vein from the

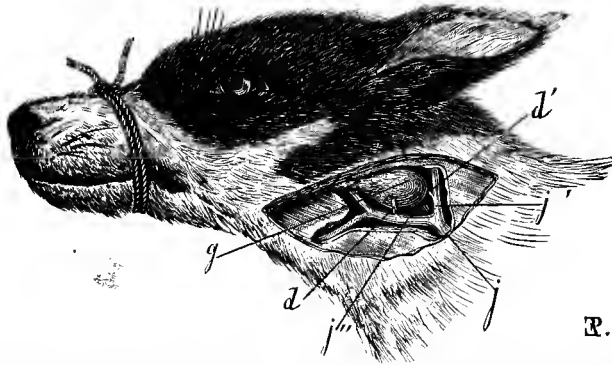

FIG. 120.—VEINS OF THE SUBMAXILLARY GLAND OF THE DOG. (Bernard.)  
*g*, submaxillary gland; *j*, external jugular vein dividing into two branches; *j'* and *j'''*, veins which surround the gland; *d*, anterior glandular vein; *d'*, posterior glandular vein.

gland. Both branches which go to form the horizontal branch are tied, the one coming from above receiving a double ligature where it comes from the ramus of the jaw, and the other where it joins its fellow, the intermediate portion being removed. After having carefully removed the cellular tissue from the portion of the wound in front of the gland, the thick belly of the digastric muscle comes into view, its fibres running forward from its origin in the temporal bone to be inserted in the middle third of the ramus of the lower jaw immediately in front of the insertion of the masseter, from which muscle it is separated by a slight groove. In front of the digastric, the floor of the wound is formed by the transverse fibres of the mylo-hyoid muscle, crossed by the mylo-hyoid nerve, which comes out from under the jaw at the point of insertion of the digastric muscle. The connective tissue is then gradually to be cleared away with a blunt hook from the surface of the digastric muscle and from the groove between it and the masseter muscle, taking care to avoid, as the deeper portion is reached, the facial artery, which passes over the jaw to run between these muscles, and the artery of the gland, which comes from the facial artery and goes in this groove back to the gland. In the same locality lie also the ducts of the gland and the chorda tympani nerve. The digastric muscle is now to be separated by means of an aneurism needle from the facial artery, avoiding all the adjacent structures, and its muscular arterial branch tied. The muscle is then divided at its anterior third,

or where it is inserted into the jaw, and its posterior extremity seized with a pair of artery forceps and gradually cleared back to its insertion in the temporal bone and surrounded by a ligature. When it is assured there is nothing but muscular structure in the grasp of the ligature, it is pushed back to the temporal bone and tied, and the digastric muscle divided in front of the ligature and removed. On carefully tearing away the connective tissue at the base of the wound and drawing back the submaxillary gland, there is exposed a triangular cavity (Fig. 121). This space is limited above and behind by the under surface of the submaxillary gland, into the hylum of which enter the artery, chorda tympani and sympathetic nerve fibres, and the glandular duct. Its lower margin is formed by the genio-hyoid muscle, and its upper border by the ramus of the jaw and the masseter muscle. The anterior portion of its floor is formed by the transverse fibres of the mylo-hyoid muscle, on which ramify the branches of the mylo-hyoid nerve. At the posterior portion of this space the external carotid artery enters and runs along the base of the triangle, giving off first the lingual and then the

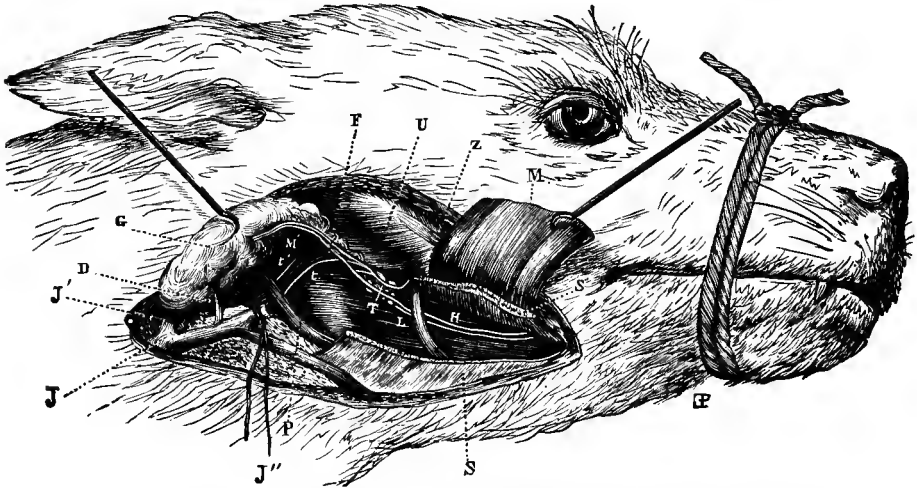

FIG. 121.—PARTS EXPOSED IN OPERATIONS ON THE SUBMAXILLARY GLAND OF THE DOG. (Bernard.)

M, anterior portion of digastric muscle elevated with a tenaculum; M', posterior extremity of the digastric raised up so as to show the carotid artery, *t t*, and the sympathetic filaments; G, submaxillary gland elevated to show its posterior surface; H, submaxillary and sublingual ducts; J, external jugular vein; J', posterior branch; J'', anterior branch; D, glandular vein; F, origin of inferior glandular artery; P, hypoglossal nerve; L, lingual nerve; T, chorda tympani; S S', divided mylo-hyoid muscle; U, masseter muscle at angle of lower jaw; Z, origin of mylo-hyoid nerve.

facial arteries, from off the latter of which comes the artery of the gland. Almost immediately after entering this space the carotid is crossed by the large hypoglossal nerve, running forward to be distributed to the muscles of the tongue. If this nerve is divided at the point where it crosses the carotid, and the central end removed, the pneumogastric nerve comes into view, lying behind the artery. On pulling to one side the vagus trunk, below and behind it can be seen the white trunk of the sympathetic nerve, which here separates itself from the vagus to form the superior cervical ganglion, from which two small filaments pass out to accompany the carotid and the artery of the gland to enter the hylum. Some of the sympathetic fibres also pass into the gland along the arterial branch which comes from the temporal branch, and enter the exterior part of the gland. Then, to expose the chorda tympani and salivary ducts, the fibres of the mylo-hyoid muscle are to be divided transversely at about their middle, avoiding every nerve, but tying all veins, and the upper half of the muscle reflected. The lingual nerve then comes into view, passing from under the ramus of the jaw and running

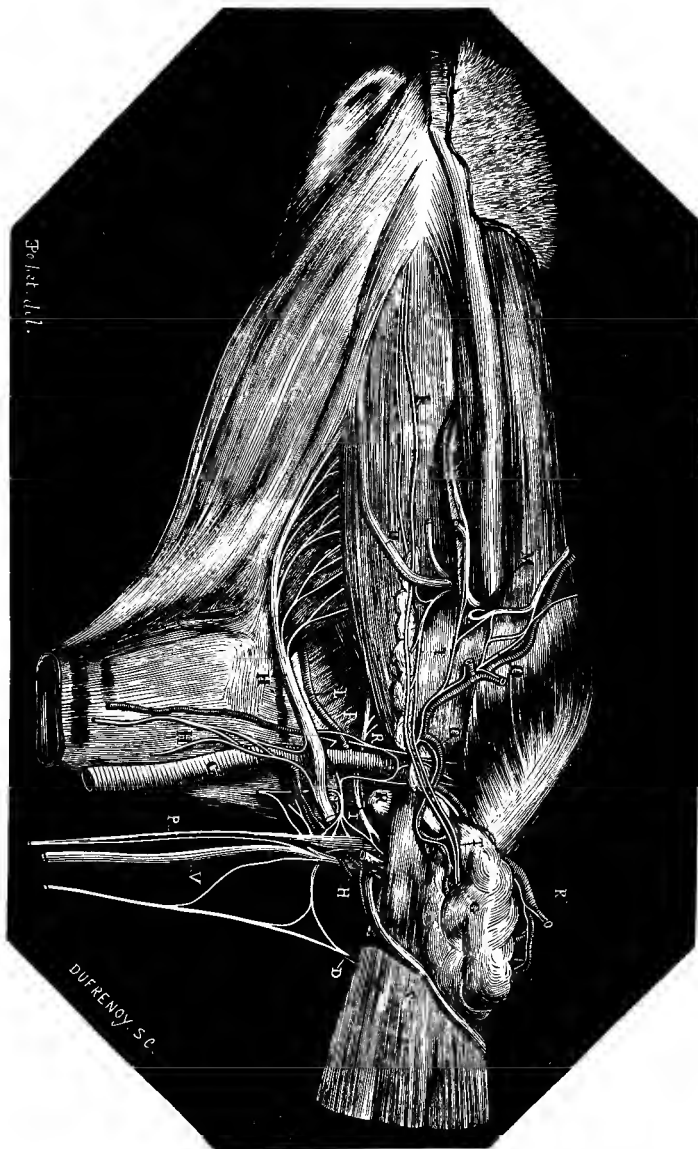

FIG. 122.—NERVES OF THE SUBMAXILLARY GLAND IN THE DOG. (Bernard.)

G, submaxillary gland; K, submaxillary duct; C, primitive carotid; L, lingual artery; O, glandular artery, branch of the facial; H H', hypoglossal nerve divided so as to show the superior cervical ganglion; V, pneumogastric nerve; P, sympathetic fibres; D, fibre from the first pair of cervical nerves; R R, glosso-pharyngeal nerve; I, anterior filaments of the superior cervical ganglion, forming the carotid plexus; P, fibre going to the submaxillary gland; Q, sympathetic filaments; M, mylo-hyoid nerve; U, lingual nerve, giving off the chorda tympani, T, which, after anastomosing with the sympathetic filaments, is distributed to the submaxillary gland; S, external branch of the spinal accessory nerve.

downward and forward, about parallel in direction with the hypoglossal. On drawing the parts toward the middle line, the two salivary ducts are seen passing along close together, immediately below the ramus of the jaw, the submaxillary duct lying nearer the bone and being a little the larger. On tracing back the lingual nerve to where it passes from under the jaw, it will be seen that a delicate nerve-filament here leaves the lingual and curves backward along the ducts to enter the hylum of the gland. This is the chorda tympani. Immediately after the chorda leaves the lingual there is sometimes seen a small ganglionic enlargement, known as the submaxillary ganglion, and as the chorda tympani enters the hylum it forms a slight ganglionic plexus with the sympathetic. The nerve- and blood-supply of the submaxillary gland of the dog are further shown in Fig. 122. Each of these nerves which it is desired to study should be carefully isolated and surrounded with a thread, and a cannula should be inserted into the submaxillary duct. To facilitate this, the duct should be freed slightly from the connective tissue, and closed with a clip or ligature; as the gland is passive, the chorda should be stimulated with a very weak electric current for a few seconds, so as to distend the duct with saliva, and a small slip of wood passed under it to act as a support. If the duct is then seized with a pair of fine forceps and snipped with a pair of sharp-pointed scissors, a cannula may be readily inserted.

The above is the mode of operation employed by Bernard, and permits of the performance of all the more important experiments on the physiology of the secretion of the submaxillary gland. Where it is simply desired to demonstrate the secretory action of the chorda tympani nerve, the operation may be greatly simplified by simply cutting directly down on to the mylo-hyoid muscle, dividing its fibres transversely, and exposing the ducts and chorda tympani nerve by turning the parts back toward the ramus of the jaw. In the sheep, the operation may be performed in the same manner, the duct originating in the union of a number of roots. In the rabbit the operation is much more difficult, from the extreme fineness of the duct and the fact that it is surrounded by the tissue of the sublingual gland.

After having performed the operation as detailed above, the first point which should be demonstrated is the fact that the secretion of saliva is a reflex action, and that the reflex circle is as stated above. If a few drops of vinegar are placed upon the tongue of a dog provided with a submaxillary fistula, almost immediately a profuse secretion of saliva will set in, and the fluid will run from the mouth of the tube. If the trunk of the lingual nerve is divided near its entrance to the mouth, and then vinegar or acetic acid placed on the animal's tongue, no secretion will result, unless the stimulating fluid reaches the back of the mouth, where it may come into contact with the terminal fibres of the glosso-pharyngeal nerve. If the central end of the divided lingual nerve is stimulated with a weak electrical current, a profuse secretion of saliva will be set up. Therefore the lingual nerve, and, to a certain extent, the glosso-pharyngeal, constitute the afferent path by which the sensory impressions necessary for the reflex action of saliva reach the brain. The nerves of taste are, therefore, the afferent nerves for the secretion of saliva. The nerve centre lies in the medulla oblongata, and there probably exclusively, although Bernard thought that he had shown that, under certain circumstances, the submaxillary ganglion might act as a reflex centre for this process. The efferent nerve is the chorda tympani. This nerve is a delicate filament which leaves the trunk of the facial nerve in the Fallopian canal about four or five millimeters

before it passes out of the stylo-mastoid foramen, and then, arching upward and forward, enters the middle ear, which it traverses from behind forward, lying within the thickness of the membrana tympani. Here for a space of six or eight millimeters the nerve is comparatively isolated, lying between the handle of the malleus and the vertical process of the incus. It then passes toward the Glaserian fissure, and leaves the skull in the neighborhood of the spine of the sphenoid bone to join the lingual nerve. It has already been stated that stimulation of the central end of the lingual nerve calls forth a secretion of submaxillary saliva. If, however, the chorda tympani nerve be previously divided, stimulation of the lingual is without effect.

The simplest method of dividing the chorda tympani nerve is to cut it where it crosses the tympanum. This may be accomplished by introducing a small sickle-shaped knife into the external auditory canal, the animal being profoundly chloroformed, keeping the cutting edge upward, and passing the back of the blade downward and forward along the inferior wall of the meatus until the tympanum is reached. Pushing the blade through the tympanum, the knife is inserted in the middle ear, and on depressing the handle of the knife in this position the nerve is divided.

The fact that the chorda tympani constitutes the efferent nerve in this reflex circle is not only proved by the experiment just alluded to, where its division prevents the flow of saliva after stimulation of the lingual, but may be positively demonstrated by its stimulation. If the chorda tympani nerve is directly stimulated with a weak induced electrical current just after it leaves the lingual trunk, in a few seconds the saliva begins to flow from the cannula, and runs in quite a stream.

It has thus been shown that the secretion of submaxillary saliva is a reflex nerve mechanism; that the sense of taste is the normal stimulus, and that this stimulus reaches the brain through the fibres of the lingual and glosso-pharyngeal nerves, and is transmitted to the gland from the medulla through the fibres of the chorda tympani nerve. We have now to study the mechanism by which saliva is separated by the gland from the blood and the influence of the various nerves and different conditions of the circulation on this process.

If the submaxillary gland is exposed as described above, and the chorda tympani nerve stimulated, not only is there a copious secretion of saliva, but the appearance of the gland itself undergoes great change. If examined before the nerve is stimulated, the gland will usually appear pale. A few arborescent vessels will be seen upon its surface, and the blood which leaves the gland is dark, and the vein small. When, however, active secretion is produced through stimulation of the chorda tympani nerve the surface of the gland becomes rosy red. Numerous branching vessels are seen. The blood that flows from the gland is almost arterial in hue, is much larger in quantity, and the veins are seen

to pulsate synchronously with the heart. Evidently, then, stimulation of the chorda tympani nerve increases the blood-supply of this gland, either through an active dilatation of the vessels, or more probably through an inhibition of a local vaso-motor centre. An analogous result will be seen in the case of the depressor nerve, a nerve whose stimulation produces paralysis of the vaso-motor centre and consequent dilation of the blood-vessels. Two results then follow stimulation of the chorda tympani,—an abundant secretion of saliva and a marked hyperæmia of the gland. Before, however, the relation between these results are discussed, the influence of the sympathetic nerve on the submaxillary gland must be alluded to.

As is well known, a constant result of stimulation of a fibre of the sympathetic system is a contraction of the arterioles, and a consequent diminution of the supply of blood in the parts supplied by the nerve. If the filament which leaves the superior cervical ganglion and passes to the submaxillary gland along the carotid is irritated with a weak induction current, there is a momentary flow of saliva, and the character of the secretion so produced differs from that which follows stimulation of the chorda. Sympathetic saliva is very viscid, and can be drawn out in a long thread from the orifice of the cannula. It is of higher specific gravity and richer in organic elements than that which follows stimulation of the chorda. In other words, the chorda saliva contains a maximum quantity of water and a minimum of organic elements, while in sympathetic saliva the proportions are reversed. So, also, the effects of the sympathetic stimulation on the blood-supply of the submaxillary gland differ from those of the chorda tympani. If the sympathetic filament is irritated, the arborescent vessels, especially over the surface of the gland, disappear, and the tissue of the gland becomes pale and the vein of the gland contracted and carrying a small quantity of black blood. In fact, therefore, in both respects the function of the sympathetic and chorda tympani nerves are antagonistic; and if each nerve be stimulated alternately at short intervals with the current which applied alone to either nerve would produce its characteristic effect, there is no result. Evidently, then, there is a complete opposition in function in these two nerves. But is the secretion of saliva simply dependent upon the vascular condition of the glands? Does the gland act as a sponge, filtering out the saliva from the material within the gland, the quantity being solely dependent upon the quantity of blood in the organ; or is there some special function possessed by the cells of the salivary glands, by which the saliva is separated from the blood without being dependent solely upon the supply of blood? In other words, what is the mechanism by which the salivary glands separate the salivary secretion from the blood? We know that as the blood passes through the capillaries of the systemic



circulation it not only loses in oxygen and gains in carbon dioxide, but there is also an actual reduction in the amount of fluid, due to the transudation of the serum of the blood into the lymph-spaces. Such transudation is due solely or mainly to blood-pressure, and does not constitute a permanent loss to the blood; for the fluids so poured out into the lymph-spaces serve largely to nourish the tissues, and are then pushed on into the lymphatic vessels by fresh quantities coming after them, and finally again reach the veins, and thus re-enter the circulation. Such transudations pervade all tissues, but in glandular organs not only is there a constant loss from the nourishment of the tissues forming the glands, but the secretions are produced at the expense of these filtrates from the blood-vessels into the lymph-spaces of the glandular tissue. Secretion is, thus, the passage of the substances from lymph-spaces to the exterior of the body, for, as has already been referred to, the alimentary canal may be regarded as such.

Various views have been proposed to explain the passage of the constituents of the lymph so transuded from the blood-vessels into the excretory ducts of the glands. The blood-pressure is evidently concerned in forcing the serum of the blood through the walls of the capillaries into the lymph-spaces, but here the blood-pressure ceases to be of influence. For if a manometer is inserted into the submaxillary duct of a dog and the chorda tympani nerve stimulated, the pressure in the salivary duct will be found to be greater by far—one-third greater, at least—than that of the carotid artery. Where, therefore, the pressure is greater on the side of the excretory duct, blood-pressure of course can be of no avail in causing the passage of the fluids through the glandular tissue into that duct. Osmosis may to a certain extent be concerned in producing the passage of the fluid through the gland-membrane, though there are scarcely any data in favor of this view other than that which is conceded in the fact that the stimulation of the chorda tympani nerve may result electrolytically in the production of certain decomposition products which, having a strong affinity for water, might extract water from the lymph-spaces into the gland-cells. The production of heat in secretion to a certain extent favors this view, since it has been found that the temperature of the saliva in the salivary duct may be one degree or more higher than that of the blood. Secretion of saliva can, thus, not be a process of mere mechanical filtration; for not only do we find, as already mentioned, the greater pressure on the side of the salivary duct, and an actual formation of heat in the secretion, but the secretion may even take place in the absence of the circulation. Thus, if the chorda tympani is isolated in the rabbit, and the animal then rapidly decapitated, the flow of saliva may still take place on stimulation of the chorda, and it may produce in a few moments double

the weight of the gland in saliva, even although, of course, the circulation has been arrested. Then, again, the action of various drugs on the salivary gland show the independence, to a certain degree, of the vaso-motor and secretory effects of the stimulation of the chorda tympani. If fifteen milligrammes of atropine in solution are injected into the jugular vein of a dog and the chorda tympani nerve then stimulated, there is no flow of saliva, but, on examining the gland, the vaso-motor phenomena which were present under the same circumstances before the atropine was injected may be seen. In other words, vascular dilatation follows stimulation of the chorda tympani nerve after the administration of atropine, while the secretion of saliva is prevented. Then, again, by means of pilocarpine the paralyzing effect of the atropine may be antagonized and the gland may be made to secrete. The dose of pilocarpine which, when introduced into the general circulation, would be able to remove the effects of atropine would probably be fatal to the animal. If, however, the drug is allowed to enter the circulation of the gland, a much smaller quantity will be efficient without danger to the animal. Thus, if seventeen milligrammes of pilocarpine are injected into the sub-maxillary duct after atropine poisoning and the chorda tympani then irritated, a slight secretion will be produced, passing off again as the stronger effect of the atropine makes itself felt. Then, again, the activity of the secreting cells may be paralyzed, and the circulatory changes produced by certain drugs, such as sodium carbonate in 5 per cent. solution or hydrochloric acid in  $\frac{1}{10}$  per cent., injected into the duct; but as the increased pressure leads to transudation, and as the cells cannot secrete, œdema of the gland is rapidly produced when the chorda is stimulated. Further, quinine injected into the duct influences vaso-motor changes, although no secretion is produced even though the secretory fibres of the chorda are not paralyzed. Evidently, then, the chorda tympani nerve must contain two sets of fibres,—the one vasodilator, not paralyzed by atropine, and the other the secretory fibres, paralyzed by that poison. It is only by the existence of a class of nerves which act through calling into activity the protoplasmic energy of the secreting epithelial cells that these effects can be explained. When the chorda is irritated two sets of impulses travel along the nerve, one impulse acting on the blood-supply of the glands, while the other acts on the secretory elements of the epithelial cells in a manner analogous to that which occurs when a motor nerve going to a muscle is irritated—the muscle contracts through the stimulation of the contractile elements of the muscle-cells, and the blood-vessels dilate through vaso-motor influence. The result in both cases is probably of an electrolytic nature, with the production of acid or alkaline decomposition products, and these may serve as stimuli to the cells themselves, in the same way

as when the same products (compounds of lactic or phosphoric acid with lime) are directly brought into contact with the muscles. Indeed, we may carry the parallelism still further, for we know that curare, by destroying the irritability of the motor nerves, will prevent contraction of all the muscles when their nerves are stimulated, in the same manner that atropine will prevent the secretion of the gland when its secretory nerve is stimulated. In both instances the vaso-motor phenomena remain.

In the case of the parotid gland the circulation during secretion undergoes the same changes as in the case of the submaxillary. Here,

also, secretory and circulatory nerves have been determined. Vaso-constrictor fibres have been found in the sympathetic branches distributed to the parotid gland, while the glosso-pharyngeal, according to Heidenhain, contains fibres whose stimulation leads to a dilatation of the parotid blood-vessels. Both the facial and the glosso-pharyngeal nerves contain fibres whose stimulation leads to parotid secretion, and if the auriculo-temporal nerve is stimulated the secretion at once commences; if divided the secretion stops. It has been found, however, that the trigeminal nerve is not the source of these secretory fibres, for when the trigeminal is stimulated within the cranium no parotid secretion results. They are consequently derived from the facial nerve, and when this latter nerve is stimulated within the cranium parotid secretion results (Fig. 124). The passage of these glandular fibres from the facial

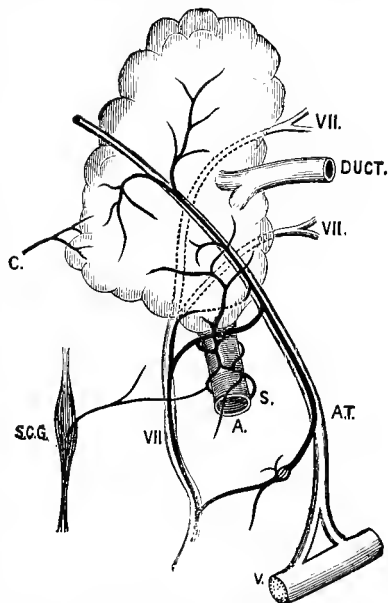

FIG. 123.—DIAGRAM OF NERVES SUPPLYING THE PAROTID GLAND. (Yeo.)

The dark lines indicate the course of the nerves of the gland. V, inferior division of fifth cranial nerve and its (AT) auriculo-temporal branch; VII, portio dura; SCG, superior cervical ganglion sending a branch to the carotid plexus around the artery.

into the auriculo-temporal nerve has been explained in the following manner by Bernard: If the facial nerve is divided at its exit from the stylo-mastoid foramen, and the central end divided, parotid secretion is produced, while stimulation of its peripheral extremity is without effect. The secretory fibres do not pass through the chorda tympani, as was formerly believed, for section of the chorda in the tympanum does not, as in the case of submaxillary secretion, arrest the flow of parotid saliva. Nor do they pass through the greater superficial petrosal nerve,

for extirpation of the ganglion of Meckel is without effect on the parotid secretion. As a consequence, it must be concluded that these fibres pass to the lesser superficial petrosal nerve, which anastomoses with the otic ganglion. For it has been found that extirpation of the otic ganglion, or section of the lesser superficial petrosal nerves, arrests salivation. According to Heidenhain, the glosso-pharyngeal nerve also furnishes secretory fibres to the parotid, the fibres passing from this nerve to the nerve of Jacobsohn, and thence into the lesser superficial petrosal. Relations between the parotid secretion and the excitation of the cerebral glandular nerves seem to be about the same as for the submaxillary gland. The proportion of solids and salts augments with the intensity of the stimulation, while the proportion of organic matter increases as long as the glands are fresh, but diminishes if they become exhausted.

The secretory influence of the sympathetic on the parotid has been the subject of considerable controversy; the general opinion being that the sympathetic influences the parotid secretion only by diminishing the calibre of the capillaries. Certain authors have, however, held that in certain species excitation of the sympathetic produces a temporary increase in the parotid secretion. According to Eckhard, the parotid of the sheep continues to secrete even after section of all its nerves, being thus analogous to the secretion poured out by the salivary gland after section of the chorda tympani.

From the above facts it appears that the secretion of saliva is composed of two phases,—the first, a preparatory stage; the second, the essential stage.

The preliminary stage of salivary secretion is that of filtration of serum of the blood into the lymph-spaces around the acini of the salivary gland. This act is entirely under the control of the vascular nerves, which, by changing the calibre of the blood-vessels, and by thus increasing or decreasing the pressure within them, facilitate or hinder the transudation of serum. The influence of the circulation on secretion is, therefore, indirect. When the small arteries of the glands dilate more blood passes through them, a larger amount of nutritive material filters through into the lymph-spaces, and is appropriated by the gland-cells, whose vital processes must be thus quickened.

The second stage is that of true secretion through the action of the gland-cells, and, as has been already shown, is independent of the circulation and is under the control of the secretory nerves. The nature of these changes occurring in the act of secretion within the gland-cells is to a certain extent rendered explainable from the study of the histological changes which occur within the gland-cells. As has been already stated, the salivary glands may be divided into two types,—the serous and the mucous types. This distinction, which has only as yet been

based upon the character of the secretion, is further supported by actual morphological differences in the character of the gland-cells. In the serous glands, which are exemplified by the parotid of man and other mammals, the acini are lined by a layer of granular cells, which, in the quiescent condition, completely fill the acinus (Figs. 124 and 125). The nucleus under such conditions is barely distinguishable, its presence being obscured by the large number of granules present. As secretion takes place, these granules disappear, seemingly being broken up and used to form the secretion. During activity, therefore, the outer portion of each cell of a serous gland becomes clear and transparent, and this condition gradually spreads toward the centre of the cell. These changes have been most studied in the parotid of the rabbit. When at rest the nucleus is small, irregular, and devoid of nucleoli. When caused to secrete by stimulation of the sympathetic nerve the cells become

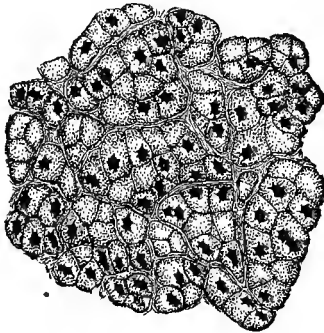

FIG. 124.—PAROTID OF RABBIT IN THE RESTING CONDITION. (Heidenhain.)

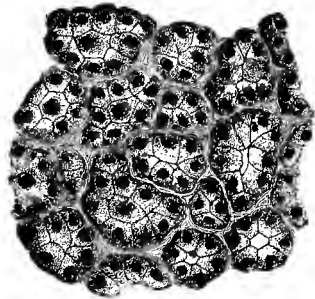

FIG. 125.—PAROTID OF RABBIT AFTER IRRITATION OF THE SYMPATHETIC NERVE. (Heidenhain.)

smaller, the nuclei become large and round, while the nucleoli may even be detected, and the whole cell stains more deeply with carmine. It thus appears that during rest granules are manufactured, which disappear during the activity of the cell.

In the mucous glands, of which the submaxillary or orbital glands of the dog may be taken as a type, the appearances are more complex. When a microscopic preparation is prepared of the resting salivary gland, the cells only stain with difficulty with carmine, this apparently being due to the presence of a large amount of mucin-like substance which occupies the entire cell with the exception of a small amount of unchanged protoplasm, readily staining with carmine, which remains around the nucleus. In such a section, prepared of the resting gland, in each acinus will usually be found one or more half-moon shaped cells lying outside the muciparous cells, which readily stain with carmine, which possess two or more nuclei,

and seem to be cells in a state of active growth and multiplication. When a similar section is prepared from a salivary gland which has been exhausted by prolonged stimulation of the chorda tympani nerve, the muciparous cells will, as a rule, have largely disappeared. All the cells are now small in size and all stain deeply (Figs. 126, 127, and 128). It would appear from this that in such a gland stimulation of the chorda nerve leads to a discharge of mucin, or to a total breaking down of the

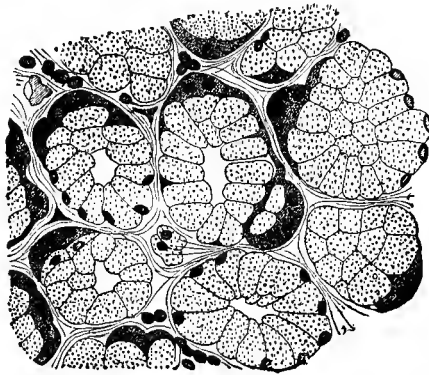

FIG. 126.—ORBITAL GLAND OF THE DOG IN THE RESTING CONDITION. (*Heidenhain.*)

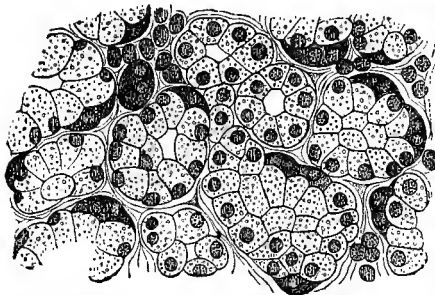

FIG. 127.—ORBITAL GLAND OF DOG—COMMENCEMENT OF CHANGES DURING ACTIVITY, AFTER LADVOVSKY. (*Heidenhain.*)

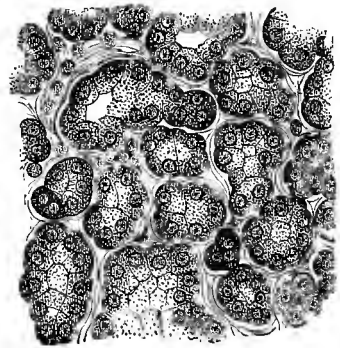

FIG. 128.—ORBITAL GLAND OF DOG—HIGHEST DEGREE OF CHANGE IN ACTIVITY, AFTER LADVOVSKY. (*Heidenhain.*)

entire cell, whose place is then taken by the new, rapidly growing, half-moon cells. Both statements are probably correct.

It is thus seen that the secretion is the result of the activity of the protoplasm of the secreting cell. During rest the mucous gland manufactures mucin at the expense of its protoplasm. When such a gland secretes, the mucin is discharged and new protoplasmic cells are rapidly

developed. In the case of the serous cells the changes are not so readily recognizable, since the microscopic changes are less marked, but the probability is that the same sort of processes occur. In the actual formation of the secretion we have thus two processes concerned. We have the development of mucin in the muciparous cells, and of ptyalin. During activity, from dilatation of the capillaries, the blood-serum, more or less modified in composition, reaches the acini, and from there passes into the glandular cells, while at the same time the fluid filters from these cells into the duct, and so constitutes secretion. The inorganic constituents of secretion are, therefore, removed from the blood by a simple process of osmosis, or filtration, while the organic constituents are the results of active manufacturing processes occurring within the protoplasmic cell-contents.

#### V. DEGLUTITION.

By the term deglutition is meant the various co-ordinated muscular movements which result in the passage of the food from the mouth to the stomach.

The act of deglutition may be divided into three different stages. In the first stage, which occurs in the mouth, the bolus of food passes to the isthmus of the fauces, in the second stage it passes through the pharynx, and in the third stage it traverses the œsophagus.

When the food has been sufficiently masticated it is gathered into a bolus by the contraction of the muscles of the tongue, the tip of the tongue being raised by the intrinsic muscles of the tongue, aided by the stylo-glossus, and the bolus passes back between the tongue and the hard palate to the anterior portions of the fauces (Fig. 129). This transferring of food from the mouth to the pharynx occurs when the teeth are in contact, since the jaws must be closed to afford support to the hyoid muscles, which we will find to be concerned in the later steps of the process, and in the herbivorous animals is accomplished so rapidly that no more marked duration of closure of the jaws can be detected than at any other time. When the bolus is very large mastication ceases at the moment of deglutition, as in carnivora and other animals that swallow the entire contents of the mouth at one movement. This first stage of deglutition is entirely within the control of the will, and may be prolonged or accelerated, and the movements of the bolus are perceptible to the sensory nerves of the part. When the bolus has once been placed upon the dorsum of the tongue, the tip, middle, and root of the tongue are successively pressed against the hard palate, and the contents of the mouth are thus propelled toward the pharynx; an active contraction of the mylo-hyoid muscles then takes place, as may be recognized by the finger placed below the lower jaw, the dorsum of the tongue is raised up,

and the bolus of food forced from the mouth into the pharynx. Almost at the same time the hyo-glossal muscles also begin contracting and, especially those portions which are attached to the cornua of the hyoid, cause the free surface of the tongue, which at rest looks upward and backward, to move backward and downward upon the epiglottis and mechanically close the glottis. The rapid narrowing of the space between the mylo-hyoids and the palate which is thus brought about also rapidly raises the pressure there. This effect is increased by the pull of the hyo-glossal muscles, which gives the tongue a backward and downward

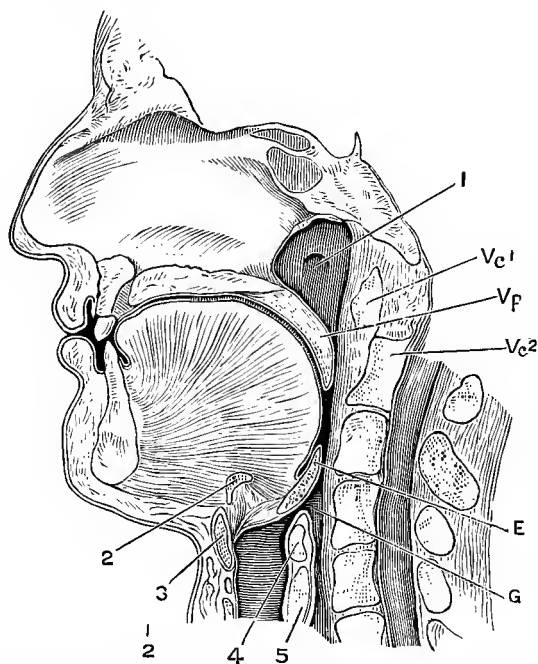

FIG. 129.—MEDIAN SECTION OF THE HUMAN HEAD, AFTER HENLE. (Mayer.)

Vp, the position of the soft palate during rest; I, orifice of Eustachian tube; Vc1 and Vc2, first and second cervical vertebrae; E, epiglottis; G, glottis; 4, arytenoid cartilage; 5, cricoid cartilage; 3, thyroid cartilage; 2, hyoid bone.

movement. Thus, liquids and soft foods are squirted down the entire pathway to the stomach before contractions of the pharyngeal or œsophageal muscles can manifest themselves (Meltzer). Fragments which happen to remain in the pharynx are sent down later by the succeeding contraction of the constrictors and with a slowness peculiar to these muscles (Fig. 130). When the bolus has passed the anterior palatine arches its return to the mouth is prevented by contraction of the palato-glossi muscles which lie in the anterior pillar of the fauces, and,



coming together, lie together like side-screens or curtains (Landois), meet the raised dorsum of the tongue, and so form a partition between the mouth and pharynx; the occlusion is still further assisted by the contraction of the stylo-glossi muscles, which elevate the tongue and press it against the palate.

The second stage of deglutition then commences, and the bolus of food is now entirely beyond the control of the will, and must pass down the pharynx into the œsophagus, its ejection into the mouth again only

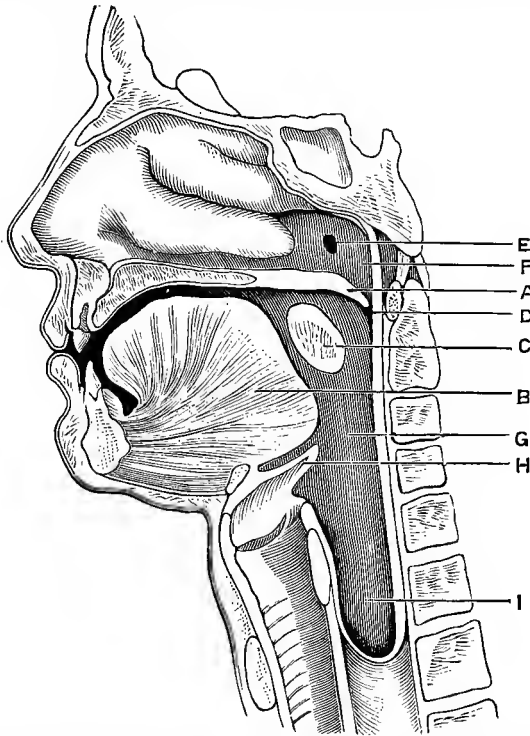

FIG. 130.—POSITION OF THE SOFT PALATE DURING THE SECOND STAGE OF THE ACT OF DEGLUTITION, AFTER FIAUX. (*Mayer.*)

A, soft palate; C, bolus; E, orifice of Eustachian tube; B, tongue; G, pharynx; H, epiglottis; I, œsophagus.

being rendered possible by an active coughing or gagging movement. Its downward movement during this stage, which lasts while the food is passing from the anterior pillars of the fauces to the entrance of the œsophagus, is still attended by sensation.

The muscular movements of the second stage of deglutition are much more complex than in the first. The pharynx communicates with three cavities,—the posterior nasal chamber, the œsophagus, and the larynx. Special mechanisms exist which direct the food downward toward

the opening of the œsophagus and hinder its passage into the nasal chambers and windpipe. As soon as the bolus of food reaches the anterior palatine arches the soft palate is raised by the contraction of the levator-palati muscles, and rendered tense and directed backward toward the posterior walls of the pharynx, with which, in many animals, as in the horse, it comes in actual contact (Fig. 131), and at the same time the palato-pharyngeal muscles, which lie in the posterior arches of the fauces, contract. These muscles have a bony insertion in the posterior wall of the pharynx, and then are inserted into the soft palate. The action of the levator-palati muscles has the effect of giving these muscles fixed points of support. In their condition of rest they form a curved line on each side from the centre to the back of the pharynx. When

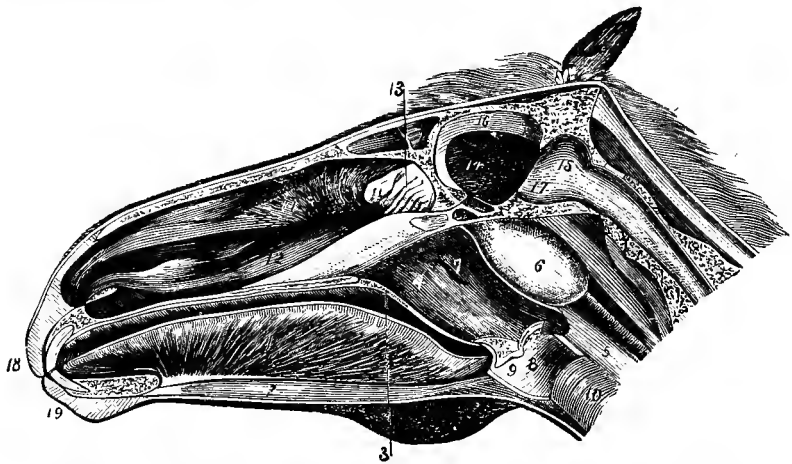

FIG. 131.—ANTERO-POSTERIOR SECTION OF THE HEAD OF THE HORSE, SHOWING THE ENTIRE MOUTH, PHARYNX, AND NASAL CAVITIES. (*Gamgee.*)

1, genio-hyoglossus; 2, genio-hyoideus; 3, section of the soft palate; 4, pharynx; 5, œsophagus; 6, guttural pouch; 7, pharyngeal opening of the Eustachian tube; 8, cavity of the larynx; 9, ventricle of the larynx; 10, trachea; 11, superior turbinated bone; 12, inferior turbinated bone; 13, ethmoid cells; 14, portion of the cranial cavity which lodges the brain proper; 15, portion of the same which lodges the cerebellum; 16, falx cerebri; 17, tentorium; 18, upper lip; 19, lower lip.

these muscles contract, downward motion of the soft palate having been prevented by the action of the levator-palati muscles and approximation of their origin and insertion being thus prevented, the effect will be to form a straight line between these two points. Merkel states that the inferior portions of the pharyngo-palatine muscles cross in the middle line of the posterior wall of the pharynx, and thus act as a sphincter in shutting off the nasal portion of the pharynx, the two muscles forming a circular muscle, like the orbicularis oris. The distribution of these fibres is shown in Fig. 132. As a consequence, the posterior pillars of the fauces will come together in the same way as the anterior pillars to form a screen or curtain, which will shut off the

pharynx from the posterior nasal fossa, the uvula serving still further to close the chink between their two free borders. An inclined plane is thus formed, down which the bolus is pressed by the backward movement of the tongue. At this stage the elevation of the soft palate may readily be demonstrated by placing a light straw along the floor of the nose, so that its posterior end rests on the soft palate (Landois). If now a motion of swallowing is made, the end which projects from the nose will descend, showing an elevation of the end which rests on the soft palate. At the same time there is a distinct rise of pressure within the nasal chambers. This may be shown by introducing a water manometer into one nostril and closing the other just before swallowing.

As the food passes behind the anterior palatine arch it is subjected to the action of the pharyngeal constrictor muscles, which propel it downward. The longitudinal fibres of the pharyngeal constrictors contract and cause an elevation (or more strictly shortening) of the walls

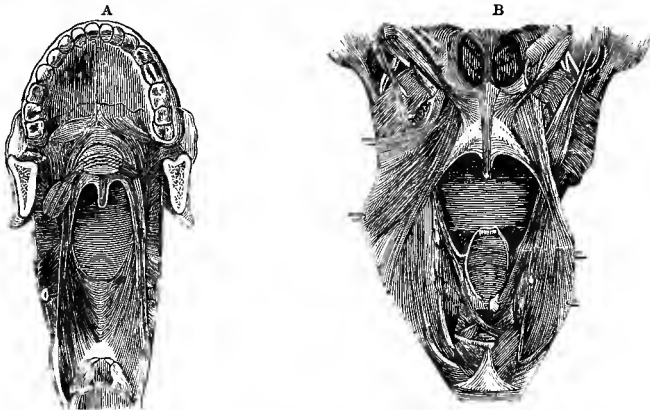

FIG. 132.—DISTRIBUTION OF FIBRES OF THE PALATO-PHARYNGEAL MUSCLES. (*Luschka.*)  
A anterior, B posterior view.

of the pharynx, together with the elevation of the larynx, this elevation being produced by a contraction of the stylo-pharyngeal and palato-pharyngeal muscles, the lower jaw coming in contact with the upper jaw through the action of the muscles of mastication. The food then passes within the grasp of the upper constrictor of the pharynx, which, contracting, serves to squeeze the bolus of food downward, passage into the nasal chamber being prevented by the mechanism above alluded to, and the bolus being propelled downward by successive contraction of the upper, lower, and middle constrictors of the pharynx until it passes into the œsophagus. The elevation of the larynx occurs when the bolus enters the pharynx, and is due to the action of the genio-hyoid and mylo-hyoid muscles. It is very perceptible in man, less so in animals in which the larynx is very near or very far from the base of the skull,

as the deer, is very slight in the horse and most ruminants, and has more of a forward motion, serving simply to bring the larynx beneath the base of the tongue. The elevation of the larynx serves partly to prevent the passage of food into the larynx. As the larynx is elevated the arytenoid cartilages and both true and false vocal cords are approximated, and as the thyroid cartilage ascends by the action of the laryngeal muscles the epiglottis is depressed to cover the glottis. In this latter operation the depression of the epiglottis is a passive and not an active movement, the depression being due not to an action of any intrinsic muscles, but to the ascent of the larynx beneath the epiglottis, and the mechanical pressing downward of the epiglottis by the weight of the bolus of food and the descent of the root of the tongue. The epiglottis is not, however, essential to the prevention of the entrance of food into the air-passages, since excision of the epiglottis in the dog, or its removal by disease in man, does not interfere with normal movements of deglutition. Colin has found, by inserting a finger into the larynx through an opening in the trachea of a horse which was swallowing, that the larynx at the moment of swallowing was suddenly elevated and moved anteriorly toward the base of the tongue, the vocal cords closed, and the arytenoid cartilages came in contact with each other. By these means food is prevented entering the larynx. He also found, by making a fistula in the upper part of the œsophagus of an ox and inserting a finger, that at each movement of swallowing the epiglottis was depressed, and the entrance to the œsophagus elevated and thus approximated to the isthmus of the fauces. In the horse the isthmus of the fauces is very narrow, and the bolus passes with difficulty, even if not very large, and is often arrested behind the larynx, and yet does not cause coughing. This is often seen after giving a bolus to a horse, particularly in cases of angina. In ruminants the isthmus of the fauces is large and the pharynx is ample, and when the food sticks in the throat in these animals it is usually in the cervical or thoracic portions of the gullet, which is also the locality where the food is apt to be arrested in the pig.

In those animals which habitually swallow their food while the head is bent forward, the digastric, in addition to its functions in depressing the lower jaw, is also an aid to deglutition. Where, as in reptiles, birds, and most mammals, the position of the mouth with respect to the œsophagus during the act of swallowing the food is almost in the same right line, deglutition is easily effected by the mylo- and genio-hyoid muscles drawing the hyoid bone and larynx forward and upward so as to allow the masticated mass to get behind them, and so bring it within the grasp of the pharyngeal muscles; but in those animals which feed while in the erect or semi-erect position, and the head bent forward so that the cavity of the mouth is at right angles with the œsophagus, it is

evident that deglutition must be a much more complex action. In that position the mylo- and genio-hyoid muscles are relaxed, and cannot act efficiently in drawing the hyoid bone upward and forward so as to allow the masticated mass to pass into the œsophagus, into which it has to pass, in fact, around an angle. The difficulty is removed by the connection of the digastric muscle with the hyoid bone. This muscle, during the act of deglutition, causes the hyoid bone, larynx, and base of the tongue to move through a segment of a circle, the anterior part of the muscle drawing these parts forward; they are then elevated by the joint action of the anterior and posterior bellies, and finally drawn backward by the posterior bellies, so as to force the masticated mass into the œsophagus.

The second stage of deglutition is facilitated by the mucous secretions of the parts concerned. This secretion may become enormous, as in the dromedary, where the appendix to the soft palate and the pharyngeal pouch are very glandular. In all animals the secretion of the mucous membrane of the mouth and pharynx, aided by the salivary secretion, is amply sufficient to lubricate the food, so as to render deglutition possible. It was already noted in the chapter on the salivary secretion that the quantity of saliva poured out was largely dependent upon the character of the food; or, in other words, the drier the food the greater the amount of lubricant needed, and, therefore, the greater was the salivary secretion.

The second stage of deglutition is involuntary, and when the bolus of food has passed beyond the anterior pillars of the fauces it is no longer within the control of the will, and can only be returned to the mouth by vomiting or violent coughing. Therefore, in giving pills or balls to animals they have to be carried mechanically by the hand behind the pillars of the fauces; they are then carried down to the stomach by the involuntary contraction of the pharynx and œsophagus.

The third stage of deglutition occurs after the food has passed through the pharynx and has entered into the œsophagus. This stage of deglutition is much more prolonged than the two preceding stages, and in the larger domestic animals the passage of the food by the œsophagus may be followed by the eye and touch. Where the secretion of saliva is scanty the duration of this stage becomes prolonged, and sometimes, as in the horse, the food may become arrested in the lower cervical portion of the œsophagus until pushed on by the next succeeding bolus.

The rapidity of motion in the œsophagus varies. Liquids and very soft foods are very rapidly swallowed, being actually squirted through the œsophagus; dry forage is swallowed very slowly. In the horse the boluses have to be very small, from the narrow character of the gullet

in these animals. Hence, if the bolus of food is larger than three or four centimeters in diameter it is apt to be arrested. In the ox boluses double the size pass without difficulty.

When once the alimentary bolus is within the grasp of the muscles of the œsophagus it moves onward with considerable force. Mosso, in his experiments made on the dog, found that even when the bolus of food was held back by a weight of four hundred and fifty grammes deglutition was not interfered with. When once the bolus of food reaches the upper part of the œsophagus the pharynx falls, and the bolus traverses the length of the œsophagus under the influence of the successive contractions of the circular and longitudinal muscular fibres. The longitudinal fibres contract first, and draw up the œsophagus to meet the advancing bolus, which is pushed down by the contractions of the annular fibres behind it. Gravity is entirely without influence on the motions of deglutition, as swallowing occurs equally well even when the head is on a lower plane than the entrance of the œsophagus into the stomach.

The third stage of deglutition is involuntary and is unattended by sensation, though pain may be intense when too large a bolus or a hard, irregular mass is swallowed; so, also, very hot or very cold substances may be recognized in their passage through the œsophagus by the sensations which they occasion. As a rule, however, the passage of food through the œsophagus is entirely unattended by any feeling. Even acids cause but little sensation.

That deglutition may be accomplished, it is essential that there must be something to be swallowed. When the mouth contains saliva alone the motions of deglutition may be made, but as the quantity of fluid in the mouth decreases deglutition becomes more and more difficult, until finally it is impossible. This fact indicates the reflex nature of the motion of deglutition. As before pointed out, a reflex action requires the presence of a stimulus, its conduction to a nerve-centre, and the transmission of motor impulse through efferent nerves to a muscular fibre. The stimulus for deglutition is found in the contact of food with the mucous membrane of the mouth, pharynx, and œsophagus. The sensory nerves come from the trigeminal, the glosso-pharyngeal, and the superior laryngeal nerves. Excitation of any of these nerves produces movements of deglutition.

In the case of the œsophagus the pneumogastric is the sensory nerve. The centre of the movements of deglutition is found in the medulla oblongata. The motor nerves are the glosso-pharyngeal, supplying the muscles of the pharynx; the hypo-glossal, supplying the muscles of the tongue; the trigeminal and facial, supplying the muscles of mastication, and the pneumogastric, supplying the muscles of the larynx and œsophagus.

In the horse, ass, dog, sheep, and ox the lower parts of the œsophagus are supplied, as in man and the rabbit, by the recurrent fibres of the vagi; the upper portions are, however, supplied by a long branch of the pharyngeal nerve which descends in the walls of the œsophagus as far as the thorax. In birds a similar state of affairs also holds.

Deglutition may be excited by mechanical contact with the fauces in an animal in which the cerebrum has been removed; it is only necessary that the medulla remain intact.

Deglutition of liquids is performed by a mechanism which is almost similar to that concerned in the deglutition of solids. The palate is raised and made tense, the palato-pharyngeal muscles contract, the glottis rises, the epiglottis descends, the pharynx ascends, and the gullet contracts as in the case of deglutition of solids, the difference mainly consisting in the rapidity with which liquids are forced through the œsophagus.

The motions of deglutition of liquids may be very rapid. Thus, in the horse sixty-five to ninety motions may be made in each minute, each swallow carrying one hundred and fifty to two hundred and fifty grammes of liquid.

The rapidity of deglutition varies according to the animal and the nature of the food. The horse eating hay swallows thirty-five boluses in fifteen minutes after having fasted for some time, and only ten or twelve boluses in the same time as hunger commences to be appeased, the weight of each bolus varying from fifty to one hundred grammes. In swallowing liquids the horse moves the ears, advancing them at each act of deglutition, at the same time closing the jaws. The masseters may, therefore, be seen to move under the skin, and even the eyes to move in their orbits. In ruminants during deglutition the ears either remain motionless or move unequally. Rhythmical motion of these organs as seen in the horse is absent in ruminants.

The act of deglutition is performed as described above in all air-breathing animals. In all, from the mammalia down to the amphibia, the pharynx communicates with the nasal chambers, the cavities of the ear on both sides, the mouth, larynx, and œsophagus.

In the young kangaroo, while still retained in the abdominal pouch of the mother, and in cetaceans, the upper part of the larynx is elongated and projects into the posterior nares, so that during suckling the milk passes down each side without any risk of entering the air-passages and without interfering with respiration.

In fishes which respire in the water by gills the pharynx has no communication with the nasal passage, while the larynx and trachea are, of course, absent. Hence, the pharynx is here a mere passage leading from the mouth to the œsophagus, and the process of deglutition is consequently greatly simplified.

## VI. RUMINATION.

In most animals the food after being swallowed enters the stomach sufficiently comminuted to be at once acted on by the gastric juice. In others, though imperfectly triturated, the food may be at once digested, while in a third case the food is returned to the mouth for a second mastication.

The first of these cases is seen in carnivora and omnivora; the second occurs in granivorous birds and crustaceans, where mastication in the mouth is entirely absent, but where, as will be seen later, the stomach is provided with an accessory organ, the gizzard, which is capable of crushing and grinding the food.

The third case is seen in ruminants, where the food is carried to the stomach after only having been subjected to a preliminary and partial mastication in the mouth. It is then macerated by the fluids contained in the stomach, and is again regurgitated to the mouth, to be subjected to the final and complete process of mastication.

Rumination, or the returning of food from the stomach to the mouth for a second mastication, is peculiar to polygastric herbivora. It differs from vomiting in that the motion is perfectly voluntary, is a normal physiological process, and the matters regurgitated are again swallowed without leaving the mouth. All true ruminants have a multiple stomach, although all animals with multiple stomachs are not ruminants. Thus, in the bird three stomachs may be described, and in certain cetaceans, as well as in certain edents, as the sloth, the stomach may be divided into a number of different compartments and yet rumination not take place.

The habits of ruminant animals necessitate some process by which the food is hastily collected in a capacious paunch, to be again returned to the mouth for mastication. Ruminant animals in a state of nature instinctively rely on quickness of sight, acuteness of hearing, and agility to enable them to elude their enemies. With a powerful prehensile tongue, long and thick tufts of grass are rapidly carried into the mouth and as rapidly swallowed. However tough the herbage may be, it is slightly broken down by one or two strokes of the molar teeth; it then passes through the gullet into the capacious compartments which receive the name of stomachs, but which are in reality pouches of the œsophagus, and are situated between the latter tube and the true stomach. By this arrangement herbivorous ruminants are therefore enabled to rapidly stow away in these reservoirs a supply of food, where, on the approach of danger, it may be retained until an opportunity offers for its return to the mouth, when it may be masticated at leisure. The stomach of



ruminant animals consists of the following parts: the œsophagus opens into the rumen, or paunch, which communicates by an opening with the reticulum, or water bag, this again with the third stomach, or psalter, omasum, or manyplies, which finally, by a small opening, communicates with the fourth, or true stomach, or abomasum.

The histological structure of these compartments varies considerably. Only the fourth stomach can be compared with that of animals which possess but a simple, single stomach. The rumen is coated with horny epithelial cells, arranged in rows in a manner somewhat similar to the epidermal cells of the skin (Fig. 133). The similarity is further

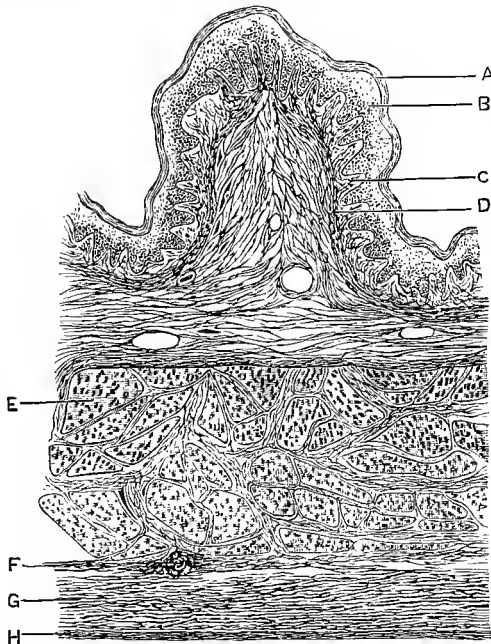

FIG. 133.—SECTION OF WALL OF THE RUMEN. (*Ellenberger.*)

A, horny layer; B, lower epithelial layer; C, papillæ; D, submucous muscular layer; E, inner muscular coat; F, ganglia; G, external muscular coat; H, serous coat.

completed in that the submucous connective tissue in the rumen is also elevated into papillæ, similar to those found in the thickness of the skin. It is well supplied with muscles, and the muscular fibres in the submucous layer are tolerably well developed. But few glands are to be found in the rumen, and these are simply of a mucous type, while acinous glands pass through the submucous connective tissue down to the muscular fibres below. The cavity of the paunch or rumen is by far the largest of the four stomachs, and constitutes about nine-tenths of the space represented by the ruminant stomach.

The second stomach is called the honey-comb bag, or reticulum, and in its histological structure differs but slightly from that of the rumen. Its interior is likewise lined with horny, epithelial cells, arranged in layers, and the inferior layers of the mucous membrane are arranged in similar papillæ. The reticulum owes its name to the peculiar arrangement of the mucous membrane which lines it in small cells or cavities not communicating with each other, but all opening freely into the general cavity.

In the camel and llama and other animals of the desert similar collections of cells are found in the rumen also. In these animals they consist of a number of large cells, arranged in parallel rows, and separated from each other by folds, the free margins of which are thickened

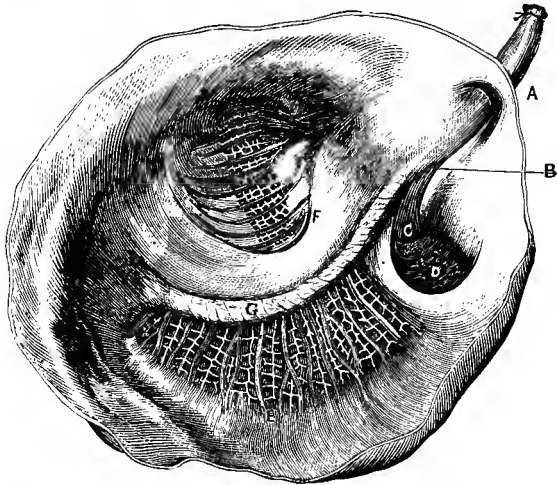

FIG. 134.—STOMACH OF LLAMA. (*Colln.*)

A, inferior extremity of the œsophagus; B, single pillar of the œsophageal canal; C, superior orifice of the manyplies; D, reticulum; E, right, or anterior water-cells; F, inferior water-cells; G, fleshy column separating the two groups of cells.

by muscular fibres or sphincters, capable of closing the opening by which each cell communicates with the cavity of the rumen. There are eight hundred of these cells in the camel and dromedary, and they all usually contain water, for which purpose, indeed, they are believed to be constituted. One group of these cells is situated to the left and the other to the right (Fig. 134). These groups of cells are each capable of containing in the camel about five quarts of water.

The reticulum, or honey-comb bag, is the smallest of the four compartments, in the ox being fixed above by the œsophagus to the diaphragm, connected with the narrow part of the rumen, and attached below also to the diaphragm. Its cavity communicates freely with that of the rumen by a large opening.

The third stomach, or psalter, omasum, or manyplies, is situated on the right side of the rumen and reticulum, descending from before backward, and is lined by mucous membrane, disposed in broad folds (Fig. 135). These folds are of varying breadth, from twelve to fifteen in number, and form almost complete partitions; between them are others gradually diminishing in size. The external surface of the mucous membrane of these folds is coated with an epithelial layer, which, when the rumen is not entirely fresh, is readily stripped off. Below this layer,

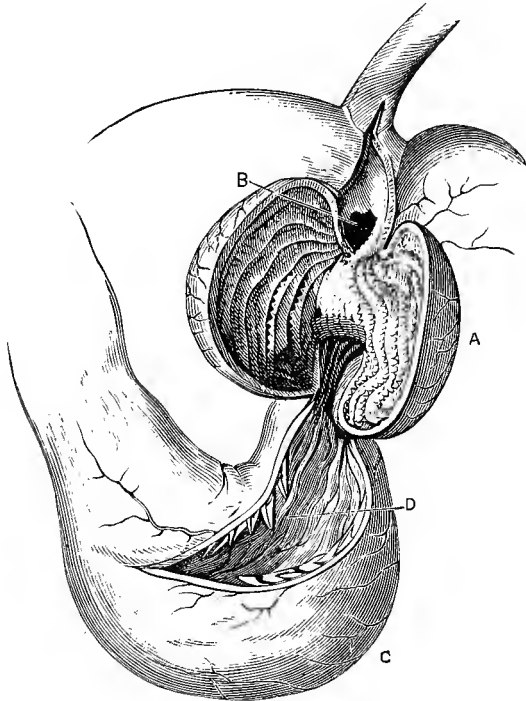

FIG. 135.—OMASUM AND ABOMASUM OF THE OX, LAID OPEN.

A, omasum, or manyplies, showing its folds; B, the opening communicating with the reticulum, or honey-comb bag; C, abomasum, the true digestive stomach, opened to show the plicae, D, of its mucous membrane.

which is called the horny layer, comes the mucous membrane proper. It is also provided with papillæ, which are larger and thicker than those found in the reticulum. The mucous membrane consists of connective and elastic tissue-fibres and blood-vessels. In the mucous membrane are also found oblique muscular fibres of the unstriped variety. Glands are entirely absent. The folds of the mucous membrane are papillated on the surface, the eminences being flattened on the side and pointed at the

edge of each fold. When the contents of this stomach are examined in animals slaughtered in perfect health they are always found dry, and there is a disposition for the epithelium to become detached in shreds and adhere to the pulpy mass. In the hornless ruminants, such as sheep, these folds are more or less rudimentary.

The œsophageal canal communicates on the left with the paunch and reticulum, and on the right with the manyplies. Its direction is from above outward and backward, the anterior pillar entering the honey-comb bag and the posterior the paunch (Figs. 136 and 137). The lower angle is raised above the level of the third stomach, especially during the action of the gullet, so that it is only when the pillars of the

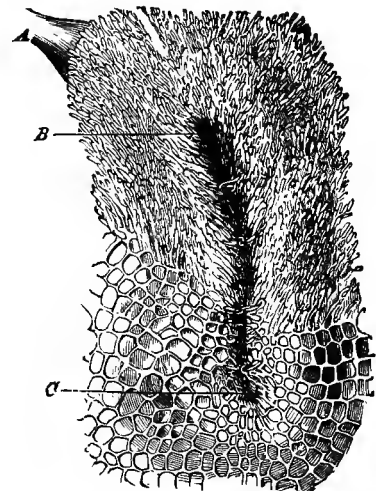
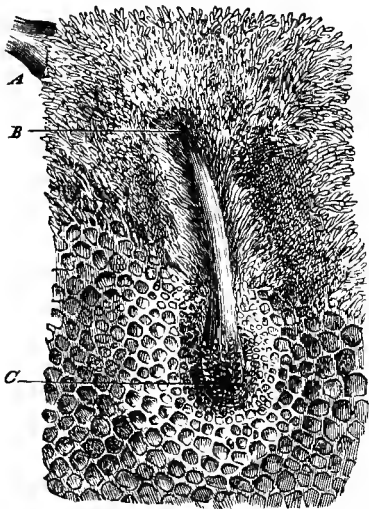

FIG. 136.—ŒSOPHAGEAL CANAL, OPEN. FIG. 137.—ŒSOPHAGEAL CANAL, CLOSED BY SUTURE. (*Coltin.*)

*A*, inferior extremity of the œsophagus; *B*, cardiac orifice; *C*, superior orifice of the manyplies.

canal are at rest, and liquids or soft foods are descending, or when the contents of the first and second stomachs strike against the canal, that any food enters into the omasum.

The fourth stomach, or abomasum or rennet, corresponds in its histological structure with the stomach of other mammals. Its mucous membrane is arranged in numerous larger or smaller folds, on the summits of which open the ducts of the gastric glands. It also is supplied with muscular fibres, and with nerves, blood-vessels, and lymphatics. Its mucous membrane is arranged in folds, which are transverse at the upper end, longitudinal in the middle, and gradually effaced in the pylorus. The fourth stomach of the ruminant differs from that of other mammals only in size and shape, and agrees in histological

structure. In the horse we find that a less important peculiarity is also to be noticed.

After having undergone the first and incomplete mastication, the food passes into the first and second stomachs, while fluid and finely comminuted food may enter all four compartments, passing directly into the first two stomachs, and then, by means of the œsophageal gutter, into the third and even into the fourth stomach. It was believed formerly that the œsophageal gutter conducted fluids entirely and directly into the third and fourth stomachs, but Flourens proved, by making fistulous openings into all four compartments, that immediately

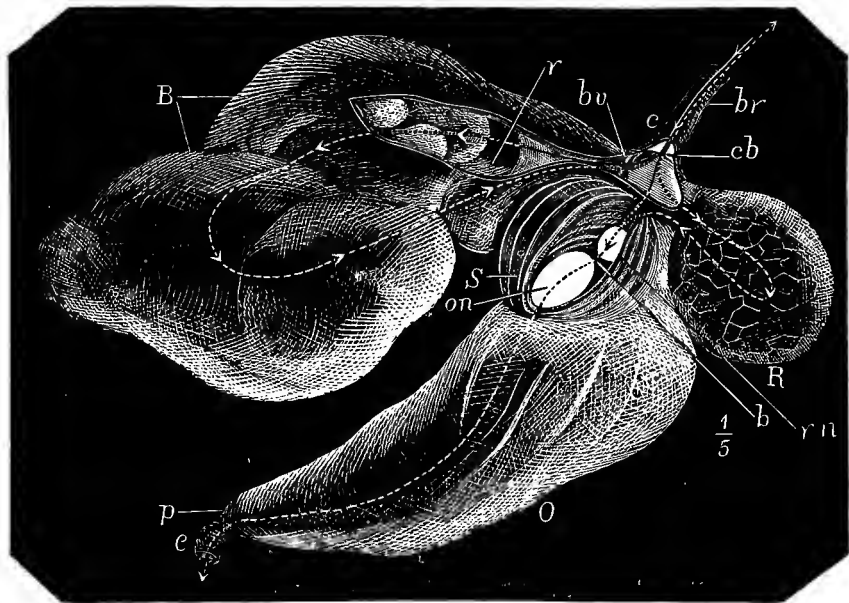

FIG. 138.—STOMACH OF FULL-GROWN SHEEP, INFLATED AND DRIED; ONE-FIFTH THE NATURAL SIZE. (*Thanhoffer.*)

B, rumen; R, reticulum; S, omasum; O, abomasum; c, cardia; p, pylorus; br, œsophagus; cb, cardiac valve; bv, œsophageal canal; r, pillars of the rumen; rn, opening of the reticulum; on, opening of the abomasum; b, valve between reticulum and omasum; e, duodenum.

on drinking fluids entered all four stomachs almost simultaneously. When an animal drinks the water enters the paunch and the reticulum, since the œsophagus enters at the junction of these two reservoirs, while a small quantity of liquid enters the third stomach directly, and from there into the fourth. Moreover, the reticulum is the seat of energetic contractions which force a part of its contents into the rumen and into the third stomach: consequently it would seem clear that the largest portion of fluid enters the first two stomachs and then passes through to the others, though some directly enters the third and fourth,

being conducted by means of the œsophageal gutter. The amount so conducted must, in the most favorable cases, be but insignificant, since the œsophageal gutter is not a direct continuation of the gullet, but joins it in an oblique angle directed toward the right side. The explanation of the origin of the large amount of fluid invariably found in the first and second stomachs would otherwise be impossible, for, as already pointed out, the lining membrane of these two compartments is but sparsely supplied with glands, and, therefore, they are incapable of furnishing a secretion of their own.

The opening between the second and third stomachs is extremely small. Coarsely comminuted food is therefore incapable of passing into the manyplies, and accumulates in the first two reservoirs. The rumen and honey-comb bag invariably contain food, even after animals have

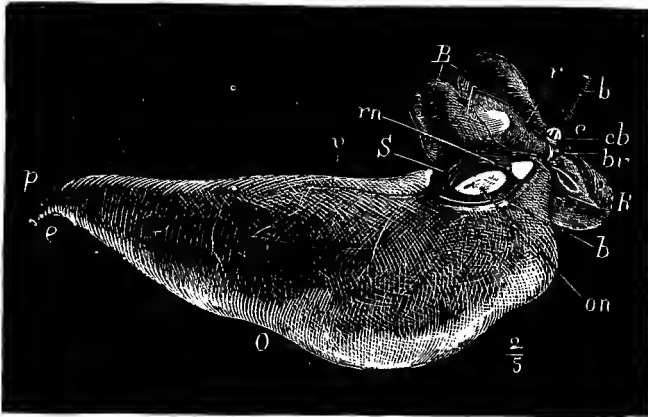

FIG. 139.—STOMACH OF THE NEWBORN LAMB, DRIED AND INFLATED; TWO-FIFTHS THE NATURAL SIZE. (*Thanhoffer.*)

B, rumen; R, reticulum; S, omasum; O, abomasum; c, cardia; p, pylorus; b, œsophagus; cb, cardiac valve; br, œsophageal canal; r, folds in rumen; rn, opening into reticulum; on, opening into abomasum; v, blood-vessels; e, duodenum.

fasted for twenty-four hours. Thus, Colin found that in an ox which had fasted twenty-four hours the rumen might contain one hundred and fifty to two hundred pounds of food, three-fourths of which was water, but little solids being found in the reticulum.

The coarsely ground food which first enters the panmach and reticulum is subjected there for a variable time to the liquids contained in those organs,—saliva, mucus, and water; in proportion to the different nature of vegetable food is its presence in the rumen prolonged. Liquids, such as milk, which need no second mastication, pass chiefly into the second and third cavities. The functions of the rumen are then dispensed with, and, as a consequence, we find the rumen quite rudimentary in suckling herbivorous animals (Figs. 138 and 139). The reaction of

the first two stomachs is slightly alkaline. Tiedemann and Gmelin found it acid in calves, and Colin says it is also acid when digestion is disturbed, from fermentative change occurring in the food. The food left in the rumen and reticulum is subjected to a slow churning process, and not to the active, grinding movements which were once thought to aid in trituration and regurgitation of food, substances dropped into the posterior pouches of the paunch gradually being forced forward into the reticulum and back again, without any very sensible contractions of the muscular walls of the viscus (Fig. 140). By exposing the interior of the paunch in a young bull, Colin noticed the welling up of the fluid and the production of distinct waves, indicating the commotion set up

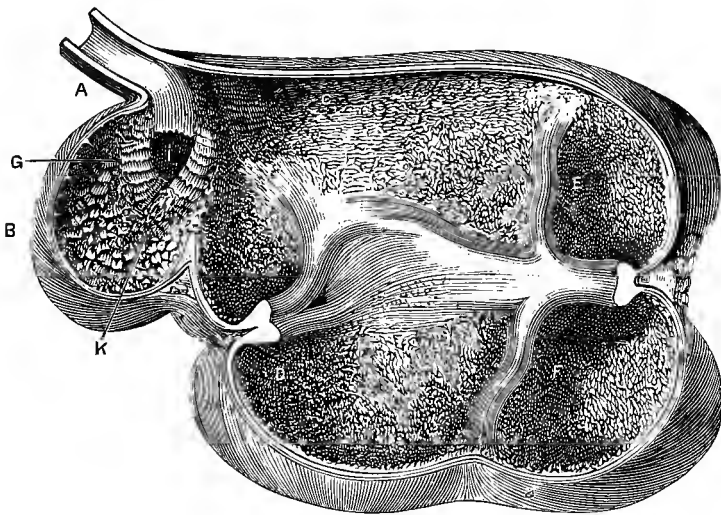

FIG. 140.—RUMEN AND RETICULUM OF THE OX, LAID OPEN BY REMOVING THE LEFT WALL WHILE IN SITU.

A, gullet; B, reticulum; C, anterior pouch of rumen; D, middle pouch; E, posterior superior pouch; F, posterior inferior pouch; G, K, pillars of the esophageal canal; I, entrance to the omasum.

in every portion of the contents. The newly swallowed food is therefore speedily mixed, however long the animal may have fasted, with the portions which must necessarily lodge in the lower pouches of the rumen, even in the most perfect digestion (Fig. 141). It is evident that prolonged maceration in the paunch will reduce food to a pulpy mass, thus facilitating the regurgitation of the food for a second mastication. All soluble materials which the saliva and other fluids swallowed may dissolve are rendered fit for passage into the alimentary canal, and, however feeble the actions of secretion, the saliva swallowed is here in its most suitable conditions for transforming starchy food into sugar. The

changes of the food in this stomach are probably of a fermentative nature, as indicated by the nature of the gases which are constantly present. Thus,  $\text{CO}_2$ ,  $\text{H}_2\text{S}$ , acetic acid, butyric acid, carbonate of ammonium, chlorides, carbonates, phosphates and sulphates of sodium and potassium, and carbonates and phosphates of lime, are almost constantly found. The solids will, of course, vary in relative abundance according to the food which has served as a diet for the animal. In the reticulum, also, the food undergoes changes similar to those which have been observed in the rumen; in fact, the reticulum may be regarded as an extension of the paunch. Its special function appears to be to retain fluids, as its contents are always liquid. Its reaction is also alkaline.

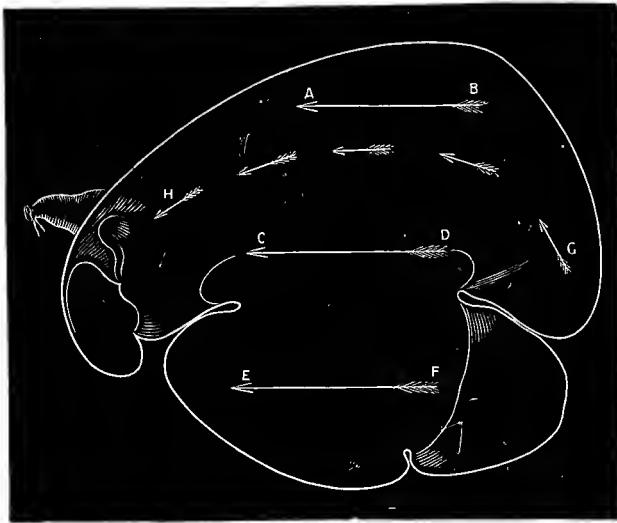

FIG. 141.—VERTICAL SECTION OF THE RUMEN AND RETICULUM. (*Colin.*)

A B, superior region; C D, median region; E F, inferior region; G H, the small arrows show the course followed by the food which passes from the posterior portions of the rumen to be ruminated.

As regards the mechanism of the rejection of food for the second mastication, considerable diversity of opinion prevails. All authors, however, agree in dividing the organs of rumination into the essential organ—the stomach, and the auxiliary organs—the diaphragm and abdominal muscles. It is not perfectly clear from which compartment the food enters the œsophagus to be ruminated.

Colin, Chauveau, and others believe that it passes directly out of the rumen into the œsophagus, while Haubner thinks that the assistance of the water-bag is essential, and this seems most probable on anatomical grounds. The rumen is an organ of immense size, and, as has been shown, may contain as much as two hundred pounds of material, and its muscular



walls are proportionately weak. On the other hand, the reticulum is the smallest of the four gastric compartments; its muscles are, comparatively speaking, strong, and under stimulation of the pneumogastric nerve it has been found to decrease one-third in volume. Furthermore, the œsophagus communicates more directly with the second than with the first stomach, its opening into the reticulum having somewhat the shape of a funnel. The lips of the œsophageal gutter are not essential to the formation of the cud, for Colin found that stitching the lips of this canal together with wire sutures did not interfere with rumination; so, also, the reticulum has been found not to be solely concerned in this operation, for Flourens excised a portion of this organ and sewed the remainder to the abdominal walls in a sheep, and yet rumination was possible. Colin has shown that the gradual insertion of food between the pillars of the gullet is sufficient for the regurgitation essential to the act of rumination. Moreover, that the œsophageal pillars are not essential to the formation of the cud is proved by comparative anatomy, where we find rumination occurring in the llama and dromedary, where only a single pillar is present. The contents of the first two stomachs, as already mentioned, are subjected to a gentle churning motion, and the tendency of the food is to strike forward against the pillars of the œsophagus. As it presses forward by its own weight, and the slight degree of impulse which the contractions of the rumen and reticulum give to it, there is a contraction of the diaphragm and abdominal muscles, and this causes a portion of the contents of these two compartments to engage in the infundibular orifice of the gullet, whence they are carried upward by reversed peristalsis.

The action of the abdominal muscles and diaphragm are necessary to permit of rumination, for when, as was proved by Flourens, the diaphragm is paralyzed by section of the phrenic nerves, although rumination may take place, the abdominal muscles will be called upon to make an extra effort. When the abdominal muscles are paralyzed, as by section of the spinal cord, rumination is then impossible. This is also the case when both pneumogastric nerves are divided. That the diaphragm and abdominal muscles are the organs whose contraction determines the act of regurgitation is probable on other grounds. The muscular fibres of the rumen and reticulum are largely of the pale, unstriped variety, and their contraction is slow and prolonged. The rapidity of the act of regurgitation points to its being produced by red, striped, voluntary muscles. When the cud engages in the œsophagus, a constant movement may be seen in the flank, more sensible than the other respiratory movements, and which is due to contraction of the abdominal muscles, an inspiration being followed by a rapid expiration. This movement is coincident with the entrance of the bolus into the

infundibulum of the œsophagus, and while it is due to the contraction of the auxiliary organs, this contraction is not, under ordinary circumstances, very energetic, but becomes so when, as a consequence of various diseases, the food in the rumen becomes more or less dry. The ascent of the cud is not only due to the pressure of the contracting abdominal and gastric muscles, but *aspiration* to a certain extent assists its onward progress. At the moment of the act of rumination the glottis is closed, and as the diaphragm contracts the thoracic capacity is augmented and the bolus is *drawn* toward the thorax. When, and as soon as the bolus of food is engaged in the œsophagus, it is carried to the mouth with great rapidity by the action of the muscular fibres of the œsophagus, the process being the reverse of deglutition; that is, the longitudinal fibres first contract, and so widen the œsophagus, and then the circular fibres successively contract below the bolus, and so force it upward. The ascent of the cud is visible throughout the entire length of the neck in most ruminants, particularly in those which are thin, or which, like the camel, have a long neck. Its ascent is also perceptible to the touch and to the sense of hearing. When the ear is placed over the course of the œsophagus in a ruminant animal, various sounds may be recognized during the act of rumination. In this position bubbling or moist friction sounds can be heard from the region of the rumen, even in the intervals of the rumination, due to the disengagement of bubbles of gases in the process of fermentation which so often occurs in this viscus. These sounds are most marked in animals which are fed on green fodder. A sound very closely analogous to the pleural friction sound is also heard in the same locality coincident with the movements of respiration. It is due to the friction between the rumen and the diaphragm. The peculiar bubbling sounds due to the motion of foods may also be heard, and are dependent upon the entrance of saliva or food into the first and second stomach and the passage of currents from the first and second stomachs, and *vice versâ*. In addition to these, rumbling and churning sounds, due to the motion of the material in the rumen and produced by contraction of the pillars of the rumen, may also be heard. During active rumination, if the ear is placed over the cervical path of the œsophagus, that is, over the left jugular, the passage of the bolus may be distinctly heard. The ear perceives the tactile impression of a body passing rapidly beneath it, and a sound is heard which by its peculiar characteristics indicates that the bolus is impregnated with or accompanied by a quantity of liquid.

As soon as the bolus enters the mouth, a second sound is heard which indicates the rapid downward passage of liquid. This may be repeated two or three times at short intervals, and shows that the bolus is accompanied in its ascent by a quantity of liquid, which, as soon as its

lubricating function has been served, is again swallowed. This fluid consists partially of saliva and water, or, in other words, the contents of the rumen and reticulum, and as the bolus of food enters the œsophagus this fluid is mechanically driven in with it. Its presence is absolutely essential to the act of rumination, for rumination is impossible in animals when deprived of water, or in whom the secretion of saliva has been interfered with.

As soon as the cud reaches the pharynx the soft palate suddenly rises and the food is carried by the tongue between the molar teeth and cheeks, the mechanism by which the food is prevented from entering the nasal chambers and larynx being precisely the same as has already been described as taking place during deglutition. The amount of food raised in each bolus varies from one hundred to one hundred and twenty grammes. It is at first only coarsely ground, and not very soft or fluid, but it soon becomes fine and comminuted and thoroughly macerated in the second mastication, and is collected in a little cake on the back of the tongue preparatory to swallowing a second time. Since the quantity composing each bolus may be readily determined by withdrawing the cud from the mouth as soon as it is rejected from the stomach, it is possible to calculate how many of these rejections are necessary for the mastication of the twelve to fifteen kilos of hay which constitute the ordinary daily ration of an ox. Since it has been shown that dry fodder absorbs in mastication and in the rumen four times its own weight of fluid, twelve thousand five hundred grammes of hay will acquire a weight of sixty-two thousand five hundred grammes. It is, therefore, necessary that five hundred and twenty rejections, each of one hundred and twenty grammes, take place. In order to permit all of this food to undergo a second mastication, and as each bolus requires about fifty seconds for its second mastication, at least seven hours would be required for the process of rumination; even if we admit that one-seventh of the food is not masticated a second time, one-fourth the day is required for rumination. The ox, therefore, cannot, like the horse, be used for constant effort, as he requires time for rumination, and, as will be shown directly, rumination is very readily interfered with by any active exertion.

As soon as the bolus enters the mouth it is subjected to a second mastication, which differs from the first only in being more regular and more complete. The number, rapidity, and regularity of the movements of the jaw in this second mastication appear, however, to be subject to numerous variations. As already stated, the movements of the jaws are unilateral; this also applies to the second mastication, although perhaps less regularly. Unilateral rumination is seen in the ox, sheep, giraffe, antelope, and other animals, and is most usual. Its duration may be as

long as a quarter of an hour, and then the direction of mastication may be reversed, the change usually occurring as a new bolus enters the mouth, and not during the mastication of one which has already entered the mouth. In certain animals, as in the dromedary, the mastication of rumination is alternate; that is, the lower jaw moves first to the right and then across the centre line to the left, and so on. In young animals the rhythm of mastication is always more irregular than in adult animals; the number of strokes of the teeth to each bolus varies according to the species of animals, the age, the character of the food, etc. Thus, dry food requires more chewing than green food, perhaps thus explaining the statement that animals ruminate more in winter than in summer. Young animals have a smaller number of teeth than older animals, and therefore require a longer time for mastication, as is also the case in old animals, where the teeth have become imperfect. The rapidity of motion of the second mastication closely corresponds in character with the other motions of the same animal. In those animals which are habitually slow and sluggish in their movements, as the ox, buffalo, etc., the movements of mastication will be slower and more deliberate than in animals, such as the antelope and gazelle, in which the muscular actions are rapidly performed. Even in animals of the same species it will generally be noticed that the movements are more rapid in youth than in old age. Toward the end of the period of mastication of the cud, the movements of the jaws become considerably accelerated. If rumination is interrupted from any disturbance, the bolus is held in the mouth for a time and mastication again completed before it is swallowed. Even when so interrupted the average number of strokes of the teeth to each bolus is not interfered with. If the disturbance is sufficiently severe to prevent the resumption of rumination, the bolus is held in the mouth for some time and then swallowed by several rapid movements of deglutition. During the mastication of the cud the bolus does not pass between the incisor teeth, but remains between the molars. As has been stated, the movements of mastication constitute the principal stimulus to the secretion of the parotid glands. It is these glands, therefore, which secrete most actively during rumination, while the salivary glands of the anterior system are almost inactive. In the ruminant animal the secretion of the parotid is never entirely suppressed, for the fluid which it pours out is essential to active rumination. Since, if a fistula be made of the parotid ducts, and the parotid saliva conducted outside of the mouth, even although the animal be supplied with water, rumination becomes more and more difficult, and after three or four days becomes impossible. The saliva is therefore essential to active rumination. When the food enters the mouth the secretion of the parotid again becomes more active, and these glands have been estimated to pour out nine hundred grammes of

saliva each in one-quarter of an hour. Besides keeping the food in the rumen moist and lubricating the œsophagus, the saliva secreted during abstinence and the second mastication does not all pass into the rumen, but some of it also passes into the manyplies, and so serves to keep the œsophageal gutter lubricated.

As soon as the mastication of the cud is complete, and the food thus sufficiently comminuted and impregnated with a large amount of liquid, it is a second time swallowed, the mechanism again being the same as was described under the heading of deglutition. Only about four seconds elapse from the time of deglutition of one bolus before the next is formed and ascends to the mouth. Of this period, probably one and a half seconds each is occupied by the descent of the bolus, the formation of a new bolus, and the ascent to the mouth. When the cud has been swallowed a second time it is now so finely divided that it is able to pass through the opening between the second and third stomachs. It therefore largely follows the course of the œsophageal canal, and passes rapidly into the manyplies, and from there into the true stomach, to be subjected to the action of the gastric juices. Part of it, however, possibly falls directly into the rumen and reticulum, to be mixed with the materials contained in these cavities.

In order that rumination may take place the stomach must be distended with food, otherwise the walls of the rumen will be flaccid and the abdominal muscles will be ineffective in aiding in the passage of the bolus upward through the œsophagus. Since, then, no digestion or absorption occurs within the first three gastric compartments, an animal under such a condition might die of hunger with its rumen still almost filled with food. On the other hand, the paunch must not be very much distended, or its walls will be paralyzed and will be prevented from reacting on its contents. Ruminant animals must always be well supplied with water, and their secretion of saliva must be active. Rapidly grown grasses from irrigated meadows distend the rumen far more in proportion to their solid elements than other forms of food. The distended paunch, however, soon diminishes in size, and then appears very empty, and animals cannot ruminate as effectually as with harder and drier food, as a certain bulk is required to permit of regurgitation. Rumination does not, as a rule, commence until after the animals have been watered, unless fed on green fodder or succulent roots, and even then they sometimes require water.

The position which the ruminant animal assumes during the act of rumination is common to all ruminants, and is very characteristic. The animal reclines slightly on one side, resting more or as much on the chest as on the belly, the anterior limbs flexed under the chest, and the posterior limbs brought forward and partly under the abdomen.

Ruminant animals are very timid and easily frightened, so very slight causes will arrest rumination. As soon as the attention is attracted the animal abruptly ceases to ruminate, and if lying down rises and often runs away. A sudden sound, a falling object, or some strange sight may be sufficient for this, although, of course, animals in domestication become less impressionable. Slight maladies prevent rumination, as do excessive food and gases in the stomach, venomous or narcotic plants, forced marches, fatigue, rut, and suffering of all kinds. Even the separation of a mother from her young has been known to temporarily arrest rumination. The longer rumination is postponed, the more difficult is its recommencement, since food becomes dry and compactly packed in the rumen and the manyplies, and their membranes become irritated.

It would appear at first sight as if the act of rumination was a purely voluntary process, since the least psychical disturbance interferes with its accomplishment. Nevertheless, like other complex co-ordinated movements, such as deglutition and defecation, which are partially under the control of the will, rumination is essentially reflex in nature, and has for its point of departure the irritation of the terminal filaments of the sensory nerves of the rumen. The centripetal path of this nervous impulse lies in the pneumogastrics, and explains the suspension of rumination when these nerves are divided; the automatic nervous centre is located in the medulla oblongata, its precise position being, however, unknown; the efferent nerves are the motor nerves of the stomach, diaphragm, and abdominal muscles, together with the nerves going to the muscles of mastication and deglutition, and to the parotid glands.

In goats narcotized with morphine Luchsinger was able to produce all the movements of rumination by artificially stimulating the sensory nerves of the rumen, either by pressure with the hand on the surface of the rumen, electrical stimulation, or distensions by injections of warm water. He also found that not only might the regurgitation and ascent of the bolus be so produced, but that movements of mastication and deglutition and salivation were produced even when by division of the œsophagus the ascending bolus was prevented from reaching the mouth, thus indicating that these processes also are gastric reflexes.

Rumination may thus be regarded as a species of vomiting, modified in such a manner that there is no escape of the ejected matters from the mouth, and that no more is regurgitated from the stomach at any one time than can be conveniently masticated; for as soon as the bolus engages in the gullet the œsophageal pillars become firmly contracted and the gastric orifice of the œsophagus remains closed until the cud, having been subjected to a second mastication, again enters the stomach.

## VII. VOMITING.

By vomiting is meant the convulsive rejection of the contents of the stomach through the mouth. It differs from rumination in that in most cases it is a pathological and not a normal process, and that the ejected matter usually escapes from the mouth, and is not again swallowed. In certain animals, however, as in carnivorous birds and fishes, vomiting constitutes the normal method by which indigestible substances are removed from the stomach; thus birds readily reject the contents of their crop, and the matter so rejected is often, as in the case of pigeons, used for nourishing their young.

Fish, amphibia, and reptiles readily vomit through the contractions of their stomachs, and by this means indigestible matters are removed. In frogs this process occurs frequently in June and July, and then is of less frequent occurrence as the winter approaches, and when they pass into their state of hibernation in January and February is entirely wanting. Among mammals there exists the greatest difference in the degree of readiness with which vomiting occurs, the carnivora and most omnivora vomiting with the greatest readiness, although the pig with difficulty empties its stomach by vomiting. The monogastric herbivora vomit

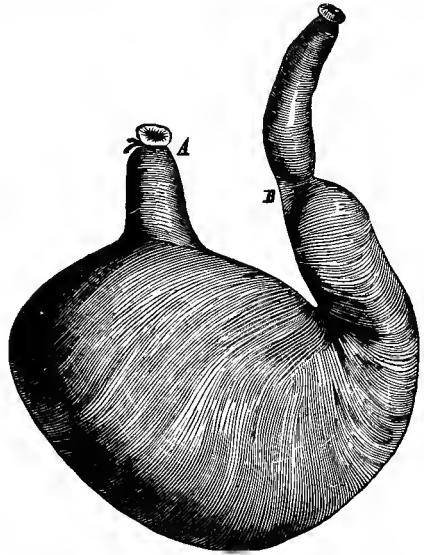

FIG. 142.—STOMACH OF THE DOG. (*Coltn.*)  
A, œsophagus; B, pylorus.

very rarely, and then only with the greatest difficulty. This difference in the degree of facility with which vomiting takes place is due to the formation of the stomach and the character of the aliments which it contains. In mammals, which vomit readily, as Colin has pointed out, the stomach is simple, and the œsophagus is inserted toward the left extremity of the stomach far from the pylorus. The œsophagus has thin, extensible walls, with an infundibular dilation at its insertion in the stomach (Fig. 142). In animals which do not vomit the stomach may be either simple or have several compartments, the cardiac orifice, in the former case, being near to the pylorus, and the œsophagus having thick walls with a narrow orifice of entrance into the stomach, which is constantly occluded by the contractions of the

powerful sphincteric muscle (Fig. 143). In animals, such as the carnivora and omnivora, which readily vomit, the stomach contains substances which are generally soft and moist and frequently finely divided, and when subjected to pressure readily escape into the dilatible cardiac orifice of the gullet. In herbivora which do not vomit the stomach is usually filled with imperfectly divided forage, imperfectly impregnated with water as compared with animal tissues and closely mixed together. When these matters are subjected to pressure, the liquids which they contain are pressed out and escape into the intestines through the large

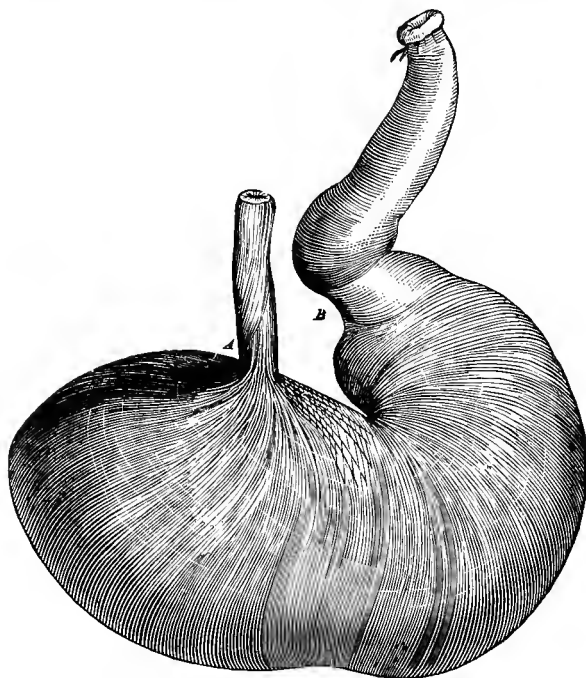

FIG. 143.—STOMACH OF THE HORSE. (*Colin.*)  
A, cardiac extremity of the œsophagus: B, pyloric ring.

and generally patent pyloric orifice. Pressure, therefore, simply serves to reduce the volume of the gastric contents, while small portions only are separated from the mass and engage in the œsophagus, and can then only move upward with great slowness.

Vomiting is inaugurated by a special nervous impression, termed nausea, which effects the combined action of the stomach, œsophagus, diaphragm, and abdominal muscles. The sensations of nausea are usually accompanied by a copious secretion of saliva (by a reflex stimulation of afferent fibres in the gastric branches of the vagus, the efferent nerve



being the chorda tympani), which, together with air contained in the mouth, is swallowed and so carried to the stomach. Vomiting is usually preceded by a series of ineffectual retching movements, which are due to spasmodic contractions of the abdominal muscles, but which are ineffective from the fact that the sphincteric muscle of the œsophagus remains contracted. In ejecting the contents of the stomach into the gullet, when vomiting commences, a deep inspiratory movement is made, and by this means the diaphragm is depressed and by its contraction forces the stomach down into the abdominal cavity, while at the same time the œsophagus becomes partially distended with air. The glottis is then closed and the abdominal muscles again spasmodically contract, while at the same time the longitudinal fibres of the œsophagus by their contraction serve to open the orifice of the œsophagus into the stomach. As long as the diaphragm remains in its contracted position and the glottis is closed, the entire force of the contraction of the abdominal muscles is expended on the abdominal contents, and as a consequence the stomach is firmly compressed between the abdominal walls and the diaphragm.

The longitudinal muscular fibres of the œsophagus radiate from the gullet over the walls of the stomach, and the contractions of the diaphragm having served to a certain extent to give a fixed point of support to the œsophageal ends of these fibres, their contraction under these circumstances will serve to pull open the orifice of the insertion of the gullet into the stomach, thus overcoming the contraction of the cardiac sphincter. The pressure to which the stomach is then subjected by means of the contraction of the abdominal muscles forces some of the contents of the stomach into the gullet, the mouth is widely opened and the neck stretched to afford as straight a path as possible, and the contents of the stomach are forcibly driven through the œsophagus and ejected from the mouth. The entrance of the food into the larynx is prevented by the closure of the glottis at the commencement of the act, and toward its completion by a forcible expiration. Ordinarily the posterior pillars of the fauces are sufficiently closely approximated to prevent the entrance of the ejected matter into the nasal chambers; but when the vomiting is very violent their contraction is overcome and the matters are forced into the nasal chambers and escape by the nostrils as well as by the mouth.

Vomiting thus consists of two distinct operations,—the active dilatation of the cardiac opening by the contraction of the longitudinal fibres of the œsophagus, and the pressure of the contracting abdominal muscles on the contents of the stomach. As long as the œsophageal ring is tightly closed, violent contractions of the abdominal muscles are entirely ineffective in expelling the contents of the stomach. Without the contraction of the abdominal muscles, even though the cardiac

sphincter may be relaxed, the stomach cannot entirely empty itself. This indicates that the intrinsic contractions of the muscular walls of the stomach are of little importance in ejecting the contents of the stomach. This was demonstrated by Majendie, who showed that vomiting might take place in an animal from whom the stomach had been excised and a bladder substituted for it. When such an operation was performed on a dog, and the bladder connected with the œsophagus and small intestine inserted in the abdominal cavity and the wound in the abdominal walls closed, injections of tartar emetic were perfectly capable of producing vomiting, thus showing that the contractions of the walls of the stomach are by no means essential to the act of vomiting.

Schiff, however, found that if the cardiac sphincter was not removed, or if the longitudinal fibres of the lower extremities of the œsophagus were damaged, as by crushing, this experiment of Majendie would then be ineffectual, thus showing that, while the contractions of the muscular walls of the stomach are of no importance in the mechanism of vomiting, the action of the longitudinal œsophageal fibres in overcoming the contraction of the cardiac sphincter is essential. This contraction of the longitudinal fibres always precedes by a few seconds the act of vomiting, and may be recognized by the insertion of a finger through a gastric fistula. As a consequence of this opening of the sphincteric muscle, the pressure within the stomach falls, as may be recognized by the connection of a manometer with the interior of this organ.

In the normal process of vomiting the contraction of these fibres is enabled to open the œsophageal sphincter, as pointed out by Foster, through the support which descent of the diaphragm has given to the stomach: consequently, in the horse the impossibility of the stomach being so supported by the diaphragm will largely explain the difficulty of vomiting in these animals; for the longer the portion of gullet between the diaphragm and the stomach, the greater will be the effect of the radiating fibres in pulling down the œsophagus and the less their capability of dilating its orifice.

The nervous mechanism which governs this process of vomiting is complicated, and, as is well known, it is a reflex action, and the afferent impulses which excite this process may reach the vomiting centre in the medulla oblongata through the most diverse paths. The vomiting centre lies in the medulla close to the respiratory centre, and this connection is probably partly functional as well as anatomical, since, as is well known, nausea may to a certain extent be overcome by rapid and deep respirations. Mechanical stimulation of the fauces, irritation of the stomach, obstruction of the alimentary canal, may all serve as stimuli which inaugurate the action of vomiting.

Again, vomiting may take place by direct stimulation of the reflex

centre in the medulla oblongata. In this way certain emetics, such as tartar emetic, probably act, for they may produce vomiting even when injected into the blood, and without reaching the stomach at all.

Again, vomiting may be produced by sensations coming from the central nervous system higher up than the medulla; thus, offensive smells or tastes or disturbed cerebral circulation, as in sea-sickness, may produce vomiting. The efferent path of this action seems to lie mainly in the pneumogastric nerve, for when this nerve is divided the cardiac sphincter remains tightly closed, and vomiting is then impossible. Section, therefore, of these nerves will, as a rule, prevent vomiting. The efferent paths of the nervous impulses passing to the muscles of vomiting are, of course, through the motor nerves supplying the gullet, the larynx, and abdominal muscles.

In the horse, as is well known, vomiting occurs only under very exceptional circumstances. The explanation of this fact, as pointed out by Colin, is to be found in the anatomical relations and physical conformation of the stomach.

In the first place, in the horse the stomach is never in contact with the abdominal muscles; hence, it is not readily subjected to pressure when the abdominal muscles contract. Again, as already mentioned, the portion of the œsophagus between the diaphragm and the stomach is longer than in carnivorous animals, and, as the stomach cannot be supported by close contact with the diaphragm, the longitudinal fibres are unable to overcome the permanent contraction of the cardiac sphincter.

In carnivorous animals which readily vomit the œsophageal orifice is at the left extremity, far from the pylorus. An antiperistaltic action tends to force food into the opening of the œsophagus. The gullet has dilatable walls and an infundibular insertion into the stomach and marked radiating fibres. The pylorus is narrow and nearly always closed, while the stomach is large and directly in contact with the diaphragm and abdominal walls, and is thus in the best possible condition for being subjected to pressure through the contraction of these muscles, while the œsophageal fibres are supported through the contractions of the diaphragm.

In the horse, on the other hand, or the hare or rabbit, the œsophageal orifice is in the middle of the lesser curvature of the stomach and near to the pylorus. Its orifice is always closed by a powerful sphincter muscle. It passes obliquely through the walls of the stomach, and is further obstructed by folds of mucous membrane, and the pylorus is large and nearly always patulous (Fig. 144).

Subjection of the stomach to pressure in the horse will, therefore, still more tightly close the œsophageal orifice, and will force the contents of the stomach into the small intestine. Occasionally, however, vomiting

has been noticed to take place in the horse. Under such circumstances it is a symptom of the greatest gravity, and in most cases it will be found to be due to the partial rupture of the walls of the œsophagus.

Ruminants, also, habitually do not vomit, but do so occasionally. When the structure of the stomach of the ruminant animal is examined, all the conditions would at first appear to favor vomiting. The gullet is large, dilatable, and has a funnel-shaped opening into the stomach; the stomach is large, is in direct contact with the abdominal walls and the diaphragm, and the pylorus is far removed from the cardiac orifice. Nevertheless, vomiting, even when intense nausea is produced by emetics,

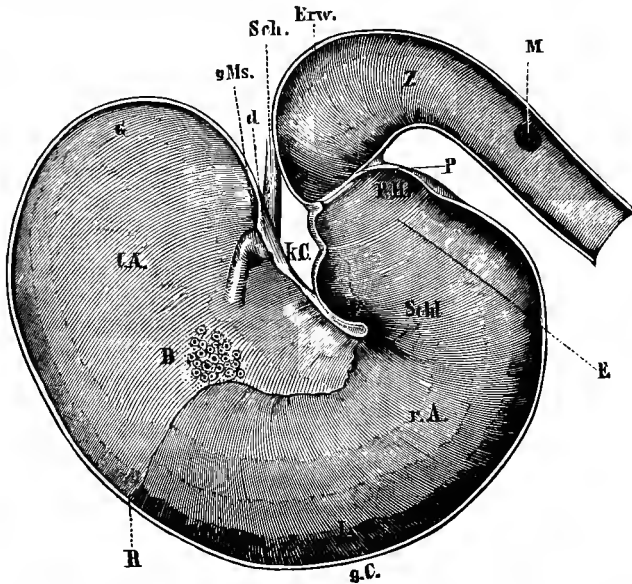

FIG. 144.—ANTERIOR HALF OF THE STOMACH OF THE HORSE, INFLATED, SEEN FROM BEHIND. (Müller.)

Sch, œsophagus; G, cardiac *cut-de-sac*; kC, lesser curvature; gC, greater curvature; LA, mucous membrane of the left half, and RA, mucous membrane of the right half of the stomach; R, dividing line between right and left halves of the stomach; F, fold projecting into stomach from the lesser curvature; L, peptic region; Schl, mucous region; gMs, muscular pillars surrounding the opening of the œsophagus; d, section of the muscular fold; P, pylorus; PH, pyloric cavity; E, constriction separating pyloric portion from right half of stomach; Z, duodenum; Erw, pear-shaped dilatation of duodenum; M, opening of the bile and pancreatic ducts.

will but rarely take place, and when vomiting does occur in these animals it is the contents of the rumen and reticulum alone which are expelled, while true vomiting should require the escape of the contents of the fourth stomach. To enable this to take place, the material from the fourth stomach would have to pass through the narrow openings of all the three preceding stomachs. When matters are ejected from the stomach through the action of emetics in a ruminant animal, if at all, the contents of the rumen alone are ejected, and these may be again swallowed, as in rumination, without escaping from the mouth.

## VIII. GASTRIC DIGESTION.

Nearly all the digestive acts so far considered are purely mechanical and solely preparatory to digestion in the sense in which the term digestion implies production of changes essential to absorption. The food has been seized, carried to the mouth and appreciated by the sense of taste, masticated and impregnated by saliva, swallowed, and in the case of ruminant animals again returned to the mouth for further preparatory change. When once, however, it enters the stomach—and it must be remembered that in the strict sense of the word this term only applies to the fourth stomach of ruminants—it is subjected to more or less profound chemical and physical changes, which are described as resulting from the processes of gastric digestion or chymification. As has been already seen, the organ in which these digestive changes are inaugurated is not distinctly defined in all species of animals, its first appearance being a mere swelling of the alimentary tube without any distinct line of demarcation at either extremity. Such a rudimentary stomach is found in all animals below the subkingdom of the articulates. In the mollusks and articulates its separation from the intestinal tube and œsophagus becomes more evident, while in insects the stomach, with its glandular appendages, becomes an important organ of digestion.

In the fish the stomach is separated from the intestine by a narrow pyloric orifice, but still lies in the direction of the long axis of the body, as is also the case in many reptiles, though in the higher members of this family and in the bird it acquires a considerable degree of complexity and tends now to occupy a position at right angles to the axis of the body. The highest degree of complexity of the stomach is found in the ruminant herbivora, and indicates that the diversity and complexity of organization of the gastric parts is governed by the peculiar alimentary habits and needs of the different species of animals.

Certain general properties and characteristics of gastric digestion are common to all the higher mammals, while, again, certain special distinctive points are found in the nature of gastric digestion according as the animals are carnivora, ruminant or non-ruminant herbivora, or omnivora. These general characteristics will first be alluded to, and the peculiarity of gastric digestion in carnivora, ruminants, and non-ruminant herbivora will subsequently demand attention.

In the first place, we must consider the mode of accumulation of food in the stomach, the changes in shape, and the motions thereby inaugurated in that organ. Then we must study the secretions poured out in the stomach as the result of contact of food with its walls, their composition and properties, and mode of separation from the blood; then the changes which the food undergoes in the stomach and during its

gradual passage into the small intestine, with the consideration of the influence of the nervous system. These steps in the process of digestion often become characteristic of gastric digestion in the different domestic animals.

If abstinence has continued for some time, the stomach will have emptied itself of its contents more or less completely, and contracted so as to obliterate its cavity in different degrees according to the different species of the animals. In the dog and other carnivora, after abstinence has continued for twenty-four or forty-eight hours, the stomach will be found to be contracted to a small volume, and will be irregular and ovoid in shape. Its mucous membrane will be thrown up into folds and its cavity almost obliterated, while the reaction of its mucous secretion will be neutral, or even alkaline. In omnivorous animals, such as the pig, the stomach does not contract so completely, nor does it ever become entirely emptied, but will, even after prolonged abstinence, be found to contain a bilious liquid and fetid gases. In the horse, after prolonged fasting, the distinction between the right and left half of the stomach becomes more marked. The right half of the stomach behaves in these respects almost like the stomach of the carnivora and becomes highly contracted, with its cavity almost obliterated. The left portion of the stomach, on the other hand, remains dilated and will nearly always be found to contain saliva which is swallowed during abstinence. When food enters the stomach after prolonged abstinence, it dilates insensibly and changes its positions and relations. In the fasting condition the pylorus sinks, and the stomach tends to assume, in this state of functional inactivity, a position in the direction of the long axis of the body, corresponding more or less with what is its normal state in lower groups of animals, in whom the stomach is of minor importance. When food accumulates in the stomach the pylorus rises, and the organ now occupies a position at right angles to the axis of the body, while it rotates on its own axis so as to cause the greater curvature of the stomach, which in the position of rest is directed downward and to the left, in the state of repletion of the organ to become transverse and directed anteriorly (or downward in quadrupeds).

The mode of accumulation of food in the stomach varies according to the character of the material swallowed. Soft and diffuent foods and liquids will mix at once, and if the food is swallowed in voluminous masses, as in the carnivora, or dry or in more or less firm boluses, as in the herbivora feeding on dry fodder, and in the non-ruminants, the first portions which enter the empty stomach are deposited in the cardia. Those which go afterward push these toward the greater curvature and toward the pylorus, while liquids and softer food fill up the interstices between them.

The capacity of the stomach is, of course, very variable in different animals in proportion to their size. It is very considerable in the carnivora; thus the dog's stomach may contain from two to ten litres; in the hog seven to eight litres will represent the average capacity; while in the horse, in proportion to its size, it is relatively very much smaller, the capacity of the stomach of the horse varying from sixteen to eighteen litres, or only one-tenth or one-twelfth of that of the intestines.

In the ruminant the mean capacity is stated by Colin to be two hundred and ninety litres. It must be remembered, however, that in the latter case the stomach of the ruminant is never empty, no matter what may be the duration of abstinence. Thus, Colin found sixty-five kilos of dry food in the first three compartments of the stomach of a cow which had fasted for a very long time; in another, after four days' abstinence, forty-two kilos were found, while in a third sixty-six kilos were found after a fast of two days.

In the horse, as the stomach fills up with food, the constriction between the right and left halves of this organ disappears, and the stomach then takes the shape as seen when distended by air after death. In the horse, no matter how much distended, the stomach is never in contact with the inferior abdominal walls, but is always separated from them by the infra-sternal curvature of the colon and a portion of the gastro-diaphragmatic curvature. In carnivora the stomach is in contact with the lumbar region above, and with the abdominal walls in the epigastrium and hypochondrium. As the stomach becomes expanded with food, the cardiac and the pyloric sphincters become contracted, and the alimentary matters by contact provoke contraction of the muscular walls of the stomach, and so serve to mix up the food.

When the food first enters the stomach these movements are slight, but they gradually become more and more vigorous, and cause a sort of churning motion in the stomach, the food travelling from the cardiac orifice along the greater curvature to the pylorus and returning by the lesser curvature. At the pylorus the circular muscular fibres are the seat of slow, rhythmical contractions, which serve to assist in the passage of the contents of the stomach into the small intestine. While these movements seem to be started by the contact of the food with the mucous membrane of the stomach, it is evidently not a mere mechanical stimulation which produces them, since, when the stomach is fullest, and when, therefore, this mechanical stimulation must be at its height, the movements are the slightest, and become more vigorous as the stomach empties itself. Apparently these contractions are started up by the commencing acidity of the gastric contents, which, at first alkaline, become gradually more and more acid as digestion progresses, coinciding with the increase in vigor of the muscular movements of the walls of

the stomach. The muscular movements of the stomach are not so regularly peristaltic as in the intestines, on account of the want of symmetry of the direction of the muscular fibres.

The nervous mechanism of the gastric movements has not been thoroughly cleared up. Numerous nervous ganglia have been found in the walls of the stomach, and this fact, in addition to the observation which has often been made, that these movements may occur in a stomach which has been separated from the central nervous system, would indicate that the ganglia start up these movements in this organ. Nevertheless, the movements of the stomach are dependent on and governed by the central nervous system, since the movements of the stomach may be induced by stimulation of the peripheral ends of the pneumogastric nerves when the stomach is full. That the movements of the stomach are not, however, solely dependent on impulses coming through the pneumogastrics is proved by their occurrence after these nerves have been divided. Stimulation of the sympathetic and celiac plexus is said to evoke contractions of the gastric walls, probably through changes in the blood supply of the stomach. The vagus nerve is without doubt the principal path through which the movements of the stomach are controlled by the central nervous system.

The contractions of the muscular walls of the stomach not only serve to mix the food contained in this organ, but also to bring all the contents of the stomach in contact with the secreting portion of its walls. This is especially important in such animals as the horse, where only one-half the organ is thus active.

The œsophageal sphincter is always tightly closed, especially in horses, where it is very firmly constricted, and so prevents the return of the food to the mouth, even when the stomach is strongly compressed. The pyloric sphincter is not so powerful and its contractions are not so prominent, but are, nevertheless, well marked in the carnivora, the pig, and the ruminant.

In solipedes the contraction of the pylorus is only faintly marked, and, as a consequence, the opening of the stomach into the intestines in these animals, for reasons which will be given directly, is nearly always patulous. Oser has found that stimulation of the pneumogastric nerves in the neck leads to an immediate contraction of the pylorus, the intensity and duration of the contraction depending on the degree of stimulation. Stimulation of the thoracic portion of the sympathetic nerve arrests the spontaneous contractions of the pylorus, the influence of this stimulation being progressive, attaining its maximum in one or two minutes and then slowly declining. After the conclusion of the stimulation the spontaneous contractions, which exist even after section of the vagi and splanchnic nerves, at first are feeble, and attain their normal degree in



about three minutes. The inhibitory action of the splanchnics in the thorax is less marked than the motor action of the vagi; the inhibitory power of the left splanchnic is greater than that of the right.

It thus would appear that the circular muscular fibres of the pyloric ring are innervated by two antagonistic sets of nerves, the vagus being the motor nerve and the splanchnic the inhibitory nerve.

When the food is received in the stomach it is gradually dissolved, and we have, therefore, to study the several processes which are concerned in this action. The general outline of the characters of that change will first be given, then the properties of the secretion to whose action it is due, the action of this secretion on the various food-stuffs, the nature of the resulting products, the conditions essential to gastric digestion, and, finally, the mode in which the gastric juice is secreted.

The study of gastric digestion is especially a study of chemical changes. It was seen that in the mouth the food was not only subjected to the chemical changes produced by the saliva, but that through mechanical changes resulting from mastication and the close mixing of the food with the saliva the materials destined to nourish the body were brought into the most favorable conditions for subjection to the various solvent juices of the economy. The first and the most important of these with which the food comes in contact in its onward passage through the alimentary canal is the gastric juice. In the experiments made on the saliva the precedent was established of performing acts of digestion, or at least acts introductory to digestion, outside the body, the natural conditions being preserved as far as possible. In the study of gastric digestion it will be found that this step is not unwarranted. All the phenomena of gastric digestion may be as completely and conveniently studied in an artificial stomach as in the living organ, a fact demonstrative of the essentially chemical nature of the process.

Not only may such experiments be conducted outside of the body, but they may even be performed with artificial gastric juice.

Such a fluid, or artificial gastric juice, of considerable purity may be obtained by mincing the mucous membrane of the stomach of almost any animal, drying the fragments between layers of filter-paper, and allowing them to remain for twenty-four hours under absolute alcohol. They are then removed from the alcohol and covered with strong glycerin. In a few days the glycerin will become strongly impregnated with pepsin, the ferment of the gastric juice, and may be preserved for almost any length of time. The addition of a few drops of this glycerin extract to one hundred cubic centimeters of hydrochloric acid of .02 per cent. will produce a fluid of high digestive power, and one which is quite permanent.

An artificial gastric juice may also be obtained by rubbing up the minced mucous membrane of the stomach, from which the mucus has been removed by gentle scraping, in a mortar with clean sand or powdered glass and water. It should then stand for some hours, being occasionally stirred, and finally filtered. The filtrate will contain pepsin and a small amount of peptones. Added to an equal bulk of .02 per cent. of hydrochloric acid, it will form a powerful digestive fluid, which may be kept for a long time, not even losing its powers when mouldy.

1. CHEMISTRY OF THE GASTRIC JUICE.—That the gastric juice may be obtained pure for analysis a fistulous opening has to be made into the stomach, since the various other methods employed by Reaumur and Spalanzani, of allowing animals to swallow sponges and then withdrawing them and obtaining the fluid by pressure, will not succeed in yielding a pure gastric secretion, as it will evidently be contaminated with the fluids of the mouth, pharynx, and œsophagus.

The method of performance of gastric fistula originated in the account of the celebrated case, reported by Dr. Beaumont, of the Canadian trapper, Alexis St. Martin, in whom an accidental gunshot wound of the abdominal walls left a fistulous tract communicating with the cavity of the stomach. It was through the data obtained by Beaumont from a study of this case that the first facts as regards the chemistry and physiology of gastric digestion were obtained. Led by an account of this case, the production of a similar fistulous opening communicating with the gastric cavity on animals was first shown to be practicable by Blondlot, and after him by Bernard. Blondlot's method was to make an incision seven or eight centimeters long in the linea alba, commencing at the xyphoid cartilage. The walls of the stomach were stitched to the wound, and, after adhesion had taken place between the peritoneal covering of the stomach and the abdominal walls, an opening was made into the cavity of the former, in which a tube was inserted.

Bernard has, however, shown that it is not necessary to allow the stomach to become adherent to the abdominal walls before opening it, and the method which he recommended is one which is now generally adopted.

In making a gastric fistula, an animal must, of course, be selected in which the stomach is large and lies close to the abdominal walls. The horse is, therefore, inappropriate for such experiments, since in the horse the stomach is small, deeply scated, and not in contact with the abdominal parietes. On the other hand, rabbits cannot be employed, since their stomachs are never empty; and cats are very liable to die of peritonitis, to say nothing of the difficulty in their subsequent management. In some birds with a muscular stomach, as, for example, in the crow, gastric fistulæ may be very satisfactorily made. The animal, however, which is, on all accounts, most suitable is the dog. Dogs are easily managed, secrete pure gastric juice in abundant quantity, and are not very liable to peritonitis.

In order to perform the operation of making a gastric fistula on a dog, the animal is well fed, so as to distend the stomach, or, after fasting twenty-four hours, the stomach may be distended by an injection of air through the œsophagus, and is then chloroformed and securely fastened. The first step is to shave the hair from the abdominal walls in the epigastric region, and to remove all the hairs carefully with a sponge, so as to prevent their entering the abdominal cavity. An incision is then made through the skin, commencing at the lower margin of the costal cartilages and about an inch and a half to the left of the linea alba, and extending downward parallel to this line for a distance a little less than the diameter of the flange of the cannula which it is desired to use. Each muscular layer is then to be divided in a direction parallel to its fibres, every bleeding point being tied before the peritoneum is opened, so as to prevent the entrance of blood into this cavity.

When it is certain that all the bleeding has stopped, the peritoneum is to be opened upon a director. On stretching open the wound the distended stomach comes into view, its oblique muscular structure being plainly visible through its serous covering. The gastric wall should then be seized with a pair of artery forceps at a point where there are not many vessels and drawn forward. Two strong silk threads are then passed into the walls of the stomach with a curved needle, at distances from each other about equal to the diameter of the tube of the cannula, and brought out again at a similar distance from the points where they were introduced. An incision is then made into the gastric walls, between the two threads, rather shorter than the diameter of the tube of the cannula. Immediately some bubbles of gas escape and some of the fluid contents of the stomach, which must be sponged off. The opening into the stomach is now to be stretched with a pair of blunt hooks until it is large enough to pass the inner flange of the cannula, which is to be then introduced and pushed into the stomach up to its outer plate. The form of the cannula usually employed is represented in Fig. 145; it consists of two tubes, each terminating at one end in a circular plate, the two tubes being cut with a screw-thread, on the outside of one and the interior of the other, so that the distance between the two plates, when the tubes are joined together, may be altered at will. After the insertion of the cannula the stomach is fastened to it by the threads which were previously inserted, and the ends of these threads passed through the abdominal walls in such a way as to fasten the stomach to them, and at the same time when tied together keep the edges of the wound in the abdominal walls in apposition. The sutures need not be carried through the peritoneum, and no additional means of closing the wound is necessary. After the animal has recovered from the anæsthetic, the cannula must be left uncorked for at least half an hour after the operation, for the dog is almost certain to vomit, and were the cannula not open the contents of the stomach would be apt to be forced past the side of the cannula into the abdominal cavity, and cause the death of the animal.

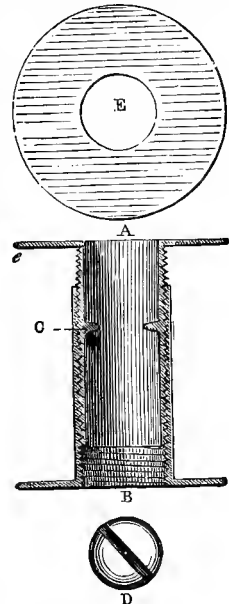

FIG. 145.—CANNULA FOR GASTRIC FISTULÆ. (Bernard.)

A B, section of the cannula; e, flange of the cannula; C, projections on the interior of tube which fit in key, D, so as to lengthen or shorten tube; E, opening of tube.

After the operation the animal must be fed on milk for two or three days and kept in a warm place. When recovering from the anæsthetic the animal will be very likely to make attempts to tear out the cannula with his teeth, a result which would be apt to be fatal to the dog. The only way this accident may be guarded against is by careful watching. It will not do to muzzle him and leave him, for if he then should vomit he would choke to death. After the first day the wound becomes so tender that no further attempts at tearing out the cannula are usually made. On the second or third day after the operation the margin of the wound becomes much swollen, and it is then necessary to lengthen the tube of the cannula so as to avoid ulceration of the skin from pressure of the external flange. By this time adhesions have been established between the edges of the wound in the stomach and the abdominal walls, and the wound in the latter having healed, with the exception of the space occupied by the tube of the cannula, the cavity of the stomach communicates with the exterior by means of a more or less elongated fistulous tract (Figs. 146 and 147). The cannula may be closed by a cork or it may be fastened with a valve.

If everything goes well, the dog will be ready for experiments in about a week.

In ruminant animals fistulous openings may be made into any one of the four stomachs or gastric compartments, although, of course, an opening into the fourth stomach is the only one through which gastric juice may be collected. The

method of operation is the same as that employed in the dog. In recent times special gastric fistulæ have been performed by Klemensiewicz, who excised in the living dog the pyloric portion of the stomach, and afterward stitched together the duodenum and the remaining part of the stomach, thus establishing the continuity of the latter organ. The excised part, with its vessels intact, was stitched to the

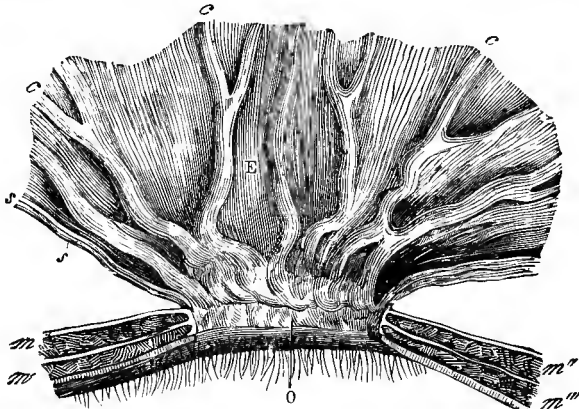

FIG. 146.—GASTRIC FISTULA, LAID OPEN. (Bernard.)

*m m' m''*, section of the abdominal walls; *s*, section of the walls of the stomach; *c*, folds of the mucous membrane, *E*; *O*, cicatricial tissue at the orifice of the fistula.

abdominal wall after closing its lower end by sutures. Heidenhain, by employing the antiseptic method, was able to preserve three dogs out of seven thus operated on. He also succeeded in isolating in the same manner the cardiac extremity of the stomach by means of this operation; therefore, it is rendered possible to obtain pure gastric secretion from either the pyloric or the cardiac extremity of this organ, and the characters of the secretions from these parts are rendered accessible for study.

In order to collect gastric juice for analysis the dog must be allowed to fast for at least twenty-four hours, so as to empty the stomach, and the secretion of gastric juice may be stimulated by tickling the inner surface of the stomach with a feather tied to a glass rod. The gastric juice will then flow along the glass rod out of the stomach, and may be collected in a glass beaker.

Bernard's method of stimulating the flow of gastric juice was to give a dog which had been fasting for some time a hearty meal of thoroughly boiled tripe, which furnished a normal stimulus to the gastric glands, and, being almost indigestible, does not contaminate the gastric juice to any great extent, and is therefore in some respects preferable to mechanical stimulation.

That the gastric juice may be obtained perfectly pure, the salivary ducts should be tied, otherwise the fluid obtained from the stomach will be more or less mixed with the saliva.

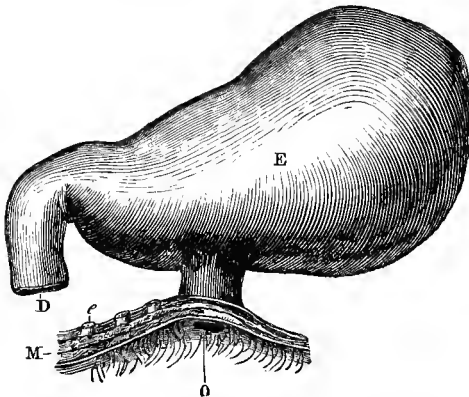

FIG. 147.—GASTRIC FISTULA. (Bernard.)

*E*, stomach; *D*, duodenum; *M*, muscles of the abdominal walls; *O*, external orifice of the fistula.

Gastric juice may also be obtained from man either by withdrawing the contents of the stomach by means of the stomach-pump, or it may be obtained, as it has been done in several instances, through a fistulous opening made into the stomach, either accidentally, as in the case of St. Martin, or, as in the case studied by Richet, in which the operation of gastrotoomy was performed by Verncuil for impermeable stricture of the œsophagus.

Gastric juice collected from a gastric fistula is a thin, limpid, almost colorless liquid of strongly acid reaction and of a specific gravity of about 1010.<sup>1</sup> It has a peculiar odor which is generally characteristic of the animal from which it is obtained. The filtered gastric juice of the dog contains from 1.05 to 1.48 per cent. solids; of the horse, 1.72 per cent., and of man, 1.27 per cent. It rotates the plane of polarized light to the left, and it is not rendered turbid by boiling, and resists putrefaction for a long time. The quantity of gastric juice secreted in twenty-four hours is only with difficulty determined, and the great discrepancy which exists between the various estimates which have been placed on this amount shows that it must vary very widely under different conditions. Thus, Beaumont estimated that one hundred and eighty grammes of gastric juice were secreted daily; Grünewald, from studies made on a similar case of gastric fistula, concluded that 26.4 per cent. of the body weight represented the amount of gastric juice daily poured out; while Bidder and Schmidt, from operations made on dogs, estimated that the daily secretion of gastric juice corresponded to about one-tenth of the body weight.

The gastric juice of a dog, even after having fasted for a long time, can never be collected perfectly pure from a gastric fistula, since it always is contaminated and mixed with remnants of undigested food, sand, and hairs from the edges of the wound, etc. In the sheep it is even more difficult to obtain perfectly pure gastric juice, since Bidder and Schmidt have found that even after thirty-six hours particles of food were still contained in the fourth stomach. When filtered, gastric juice is always clear and limpid, almost colorless, or yellowish in the dog, brownish in the sheep. Gastric juice resists putrefactive changes to a remarkable degree, and may be kept for an almost indefinite period without undergoing change.

Acids and heating produce no precipitation in gastric juice, as is also the case with lime, chloride of iron, sulphate of copper, and ferrocyanide of potassium; alkalies, on the other hand, produce precipitation, which consists of calcium phosphate with iron and magnesium phosphate and some organic matter. Corrosive sublimate always produces a precipitate, which consists mainly of the digestive ferments. Alcohol and acetate of lead give an abundant precipitate, which consists mainly of the ferment.

The gastric juice is poor in solids, containing not more than two per

cent. The usual salts found in animal fluids are also here present—chlorides of sodium, potassium, calcium, and ammonium being in excess. Phosphatic earths with some iron occupy the next place, while the sulphates are either absent or present only in minute traces. The constituents, therefore, of the gastric juice consist, in the first place, of two soluble ferments, pepsin and the milk-curdling ferment, which represent the organic constituents of the gastric secretion; second, a free acid, which is, in all probability, hydrochloric; and, third, the mineral salts.

(a) *Pepsin*.—Pepsin belongs to the category of soluble ferments. As yet it has been impossible to obtain it in a state of absolute purity.

The procedure which gives the best results is that of Brückc. The mucous membranc of the stomach is digested at 40° C. with dilute hydrochloric acid. It is then neutralized with lime, which is thus precipitated, and carries down mechanically with it the ferment, pepsin. This precipitate is washed and dissolved in dilute hydrochloric acid, and to this is added a solution of cholesterin in four parts of alcohol and one part of ether. The cholesterin throws the pepsin out of solution. It is then washed with water and with ether. The ethereal layer is poured off, and pepsin remains in watery solution, from which it may be obtained by evaporation. Von Wittieh treats the mucous membranc with glycerin, after having allowed it to remain for twenty-four hours in alcohol, so as to precipitate the proteids in the tissue of the stomach, and at the end of a week or two the glycerin is filtered off, and pepsin may be obtained by precipitating the glycerin solution of pepsin with absolute alcohol.

Obtained by either of these processes, pepsin is a yellowish powder, which is soluble in water and glycerin and insoluble in alcohol. When precipitated by alcohol from its aqueous or glycerin solutions it does not lose its solubility in water, thus differing from the proteids; it is not diffusible. When dried it may be warmed up to 110° C. without losing its activity. While in solution it may be transformed into a substance which is less active, and which has been termed isopepsiu by Finckler. At 80° it becomes entirely inactive. Pepsin is also soluble in dilute acids. If pure, pepsin should not give proteid reactions. It should yield no precipitate with nitric acid, tannic acid, iodine, or mercuric chloride. It is precipitated from its solutions by acetate of lead and platinum chloride.

The proportion of pepsin in the gastric juice varies at different periods of digestion. At the commencement of digestion it is present in the smallest amount, and acquires its maximum between the fourth and fifth hours of digestion. In man it is said to be present in amounts varying from 0.41 to 1.17 per cent.

Without the addition of dilute acid pepsin manifests no specific action, and the characteristic test of the presence of this ferment is known as the pepsin test with fibrin. If a little fibrin, obtained by whipping the blood as it flows from a divided vessel, is washed until perfectly white and placed in a test-tube with a little gastric juice, and warmed up to 35° C., the fibrin will entirely disappear. There will be

no precipitate upon boiling, and but slight precipitation on neutralization. Since no other substance will produce this result with fibrin, it is characteristic of the presence of pepsin with a dilute acid.

(b) *Milk-Curdling Ferment*.—As is well known, when milk is brought into contact with the mucous membrane of the stomach, or when an infusion of the mucous membrane of the stomach is added to milk, it coagulates. This process is made use of in the manufacture of cheese, and was formerly attributed to the acid of the gastric juice or to the production of acidity in the milk from the development of lactic acid from milk-sugar. It has, however, been shown that milk, while completely neutral, may be coagulated by an infusion of gastric juice, or by a neutral infusion of the mucous membrane; and since this specific action of the gastric juice in curdling milk is destroyed by boiling, it also is attributable to a specific ferment, which is termed the milk-curdling ferment, or rennet.

This ferment produces coagulation of the casein of milk without calling in in any way the action of the acid, and will produce its characteristic results in solutions of casein which are entirely free from milk-sugar and which are perfectly neutral.

Solutions of the milk-curdling ferment may be obtained by digesting the mucous membrane of the stomach with glycerin. A few drops of this glycerin extract, which also, of course, contains pepsin, will cause a hundred cubic centimeters of fresh milk to coagulate within a few moments if heated up to 40° C.

Several other methods have been proposed for the extraction of milk-curdling ferment, but in all pepsin is nearly always present.

Hammarsten has found that by precipitating with carbonate of magnesium or acetate of lead solution, a solution of milk-curdling ferment might be obtained which is perfectly free from pepsin; for although both ferments are carried down by this precipitate, all the pepsin remains in the precipitate, while a considerable amount of the milk-curdling ferment passes through the filter. By this means Hammarsten was enabled to obtain solutions which would coagulate fresh milk in one to three minutes at the temperature of the body, even in neutral fluids, while when acidulated they were entirely incapable of dissolving the smallest particles of fibrin.

Little is known as regards the chemical reactions of the milk-curdling ferment. It does not coagulate, when in watery solutions, by boiling, nor is it precipitated by alcohol, nitric acid, iodine, or tannin. It is precipitated by the basic acetate of lead; it does not give a yellow color with hot nitric acid; it does not diffuse through parchment-paper, and only with difficulty through unglazed earthenware. Milk-curdling ferment is a less stable substance than pepsin and is destroyed at a lower temperature than pepsin; thus, if a solution which contains both pepsin and milk-curdling ferment is heated about forty-eight hours to 37° or 40° C. in a .02 per cent. HCl. solution, it loses all power of

coagulating milk, while the pepsin remains unaffected. In neutral solutions, on the other hand, the milk-curdling ferment may be heated up to 70° C., or even may be boiled for a moment without being entirely destroyed. Alcohol only slowly interferes with the milk-curdling ferment; caustic alkalis rapidly destroy it. Even .02 per cent. of caustic soda is sufficient to cause a previously active ferment solution to become entirely inactive. Salicylic acid does not interfere with its action. In common with the other ferments, an almost infinitely small amount of this ferment will coagulate an immense volume of milk. Hammarsten precipitated a glycerin extract of milk-curdling ferment with alcohol, dissolved the resulting precipitate in water, and, since the percentage of solid in this solution could be readily determined, was able to estimate that one part by weight of milk-curdling ferment would coagulate at least from four hundred thousand to eight hundred thousand parts of casein. The milk-curdling ferment is entirely without action on sugar solutions and is without influence in the digestion of albumen. It has been found that milk-curdling ferment is principally secreted by the glands of the fundus of the stomach, while the pyloric region furnishes but a small amount of this ferment. Milk-curdling ferment may almost invariably be found in watery extracts of the stomach of the calf and sheep, while in other mammals and birds it is usually absent, and is scarcely ever to be detected in the stomach of the fish, even although watery extracts of the stomachs of these animals become effective after being first acidulated and then after twenty-four hours again neutralized. This would seem to show that the acid serves to develop milk-curdling ferment out of some previously inactive body. The coagulation of milk by the milk-curdling ferment is more analogous to the process of coagulation of the blood than to our generally accepted ideas as to the processes of fermentation; for the casein, a soluble albuminoid body, through the action of rennet simply becomes insoluble without undergoing any other change. Its action is, therefore, directly opposed to that of pepsin, which converts an insoluble albuminoid into a soluble body.

A difference also exists in the result of coagulation of milk, according as this coagulum has been produced through the action of the ferment or by the development of acid. In the latter case the precipitate is still casein, in the former case it is cheese. In the former instance the casein is precipitated in fine, tender flocculi, which are readily soluble in dilute acid, but solutions that are coagulated by rennet are very much less soluble.

The process differs still further in that the casein precipitated by acids, if carefully washed, may be obtained perfectly free from ash. Casein precipitated by a milk-curdling ferment, on the other hand, always contains phosphate of lime, and this salt seems to be essential to the



action of the milk-curdling ferment; for rennet is entirely ineffective when the earthy phosphates are absent. Thus, if casein is precipitated by an acid and dissolved in a small amount of alkali, after careful washing rennet is entirely incapable of producing a coagulum; so also milk, when subjected to dialysis, by which means the salts are removed, is incapable of coagulating under the influence of rennet. As to whether there is a chemical association of the phosphates in the production of the coagulum by the action of rennet or not, or whether it acts merely mechanically, is not known.

In addition to the milk-curdling ferment, which, as already stated, is said to be entirely ineffective on milk-sugar, there appears to be still another and third ferment in the gastric juice, different from both pepsin and milk-curdling ferment, and which has for its action the conversion of milk-sugar into lactic acid; for both pepsin and rennet may be destroyed by the action of a dilute caustic soda solution, and the resulting fluid will still be able to convert milk-sugar into lactic acid.

(c) *The Acid of Gastric Juice.*—The greatest controversy has for a long time existed as to the nature of the free acid of gastric juice. The contradictions on this subject are evidently due to the fact that in the process of analysis the hydrochloric acid usually found might possibly originate from the breaking up of the metallic chlorides which are constantly found in this secretion.

Prout first separated hydrochloric acid from gastric juice by distillation, and Lehmann suggested that when metallic chlorides are distilled with lactic acid, hydrochloric acid will always pass into the distillate; and on account of this objection it was for a long time believed that the acidity of gastric juice was normally due to the presence of free lactic acid.

Schmidt's analysis of gastric juice, however, overcame this objection raised by Lehmann, as he found in the secretion more hydrochloric acid than could saturate all the bases present. Numerous proofs have since then been brought forward which all tend to demonstrate that hydrochloric acid in a free state is the cause of the acid reaction of this secretion; thus Richet proved by the degree of solubility in ether, according to the method pointed out by Bertholet, who found that while mineral acids were soluble in ether organic acids were insoluble, that the acid of gastric juice must be a mineral acid, and from what he termed the coefficient of partage with ether that acid was hydrochloric. Still another proof is found in the fact that gastric juice behaves like mineral acids in giving the color of sulphocyanide of iron when added to a solution of sulphocyanide of potassium and citrate of iron and quinine (Reoch); while, still further, the addition of gastric juice to starch-mucilage containing iodide of potassium will develop the blue iodide of starch by liberating the iodine from the potassium.

In addition to these tests, a number of reagents, such as tropeolin, methyl-violet, Congo-paper, etc., have been proposed to distinguish mineral from organic acids. The best of the more recent tests is *phloroglucin-vanillin*, described by Wiesner and Gunzburg. Two grammes of phloroglucin and one gramme of vanillin form a reddish-yellow solution with thirty grammes of absolute alcohol. A drop of this solution in the presence of a trace of a free mineral acid forms a brilliant red color, at the same time depositing bright-red crystals. On the other hand, organic acids, such as lactic or acetic acids, or even chlorides mixed with these acids, produce no change in coloration.

There is no doubt but that lactic, butyric, and other organic acids may be present in gastric juice, but their origin is to be explained by their respective fermentations, from articles of food, or from decomposition of their salts. The amount of free acid found in gastric juice in a state of health may vary from 0.02 per cent., as stated by Bidder and Schmidt, which is probably a low estimate, to 0.5 per cent., as estimated by Heidenhain, in the gastric juice of the dog.

The degree of acidity of the gastric juice differs in different animals and under different conditions. In the dog, Bidder and Schmidt found that one hundred parts of filtered gastric juice required 0.390 grammes potassium hydrate for neutralization; in the sheep, one hundred parts of gastric juice required only 0.264 grammes potassium hydrate, indicating in a general way that the degree of acidity of this secretion is higher in the carnivora than in the herbivora.

The degree of acidity varies also with the stage of gastric digestion. Rothschild found, after the administration of fifty grammes of rare meat and three hundred and twenty-eight grammes of water through the œsophageal sound in healthy individuals, that hydrochloric acid was the only acid present. The degree of acidity was determined by removing the contents of the stomach by the stomach-pump. The following table shows the results of his investigations:—

After $\frac{1}{2}$ hour,	0.74 per mille, H Cl.
“ 1 “	0.84 “ “
“ $1\frac{1}{2}$ hours,	0.99 “ “
“ 2 “	1.40 “ “
“ $2\frac{1}{2}$ “	2.46 “ “
“ 3 “	stomach empty.

There seems to be certain reasons for supposing that hydrochloric acid is not entirely free, but in a state of partial combination with some substance which does not entirely destroy its free acidity. Thus, gastric juice has been found to dialyse differently from a solution of hydrochloric acid of the same percentage.

Numerous theories have been proposed to explain the formation of the free acid of gastric juice. No one of these views has reached the

dignity of a demonstration. It is known that the acid is formed only by the parietal cells of the gastric tubules, and the free acid is found on the free surface of the gastric mucous membrane. An experiment devised by Bernard serves to demonstrate this. For the production of Prussian blue through the union of potassium ferrocyanide and a salt of iron, an acid reaction is requisite. Claude Bernard injected potassium ferrocyanide, and afterward a solution of lactate of iron into the veins of a dog. When examined after death, the blue color was found only in the upper layers of the gastric mucous membrane, showing thus that this locality was the sole seat of the acid reaction. As to the origin of this acidity, it appears that the parietal cells of the gastric glands form hydrochloric acid from the chlorides which the mucous membrane takes up from the blood; for, if sodium chloride be withheld from the food, the formation of hydrochloric acid ceases. The active agent in this splitting up of the chlorides is probably lactic acid, which, by splitting up sodium chloride, forms free hydrochloric acid, while the bases, forming alkaline salts, are excreted by the urine. The renal secretion is, therefore, less acid during digestion than in the intervals of digestion.

The following tables represent the quantitative composition of gastric juice in different animals:—

	Man.	Dog.	Sheep.
Water,	994.40	973.06	986.14
Organic matter (especially ferments),	3.19	17.13	4.05
Sodium chloride,	1.46	2.50	4.37
Calcium chloride,	0.06	0.26	0.11
Hydrochloric acid,	3.19	17.13	4.05
Potassium chloride,	0.55	1.12	1.52
Ammonium chloride,		0.47	0.47
Calcium phosphate,		1.73	1.18
Magnesium " }	0.125	0.23	0.57
Ferrie " }			

2. THE ACTION OF GASTRIC JUICE ON THE FOOD.—The general solvent effects of the gastric juice on food-stuffs may be roughly illustrated by means of an experiment devised by Schiff, in which the stomach, removed from the body and placed in an acid medium, is capable of digesting itself. If the stomach is removed from a dog, mined into small pieces, and infused in four or five hundred cubic centimeters of HCl of 0.02 per cent. in an oven at 40° C., at the end of eight to ten hours the fragments of the stomach will be found to be almost entirely liquefied. In the structures of the stomach are found the principal animal substances which serve as nutriment. Albumen and fibrin of the blood are present, muscular tissue, and connective tissue. These substances then being dissolved, as may be demonstrated by the fact that the liquid, which may be filtered off from the small, pulpy and yellowish residue, is free from solid material, it remains only to determine in what form these albuminoid constituents of the tissues are present in the solution.

As has been already stated, albumen is precipitated from its solutions by boiling or by a concentrated mineral acid. If the filtrate from this autodigestion of the stomach is boiled no coagulum will be formed, nor will an addition of nitric acid cause any precipitate. If albumen is present in this solution, it must, therefore, exist in a modified form.

Millon's test and the xanthoproteic reaction will indicate in this filtrate the presence of an albuminoid body. If the filtrate be neutralized by the careful addition, drop by drop, of a little liquor potassæ, when the fluid is perfectly neutral a precipitate will be formed. These tests show that while albuminoid bodies do exist in the filtrate, they have been transformed by the gastric secretions into other members of the proteid group.

Recollecting the statement made in a preceding chapter as to the effect of dilute acid on albumen, it was found that if a dilute acid was added to a solution of albumen, the albumen totally lost its power of coagulating by heat and was rendered insoluble in water. It was therefore thrown out of solution by neutralization. When such a solution of acid albumen was exactly neutralized, the filtrate was found to be entirely free from proteid in solution. If, on the other hand, in this experiment of autodigestion by the stomach the precipitate produced by neutralization is filtered off, the filtrate will still show the presence of proteid in large amounts. The results of gastric digestion are not, therefore, entirely identical to the action of a dilute acid, for we find a portion of proteid which is still soluble in neutral solutions and is nevertheless not coagulated by boiling; consequently, the modifications of albuminoids produced by the action of the gastric juice are not due solely to the acid alone.

This fact can be still further demonstrated by a simple experiment.

In four test-tubes may be placed some fragments of boiled blood-fibrin. In one tube are placed ten cubic centimeters of hydrochloric acid of .02 per cent.; in No. 2 are placed ten cubic centimeters of artificial gastric juice made by adding a few drops of glycerin-pepsin extract to dilute hydrochloric acid, as already described; in No. 3 are placed ten cubic centimeters of the same artificial gastric juice carefully neutralized; and in No. 4 ten cubic centimeters of gastric juice thoroughly boiled. All of these tubes are then to be placed in an oven heated by 40 degrees centigrade. At the same time, duplicates of tube No. 2 are to be prepared, one being surrounded with ice and the other kept at the temperature of the room. On examination of these tubes after four or five hours, it will be found that in tube No. 1, which contained acid alone, the fibrin is swollen up into a stiff jelly, but has not been dissolved. In No. 2, which contained artificial gastric juice, the fibrin will have entirely disappeared. In No. 3, which contained gastric juice neutralized, or, in other words, pepsin in solution, the fibrin will be unaltered, while in No. 4, which contained the boiled gastric juice, the appearances will be identical with those of No. 1. It may be learned from this that fibrin is not dissolved by acid alone nor by pepsin alone, but that their combination is necessary for its solution, while it is also seen that pepsin is destroyed by heat. By referring to the other two tubes, it will be seen that the fibrin will present the same appearance almost as seen in tube No. 1, showing, therefore, that cold prevents the action of gastric juice. If, however, the tube which was in the ice is placed in a warm oven, the fibrin will be rapidly digested, showing that its solution was simply suspended by cold. The solvent action of the gastric juice is, however, totally destroyed by boiling. If tube No. 1 be exactly

neutralized, the fibrin will regain its original appearance. If tube No. 3, which contained the neutralized gastric juice, be acidulated to proper degree, the fibrin will be dissolved. If tube No. 2 is neutralized, there will be a precipitate varying in amount with the duration of the digestion. If that precipitate be filtered off, the filtrate will still show the presence of a proteid body.

The results of gastric digestions are, thus, not dependent upon the acidity of the gastric juice alone, for we find that when the neutralization product is filtered off there still remains in solution in the filtrate a large quantity of proteid matter. This substance is termed peptone, and has the same elementary composition as albumen and gives most of the proteid reactions, it, however, differing from the ordinary proteids in several respects. In the first place, solutions of peptone diffuse readily and are readily filtered. They are not precipitated by boiling and nitric acid, acetic acid and potassium ferrocyanide, and saturation with common salt. They are precipitated from neutral or faintly acid solutions by mercuric chloride, tannic acid, bile acids, and phosphowolframic acid; they will yield the Millon's and xanthoproteic tests, and with caustic soda or potash and a small quantity of eupric sulphate they give a beautiful purple-red color instead of the violet yielded by other albuminous bodies (Biuret test). They rotate the plane of polarized light to the left. When injected into the blood they do not appear in the urine, as is the case with egg-albumen, but when injected in large amounts produce the symptoms of a narcotic poison and prevent coagulation of the blood. When dried, peptones are amorphous, transparent, yellowish-white, hygroscopic powders, while when freshly precipitated they closely resemble coagulated casein in appearance.

When proteids are subjected to the action of gastric juice, the acid first transforms the albuminous bodies into a substance analogous to acid albumen, termed parapeptone, this substance thus standing midway between the albumen and peptone. By the continued effect of the action of the gastric juice, principally through the influence of the pepsin, the parapeptone passes into a true soluble peptone, its formation being due to the taking up of a molecule of water. Under the influence of the hydrolytic ferment of pepsin, the greater the amount of pepsin, within certain limits, the more rapidly the solution takes place, although it seems that the pepsin is not used up in the process of gastric digestion; and if the degree of acidity be kept uniform, almost unlimited amounts of albumen may be digested by a small amount of pepsin. Large amounts of peptones appear to interfere with the digestion of albuminous bodies; but if the peptones are removed as rapidly as formed, digestion may go on until all the albumen is converted into peptones, or until the acidity has disappeared.

The gastric juice only digests the albuminous constituents of food, vegetable albuminoids being digested in the same manner and with the

same products as albuminoids of animal origin. On carbohydrates the ferment of gastric juice is without effect, the cases reported in which starch has promptly been converted into sugar in the stomach being attributable to the action of saliva which had been swallowed. The salivary ferment is not destroyed in the stomach, since saliva may be kept for days together in contact with gastric juice, and if the acid be then neutralized the diastatic power of the saliva may still be exerted. The change of starch into sugar in the stomach will vary in intensity according as the animal is carnivorous or herbivorous. In the former case the saliva possesses but little diastatic power, and the food being swallowed without mastication no conversion of starch into sugar may be said to occur in the mouth, while the high degree of acidity of the gastric juice will almost entirely prevent the action of saliva in the stomach. Carbohydrates, therefore, when given to carnivora, pass through the stomach almost unchanged, and are only converted into sugar when brought into contact with the pancreatic and intestinal secretions. In the case of ruminant herbivora the food and saliva are carried together to the rumen, where the high temperature and alkaline reaction favor the conversion of starch into sugar. In the non-ruminant herbivora, as in the horse and rabbit, the sojourn of the food in the mouth is much more prolonged than in other animals, and time is given for the partial conversion of starch into sugar to take place. When the unconverted starch and saliva reach the stomach the process may still go on, for, in the first place, the acidity of the gastric juice is much less in these animals than in carnivora, and, in the second place, as will be shown directly, the acid of the gastric secretion in these animals in the first stage of digestion is lactic and not hydrochloric acid, and the action of ptyalin may still take place in a fluid containing 2 per cent. of the former acid, while it ceases in 0.5 per cent. of the latter. By the time, therefore, that hydrochloric acid has been substituted for lactic acid, it may be concluded that the starch has been mainly converted into sugar.

Again, cane-sugar is slowly converted in the stomach into invert-sugar, apparently through the influence of hydrochloric acid. Fats are but slightly digested by gastric juice, it appearing that a small part of the fat is broken up into glycerin and fatty acids. When adipose tissue is subjected to the action of gastric juice, the albuminous cell-envelopes are dissolved and the fat liberated in the form of free oil-globules, only a small portion of which is broken up into fatty acids and glycerin, while the remainder escapes into the small intestines to be acted upon by the pancreatic secretion. When milk is introduced into the stomach, the casein, through the action of the milk-curdling ferment together with the acid of the gastric juice, is coagulated and forms the curd, in which the oil-globules are held. In a subsequent stage of digestion, the casein

is dissolved and converted into peptone, and the oil is again liberated. When, therefore, artificial gastric juice is added to milk warmed to the temperature of the body, the casein is rapidly coagulated and a tolerably firm, white curd is formed, floating in the clear fluid, the whey, which contains the salts, milk-sugar, water, and albumen of the milk. As digestion progresses, the casein being turned into peptone, the oil is set free and the whey again becomes milky, from the oil again passing into the state of partial emulsion.

Gelatin and connective tissues are dissolved and peptonized by the gastric juice. When gelatin has been subjected to the action of gastric secretion, its solutions no longer solidify when cold, but a gelatin-peptone is formed which is soluble and diffusible, although it differs from a true peptone. When muscular tissue is subjected to the action of gastric juice, the sarcolemma becomes dissolved, the muscle-fibre breaks up transversely into disks, which become dissolved and converted ultimately into a true peptone. Horny tissues are unchanged by gastric juice, as is also amyloid substance. Red blood-corpuscles are dissolved in the stomach, the hæmoglobin being decomposed into hæmatin, and the globulin is ultimately transformed into peptone, while the hæmatin is partly unchanged and partly converted into bile-pigment.

That the stomach is able to digest albuminous bodies of the most varying nature, and yet escape digestion itself by its own secretion, is a fact of which explanation has as yet never been clearly determined. It has been attributed to the alkalinity of the blood in the tissues neutralizing the gastric juice and so protecting the tissues of the stomach; if that were so, we would expect that the pancreatic secretion, being most active in an alkaline medium, would be aided by the alkalinity of the blood in digesting the walls of the intestine. The protection of the walls of the stomach during digestion has been attributed to the mucus or the epithelium lining the stomach; both may, however, be mechanically removed through a gastric fistula—and both are, undoubtedly, at least partially removed in the use of the stomach-sound—and yet without the walls of the stomach being digested.

The obscurity is rendered still more intense by the fact that under certain circumstances the stomach does digest itself. If an animal be killed during active digestion, and the body kept at an elevated temperature, the walls of the stomach will be digested; or if the stomach be excised from an animal and covered with dilute hydrochloric acid, it will be almost completely dissolved. These facts have been attributed to the absence of vitality; but if the leg of a living frog be inserted through a fistula into the stomach of a dog it will be completely digested, and in the maintenance of a gastric fistula in dogs it will often be noticed that the edges of the wound become corroded from the escape of gastric

juice along the sides of the caecum. The subject must, therefore, be left where we started: the stomach during life does not digest itself, but its immunity cannot be satisfactorily explained.

3. THE SECRETION OF GASTRIC JUICE.—The walls of the stomach are constituted by four coats, composed *externally* of the peritoneum or serous layer; *second*, the muscular layer, composed of longitudinal, circular, and oblique unstriated muscular fibres; *third*, the submucous layer of connective tissue, in which are found numerous blood-vessels, lymphatics, and glands; and, *fourth*, the internal mucous coat, in which are found the glands of the stomach. The mucous membrane is covered throughout its entire extent by a single layer of narrow, cylindrical, epithelial cells similar to the ordinary mucus-secreting goblet cells. The tubular glands of the stomach are of two distinct kinds, traversing the mucous membrane vertically and differing greatly as they are located in the cardiac or pyloric portions of the stomach. The glands found in the cardiac portion of the stomach or fundus are called the peptic glands, and consist of several short tubules opening into a broad duct which is lined by epithelial cells similar to those on the free mucous membrane of the stomach. The lower portions of the tubes, those portions which alone form the gastric secretion, are lined by a layer of small granular, columnar, nucleated cells (Fig. 148). These cells border the lumen of the gland and are termed the chief or central cells. At various places between

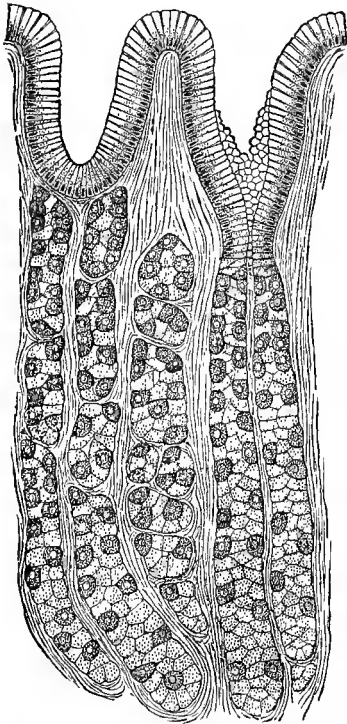

FIG. 148.—GLANDS OF THE FUNDUS OF THE STOMACH. (Heidenhain.)

these cells and the membrana propria are large, oval or angular granulated, nucleated cells, which are termed parietal cells. These cells are most numerous in the necks of the glands and less so in the lower ends of the tubules (Fig. 149). They are stained deeply by osmic acid and aniline blue, and bulge out the membrana propria opposite to where they are placed, and are thus readily recognized.

The pyloric glands (Fig. 150) are generally branched at their lower ends, several tubes opening into a single duct, which is long and wide.



The duct is lined by epithelium like that lining the stomach, while the deeper part is lined by a single layer of short, fine, granular, columnar cells.

It is thus seen that the glands of the fundus and pylorus are histologically different, and it has been found by the method of partial fistula, by excising certain portions of the stomach, that the character of the secretions formed by these cells is also different. Here also, as in the salivary glands, changes occur in the interior of the cells according as the gland is active or has been exhausted. During fasting the chief cells of the fundus and all the cells of the pyloric glands are clear and of moderate size. During digestion the chief cells become enlarged or turbid and granular; the parietal cells also enlarge, while the pyloric cells remain unchanged, and only become enlarged toward the ter-

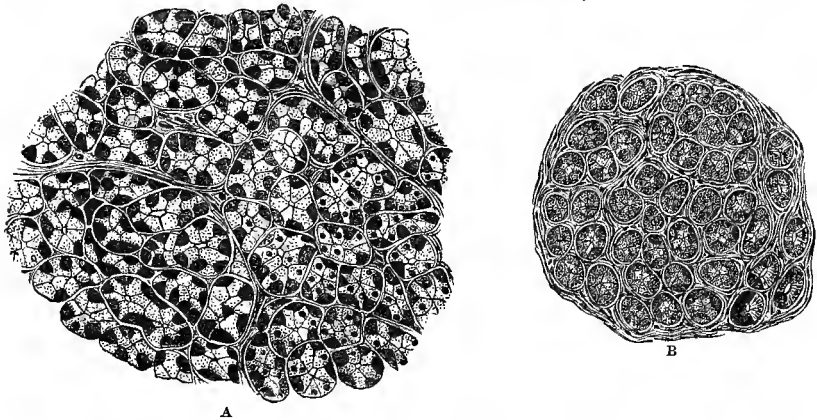

FIG. 149.—CROSS-SECTION OF THE GLANDS OF THE FUNDUS OF THE STOMACH. (*Heidenhain.*)

A, through the body of the gland; B, through the neck.

mination of digestion. Often during the last hours of digestion the chief cells again become larger and clearer, the parietal cells diminish, and the pyloric cells decrease in size and become turbid. We therefore see that there are three different forms of anatomical elements found in the stomach, and these different cells furnish different forms of gastric secretion (Figs. 151 and 152). When the stomach is empty its reaction is alkaline and its mucous surface is covered with a layer of mucus which is formed from the cylindrical epithelial cells, which line the free surface of the mucous membrane and dip into the ducts of the glands. The gastric juice proper comes from the tubules which line the entire stomach with the exception of the cardiac and extreme pyloric ends. Gastric juice, as has been seen, contains pepsin, hydrochloric acid, and the milk-curdling ferment. The pepsin is formed by the chief cells found throughout

all the tubular glands of the stomach. When these cells are clear and large they then contain their maximum amount of pepsin. After the secretion of gastric juice has lasted for some time, these cells become contracted and turbid and then contain but a small amount of pepsin. According to certain authorities, pepsin is not directly formed in the cells of these tubular glands, but results from the transformation, by means of hydrochloric acid or sodium chloride, of a mother-substance or zymogen which has been termed pepsinogen.

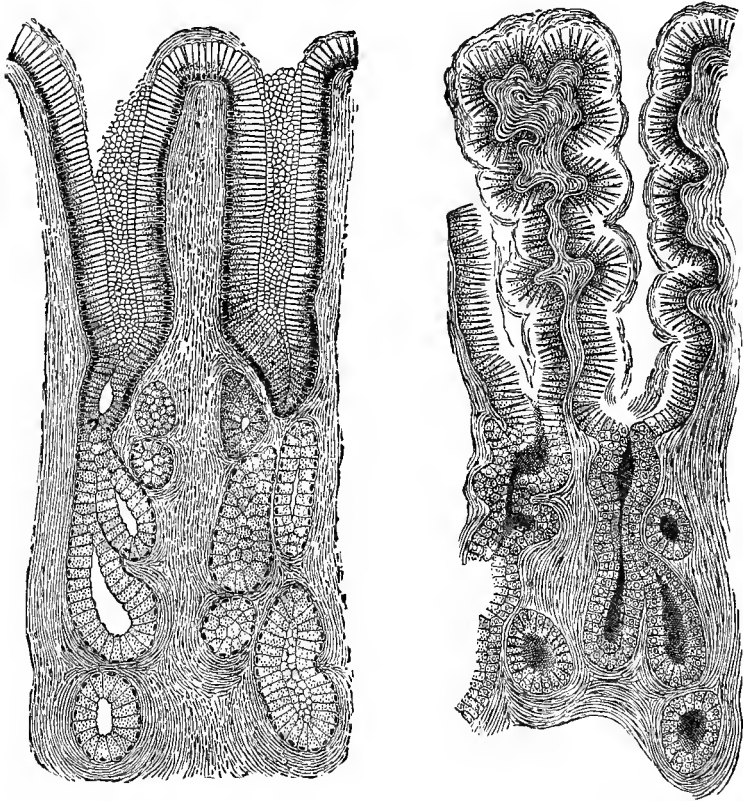

FIG. 150.—PYLORIC GLANDS OF THE STOMACH.  
(Heidenhain.)

FIG. 151.—PYLORIC GLANDS—COM-  
MENCING CHANGES DURING DIGES-  
TION, AFTER EBSTEIN. (Heidenhain.)

These statements as to the formation of pepsin are based upon the fact that the secretion withdrawn from the isolated cardiac or pyloric extremity of the stomach contains pepsin in abundance, although the quantity is more marked in the secretion formed by the glands of the fundus. So, also, in the frog, glands similar in character to those containing chief cells are found in the tubules located in the lower portion

of the œsophagus. Here, also, the secretion poured out by the glands of this locality is alkaline, and yet contains pepsin, while a watery infusion of this part of the frog's stomach is also highly peptic. On the other hand, the hydrochloric acid is formed, according to Heidenhain, by the parietal or associate cells, which are found only in the glands of the fundus. This statement, also, has been proved by the determination that the secretion alone of the fundus during active digestion has an acid reaction, while that of the pylorus never acquires any acidity. So,

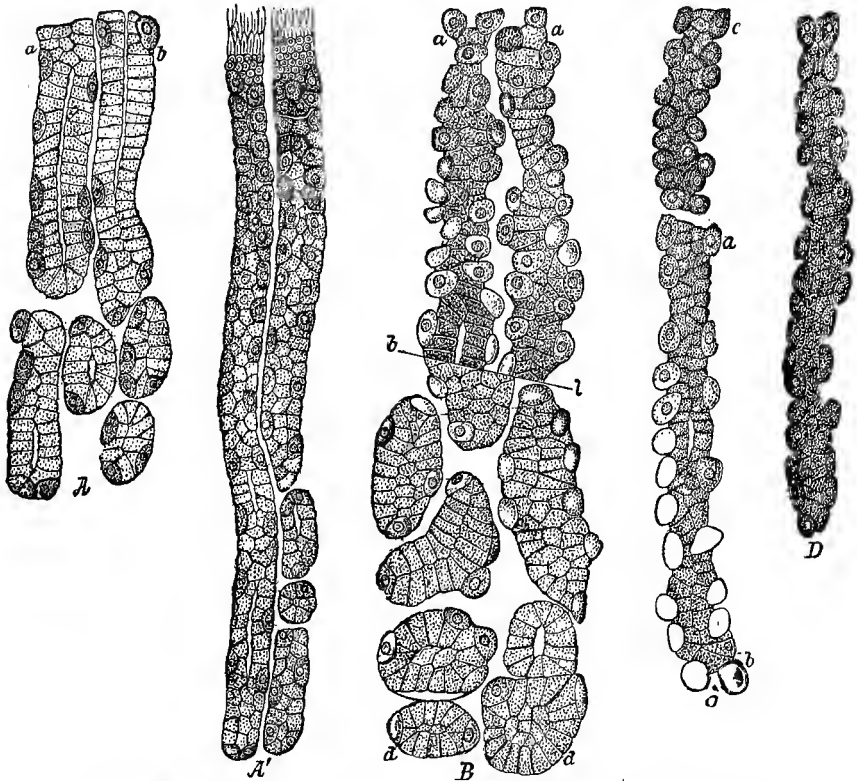

FIG. 152.—GLANDS OF THE FUNDUS OF THE STOMACH. (Heidenhain.)

*A* and *A'*, during fasting; *B*, first stage of digestion: enlargement of the chief cells and commencing turbidity; *C* and *D*, second stage of digestion: the chief cells become smaller in size and more and more turbid.

again, in the frog these associate cells are found in the stomach, and not in the tubular glands of the œsophagus, and it is known that in the stomach alone free acid is formed. Again, in hibernating animals the chief cells disappear, and in these animals the secretion of gastric juice never acquires an acid reaction. The milk-curdling ferment is, probably, also formed by the central cells, especially those of the pyloric extremity,

since it has been found that it is this locality of the stomach which yields the milk-curdling ferment in largest amounts.

As regards the action of the nervous system on the secretion of gastric juice, very little is known. It seems clear that this secretion, like that of the saliva and of other glands, is a reflex process; for when the stomach is empty there is no secretion of gastric juice, which only takes place when proper stimuli are applied to the mucous membrane of the stomach. Such stimuli may be either mechanical or chemical, and the immediate result of their contact is to cause an increase in the activity of the circulation through the walls of the stomach, with a consequent increase in temperature which may amount to as much as 1° C. The mechanism of secretion, therefore, is, in all probability, identical with that of other glands. The nerves which influence the secretion are almost totally unknown, since no nerve has been found whose stimulation leads to the secretion of gastric juice in a manner at all analogous to that which results from the stimulation of the chorda tympani in producing the secretion of saliva. It seems probable that the centres whose reflex stimulation leads to the flow of gastric juice are located in the stomach, for both the pneumogastric and sympathetic nerves may be divided, and local stimulation of the gastric mucous membrane will still lead to a flow of gastric juice. The pneumogastrics, nevertheless, besides being the sensory nerves of the stomach, seem to be concerned in the production of the vascular dilatation, which is of such importance in the production of the secretion; for, if both pneumogastrics are divided during digestion, the mucous membrane of the stomach becomes pale. The secretion of gastric juice is also undoubtedly in some way connected with the central nervous system, for Richet has noted the fact that in a case of complete œsophageal stricture, observation of the stomach through a fistulous opening into this organ proved that the secretion of gastric juice followed the introduction of acids or sugar into the mouth.

4. GASTRIC DIGESTION IN CARNIVORA.—The importance of the stomach in the operation of digestion varies greatly in different animals. In the carnivora the action of the stomach is less constant than in the herbivora, but is of greater importance. While its action is intermittent, the intervals between its periods of activity and the duration of its activity are more prolonged. Carnivora swallow their food in large fragments, torn only small enough to be swallowed, and in many cases swallow their prey entire. Their mastication is of slight importance, for they feed on substances readily soluble in gastric juice, the only function of the saliva being to render the food easy of deglutition, it having scarcely any digestive function to fulfill. In carnivora, as already stated, the conformation of the mouth, pharynx, and gullet enables large masses

of animal matter to be introduced into the stomach. The gastric mucous membrane secretes gastric juice throughout its entire extent, and the digestion in the stomach in carnivora is the most important stage in the preparation of food for absorption. The secretion is rapidly poured out after taking a meal, the activity being in accordance with the degree of stimulation which the aliments exercise on this viscus. Thus, there is less secretion formed when gelatin, gum, starch, and other indigestible substances are swallowed, while the secretion is copious when meat, bone, and other albuminous bodies are introduced into the stomach. The total amount of gastric juice secreted by carnivora can only be determined with difficulty. It has been stated as one hundred grammes for each kilo of body weight—an amount which is evidently too large; probably one-fourth the amount would be nearer the truth. As the gastric juice of the carnivora is obtained with the greatest readiness, it is the secretion which has been most studied. It contains a larger percentage of acid and pepsin than that of omnivorous and herbivorous animals, and in equal time will digest four times as much cooked albumen as the gastric juice of the sheep. It has been stated that a dog is able to digest one-fifth of his own weight at one meal. Nevertheless, the gastric juice does not convert all the food taken into the stomach into peptones; a large part is merely disintegrated and passes into the small intestine to be acted upon by the pancreatic juice. When excessive amounts of meat are taken, as is occasionally the case in young dogs, it will escape entirely unaltered through the intestines. Considerable time is required for gastric digestion in carnivora. Thus, albumen given to dogs has been found still coagulable by heat after a sojourn of three hours in the stomach, indicating that in a certain portion digestion had not commenced. Again, coagulated albumen has been found unaltered after a period of four hours; fibrin has been found swollen and transparent, but not dissolved; while gluten, after having remained four hours in the stomach, has been found almost unaltered.

Spallanzani states that masses of meat inclosed in tubes were found partially undigested after eleven hours, while Colin claims that at least twelve hours are required for a carnivore to digest the amount of meat which it would take spontaneously at a single meal. Thus, Colin gave to a cat which had fasted for twenty-four hours two hundred grammes of horse-meat, and found that five hours afterward the stomach contained one hundred and fifty grammes of unaltered meat; but forty-five grammes, therefore, or only about one-fourth, having been disintegrated. To another cat two hundred grammes of horse-meat were given after fasting twenty hours, and after twelve hours sixty-four grammes could still be recognized. Similar data were also obtained in the case of the dog. It is not astonishing that the food remains so long in the stomach. Time is given

for the digestion of ligaments, tendons, and often cartilages and bones, and such substances will often remain in the stomach for days at a time. The digestibility of certain kinds of animal food appears to be altered according as the substances are cooked or raw; gelatinous tissues, such as tendons, are more readily digested when cooked, evidently due to the conversion of the collagenous bodies into gelatin. Albuminous tissues, on the other hand, especially the glandular structures, such as liver, kidney, etc., lose in digestibility when cooked, unless the cooking is very prolonged, when a stage of peptonization may be inaugurated. Muscular tissue seems to be equally digestible when raw as when cooked. Feeding on raw meat is the natural normal diet of the pure carnivora, and even carnivorous animals in a state of domestication appear to digest raw meat more regularly and with less diarrhœa than when fed on cooked meat, which is often followed by a fetid diarrhœa; thus, a little raw meat given to dogs will keep their skin supple, the hair soft, and their general condition will be improved.

From what has been said, it is, then, clear that ordinary house refuse is all that dogs require for food. When a number of dogs are kept, this will not, as a rule, be sufficient; so, then, it is necessary to give some further idea as to the best and most economical plans of feeding a kennel of dogs. For ordinary feeding in town, as recommended by Dinks and Mayhew, beef-heads, sheep-heads, feet, and offal should be cleaned, chopped up, boiled in water, filling up the kettle as the water boils away, until all the meat separates in shreds. To this may be added a little salt and any cheap vegetable, such as cabbage, parsnips, potatoes, or turnips. Put this soup aside, and then boil *old* Indian meal till it is quite stiff; let it also get cold. When required, take as much meal as may be required, and enough broth to liquefy it.

In the country, during the summer, skimmed milk, sour milk, buttermilk, or whey may be used in place of the broth. In the winter the soup should be alternated with meal—never use new Indian meal, it scours. Although Indian meal has not as much sugar or albumen as oats, it does tolerably well; but when a great amount of work is expected of the dogs, as in a month's shooting excursion, oatmeal should always be used, as a less bulk is more nourishing than Indian meal, and old meal cannot always be obtained, or meat to make soup. Oatmeal-porridge and milk are capital under such circumstances.

In a house there are always bones, potato-peelings, and pot-liquor: by cleaning all the potatoes, and throwing all into the dog-pot, the dogs are greatly benefited. Rutabagas are good boiled in soup. Boiled meat alone seems to destroy the scent of dogs; so, also, greasy substances.

Alimentary substances introduced into the stomach are changed in the way already indicated. All albuminous bodies are converted into peptone. Starch may be slightly converted into sugar through the action of the salivary ferment, or, after passing into the intestine, through the action of the pancreatic ferment. Herbaceous matters are not digested by dogs, even though often taken in great quantities, and they are either again vomited, pass in the fæces, or may cause intestinal obstruction. When raw vegetable substances are swallowed by carnivorous animals it is only the salts of vegetable acids which are extracted, while the skeletons, containing starch and albuminous matters, remain behind. It is

probably the need of the extraction of these vegetable acids which leads dogs so often in the spring to eat grass.

As the substances contained in the stomach are liquefied, they pass gradually by the contraction of the walls of the stomach and relaxation of the pylorus into the small intestine. Indigestible substances may remain in the stomach, either to be vomited or finally to pass into the intestine.

5. GASTRIC DIGESTION IN OMNIVORA.—In the omnivora gastric digestion offers similar characteristics to those noted in the case of the carnivora, though it is slower and less complete. Thus, Colin states that after giving one thousand grammes of raw meat to a hog six hundred grammes were found in the stomach six hours after feeding, while undigested pieces were found in the small intestine. In another case a hog which had received three kilos of meat with one litre of water had only digested three hundred grammes in six hours. We thus see that while the hog is an omnivorous animal, it is not less capable of digesting animal matters than are the pure carnivorous animals. While this is, however, the case, from their imperfect mastication they are less constituted for the extracting of nutritive principle from the vegetable matter than the purely herbivorous animals.

The stomach of the hog is generally described as a simple stomach, but it really represents a stage of transition between the simple stomach of carnivora and the complex stomachs of ruminants. Even on external examination, by the presence of a constriction at the cardiac and pyloric extremity the presence of well-marked diverticula is evident. On inspecting the interior, Ellenberger and Hofmeister, who have been mainly followed in this description, show that the organ may be divided into five distinct regions: 1. The *œsophageal portion*, which is coated with a mucous membrane, cutaneous in character, similar to that lining the œsophagus, and which is separated by a distinct border from the secreting membrane. It contains no glands, but is papillated, though to a less degree than the left half of the horse's stomach. 2. The *cardiac diverticulum*, lined with a white, thin mucous membrane, which is separated by a fold of mucous membrane from the fundus of the stomach. The mucous membrane of this portion of the hog's stomach is coated with cylindrical epithelium and contains tubular glands, which are shorter than the fundus glands, and composed of small, transparent, granular cells, different from those found in any other region. Lymph-follicles are numerous, and in some places so close together as to resemble Peyer's patches. 3. The *left zone*, or *fundus*, constituting one-third or one-half the stomach, lined with a glandular membrane, similar to that of the cardiac diverticulum; it contains, however, a smaller relative number of follicles. 4. The *central zone* includes the greater curvature,

and extends toward the pylorus and œsophageal portion, its extremities being triangular. The mucous membrane in this region is very thick and brownish-red in color, and contains the so-called fundus glands. These are tubular in structure, longer, but subdivided to a less degree than the pyloric glands. The ducts of these tubules are lined with epithelium similar to that lining the cavity of the stomach, while the fundus contains chief and associate cells similar to those found in the stomachs of carnivora, with the exception that the associate cells lie in groups external to the cylindrical cells. 5. The *right* or *pyloric* zone includes the pylorus, as much of the lesser curvature as does not belong to the œsophageal portion, and a small portion of the greater curvature. Its mucous membrane is white in color, and in the pylorus very thin, though much thicker at the entrance to the pylorus; the submucosa is sparsely developed. After death the pyloric zone is generally found coated with a thick layer of mucus, stained yellowish from the bile. The glands of this portion are considerably longer than those found elsewhere, are subdivided and convoluted. Associate cells are entirely wanting in the pyloric zone, the cells being cylindrical and granular or hyaline.

As Ellenberger and Hofmeister pointed out, the stomachs of mammals may be divided into two different groups, in one of which œsophageal diverticula, and in the other diverticula of the stomach itself, represent the mode of deviation from the simple gastric form. When both forms of diverticula are present, the true compound stomach is represented. The gastric formation, with a diverticulum formed from the glandular stomach itself, is met with in many herbivora and omnivora, and such carnivora as live on highly indigestible animal substances.

In its simplest form the part near the pylorus is dilated into a pouch-like expansion; such a form is met with in the hog, but is still further complicated by a saccular expansion at the cardiac extremity. Such a formation evidently lengthens the period of retention of the food within the stomach, and by an increase in the internal surface of the stomach permits of a more continuous action of the gastric juice, since it corresponds to an increase in the secreting surface.

In the development of the compound stomach through the formation of œsophageal dilatations, the stomach of the hog represents the first stage.

The second stage is found in the stomach of the horse, where the entire left half of the stomach may be regarded as an œsophageal expansion; and while the stomach of the horse from external view resembles a simple stomach, internal examination shows that it is practically a compound stomach.

The highest degree of development of the œsophageal pouches is, of course, seen in the stomachs of ruminants.



The gastric juice of the hog contains the same ferments as are found in the secretion of other mammals; it dissolves albuminates and converts them into peptone, parapeptone, and syntonin, and coagulates milk, and, to a slight degree, as in the case of other mammals, splits up fats into glycerin and fatty acids.

The secretion obtained from different portions of the stomach differs; that obtained from the greater curvature contains more mucin, more acid, and more ferment than that from the other portions, while the secretion from the œsophageal portion is free from ferment.

In the secretion from the greater curvature, as obtained by the making of extracts with common salt, the degree of acidity varies from 0.03 to 0.07 per cent.

The portion of the stomach supplied with the associate cells contains all the ferments in the greatest quantity. Small amounts are found in the pyloric region, and a still smaller amount in the cardiac diverticulum.

These ferments in the hog are with difficulty extracted with glycerin, but are readily removed by means of dilute hydrochloric acid and salt solutions.

Ellenberger and Hofmeister further claim that there is a diastatic ferment in the mucous membrane of the hog's stomach, and they have proved by carefully controlled experiments that the conversion of starch into sugar by means of artificial gastric juice from the hog is actually due to the presence of the ferment. It does not, however, seem clear as to whether this ferment is actually produced in the gastric mucous membrane, or whether it enters that membrane by imbibition from saliva which has been swallowed. The gastric juice of the fundus of the stomach of the greater curvature produces coagulation of milk, both in alkaline and in neutral conditions; this power is not possessed by the mucous membrane of the cardiac sac, and only to a slight degree by the pyloric portion. No lactic acid ferment exists in the hog's gastric juice.

The progress of gastric digestion in the hog has been carefully studied by Ellenberger and Hofmeister, by administering definite amounts of specific foods to hogs in whom the stomach had been emptied by fasting and cleansed by copious administration of water. The animals were then killed, at specific intervals after the administration of the food, and the gastric and intestinal contents subjected to a chemical examination. These authors' experiments were restricted to the cereals. The largest number of experiments were made with oats, given dry, so as to produce the greatest quantity of saliva. In other instances the food was given moist, so as to reduce the secretion of saliva to a minimum. To those who received the dry food water was always given to drink. The animals on whom these experiments were made were for a

few days previous to the experiment fed on such food as could be readily recognized in the intestinal tube. For thirty-six hours before the experiment no food whatever was given. The animals were then killed, after the administration of a weighed quantity of food, at one, two, three, four, six, eight, ten, and twelve hours after the termination of the meal, an attempt being made to isolate the portions obtained from the different parts of the stomach, the cardiac and pyloric halves being kept separate. The result of these experiments directed attention especially to the progress of digestion, to the location of the gastric contents, the nature of the acid and quantity of the ferment present, the duration of gastric digestion, the source of gastric juice, and the character of the gastric movements. Their experiments teach that the gastric digestion of grains in the hog may be divided into two periods. During the meal and for one or two hours afterward, digestion of starch alone takes place, the starch being converted into soluble starch, dextrin, and sugar. Simultaneously with the digestion of the starch, lactic acid fermentation occurs, a considerable quantity of the sugar being in this way converted into lactic acid. It does not appear from their results as to whether cellulose, also, at the same time undergoes fermentation or not. During this period the food becomes softened and swollen from maceration in the fluids, and a great part of the soluble matters of the food pass into solution, the digestibility of the vegetable albuminates being facilitated by the presence of lactic acid.

The conversion of the starch into sugar occurring in this period is due to the saliva, which the authors have found in the hog to possess amylolytic power in a high degree. It is strongly alkaline, and therefore neutralizes whatever acid was first present in the stomach. Later, the cardiac contents become acid, due at first to the presence of lactic acid, which, as is well known, does not interfere with the action of the amylolytic ferment. It is also probable that a certain amount of this amylolytic ferment comes from the cardiac sac of the hog's stomach, which, as already mentioned, contains a special character of glands whose extract always yields diastatic ferments.

As regards the degree of digestion in this period, the following figures, taken from one of Ellenberger's and Hofmeister's experiments, serve as an example:—

The animal had received 860 grammes of oats, representing 73 grammes of cellulose, 557 grammes of carbohydrates, and 93 grammes of albuminoids. As a consequence, 22.5 per cent. soluble nutritive substances consisted of albumen. On analysis, only 47 grammes of undissolved albumen were found; hence 34 per cent. of the insoluble albuminous bodies had passed into solution.

In feeding with animal matters, naturally this first stage, which

might be called the amyolytic period of digestion, is absent. This amyolytic period lasts for about three or four hours, including, of course, the half-hour or hour occupied by the meal. The duration is, however, longer in the cardiac sac than in the fundus and pyloric portions of the stomach, where it becomes gradually converted into what might be termed the proteolytic period, in which the proteids become converted into peptones.

The digestion of proteids in the hog is first rendered possible through the presence of lactic acid. During this stage of proteolysis the digestive processes differ in the cardiac and pyloric portions of the stomach, indicating that for several hours a well-marked difference exists between the contents of these different regions of the stomach, in the former of which only lactic acid and in the latter both hydrochloric and lactic acids are present. This fact, for which we are also indebted to Ellenberger and Hofmeister, is in opposition to the generally accepted views as to the rapid diffusion and mixing of the gastric contents.

The second digestive period, in which, while the cardiac extremity is still digesting starch, the pyloric half is digesting albumen, begins at about the third or fourth hour of digestion, and may continue from nine to twelve hours.

In the third period the digestion of starch ceases, from the great development of hydrochloric acid, although it should be remembered that up to the fourth hour of gastric digestion the cardiac fluid is still capable of converting starch into sugar.

It thus would appear that digestion in the stomach of the hog continues from one meal to the other, although in a moderate meal part of the gastric contents may pass into the intestine three or four hours after eating; but part, nevertheless, remains in the stomach, and may be found there even thirty-six hours afterward.

These results further show that the degree of mixing of the contents of the stomach produced by the gastric movements is by no means complete, the first quantities being gradually pushed on toward the pylorus by those coming afterward. The degree of acidity of the gastric contents gradually increases. While at first alkaline, it gradually increases in acidity so that three hours after the meal 0.07 per cent. acid may be recognized in the left half of the stomach and 0.2 per cent. in the right half. The acid within the left half of the stomach then commences to increase, until finally it may amount to 0.3 per cent. When the meals rapidly follow each other gastric digestion is interrupted, and the undigested portion is forced into the intestine, undergoing digestion there by means of the intestinal digestive fluids. As a consequence, in large meals the amyolytic period is increased and the proteolytic period decreased, while the degree of acidity more slowly approaches a

maximum. The degree of mastication is further of influence on the completeness of the amylolytic change. When dried food is given mastication is more prolonged, and the conversion into starch is more complete than when soft, watery foods are given.

6. GASTRIC DIGESTION IN SOLIPEDES.—The simplicity and smallness of the stomach in these animals, the vast size and valvular character of the colon, and the importance and high degree of development of the cæcum are the peculiarities which characterize digestion in this group of herbivorous animals. The type of digestive parts seen in the horse and other solipedes are represented also in the pachyderms and among rodents, where the intestinal tube is constructed on a similar plan. They, therefore, possess many points in common in the mode of action of the digestive parts. As indicated by Colin, the following points characterize digestion in solipedes. First, the slowness of the mechanical preparatory stage of digestion; second, the rapidity with which the work of the stomach is effected; third, the rapidity of the passage of liquids into the intestines, and their accumulation in the cæcum; fourth, the hardness and globular form which the residue of alimentary matters assume in the posterior parts of the large intestine.

Mastication, which was found in the carnivora to be insignificant, becomes in the herbivora an act of the greatest importance, for grass, hay, corn, or oats can only be digested after the most perfect comminution and trituration, for the vegetable nutritious matters are enclosed in cellulose envelopes which are impervious to gastric juice. In the solipedes rumination does not take place; hence, mastication is slow and perfect and completed once for all. A horse cannot ordinarily eat two thousand five hundred grammes of hay in less than one hour, or even two if the teeth are at all defective, while twenty to forty minutes are required for the mastication of the same quantity of oats. Preliminary chopping of food does not help digestion in sound animals, and cannot replace the process of mastication in animals in which the teeth are defective, for it is impossible to carry the process far enough unless the substances are actually milled or ground to a powder. This, of course, will liberate the nutritive matters from their indigestible cells, and may assist digestion in animals in which mastication is imperfectly performed. Chopped food, in fact, may prove harmful by reducing the duration of mastication, and so decreasing the amount of saliva poured out. Mastication in solipedes is slow and prolonged, not only from the necessity for comminuting the food, but also from the fact that in the mouth the principal action of the saliva on the food commences.

As the foods enter the stomach they push to the right the mass already present, and as the capacity is only fifteen to eighteen litres, this organ cannot contain an entire single meal. Thus, when a horse eats

five kilos of hay, representing one-half its daily ration, requiring two hours for its consumption, and impregnates it with twenty litres of saliva, the mass would occupy a space of twenty-eight to thirty cubic decimeters. As the stomach is functionally most active when only two-thirds distended, that is, while containing about ten litres, the stomach must, therefore, fill and empty itself two or three times during one meal. It is, therefore, seen that the small capacity of the stomach has the effect of reducing the duration of gastric digestion, and the greater the volume of food the less will be the time that food will remain in the stomach. Consequently, oats, taking up only one-fifth the volume of an equal weight of hay, would remain in the stomach four or five times as long. This difference in time during which different foods remain in the stomach is necessitated, as indicated by Colin, by the different compositions of the food. Thus, a horse fed on hay receives in this food 44 per cent. of carbohydrates, which have been already partially modified by the saliva and whose further transformation is completed in the intestine. Four per cent. of fats is present, which, as has been seen, are not acted on by the gastric juice, while only 7 per cent. of albuminous matter is present. It is the albuminous matter alone which is digested by gastric juice, and, since we have only 7 per cent. of albuminous matter present in hay, it is evident that but a short time, comparatively speaking, would be required for the digestion of this albuminous matter, which is finely divided and in the most favorable condition for being subjected to its solvent action. So, also, the horse fed on green forage receives in its food 9 per cent. of carbohydrates, barely 1 per cent. of fat, and only 3 per cent. of nitrogenous matters which are digestible in the stomach. Therefore, in green fodder but a short time is required for gastric digestion. On the other hand, oats contain about 11 per cent. of nitrogenous matter, and, consequently, we find that the small relative volume of oats, as contrasted with other forms of vegetable foods, enables them to remain longer in the stomach.

In the horse the performance of gastric fistulæ is impossible on anatomical grounds, and various attempts have been made to collect gastric juice by performing œsophagotomy,—passing a sponge through a tube into the stomach, killing the animal after a certain time, tying the pylorus, and collecting the contents. This method, however, fails to secure a gastric secretion which is free from bile and pancreatic juice. So, also, the use of the stomach-pump is rendered difficult or impossible on account of the long and pendulous soft palate and the discomforts and struggles which it causes in animals when attempts to employ it are made.

By means of the method referred to above, the fluids obtained from the stomach will always contain saliva and various food-products, as well

as the true gastric secretion; but, since these substances are always mixed in actual digestion, they will answer for the study of the process of digestion, even although they will prevent accurate statements as to the chemical constitution of this secretion. The gastric juice in the horse is secreted only by the glands of the fundus from a surface about two hand-breadths in extent. Extracts from this portion of the mucous membrane contain more acid, more ferments, and, what is remarkable, more mucin than extracts made from the pyloric portion. Ellenberger and Hofmeister found that the degree of acidity immediately after eating was, in the horse, only 0.084 per cent. After an hour the acidity rose to 0.1 per cent., and still later to 0.2 per cent. Immediately after eating no hydrochloric acid was present, but only appeared four or five hours after the commencement of the meal. Lactic acid was always present, apparently even in excess of hydrochloric acid. This may, perhaps, serve to explain the fact that in the horse's stomach the change of starch into sugar may go on even in the presence of 0.2 per cent. of acid, as organic acids interfere less than mineral acids with this process. The characteristics of the acid of the gastric juice have been found to depend upon the food. Thus, these authors have found that the distribution of acids was as follows:—

	Hydrochloric Acid.	Organic Acids.
1. Oats and chopped straw, . . . . .	0.163 per cent.	0.287 per cent.
2. Oats, . . . . .	0.490 “	0.610 “
3. Hay, . . . . .	0.022 “	1.798 “

It is thus seen that when the food consists of oats the maximum percentage of hydrochloric acid is found in the gastric juice, while when hay is given the mineral acid falls to a minimum, while the organic acids are in excess. The importance of these facts is evident when it is remembered that oats contain 12 per cent. of albuminous matter and 65 per cent. of carbohydrates, including cellulose, while hay contains only 9 per cent. of proteids and 70 per cent. of carbohydrates. Hence, when oats are given, the excess of hydrochloric acid is especially favorable for the peptonization of the proteid constituents, while it interferes with the digestion of the carbohydrates. On the other hand, when hay is given, the excess of organic acids, as already mentioned, does not interfere with the action of ptyalin on starch, while still permitting the peptonization of the proteids.

The watery extract of the mucous membrane of the fundus differs, as already mentioned, from that of the pylorus. It contains more mucus, more acid, and more ferment. The fundus extract contains a ferment which converts casein, fibrin, albumen, and gelatin into peptone in media containing 0.15 to 0.5 per cent. of hydrochloric acid. While 0.6 per cent. of hydrochloric acid arrests digestion, in the case of organic acids

it was found that the percentage might be considerably increased above this point and yet digestion go on. Thus, the gastric extract appeared to possess about the same degree of activity when lactic acid was present in 2 per cent. as with hydrochloric acid present in 0.2 per cent. The ferment is only diffusible with great difficulty, and resists, to a high degree, putrefactive and alcoholic fermentations. Lactic acid fermentation does not interfere with its activity.

The ferment is soluble in water, glycerin, dilute acids, alkaline and saline solutions, and loses its activity at 60° C. Such an artificial gastric juice extracted from the mucous membrane of a horse's stomach will digest animal tissues in the same way as extracts prepared from the mucous membrane of the stomachs of carnivora. Extracts prepared from inflamed mucous membrane are totally inactive. In addition to the pepsin, the gastric juice of the horse also contains the milk-curdling ferment and salts, lactic acid ferment, and traces of a diastatic ferment, all of which may be precipitated by alcohol. The distribution of these ferments and of the acidity of the gastric juice is the same as in the dog, with the exception that no secretion takes place in the membranous cardiac portion of this organ.

Gastric digestion in solipedes is more important than one might be led to suppose, and continues, to a certain extent, from one meal to the next, as the residue remains in the stomach until the next one is taken, and therefore the stomach does not completely empty itself after twenty-four hours. The characters of this residue will, of course, vary with the nature of the food. Thus, the contents of the stomach after feeding with oats is a dried, crumbling mass, containing 60 to 70 per cent. of water. After feeding with hay the percentage of water may be as much as 80 per cent. The reaction is always acid.

Gastric juice obtained as above, by the method of Ellenberger and Hofmeister, rapidly converts starch into sugar, although the ferment is not derived from the stomach, but from the swallowed saliva.

The change of starch into sugar goes on in the stomach, as is proved by the fact that gastric juice outside of the body will turn starch into sugar, and by the fact that after feeding starch large quantities of sugar may be found in the contents of the stomach. The digestion of starch is most active in the first two hours of digestion and stops after five or six hours, when the percentage of hydrochloric acid is most marked.

When dry food has been given, the conversion of starch into sugar may continue much longer, from the large quantity of alkaline saliva swallowed, and may go on in the left half of the stomach even while the fundus is digesting proteids, the acidity being due to lactic acid. After feeding with oats, as much as thirty-five grammes of sugar have been found, while five to eight and one-half grammes of sugar have been found after

feeding with hay. Of course, this does not represent the total amount formed, as a great deal will have been absorbed, some converted into lactic acid, and some will have passed into the small intestine.

Ellenberger, Hofmeister, and Goldschmidt found that the naturally mixed saliva of the horse possessed a stronger amyolytic action than the artificially combined separate salivary secretions; and that each separate salivary secretion, though highly amyolytic, was less so than the mixed secretions; and, finally, that the conversion in the horse's stomach of starch into dextrin, sugar, and lactic acid occurred to a greater degree than could be attributable to the fermentative action of the saliva alone. The conclusion is, therefore, drawn that in the horse's stomach amyolytic digestion is aided by ferments developed in the alimentary canal and in the food itself. This latter statement is confirmed by the fact, already mentioned, that Hofmeister has found in oats an amyolytic ferment, which is destroyed at the temperature of boiling water, but which is active at the body temperature, thus explaining the fact that more starch is converted into sugar in the stomach than is attributable to the action of the salivary ferment alone. Finally, Goldschmidt has found that the digestion of starch in the horse is aided by amyolytic ferments derived from the air, which are mixed with the saliva in the mouth, and which rapidly develop in the oral mucus.

In the horse's stomach vegetable albumen is rapidly digested and turned into peptone, which increases in amount with the duration of digestion. After a large meal the peptonization is at first slight, since the glands cannot form acid and pepsin fast enough to digest a large meal rapidly. If, then, another meal is taken before the first is digested, the former food is forced in an undigested state into the intestine. After a moderate meal the digestion reaches its maximum in three to four hours; in other words, digestion is then complete. The larger quantity of peptone is found in the stomach after oats have been given than after feeding with hay. Five to forty grammes of peptones have been found after oats have been given, while only about six grammes were found six hours after feeding with hay. Of course, these figures do not indicate the total amount of peptones formed, since, probably, a large portion would be absorbed almost as rapidly as formed. As hay absorbs four times its weight of saliva, it is readily digested at first without water, but the digestion then becomes slow. Colin administered twenty-five hundred grammes of hay to a horse, and then killed him. Only seven thousand grammes of material were found in the stomach, representing, therefore, but little more than one-half the amount given, since the two thousand five hundred grammes of hay would have absorbed ten kilos of saliva. Of this residue only one thousand grammes were dry



hay; the remainder had passed into the intestine. Other animals killed at longer periods after meals showed the passage of the food from the stomach into the intestine was not as rapid toward the end of the repast as at the commencement. There appears, therefore, to be two periods in the digestion of hay in the horse: In the first, the materials, as soon, almost, as they enter the stomach, are rapidly pushed into the intestine by the food that comes later; in the second period, toward the end of the meal, the sojourn is more prolonged, and chymification is, therefore, more perfect. The gastric digestion of hay appears to be abbreviated by the ingestion of water, as the water carries into the intestine a good deal of food. Digestion of hay does not appear to be modified by previous chopping.

When oats are given as food, at the commencement of the meal, a part always passes into the intestine, but, as oats only absorb a little more than their own weight of saliva, the volume never becomes as high as when hay is eaten. Colin reports, also, the following experiments: A horse which had received two thousand five hundred grammes of oats was killed two hours after the commencement of the meal. The stomach, which, together with the oats and saliva, had received five thousand grammes of material, was now found to contain six thousand and seventy grammes, the addition being derived from the gastric juice and the saliva which had been swallowed during the meal. Here, also, two analogous periods may be made out, but less accented than when hay is the food. It, therefore, seems evident that small meals, frequently repeated, would serve to render the gastric digestion in solipedes more perfect. Thus, in Paris, according to the statement of Colin, the horses in the omnibus service make six meals from 4 A.M. to 9 P.M., and each of these meals has three hours for digestion, with the exception of the last, which has six. Water is only given when hay is included, and not at other times. It follows that gastric digestion is not of equal importance for all kinds of food, and it is, therefore, possible so to distribute the constituents of a meal as to allow of a longer gastric digestion of oats, which have a greater percentage of albuminous bodies and carbohydrates than hay. Therefore, in the feeding of a horse especial attention should be given to the sequence or to the order in which the different constituents of the horse's meal follow each other,—a fact which is of greater importance for the horse than for man, the carnivora, and the ruminants, in which all the constituents of a meal may be kept in the stomach until the digestion is completed. Experience has shown that if oats are given first, subsequent eating of hay forces the oats into the intestines before the digestion of the latter is complete; consequently, if given after hay, the sojourn in the stomach is much more prolonged, while the hay, containing a minimum of albuminous matter, may be

partially digested in the stomach, and its subsequent changes completed in the intestines. Consequently, oats should always succeed the administration of hay in the feeding of horses. So, also, water should not be given after a meal of oats to the horse, or else it will wash the oats out of the stomach before digestion is completed. Consequently, the water should precede hay, and both hay and water should precede the administration of oats.

The short time that food remains in the stomach is probably the reason that the horse does not readily digest animal food, although in the Tartar steppes it is stated that horses become accustomed to a meat diet.

In addition to true digestion, fermentative processes also occur in the stomach, especially in the earlier stages of gastric digestion, when the hydrochloric acid is absent or present only in small amounts. It has been shown that hydrochloric acid is always in small amount in the œsophageal sac, and in this locality lactic acid fermentation, as well as fermentation of cellulose, undoubtedly may occur, though the time which the food remains in this part of the stomach is too short to permit of any extensive change of this character. It will be subsequently shown that the conditions for the fermentation of cellulose are much more favorable in the intestinal canal of the horse than in the stomach.

7. GASTRIC DIGESTION IN RUMINANTS.—Gastric digestion, which has been found to be much the same in carnivora and solipedes, takes on a new form in the ruminant animals, and although the general result of gastric digestion is the same in all, special means are concerned in the accomplishment of this result in the ruminant that are not seen in animals with a simple stomach. This complication is practically due to the preliminary and accessory changes which occur in the food before it is subjected to the action of gastric juice. Hence, the changes in the first three compartments of the stomach are without an analogue in the gastric digestion of monogastric animals, while the fourth stomach reproduces exactly the process that takes place in this viscus of the latter class of animals.

Although the four gastric reservoirs of the ruminant are anatomically connected, they are, to a certain point, functionally isolated, each one of them having tolerably distinct functions to fulfill. The first three are concerned in the storing of foods and liquids in rumination, while in the fourth alone true digestion takes place. This may occur during rumination or during inaction of the first three stomachs.

The rumen receives almost all of the aliments when swallowed for the first time, the greater part of liquids drunk, and a considerable portion of the results of the second mastication (Fig. 153). It keeps them stored up for a certain time in its interior, where they become thor-

oughly macerated and soaked in fluid, and from which they are forced into the œsophagus during rumination or into the honey-comb bag during the intervals of rumination. It is evident, therefore, that the food contained in this pouch may undergo changes due to the movements to which it is subjected, the temperature, and the action of saliva and other fluids. The changes are, therefore, physical and chemical. The walls of the rumen, by their contractions and resulting movements, may exert a considerable amount of mechanical force on the aliments contained within it, although this has been greatly exaggerated. Nothing like trituration takes place, but simply thorough mixing of the new and old food together

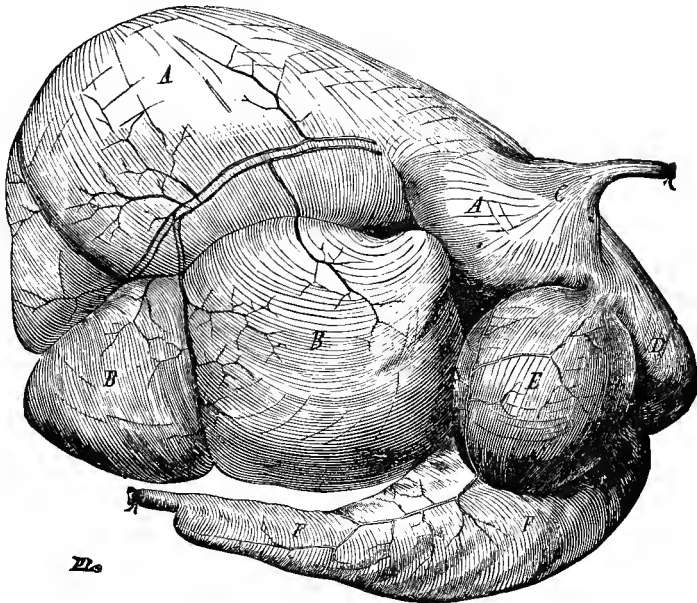

FIG. 153.—STOMACH OF THE OX. (*Colin.*)

A, rumen (left hemisphere); B, rumen (right hemisphere); C, insertion of the œsophagus; D, reticulum; E, omasum; F, abomasum.

and with fluid; consequently, it is not necessarily the portion of food which first enters the paunch which is the first to leave. The maceration which the food undergoes in the fluids of the paunch is especially marked in the case of grain and dry fodder, and is greatly assisted by the temperature of the organ.

The fluids contained in the rumen consist, in a great part, of water which has been drunk and a large quantity of saliva, which is swallowed with the first mastication and in the intervals of the act of rumination. The rumen has, however, no secretion of its own, since no secretory glands are found in its walls. Its reaction, as already stated, is generally

alkaline, and is derived from the saliva. Occasionally, the reaction of the rumen may be found to be acid. This may be due to fermentation occurring in the contents of this organ, and is especially seen in nursing calves, in animals fed on roots, and in cases of faulty digestion. It nearly always occurs in animals fed on green fodder, where the conditions are favorable to the fermentation of sugar. Occasionally, also, the reaction of the rumen, which may be found to be acid after death, is due to the regurgitation of the contents of the fourth stomach into the first three compartments. In the rumen the conditions are especially favorable for the digestion of carbohydrates, for the conditions are favorable for the action of saliva, which is thus enabled to convert starch into sugar. Cellulose, also, is said to be digested in the rumen through fermentative processes to as much as 60 to 70 per cent. Salts, sugar, mucilage, gum, and other soluble substances may be dissolved out of the food while in the rumen, and so prepared for absorption. No peptonization, however, occurs; for all the various bases, salts, and albuminoids which may be detected in the contents of this organ come solely from the food and the secretions and liquids which have been swallowed, and not from any secretion poured out by the rumen itself. The function of the rumen is, therefore, simply to act as a reservoir, in which the food, after being swallowed, is collected, undergoes maceration, and is again, from time to time, returned to the mouth for a second mastication. In this organ the food becomes softened, as the result of impregnation with liquids warmed to the temperature of the body.

The functional importance of the rumen is not equally marked at all periods of life. This is especially seen in suckling animals, such as calves, in whom the rumen is capable of containing one thousand one hundred and seventy-five grammes, the reticulum one hundred, the manyplies one hundred and sixty, while the cubic capacity of the abomasum may amount to three thousand five hundred grammes (Colin). Hence, digestion in the suckling ruminant is accomplished almost solely by the fourth stomach, and the rumen does not acquire its great proportionate size seen in the adult ruminant until the animal commences to live on a solid vegetable diet.

Although the reticulum may be regarded as an appendage to the rumen, with which it communicates by a large opening, it also has a special function to fulfill, which appears to be uniform in all ruminants. It constantly contains fluid, since its base is on a much lower level than the openings into the first and third stomachs. Fluid can, therefore, only leave this compartment as a result of its own vigorous contractions, such as precede the insertion of the cud into the œsophagus for rumination.

The function of the œsophageal canal is to assist in the transfer of

the contents of the reticulum into the manyplies. The entrance of the contents of the rumen through the contraction of its walls into the reticulum leads to a contraction of the muscular walls of this compartment, and the materials contained in it are thrown up against the edges of the œsophageal gutter. Through this contact the œsophageal pillars shorten so as to draw up the opening into the manyplies nearer to the reticulum, at the same time turning spirally on their own axes, the left-hand pillar being extended downward and to the right. The contents of the reticulum thus find a means of ready entrance into the manyplies, large particles being strained off by the papillæ at the orifice of the manyplies, and falling back into the reticulum.

Although the reticulum receives all the matter swallowed, its small size prevents it from retaining more than a small portion, the remainder being forced into the rumen and manyplies, the fluid and finely divided solids alone entering into the latter on account of the small size of the communicating orifice. Its function, therefore, is to assist in rumination, particularly by supplying the fluids which ascend the œsophagus, and by its contraction aiding in the ascent of the cud and in keeping up the circulation between the contents of the first and second stomachs. It also has no secretion proper, and the fluids found in it have the same source and same functions as those found in the rumen.

If one could judge of the importance of an organ by its complexity, the functions of the psalter would play an especially important rôle in the gastric digestion of the ruminant. In this compartment of the stomach the openings are always narrow, are always close together, and are both on the uppermost portion of this organ, while the free borders of its folds are directed downward; consequently, the manyplies, by means of its folds and the narrowness of its openings, the one into the fourth stomach being closed by a powerful muscle and numerous large papillæ, like a sieve, strains off solids and delays the passage of aliments into the true stomach. The muscular fibres which run in the larger folds are inserted into the borders of the orifice between the manyplies and reticulum. When, therefore, the sphincter-muscle of this opening contracts, after the entrance of the contents of the reticulum, the folds are simultaneously drawn up, and the food is thus forced up to the base of these partitions. At the same time, through the contraction of its walls, the posterior extremity is drawn forward so that the prolongation of the œsophageal canal becomes almost perpendicular to the opening of the third into the fourth stomach. By this process not only the fluid in the œsophageal canal, but a portion of the food previously in the manyplies may enter the rennet. The contraction of these folds does not take place only during rumination, but also during its intervals; the water in the contents of this compartment is then pressed out, and the residue

found in this stomach after death is always dry. The mucous membrane is, however, entirely incapable of absorption, and the dryness of its contents cannot, therefore, be explained as due to the entrance of the fluid from its contents into the blood. The psalter likewise furnishes no secretion of its own, and the changes which occur in its contents are due simply to the influence of the saliva and the fermentative process which occurs in the two preceding stomachs. Its reaction is, however, often acid, evidently due to the regurgitation of the fluids from the fourth stomach. It is worthy of note that in the llama, the camel, and, to a less extent, in the sheep the folds of the membrane in the third stomach are but slightly developed, and there is no constriction between the third and fourth stomachs, while the opening into the reticulum is particularly narrow. This may possibly serve to prevent too great dryness of the contents of this compartment in these animals, which are so frequently deprived of water. Where obstruction of the stomach occurs, it is nearly always to be found in this compartment.

The action of the first three stomachs is merely preparatory to digestion. It is only in the fourth stomach that true digestion takes place. Its secreting membrane is four or five times as extensive as that of the right half of the stomach of the horse, and is relatively less in the llama and dromedary than in other ruminants. The gastric secreting membrane is, apparently, in all respects similar to what has already been described in other animals, although the amount of pepsin and acid in the gastric juice of ruminants is less than that found in this secretion of carnivora. Pauli states that extracts made from the glandular portion of the fundus of the fourth stomach of the ox possess a much greater digestive power than similar extracts made from the pyloric portion; in other words, the amount of acid added being the same in both cases, that the glands of the pylorus are poor in pepsin, the glands of the fundus rich in pepsin; and that the small amount of pepsin in the pyloric portion is almost incapable of extraction with glycerin, but is removed by hydrochloric acid and by common salt solutions. Pauli would infer from these statements that, the histological structure of the ruminant's stomach being similar to that of other mammals, the so-called chief cells are not the peptic cells, but perhaps are concerned in the elaboration of other ferments, while the associate cells are the true peptic cells. We have already in another place discussed the grounds for attributing the acid of the gastric juice to the action of the associate cells.

Since the aliments enter the stomach but slowly and gradually, and some already in a fluid state, digestion in the stomach occurs under the most favorable circumstances, and is rapidly completed. The pylorus is narrow and guarded by a powerful sphincter, thus resembling that of carnivora in contradistinction of what has been noticed in the horse, and

serves to keep back the aliments that are not thoroughly digested. In other respects, gastric digestion in ruminants is similar to that seen in other animals. In other words, albuminoids are converted into peptones; gelatin is dissolved and converted into a diffusible gelatin peptone, and milk is coagulated and its casein is converted into peptones. Adipose tissue is dissolved and the oil liberated and partially split up into fatty acids; cane-sugar is slightly converted into inverted sugar through the action of the acid; starch which has escaped being converted into sugar through the action of saliva in the rumen passes into the intestine to be acted on by the intestinal secretions, for the degree of acidity of the gastric juice is sufficient to interfere with the diastatic action of ptyalin. Gastric digestion in ruminants is much more complicated than in other animals, and comprises a series of operations which are carried on partly simultaneously and partly alternately. The two first reservoirs are concerned in rumination and in the maceration of food. The third stomach has nothing to do with rumination, but acts as a strainer and prevents substances passing into the fourth stomach until sufficiently comminuted and softened to be subjected to the action of gastric juice, while, finally, the fourth stomach is the true digestive organ, in which the albuminous contents of the food are converted into peptone. It is thus seen that gastric digestion in the ruminant is much more complete than in other herbivora. Therefore, gastric digestion in these animals is predominant, while intestinal digestion is simplified.

8. GASTRIC DIGESTION IN BIRDS.—Gastric digestion in birds differs very essentially from that of mammals, the difference being dependent on the difference of plan on which the alimentary tract is constructed. The digestive parts are simplest in birds of prey, such as the owl, the buzzard, and hawk. The œsophagus is large and dilatable, and is, as a rule, not supplied with a crop. It is continuous, without any marked line of demarcation, with the small longitudinal stomach, which takes on a transverse curve where it ends in the small intestine. Where the œsophagus terminates it has a calibre almost as great as the stomach, so that the latter seems simply to be a prolongation of the œsophagus. The superior limit of the stomach is marked by a band of large glands, which may often be seen from the outside of this organ, and which almost seem to resemble the agminated glands of the small intestine of the mammal. Below this the stomach contracts, and again dilates to a more or less globular pouch, and again becomes contracted and united with the small intestine. The pyloric orifice in birds of prey is very narrow.

In gallinaceous birds, such as the cock, the turkey, and the pheasant, the gullet dilates at the lower portion of the neck (the crop) and then contracts, to again expand and form the ventriculus, which has thick,

glandular walls; then comes the gizzard, composed of two thick, red, striped muscles, covered internally with a thick, horny epithelium. The gastric parts of this class of birds are therefore divided into three sections—first, the crop, to act as a reservoir, in which the food is macerated; from this it is pushed gradually into the second, the stomach, in

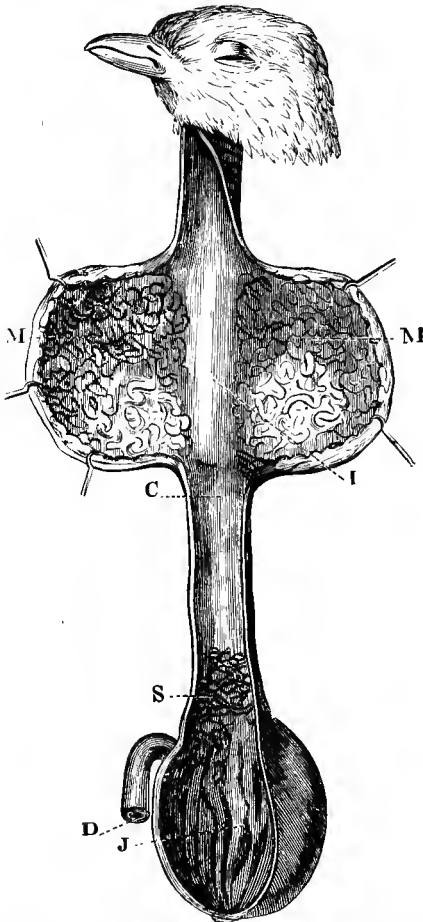

FIG. 154.—CROP AND STOMACH OF THE PIGEON.  
(Bernard.)

M M, crop; I, œsophagus; C, proventriculus; S, tubular glands of stomach; J, gizzard; D, duodenum.

which it undergoes gastric digestion simultaneously with the process of trituration which occurs in the gizzard, or the third digestive compartment (Fig. 154). Grains, etc., which form the food of gallinaceous birds, first go into the crop, which they distend, and in which they accumulate in considerable quantity. Here the food becomes softened and takes on an acid reaction. A comparatively profuse secretion is poured out in this pouch, whose properties have not been thoroughly investigated. By inserting substances into the crop, Spallanzani obtained one ounce of fluid in twelve hours from the crop of a pigeon, and seven ounces of the fluid from a guinea-hen; but although this fluid is thus poured out in considerable amount, it does not appear to be very active in softening the food. It is not known that this secretion has any digestive properties, although it seems probable that starch would

here be converted into sugar, since grain remains in this compartment for twelve or thirteen hours, or even much longer. After leaving the crop, the food then passes into the ventriculus and gizzard. The ventriculus is supplied with a large number of tubular glands, which secrete an acid fluid.



When, however, the food comes in contact with this secretion, it has not yet been crushed or comminuted; consequently it is incapable of being acted on by the gastric juice, which is powerless to digest cellulose membranes. The contact of the food with the walls of the ventriculus leads to the pouring out of a profuse acid secretion. Bathed with this fluid, the food then enters the gizzard, where it is reduced by crushing to a homogeneous pulp. The gizzard has thick, muscular walls, with a hard, horny epithelium lining it, and is capable of exerting very great force. Thus, it has been stated that iron tubes capable of supporting a weight of five hundred and thirty-five pounds were completely flattened out after passing through the gizzard of a turkey. This crushing is indispensable for the digestion of grains, and is aided by the presence of gravel, etc., almost always to be found in this organ.

In carnivorous birds gastric digestion is simpler than in the herbivora. Such birds swallow their prey entire, if small enough to enter the beak and œsophagus; if not, it is torn with the beak small enough to be swallowed, and then the skin, hair, feathers, and all are carried to the stomach with the flesh. As there is no crop in such birds, and the ventriculus is but faintly distinguished from the gizzard, which is comparatively small, and whose walls have become thin and almost membranous, we have, therefore, a simple process of gastric solution, since the gizzard has lost its crushing power. The solvent power of the stomach of carnivorous birds is very rapid and powerful, muscles, tendons, and cartilages being rapidly dissolved. After about eighteen or twenty-four hours, bones and matters which have escaped digestion, or which are insufficiently dissolved to pass into the intestine, are regurgitated through the mouth, since the very narrow pylorus present in carnivorous birds, as in carnivorous mammals, prevents the passage of everything except fluids.

There exists, again, a type of birds, midway between the purely omnivorous and the granivorous, where the gizzard has but moderate thickness and power. These birds also vomit indigestible substances.

Birds have, in general, a very active digestion. Some may make as many as twelve meals a day, in which they fill not only the stomach, but also the gullet, pharynx, and beak, especially when feeding on soft substances like larvæ or worms. Their appetite seems to return as soon as there is the least place which can hold more food. The diet of birds cannot be changed. The birds of prey, without gizzard or crop, cannot feed on grains, although the gallinaceous birds may be brought to accommodate themselves to an animal diet.

Colin states that morsels of meat fed to sparrows appear in the gizzard in less than an hour, and reach the intestine within an hour and a half; while *débris* of food may be found in the fæces in four or five hours.

## IX. DIGESTION IN THE SMALL INTESTINE.

As the aliments pass into the duodenum, after being subjected to the action of gastric digestion, they immediately mingle with the three other digestive secretions,—the bile, the pancreatic juice, and the intestinal secretion.

I. BILE.—The bile is the secretion of the liver, and, strictly speaking, occurs only in vertebrates. In the lowest invertebrate animals a fluid somewhat analogous to the bile is poured directly into the intestine, as the result of the secretion of cells attached to the intestinal mucous membrane. In others it is formed by a series of convoluted tubes surrounding the intestine, or, it may be, directly surrounding the stomach. But although this fluid may be yellowish or brown, it is not to be regarded as bile, since in invertebrates it never contains the specific bile constituents, bile coloring-matters and acids, and the glands which form it differ histologically from the liver. In all the invertebrates the so-called bile is directly poured into the intestine; in many vertebrates, however, the excretory duct is in communication by a side branch directed obliquely backward from the course of the duct with a reservoir for the bile, termed the gall-bladder. This reservoir is present in all omnivora and carnivora, and in most herbivora, birds, and reptiles. It is absent in certain of the group of herbivora. It is absent in the solipedes, the horse, mule, and ass, and among the ruminants in the stag, camel, and dromedary; among the pachydermata, in the elephant, the rhinoceros, and tapir; in the wild boar, and in certain cetaceans; while in birds it is absent in the pigeon, cuckoo, paraquet, and ostrich. It is also absent in the mouse and marmot. In the horse and elephant the gall-duct is dilated to form a sort of pouch. The ultimate gall-ducts all unite to form a single trunk, or ductus communis choledochus, which in many animals, such as sheep and goats, communicates with the excretory duct of the pancreas and pierces the wall of the duodenum obliquely from below upward. As the result of this, an increase of pressure on the intestinal contents simply closes the orifice of the duct, and regurgitation of intestinal contents into the duct is impossible.

In the gall-bladder the bile becomes concentrated, and mucin is added to it as a result of the action of the secretion of the mucous membrane of the gall-bladder. Little or no mucin is found in bile coming directly from the hepatic cells. The gall-bladder is necessary in animals whose digestion, as in the carnivora, is intermittent. It is less important for the herbivora, where digestion is nearly constant. The liver differs from all other organs in its blood-supply. In proportion to its size, it receives but a small supply of arterial blood, and although an immense amount of blood passes through it, the greater part reaches

the liver through the portal vein, indicating the functional relation of the liver to the process of intestinal digestion.

1. *The chemical characteristics* of the bile have been mostly studied in the fluids found in the gall-bladder of the ox and in that obtained from fistulæ in dogs. In the fresh state, bile is a clear, thin, or more or less tenacious liquid, which, with the exception of epithelial cells from the gall-bladder, contains no morphological elements. It has a neutral or alkaline reaction. When fresh, in man and carnivora, it is of a golden yellow or greenish-brown color; it is green in herbivora (brownish-green in the horse and ox, greenish-yellow in the hog, and dark green in sheep). After standing exposed to the air, the brownish-yellow bile becomes dark brown, and the greenish bile more intensified to a dark green. Bile has a peculiar bitter taste, and when warmed a musk-like odor. The specific gravity varies in different animals from 1008 to 1030, the highest being found in bile taken from the gall-bladder of man. Ox-bile is often yellowish-brown, though usually green in color, and may be either clear or turbid; it is alkaline, viscid, and contains a large amount of mucin; its specific gravity varies from 1022 to 1025. Sheep's bile is usually green, is odorless, clear, alkaline, and, although it contains mucin, is not viscid; specific gravity, 1025 to 1031. Calves' bile is green or yellowish-brown, though sometimes golden yellow in thin layers; it is clear, odorless, viscid, neutral in reaction, and contains but little mucin; specific gravity, 1020 to 1027. Pig's bile is clear or dark yellowish-brown or golden yellow (the latter when diluted), is odorless, alkaline, contains large amounts of mucin, and is therefore very viscid; specific gravity, 1020 to 1027. Dog's bile is usually yellowish-brown, and when diluted golden yellow; it may be either neutral or alkaline, contains mucin, and is clear and odorless; specific gravity, 1025. The bile of all animals may be kept for several days, even at a high temperature, before putrefaction sets in. In the fresh secretion from the liver, the solids in the bile of the cat, dog, and sheep amount to 5 per cent., in the rabbit 2 per cent., and in the sheep  $1\frac{1}{2}$  per cent. In the gall-bladder in cats, dogs, and rabbits the solids rise from 2 to 20 per cent., in the sheep to 8 per cent., in man from 9 to 17 per cent., and in the ox from 7 to 11 per cent.: the solids in the bile of man, the pig, and the ox consist of only 1.5 per cent. of inorganic matter, and in the dog only 3.6 per cent.

In 100 parts Bile.	Man.	Ox.	Pig.	Dog.	
				Fresh.	From Bladder.
Water,	86.3	90.4	88.8	95.3	85.2
Solids,	13.7	9.6	11.2	4.7	14.8
Bile salts, . . .	7.4	8.0	7.3	3.4	12.6
Lecithin, cholesterin,	3.0				
Fats, soaps,		2.2	0.3	0.6	0.2
Mucin and coloring matter,	1.1	1.3	1.1	0.6	0.6
Inorganic salts,					

While the bile is entirely free from proteids, it contains both organic and inorganic constituents. The former group are represented by mucin, a compound of sodium with two organic acids (glycocholic and taurocholic), a coloring matter which undergoes various modifications and whose origin is a source of considerable interest, lecithin, small quantities of fat and soap, and a small amount of diastatic ferment. These will be considered in turn.

(a) *Mucin*.—Mucin gives to bile its viscosity, and is the product of the mucous glands of the larger bile-ducts and gall-bladder. The longer the bile remains in the gall-bladder, the larger will be the percentage of mucin found in it, since the mucous cells in the walls of this reservoir are the principal sources of this body. In the bile of animals supplied with a gall-bladder, mucin will be found in larger amounts than in animals in whom this appendage to the liver, as in the case of the horse, is absent. The smaller bile-ducts are free from mucous cells, and, as a consequence, bile coming directly from the liver-cells contains no mucin. The longer the gall remains in the gall-bladder, the more will it deviate from its general character when freshly secreted by the liver-cells. Yellow bile gradually becomes greenish, and its consistence will become more marked from the addition of mucus. The general characteristics of mucin found in the bile do not differ from those of mucin found elsewhere. It may be precipitated by acetic acid, and when bile containing mucus is precipitated with alcohol it loses its viscosity.

(b) *The Bile Acids*.—The bile acids occur in the bile in the form of compounds with sodium, and occasionally with minute amounts of potassium, to form glycocholate and taurocholate of sodium,—two salts which are highly soluble in water. The relative proportions of these two salts vary considerably in the bile of many animals. In that of man, as well as of birds, many mammals and amphibia, taurocholic acid is most abundant. In other mammals, as in the pig and ox, sodium glycocholate is in largest amount, while the taurocholate is more scanty. In the bile of the dog, cat, bear, and other carnivora, taurocholate is almost the sole representative of these salts, while the glycocholate is almost entirely absent. In the bile of the pig, in addition to these two salts, the hyocholate of sodium is also present.

The gall of the hog contains, besides hyoglycocholic acid, another until lately unknown acid, which occurs in larger quantity than the first known acid (Jolin). It is, for the present, called B-hyoglycocholic acid. It is with difficulty obtained pure, as neither it nor its salts are crystallizable. It is distinguished from the A-acid by its behavior with saturated sodium sulphate solution, which precipitates the sodium salt of the A-acid almost completely, and in a flocculent form, whereas the sodium salt of the B-acid is only partly precipitated, and is at first colored, and easily soluble in water. The purified salt is separated from the alcoholic solution by means of ether, as a snowy-white, cheesy precipitate, which soon shrinks to a yellowish mass, whereby much ether is pressed out. This mass is easily soluble in water and alcohol, and the solutions allow them-

selves to be concentrated to a syrupy consistency. The aqueous solution gives a precipitate with barium chloride, which at first dissolves again, but with more barium solution a lumpy barium salt separates, which soon changes to a tough, shiny, silky mass. The salts of this acid have a very bitter taste, which is not, however, as intense as that of the A-acid salts. The composition of the acid could not, as yet, be determined. Analysis proved that the percentage of carbon is much less in the B-acid than in the A-acid, whereas the percentage of nitrogen is about equal in both. By continued treatment with alcohol, the B-acid yields cholalic acid. In how far this acid corresponds to the one obtained in a similar manner from the A-acid has not yet been determined.

Various methods have been proposed for the separation of these salts from the bile, of which only the following will be given. The bile from the gall-bladder of an ox should be evaporated to one-fourth its volume over a water bath, rubbed up to a thick paste with animal charcoal, and completely dried at 100° C. The hot mass should then be thrown into absolute alcohol, well shaken repeatedly, allowed to stand for two or three hours, and then filtered. A part of the alcohol may be removed from the filtrate by distillation, and the bile salts may then be precipitated, in the form of a resinous syrup, by the addition of a large excess of ether. After standing a variable time, from one or two days to a week or more, the time depending upon the anhydrous character of the alcohol and ether, the so-called Platner's crystallized bile separates in a mass of glistening needles. This crystallized bile consists of a mixture of taurocholate and glycocholate of sodium.

These salts are insoluble in ether and readily soluble in alcohol and water. Their aqueous solutions have a decided alkaline reaction, and rotate the plane of polarized light to the right. Both these salts are highly deliquescent, and when exposed to the atmosphere the crystals absorb the mixture and break down into a thick, tenacious syrup.

To separate the two individual bile acids from each other, this mixture of crystallized bile may be dissolved in a small volume of water, a little ether added, and then dilute sulphuric acid. After stirring well, glycocholic acid crystallizes in shining needles, the taurocholic acid remaining in solution. The crystals may be collected on a filter, washed with water, dissolved in dilute spirits, and precipitated with excess of ether. "Or to the solution of Platner's crystals add neutral and then a little basic lead acetate, when glycocholate of lead will be thrown down. Collect on a filter, wash, and dissolve in hot alcohol, and remove the lead by passing a current of sulphuretted hydrogen; filter, and by the careful addition of water to the alcoholic filtrate, crystals will be deposited. To the previous filtrate from the glycocholate of lead add acetate of lead and ammonia; glycocholate and taurocholate of lead will be precipitated, and may be washed and decomposed, as with the glycocholate." In the bile of oxen from certain districts, glycocholic acid rapidly crystallizes on the addition of five c.c. of hydrochloric acid and thirty c.c. of ether to each five hundred c.c. of bile. In other specimens this process entirely fails. No satisfactory explanation of this peculiarity has ever been given, though Hoppe-Seyler suggests that the acid removes the base from the glycocholate, and the liberated glycocholate acid, being insoluble in water, is precipitated. If this were the explanation, the process should invariably succeed; such is not, however, the fact.

The test for these two acids is known as Pettenkofer's reaction for biliary acids. If a little cane-sugar in strong solution is added to a small quantity of bile in a test-tube, gently warmed to about 60° C., and then an equal volume of strong sulphuric acid allowed to flow down the side of the tube, a bright-purple color forms above the level of the acid. This test may be even better shown by preparing the bile as before (solution of Platner's crystals), warming gently, with a cane-sugar syrup, then shaking well until a layer of foam forms on the upper surface. If a small amount of sulphuric acid is poured down the inside of the tube, the froth on the surface of the bile becomes bright purple in color; or bile may be diluted with cane-sugar solution, and a piece of filter-paper dipped into it

and allowed to dry. Dropping a little sulphuric acid on the paper thus prepared will in a few seconds produce a violet-red color. Proteids will also behave in the same way as Platner's crystallized bile, but the reactions may be distinguished by the fact that, when examined spectroscopically, two absorption bands, one near the line E and the other opposite F, will be found when the bile is examined, and will be absent from the color produced by this test with albuminoids. Amylic alcohol will also produce a similar reaction, and here again the spectroscope will serve to distinguish them. This test depends upon the fact that cholic acid is first precipitated by sulphuric acid in a whitish form, as may be readily seen in solutions of crystallized bile, and then dissolved, assuming a cherry-red color, which becomes gradually darker in hue. The pigments and, to a still more marked degree, the presence of nitrates or chlorates will interfere with this reaction.

The source of the biliary acids is almost unknown, except that they probably originate from the breaking down of albuminoids. They are not found in the blood, but are formed in the hepatic cells, the nitrogen possibly originating from the albuminoid, while the cholic acid radical may be derived from the fats. These acids are compounds of taurin and glycochol with cholic acid, into which they may readily be split up by prolonged boiling with alkalis or mineral acids.

*Glycocholic Acid* ( $C_{26}H_{43}NO_6$ ).—Glycocholic acid occurs in large amounts in the bile of herbivora, while it is only found in small quantities in the bile of carnivora and omnivora. It originates from the union of glycochol with cholic acid, and, like taurocholic acid, is closely allied to hippuric acid. When boiled with hydrochloric acid it is decomposed into glycochol and cholic acid, the latter being a non-nitrogenous body. The reaction is as follows:—

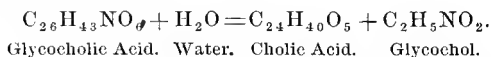

Glycocholic acid crystallizes in glistening, white needles, which are almost insoluble in cold water, slightly soluble in hot water, easily soluble in alcohol, and slightly soluble in ether.

*Taurocholic Acid* ( $C_{26}H_{45}NO_7S$ ).—Taurocholic acid is the only acid in dog's bile, as in that of other carnivora, though it can be obtained in small amounts from ox-gall after the removal of glycocholic acid. It contains sulphur, and forms white, glistening needles, which become fluid when in contact with the air. Taurocholic acid is soluble in water and alcohol and insoluble in ether. Of these acids only the alkaline salts are soluble in alcohol and water. Out of a mixture of glycocholic and taurocholic acid salts, acetate of lead will precipitate the glycocholic acid as a glycocholate of lead. When filtered off, the addition of acetate of lead and ammonia will precipitate taurocholic acid as a taurocholate of lead, which may be easily dissolved in hot alcohol, and the lead removed by passing a current of sulphuretted hydrogen through it.

Taurocholic acid originates in the breaking down of albuminoids, from which the sulphur is derived, and its amount in the bile may be

increased by an increase in albuminoid diet, though not in the same degree as occurs in the case of urea. It is rapidly decomposed into taurin and cholic acid; this decomposition also occurring in the intestine.

*Glycochol* ( $C_2H_5NO_2$ ), or glycine, is also formed by boiling gelatin with dilute sulphuric acid. It is a crystallized body, slightly soluble in water, insoluble in alcohol and ether. Its aqueous solutions have a faintly acid reaction. It does not occur as such in the animal body, but, besides being concerned in the origin of the bile acid, it is also found in the urine, especially of the horse, united with benzoic acid in the form of hippuric acid. It may be obtained from the glycocholic acid, as already indicated, by boiling with strong hydrochloric acid.

*Taurin* ( $C_2H_7NSO_3$ ) occurs in large, glistening columns as a product of splitting of the bile acids. It is readily soluble in water, insoluble in alcohol and ether. It is also found in the intestinal canal and in the flesh of various fish and of the horse, and in the kidneys, spleen, and lungs of various other animals. It is also found in putrid bile, being then developed at the expense of the taurocholic acid in the fermentation of the bile. It combines with various bases to form salts. The bile acids may thus be regarded as compounds of glycochol and taurin with cholic acid, whose chemical composition and general properties are not certainly known. Cholic acid may be regarded, therefore, as the starting point of the biliary acids.

*Cholic Acid* ( $H_{40}C_{24}O_5 + H_2O$ ).—Cholic acid is a constant product of decomposition of biliary acids, and is therefore found in the intestinal contents, occasionally in the urine of jaundice, but not in fresh bile or elsewhere in the organism. Cholic acid occurs in an amorphous and in a crystallized form; it is insoluble in water, soluble with difficulty in ether, and moderately soluble in alcohol.

“It may be prepared by boiling bile with caustic potash for twelve to twenty-four hours, then precipitating with hydrochloric acid, and, having washed the deposit with water, dissolving it in caustic soda containing a little ether; hydrochloric acid is next added, and after some time crystals form. The supernatant fluid may be decanted, and the residue covered with ether; drain off the ether in a half-hour or so, and dissolve the deposit in boiling alcohol; to this solution add a little water until a permanent precipitate appears, and tetrahedric crystals soon make their appearance.”

(c) *The Coloring Matters of the Bile*.—The bile under different conditions and in different animals contains a number of different coloring matters, to which its different shades of color are due. The essential coloring matter of fresh bile is *bilirubin*, to which the reddish-brown color of the bile of man and the carnivora is due, and which appears to be the starting point of the various coloring matters which are found in the bile of different animals; it also occasions the various changes

in tint which the bile undergoes after having been removed from the body. When bile remains for a considerable time in the gall-bladder, and when bile is exposed to the air, provided the reaction remains alkaline, the reddish-brown coloring matter, bilirubin, absorbs oxygen from the atmosphere and acquires a greenish color; it is then termed *biliverdin*. In the bile of herbivora and most cold-blooded animals this pigment exists naturally, and is present even before it passes into the small intestine. Both these substances, bilirubin and biliverdin, are insoluble in water, and their state of solution in the bile is to be explained on the basis of their forming soluble combinations with alkalis, and partly to their being held in solution by the bile acids, in whose solutions they are soluble. They are slightly soluble in ether and alcohol, and readily soluble in chloroform and in alkalies. The test for their detection is known as Gmelin's test, which is claimed to be sufficiently sensitive to detect the presence of one part of bilirubin in eighty thousand parts of solution.

The test is performed by adding nitric acid which contains some free nitrous acid to bile. This causes a precipitate which disappears on the addition of fresh acid, and results in the formation of a series of colors, passing through green, blue, violet, red, and then yellow, and is due to the different degrees of oxidation of the red coloring matter of the bile. Various modifications have been proposed for this test. Brücke recommends the addition of dilute nitric acid to the suspected fluid, and then pouring a quantity of concentrated sulphuric acid carefully down the side of the tube; as it sinks to the bottom it liberates free nitric acid, which produces the characteristic play of colors; or a concentric solution of nitrate of sodium may be added and then sulphuric acid. When only traces of bile and coloring matters are present, the addition of the tincture of iodine causes the appearance of a green color.

*Bilirubin* ( $C_{32}H_{36}N_4O_6$ ).—Bilirubin, which is also called hæmatoidin, occurs as an amorphous, orange-yellow powder, which, by its precipitation out of chloroform (obtained by boiling bile with chloroform), may be crystallized in red prisms. This bile-pigment is more frequently obtained from biliary calculi, especially those of the ox, which are constituted almost entirely of this pigment and cholesterin.

The calculi should be powdered, exhausted with ether, and then with boiling water containing a few drops of hydrochloric acid, which is added to separate the bilirubin from the alkali with which it is supposed to be combined. The residue is then to be washed in pure water, then dried, and then boiled with chloroform and finally filtered. From the filtrate the chloroform may be distilled off, the residue then extracted with alcohol, and ether and pure bilirubin will remain behind. The amorphous, reddish powder which remains may be purified and obtained in a crystallized form by re-solution in chloroform, which should be allowed to evaporate spontaneously. In the preceding process the ether is employed to remove the fat and cholesterin, and water to remove the other soluble biliary constituents.

Bilirubin is only slightly soluble in water, readily soluble in chloroform and benzole, and sparingly soluble in alcohol and ether. It seems to play the part of an acid, and unites with alkalies to form combinations



which are insoluble in chloroform. Bilirubin is the most important coloring matter, and from it originate the others. It is undoubtedly formed in the liver-cells, though it is also formed in other localities. Pathologically, it occurs in old blood-extravasations, where it was formerly described by Virchow under the name of hæmatoidin crystals; physiologically, it is found in the corpora lutea, in the ovaries, and in the borders of the placenta of the dog. Bilirubin evidently originates in the hæmoglobin of the red blood-corpuseles. All causes which produce breaking down of the red blood-cells and consequent jaundice, such as poisoning by ether and chloroform, lead to the appearance of bilirubin in the urine. This decomposition may also be produced by the action of the alkalies of the bile acids, and it is therefore probable that the physiological origin of the bile coloring-matter is due to the action of the bile acids on the blood-corpuseles in the liver. When oxidizing agents, such as nitrous-nitric acid, are added to a solution of bilirubin it displays a succession of colors identical with that seen in the application of Gmelin's test. Each of these stages represent a distinct pigmentary substance. The first which results, or the greenish color, is due to the appearance of biliverdin.

*Biliverdin* ( $C_{32}H_{36}N_4O_8$ ) occurs through the action of oxygen on bilirubin, and is produced even when the solutions of the latter are allowed to stand exposed to the air. This body is found in abundance in the bile of cold-blooded animals, and is the principal pigment of the bile of herbivora. Biliverdin may be prepared by making an alkaline solution of bilirubin and exposing it to the air in a shallow vessel; after awhile the reddish solution becomes intensely green, and biliverdin may be deposited as a green, amorphous powder by precipitation with hydrochloric acid, washing with water, dissolving in alcohol, and finally precipitating with water. Biliverdin then forms a green, amorphous powder, which is insoluble in water, ether, and chloroform; is soluble in alcohol, acetic acid, and solutions of the alkaline carbonates. When subjected to the action of nitrous-nitric acid this pigment also liberates a series of different colors, which pass through the same sequence as those developed by the addition of this acid to solutions of bilirubin, the only difference consisting in the absence of the original red color. The first change is from a green into a blue or violet color, and is due to the formation of choletlin, which finally becomes yellowish-brown. Each of the coloring matters of the bile has a distinctive absorption of the spectrum, which is yielded when the solution is treated with nitric acid. The bile of carnivora is usually free from absorption bands, unless an acid be added, in which case the absorption bands characteristic of bilirubin appear in the spectrum.

(d) *Cholesterin* ( $C_{26}H_{44}O (H_2O)$ ) is also an important constituent

of the bile, and forms the bulk of the so-called white gall-stones. Cholesterin rotates the plane of polarized light to the left, and forms transparent, rhombic plates, which usually have a small, oblong piece cut out of one corner. Cholesterin is insoluble in alkalis, dilute acids and alcohol, and cold water, and is soluble in hot alcohol, ether, glycerin, chloroform, and soap solution and alcohol. In the bile it is kept in solution through the union of bile salts. Cholesterin is widely distributed through the body, occurring usually in the cerebro-spinal axis and nerves, and, in fact, seems to originate from the breaking down of nerve-tissues. It is likewise found in the yolk of eggs, in the spleen, and in various pathological deposits in the animal body.

It may be prepared by powdering white gall-stones, boiling in water containing caustic potash, filtering when cold, and washing the resulting mass with boiling alcohol, and filtering while still hot. Cholesterin crystallizes out of the alcohol when cold. It may be purified by redissolving in boiling ether, and adding half its volume of alcohol, and allowing it to evaporate spontaneously. Cholesterin crystals give a violet color with 80 per cent. sulphuric acid (Moleschott).

When treated with nitric acid, dried, and touched with a drop of ammonia, a deep-red color is produced, which is not altered by the addition of caustic soda. (Schiff).

When dissolved in chloroform and agitated with an equal volume of strong sulphuric acid, a blood-red solution is obtained, which becomes gradually violet, blue, green, and then yellow, and then disappears if a trace of water is present. The layer of sulphuric acid in this test shows green fluorescence. If crystals of cholesterin are heated with tolerably strong sulphuric acid, and afterward with a little iodine, a play of colors is produced, passing from violet through blue, green, red, and yellow to brown.

Among the other organic constituents of the bile, lecithin, which belongs to the group of the complex nitrogenous fats, is to be mentioned. Its formula is  $C_{44}H_{90}NPO_5$ . It occurs widely distributed throughout the body, occurring especially in the brain, nerves, yolk of eggs, semen, and pus. When pure, it is a colorless, partially crystalline body, soluble in cold and hot alcohol, less so in ether, and soluble in chloroform, carbon disulphide, and fats.

It is not yet clearly established as to whether the lecithin found in the bile and other secretions and tissues is derived from the breaking down of food-stuffs in pancreatic digestion, or whether it is found synthetically. The reabsorption of lecithin, however, is complete, since no trace of lecithin or glycerin-phosphoric acid is to be found in the fæces.

(e) *The Inorganic Constituents of the Bile.*—Of the inorganic constituents of the bile, iron is of special importance, as indicating the red blood-corpuscles as the source of bilirubin, from which process of decomposition the iron also undoubtedly originates. No close relation, however, between its quantity and that of the bile coloring-matters has been ever distinctly made out. The following table, after Hoppe-Seyler, indicates the quantitative composition of the solids found in bile of the dog

drawn from the bile-duct, and after having remained some time in the gall-bladder:—

	From Bladder.	Freshly Secreted.
Mucin,	0.454	0.053
Taurocholic alkali,	11.959	3.460
Cholesterin,	0.449	0.074
Lecithin,	2.692	0.118
Fats,	3.841	0.335
Soaps,	3.155	0.127
Organic bodies insoluble in alcohol,	0.973	0.442
Inorganic bodies insoluble in alcohol,	0.199	0.408
$K_2SO_4$ ,	0.004	0.022
$Na_2SO_4$ ,	0.050	0.046
$NaCl$ ,	0.015	0.185
$Na_2CO_3$ ,	0.005	0.056
$Ca_32(PO_4)$ ,	0.080	0.039
$FePO_4$ ,	0.017	0.021
$CaCO_3$ ,	0.019	0.030
$MgO$ ,	0.009	0.009

2. *The Secretion of the Bile.*—In contradistinction to the saliva and gastric juice, the secretion of bile appears to be continuous: even during prolonged abstinence, though reduced in amount, it is not suppressed. Food exercises a marked influence on the quantity and composition of the bile, every meal producing a maximum increase in the amount of secretion which is reached between three and five hours after the completion of the meal. It then returns gradually to its original quantity, to be again subjected to a second increase, which occurs between thirteen and fifteen hours afterward. This increased flow of bile, it will be noticed, co-exists with the discharge of the contents of the stomach into the small intestine, and it would appear, as has been determined experimentally, that the application of the acid to the intestinal surfaces causes a discharge of bile by causing reflex contraction of the bile-ducts and gall-bladder.

Since in the herbivora eating and digestion are almost continuous, the amount of bile secreted is much larger than in the case of the omnivora and carnivora. The total amount has been estimated to be about five hundred to six hundred cubic centimeters in twenty-four hours, or fifteen grammes of bile with half of one per cent. of solids per kilo of body weight. In the horse the amount excreted in twenty-four hours is about five to six kilos. In dogs, the secretion is most active after a meal of meat, a diet of fat, however, greatly reducing the amount of this secretion. According to Bidder and Schmidt, for every kilo of body weight each hour the

Sheep secretes	1.059 grammes of bile.
The dog “	0.824 “ “
The cat “	0.608 “ “
The rabbit “	5.702 “ “

Colin fixes the following amounts as the hourly secretion in the domestic animals :—

In the ox,	100 to 120 grammes.
In the pig, .	75 to 160 "
In the sheep,	10 to 160 "
In the dog,	8 to 15 "
In the horse,	250 to 300 "

It would seem, therefore, that the smaller the animal the greater the relative amount of bile secreted in proportion to the body weight. Thus, a guinea-pig weighing one kilo, and whose liver only weighed forty grammes, secreted in twenty-four hours one hundred and seventy-five grammes of bile, or more than four times the weight of the liver; and as the bile of the guinea-pig contains 1 per cent. of solids, one kilo of liver-substance would, in twenty-four hours, form four kilos of bile with fifty grammes of solids. Since the liver only contains 25 per cent. of solids, it follows that in twenty-four hours one-fifth of all the solids in the liver must be eliminated in the bile. According to Colin, the liver forms, in twenty-four hours, in the horse six kilos, in the ox 2.64 kilos, and in the sheep 0.34 kilos.

In contradistinction to the saliva, the bile is secreted under very low pressure. Every slight obstruction to the flow through the duct leads to reabsorption of the secretion by the hepatic lymphatic vessels and consequent jaundice, thus showing the close connection between the bile-ducts and lymphatics. This is also shown by the fact that microscopic injections of the bile-ducts made after death, under very low pressure, often pass into the lymphatics of the liver. While the pressure under which the bile is secreted is comparatively low, as compared with that of the saliva or that of the arterial pressure, it has been stated by Heidenhain that the pressure under which the bile is secreted is more than double that of the blood in the portal vein. In the liver, therefore, as in the salivary glands, there can be no question as to the formation of this secretion by a mere process of filtration; it can only take place as the result of special cell activity, the specific constituents of the bile, the bile acids and the coloring matter, being found normally neither in the blood nor in any other tissue or organ, the cases in which they or their derivatives are found elsewhere than in the bile being capable of clear proof that they have only reached those localities through the bile. Even after extirpation of the liver, no accumulation of bile coloring-matter can be detected in the economy. The specific constituents of the bile must, therefore, be formed in the liver-cells, and, as already indicated, there is considerable proof that the coloring matter originates from the breaking down of the red blood-cells, the process of destruction being probably due to the action of the bile acids, hæmo-

globin being thus liberated and then decomposed into bilirubin, the iron escaping in the form of a phosphate in the bile. As regards the origin of bile acids little is known, though they are probably derived from the breaking down of albuminoids.

The action of the nervous system in modifying the secretion of the bile is almost entirely unknown. No nerve has been found whose stimulation leads to an increased flow of bile, or causes its arrest when actively flowing. The splanchnic nerve has been noticed, when stimulated, to cause an increase in the flow of bile from biliary fistulæ, but this action is evidently due to the production of contraction of the biliary ducts.

3. *The Physiological Action of the Bile.*—The bile enters the intestine, in most animals, associated with the pancreatic juice, as seen in the horse, goat, and dromedary, while in the ox and rabbit the bile-duct is separated for a considerable distance from the opening of the pancreatic duct. The fact that it enters the intestine simultaneously with the pancreatic juice, or even before it, shows that in its physiological action it must be associated with the latter. Its action on the food-stuffs is of but slight importance. On proteids it produces no distinct action whatever, and, in fact, would seem to interfere with the digestion of proteids as commenced in the stomach. Thus, when bile, or a solution of taurocholic acid, is added to the products of gastric digestion, a copious precipitate takes place, which consists of coagulable albumen, syntonin, and pepsin,—the latter being indicated by the fact that when this precipitate is filtered off and the supernatant liquid acidified it has no peptic power. This precipitate is, however, redissolved in an excess of bile or a solution of bile salts, and its object would appear to be, by precipitating the parapeptone to delay its passage through the intestine and so give the pancreatic juice time to act, while, at the same time, by precipitating the pepsin the pancreatic ferments are protected from the solvent action of the gastric juice. For we find that during active digestion, as a rule, the contents of the small intestine are strongly acid in the greater portion of its upper extremity, and were the pepsin not precipitated the pancreatic ferments would be digested and therefore destroyed through the action of the gastric juice. The re-solution of the precipitate produced by bile in the products of gastric digestion is due to an excess of taurocholic acid. In most animals (ox, sheep, and horse), the bile has been found to contain a ferment, present in small amount, which is capable of converting starch into sugar. A similar action is also produced on glycogen. This action is, however, secondary, and of but little importance in the digestion of carbohydrates, other than that the bile assists the amylolytic action of the pancreas. In the dog's and pig's bile no diastatic ferment is present.

The principal function of the bile in digestion is the aid which it renders to the digestion and absorption of fats. Bile has a solvent action on fats in small quantities, and assists in the emulsification of fats. We shall find that the pancreatic juice, in its action on fats, liberates fatty acids. A similar action is also manifested, although to a very much less extent, by the bile of the horse, ox, and sheep; it is absent in that of the hog and dog. These fatty acids, thus liberated, unite with the alkalis of the bile and pancreatic juice and form soaps, and so greatly assist in the formation of a permanent emulsion. By means of the emulsion thus formed the absorption of fat is greatly assisted; while, in addition, it has been found that when membranes are moistened with bile, or with solutions of bile salts, the passage of fats through such membranes is greatly facilitated. Thus, if two filters are moistened, the one with a solution of bile salts and the other with water, oil will pass with comparative readiness through the former, while it scarcely succeeds at all in passing through the filter moistened with water. Oil-drops placed on the surface of bile spread into a thin layer, like solutions of corrosive sublimate on mercury, and in tubes moistened with bile the oil will rise above its level outside of the tube,—facts which point still further to the assistance which the bile renders in the absorption of fats. The bile of most animals contains a lactic acid ferment. On other food-stuffs bile is quite inert.

It is evident from the above that the uses of bile must be manifested in some other direction than as a digestive fluid; for while it would be presumed from the fact that we have here the largest gland in the body, pouring an immense volume of fluid into the digestive tract at a point at which digestion has barely commenced, that that fluid must have some important rôle to fulfill in digestion, the facts above mentioned, attained through chemical examination, show that this assumption is not entirely warranted. Still another method of examination, that of the production of permanent biliary fistulæ, also shows that the functions of the bile are not solely manifested in assisting in digestion. In other words, the bile is not only a digestive secretion, even though of secondary importance, but is also an excretion. The most valuable data as to the functions which the bile fulfills in the economy are obtained from the maintenance of biliary fistulæ.

Biliary fistulæ may be either temporary or permanent. The former are of special importance for the study of the secretion of bile as to the influence of drugs and other agents on the amount of bile poured out. Dogs are most suitable for such an operation, which may be performed upon them without any difficulty.

The dog should have been allowed to fast for several hours before the operation, as then the gall-bladder will be apt to be filled with bile. After

anæsthesia has been produced, an incision should be made in the linea alba about an inch and a half long and about two inches below the xyphoid cartilage, tying each bleeding-point before the abdomen is opened. On pushing aside or tearing through the omentum with the forefinger of the right hand, and carrying the finger well down below the liver, a dense band may be felt running from the liver to the duodenum, and consisting of the hepatic vessels, nerve, and common bile-duct. Hooking the forefinger under this band, and drawing it carefully and slowly forward, a blunt hook may be passed under it with the free hand, and the vessels drawn out of the wound. They can be prevented from retracting into the abdominal cavity by pushing the hook through so that the vessels lie upon its handle, which rests transversely over the wound. The duct is easily isolated and ligated at its entrance to the duodenum to secure the small blood-vessels on its surface, and the cannula inserted and tied in the duct. On removing the stilette from the cannula, a few drops of bile immediately escape. Probably, however, a similar method, and one less likely to wound the hepatic blood-vessels, is to open the abdomen at the right margin of the right rectus muscle, and then follow the duodenum, which appears in the wound, and may be recognized by its large size and absence of mesentery, up toward the stomach, where the duct may be readily isolated and divided at its insertion into the duodenum.

Permanent biliary fistulæ may also be made quite readily in dogs, and have been undertaken to decide the question as to the excrementitious nature of the bile. For this purpose the gall-bladder is selected for the fistula instead of the ductus choledochus. The abdomen is opened in the median line, or, preferably, at the right border of the right rectus muscle, care being taken not to wound the large vessels which cross the wound on the inner surface of the abdomen, and the common bile-duct isolated as before. It is then ligated close to its entrance into the intestine and at its junction with the cystic duct, and the intermediate portion excised.

The gall-bladder is then drawn down and fixed to the edges of the wound. The operation may then be suspended until adhesion has occurred between the walls of the bladder and the edges of the wound, and the bladder then opened; or it may be treated in the same manner as when making gastric fistulæ, and a cannula similar to the one employed in making gastric fistulæ inserted at once. In this mode of operation the object has been to exclude the bile entirely from the intestine; but Schiff has shown that less pressure is required to make the bile pass from the hepatic duct into the gall-bladder than to force it through the common duct into the intestine. This excision, then, of the common duct is entirely unnecessary, apart from the fact that it sometimes fails in its object by becoming restored; since as long as the cystic fistula is kept open the bile passes out of the wound, but when the cannula is closed it passes as normally into the duodenum.

When the operation for the formation of a permanent biliary fistula succeeds, and all the bile is conducted outside of the body, animals rapidly lose weight and eventually die, under ordinary circumstances, under the phenomena of starvation. Such a result depends upon the interference with the digestion of fats and upon the direct loss of bile salts. Thus, Voit has found that a dog weighing twenty kilos, which in its normal condition was able to digest from one hundred and fifty to two hundred grammes of fat, absorbing 99 per cent. of this amount, was only able, after a permanent biliary fistula was established, to absorb 40 per cent. of the fat given. The loss of such an amount of fat through imperfect absorption naturally produces a disturbance of nutritive equilibrium. An animal which before the operation is able to preserve its nutritive balance with a certain amount of meat and fat, is unable to do this after the performance of a biliary fistula, and is compelled to call on

the reserve store of tissue-albumen, and finally dies practically of starvation. If the animals are allowed to lick the wound, and so cause the bile to enter their alimentary canal, the phenomena of impairment of nutrition are very much less marked. So, also, if they are fed on double the amount ordinarily required to maintain their nutritive equilibrium, the carbohydrates especially being in excess, the phenomena of malnutrition may be largely prevented. In animals where the secretion of bile is prevented entirely from reaching the intestines, we find that obstinate constipation is usually added to the symptoms of disturbed nutrition, and that the fæces which are occasionally passed are clay-colored, with a most offensive putrefactive odor. It would, therefore, appear that the bile, by acting as a stimulus to the mucous membrane of the intestine, tends to maintain the normal peristaltic contractions of this part of the alimentary canal, and to that extent, therefore, acts as a natural purgative, while at the same time it largely prevents putrefaction and decomposition. The bile is, however, largely an excretion. Many of its constituents are removed unchanged, while some of them are reabsorbed and again enter the blood-current. The mucin and cholesterin pass through with the fæces unchanged. The bile-pigments undergo decomposition in the intestinal tube, and are partly excreted with the fæces under the form of hydro-bilirubin, a characteristic brown coloring-matter of excrement, and are partly eliminated as urobilin by the urine. The bile salts are for the most part reabsorbed by the walls of the upper portion of the small intestine, only a small quantity of glycocholic acid being found in the fæces. The taurocholic acid is largely absorbed, it being previously, perhaps, decomposed into cholic acid and taurin, the latter being constantly absorbed, while part of the cholic acid may perhaps be removed with the fæces.

II. THE PANCREATIC SECRETION.—The pancreatic fluid is poured into the small intestine immediately after the entrance of the bile, or in some instances simultaneously with it and the secretion of Brunner's glands. While the pancreas is one of the most constant of all glands, existing in all mammals, birds, reptiles, in most fish and insects, its anatomical form is subject to great variation in different animals. In the dog, as in other mammals, most birds, and reptiles, the pancreas is situated in the concavity of the duodenum. Also in the dog, and in other mammals in which the duodenal mesentery is short or absent, this gland is thick, elongated, and bilobed, one portion extending horizontally toward the spleen, while the other portion descends at a right angle, parallel to the duodenum (Fig. 155). At the angle the pancreas is closely adherent to the duodenum, and often overlaps it, being connected by a multitude of small blood-vessels, while the descending portion lies free in the abdominal cavity. There are in the



dog, in which the operation for making pancreatic fistulæ is most usual as in most other animals, two pancreatic ducts—the upper and smaller one opening into the duodenum in the same papilla as the bile-duct, while the larger and lower duct opens into the duodenum about two centimeters lower down. These ducts communicate by frequent anastomoses, the lower being always selected for operation. In those animals in which the duodenum has a wide mesentery, as in the rodents, the pancreas forms an arborescent mass between the two layers of the mesentery. This is the plan of arrangement in the rabbit, and also in the

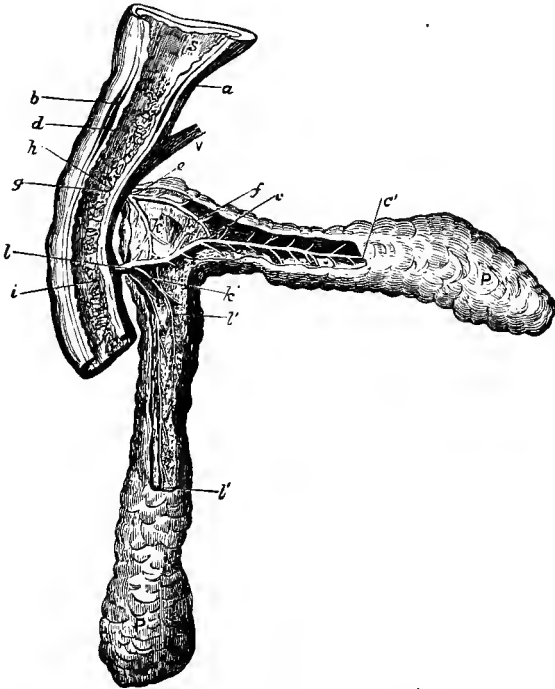

FIG. 155.—PANCREAS OF THE DOG. (Bernard.)

P P, pancreas; a, pylorus; b, glands of Brunner; c c', large pancreatic duct; d, eminence formed by the duodenal glands; e, small pancreatic duct at its opening in the intestine; f, anastomosis between the large and small pancreatic duct; g, orifice of the biliary duct; h, orifice of small, and i, of the large pancreatic duct; k', anastomosis of the large with the small duct.

cat. In the rabbit the pancreas has two ducts, but the upper one, which enters the duodenum with the bile-duct, is very small, while the lower one is very long, and enters the intestine about thirty to forty centimeters below the pylorus. In the cat, the arrangement of these ducts is so irregular as to baffle all description. In most cases there are several of them, and sometimes, as occurs quite constantly in the seal, the upper duct passes into a sort of reservoir

before entering the intestine (Fig. 156). The arrangement of the pancreatic ducts in the bird is represented in Fig. 157.

The pancreatic juice is a colorless, alkaline fluid secreted by the pancreas or the so-called abdominal salivary glands. It differs from the other digestive secretions in that when freshly formed by a normal gland it contains a large amount of proteids. Its composition varies with the rate of secretion, and when studied as obtained through fistulæ differs accordingly as to whether a temporary or permanent fistula has been made.

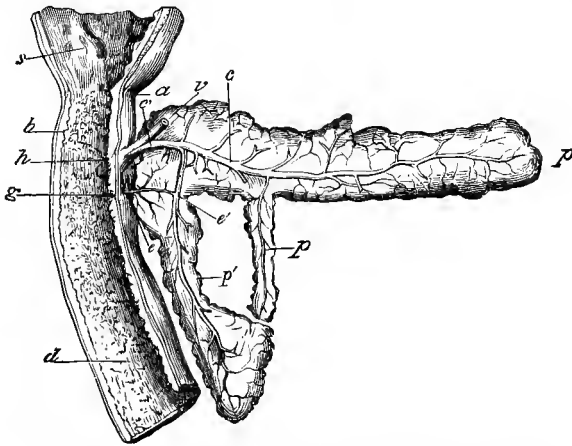

FIG. 156.—PANCREAS AND DUODENUM OF THE CAT. (Bernard.)

*a*, pylorus; *b*, section of duodenum at the level of the glands of Brunner; *c* *c'*, superior pancreatic duct opening with the biliary duct into the intestine; *a*, mucous membrane of the duodenum; *c*, inferior pancreatic duct; *c'*, point of its anastomosis with the descending branch of the pancreatic duct; *h*, common opening of the biliary duct and superior pancreatic duct; *s*, pyloric portion of stomach; *v*, biliary duct; *p p'*, pancreas.

Temporary fistulæ of the pancreas are best made on the dog, since in this animal there is the greatest probability of escaping peritonitis,—a complication which if present is disastrous to the success of the operation, for the pancreas is extremely susceptible to inflammation, and as a consequence the secretion becomes perverted and its properties altered. The only difficulty in the operation consists in finding the duct without injuring the gland or its numerous blood-vessels. To be thoroughly successful the operation should be performed as rapidly as possible, so as to avoid exposing the parts any longer than is necessary, while the pancreas should be handled with the greatest gentleness. The operation should be performed without employing an anæsthetic, to avoid subsequent vomiting and possible vitiation of the secretion. The dog should receive a hearty meal of bread and meat two hours before the operation, and then should be fastened on his left side. An incision should be made in the right hypochondrium, descending downward from the end of the last rib about five centimeters and parallel with the linea alba, every bleeding point being tied before the peritoneum is opened. Passing the index and middle fingers of the left hand into the wound, the duodenum is easily recognized. The fingers are then carried well down into the right hypochondrium, and then backward to the convex surface of the duodenum, and keeping their palmar surface directed upward, the fingers are carried behind the duodenum and pancreas, which are then to be drawn together out of the wound. The animal being in full digestion, the tissue of the gland is of a rosy-pink coloration. By this manipulation the parts preserve their normal relation, and the an-

terior surface of the pancreas presents in the wound. The next step, and perhaps the most difficult, is the finding of the duct,—a proceeding rendered difficult not only by the extreme shortness of the duct, but by its being surrounded by numerous blood-vessels, which bleed very easily and which bridge over the duodenum and the overlapping edge of the pancreas. By keeping the anterior surfaces directed forward this difficulty is reduced to a minimum, since here the duct is nearer the surface and is only surrounded by a few small blood-vessels, while on the posterior surface the vessels are very large, and it is just back of a large hundle of vessels that the duct enters the intestine. On carefully pushing aside with a blunt hook the overlapping edge of the pancreas at the lower border of the angle formed by the transverse and vertical portions of this gland, and about two centimeters below the duetus choledochus, the larger panereatic duct is seen and may be distinguished from the blood-vessel by its larger size and white color. The finding of the duct may be facilitated by the following observations: Where the vertical segment of the pancreas leaves the duodenum there is always to be found a thick vein passing from the intestine to the pancreas. Above this the pancreas lies directly under the gut, joined to it by numerous bundles of veins. The opening of the duet lies usually in the space between the first two of these or between the second and third. After the duet has been isolated, a thread should be passed around it and it should be opened with a pair of fine seissors; a small silver cannula, about five millimeters in diameter and ten centimeters long, may then be inserted and pushed up to the first division of the duct, tying it securely by the thread previously passed around the duct. To make the cannula still more firm, a stitsh may be passed through the serous coat of the intestine and then the cannula fastened there also. The duodenum and pancreas are then returned to the abdominal cavity, retaining the ends of the thread and the free end of the cannula in the wound, which is then closed by sutures. first sewing together the muscles and then the skin. Upon withdrawing the stilette from the cannula a few drops of colorless, limpid fluid escape, which flow more rapidly when the animal makes any movement and which is strongly alkaline (Figs. 158 and 159). The secretion may be collected by fastening a rubber bulb furnished with a stop-cock to the cannula. The bulb should be first compressed so as to be emptied of air, the stop-cock closed and connected with the cannula. On opening the stop-cock the tendency of the bulb to expand draws the fluid out of the duets. Generally the fluid is secreted quite rapidly, and may be collected

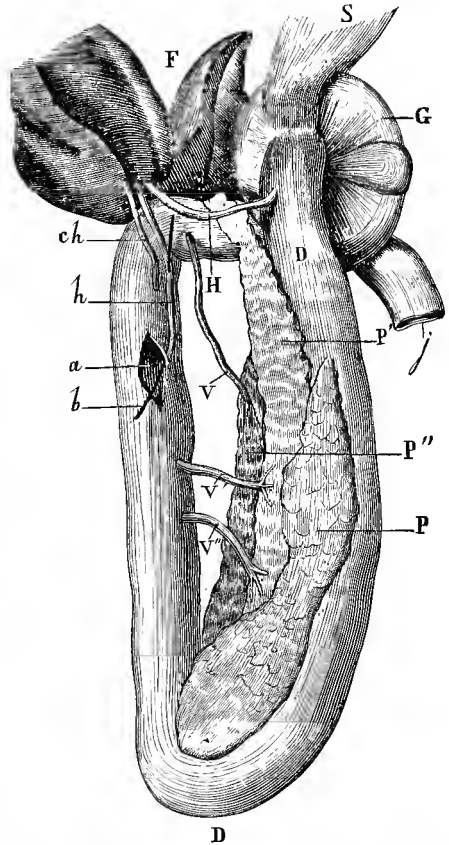

FIG. 157.—PANCREAS OF THE PIGEON. (Bernard.)

P, first pancreas with its duct, V; P' P'', second pancreas with two ducts, V V''; H, biliary duct opening into the duodenum, D, below the gizzard. G, *ch* and *h*, secondary biliary ducts opening into the ascending portion of the duodenum; F, liver; S, stomach; P P' P'', pancreas; *a*, opening in duodenum showing a probe, *b*, inserted into secondary biliary duct.

from the cannula a few drops of colorless, limpid fluid escape, which flow more rapidly when the animal makes any movement and which is strongly alkaline (Figs. 158 and 159). The secretion may be collected by fastening a rubber bulb furnished with a stop-cock to the cannula. The bulb should be first compressed so as to be emptied of air, the stop-cock closed and connected with the cannula. On opening the stop-cock the tendency of the bulb to expand draws the fluid out of the duets. Generally the fluid is secreted quite rapidly, and may be collected

for several hours. After the first day, however, the character of the secretion alters and is no longer normal or suitable for study. If it does not flow rapidly, it may be stimulated by injecting ether through a tube into the stomach. Vomiting stops the secretion. Usually after the second day the tube and threads drop out, or else they may be gently removed, and the wound generally heals readily and the duct becomes restored. The same animal may again be used for the same purpose. One of the difficulties that will be met with in this operation is that, since the duct is so short, the cannula is very apt to slip out. This may be partially remedied by having a cannula made with a little bulb on the end to be inserted, or a T-shaped cannula may be used, the duodenal end of which must be closed. If such a cannula is used it is better to have one made in two sections, one being first inserted in the duct and the other, which is to come out of the wound, screwed in afterward.

In the ruminant animal the pancreas lies in part on the convolutions of the colon, on the superior right portion of the rumen, extending over the fissure of the liver to the second lumbar vertebra. Its duct, six, eight, or nine millimeters in diameter, opens into the duodenum in the ox eighty to ninety-five centimeters

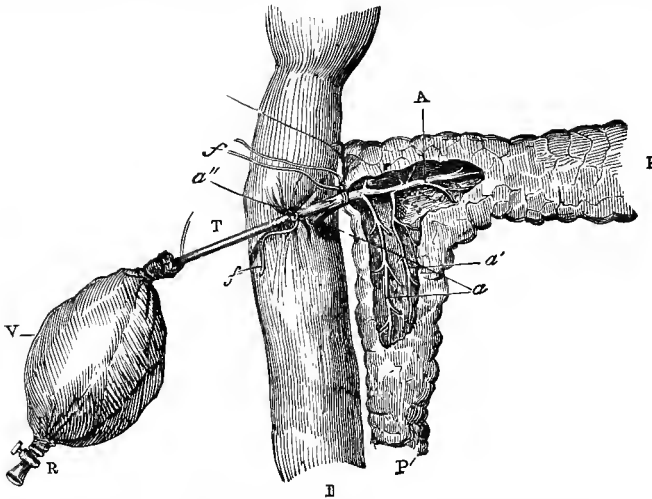

FIG. 158.—PANCREATIC FISTULA IN THE DOG. (Bernard.)

A, principal pancreatic duct; a, entrance of the duct into the intestine; a', lesser pancreatic duct; a'', ligature fastening the cannula to the intestinal wall; f, f, ends of the ligature; I, duodenum; P P', pancreas; T, cannula; V, rubber bulb; R, stop-cock.

below the pylorus, and in the sheep and goat at the opening of the bile-duct, and is often free from gland-tissue for a space of from two to three centimeters. To make a pancreatic fistula in the ruminant, an incision about ten to twelve centimeters long is made in the right flank parallel to the last rib and three or four fingers' breadths removed from it. The pancreas then comes into view on opening the abdomen, the duct may be readily exposed, and the cannula inserted. The operation may be readily performed on the ox without uncovering the duodenum from its omentum, and without dragging on the pancreas (Fig. 160).

In solipedes it is difficult to study the pancreatic secretion. The gland is deeply situated against the vertebral column, its duct is surrounded by gland-tissue up to its insertion in the duodenum, and it has very thin walls. To make a fistula it is necessary to freely open the abdominal cavity in the median line from the sternum almost to the pubis, to withdraw the colon from the abdomen, open the duodenum and insert a tube through the opening of the pancreatic duct and fasten it by a ligature, which must also include part of the gland. The colon and duodenum are then to be replaced and the wound sewed up. This method

was first employed by de Graff on the dog, and has proved successful in the hands of Leuret and Lassaigne on the horse.

As before stated, the operation as performed as above described does not render the permanent collection of this secretion possible. It has been found that when permanent fistulæ are established, although they serve a useful purpose in permitting the study of various conditions which may modify the secretion of pancreatic juice, yet the fluid poured out by the glands under these circumstances cannot at all be regarded as its normal secretion. For the purpose of establishing a permanent pancreatic fistula, a small dog may be selected, since in small animals the pancreas is nearer the middle line than in large dogs, and hence the parts are not as much disturbed by the operation. The dog having been kept fasting for twenty-four hours, so that the pancreatic vessels should contain as little blood as possible, should be narcotized by a subcutaneous injection of morphine, and the abdomen opened by an incision about two centimeters long made in the linea alba and about midway between the xyphoid cartilage and umbilicus. The duodenum and the

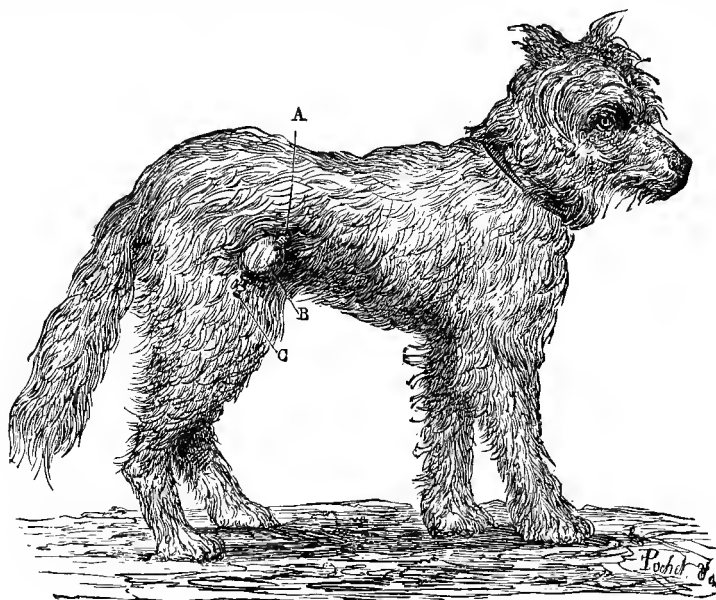

FIG. 159.—PANCREATIC FISTULA IN THE DOG. (*Bernard.*)

A, cannula on which is fastened the rubber bulb; B; C, stop-cock.

pancreas are then to be drawn out of the wound and the pancreatic duct isolated and opened by a little cut in one side; instead then of inserting a cannula, two pieces of lead wire bent at an angle are to be introduced, one wire being passed toward the gland and the other into the intestine; the remaining halves of each wire are then to be twisted together so as to form a T-shaped piece, the middle limb of which projects through the wound. Owing to the shape, the wires cannot fall out and cannot move around in the duct. Fine wire should be selected somewhat smaller than the calibre of the duct, so that the flow of the secretion will not be interfered with. The duodenum and pancreas are then returned to the abdominal cavity, care being taken to retain the wires in the wound, the duodenum is to be stitched to the abdominal peritoneum, and the wound then closed. Inflammatory adhesions take place around the wound and the wires cause the formation of a fistulous tract which communicates with the ducts and through which, after a week or so, the juice may be collected.

Heidenhain has employed a method of establishing permanent pancreatic fistulæ which he claims to have yielded in his hands satisfactory results. He excises that portion of the duodenum which contains the opening of the pancreatic duct, restores the continuity of the gut, and sews the excised portion, after division lengthwise, to the abdominal wound, so that the orifice of the duct opens externally upon the abdominal surface.

1. *The Chemical Composition of Pancreatic Juice.*—The pancreatic secretion differs in composition and physical properties according as it is obtained from permanent or temporary fistulæ, and according to the animal from which it is obtained. When obtained from temporary fistulæ in the dog, it is a clear fluid, almost of the consistency of syrup, very

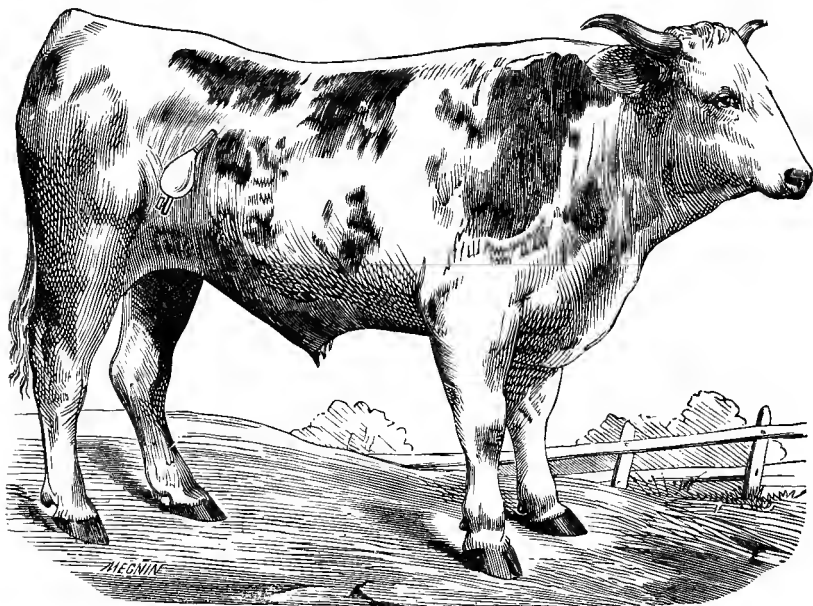

FIG. 160.—PANCREATIC FISTULA IN THE OX. (*Colln.*)

tenacious, and of strongly alkaline reaction. It contains few or no structural elements, though corpuscles similar to those found in saliva have been claimed by Kühne to exist, and occasionally free particles of oil. It has a decided salty taste, and under the action of heat coagulates, as does the white of egg, to a firm white mass. Alkalies prevent the coagulation. When alcohol is added to the fresh pancreatic secretion it forms a copious, white, flocculent precipitate, which is subsequently in large part, after filtration, soluble in water. When very dilute acids are added to pancreatic juice, they at first form a turbid mass which subsequently dissolves in excess of acid. This action is to be explained as due to the

production of acid albumen. Dilute acetic, lactic, and phosphoric acids are without apparent action on pancreatic juice, but it is precipitated by metallic salts, tannic acid, iodine, and chlorine- and bromine-water. The pancreatic secretion obtained from a temporary fistula in a sheep is a clear, tenacious fluid, which may be drawn out in threads like the white of an egg. The first portions secreted are claimed to have a slightly acid reaction, which soon becomes converted into an alkaline reaction. The pancreatic juices of the horse, the rabbit, the chicken, and pigeon behave in a similar manner, although the pancreatic secretion of the rabbit only becomes turbid when heated, and does not form a firm coagulum, like that of the dog.

The pancreatic secretion differs from the other digestive fluids in the large amount of solids, principally proteid in nature, which it contains. Its specific gravity as obtained from temporary fistulæ may be placed at 1030; obtained from permanent fistulæ in the dog, the pancreatic secretion is a thin, watery fluid, with a specific gravity only of about 1010 or 1011; the lower specific gravity, of course, being due to the smaller amount of solids. In the fluid from permanent fistulæ the solids amount to 2 to 5 per cent., while in that obtained from temporary fistulæ they may rise to 10 per cent. Otherwise the fluid from permanent fistulæ agrees in most respects with that from temporary fistulæ, it is clear and colorless, alkaline in reaction, and of a sickly, saltish taste. When heated it becomes turbid and may even coagulate, while it may also be precipitated by alcohol, the precipitate being soluble in water. When cooled down to the freezing point, it is said to deposit transparent mucus-like coaguli. The pancreatic secretion, in contradistinction to that of the gastric glands, is readily decomposed; it then acquires a faecal odor and colors chlorine-water red. After standing for some time, it acquires an offensive, putrefactive odor and now no longer gives a red with chlorine, but with nitric acid a bright-red color is produced. This reaction is evidently due to indol.

The pancreatic secretion contains serum-albumen, alkali albuminate, fat, soaps, and sodium salts, and is thus very closely allied to blood-serum in composition; but it differs from it in containing four ferments,—an amyolytic, a proteolytic, one which splits fats into glycerin and fatty acids, and the milk-curdling ferment. The first three of these ferments are precipitated by alcohol and are found in the pancreatic secretion of both carnivora and herbivora. The existence of the milk-curdling ferment is not entirely beyond question. Pancreatic juice is also stated to contain peptones, leucin, and tyrosin, but it seems probable that these elements are not found in perfectly fresh juice, with the exception, may be, of a trace of leucin, but are formed through the digestion of the albumen in the pancreatic juice by one of its own ferments.

The following table represents the composition of the pancreatic juice of the dog, as obtained from permanent and temporary fistulæ:—

	Temporary Fistula.	Permanent Fistula.
Water, . . . . .	900.8	984.06
Solids, . . . . .	92.2	15.4
Organic matter, . . . . .	90.4	9.2
Ash, . . . . .	8.8	6.1

The following table represents the analyses of the ash.—

	Temporary Fistula.	Permanent Fistula.
Sodium, . . . . .	0.58	3.31
Sodium chloride, . . . . .	7.35	2.50
Potassium chloride, . . . . .	0.02	0.93
Phosphatic earths with traces of iron, . . . . .	0.53	0.08
Sodium phosphates, . . . . .		0.01
Lime and magnesium, . . . . .	0.32	0.01

The solids in pancreatic juice are, however, subject to great variation. Bernard found in the secretion from temporary fistulæ in the dog 8 to 10 per cent. of solids, Tiedemann and Gmelin 8.7 per cent. of solids, of which 7.89 per cent. were organic and 0.72 per cent. ash, while in the secretion of the sheep 3.6 to 5.2 per cent. of solids have been found.

According to Hoppe-Seyler, in 1000 parts of pancreatic secretion, obtained from a diverticulum in the pancreatic duct of the horse, 982.5 parts were water, 8.88 parts organic matter, and 8.59 parts ash.

In the rabbit the solids have been placed at 1.76 per cent., while in the ram 1.43 to 3.69 per cent. of solids have been determined through various analyses.

*The Pancreatic Ferments.*—The pancreatic ferments may be together extracted from the fresh gland by a process of mincing and extracting with glycerin; on adding alcohol to the glycerin extract, the proteolytic and amylolytic ferments may be precipitated. If, however, the gland be first treated with alcohol before extraction with glycerin, the proteolytic ferment will not be found in the solution, while the diastatic ferment will be present in large amounts. It is claimed, however, that if the pancreas of the ox be allowed to remain for a long time in alcohol, and then extracted with glycerin, a preparation will be obtained which contains all three of these ferments.

Various processes have been proposed for the isolation of these three ferments. Danilewsky recommends for the isolation of the proteolytic ferment that the pancreas should be taken from an animal killed six hours after a copious meal, and, after washing, should be ground up with clean sand and digested for two hours with water, at a temperature which should not rise above 30° C. The mixture should then be filtered, and the filtrate, which contains both amylolytic and proteolytic ferments, treated with an excess of calcined magnesia to remove fatty acids, filtered, and added to one-third its volume of thick collodion, which carries down the fibrin-ferment in a crumbly mass. The ether should then be evaporated, and the resulting mass washed with alcohol and ether, and by now



precipitating with alcohol the proteolytic ferment may be isolated comparatively pure. From the filtrate of the precipitate obtained with collodion the diastatic ferment may be isolated by evaporating under an air-pump, filtering off the precipitate, again precipitating with alcohol, and dissolving the precipitate in a mixture of two parts of water and one of alcohol, by which proteid matter is removed. The remaining substance will convert starch rapidly into sugar, but is without action on proteids.

Kühne's method is to form an aqueous extract of a pancreas at the freezing point and to precipitate with alcohol; the precipitate is re-dissolved in water, again precipitated with absolute alcohol, and the precipitate a second time re-dissolved in water and treated with acetic acid up to 1 per cent.

The same treatment is repeated a second time, and the watery solution, after the addition of acetic acid, is warmed to 40° C. and then filtered. The filtered liquid is made alkaline with sodium hydrate, by which the greater part of the earthy salts and tyrosin are precipitated, the trypsin or proteolytic ferment is then freed by dialysis from tyrosin, peptones and other crystalline substances, and finally precipitated with alcohol.

Paschutin recommends a process for the isolation of these ferments which depends upon the fact that solutions of different salts have special capabilities of extracting the separate ferments. He found that sodium chloride, calcium chloride, and sodium sulphate were able to dissolve all three of the ferments, while other solutions had special degrees of power in extracting the individual ferments. Thus, the proteid ferment is especially dissolved by potassium iodide, potassium arseniate, and potassium sulphate. The fatty ferment is readily extracted by solutions of bicarbonate of sodium containing a small quantity of caustic soda, while the diastatic ferment is most readily extracted by a solution of arseniate of potassium to which a small quantity of ammonia has been added.

2. *The Action of the Pancreatic Juice on Food-Stuff's.*—When studying gastric digestion, it was seen that all the different phenomena could be most conveniently studied with an artificial fluid in experiments conducted outside of the body. The same conditions prevail in the study of pancreatic digestion. An artificial pancreatic juice may be made by three different processes:—

*First.* The fresh pancreas of a dog killed some hours after a full meal is cut into pieces, washed to remove the blood, and then infused for two hours in four times its weight of water, warmed to 25° C., taking care to keep the mixture at that temperature during the whole time of infusion. It is then to be filtered, first through muslin and then through paper. Since the filtrate will be usually acid from the development of fatty acids through the action of ferments on fats of the pancreas, it must be neutralized with sodium carbonate. The fluid will be slightly opalescent from the small amount of fat held in the form of emulsion. This preparation has all the properties of pancreatic juice, although the degree of its digestive action on proteids will depend upon the nutritive state of the pancreas from which it was made. For, if the pancreas of a fasting animal was employed, it will possess scarcely any digestive powers.

*Second.* An artificial pancreatic juice may be obtained by allowing a minced pancreas to remain for two days in absolute alcohol, which is then to be filtered off and the residue covered with glycerin; this glycerin extract will contain a considerable quantity of the amylolytic ferment, while the quantity of proteolytic ferment, as in the first, will depend upon the condition of the gland.

*Third.* The pancreas may be taken from an animal in full digestion, minced, and rubbed up in a mortar with powdered glass. For each gramme of gland-substance, one cubic centimeter of 1 per cent. acetic acid should be added and mixed thoroughly in a mortar for ten minutes, and then ten times its volume of glycerin added, and the whole allowed to stand for three days. This preparation will contain a much larger proportion of proteolytic ferment than was obtained by either of the preceding processes, since the acetic acid seems to possess the power of converting into ferment the zymogen, or the substance which yields the proteolytic ferment.

(a) *Action on Carbohydrates.*—Valentin pointed out that the pancreatic juice was capable of converting starch into sugar, and nearly all that was stated with regard to the action of saliva on starch might be repeated for the case of the pancreatic juice, with the single modification that in the case of the pancreas the amylolytic power possessed by its secretion is much stronger than that of the saliva. The secretion and watery extract of this gland in both herbivora and carnivora, as well as the secretion obtained from this gland in birds (chicken and goose), rapidly convert starch into sugar. All the conditions which were found to prevent the action of the saliva also hold here, with the single exception that a slight degree of acidity seems rather to favor the action. The ferment through whose action the pancreatic juice is enabled to convert starch into sugar is apparently formed in the gland-tissue by the transformation of some previously existing material; since it has been found that if the ferment is completely extracted from a fresh gland by glycerin, and the inactive residue allowed to remain on the filter for five or six hours exposed to the air, a further production of ferment occurs. This new formation may be again extracted by water or glycerin. That this result is really due to the new formation of ferment, and not to the occurrence of decomposition, is proved by the fact that if the watery extract of the pancreas is once deprived of its action on starch by boiling, this power never returns in any stage of the subsequent decomposition. So, also, a gland which has been exposed for twenty-four hours to the air is more active than a fresh gland. The amount of starch which by the action of pancreatic diastase is converted into sugar is almost infinite. Roberts has calculated that pancreatic diastase is able to transform into sugar and dextrin no less than forty thousand times its own weight of starch. The rapidity with which starch is converted into sugar depends upon the proportion of ferment brought to act upon it. So that all grades of activity may exist between the apparently instantaneous conversion of a small amount of starch with a large amount of ferment, and the slow and gradual action of a small amount of ferment on a large quantity of starch. The products which result from the action of pancreatic ferment on starch are entirely analogous to those which result from the action of ptyalin or malt-diastase on starch. When the gland-tissue is itself brought into contact with soluble carbohydrates, lactic acid fermentation ultimately results. Glycogen is also rapidly converted into sugar under the action of pancreatic diastase. Inulin and cane-sugar are entirely unaltered by it. The amylolytic action of the pancreatic juice is said to be absent in newborn children, appearing first after the termination of the second month.

(b) *Action on Fats.*—In the small intestine the fats, which have been seen to almost entirely escape the action of the gastric juice, are broken

up into a state of emulsion, while a small quantity undergoes chemical changes, in which fatty acids are liberated. The fatty acids thus liberated combine with the alkaline bases of the bile and pancreatic juice to form soaps. If oil, butter, or lard is stirred with pancreatic juice at a temperature of  $35^{\circ}$  or  $40^{\circ}$  C., almost immediately a thick, creamy emulsion is formed which will stand for a long time. The presence of gastric juice, even when in sufficient amount to neutralize the alkalinity of the pancreatic juice, is stated by Bernard to have no influence on the emulsifying property of this secretion; but to produce it in its highest degree the secretion must be normal, and that obtained from permanent fistulae is much less efficacious than that from temporary fistulae. This emulsifying power possessed by the pancreatic juice is due to the specific action of a special ferment, termed generally the emulsive ferment, which is claimed by Bernard to first emulsify and then saponify fats. It is certain that in the small intestine the principal change is merely due to the production of an emulsion, and nearly all the fat taken up by the absorbent vessels of the small intestine is in the form of an emulsion and not of a soluble soap, although both changes do occur in the small intestine; the saponification is, however, most marked after the fats have been absorbed. The emulsive ferments, it has been claimed by Paschutin, may be readily extracted from the pancreas by a solution of bicarbonate of sodium, and this solution will readily emulsify fats. It is doubtful as to what importance is to be attached to this statement, since it has been already stated that a solution of bicarbonate of sodium constitutes an extremely delicate test for the presence of fatty acids, and when such acids are present the addition of the bicarbonate of sodium will almost instantly form a permanent emulsion. Since, therefore, it is almost impossible to obtain fats which are absolutely free from the presence of fatty acids, the above statement is not by itself sufficient to prove that the emulsifying power of pancreatic juice is due to the action of a specific ferment. Other proof is, however, found in the fact that the action of fresh normal pancreatic juice on neutral fats does result in the development of free fatty acids and glycerin. This result may even take place when the pancreatic juice has been diluted with twelve times its volume of water; and although gastric juice and hydrochloric acid seem to interfere with this action of the secretion, the bile appears to facilitate it. Just as we found that the solution of fibrin with acid in contact with peptic glands was a reliable test for the presence of pepsin, so also the power possessed by the pancreas of decomposing fats and forming fatty acids and glycerin serves for the recognition of the pancreas in lower animals, and, as employed with this object in view, has been highly perfected by Bernard.

The emulsive action of the pancreatic juice is destroyed by boiling, and the digestive action on fats through the influence of pancreatic

juice is, therefore, of two kinds. Mechanically, it forms an emulsion with the oil, while chemically it liberates the fatty acids with glycerin, the formation of the emulsion being largely the result of the liberation of fatty acids.

(c) *Action on Proteids.*—The action of pancreatic juice on proteids coincides with that of gastric juice in so far that in both cases the conversion is due to a ferment which is destroyed by heat, and that both secretions convert proteids into peptones. Many points of contrast, however, exist. In the first place, it was seen that gastric digestion required the presence of dilute hydrochloric acid. In the case of pancreatic digestion it will be found that a half of 1 per cent. solution of sodium carbonate produces the most active results. If a fragment of thoroughly boiled fibrin is placed in an artificial pancreatic juice, made by adding a few drops of the glycerin-acetic acid extract to a 1 per cent. solution of sodium carbonate, it will ultimately dissolve, but the process will differ from that occurring in gastric digestion. After having remained for an hour or two in contact with the pancreatic juice, the fibrin will at first appear to be unaltered, but if it is stirred with a glass rod, many small fragments dissolve, and on removing some of the larger pieces and washing them with water, they are seen to be corroded and as opaque as before, but not swollen and transparent, as would occur in an analogous stage of gastric juice. Besides these superficial changes, however, the properties of the fibrin have been considerably modified. Undigested boiled fibrin is entirely insoluble in dilute acid, and if this boiled fibrin, which has been partially digested by pancreatic juice, is placed in a two-tenths of 1 per cent. solution of hydrochloric acid, it will be rapidly dissolved, and form a solution of syntonin, which may be precipitated by neutralization. Before being dissolved, therefore, boiled fibrin is rendered by pancreatic juice more soluble in dilute acid than even raw fibrin, which, as is well known, will not dissolve for many hours.

Again, in this stage of pancreatic digestion, the boiled fibrin becomes soluble in a 10 per cent. solution of sodium chloride, and is readily coagulated by nitric acid and boiling; it thus appears that the first step in the pancreatic digestion of boiled fibrin is to change it to a soluble albuminoid, somewhat resembling raw fibrin.

Again, if the fibrin be allowed to remain in pancreatic juice until it has been dissolved, a precipitate may be formed on neutralization which is evidently of the nature of an alkali albuminate and analogous to the parapeptone formed in gastric digestion; while boiling will also produce a precipitate,—a phenomenon which is entirely unrepresented in any known stage of gastric digestion. Although, as already mentioned, an alkaline reaction appears to favor pancreatic digestion, nevertheless, it appears

that proteids may be digested in pancreatic infusions with a neutral or even faintly acid reaction; it even appears that in the case of the pig the pancreatic infusion is only active in digesting proteids when the intestinal reaction is acid.

As already mentioned, the pancreas is not under every condition capable of forming a secretion which will digest proteids, and under many circumstances infusions of the pancreas will be entirely inert on proteids. This would seem to indicate that while trypsin, or the proteolytic ferment, is formed in the cells of the pancreas, it is preceded by another substance termed zymogen, which is gradually in the normal conditions of the gland converted into trypsin. In support of this statement it may be mentioned that the pancreas obtained from the slaughterhouse or from fasting dogs is often inactive, while the most activity is present about four or seven hours after feeding. It is supposed that the zymogen, which is soluble in water and glycerin, and which is found in the inner zone of the secretory cells, is, through the gradual action of oxygen, converted into trypsin. This conversion normally occurs in the interior of the gland during digestion, but even inactive glands may develop trypsin through exposure to the air after death or by the action of dilute acetic acid.

Schiff and Herzen claim that there is a close connection between the action of the spleen and the development of trypsin, and they claim to have demonstrated that the pancreas of an animal from whom the spleen has been removed is incapable of digesting proteids, and that if such a pancreas be rubbed up with a portion of spleen it will then acquire the power of digesting proteids. This statement, however, needs further confirmation.

When the pancreatic digestion of proteids is prolonged, in addition to peptones, various other bodies make their appearance. Leucin and tyrosin appear in large amounts, with traces of asparaginic acid, xanthin, and a body which is colored red with chlorine- or bromine-water. The longer the pancreatic digestion is prolonged, the larger will be the amount of leucin and tyrosin present and the smaller the amount of peptone; from which it would appear that these crystalline substances result from the gradual breaking down of the peptone itself.

Kühne explains this result by supposing that the albuminous bodies under the action of trypsin become converted into two forms of peptone, to which the terms respectively antipeptone, which does not undergo further change, and hemipeptone, the latter in normal digestion being converted into leucin, tyrosin, etc., and readily undergoing putrefaction, resulting in the formation of indol, skatol, and phenol.

If a pancreatic digestive mixture be neutralized so as to precipitate alkali albumen, and then treated with an excess of alcohol, the greater

part of the peptone will be precipitated. If the alcoholic fluid be then acidulated with acetic acid, boiled, and filtered, leucin and tyrosin will separate when the filtrate is concentrated by evaporation. By heating this deposit with water, the leucin, which is readily soluble in water, may be separated from the tyrosin, which is not so soluble.

*Leucin*, or amido-caproic acid ( $C_6H_{13}NO_2$ ), belongs to the fatty bodies, and is a constant decomposition product of albumen and various nitrogenous substances. Leucin occurs in the form of white, shining lamellæ, which are insoluble in ether and chloroform, readily soluble in alkalies and acids, especially when hot. It readily crystallizes from its solutions in hot water in spherical masses, composed of groupings of thin, white, glistening needles. When a few crystals of leucin are placed on platinum-foil and evaporated gently with a drop of nitric acid, if a few drops of caustic soda are added to the colorless residue a yellow or brownish mass is obtained, which forms an oily drop. (Seherer's test.)

If a dilute solution of leucin is boiled with eupric hydrate in excess, bright violet scales are deposited on cooling.

*Tyrosin* ( $C_9H_{11}NO_3$ ) is a member of the aromatic group, and may be obtained from almost any proteid under the action of strong oxidizing agents. It remains in the deposit of pancreatic digestion of albuminoids, prepared as above, after the leucin has been removed. By dissolving this residue in hot water, and rapidly crystallizing by the addition of ammonia, tyrosin may be obtained in tolerable purity. It then occurs in the form of fine, white, silky needles, generally arranged in sheaf-like bundles, which dissolve in hot dilute ammonia, and are deposited on cooling the solution in brilliant, colorless, radiating stars. It is insoluble in absolute alcohol and ether, almost insoluble in cold water, and slightly soluble in hot water, but readily soluble in the mineral acids and in warm dilute ammonia.

If a hot, watery solution of tyrosin is treated with a few drops of Millon's reagent to boiling, a dark-red color appears, and when the solution is concentrated deposits a dark-red precipitate. (Hoffman's test.)

The application of Seherer's test, as in the case of leucin, will form a reddish-yellow residue, which will become brown on the addition of caustic soda.

In the small intestine the pancreatic juice never alone comes in contact with food-stuffs, but it meets with undigested matters mixed with the results of gastric digestion, and therefore with the acid gastric juice and bile.

In the animal economy, therefore, the activity of the pancreatic juice must be different from that which has been stated as occurring outside of the body, when the operation of the pure pancreatic juice is alone considered.

When the acid chyme from the stomach reaches the small intestine, the alkalinity of the bile, pancreatic and intestinal secretion, to a certain extent, partially neutralizes the acid of the gastric juice.

It has been found that when pancreatic juice is mixed with gastric juice, the activity of the resulting medium will depend greatly upon the relative proportions of these two fluids. As a rule, gastric juice, by digesting trypsin, renders the pancreatic secretion entirely inert. The process occurring in the duodenum is, however, somewhat different: for we have already found that the first effect of the bile is to precipitate pepsin, and therefore the pancreatic ferment comes into contact with

the acid constituents alone of the gastric secretion, which, as has been already mentioned, has but slight degree of acidity, and does not interfere with pancreatic digestion.

The bile, on the other hand, while disturbing gastric digestion, considerably assists the action of the pancreas, not only in facilitating the emulsification of fats, but apparently also in some way aiding the solvent action of the pancreas on proteids. The pancreas, in addition to the three ferments already described, is also said to contain a ferment which coagulates milk, which may be extracted from the gland by means of a concentrated solution of common salt, the ordinary solvent used in making rennet from the calf's stomach, and which in general is claimed to behave like the milk-curdling ferment of the gastric juice.

This ferment has been found in the pancreas of the pig, the sheep, the calf, the ox, and the fowl. The principal difference between the action of the milk-curdling ferment of the pancreas and that of the gastric juice lies in the fact that even 1 per cent. of sodium bicarbonate does not prevent coagulation in the former case, while one-fourth of 1 per cent. in the latter case does. The pancreatic rennet is also quite active in a neutral or even faintly acid medium. Boiling, as with other soluble ferments, destroys its power. It may likewise be precipitated by alcohol and again dissolved in water without losing its activity.

When a pancreatic digestive mixture is allowed to remain in contact with food-stuffs, it rapidly acquires a putrefactive odor, and swarms with microscopic organisms. Usually in eight hours a high degree of putrefaction has taken place. It is to be supposed that a similar state of affairs occurs in the small intestine, since the conditions are there favorable for the reproduction of bacteria; for it is scarcely possible to assume that the acidity of the gastric juice is sufficient to destroy the germs which we must suppose are constantly taken into the alimentary tract. A characteristic result of the putrefaction and decomposition of proteids is indol, to which the faecal odor of putrefying pancreatic secretion is due. When salicylic acid is added to pancreatic digestive mixtures, they remain free from odor, and the presence of indol cannot be detected. It therefore seems clear that indol is a result of putrefaction of the results of pancreatic digestion, and is not normally a digestive product. Nevertheless, the constant presence of indol in the small intestine would show that in this portion of the alimentary canal such putrefactive changes almost invariably result.

In addition to indol, putrefying pancreatic solutions will develop ammonia, carbonic acid, butyric acid, valerianic acid, acetic acid, phenol, sulphuretted hydrogen, carburetted hydrogen, and hydrogen,—gases which are also found in the alimentary canal.

While such putrefactive changes undoubtedly occur in the alimentary

canal, the extent to which these processes take place can be scarcely estimated; of course, the more proteid which is so broken up, the greater will be the nutritive loss to the economy, since such putrefactive products have no physiological value. It may, therefore, be assumed that it is only the excess of proteids which is so broken up, for under normal conditions it may be assumed that peptone is absorbed as fast as it is formed. In the case of the herbivora, whose long intestinal tract is nearly always filled with residue of food, this decomposing process will probably attain a higher degree than in the case of the carnivora. That the intestinal contents are comparatively free from putrefactive odor in these animals is not an objection to this statement, since it is always so largely composed of cellulose and other non-putrefactive substances.

It has been found that the amount of indican contained in the urine is a measure of the amount of putrefaction occurring in the intestine; and since indican is present in the urine of herbivora in about twenty-three times the amount found in the urine of man, it is evident that the putrefactive process in the intestinal canal of the herbivora must be also largely in excess. In addition to the fact that the proteids are rapidly absorbed as soon as acted on by the digestive secretions, the influence of the bile is also to be alluded to as a preventive of putrefaction.

3. *The Secretion of Pancreatic Juice.*—In the pancreatic secretion the digestive juices reach their maximum as regards intensity of action and variety of food-stuffs on which they act. Human pancreatic juice has never been obtained in a condition of purity, and were it not for the studies made on animals this branch of our subject would be an empty page. The volume of this gland, which is very constantly present and subject to a great variety of changes, is much larger in the carnivora than in the herbivora. In the herbivora the secretion is constant, in the carnivora it is intermittent, while in the ruminant its maximum activity appears to coincide with the end of rumination, when as much as two hundred to two hundred and seventy grammes may be secreted per hour. During fasting in the ruminant, although not absolutely suspended, its secretion is greatly reduced in amount. In the horse, from experiments made by Leuret and Lassaigne, Colin was able to determine that the maximum hourly secretion was two hundred and sixty-five grammes, or about the same as that of the ox, though part was probably lost by not tying the supplementary duets. As in the carnivora, so, also, in the herbivora, this gland is extremely liable to inflammation, which, of course, will affect the general result.

Another method by which the amount of pancreatic secretion poured out was estimated was to ligate the bile-duct and pylorus, then empty the intestine by pressure, and then to tie its lower extremity. In this way six hundred to one thousand grammes of clear, limpid fluid



were collected in an hour, though, of course, the fluid was not derived solely from the pancreas, but contained the secretion poured out by the intestinal glands.

The pancreatic secretion in the hog has certain characteristics which are readily determined. The fistula is made in the same manner as in the dog, and it is then seen that the hourly secretion is five to fifteen grammes, and that the activity of the pancreatic secretion is in inverse ratio to that of the bile.

In the carnivora the study of this secretion is most readily carried out. In the sheep it is open to difficulties, and has not been as thorough as in the dog. No ratio between the size of the animal or of the gland and the quantity of pancreatic juice is capable of demonstration. Thus, the pancreas of the horse and ox weigh each three hundred grammes; both animals are about of the same

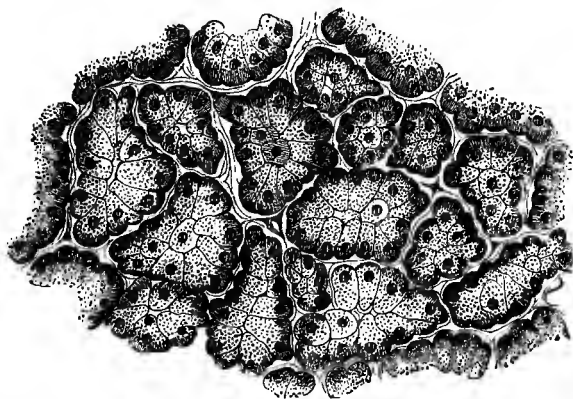

FIG. 161.—SECTION OF THE PANCREAS OF THE DOG IN THE FASTING CONDITION, HARDENED WITH ALCOHOL AND STAINED WITH CARMINE. (*Heidenhain.*)

size, and also secrete the same amount of pancreatic juice. In the sheep the pancreas weighs from fifty to sixty grammes, or one-fifth as much as in the large ruminants, and yet only pours out seven to eight grammes per hour. In the hog the pancreas weighs from one hundred and forty to one hundred and eighty grammes, and only secretes ten to fifteen grammes per hour. These results, of course, cannot be too positively accepted, on account of the many disturbing causes.

In the pancreas, as in other glands, we may distinguish a period of rest, during which the gland is pale and free from blood, and a period of activity, during which it is swollen and its vessels gorged with arterial blood. Changes occur, therefore, in the pancreas such as have been already described in the case of the salivary glands. In the carnivorous animals the secretion commences when the food is introduced into the

stomach and rapidly reaches its maximum two or three hours thereafter. Toward the fifth or seventh hour it decreases in activity, and about twelve hours after feeding again becomes increased in amount, the second increase being apparently coincident with the escape of the acid chyme into the small intestine. The cells of the pancreas also undergo marked histological changes during the period of active secretion. In the pancreas of a fasting dog two zones may be recognized, the inner zone highly granular in nature, and with difficulty stained with carmine, and a smaller homogeneous outer zone which readily stains red. The nucleus, which is generally irregular in shape, lies between these two zones (Fig. 161). If, on the other hand, a microscopic inspection be made of an animal in full digestion, the outer homogeneous zone will be found to have greatly in-

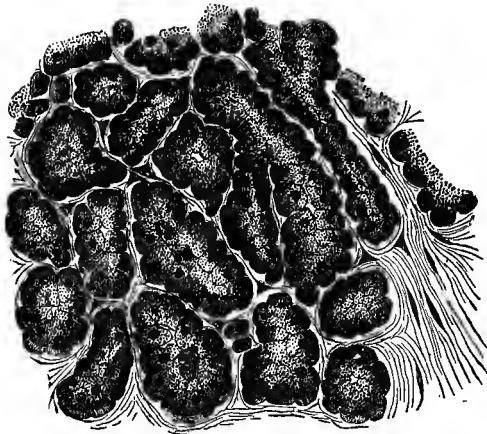

FIG. 162.—PANCREAS OF THE DOG IN THE FIRST STAGE OF DIGESTION. (*Heidenhain.*)

creased in extent, while the inner granular zone will be almost absent, the whole cell being smaller and readily stained with carmine (Fig. 162). After digestion has been completed, the appearance described in the fasting cell will be again regained (Fig. 163). It would appear from these facts that the secretion of the pancreatic juice is formed at the expense of the granular material found in the inner zone of the secreting cells, while these granules result from the amorphous homogeneous matter found in the external zone, and which during digestion is built up from the matter taken from the blood. We have already alluded to the fact that to obtain an active pancreatic extract the gland must be taken from an animal in full digestion, and that if the gland of a fasting animal be rubbed up with glycerin and acetic acid, the glycerin extract from such a gland will be strongly proteolytic. These results are to be explained,

as already mentioned, by the fact that the gland itself contains but little ready-formed proteolytic ferment, but a substance termed zymogen, which, from exposure to the atmosphere, or under the action of dilute acid, is readily converted into ferment.

Heidenhain has determined that the amount of zymogen in the pancreas coincides in amount with the extent of the granular zone; therefore, in pancreatic secretion, as in the case of saliva, the act of secretion possesses two phases: the first, the preliminary stage of separation from the blood; the second, the stage of manufacturing of those constituents into the specific ferments of the secretion.

As regards the action of the nervous system on the secretion of

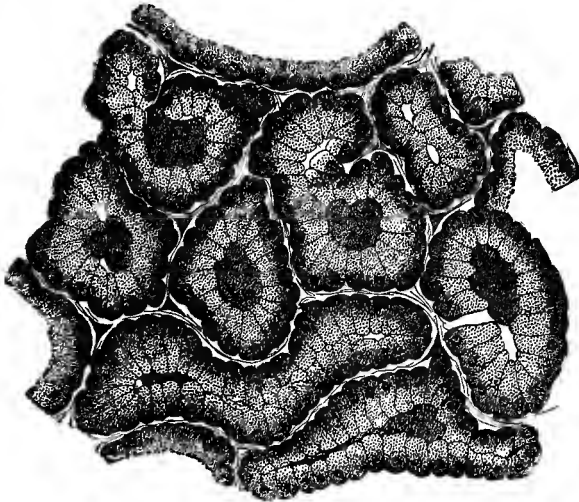

FIG. 163.—PANCREAS OF THE DOG IN THE SECOND STAGE OF DIGESTION. (*Heidenhain.*)

pancreatic juice but little is known. Both section and stimulation of the central end of the pneumogastrics temporarily arrest the flow of pancreatic juice; vomiting also has the same effect, the result being probably due to the stimulation of this nerve. Stimulation of the gland itself by an induction current, as well as stimulation of the medulla oblongata, seems to produce an increase in the secretion, but section of the spinal cord does not raise it. When all the nerves going to the pancreas are divided, a continuous flow of pancreatic juice commences, and under these circumstances the fluid formed has but slight digestive power, and its amount is not influenced by the taking in of food. Injections of ether into the stomach produce an increased flow of pancreatic juice, while the secretion is suppressed in the dog, though not in the

rabbit, by the action of atropine and by stimulation of the sensory nerves.

The pressure under which the pancreatic juice is secreted is not much higher than that of the bile, amounting only to about seventeen millimeters of mercury.

III. THE INTESTINAL JUICE.—In addition to the fluids poured out by the liver and the pancreas, the walls of the small intestine are also abundantly supplied with glands, which pour out a secretion which possesses a certain digestive value. The largest amount of this fluid is poured out by the so-called duodenal follicles, or glands of Lieberkühn, to which is added the scanty secretion of the small, convoluted, tubular Brunner's glands. The latter are morphologically identical with the glands of the pylorus and stomach, and their cells are turbid and small during hunger, while during digestion they are large and clear. In the sheep the Brunner's glands form a continuous layer and their walls pour out a fluid containing mucin and ferments which possess the power of dissolving proteids and of converting starch into sugar. Any data as to the action of the secretion formed by these glands are, however, obtained with the greatest difficulty on account of the smallness of the glands and impossibility of isolating their secretion; consequently, the greatest uncertainty surrounds their functions.

The glands of Lieberkühn are small, tubular glands set vertically in the mucous membrane and are lined by cylindrical epithelial cells, among which numerous goblet, mucous cells may be found. These cells, apparently, are the main source of intestinal juice, the so-called *succus entericus*.

Various methods have been proposed for obtaining the fluid poured out by these glands. Thiry's method was to withdraw a loop of small intestine from the abdomen, and excise a portion several inches in length, leaving its blood supply intact, and then restoring the continuity of the intestine by stitching together the ends above and below where the excised portion had been removed. One end of the excised portion was then closed by stitches, while the other extremity was kept open and stitched into the abdominal wall. By this means a small portion of the small intestine was isolated, and as it communicated with the exterior the secretion which it formed could be readily collected. Vella improved the method employed by Thiry by leaving both ends of the isolated portion open, after restoring the continuity of the bowel, and stitching them to the abdominal wound. It is evident that after this operation the small intestine cannot be regarded as being in its normal condition, for it is entirely removed from contact with the secretions and chyme, and undergoes a considerable amount of atrophy; and although its secretion is not contaminated by any other digestive fluid, it cannot be regarded as being in a normal condition.

Colin collected a considerable amount of fluid by placing a clamp on the small intestine of the horse and emptying a considerable portion below it by gentle pressure, and then clamping it several feet below the upper clamp. In this way he obtained from eighty to one hundred and twenty grammes of fluid in half an hour from two meters of the small intestine of the horse. He states, however, that this fluid may be greatly increased by the injection into the loop of a solution of aloes, manna, or soda; and since its composition coincides almost exactly with that of blood-serum, it is probably an exudation. No reliable experiments seem to have been made as to the digestive properties of the fluid obtained in this way.

Moreau has also succeeded in obtaining a large quantity of liquid by clamping the intestine, as in Colin's method, and then dividing the nerves going to the isolated portion of the intestine. In this operation, also, it is probable that the fluid is an exudation, as it coincides almost entirely with blood-serum in composition; and here also no experiments as to its digestive powers have been made.

The author has employed a method for collecting the secretion of the small intestine which is free from most of the objections which may be urged against the methods already described. A fistula is made into the duodenum in the same way as in making a gastric fistula, and a small tube inserted. The operation is readily performed, but in a large number of animals so treated the tube will tear out of the intestine, and the experiment will consequently fail. When the wound has healed the dog should be allowed to fast for at least twenty-four hours, and then the intestine washed out by an injection of lukewarm water through the cannula. A rubber bulb is then to be inserted through the tube into the small intestine and pushed back toward the stomach, taking care, however, that it lies below the opening of the pancreatic and bile ducts; it then may be distended by water so as to occlude the intestine, and a small bulb with a long tube is then pushed down the intestine and distended with water so as to occlude it below.

In this way a variable portion of small intestine is shut off from the contents of the alimentary canal above and below, and its secretion in a state of comparative purity, and in considerable amount, may be then collected.

Obtained in this way, the intestinal juice has an alkaline reaction; its specific gravity, 1010; it gives no coagulum on boiling, and yields Millon's reaction, and deposits a heavy precipitate when thrown into absolute alcohol. Its composition in one hundred parts is as follows: Water, 98.86; organic matter, 0.54; inorganic matter, 0.59. The inorganic matter is represented by chlorides and sulphates and carbonates of sodium and potassium. With chlorine-water no red is given, and in

certain instances it has been found to turn acid on standing. As regards its digestive action, it contains three ferments, which may be precipitated by alcohol and again redissolved in water. It will rapidly convert starch into sugar in a neutral or faintly alkaline medium, while 2 per cent. of acid and 5 per cent. of liquor potassa will prevent it. This has also been established by Ellenberger and Hofmeister to apply to the intestinal secretion of the horse. There is a special ferment present which will convert cane-sugar into invert-sugar, or a mixture of lævulose and dextrose. This is the only secretion in the body which possesses this power. The transformation of cane-sugar into invert-sugar is represented in the following formula :—

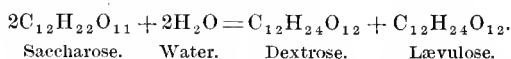

The inversive ferment has been found by Bernard in the small intestine of dogs, rabbits, birds, and frogs. Roberts has recognized it in the small intestine of the pig, the fowl, and the hare, while Balbiani has found it in the intestine of the silk-worm. It is absent from the large intestine. When a watery infusion is made of the mucous membrane of the small intestine, it possesses the power of inverting sugar, but loses it when the infusion is filtered, seeming to indicate that the ferment remains attached in such infusions to some of the formed elements contained in the intestine. It is, however, possible to precipitate the ferment from intestinal juice, and then obtain a watery solution of the precipitate which will invert sugar. The intestinal juices will also dissolve proteids, albumen, and fibrin, and convert them into peptone, after first passing through a stage similar to that of alkali albumen. The action of the intestinal juices resembles that of the pancreatic secretion in its general characters and in the resolution of the fibrin peptone into leucin and tyrosin and indol. The ferment which is concerned in the digestion of proteids is apparently either not carried down by the alcohol, or is not capable of resolution in water, for all the author's experiments failed in obtaining an active solution of the ferment in water, acid, or alkali after precipitation with alcohol. When fibrin is digested by the intestinal juices, a peculiar substance is formed, which gives a red with nitric acid, the color disappearing on heating.

IV. FERMENTATION PROCESSES IN THE SMALL INTESTINE.—In the small intestine are found numerous examples of the lower organisms which enter the alimentary canal through the foods and liquids which are swallowed, and which induce various fermentations and putrefactions in the contents of the alimentary canal, resulting in the evolution of various gases. These gases consist, in the first place, of air, which is swallowed with the food, of which a large portion of the oxygen is

absorbed, while the nitrogen remains unaltered. Therefore, the oxygen will be in smaller relative proportion, as contrasted with the nitrogen, than is found in the atmosphere; the carbon dioxide, which is also present, will, on the other hand, be in relative excess, since a certain quantity of this gas diffuses from the venous blood into the interior of the alimentary canal. Hydrogen, ammonia, and carburetted and sulphuretted hydrogen are also found as the results of various decompositions.

V. **INTESTINAL DIGESTION IN DIFFERENT ANIMALS.**—The contents of the stomach do not pass suddenly, but gradually, into the small intestine, their entrance into this portion of the alimentary canal not being due to the forcible contraction of the stomach, but to a series of periodic relaxations of the pylorus, as a result of special stimuli; during the intervals, the pylorus is tightly closed. Transition into the intestine rarely occurs before digestion has made considerable advances; the necessary stimuli, therefore, cannot be of a purely mechanical nature, especially as it has been found that mechanical stimuli lead to more marked contraction of the pyloric ring rather than to its relaxation. The stimulus which leads to a relaxation of the pyloric sphincter is probably of a chemical nature, but its exact mode of operation is entirely unknown. It would seem, however, that fat is almost incapable of causing an opening of the pylorus, for, no matter how much fat be given in the food, nearly the same amount will be found in the intestine after four, five, or twenty-one hours, showing that the pylorus allows no more to pass than may be taken up by the villi; therefore, there is never an accumulation of fat in the intestine.

If, during the latter stage of gastric digestion, a transverse section is made through the duodenum, on the mucous surface will be found a white, pasty emulsion; then comes a yellowish, cheesy precipitate, produced by the bile, and in the centre will be found a thin, yellowish-brown liquid, containing particles of undigested food. If such a section be made still lower down in the intestine, further from the stomach, the fatty layer will be found to have decreased in amount, while the central fluid will be relatively more abundant, and becomes darker and darker in color, until at the lower portion of the small intestine it is of a deep-green color. Some of the fluid constituents contain many gas-bubbles. The central fluid has always a more strongly acid or less alkaline reaction than the portion of the intestinal contents in contact with the intestinal walls.

As we have seen, the chyme, as it issues from the stomach, is subjected to the action of the intestinal secretions before being ready for absorption. The character of the chyme, as indicating the character of the digestive processes, varies in different animals, and has been closely studied by Colin, whose description is here mainly followed. In

carnivora the chyme is scanty, gradually giving up matters ready for absorption, and passes slowly through the intestine. Thus, seven to eight hours after a meal of one thousand grammes of meat, only fifty to one hundred grammes represent the weight of intestinal contents. The small intestine in carnivora is never distended, as in the case of the omnivora, and especially the herbivora, but it is always a flattened cylinder. The stomach appears to regulate the amount which passes into the small intestine. The small intestine in non-ruminant herbivora, as the horse, receives large volumes of chyme from the stomach, and rapidly disperses it through the entire small intestine; but although the small intestine has a capacity four times as great as the stomach, it never contains as much as may be contained in the stomach when distended, for after a meal the contents of the stomach are rapidly distributed between the small intestine, stomach, and cæcum. If the contents of the small intestine of the horse be examined at various intervals after feeding, it will be found that 40 to 50 per cent. of the carbohydrates in the food have been digested in the stomach, while 30 to 50 per cent. of the albuminoids and 40 to 60 per cent. of the non-nitrogenous constituents may still be recognized.

In the horse, the fluid found in the duodenum and jejunum is usually acid in reaction, yellowish in color, turbid, and viscid. It is capable of digesting proteids and starch, and its ferments may be precipitated by alcohol and redissolved in water without losing their activity. In the ileum the contents are usually alkaline in reaction, brownish-yellow in color from the bile-pigments, turbid, but contain less mucin than the duodenal contents. Intestinal digestion in the horse is of considerable importance; only from 23 to 52 per cent. of undigested albumen and from 38 to 59 per cent. of undigested carbohydrates are to be found in the duodenum, although there can be no doubt but that large amounts of entirely undigested food pass from the stomach into the small intestine. When the food has a prolonged sojourn in the stomach but 2 to 10 per cent. of its proteid constituents may be left untouched for digestion by the intestinal secretions, but where this is not the case it may be safely stated that at least 60 per cent. of the proteids have to be digested in the small intestine. These facts would seem to indicate that in solid-pedes digestion is almost continuous. In ruminant herbivora the state of affairs is different; there, the contents of the intestine only represent one-eighth to one-tenth the amount contained in the stomach, and when rumination is suspended but a comparatively small part of the food remains unchanged to be acted on by the intestinal secretions. In carnivora, still another state of affairs occurs. The stomach holds almost all the alimentary matter, only small quantities of liquefied chyme passing into the intestine, and as the gastric digestion in these animals is



very complete the contents of the small intestine amount to only one-tenth or one-twentieth of the gastric contents. Aliments more or less liquefied, according to the quantity of fluid contained in the alimentary tract, present a different character in each portion of the intestinal tube. In solipedes, for example, in the small intestine they are mixed with a thick, yellowish, viscid fluid; in the cæcum they are suspended in a large amount of fluid not deprived of viscosity; in the great fixed colon they are still soft, but as the floating colon is approached they acquire progressive dryness and are moulded into balls, which stick to the valvulæ conniventes.

The bile of the hog, as has been mentioned, contains no amylolytic ferment, but is capable of emulsifying rancid fats. The intestinal juice, according to Ellenberger and Hofmeister, contains a diastatic but no other ferment, a statement which, in view of the general presence of the invert ferment in the secretion, needs confirmation. The pancreatic juice contains three ferments, and is, therefore, possessed of the same properties as in other mammals. Consequently, in the intestinal canal of the hog, albuminoids are peptonized, starch converted into sugar, and fats digested and emulsified. Absorption in these animals is exceptionally rapid, so that examination of the intestinal contents will reveal but small amounts of digestive products. Peptone, especially, seems to be absorbed as rapidly as it is formed, while 69 to 75 per cent. of the albuminous food-stuffs and 65 to 72 per cent. of the carbohydrates found in the small intestine has been digested.

The reaction of the small intestine of the hog is usually acid throughout half its extent, the acidity sometimes extending through five-sixths its length.

After feeding, the first portions of the meal appear in the small intestine in from three to four hours, while three hours later a portion of the intestinal contents has already reached the cæcum. Intestinal digestion, therefore, in the hog is of but short duration.

One is accustomed to speak of the reaction of the small intestine as self-evidently alkaline, and it is almost universally taught that as soon as the acid chyme enters the duodenum its acid reaction, through the influence of the bile and pancreatic juice and intestinal secretion, at once passes into an alkaline reaction. This, however, is an error. As a rule, an alkaline reaction is rarely met with until the very lowest portion of the ileum is reached. It has been already mentioned that the acid chyme produces precipitation in the bile, the glycocholate of sodium, glycocholic acid, and mucin being carried down, while the acid reaction is still maintained, and that this precipitate carries the pepsin mechanically down with it. The importance of this is seen when it is remembered that in acid solutions pepsin will destroy the pancreatic ferments.

The pepsin is only released when the strongly alkaline reaction of the lower portion of the small intestine dissolves the bile precipitate. It can then do no harm, as pepsin is inactive in alkaline solutions; while, on the other hand, the acid does not interfere with the pancreatic digestion, since the pancreatic ferments are still capable of producing their characteristic effects, even in a faintly acid medium.

The acid reaction of the small intestine is most marked in carnivorous animals, and in them, consequently, putrefactive and fermentative changes occur to a less degree than in omnivora and herbivora. In the fasting horse the contents of the small intestine are invariably alkaline, this reaction being more marked the greater the distance from the stomach. In digesting animals, the acid reaction decreases below the point of entrance of the bile and pancreatic juice, and becomes decidedly alkaline at the lower portion of the small intestine. This holds in the horse, ox, and sheep, whether fed on dried or green fodder, on oats, grain, or roots. The cause of the alkalinity of the reaction of the intestinal contents is due to the bile, pancreatic juice, and intestinal secretions, and is more marked the more active is intestinal digestion. The acidity of the intestinal contents when present is due not only to the acid gastric juice, but also to the liberation of fatty and lactic acids from lactic and butyric acid fermentations.

It is seen from the above that in the small intestine secretions are met with which are capable of establishing digestion of the various food-stuffs, so as to render them capable of absorption. Starch becomes converted into sugar through the action of the pancreatic and intestinal secretions; cane-sugar is converted into invert-sugar through the action of the special ferment of the intestinal secretion; fats are partially saponified and emulsified through the influence of the bile and pancreatic juice, while albuminoids, through the influence of the pancreatic and intestinal fluids, are turned into peptones.

As regards the changes which occur in albuminoids in the small intestine, it is worthy of note that in all probability the formation of leucin and tyrosin has been greatly overestimated, for since the intestinal juices are almost always acid, and since leucin and tyrosin only form in alkaline digestive juices, perhaps these bodies never form normally in the intestine. It is, at any rate, certain that but mere traces of leucin and tyrosin are to be found in the intestinal contents during digestion of large amounts of albumen. It is also worthy of note that the acid reaction of the intestine does not interfere with the digestion of fats, for the lacteals will be found filled with a milky emulsion after feeding, even though the reaction of the intestinal contents is almost as acid as the gastric juice.

At the lower end of the small intestine the reaction of the intestinal

contents is usually strongly alkaline, and we have then to deal with processes which are evidently putrefactive in nature. But a small portion of the nutritive parts of food will, however, be subjected to these changes, since probably digestion, especially in carnivora and ruminants, is completed before this portion of the tract is reached. Indol and phenol are here found, and result from the putrefactive changes in albuminoids, while lactic acid, butyric acid, acetic acid, carbonic acid, and hydrogen are met with and result from changes in carbohydrates. The different gases found in the small intestine have been already mentioned; their character and amounts vary according to the nature of the diet.

The following table represents their relative amount from different diets in dogs:—

	CO <sub>2</sub> .	N.	H.	O.
Meat diet, . . . . .	40.1	45.5	13.9	0.5
Bread diet, . . . . .	38.8	54.2	6.3	0.7
Vegetable diet, . . . . .	47.3	4.0	48.7	..

#### X. DIGESTION IN THE LARGE INTESTINE.

The absorption of all the alimentary elements which are essential to nutrition is in the carnivora achieved in the small intestine. In these animals the cæcum is absent or rudimentary, and the colon is short and apparently uncomplicated; but in the immense cæcum of solipedes and certain other herbivora the digestive process goes on, and the changes which the food undergoes in this part of the alimentary tract now deserve attention.

1. THE FUNCTIONS OF THE CÆCUM.—The cæcum, or blind gut, is that portion of the large intestine which usually occurs as a diverticulum at the point of junction of the small and large intestines, and in which the contents of the former empty. In man and carnivora this reservoir is rudimentary, and receives the alimentary mass after all its nutritive properties have been extracted. In this class of animals, therefore, the cæcum can have no physiological function to fulfill. In reptiles, batrachians, and the fish the small intestine is directly continuous with the large intestine, scarcely increasing in diameter, and no cæcal appendage is present, the reservoir only being represented by a long, lateral dilatation. It is only in mammals and in birds that one or two pouches are found at the point of union of the small and large intestines, and which furnish a new reservoir to the alimentary matters before permitting them to enter into the large intestine to be finally expelled.

In birds, the cæcum varies in development and importance according to their normal diet. In the flesh-eating birds, the stomach and small intestine are amply sufficient to produce the necessary chemical transformations in the food to render it capable of being absorbed. Their

cæca are consequently rudimentary or absent. In vegetable-eating birds, on the other hand, the cæcum acquires a high degree of importance. The cæcal apparatus in these animals is double, and consists of two long tubes, symmetrically located to the right and left, and connected with the alimentary canal at the point of junction of the small and large intestines. Their mucous membrane is arranged in folds, so as to increase their internal surfaces. Their internal surface is supplied with glands, which secrete a fluid, and with villi, which facilitate absorption. While it thus would appear that in these animals, as we find it the case in mammals, the development of the cæcum is in proportion to the complexity of the food, there are, nevertheless, certain exceptions to this rule. In the nocturnal birds of prey the cæcum is highly developed. This is, perhaps, to be explained from the fact that it acts as a compensation to the extreme shortness of the intestinal canal in this species. On the other hand, in the gallinaceous birds the cæcum is voluminous, and yet in the pigeon it is entirely absent. This latter fact is, perhaps, to be explained by the statement that in the pigeon the starchy matters are completely digested before the cæcum is reached, while such is not the case in the gallinaeæ. Moreover, in the pigeon the crop is double, so, perhaps, acting as a substitute for the cæcum. In mammals, also, the cæcum varies in importance according to the character of the substances with which they are nourished. In carnivora, such as the dog and cat, whose foods are readily digestible and assimilable, the cæcum is absent or rudimentary. Its structure is analogous to the large intestine; that is to say, this organ forms part of the excretory portion of the alimentary canal. The herbivora, on the other hand, find their food in substances which are poor in nutritious principles, and in which the nutritive matters are inclosed in resisting cellulose envelopes. As a consequence, we find the digestive apparatus in these animals reaching a high degree of perfection. Their apparatus of mastication is complete; their salivary secretion abundant. Their intestine is extremely long and of considerable volume, so as to multiply the secretory and absorbent surfaces and prolong the action of the digestive juices.

We find in the ruminants a complex and voluminous stomach, where the food is delayed for a considerable time before being subjected to the action of the solvent juices: but in the horse and rabbit the stomach is simple and small, and we find in the highly developed cæcum a substitute for the voluminous gastric pouches of the ruminant. In these animals the cæcum takes on the form of an immense pocket, whose length may exceed that of the body, and whose capacity may be two or three times greater than that of the stomach, while its volume is so great as to cause it to occupy the greater part of the abdominal cavity. In structure, also, the cæcum no longer resembles that of the

larger intestine, but more nearly approaches that of the small intestine. In it are found numerous folds of mucous membrane, villi, glands and follicles, and large lymphatics.

Comparative anatomy thus shows that in all animals whose diet is composed of substances difficult to digest and rich in cellulose, the cæcum is highly developed, if some other organ is not specialized for this purpose, as in ruminants. While its volume is proportionate to the volume of food which these animals require for their nourishment, while it is absent in the sable and those of the bear tribe which nourish themselves on fruits or substances easily digested, and while it is slightly developed in the carnivora and herbivora which feed on tender plants, it is highly developed and acquires a value closely allied to that of the stomach in animals whose ordinary food is composed of bulky vegetable substances difficult to digest. Such a state of affairs is seen in most of the rodents. It reaches its maximum development in the solipedes, the rhinoceros, and some herbivorous marsupials. Its development, again, is not only dependent upon the degree of the digestibility of the food, but it is inverse with the size of the stomach (hence its great size in solipedes) and with the presence of special organs to facilitate gastric digestion (hence its small size in ruminants). In cases, therefore, where we have a voluminous stomach provided with an extensive mucous membrane and followed by a long small intestine, we may be sure the cæcum will be poorly developed. These facts prove that the cæcum is a compensatory organ to the stomach, and that the development of the two is in inverse ratio.

Apart from the œsophageal dilatations of the ruminant, we have certain other animals in which annexes to the alimentary tube serve to assist in the digestion of almost indigestible food. These annexes may replace the œsophageal pouches and cæcum. Thus, we have in birds the crop, analogous to the ruminant's pouches, highly developed in pigeons, chickens, and geese, with the addition of a muscular, crushing stomach. In these birds, with the exception of the pigeon, the cæcum is also present, and all together are needed for the digestion of foods. Here the apparatus of mastication is absent. The crop, gizzard, and cæca all fulfill the same end. In the solipedes, again, the cæcum therefore fulfills the same general functions as the pouches of the ruminant's stomach, which again are analogous to the crop of the gallinaceous birds.

Most of the earlier physiologists regard the cæcum as a second stomach from some obscure analogy of form, and from the fact that its contents were said to be almost invariably acid. This theory as to the analogy of the functions of the cæcum and stomach held until it was discovered that the glands of the cæcum, instead of secreting an acid fluid, poured out an alkaline secretion like that coming from the glands

of Lieberkühn ; but just as the cæcum is the recipient of the contents of the ileum, and this often has an acid reaction, so may the contents of the cæcum be acid, especially in carnivorous animals, a fact which may serve to illustrate the error of applying results found in carnivora to similar functions in herbivora, where the processes are evidently different.

Colin claims that the reaction of the contents of the cæcum in the horse is almost invariably alkaline, and that to a greater degree than in the small intestine, whether the animal be digesting or fasting. When an acid reaction has been found in this cavity it is almost invariably to be explained as due to acid fermentations occurring in the food-constituents.

Ellenberger shows that the cæcum has a special value in the horse. In this animal, as we know, the small intestine is comparatively small, with a relatively small extent of digestive mucous membrane. The stomach is so small that it cannot contain the amount taken at one meal, so the stomach forces its contents into the intestine even while the animal is eating ; gastric digestion is, therefore, imperfect in these animals. But, as the horse is nourished on substances which are difficult of digestion, it should possess a special digestive organ, which, by its activity, should compensate for the loss of functional activity in the stomach. Nothing can be more natural than to suppose that this supplementary organ is found in the vast cæcum of these animals, and we may admit that this is to a certain extent true, without being compelled to acknowledge that this organ liberates an acid digestive secretion. The cæcum is, hence, of special importance in the monogastric herbivora, where the small size of the stomach prevents accumulation of food and drink. It is, therefore, a reservoir for intestinal digestion.

Its anatomical arrangement leads to the retaining of its contents. Its bottom corresponds to the region of the xyphoid appendage, while its narrow opening into the colon is in the most superior part, so that everything to enter the colon must be forced up against gravity, and should desiccation of its contents occur obstruction is sure to result, and the result is apt to be fatal. In length it is about one meter, while its capacity is from thirty-two to thirty-eight liters, or nearly twice as large as the stomach. It has an extensive mucous membrane, well supplied with glands, like the duodenal follicles (Fig. 164).

Ellenberger reports a number of experiments which he made on the horse to determine the length of time the food remains in the cæcum and the alterations to which it is subjected there. To determine this, he fed a series of horses during a certain number of days with a certain amount of food of known composition ; the animals were then killed at given periods, and the contents of the intestine examined.

The results of these experiments showed that they might be divided into four groups, according to the nature of the food given.

FIG. 164.—CÆCUM OF THE HORSE. (*Colin.*)

A, cæcum; B, ileum; C, colon.

Thus, when dried peas are given, traces of them are to be found in the cæcum after the lapse of twelve hours. After twenty-four hours grain and dry forage are still to be found in the cæcum, and after thirty hours chopped hay still remains in the cæcum. After seventy-two hours the greater part of the hay had already passed into the colon. Thus, in *résumé*, twelve hours after feeding, forage is to be found in the stomach, with some traces in the jejunum and cæcum; after twenty-four hours, principally in the cæcum, with a certain amount of residue in the jejunum; after forty-eight hours, in the ventral colon, with some *débris* in the cæcum; after seventy-two hours, in the dorsal colon; and after ninety hours, in part in the dorsal colon and rectum.

As regards the functions of the cæcum, it would appear that after twelve hours already traces of food are to be found in the cæcum, and after twenty-four hours nearly all the alimentary mass has arrived at the cæcum, in which some is still to be found after forty-eight hours. Food, therefore, usually remains twenty-four hours in the cæcum of the horse. The contents are always alkaline, highly fluid, and of a special odor. The color varies with the nature of the food.

From the fact that a larger amount of undigested food is found in the cæcum than in the colon, it follows that digestion must take place in the cæcum, its extent being placed by Ellenberger at from 10 to 30 per cent. of the food; the nature of this action is determined by examination of the cæcal contents.

The acid reaction of the stomach and upper portion of the intestine gives place to an alkaline reaction in the lower portion of the ileum, and that of the cæcum is invariably alkaline. In the colon, again, the reaction may become acid from fermentative changes in food.

Digestive changes are, therefore, merely the continuation of the ordinary intestinal digestion.

Bureau has succeeded in obtaining a secretion from the cæcum of the rabbit, but in such small amount as contrasted with the quantity obtained from the small intestine by the same method (double ligature) that he concludes that the digestive processes occurring in the cæcum are due to the action of the intestinal fluids which come down from above.

In the duck, however, by ligating the cæcum, after introducing small fragments of cooked meat, a large amount of clear alkaline fluid may be obtained, although the morsel of meat will have remained unaltered. This fluid is said to have the power of converting starch into sugar, but is without action on other food-stuffs.

By making cæcal fistulæ in rabbits, Bureau found, in the first place, that the reaction was invariably alkaline. Raw meat appeared to be unchanged in the cæcum, while cooked meat becomes somewhat softened and reduced in volume. Boiled starch is converted into sugar.



Ligation of cæca in chickens caused diarrhœa, loss of flesh, and death from inanition.

The most important function of the cæcum is, in all probability, to be found in the digestion of cellulose, which occurs in it. It is well known that from 30 to 40 per cent. of cellulose disappears in passing through the intestinal canal of the horse, and the poorer the food is in true nutritive substances the greater will be the amount of cellulose digested. Experiment has proven that the saliva, gastric juice, and pancreatic secretion are entirely inactive on cellulose. On the other hand, the fluids collected from the small intestine of a newly killed horse have been found to dissolve from 40 to 78 per cent. of cellulose (Hofmeister), and this power is lost when these fluids are previously boiled, indicating the probable dependence of this digestive process on a true ferment. Admitting these facts, the share which the cæcum bears in digesting cellulose is evident; it acts as a reservoir for fluids and undigested food-stuffs coming down from above, and by its reaction, temperature, etc., favors fermentative changes.

The nature of the substances resulting from the digestion of cellulose are clouded in obscurity: the most natural presumption would be that it was converted into sugar, but no experimental proof of this has ever been adduced, though it is generally assumed that the cellulose in digestion is changed into some nutritive substance, which is absorbed. According to this, cellulose should be classed among the food-stuffs. Unfortunately, this also does not admit of proof. It is well known that in fermenting cellulose may be converted into marsh-gas, and Hofmeister's experiments seem to prove that the substance resulting from the digestion of cellulose by the intestinal fluids of the horse is gaseous in nature. While this may be so, and there is no denying that the gas may be met with in the alimentary canal, it does not follow that *all* the digested cellulose is converted into marsh-gas. For, as Ellenberger has pointed out, we often meet with a lactic acid fermentation of sugar in the stomach and intestine, but do not infer from that that all the sugar which disappears from the alimentary canal has been converted into lactic acid. The case may be similar with cellulose; when in excess, or not needed, it may and probably is converted into marsh-gas; when needed by the economy, it is absorbed in some soluble form, probably of the nature of a sugar. This view is supported by the fact already alluded to, that the poorer the food the greater the quantity of cellulose which disappears.

2. THE FUNCTIONS OF THE COLON.—The colon in the carnivora constitutes a simple reservoir for excrementitious matters, and in the herbivora it is doubtful if it has a more important rôle to perform in the digestive elaboration of food. In the walls of the large intestine are

found follicular glands, apparently similar to those in the small intestine, and which furnish a secretion which it is claimed will turn starch into sugar and albumen into peptone. The latter statement, which is made by Thanhoffer, seems to need confirmation. It is, at any rate, clear that the degree of digestion occurring in the large intestine must be slight, since the greater part of the food-stuffs which reach the large intestine have already undergone complete solution in the upper portion of the alimentary canal. In the large intestine in carnivora the contents of the

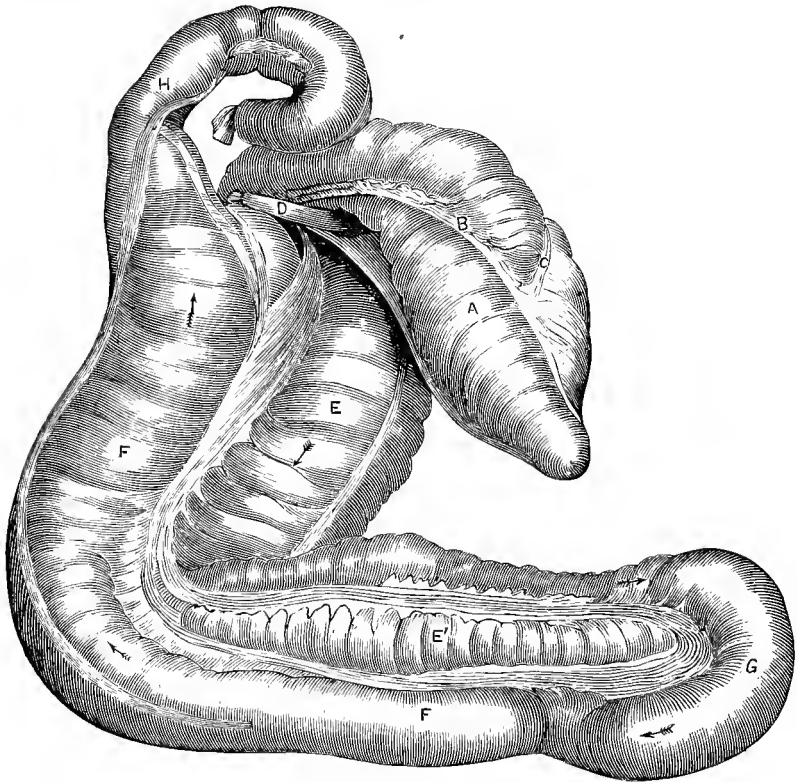

FIG. 165.—CECUM AND GREAT COLON OF THE HORSE. (*Strangeways.*)

A, cæcum; B C, its muscular bands; D, termination of ileum; E, first, E', second, F, third, and F', fourth divisions of colon; G, pelvic flexure; H, origin of floating colon. The arrows indicate the course of the food through the colon.

alimentary tube undergo no further digestive changes, but become more condensed from the rapid absorption of water and other fluids which takes place through its walls. In the solipedes the large intestine is particularly active as an absorbent, removing water and various fluids secreted by the upper portions of the alimentary tube and the alimentary

principles which have escaped absorption in the small intestine. Its enormous capacity, five or six times that of the stomach, enables it to retain immense quantities of materials which move slowly, and which

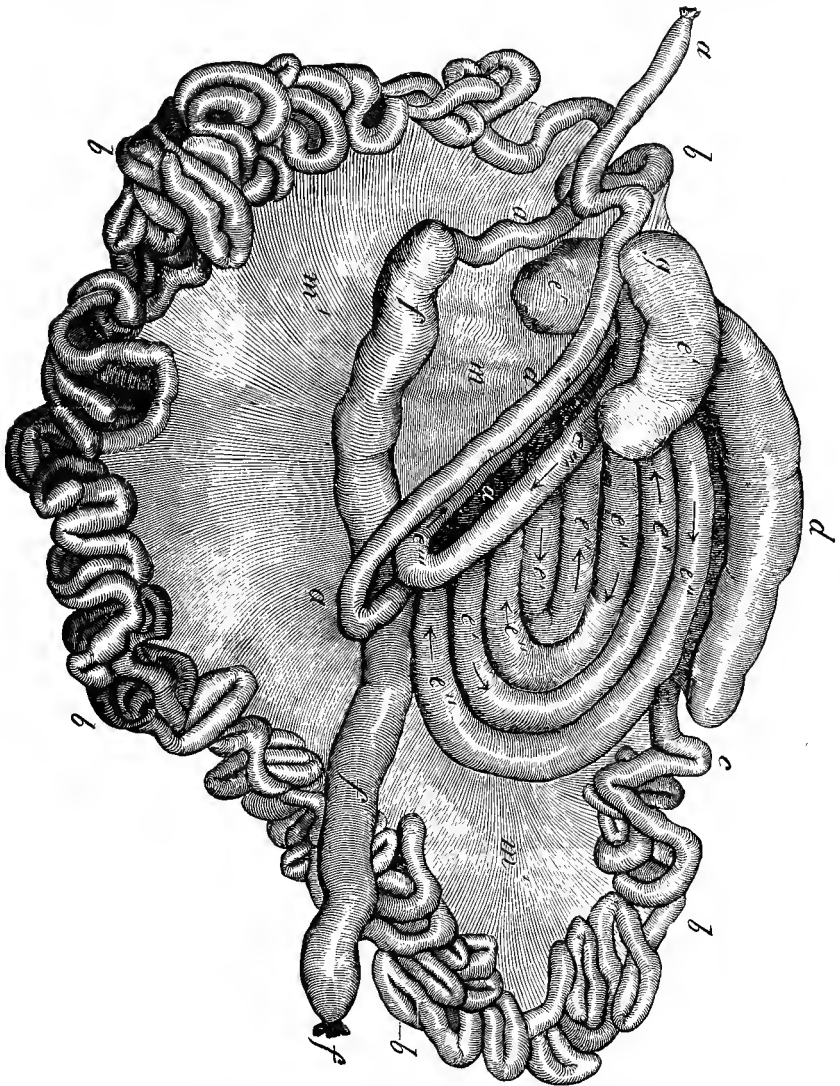

FIG. 166.—INTESTINAL CANAL OF THE OX. (Müller.)

*a*, duodenum; *b* and *c*, jejunum and ileum; *d*, caecum; *e*, colon with its various convolutions; *f*, rectum; *g*, commencement of colon; *m*, mesentery of large intestine; *m'*, mesentery of small intestine.

are brought in contact with an immense extent of mucous membrane. The contents enter by a narrow and valvular opening, and descend first

to the substernal curvature, then they mount to the pelvic curvature, which is always higher than the sternal curvature, and then up the diaphragmatic curvature, and finally descend abruptly, passing by the left kidney to enter the convolutions of the floating colon, where they make two ascents and two descents (Fig. 165).

The large intestine of the ox is shown in Fig. 166.

The interior arrangement of the colon consists in the formation of pockets, in which portions of the contents remain temporarily, while the centre of the gut is free. The disposition of certain parts of the colon leads to a difference in the physical characters of its contents at different points. The diaphragmatic curvature, on account of its dependent position, contains large volumes of liquid, in which certain salts are abundant, such as ammonio-phosphate of magnesium, especially after oat diet, and in this locality these salts are often deposited as intestinal calculi.

Digestion in the large intestine cannot, therefore, be said to take place, although absorption is highly active, and numerous cases are on record in which life has been preserved through the absorption by the walls of the large intestine alone of alimentary substances introduced into the rectum. In the large intestine complex fermentations take place, and true decomposition frequently occurs in the contents of this portion of the alimentary tube, especially when the reaction is alkaline. Many of the gases, such as oxygen and nitrogen, which are found here have probably entered with the food; others are derived from different fermentations; thus, for example, hydrogen is liberated in the butyric acid fermentation, sulphuretted hydrogen and ammonia from the putrefaction of animal substances.

#### XI. THE COMPARATIVE DIGESTIBILITY OF DIFFERENT FOOD-STUFFS.

The quantity and chemical composition of the *faeces* is of special interest on account of the insight which it permits as to the degree of digestibility and convertibility of the different food-stuffs, for it is evident that if we know the amount and composition of any food given to an animal for a series of days, the loss of these materials, determined by an analysis of the *faeces*, will indicate within certain limits the amount which has been digested and absorbed in its passage through the body. In making these calculations, however, it must be remembered that a large amount of fluid is added to the food in the form of the digestive juices, which, to be sure, is again largely absorbed; but we have further seen that certain excretory ingredients have been added to the *faeces*, and, further, that the different food-stuffs may undergo decompositions other than digestive in the alimentary tract. The digestive processes, as we have seen, are of the same nature in all our domestic animals, simply varying in degree. This difference we have also seen to be due to

the different degrees of perfection with which mastication is accomplished, to differences of construction in the alimentary canal, different constitutions, and the different degrees of concentration of the digestive juices. Thus, the herbivora, through the high development of their molar teeth, the roomy and long digestive canal, and large amounts of amylolytic ferments in their digestive secretions, are especially suited for digesting carbohydrates. Their gastric juice is comparatively poor in acid, and, as a consequence, prevents their living on a highly albuminous diet; while the highly alkaline nature of their intestinal contents facilitates putrefactive changes in albuminoids, the characteristic results of such fermentations being met with in large amounts in their urine. In the carnivora, on the other hand, we find a short and less capacious intestinal canal, with a relatively voluminous stomach and an active acid gastric secretion, thus fitting them for the digestion of albumen, while the conditions for the digestion of carbohydrates are less favorable.

Omnivora naturally occupy a mean between these two classes. It is to be remembered, however, that as long as animals are fed on their mothers' milk there is no difference in the digestive act in the carnivora or in the herbivora.

Not all the nutritive substances which are contained in the food are actually digested, but a considerable proportion, under the most favorable circumstances, is apt to remain undigested and pass unchanged into the fæces. The cause of this is frequently to be found in the fact that the food is taken in such quantities that the amount of digestive secretion poured out by the alimentary tract is insufficient to act upon it. There appears to be, again, a limit of absorbability even of the amount of food digested. This limit, of course, varies in each group of animals, and the residue of food, even though it may be digested, remains unabsorbed in the alimentary canal to undergo breaking down into various decomposition products, such as leucin, tyrosin, etc. Again, another cause for indigestibility of food is to be found in the fact that in many cases, especially in the food of the herbivora, the nutritive principles are contained in resisting envelopes which are impermeable to the digestive secretions, and which require mechanical comminution in mastication before being accessible to the act of digestion. Imperfect mastication, therefore, from whatever cause, will reduce the digestibility of food. By this term, digestibility of food, is meant the amount of any food-stuff which through digestion is rendered capable of absorption and does actually enter the blood, in proportion to the amount which remains undigested or which is not so absorbed. This quantity, which may be termed the co-efficient of digestion, varies according to the composition of food and to the mode of digestion of different classes of animals. We will, therefore, allude to these sources of variation in turn:—

*First.* Vegetable fibre is capable of being digested to a more or less degree by all herbivora and even to a certain extent by the hog, the co-efficient of digestion lying, in green and dry fodders, between 45 and 75 per cent. In vegetable foods, such as grains, roots, and bulbs, and the artificial nutritive substances made from such materials, all of which are rich in cellulose, the digestibility becomes greatly reduced, and, in fact, many such products may be said to be entirely undigestible. It is probable, again, as already mentioned, that a certain amount of cellulose which disappears in its passage through the intestinal canal may be explained as due to the development of carburetted hydrogen and carbon dioxide and other fermentations.

*Second.* The non-nitrogenous extractive matters, as found in beets and potatoes and seeds, are almost completely digested, only about 2 per cent. escaping the action of the digestive fluids, though in green fodders the digestive co-efficient of these materials may sink from 84 to 48 per cent. In this connection the remarkable fact appears that the amount of soluble non-nitrogenous food-constituents which undergoes digestion, together with the amount of cellulose which is digested, almost exactly equal the total sum of non-nitrogenous extractive matters found in the food, and in this we have, therefore, a means of estimating the quantity of non-nitrogenous extractive matters actually digested and absorbed. The digestible portion of the non-nitrogenous extractive matters in any food may be estimated in nutritive value as pure carbohydrate, and therefore compared with starch.

*Third.* As regards fat, it may be stated that, when perfectly pure, fat is entirely digested, but since fat in the ordinary foods is not pure and contains other indigestible constituents, it is evident that the digestive co-efficient of fat will be subject to great variation. In clover and various oil-cakes this co-efficient varies between 80 and 90 per cent.; in seeds, between 60 and 90 per cent. In beets and potatoes fat may be regarded as entirely digested, while, on the other hand, the fat in green foods, although present in smaller amount, still varies in digestibility through very wide limits. Thus, 80 per cent. may be absorbed, or only 20 per cent. In general, in this connection, clover is more readily digested than grasses, while straw of the hulled fruits is more digestible than the straw of the hulled cereals.

*Fourth.* The nitrogenous constituents of the food are generally regarded as albumen, although, of course, other nitrogenous materials are often constituents of foods. In beets and potatoes albuminous matters are, as a rule, entirely digested, in seeds a certain amount escapes, the co-efficient of digestion varying from 60 to 90 per cent. In green and dried fodder great variation is met with, the co-efficient of absorption varying between 17 to 75 per cent., as a rule, the digestibility

of albuminous matters being greater in the green than in the dry fodder, even though of the same material; while still further the statement may be made that the larger the relative proportion of albuminous matter and the smaller the amount of the cellulose, the greater will be the amount of albuminous matter digested.

*Fifth.* The digestive co-efficient of the different food-stuffs may be altered through the addition to the food of different nutritive substances. Thus, it has been shown that the administration of a readily digestible albuminous diet is without influence on the co-efficient of digestion of the other foods; but, on the other hand, the addition of starch or sugar will reduce the digestive co-efficient of the albuminous bodies when the amount of carbohydrates given exceeds by 15 per cent. the solids of the other food-stuffs. This depression of digestibility is especially marked in the dry foods. A similar result is also manifested when beets and potatoes are added. The addition of oil is without influence on the digestive co-efficient so long as it is not given in great amounts. When the amount given exceeds the proportion of one-tenth gramme to one kilogramme of body weight, slight disturbances of digestibility are readily produced. When the food is composed of several nutritive substances combined, the proportion of the nitrogenous and the non-nitrogenous constituents of the total amount is of great influence on the digestibility. This nutritive relationship of the non-nitrogenous substances is found by adding the amount of fat to the sum of the non-nitrogenous extractive matters, the amount of cellulose being excluded. Ordinarily the amount of fat is multiplied by two and four-tenths or two and five-tenths, and this product then added to the amount of extractive matters,—a procedure which is, however, apt to give an erroneous idea as to the nutritive value of the fat.

The general result may be stated that a food is readily digestible when the proportion between nitrogenous and non-nitrogenous constituents varies from 1 : 5 to 1 : 7. An increase of this proportion causes a certain amount of the non-nitrogenous constituents to remain undigested while an increase of the nitrogenous substances causes a waste. It is evident that the above statement as to the digestibility of food may be only regarded as in general true. Each group of animals will possess special facilities for digesting special foods; these will deserve consideration in turn.

As might be expected, the time required for undigested food to appear as fæces after feeding very closely corresponds in different animals with the comparative length of the intestinal canal. Thus, it has been found that in oxen fed with oat-straw the first traces appear in the fæces about thirty-six hours after feeding, and disappear after seventy-two to ninety-six hours, while in the goat seven days were required after

giving certain food for its traces to disappear from the fæces. In the calf three days were required for the removal of traces of a previous meal of barley, while four days were required for an ox under the same conditions. In the sheep fed with hay, it has been determined that the food remains 20 hours in the first three stomachs, and in the fourth stomach 1.2 hours; in small intestine, 2.3 hours; in cæcum, 7 hours; and in colon, 5.5 hours; or, in all, 36 hours before appearing as fæces.

Carnivora fed on pure flesh diet produced but little fæces. A dog weighing thirty-five kilos, and fed with a half to two and a half kilos of meat, produces from twenty-seven to forty grammes of fæces, in which there will be only nine to twenty-one grammes of solids; therefore it may be said that with a flesh diet only 1 per cent. of the amount of solids taken with the food escapes from the body in the form of fæces.

Omnivora form considerably larger amounts of fæces. Animals living on a mixed animal and vegetable diet, like man, will pass daily about one hundred and thirty grammes of fæces, containing thirty-four grammes of solids, which will represent about 5 per cent. of the solids taken as food. When the vegetable diet is in excess, this may rise to 13 per cent., so that only seven-eighths of the solids are finally absorbed. Hogs pass in their fæces only about 20 per cent. of mixed matter taken in food. However, when fed on sour milk, with beans and peas, only about 1 per cent. escapes absorption. So, also, according to Wolff, pigs digest almost completely the residue remaining after making meat extracts. The hog is able to digest both vegetable and animal matter, and is claimed to be capable of digesting fully 50 per cent. of cellulose.

The following table gives the percentage of constituents absorbed in hogs fed with sour milk:—

Albumen, . . . . .	96.06 per cent.
Non-nitrogenous substances, . . . . .	98.90 “
Inorganic matter, . . . . .	64.46 “

So, also, of the following vegetable foods, the figures indicate the amount digested and absorbed:—

Horse-beans, . . . . .	99.8 per cent.
Peas, . . . . .	99.7 “
Oats, . . . . .	93.7 “
Barley, . . . . .	92.7 “
Rye, . . . . .	90.7 “

The largest amount of fæces is formed by the herbivorous animals. In the horse and ox, of one hundred parts of food about 40 per cent., as a rule, escapes unchanged in the fæces, so that only three-fifths of the food swallowed serves any nutritive purpose. This follows from the fact that a large part of vegetable food is absolutely indigestible, and all is very difficult of digestion. The horse, as a rule, digests a smaller proportion of dry fodder than does the ox.



As a rule, it may be stated that the ox is capable of digesting the following amounts:—

	Albuminoids.	Cellulose.	Non-nitrogenous Extractive Matters and Fats.
Oats, . . .	49 per cent.	55 per cent.	44 per cent.
Wheat-straw, . .	26 “	53 “	39 “
Bean-straw, . .	51 “	36 “	62 “
Clover-straw, . .	51 “	39 “	67 “
Barley-hay, . .	60 “	60 “	67 “

Henneberg has found that the digestibility of a fodder is altered when a second nutritive substance is added to it. Thus, the digestibility of any fodder is reduced by the addition of starch, while, on the other hand, the addition of fat facilitates the digestion of albuminoids and cellulose. In general, it may be stated that the digestibility of any dry fodder is decreased by the addition of any readily digestible substance, such as albumen, starch, sugar, and in ordinary fattening diet a loss of at least 20 per cent. of nutritive substances may be calculated. This author's experiments have further shown that at least five days are required after the change of diet before the traces of indigestible food are removed from the fæces, and that the removal of the residue of prairie hay occurred about thirty hours before that of wheat-straw. In the calf, experiments have been made to determine the digestibility of cereals and grains taken whole, with the following results:—

	Oats.	Flaxseed.	Barley.	Wheat.
Digested, . . .	91.4	58.2	94.6	36.3
“ . . .	91.5	57.4	94.9	36.7

In the sheep the same results have been obtained as in the ox. An addition of starch or sugar to the food diminishes considerably the digestibility of the albumen and, when in small amount, of the cellulose also. Pure albumen has slight influence on the digestibility of the food. Substances containing sugar, with the exception of beets, are almost entirely digested, while in potato-starch 80 per cent. is digestible, and fat, when added to fodder, is usually absorbed, though its administration when given in large amounts interferes with the digestion of cellulose.

According to Wildt, lambs which were fed with barley-straw, and then the residue from meat extracts, absorbed 95 per cent. of the latter. Experiments on the horse have also proved that this animal is capable of digesting cellulose to about 50 per cent. In comparison with the ruminants, the horse is less capable of digesting all the constituents of hay. The loss in the horse, as in other herbivora, is much greater than in the carnivora. The carnivora may be said, as a rule, to absorb about 98 per cent. of albuminous matter given in the food. In a man fed on milk and meat diet only  $2\frac{1}{2}$  to 10 per cent. escapes in the fæces; with vegetable diet, rice, bread, and potatoes, the loss may amount to 30 per

cent., though the carbohydrates are almost completely absorbed, only 1 per cent. being lost, and only 5 per cent. of fats escapes absorption. In the herbivora the loss is, however, much greater. Thus, a horse fed with six kilos of oats and fifteen liters of water will pass about twelve kilos of fæces, composed of three kilos of solids, containing 5 per cent. of albuminous matter, 20 per cent. of fat, 20 per cent. of starch, and 60 per cent. of cellulose. If the horse is fed with a mixed diet, composed, for example, of three and a half kilos of oats, five and a half kilos of hay, and one and three-fourths kilos of chopped straw, seventeen kilos of fæces will be passed, in which there will be four kilos of solids, of which 30 per cent will be albuminous matter, 40 per cent. fats, 30 per cent. starch, and 60 per cent. cellulose having escaped digestion. The loss is, therefore, greater in a mixed diet than in a horse fed on grain alone. In the ruminants the digestibility of hay is much greater than in the horse. Oxen fed with ten kilos of hay will digest and absorb about 50 per cent. of the albuminous matter, while, as already mentioned, if more readily digestible substances are added to the hay diet, less hay will be digested.

It has been found that in the fermentation of cellulose large quantities of  $\text{CO}_2$  and  $\text{CH}_4$  are formed, and, as the latter gas is constantly found in the intestine, that its source is in the putrefaction and fermentation in the intestinal canal is readily conceivable, and indicates a possible explanation of the fact that about 40 to 60 per cent. of cellulose disappears in the intestinal canal. This may occur in the rumen of the ruminants, while it certainly occurs in the cæcum of the horse, although in this animal less cellulose disappears than in the ruminant.

As regards the inorganic constituents of the food, the fact that the fæces contain but small amounts of soluble salts shows that they must have been largely absorbed. Small amounts only of the alkalies are found in combination with chlorine and sulphuric acid, while potassium and sodium are found in combination as chlorides or sulphates in minute quantities. Magnesium is also almost entirely absent. In the herbivora less lime is absorbed than magnesium, while in the carnivora but very small quantities of both lime and magnesium are absorbed. Another point of contrast between carnivora and herbivora is that in the former almost all the phosphates in the food are absorbed, while in the herbivora they are almost entirely excreted in the fæces, unless they are fed with meal, milk, or other readily digestible food.

Mr. E. F. Ladd has tested the relative digestibility of the different feeding stuffs by digestion experiments performed with them, after thorough comminution, with an artificial gastric juice, formed of 0.2 per cent. hydrochloric acid with five grammes of pepsin to the liter. The following tables give his conclusions:—

TABLE No. I.—COMPOSITION OF ORDINARY FEEDING STUFFS (LADD).

	FRESH SUBSTANCES.							DRY SUBSTANCES.				
	Water.	Albuminoids, N × 6.25.	Crude Fibre.	Nitrogen-free Extract.	Fat, Ether Extract.	Ash.		Albuminoids.	Crude Fibre.	Nitrogen-free Extract.	Fat, Ether Extract.	Ash.
1 Clover-hay, . . . . .	14.53	11.80	28.22	35.84	3.31	6.30	13.812	33.025	42.113	3.865	7.185	
2 Same, exposed, average, . . . . .	14.53	10.42	35.14	33.28	2.48	4.15	12.187	41.110	38.953	2.900	4.840	
3 Same, exposed, poorest, . . . . .	14.53	11.73	34.79	31.79	2.52	4.64	13.843	40.710	37.057	2.960	5.430	
4 Clover-hay, . . . . .	15.22	5.14	31.28	41.36	2.06	4.94	5.94	36.89	48.91	2.43	5.83	
5 Same, steamed, . . . . .	15.22	4.94	35.89	35.58	2.08	4.68	5.94	43.16	42.80	2.50	6.23	
6 Hay, ordinary, mixed, . . . . .	16.85	3.40	15.46	30.64	1.30	2.71	7.81	35.54	47.44	2.98	5.60	
7 Hay, poor, many daisies, . . . . .	56.49	8.42	22.34	38.29	1.35	8.37	10.69	28.35	48.59	1.75	10.62	
8 Fodder-corn, . . . . .	21.23	1.13	5.01	7.22	1.15	9.1	7.31	32.48	46.84	7.45	5.92	
9 Soya hispida, . . . . .	84.58	13.72	10.52	53.09	2.86	6.12	15.87	12.19	61.53	3.32	7.09	
10 Ensilage, . . . . .	16.00	14.96	4.71	54.12	3.99	6.32	17.81	5.68	64.12	4.87	7.52	
11 Wheat-bran, . . . . .	8.25	30.16	2.78	52.79	5.16	8.6	32.87	3.03	57.54	5.62	7.52	
12 Ship-stuff, . . . . .	63.60	7.66	3.68	20.78	4.04	21	21.06	10.10	57.08	11.11	.94	
13 Gluten-meal, . . . . .	6.00	16.04	13.02	58.14	6.08	7.2	12.50	12.43	65.11	9.45	.51	
14 Starch-refuse, . . . . .	8.35	9.85	5.76	62.91	11.21	1.92	10.75	6.28	68.64	12.23	2.10	
15 Starch-feed, . . . . .	6.12	7.04	13.26	64.55	7.53	1.50	7.50	14.12	68.76	8.92	1.60	
16 Corn-feed, ground germ, . . . . .	8.07	31.71	12.31	34.38	8.20	5.33	34.50	13.39	37.40	8.92	5.79	
17 Corn-feed, ground hull, . . . . .	8.55	32.35	13.77	38.13	2.13	5.07	35.37	15.06	41.70	2.33	5.54	
18 Unseed-meal, old process, . . . . .	18.52	35.21	5.74	21.66	12.32	6.55	43.21	7.31	26.32	15.12	8.04	
19 Unseed-meal, new process, . . . . .	18.52	35.21	5.74	21.66	12.32	6.55	42.73	7.31	26.32	15.12	8.04	
20 Cotton-seed meal, . . . . .	18.52	35.21	5.74	21.66	12.32	6.55	42.73	7.31	26.32	15.12	8.04	
21 Same, cooked, . . . . .	18.52	35.21	5.74	21.66	12.32	6.55	42.73	7.31	26.32	15.12	8.04	
22 Corn-meal, . . . . .	12.21	10.86	2.24	68.23	5.06	1.40	12.37	2.55	77.78	5.77	1.59	
23 Same, cooked, . . . . .	12.21	9.88	2.90	69.77	3.85	1.39	11.25	3.31	70.48	4.38	1.58	
24 Pea-meal, . . . . .	12.08	21.37	11.06	52.02	8.6	2.61	24.31	12.58	59.17	3.97	2.97	
25 Crushed oats, . . . . .	10.09	11.63	16.57	53.98	4.49	3.24	11.87	22.33	58.51	3.90	3.39	
26 Corn-meal, . . . . .	24.54	8.20	1.52	60.60	3.96	1.18	10.87	2.02	80.31	5.24	1.56	
27 Corn-meal, . . . . .	8.01	9.61	2.14	73.80	4.98	1.47	10.41	2.33	80.35	5.41	1.50	
28 Same, cooked, . . . . .	8.01	9.09	2.27	75.80	3.52	1.31	9.87	2.47	82.33	3.86	1.42	
29 Corn-meal, . . . . .	15.80	10.31	1.58	67.64	3.62	1.05	12.25	1.88	80.33	4.30	1.42	
30 Same, heated, in bin, . . . . .	15.80	9.99	3.88	67.42	1.44	1.44	11.71	1.87	79.93	1.71	1.87	
31 Wheat, Clawson's winter, . . . . .	12.80	13.00	3.76	67.40	1.64	1.40	14.93	4.31	77.28	1.88	1.60	
32 Bean, navy or pea, . . . . .	12.39	22.17	7.21	53.14	1.38	3.71	25.31	8.23	60.66	1.57	4.23	

TABLE No. II.  
DIGESTED BY FLUID FROM HOG'S STOMACH (LADD).

No. Corresponding to No. of Analysis.	HAY AND COARSE FODDERS.	Per Cent. of Crude Albuminoids, N $\times$ 6.25.	Per Cent. of True Albuminoids.	Per Cent. Undigested.	Per Cent. of Crude Albuminoids Digested.	Per Cent. of True Albuminoids Digested.
1	Clover-hay, . . . . .	13.81	10.03	3.62	73.75	63.91
2	Same, exposed, average,	12.19	9.38	6.20	49.23	33.90
3	Same, exposed, poorest, .	13.84	11.31	7.09	48.76	37.31
26	Corn-meal, . . . . .	10.87	8.31	1.71	83.98	79.42
10	Ensilage, . . . . .	7.31	4.46	2.32	68.20	47.98

TABLE No. III.  
DIGESTED BY PEPSIN SOLUTION (LADD).

No. Corresponding to No. of Analysis.	HAY AND COARSE FODDERS.	Per Cent. of Crude Albuminoids, N $\times$ 6.25.	Per Cent. of True Albuminoids.	Per Cent. Undigested.	Per Cent. of Crude Albuminoids Digested.	Per Cent. of True Albuminoids Digested.
4	Clover-hay, . . . . .	14.53	10.03	4.70	67.65	53.14
5	Same, steamed, . . . . .	14.34	..	6.70	53.27	..
6	Hay, ordinary, mixed,	5.94	..	2.09	35.32	..
7	Hay, poor, many daisies,	5.94	5.44	2.51	57.69	53.86
8	Fodder-corn, . . . . .	7.81	5.88	2.89	63.00	50.83
9	Soja hispida, . . . . .	10.68	9.56	2.57	75.92	73.11
10	Ensilage, . . . . .	7.31	4.56	2.82	61.35	39.25
	<i>By-Products.</i>					
11	Wheat-bran, . . . . .	15.87	13.00	2.65	83.27	79.61
13	Gluten-meal, . . . . .	32.87	..	5.51	83.23	..
14	Starch-refuse, . . . . .	21.06	..	5.60	73.43	..
15	Starch-feed, . . . . .	12.50	12.68	4.89	60.80	61.36
16	Corn-feed, ground germ,	10.75	..	4.54	57.98	..
17	Corn-feed, ground hull, .	7.50	..	2.28	69.71	..
18	Linseed-meal, old process, .	34.50	33.13	3.61	89.52	89.10
19	Linseed-meal, new process,	35.37	32.19	7.62	78.44	76.33
20	Cotton-seed meal, . . . . .	43.21	40.25	5.30	87.73	86.83
21	Same, cooked, . . . . .	42.73	..	11.19	73.81	..
21	Ship-stuff, . . . . .	17.81	16.81	2.34	87.86	86.08
	<i>Grains.</i>					
24	Pea-meal, . . . . .	24.31	20.19	2.75	88.69	86.38
25	Crushed oats, . . . . .	11.87	10.31	2.15	81.89	79.14
26	Corn-meal, . . . . .	10.87	8.31	1.50	86.15	81.95
27	Corn-meal, . . . . .	10.41	7.64	2.85	72.58	64.00
28	Same, cooked, . . . . .	9.87	7.61	3.64	63.16	52.17
31	Wheat, Clawson's winter,	14.93	8.81	1.93	87.07	78.09
29	Corn-meal, . . . . .	12.25	8.81	3.57	70.85	59.48
30	Same, heated, . . . . .	11.81	8.81	3.58	69.79	59.35
22	Corn-meal, . . . . .	12.37	9.41	3.87	68.63	58.87
23	Same, cooked, . . . . .	11.25	5.19	4.44	60.53	16.37
32	Bean, navy or pea, . . . . .	25.31	22.06	1.13	95.59	94.93

TABLE No. IV.  
 DIGESTIBLE CONSTITUENTS OF THE FOOD IN PERCENTAGES (KUH).

NAME OF THE FOOD.	ALBUMEN.			FAT.			NON-NITROGENOUS EXTRACTIVE MATTERS.			CELLULOSE.		
	Minimum.	Maximum.	Mean.	Minimum.	Maximum.	Mean.	Minimum.	Maximum.	Mean.	Minimum.	Maximum.	Mean.
<i>I. Green Fodders.</i>												
Pasture-grass, . .	70.6	79.3	75.0	63.4	68.1	66.0	74.5	84.4	79.0	70.3	75.2	73.0
Good meadow-grass, . .	69.0	71.7	70.0	60.4	68.1	65.0	74.7	84.4	79.0	65.4	72.8	69.0
Clover, . . . . .	77.7	78.7	78.0	63.3	65.1	64.0	78.0	78.5	78.0	66.9	67.4	67.0
Lucern-clover, . .	78.2	83.2	81.0	37.0	53.6	45.0	61.1	76.9	72.0	31.6	46.8	41.0
Esparet, . . . . .	71.7	73.3	73.0	64.1	69.2	67.0	76.5	80.0	78.0	42.1	42.3	42.0
Lupines, . . . . .	73.0	75.7	74.0	15.5	45.3	30.0	57.3	65.9	62.0	67.1	79.8	73.0
Potato-stalks (beginning of October), . . . . .			42.0			24.0			60.0			36.0
Aspen-leaves, . . . . .			56.0			79.0			65.0			35.0
<i>II. Hay.</i>												
Prairie-hay, . . . . .	38.9	71.0	57.0	8.5	69.7	46.0	48.0	78.8	63.0	44.6	72.4	58.0
Second-crop hay, . . . . .	53.0	68.0	61.0	27.0	57.4	46.0	56.7	75.0	66.0	54.3	74.9	63.0
Clover-hay, . . . . .	43.0	73.3	60.0	33.0	75.3	59.0	62.5	80.1	69.0	38.0	59.2	47.0
Lucern-hay, . . . . .	72.1	83.0	77.0	29.7	51.0	39.0	52.6	72.0	65.0	33.1	45.7	40.0
Acidified beet-leaves, . . . . .	73.0	75.7	74.0	15.5	45.3	30.0	57.3	65.9	62.0	67.1	79.8	73.0
			65.0			60.0			54.0			54.0
<i>III. Straw.</i>												
Wheat-straw, . . . . .			26.0			27.0			40.0			52.0
Rye-straw, . . . . .	2.6	28.6	25.0	21.2	40.9	32.0	28.5	51.8	36.0	46.8	72.9	56.0
Oat-straw, . . . . .	14.4	50.0	38.0	14.0	51.0	30.0	33.2	47.0	42.0	53.0	67.0	61.0
Barley-straw, . . . . .	12.8	16.8	15.0	32.4	42.6	38.0	50.7	51.3	51.0	49.1	55.6	52.0
Pea-straw, . . . . .	60.3	60.6	60.5	41.6	50.1	46.0	64.0	64.8	64.0	47.2	65.9	52.0
	35.4	39.7	37.0	25.4	35.0	30.0	64.5	65.4	65.0	49.2	52.0	51.0
<i>IV. Cereals.</i>												
Oats (experiments with ruminants), . . . . .	58.0	81.3	74.0	68.4	99.0	82.0	65.0	79.7	73.0	5.5	32.1	21.0
Crushed barley (experiments with ruminants), . . . . .			77.0			100.0			87.0			20.0
Crushed corn (experiments with hogs), . . . . .	83.9	88.1	85.0	74.4	78.5	76.0	9.25	96.3	94.0	17.0	57.4	34.0



TABLE No. V.

DIGESTIBILITY OF THE NUTRITIVE PRINCIPLES IN FOOD-STUFFS BY DIFFERENT ANIMALS (POTT).

FODDERS.	PROTEIDS.			FATS.			NON-NITROGENOUS EXTRACTIVE MATTERS.		
	Minimum.	Maximum.	Mean.	Minimum.	Maximum.	Mean.	Minimum.	Maximum.	Mean.
A. THE RUMINANTS digest the following percentages of nutritive substances:—									
1. (a) <i>Green Foods</i> : Prairie-grass, clover, lucern, esparcet, vetches, rye, lupines, corn, beans, peas, spurry, white mustard, rape-seed, cabbage, beet-leaves.									
(b) <i>Hay</i> of esparcet, vetches, lucern, and lupines. . . . .									
	60.0	81.0	70.0	50.0	75.0	60.0	65.0	79.0	73.0
2. (a) <i>Green Foods, etc.</i> : Prairie-grass after blossoming, beet-leaves, buckwheat.									
(b) <i>Prairie-hay</i> , clover-hay.									
(c) <i>Straw</i> of beans, peas, and lentils, . . . . .									
	40.0	78.0	60.0	32.0	62.0	50.0	54.0	76.0	65.0
3. <i>Prairie Grummet</i> , . . . . .									
	58.0	70.0	64.0	45.0	68.0	54.0	62.0	74.0	67.0
4. <i>Acid Hay</i> , . . . . .									
	50.0	72.0	60.0	46.0	76.0	60.0	53.0	67.0	60.0
5. <i>Straw</i> of the cereals, rape, clover, lupines, potatoes, . . . . .									
	17.0	48.0	27.0	20.0	49.0	35.0	35.0	60.0	44.0
6. (a) <i>Roots and Bulbs</i> : All sorts of beets, potatoes, etc.									
(b) <i>Residue</i> from manufacture of spirits, starch, and sugar, etc., . . . . .									
	51.0	86.0	65.0				89.0	96.0	93.0
7. <i>Cereal Grains</i> , . . . . .									
	68.0	86.0	78.0	67.0	97.0	82.0	67.0	91.0	86.0
Malt, . . . . .									
			81.6			49.0			87.6
Brewers' grains, . . . . .									
			73.0			84.0			64.0
Acorns, . . . . .									
			83.0			87.5			91.4
8. <i>Hulled Fruits</i> , . . . . .									
	81.0	95.0	91.0	66.0	100.0	86.0	84.0	99.0	92.0
9. <i>Fodder Cakes</i> : Rape-seed cake, unshelled ground-nuts, unshelled cotton-seed and other oil-cakes and oil-cake meals, . . . . .									
	74.0	90.0	81.0	69.0	91.0	88.0	46.0	85.0	70.0

TABLE No. V.

DIGESTIBILITY OF THE NUTRITIVE PRINCIPLES IN FOOD-STUFFS BY DIFFERENT ANIMALS.—(Continued).

FODDERS.	PROTEIDS.			FATS.			NON-NITROGENOUS EXTRACTIVE MATTERS.		
	Minimum.	Maximum.	Mean.	Minimum.	Maximum.	Mean.	Minimum.	Maximum.	Mean.
10. <i>Fodder Cakes</i> of the various nuts and seeds, as above, after shelling, . . . . .	80.0	100.0	88.0	86.0	100.0	90.0	63.0	98.0	86.0
11. <i>Wheat-bran</i> , . . . . .	70.0	89.0	82.0	50.0	77.0	63.0	71.0	82.0	76.0
12. <i>Meat-powder</i> , . . . . .			95.0			98.0			
<i>Fish-guano</i> , . . . . .			90.0			76.0			
<i>Blood-powder</i> , . . . . .			62.0			100.0			100.0
13. <i>Milk and dairy residues</i> , . . . . .	91.0	97.0	94.0	90.0	99.0	95.0			98.0
14. <i>Brewed hops</i> , . . . . .	26.0	39.0	33.0	52.0	77.0	69.0	43.0	53.0	47.0
B. Hogs digest the following percentages of nutritive substances:—									
1. <i>Crushed barley</i> , . . . . .	75.0	80.0	78.0	65.0	77.0	68.0	89.0	91.0	90.0
2. <i>Crushed peas</i> , . . . . .	85.0	90.0	88.0	36.0	67.0	50.0	95.0	99.0	96.0
3. <i>Crushed corn</i> , . . . . .	84.0	88.0	85.0	74.0	79.0	76.0	93.0	96.0	95.0
4. <i>Crushed beans</i> , . . . . .			79.0			71.0			91.0
5. <i>Rye-bran</i> , . . . . .			66.0			58.0			75.0
6. <i>Boiled rice</i> , . . . . .	88.0	91.0	90.0						100.0
7. <i>Meat-powder</i> , . . . . .	82.0	99.0	95.0	82.0	91.0	87.0			
8. <i>Blood-meal</i> , . . . . .			72.0						92.0
9. <i>Crushed beetles</i> , . . . . .	71.0	81.0	77.0	79.0	91.0	83.0			
10. <i>Skimmed sour milk</i> , . . . . .			96.0			95.0			99.0
11. <i>Potatoes</i> , . . . . .			73.0						98.0
12. <i>Oil-cake</i> , . . . . .	60.0	75.0	68.0	75.0	85.0	80.0	80.0	90.0	85.0
13. <i>Brewers' grains and malt</i> , . . . . .	70.0	80.0	75.0	60.0	70.0	65.0	80.0	90.0	85.0
C. HORSES digest the following percentages of nutritive substances:—									
1. <i>Oats</i> , . . . . .	77.0	91.0	86.0	71.0	81.0	78.0	70.0	78.0	76.0
2. <i>Peas</i> , . . . . .			83.0			70.0			89.0
3. <i>Beans</i> , . . . . .	84.0	90.0	86.0			80.0	92.0	96.0	93.0
4. <i>Lupines</i> , . . . . .			94.0			37.0			73.0
5. <i>Corn</i> , . . . . .			78.0			63.0			94.0
6. <i>Barley</i> , . . . . .			80.0			42.0			87.0
7. <i>Prairie-hay</i> , . . . . .	54.0	66.0	61.0	14.0	42.0	23.0	49.0	62.0	56.0
8. <i>Clover-hay</i> , . . . . .	51.0	60.0	55.0	28.0	31.0	29.0	61.0	67.0	63.0
9. <i>Lucern-hay</i> , . . . . .	70.0	75.0	72.0	21.0	30.0	26.0	67.0	71.0	69.0
10. <i>Wheat-straw</i> , . . . . .	27.0	44.0	36.0	67.0	100.0	84.0	17.0	30.0	24.0
11. <i>Meadow-grass</i> , . . . . .			69.0			13.4			66.0
12. <i>Prairie-grass</i> , . . . . .	54.0	69.0	61.0	13.0	42.0	22.0	49.0	66.0	56.0
13. <i>Carrots</i> , . . . . .			99.0						94.0
14. <i>Potatoes</i> , . . . . .			88.0						99.0



Of the feeds examined in per cent. of digestibility of the albuminoids, bean-meal stands the highest, linseed-meal (old process) next, and pea-meal but little less, while the mixed hay of rather inferior quality, but similar to much hay feed, stands lowest. The old process linseed-meal shows a higher per cent. of digestibility than the new process; this difference is due, very likely, to the partial cooking of the meal by steam during the process of oil extraction and preparation of the meal for feed. Cotton-seed meal, much the richest substance examined, gives a high co-efficient for digestibility. A marked difference exists between the first three hays, showing plainly the difference between well-cured hay and that exposed to the weather.

Of the raw and cooked foods examined, in every instance the higher digestion co-efficients were obtained from the raw foods, and an examination of the table of analyses shows an actual loss in albuminoids by cooking, and a change in the fat rendering it insoluble in ether, and unacted upon by acids or alkalies of the strength used for fibre determinations.

## XII. THE COMPOSITION OF FÆCES.

The fæces are composed of the more or less altered residue of the food-stuffs, to which are added the excretory products of the digestive tract. The character of the fæces will be governed by the relative amounts of these two groups of substances.

When no food is given, as during fasting and in the fœtal state, the fæces consist only of the excretory products of the digestive tract. This state of affairs will also hold when the food given is entirely digested and absorbed, as is the case with the dog fed on a not too abundant meat diet.

The amount of matter found in the fæces which is not derived from the food may vary under different circumstances. In the fasting condition, according to F. Müller, the fæces contain 4 per cent. of the total amount of nitrogen eliminated, 1.4 per cent. of the amount of carbon, and 25 per cent. of the inorganic matter. When, however, food is given, the activity of the intestinal mucous membrane is increased, and through increased secretion and excretion the percentage of faecal constituents not derived from the food is increased.

The fæces passed in the fasting condition furnish, therefore, no index as to the degree of intestinal excretion. This, however, may be reached through the examination of the fæces of carnivora fed on meat, when the amount of nitrogen eliminated will be about 1.2 per cent. of the total amount, carbon 2.7 per cent., and inorganic matters 18.5 per cent.

Meconium, or the contents of the fetal intestinal canal, contains neutral fats, free fatty acids, biliverdin, bilirubin, unchanged biliary acids,

and various unknown bodies which may be extracted with ether; on the other hand, phenol, indol, leucin, and tyrosin are absent, indicating the absence of putrefactive changes in the fœtal canal. Meconium also contains sulphur, lime, magnesium, phosphoric acid, and considerable amounts of alkaline salts. The reaction is faintly acid.

The fœces passed by the carnivora during fasting closely resembles meconium, differing from it, however, in that they contain no unchanged biliary acids and hydrobilirubin is present. When fed with meat the fœces of the dog usually have an alkaline reaction, and where the meat has not been too freely given never contain undigested muscle-fibres. The proof that the fœces in carnivora after meat feeding are mainly composed of excretory matter is found in the facts that while increasing the amount of meat does increase the amount of fœces, the increases are not proportional; and that the amount of food remaining unchanged, the amount of fœces varies. The amount of nitrogen is about 6 per cent., while the inorganic matter is considerably larger in amount than in meconium, but contains less alkaline salts. When large amounts of fats are given to dogs with meat, the fœces are dark-brown externally and grayish on the inside; the daily amount passed is also larger than where meat alone constitutes the diet.

The fœces in herbivora always have an aspect and color closely similar to the food with which the animals have been fed. Thus, they are yellow when fed on hay, and green if grass has been given, since chlorophyll is unchanged in the alimentary tube; the tint will, however, vary according to the rapidity of their progression through the intestine and the quantity of bile poured out. The fœces of solipedes are extruded in rounded masses, flattened at the sides from mutual pressure, and are yellow, green, or brownish in color. In oxen the fœces are of semi-solid consistence, and dark-green or brown in color. The fœces of sheep and goats are passed in the form of small, hard balls, very dark-green or black in color. In hogs the fœces are semi-solid, very offensive in odor; their color depends on the nature of the food.

The consistency of the fœces depends naturally upon the quantity of water contained in them, which even in the most solid instances is still considerable. In carnivora the fœces have a blackish tint if meat has been given cooked. They become fatty or clay-colored in cases of obstruction to the flow of bile or in diseases of the pancreas. The odor is characteristic of each group of animals, and is due primarily to indol and sulphuretted hydrogen. The quantity, both absolute and relative to the amount of food, is greater in herbivora than in carnivora; thus, horses empty their bowels on an average every three hours, and when fed on 10 kilos hay and 2 kilos oats will pass about 17 kilos fœces, containing 2.67 kilos of solids; cattle evacuate about 30 kilos of fœces daily,

with about 4.6 kilos of solids; dogs, when fed on a purely meat diet, only every two to four days, and only a few grammes in amount. The consistency, as mentioned before, depends upon the amount of water contained in them, and is naturally governed by the activity of secretion, of absorption, and the amount of water drunk. Thus, in man they contain, on an average, 31 per cent. of water; in the hog, 75 per cent.; in the sheep, 56 per cent.; in the horse, 77 per cent., and in the ox, 70 to 80 per cent.

The reaction of the fæces may be either alkaline, neutral, or acid, depending upon the character of the fermentations occurring in the contents of the large intestine. Thus, when alkaline, as is usually the case in abundant albuminous diet, the reaction is due to ammoniacal fermentation, while an acid reaction is usually due to the fermentation occurring in the carbohydrate constituents of the food.

The fæces are composed of excrementitious substances no longer of use to the economy and which must be eliminated. They contain indigestible matters, such as chlorophyll granules, gums, resin, wax, animal and vegetable elastic tissue, cellulose, hulls of seeds, and epithelial cells. Lactic acid, butyric acid, and various gases, such as hydrogen, oxygen, carbonic acid, and carburetted hydrogen, are present, while in addition various salts are found in large amounts, of which the ammonio-phosphate of magnesium is usually in excess. As putrefactive products, leucin, tyrosin, indol, and finally skatol and the volatile aromatic acids, such as valerianic and caproic acids, are met with, while cholesterin and the bile coloring-matters and glycochol are also found, taurocholic acid being again absorbed.

The contents of the large intestine are always in a more or less marked degree of putrefaction, which, however, though hindered, is not entirely prevented by the bile.

In carnivora fed on bones, the fæces are dense and gray from the presence of lime salts. Silicious salts constitute a large percentage of the excrement of the lower animals; thus, in the horse and ox they amount to from  $2\frac{1}{2}$  to 3 per cent.; in the sheep, to 6 per cent.; while in the hog as much as 8 per cent. of silicious salts are present. These salts are products derived from the matters taken into the alimentary canal of inorganic nature, and from the inorganic matter of the hulls of the cereals. A small amount of soluble salts are present.

The following table gives the percentage of salts found in the fæces of different animals. The percentage will, of course, vary according to the nature of the food. It may, as a rule, be said that in the fæces of the dog about 20 per cent. of inorganic matter is present when on a pure meat diet, and 24 per cent. on a mixed diet; in that of the herbivora 58 per cent. is inorganic, though the fæces of the sucking calf will contain only 2.6 per cent. of the inorganic matter contained in the food. According

to Valentin, 100 grammes of fæces of the hog contains 37.2 grammes, ox 15.2 grammes, horse 13.3 grammes, sheep 13.5 grammes of ash:—

	Horse.	Ox.	Hog.	Sheep.
Sodium chloride, . . . .	0.03	0.23	0.89	0.14
Potassium, . . . .	11.30	2.91	3.60	8.32
Sodium, . . . .	1.98	0.98	3.44	3.28
Lime, . . . .	4.63	5.71	2.03	18.15
Magnesium, . . . .	3.84	11.47	2.24	5.45
Oxide of iron, . . . .	1.44	5.22	5.57	2.10
Phosphoric acid, . . . .	10.22	8.47	5.39	9.10
Sulphuric acid, . . . .	1.83	1.77	0.90	2.69
Carbonic acid, . . . .			0.60	traces
Silicon, . . . .	62.40	62.54	13.19	50.11
Sand, . . . .			61.37	
Oxide of magnesium, . . . .	2.13			

### XIII. THE MOVEMENTS OF THE INTESTINES.

The walls of both small and large intestines are supplied with unstriped muscular fibres arranged in circular and longitudinal layers which, through their contraction, serve to cause a slow, onward, progressive movement in the contents of the alimentary tube.

The arrangement of these muscular fibres differs in the small and large intestine and in different animals. The longitudinal layers lie beneath the submucous layer immediately below the serous covering, and, therefore, give the intestine its longitudinally striated appearance.

In the small intestine these longitudinal fibres form a thin, uniform layer, which entirely surrounds the intestine, while in the large intestine they are grouped into bands, and, being rather shorter than the intestine, throw the intermediate parts into a series of pouches; this condition is seen in the large intestine of man, the omnivora, in the cæcum of solipedes, and in the fixed colon in these animals, while in the floating colon their arrangement is more similar to that seen in the small intestine, and, consequently, in those portions of the alimentary tract the sacculated appearance is wanting. Immediately below the longitudinal fibres is found the layer of circular fibres, which are considerably more developed than the longitudinal fibres.

The motions of the intestine have been compared to the movements of a worm, and are termed peristaltic contractions. When the abdomen of an animal is opened after death the walls of the intestine are seen to be in active motion, and cause the intestine thus to undergo a series of active movements of the same nature, but greatly exaggerated in intensity, as the movements occurring during life. If the intestines are closely examined, it will be seen that these movements consist in the downward passage of a constriction due to the successive contractions of the circular fibres of the small intestine from above downward, while at the same time the longitudinal fibres contract immediately below the

ring of constriction so as to shorten the intestine and to cause a rolling motion in the intestine itself. The contractions of the circular fibres of the small intestine, as a rule, commence immediately below the pylorus and progress downward toward the large intestine, so tending to force the contents of the small intestine onward toward the ileo-caecal valve; but while the pylorus is ordinarily the commencing point of this series of contractions, the wave of contraction frequently may seem to commence at other points, and normally invariably moves downward toward the large intestine. It is stated that occasionally the wave of contraction moves in both directions, the upward movement being then spoken of as an antiperistaltic movement. Such a contraction occurs in cases of obstruction of the intestines, but it is extremely doubtful as to whether such an antiperistaltic movement ever occurs during health.

It is a peculiarity of unstriped muscular fibre that when stimulated its contraction is preceded by a very long latent period and lasts a considerable time, relaxation taking place but slowly afterward. In such cases as the intestine and ureter, a stimulation of any one point not only causes contraction of the muscular fibres in that locality, but that contraction is transmitted to the parts below it, the contraction being propagated from fibre to fibre, so producing a wave of contraction which passes along both circular and longitudinal coats of such tubular structures.

The peristaltic movements of the intestine are, in all probability, due to the contact of food with the interior, and yet, as in the case of the stomach, it is probable that this stimulation is not of a purely mechanical nature; for while the insertion of foreign bodies into the small intestine starts up a wave of contraction, that contraction soon passes off as the intestine becomes accustomed to the presence of the body. So, also, the intestinal movements are frequently more energetic when the intestine is comparatively empty than when distended with food.

The principal cause of the movements of the muscular coat of the bowels is without doubt to be found in the condition of the blood circulating through the vessels in the walls of the alimentary tube. Closure of the aorta causes active peristaltic motion of the intestine. If the intestinal tube be already in motion, closure of the aorta increases the vigor of the intestinal movement. Closure of the vena cava, or portal vein, and dyspnoea likewise increase peristalsis. An increase in the amount of carbon dioxide in the blood, or a decrease in the amount of oxygen, leads to powerful peristaltic movements, and this condition will probably explain the activity of the intestinal movements seen in animals recently killed. In this case, however, the exposure to the cold air is also concerned in the production of this movement. The manner in which these changes in blood supply influence intestinal movement has

not been thoroughly cleared up. The closure of the aorta may act through the intermediation of the spinal cord, either by the stimulation of motor or the paralysis of inhibitory apparatus; or it may act directly on peripheral, intra-muscular, ganglionic cells; or directly on the muscular fibres themselves. That the central nervous system is not solely concerned in the production of peristalsis is proved by its occurrence in an intestine removed from all connection with the central nervous system, and it has been found that ligation of the mesenteric artery produces in the main the same effects as ligation of the aorta. We have, therefore, to look to the periphery for the mechanisms which maintain peristalsis. It is not permissible to assume that the state of affairs here is analogous to the connections between nerves and striped muscular fibre, even although intestinal peristalsis may be proved to be influenced by nerve impulses. The state of affairs is more analogous to the action of the pneumogastric nerve on the heart; for while the peristaltic action may occur independently of the central nervous system, as has been proved by its occurrence in excised intestine, it also is influenced by nervous impulses passing along the splanchnic and pneumogastric nerves. We have, therefore, to infer that the movements are mainly due to nervous impulses starting in the ganglia found in the walls of the intestine,—the ganglia of Auerbach and Meissner's plexus,—and that these ganglia may be influenced by impressions traveling along these nerves. When the splanchnic nerve is cut, the peristaltic contractions are temporarily arrested, probably through the large supply of arterial blood which then passes through the walls of the intestine. On the other hand, if the splanchnic nerve be stimulated while active movement is going on, peristalsis is arrested, in this case probably through the consequent constriction of the intestinal blood-vessels. If the pneumogastric be stimulated, the intestinal movements are increased, especially when the splanchnic nerve has been cut, and it is probably through the pneumogastric that the movements of the intestine are reflexly influenced through the emotions.

Temperature is also of influence on the intestinal movements. Contact of the exterior with cold air, or the introduction of cold fluid into the interior, accelerates peristaltic movements; so, also, the more fluid the contents of the intestine, the more active are the intestinal movements, thus perhaps explaining the action of various cathartics which lead to the transudation of considerable quantities of fluid into the interior of the bowels.

The movements of the large intestine are the same as occur in the small intestine, but are less marked, owing to the modified, sacculated shape of this portion of the alimentary canal. Just as the peristalsis of the small intestine commences at the pylorus, the contractions of the walls

of the large intestine commence at the ileo-cæcal valve, which is the terminal point of the peristaltic movements of the small intestine. The movements of the large intestine are said not to be influenced by stimulation of the splanchnic nerves.

#### XIV. DEFÆCATION.

The contents of the alimentary tube, which are forced onward by the peristaltic movements of the walls of the intestine, are arrested at the lower extremity of the large intestine through the tonic contraction of the sphincters of the anus.

By defæcation is meant the mechanisms, partly voluntary and partly reflex, which are concerned in the evacuation of the contents of the lower bowel. The anus is closed by two muscles—an inner sphincter which consists of unstriped involuntary fibres, and an external sphincter composed of voluntary red striped muscles; both of these muscles are in a state of tonic contraction due to the constant transmission of impulses from a special centre located in the lumbar portion of the spinal cord, and which is only inhibited during the act of defæcation. The contact of the fæces with the mucous membrane of the rectum leads, as it is ordinarily described, to the desire to defæcate, and inhibits the contraction of the sphincter muscles. The peristaltic contraction of the larger bowel is then sufficient alone to evacuate the contents of the rectum, while a simultaneous elevation of the anus, through the contraction of the levator ani muscles, raises the floor of the pelvis and pulls the anus, to a certain extent, up over the descending fæcal mass, at the same time preventing distention of the pelvic fascia. "As the fibres of both levatores converge below and become united with the fibres of the external sphincter, they aid the latter during the energetic contractions of the sphincter." Defæcation is partly a voluntary movement and may be aided voluntarily through pressure produced by the contraction of the abdominal muscles. When the contact of the fæcal mass with the mucous membrane of the upper portion of the rectum originates a desire to defæcate, the impulse is transmitted to the brain and from this to the spinal cord, inhibits the centre of defæcation in the lumbar portion of the cord, and by this means relaxes the anal sphincter; a deep inspiration is then made and the glottis is closed; powerful voluntary contractions of the abdominal muscles press upon the abdominal contents and force the intestinal mass down into the pelvis, thus mechanically aiding peristalsis in causing the downward passage of the fæces.

The contraction of the anal sphincters is kept up through the action of a nervous centre situated in the lumbar spinal cord. If the connection of this centre with the sphincter is divided relaxation of the anus takes place, but section of the cord in the dorsal region only temporarily

inhibits the tonic contraction of the sphincter. By the action of the will the tonic action of the sphincter may be increased, or the action of the sphincter may be completely inhibited. While the abdominal contractions above alluded to aid in defæcation, the sigmoid flexure serves to ward off the pressure of the abdominal walls; therefore, the contraction of the abdominal muscles is not sufficient alone to produce defæcation, but must be accompanied by the peristaltic action of the large intestine and sigmoid flexure.

As a rule, the contraction of the abdominal muscles is voluntary, but the contact of the fæcal mass with the mucous membrane of the sigmoid flexure is itself sufficient to inaugurate and normally complete the act of defæcation. Therefore, defæcation may be produced in states of entire unconsciousness.

Evacuation of fæces occurs at various intervals in different animals—in the horse, usually six to seven times in the twenty-four hours; in the sheep, four to five times; and in the hog, once or twice.

In the act of defæcation in the horse, the loosely attached mucous membrane of the lower part of the rectum is also extruded, forming the so-called "rose of the anus," and is again retracted after the act is complete; the object of this is, perhaps, to reduce friction between the mucous surface and the more or less hard fæcal masses. The horse is able to evacuate its rectum while in motion; animals, as a rule, adopt a more or less squatting position, with the back highly arched, so as to increase the expulsive action of the abdominal muscles.



## SECTION III.

### ABSORPTION.

WE have already seen that the alimentary tube is developed as an involution of the external integument. Hence, even after having undergone the most perfect digestion, food-stuffs are practically still outside of the body, and can serve no nutritive purposes until they have entered the lymph- or blood-currents. This entrance of the digestive products into the circulation is termed *absorption*, and, as just indicated, substances reach the blood-current from the alimentary canal in one of two ways: either directly through the walls of the minute blood-vessels in the mucous membrane of the stomach and intestine, or through the mediation of the lymph-channels. Both of these modes occur in the absorption of digestive products.

1. **VENOUS ABSORPTION.**—The first of these modes of absorption is frequently termed venous absorption, as the entrance of substances into the blood in all probability occurs through the walls of the minute venous radicals, where there is not a sufficiently high pressure to interfere with the passage of fluids from without to within the vessels under the ordinary physical laws of filtration and osmosis. In fact, in the very arrangement of the capillary blood-vessels in the intestine we find the conditions at one time advantageous to the passage of fluid from within to without the blood-vessels, and again directly the reverse holding. Thus, after undergoing subdivision into the minute arterioles, we find the first capillary loops, where, consequently, the pressure is highest, distributed around the deep ends of the intestinal tubules: the conditions are there most favorable for the transudation of fluid from the interior of the vessels and the consequent formation of the intestinal secretion. The capillary loops, after leaving the deeper portions of the intestinal mucous membrane, when the blood has been deprived of water, then pass to the most superficial layers, and the conditions are then most favorable to absorption. The blood is more concentrated, from the loss of water in secretion; it, therefore, from the affinity of the albumen of the blood for water, favors the absorption of large quantities of water, which may, of course, hold nutritive matters in suspension. More than this, the blood-current is now becoming more accelerated, and the internal pressure on the walls of the vessels reduced, both of which conditions are favorable to absorption.

The substances which enter the blood by venous absorption are probably all those which are soluble in water, such as salts, sugar, soaps, and peptone, as we know that all of these will more or less readily diffuse through organic membranes outside of the body. The process of osmosis is generally accepted as explaining the mode of entrance of soluble substances into the blood, but many data are still required before this view can be acknowledged as conclusively established. In the case of grape-sugar the author has found that the osmotic equivalent of sugar absorbed from the stomach of the frog very closely corresponds with the equivalent of diffusion in ordinary physical experiments, and somewhat similar observations have been made for various salts and for peptone. There is still, however, a great deal of obscurity in the matter. We have seen that by the time the blood has left the secreting surfaces of the alimentary tube and reached the absorbing surfaces it has lost a good deal of its water. Now, if we assume that the absorption (of sugar, for instance) is governed by purely physical laws, we must admit that for every gramme of sugar that is absorbed seven and one-tenth grammes of water (the osmotic equivalent of sugar) will leave the blood to enter the intestine. The blood will, therefore, become progressively concentrated and the intestinal tube filled with fluid; consequently, every substance which has a high osmotic equivalent will be apt to prove a cathartic; and it has, indeed, been found that the higher the osmotic equivalent of the purgative salts, the more marked is their cathartic action, though the relation of cause and effect between these facts has been denied (Hay).

Consequently, though it is probable that osmosis is largely concerned in the absorption of substances which are soluble in water, the process is not a pure one, such as might occur between similar fluids separated by a membrane outside of the body. In the living animal the phenomena of filtration may greatly aid venous absorption. As we have seen, the contents of the venous radicals are subjected to but low pressure, and it is quite conceivable that the pressure exerted through its contractions by the intestine on its contents may aid the passage of fluids from the exterior to the interior of the veins. Here also we are unable to conceive of an uncomplicated process of filtration, for a pressure sufficiently great to force fluids through the walls of a blood-vessel would undoubtedly so compress that vessel as to obliterate its lumen.

From the above it follows that although the physical processes of osmosis and filtration underlie the absorption of salts, sugar, and peptone from the alimentary tract, neither process is entirely analogous to similar operations outside of the body, it being probable that the excess of pressure on the intestinal contents keeps down the osmotic equivalent, and again aids in the resorption of the transuded water; while, further, the

vital properties of the epithelial cells are in some way concerned in the absorption not only of fat, but of sugar, peptone, and salts. Lannois found that by the injection of alcohol into exposed loops of intestine the epithelial cells were destroyed, and the absorption of oil, sugar, peptone, and mineral salts was delayed. The tendency of opinion of late has been in favor of the epithelial cell as an active factor in absorption, as it is in secretion.

M. Leubuscher has made some experiments which seem to confirm this view. He found in isolated loops of intestine that the absorption of 25 to 50 per cent. solutions of salt took place just as rapidly as that of

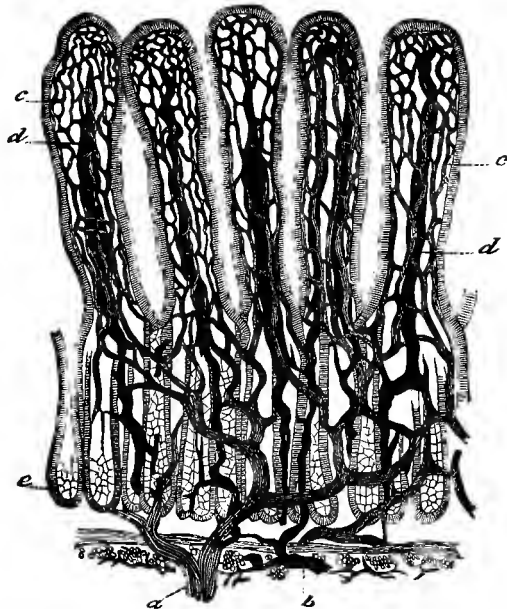

FIG. 167.—SECTION OF INTESTINE OF DOG SHOWING THE VILLI (*Cadiat*.)

The blood-vessels, *c*, and the lacteals, *d*, have been injected. The blind ending, or simple loop of the black lacteal, is seen to be surrounded by the capillary net-work of the blood-vessels.

pure water,—a phenomenon which would not take place if the law of diffusion were the sole factor in the process. The salts of sodium were absorbed more rapidly than the salts of potassium, and absorption was not hastened by the presence of bile—contrary to the general belief.

Gumelowski made a somewhat similar series of experiments, and reached much the same conclusion. Strong solutions of sulphate of sodium increase the rapidity of absorption.

Hofmeister, especially, has identified himself with the theory that the absorption of peptone is not a purely mechanical process of diffusion or filtration, but that it represents a function of certain living cells or

leucocytes, which in the assimilation of albuminoids fill a rôle analogous to that of the red blood-corpuseles in respiration. He assumes that the reason why peptone cannot be recognized in the blood is because it has combined with these lymphatic cells, and is, through their mediation, transported to different parts of the body; and he regards the rapid proliferation of the cells of the adenoid tissue of the intestinal mucous membrane and of the Peyer's patches as a morphological expression of the chemical processes of assimilation occurring in these tissues.

Thus, it seems that the process of absorption is as much a vital one as that of secretion, and that the epithelial or lymphatic cell not only aids the taking of fat into the blood, but also that of peptone (changing it to albumen), and of sugar and salts.

2. ABSORPTION BY THE LYMPHATICS.—Absorption by the lymphatics is accomplished through the instrumentality of the villi of the small intestine.

Each villus contains in its axis the commencement of a chyle-vessel, which is surrounded by a fine capillary net-work (Fig. 167). The chief purpose of this villous formation is evidently to obtain an increase of surface for absorption with economy of space; but each villus has, further, some special mechanism which aids the absorption of the intestinal contents, as is proved by the entrance into the chyle-vessels of globules of oil after having undergone emulsification by the bile and pancreatic juice.

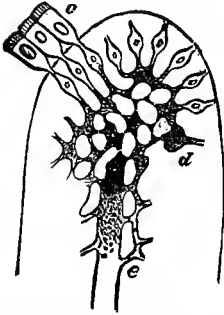

FIG. 168.—DIAGRAM OF THE RELATION OF THE EPITHELIUM TO THE LACTEAL RADICAL IN A VILLUS, AFTER FUNKE.

The protoplasmic epithelial cells are supposed to be connected to the absorbent vessel by adenoid tissue.

The fat-globules first enter the protoplasmic caps of the epithelial cells, from these pass into the tissue of the villus, and thence into the central chyle-duct (Fig. 168).

After an abundant fatty diet, this absorption of fat may be so active as to completely fill the network of lymphatics of the mesentery with milk-white, emulsified oil, and even sometimes give the blood-serum a milky-white color (Fig. 169). It further appears that the fat which is absorbed in a state of emulsion by these chyle-vessels is greatly in excess of the saponified fatty acids which may be absorbed by the veins; for, after a fat diet, nearly two-thirds of the amount of fat given as food may be recovered from the thoracic duct.

As regards the mechanism of fat absorption, the most probable view attributes the entrance of the oil-globules into the epithelial cells of the villus to a true, protoplasmic, selective power exerted by the contents of these cells, and entirely analogous to the mechanism of feeding possessed by the amœba and other infusoria.

Microscopic examination of the intestinal epithelium after a full meal which is rich in fatty elements of food will reveal the fact that the epithelium of the villi is crowded with minute oil-globules. These

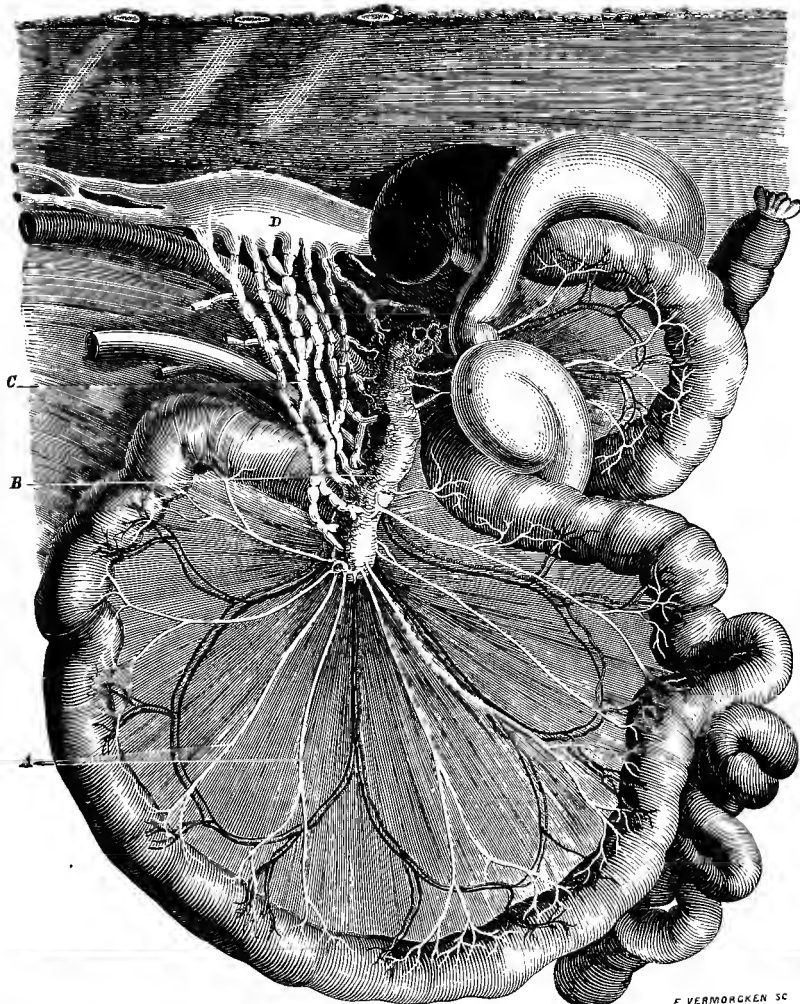

FIG. 169.—LACTEALS OF A DOG DURING INTESTINAL DIGESTION. (*Colin.*)  
*A*, lacteals of mesentery; *B*, mesenteric glands; *C*, efferent chyle-ducts; *D*, receptaculum chyli.

globules may be found in the substance of the epithelial cell itself and in its free, protoplasmic cap (Fig. 170).

When once the absorbed fat has reached the central chyle-vessel of the villus, its onward progression through the lymphatics admits of

ready explanation. Each villus under the epithelial coat is supplied with a layer of pale muscular fibres, and when these contract, the central chyle-vessel being full, the effect must be to press out the contents of the central vessel in the direction of the thoracic duct, at the same time emptying the capillary vessels by pressure. When, now, the muscular fibres relax, the capillaries will again become filled, and by the turgidity of the net-work of blood-vessels cause the central vessel to become expanded, and so exert a certain amount of suction in the interior of the villus since the valves in the lymphatics will prevent regurgitation

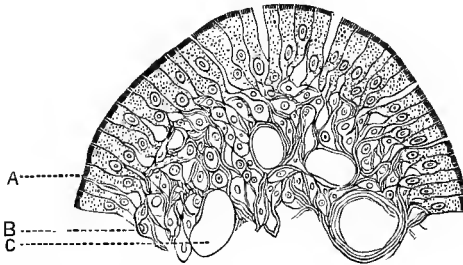

FIG. 170.—SECTION OF AN INTESTINAL VILLUS OF A HORSE. (*Ellenberger.*)

A, epithelium; B, adenoid tissue; C, commencement of lacteal.

from the mesenteric vessels. Each villus may therefore be regarded as a minute lymphatic heart, which fills itself from the interior of the villus in dilating, and in contracting forces its contents into the circulation.

In addition to the absorption of fat, it is evident that other substances contained in the intestinal contents will also mechanically be drawn into the villus with the oil-globules. Thus, unchanged albumen may be absorbed in this manner and has been found in the contents of the chyle-vessels.

## SECTION IV.

### CHYLE.

THE chyle is the chyme which has been absorbed by the intestinal villi and the thoracic duct through the mesenteric lymphatics. In the receptaculum chyli it is mixed with the lymph coming from the lower extremities.

It may be obtained pure in the ox from the large trunk which accompanies the anterior mesenteric artery (Fig. 171).

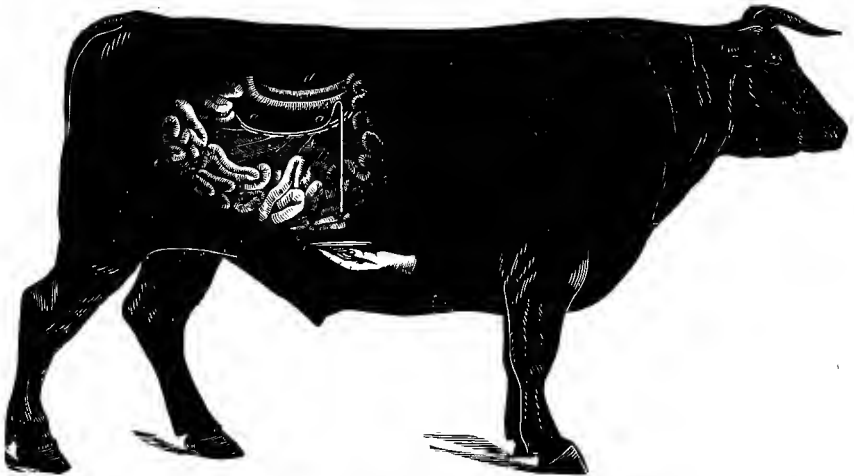

FIG. 171.—COLLECTION OF CHYLE IN THE OX. (*Colin.*)

An incision is made in the right flank of an animal in active digestion, and one of the chyle-vessels which accompany the mesentery artery is ligated. When it becomes distended a silver cannula terminating in a rubber tube may be readily inserted.

It is a milky-white, or occasionally reddish, opaque liquid, of alkaline reaction, saltish taste, and a specific gravity which varies between 1007 and 1022.

In a fasting animal the chyle found in the thoracic duct and mesenteric lymphatics is pale and transparent, or perhaps somewhat reddish in tint. During the absorption of a meal containing fat, we have seen that it becomes milky in appearance even in the very beginnings of the lymphatic radicals in the villi.

In the adult herbivora, whose diet is, as a rule, comparatively poor in fatty matters, the chyle is scarcely opalescent, or may be perfectly

transparent, and of yellowish or reddish tint. In suckling herbivora, as in the carnivora, it is milky.

In its passage from the intestine to the thoracic duct it undergoes important changes in composition. At first it contains albumen in solution, oil-globules in suspension, and is not spontaneously coagulable. After it passes through the mesenteric lymphatic glands lymph-corpuscles are added, and it acquires the property of undergoing fibrinous coagulation. It becomes poorer in albumen and fats in its onward progress, and richer in corpuscles and fibrin.

When taken from the thoracic duct after a full meal of fat it is a white, milky-looking fluid, which undergoes spontaneous coagulation on exposure to the air. The nature of the coagulation of the chyle is identical with that of the blood, to be subsequently studied, and is due to the addition in the mesenteric glands of immature blood-corpuscles and fibrin factors.

Examined under the microscope, the coagulated chyle obtained from the thoracic duct contains fibrin, a large number of white blood- or lymph-corpuscles, a few immature red blood-cells, oil-globules inclosed in albuminous envelopes, and fatty granules.

The composition of chyle differs in different animals and at different periods in the same animal, dependent on the rapidity and nature of absorption taking place from the intestinal surface. In the chyle obtained from horses fed with hay the fat scarcely exceeds in amount that found in the blood, at most not more than 1 per cent., while it may rise to 3.10 per cent. in horses fed with oats. It is made up of formed elements (lymph-corpuscles added as the chyle passes through the mesenteric lymphatics) suspended in a fluid medium (serum).

The serum contains the following bodies in solution in water:—

1. Globulin, alkali albuminate, serum-albumen, and peptones in small amount, rising during digestion to 0.6–0.7 per cent.
2. Cholesterin, lecithin, and fatty soaps.
3. Dextrose, varying from a mere trace to 2 per cent., depending on the amount of carbohydrates in the food.
4. Urea derived from the lymph, and alkaline laetates, especially in the herbivora, and after starchy food.
5. Inorganic salts of the alkalies and alkaline earths, iron, phosphoric acid, etc. (Charles).

As a result of sixteen analyses of the chyle of the horse, Gorup-Besanez gives the following figures:—

Water,	. . . . .	871.0 to 967.9	in 1000 parts.
Albumen,	. . . . .	19.32 “ 60.53	“
Fat,	. . . . .	traces “ 36.01	“

The chyle possesses the power of converting starch into sugar,



probably due to the absorption of the amyolytic ferment of the pancreas from the intestinal canal.

*Chyle of Man (Rees).*

Water,	90.48	per cent.
Solids,	9.52	“ “
<hr/>		
Fibrin,	trace	“ “
Albumen,	7.08	“ “
Fats, lecithin, cholesterin, etc.,	0.92	“ “
Extractives,	1.0	“ “
Salts,	0.44	“ “

*Chyle of Dog (Hoppe-Seyler).*

Water,	90.67	“ “
Solids,	9.02	“ “
<hr/>		
Fibrin,	0.11	“ “
Albumen,	2.10	“ “
Fats, lecithin, cholesterin, etc.,	6.48	“ “
Fatty acid and soaps,	0.23	“ “
Salts,	0.79	“ “

*Chyle of Horse (C. Schmidt).*

Serum,	96.74	“ “
Clot,	3.25	“ “
<hr/>		
Water,	88.7	“ “
Solids,	11.2	“ “
<hr/>		
Fats,	0.15	“ “
Soaps,	0.08	“ “
Fibrin,	3.89	“ “
Albumen, sugar, and extractives,	6.59	“ “
Hæmatin,	0.20	“ “
Sodium chloride,	0.23	“ “
Sodium,	0.13	“ “
Potassium,	0.07	“ “
Phosphates and sulphates,	0.11	“ “

The following table gives the composition of the chyle from the thoracic duct in the ruminant under different conditions (Würtz):—

	Ox.		Cow.	Cow.
	Before Rumi- nation.	After Rumi- nation.	Fed with Hay and Straw.	Fed with Straw and Clover.
Water,	950.89	929.71	951.24	962.21
Fibrin,	1.76	1.96	2.82	0.93
Albuminoids,	39.74	59.64	38.84	26.48
Fats,	0.81	2.55	0.72	0.49
Salts (soluble in alcohol),	2.47	2.50	2.77	1.92
Salts (soluble in water),	4.33	3.61	3.59	7.97

Pure chyle from the mesenteric vessels of the ox before mixture with the lymph has a specific gravity of 1013 and contains in 100 parts

0.0019 parts of dry fibrin. The serum contains 4.75 per cent. solids (albumen, fats, salts, etc.), and 95.21 per cent. of water.

The amount of chyle is proportional to the activity of digestion, after a hearty meal the mesenteric vessels and thoracic duct being distended with a milky emulsion, while during fasting they are collapsed and are only seen with difficulty.

The movement of the chyle is dependent upon a number of causes. In the first place, as mentioned in the description of the mechanisms of absorption of fat, the villi may be regarded as lymphatic hearts, the contraction of their muscular fibres leading to an onward movement of the contents of the mesenteric lacteals, backward flow being prevented by the valves of these vessels.

The respiratory movements are also of influence in producing an onward flow of the contents of the thoracic duct. With each act of expiration, as may be readily determined by making a fistula of the thoracic duct where it empties into the veins at the root of the neck, there is an acceleration in the flow of chyle, evidently from compression of the duct, while in inspiration this flow is retarded or may be even arrested. Inspiration, therefore, by the production of negative pressure, favors the flow of chyle from the lacteals into the thoracic duct.

Contraction of the abdominal muscles, and even intestinal peristalsis, will further aid the forward movement of the chyle. So, also, it has been noticed that there is a slight increase in the rapidity of the flow of chyle coincident with each systole of the heart. While this factor is comparatively insignificant, it acts by the compression of the thoracic duct where it passes under the arch of the aorta.

Finally, in addition to these influences and to the *vis a tergo* from continuous absorption by the villi and the propulsion due to their contraction, the most important factors, there is also a *vis a fronte* concerned in the circulation of the chyle. For, as Draper has pointed out, where the thoracic duct empties into the veins, a suction force is exerted on the contents of the lacteals by the passing current of the venous blood, upon the well-known hydraulic principle of Venturi: "If into a tube, through which a current of water is steadily flowing, another tube opens, its more distant end being in communication with a reservoir of water, through this tube a current will likewise be established, and the reservoir will be emptied of its contents."

## SECTION V.

### LYMPH.

As THE blood circulates through the capillaries, it is continually losing a portion of its fluid constituents through transudation, carrying with the water of the blood various salts, gases, and organic matters in solution. This fluid, which is termed the lymph, bathes all the ultimate tissue elements and supplies them directly with materials necessary for their nutrition, at the same time removing the soluble effete matters which result from cellular activity. This fluid, thus resulting from transudation from the blood-vessels, not only fills all the intercellular clefts of the different tissues, but also finds its way from the extra-vascular spaces and large lymph-spaces (as the lacunæ of the connective tissue and great serous sacs) through the minute radicals of the lymphatic vessels to the lymphatic glands, and from there through the large lymphatic trunks again enters the blood-vessels (veins in the neighborhood of the heart).

From its origin it is evident that the lymph must have a composition closely similar to that of the liquor sanguinis; but since different organs take from the lymph different substances needed by their nutritive demands, and yield effete matters of varying composition, its composition must vary according to the region from which it is taken and the stage of activity of the organs contributing to it. This contrast of lymph, drawn from different localities, is most marked in the lymph taken from the lymphatics of the mesentery during the period of digestion when compared with that drawn from other localities. Lymph drawn from the so-called lacteals during the digestion of fat is termed *chyle*, and is of a milky appearance from the large quantities of minute fat-globules which it holds in suspension. The characters of the chyle have been already considered.

Lymph may be obtained by inserting a cannula into the thoracic duct of an anesthetized animal where it empties into the junction of the large veins at the root of the neck; or in large animals, such as the horse and ox, it may be collected by a similar process from the lymphatics which accompany the carotid artery.

The amount of lymph which may be obtained by such a process varies under different circumstances. It is increased by active or passive movements, by venous obstructions, and by poisoning with curare. It is diminished by decrease in blood pressure.

When freshly drawn from the thoracic duct of fasting animals, lymph is a transparent, slightly yellowish fluid; when collected during digestion, it is milky from the fat in suspension derived from the chyle. When examined under the microscope, lymph is seen to contain colorless corpuscles, identical with the colorless blood-corpuscles, floating in a clear lymph-plasma: these corpuscles are much fewer in number in lymph drawn from the lymphatic radicals, while they are comparatively abundant in the lymph as it issues from the lymphatic glands. Although the lymphatic glands are the principal manufacturers of the lymph-corpuscles, they are not their sole source. The lymph-cells also originate wherever adenoid tissue is found, as in the mucous membrane of the stomach and intestines, in the thymus, tonsils, and spleen.

The lymph of animals in active digestion is milky from admixture with the fatty chyle: such lymph is said to have a *molecular basis* from the finely divided fat-globules which it holds in suspension. These particles often exhibit Brownian movements.

The amount of lymph can only be approximately estimated. It has been reckoned that for every two hundred and twenty pounds of body weight there is contained in the body about thirteen and a half pounds of lymph and chyle—seven and a half pounds being chyle and six pounds lymph. As much as six kilos of lymph have been collected in two hours from the lymphatic trunk in the neck of the horse, while in twenty-four hours ninety-five kilos of lymph and chyle have been collected from the thoracic duct of the ox. The amount of these two fluids (lymph and chyle) will evidently increase during digestion. Active and passive movements and increased blood pressure, as well as obstruction of the veins, by facilitating transudation from the blood-vessels, will increase the amount of lymph.

Lymph is a viscid fluid, slightly less alkaline than blood, having a specific gravity that varies from 1022 to 1037, or occasionally as high as 1045. When removed from the body it coagulates in from five to twenty minutes, the process being analogous to the coagulation of blood-plasma, though much slower, perhaps on account of its high alkalinity. The coagulation of lymph may be accelerated by the addition to it of a few drops of defibrinated blood by the addition thus accomplished of fibrin factors in larger amount. A soft, trembling jelly is first formed, which gradually contracts, expressing out a clear lymph-serum, in which floats a colorless contracted coagulum, composed of fibrin which is identical with that formed in blood coagulation.

From 1000 parts of the lymph of a foal, Schmidt determined that 955.17 were serum, while only 44.83 were coagulum. After death the lymph usually remains perfectly fluid in the lymphatics, and does not coagulate when the lymph-current is arrested during life.

Lymph is very variable in its chemical composition. It may be generally stated as follows:—

Water, . . . . .	: . . . .	93 to 98 per cent. (Charles).
Solids, . . . . .	. . . . .	6 “ 2 “
Albumen, . . . . .	. . . . .	3.2 “ 0.3 “
Fats, . . . . .	. . . . .	2.5 } to 0.15 per cent.
Extractives, . . . . .	. . . . .	0.1 }
Ash, . . . . .	. . . . .	0.7 to 0.8 “

Sodium chloride forms about 0.6 per cent. The proteids consist of fibrinogen, serum-globulin, and serum-albumen. Lymph yields only 0.4 to 0.8 per one thousand of fibrin, being much less, therefore, than the amount obtainable from blood.

In the ash of lymph sodium chloride is very abundant and phosphates scanty: the lymph-cells, however, contain an excess of potassium and phosphoric acid, as compared with the serum, the latter having an excess of sodium. Urea is always present (0.019 per cent. in the cow), and grape-sugar (0.16 per cent. in the dog), though it has been stated that chyle does not take up sugar when animals have been fed on a starchy or saccharine diet.

The lymph contains CO<sub>2</sub>, N, and traces of O when pure and un-mixed with blood. The amount of CO<sub>2</sub> is greater than in arterial but less than in venous blood. While the quantity of N is about the same as in the blood, the amount of O is always less than in the blood, thus showing that the tissues rapidly appropriate the O of the blood.

The following table gives a comparison of the composition of the lymph and blood:—

	LYMPH (Wurz).		BLOOD (Nasse).	
	Ox.	Cow.	Ox.	Calif.
Water, . . . . .	938.97	955.38	799.59	826.44
Fibrin, . . . . .	2.05	2.20	3.62	5.737
Albumen and extractives, . . . . .	50.90	34.76	66.901	56.414
Fats, . . . . .	0.42	0.24	2.045	1.610
Salts, . . . . .	7.46	7.41	7.041	8.241
Blood-corpuscles, . . . . .		.....	121.865	102.803

## RESULTS OF THE QUANTITATIVE ANALYSIS OF LYMPH AND CHYLE.

### I. ANALYSES OF THE LYMPH OF MAN.

CONSTITUENTS IN 100 PARTS.	Gubler and Quevenne.		Marchand and Colberg.	Scherer.	Dännhardt and Hensen.	Odenius and Lang.
	I.	II.	III.	IV.	V.	VI.
Water, . . . . .	93.99	93.48	96.93	95.76	98.63	94.36
Solid matters, . . . . .	6.01	6.52	3.07	4.24	1.37	5.64
Fibrin, . . . . .	0.05	0.06	0.52	0.04	0.11	0.16
Albumen, . . . . .	4.27	4.28	0.43	3.47	0.23	2.12
Fats, . . . . .	0.38	0.92	0.26		0.15	2.48
Extractive matters, . . . . .	0.57	0.41	0.31			0.16
Salts, . . . . .	0.73	0.82	1.51	0.73	0.88	0.72

## II. ANALYSES OF THE LYMPH OBTAINED FROM THE LYMPHATICS OF THE HORSE (C. SCHMIDT).

CONSTITUENTS IN 1000 PARTS.	I.	II.
Water, . . . . .	963.93	955.36
Solid matters, . . . . .	36.07	44.64
Fibrin, . . . . .	28.84	34.99
Albumen, . . . . .		
Fats and fatty acids, . . . . .		
Other organic matters, . . . . .		
Inorganic matters, . . . . .	7.22	7.47
NaCl, . . . . .	5.43	5.67
Na <sub>2</sub> O, . . . . .	1.50	1.27
K <sub>2</sub> O, . . . . .	0.03	0.16
SO <sub>3</sub> , . . . . .	0.03	0.09
P <sub>2</sub> O <sub>5</sub> , combined with alkalis, . . . . .	0.02	0.02
Ca <sub>3</sub> (PO <sub>4</sub> ) <sub>2</sub> , . . . . .	0.22	0.26
Mg <sub>3</sub> (PO <sub>4</sub> ) <sub>2</sub> , . . . . .		
In the serum from 1000 parts of lymph Schmidt found:—		
Albumen, . . . . .	23.32	{ 30.50
Fats and fatty acids, . . . . .		
Other organic matters, . . . . .		
	4.48	1.69

## III. ANALYSES OF CHYLE OF THE HORSE, DOG, AND MAN (HOPPE-SEYLER).

CONSTITUENTS IN 1000 PARTS.	I. Chyle of Horse.	II. Chyle of Horse.	III. Blood-Serum.	IV. Chyle of Dog.	V. Blood-Serum of Dog. IV.	VI. Chyle of Man.
Water, . . . . .	960.97	956.19	930.75	906.77	936.01	904.80
Solids, . . . . .	39.03	43.81	69.25	96.23	63.99	95.20
Fibrin, . . . . .	2.57	1.27		1.11	45.24	70.8
Albumen, . . . . .	22.60	29.85	56.59	21.05		
Fats, cholesterin, and lecithin, . . . . .	0.09	0.53		64.86	6.81	9.2
Fatty acids in the form of soaps, . . . . .	0.76	0.28	1.57	2.34	2.91	10.8
Other organic matters, . . . . .	5.37	2.24	3.85			
Hæmatin, . . . . .	0.05	0.06				
Mineral salts, . . . . .	7.59	7.49	7.14	7.92	8.76	4.4
Loss, . . . . .					0.27	
NaCl, . . . . .	5.76	5.84	5.74			
Na <sub>2</sub> O, . . . . .	1.31	1.17	0.87			
K <sub>2</sub> O, . . . . .			0.13	0.14		
SO <sub>3</sub> , . . . . .	0.07	0.05	0.11			
P <sub>2</sub> O <sub>5</sub> , . . . . .	0.01	0.05	0.01			
Ca <sub>3</sub> (PO <sub>4</sub> ) <sub>2</sub> , . . . . .	0.44	0.25	0.26			
Mg <sub>3</sub> (PO <sub>4</sub> ) <sub>2</sub> , . . . . .						
CO <sub>2</sub> , . . . . .	1.02	0.82	0.56			

Schmidt gives the following analysis of the lymph of a cow:—

Serum, . . . . .	95.52	
Clot, . . . . .	<u>4.42</u>	
	In 100 parts	In 100 parts
	Serum.	Clot.
Water, . . . . .	95.76	90.73
Fibrin, . . . . .		4.86
Other albumens, . . . . .	3.20	
Fats, . . . . .	0.12	3.43
Organic matter, . . . . .	0.17	
Salts, . . . . .	0.74	0.96
Sodic chloride, . . . . .	0.56	0.60
Soda, . . . . .	0.13	0.06
Potash, . . . . .	0.01	0.10
Sulphuric and phosphoric acids and earthy phosphates, . . . . .	0.04	0.23

The lymph further differs in composition according to the locality from which it is collected. The following table gives the composition of the lymph of the horse:—

	Lymph Collected from the Femoral Vessels (Gmelin).	Lymph Collected from the Cervical Vessels (Leuret and Lassaigue).	Lymph Collected from the Vessels of the Foot (Geiger).	Lymph from the Vessels of the Foot of an Ass (Rees).
Water, . . . . .	964.30	925.00	983.70	965.36
Solids, . . . . .	35.70	75.00	16.30	34.64
Fibrin, . . . . .	1.90	3.30	0.40	1.20
Albumen, . . . . .	21.17	57.36	6.20	12.00
Fats, . . . . .	traces		traces	traces
Extractives, . . . . .			2.70	15.69
Inorganic matters, . . . . .	10.63	14.34	7.00	5.85

*The Circulation of the Lymph.*—The lymph is continually moving in the lymphatic vessels in a slow stream from the lymphatic radicals to the larger lymphatic trunks, and thence into the large veins in the neighborhood of the heart, motion being due to the difference in pressures between the lymphatic capillaries and the entrance of the lymph-trunks into the veins.

Since the lymph originates as a transudation from the blood-vessels in the interstitial spaces, the pressure to which it is subjected will be nearly identical to the pressure in the blood-vessels which causes its passage through the vascular walls. Each volume of lymph will, therefore, be forced onward by the amounts which succeed it under a pressure which is nearly equal to the blood pressure. On the other hand, the pressure of the lymph at the points of entrance of the lymphatics into the veins will be in all cases slight, and sometimes will be even negative; for during inspiration the expanding thorax aspirates the blood from

the large venous trunks into the veins of the thorax, and by the dilatation of the right auricle from thence into the heart. As the lymphatics empty into the veins in the neighborhood of the heart, this aspiration will also be exerted on the lymphatics and will tend to produce a negative pressure. The lymph will, consequently, be subjected to a steadily decreasing pressure from the periphery to the central vessels, and will, therefore, move from the lymphatic radicals toward the venous trunks. The onward motion of the lymph is also facilitated by muscular movements, which, by compressing the lymphatics, force their contents onward, backward motion being prevented by numerous valves.

The lymphatic vessels, also, possess the power of rhythmic contraction, through the contraction of their muscular fibres, and sometimes true lymph-hearts aid the propulsion of the lymph.

In certain organs special mechanisms are concerned in the propulsion of the lymph. Thus, in the abdominal surface of the central tendon of the diaphragm there are free communications between the peritoneal cavity and the lymphatics of the diaphragm; and as the central tendon is composed of two layers of fibrous tissue arranged in different directions, these layers are alternately pressed together and pulled apart in the respiratory movements of the diaphragm. The effect is to pump lymph into the spaces between these layers. A similar mechanism exists in the costal pleura and in the fascia covering the muscles. "When a muscle contracts, lymph is forced out from between the layers of the fascia, while, when it relaxes, the lymph from the muscle, carrying with it some of the waste products of muscular action, passes out of the muscle into the fascia, between the now partially separated layers" (Landois). While the lymph-glands offer considerable resistance to the onward passage of the lymph, this is, to a certain extent, compensated by the non-striated muscular fibres which exist in the capsule and trabeculae of the glands, these muscles, together with those of the lymphatics and lymphatic hearts, when present, being directly under the control of the nervous system.

The velocity of the lymph-current increases as the trunk increases in size, from the decrease in sectional area. In the large lymphatic in the neck of the horse it has been placed at two hundred and thirty to three hundred millimeters per minute; it must, therefore, be very slow in the small vessels. The lateral pressure in the lymphatics in the neck of the horse has been estimated at from ten to twenty millimeters of a weak soda solution (Weiss).



## SECTION VI.

### THE BLOOD.

THE blood may be regarded as the main organ of nutrition, since, on the one hand, the assimilated food-stuffs enter into it at the point of their absorption to be carried to the points where they may be needed by the economy; and, on the other hand, the results of tissue waste are given up to it to be removed from the economy.

The blood may be regarded as a cellular tissue with a fluid inter-cellular substance in perpetual motion within a system of branching tubes. The blood is not a homogeneous solution, but is composed of an immense number of minute-formed elements, the blood-corpuscles or cells, suspended in a colorless, transparent fluid, the blood-plasma. Of the blood-corpuscles, the so-called red cells are greatly in excess, and it is to the hæmoglobin, or red coloring-matter, which they contain that the red color of the blood is due.

The red hue of the blood drawn from a living animal will vary according to the locality from which it is taken; the blood taken from the arteries, the left side of the heart, or the pulmonic veins being of a bright, scarlet-red color, while that drawn from the veins, the right side of the heart, or the pulmonic artery, is dark, brownish red. When exposed to air or to oxygen gas, the dark venous blood becomes arterial in hue, and this change occurs most rapidly when the blood and gas are shaken up together.

The specific gravity of defibrinated human blood varies from 1045 to 1062, the average being 1055, though greater variations than the above are not inconsistent with health. Again, the specimens of blood first drawn will have a higher specific gravity than that examined after considerable hemorrhage, as the water in the blood will have then increased from the abstraction of fluid from the tissues. The cells are specifically heavier than the plasma, and of the former the red cells are heavier than the white. Thus, if blood is prevented by cold from coagulation—and this is best accomplished with horse's blood—the blood will separate into three distinct strata, the lowest being composed of red corpuscles, the middle of white cells, and the upper layer of the clear blood-plasma. The corpuscles have a density of 1088–1105; the plasma, of 1027–1028.

The reaction of the blood is always distinctly alkaline, due to sodium

bicarbonate and sodic phosphate, most marked when the blood is freshly drawn, and decreasing rapidly in intensity until coagulation occurs.

Blood has a peculiar odor which varies in different animal species, and in certain animals, as in the cat, dog, sheep, and goat, is characteristic of the species. This odor is due to the presence of certain volatile, fatty bodies contained in the blood-plasma, and may be readily developed by treating the blood with sulphuric acid.

The temperature of the blood varies in different animals, and depends upon the oxidation processes continually occurring in the tissues. In man and the domestic mammals the temperature varies from  $37.5^{\circ}$  to  $38^{\circ}$  C. In birds it is always higher than in mammals, and may rise as high as  $44.03^{\circ}$  C. even in a state of health. The arterial blood is, as a rule, warmer than venous blood, as the conditions for radiation of heat are more favorable in the latter than in the former. The temperature of the blood of the hepatic and portal veins is warmer than other venous blood, and the blood of the right side of the heart is warmer than that of the left heart.

The quantity of blood varies in different animals and in the same species of animal at different periods of life. Various methods have been proposed for determining the amount of blood contained in the body. The method which is now generally adopted as giving the most reliable results is to bleed an animal to death and measure the amount of blood collected. The blood-vessels are then washed out with dilute saline solution until the fluid which issues from the veins comes out entirely colorless, and the various washings are collected and mixed. A known quantity of blood is then diluted with saline solution until it acquires the same tint as a measured quantity of the washings collected from the veins. From the data so obtained the amount of coloring matter in the washings may be estimated. The entire body is then minced, washed free from blood with saline solution, filtered, and the amount of coloring matter in the washings estimated as before. The quantity of blood in the two washings, together with the blood first drawn, give the total amount in the body.

Estimated in this way, the total amount of blood in the human body has been fixed at  $\frac{1}{13}$  of the body weight; in the rabbit at  $\frac{1}{18}$  of the body weight; dog,  $\frac{1}{15}$  of the body weight; cat,  $\frac{1}{21}$ ; frog,  $\frac{1}{15}$ ; mouse,  $\frac{1}{2}$ ; the guinea-pig,  $\frac{1}{9}$ ; bird,  $\frac{1}{10}$ – $\frac{1}{13}$ ; fishes,  $\frac{1}{4}$ – $\frac{1}{9}$ . No reliable estimates exist as to the amount of blood in the larger domestic animals. Colin states that the amount of blood in the ox amounts only to  $\frac{1}{23}$  of the body weight, but this is probably a low estimate. In animals bled to death the amount of blood retained in the body depends upon the amount of adipose tissue: the fatter the animal, the more blood remains in the body after slaughtering. In thin cattle the amount of blood which escapes

has been estimated at 4.7 per cent. of the body weight; in fat animals, at 3.9 per cent. In the horse the amount of blood has been estimated at  $\frac{1}{8}$  of the body weight.

The following tables represent the general composition of the blood in different domestic animals:—

*In One Hundred Parts Venous Blood (Hoppe-Seyler and Fudakowski).*

	Horse.	Dog.
Corpuscles, . . . . .	32.62	38.34
Plasma, . . . . .	67.38	61.66

*One Hundred Parts Plasma.*

Solids, . . . . .	9.16	7.87
Water, . . . . .	90.84	92.13
Fibrin, . . . . .	1.01	0.18
Albumen, . . . . .	7.76	6.10
Fats, . . . . .	0.12	0.21
Extractives, . . . . .	0.40	0.39
Soluble salts, . . . . .	0.64	0.82
Insoluble salts, . . . . .	0.17	0.17

*One Hundred Parts Corpuscles.*

Water, . . . . .	56.50	. . .
Solids, . . . . .	43.50	. . .

*In One Hundred Parts Defibrinated Venous Blood of Ox (Bunge).*

	Corpuscles.	Serum.
Water, . . . . .	31.87	68.13
Solids, . . . . .	19.12	62.22
Albumen, . . . . .	12.75	5.91
Hæmoglobin, . . . . .	3.42	4.99
Other organic matters, . . . . .	8.94	. . .
Inorganic matters, . . . . .	0.24	0.38
Potassium, . . . . .	0.15	0.54
Sodium, . . . . .	0.0238	0.0173
Lime, . . . . .	0.0667	0.2964
Magnesium, . . . . .	. . .	0.0070
Iron oxide, . . . . .	0.0005	0.0031
Chlorine, . . . . .	. . .	0.0007
Phosphoric acid, . . . . .	0.0521	0.2532
	0.0224	0.0181
	Ox.	Calf.
Water, . . . . .	799.59	826.71
Fibrin, . . . . .	3.62	5.76
Fat, . . . . .	2.04	1.61
Corpuscles, . . . . .	121.86	102.50
Albumen, . . . . .	66.90	56.41
Alkaline phosphates, . . . . .	0.468	0.957
“ sulphates, . . . . .	1.181	0.269
“ carbonates, . . . . .	1.071	1.263
Sodium chloride, . . . . .	4.321	4.864
Iron oxide, . . . . .	0.731	0.631
Calcium, . . . . .	0.098	0.130
Phosphoric acid, . . . . .	0.123	0.109
Sulphuric acid, . . . . .	0.018	0.018

1. THE RED BLOOD-CORPUSCLES.—Human red blood-corpuscles resemble biconcave lenses: their diameter varies between 0.0064 and 0.0086 millimeters.

In man and all mammalia, with the exception of the camel tribe, they are circular and devoid of a nucleus; in birds, reptiles, and most fish, they are oval, biconvex, and nucleated; in the camel, the red blood-cells are oval, but are not nucleated. From the fact that the edges of the red blood-cells are convex and the centre concave, these different parts refract light differently, and when examined under the microscope, if the edges are sharply defined, the centres appear dark, and *vice versa* (Fig. 172).

There is no constant relation between the size of an animal and the size of its blood-disks; thus, among mammals, although the red blood-corpuseles of the elephant are the largest, those of the mouse are by no means the smallest, being, in fact, three times as large as those of the musk-deer (Fig. 173).

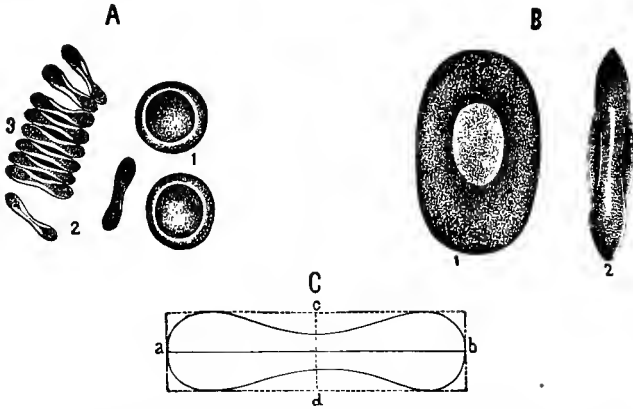

FIG. 172.—RED BLOOD-CORPUSCLES. (Landois.)

A, human red blood-corpuseles: 1, seen on the flat; 2, on edge; 3, rouleaux of colored corpuseles slightly separated. B, colored amphibian blood-corpuseles: 1, seen on the flat, and, 2, on edge. C, ideal transverse section of a human red blood-corpusele magnified five thousand times linear: *a b*, diameter; *c d*, thickness.

In the various domestic animals their diameter is placed as follows in fractions of a millimeter: horse, 0.004–0.005; ox, 0.003–0.005; dog, 0.005–0.007; sheep, 0.002–0.004; goat, 0.002; hog, 0.003–0.004 millimeters. Frequently, particularly in growing animals and after profuse hemorrhage or exhausting disease, red blood-corpuseles smaller than the above will be found. These are probably to be regarded as young, growing blood-cells. The number of the red blood-cells is almost infinite; in one cubic centimeter of blood in man, five million red blood-disks have been estimated to be present; in the goat, nine to ten millions; in the lamb, thirteen to fourteen millions; in birds, one to four millions; in the fish, one-quarter to two millions; in the frog, half a million; and in the proteus, thirty-six thousand. In fact, 30 to 40 per cent. of the entire mass of the blood is composed of red blood-corpuseles; thus, in the horse,

63.7 per cent. of the blood is constituted by the plasma, and 36.3 per cent. blood-corpuses. The red corpuscles, as already mentioned, are heavier than the other constituents of the blood, and are the cause of

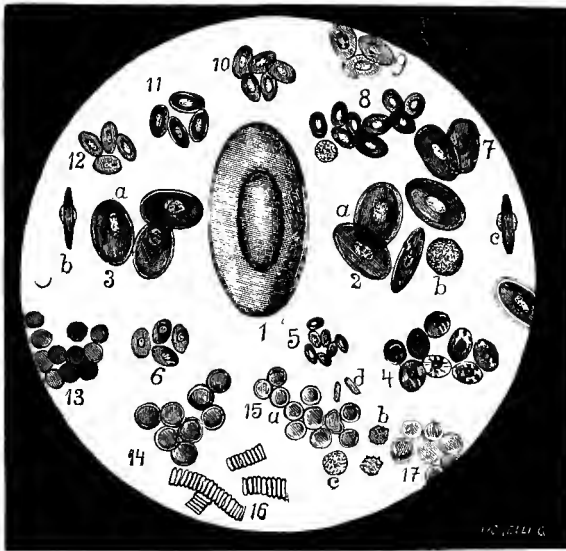

FIG. 173.—BLOOD-CORPUSCLES OF DIFFERENT ANIMALS. (*Thanhoffer.*)

1, proteus; 2, rana esculenta: *a*, upper view; *b*, white blood-corpusele; *c*, side view of red blood-corpusele; 3, triton; 4, snake; 5, camel; 6, turtle; 7, salamander; 8, carp; 9, cobitis fossilis; 10, cuckoo; 11, chicken; 12, canary-bird; 13, lion; 14, elephant; 15, man: *a*, upper view; *b*, crenated form; *c*, colorless corpusele; 16, horse, the cells arranged in rouleaux; 17, hippopotamus, upper view.

the color and opacity of the blood; their specific gravity may be placed at about 1090. If water is added to blood, it appears darker in reflected light, but is more transparent. This depends upon the change in shape

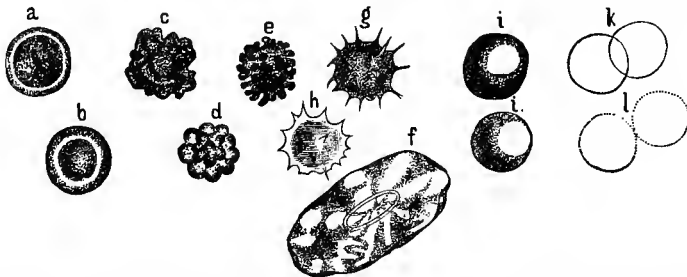

FIG. 174.—RED BLOOD-CORPUSCLES, SHOWING VARIOUS CHANGES IN SHAPE. (*Landois.*)

*a*, *b*, normal human red corpuscle, with the central depression more or less in focus; *c*, *d*, *e*, mulberry forms; *g*, *h*, crenated corpuscles; *k*, pale, decolorized corpuscles; *i*, stroma; *j*, a frog's corpuscle, partly shriveled, owing to the action of a strong saline solution.

of the red blood-cells: as they imbibe water they swell up, and so reflect less light, and at the same time the co-efficient of refraction differs less than normal from that of the blood-serum. On the other hand, if salt

solution is added to blood instead of water, the corpuscles shrivel up and therefore favor the reflection of light and prevent its transmission; hence the blood is now less transparent, but appears lighter in reflected light (Fig. 174).

The red blood-corpuscles are almost fluid in consistence, and resemble, therefore, suspended drops of jelly. This characteristic is frequently seen when the circulation in the capillaries, as in the mesentery of the guinea-pig, is examined under the microscope. The red blood-cells will often be observed to change their shape by pressure from a disk to an elongated rod, and sometimes such a distorted corpuscle will catch at the point of bifurcation of a capillary, where it may hang like a pair of saddle-bags, part in one branch of the capillary, and the other half in the opposite.

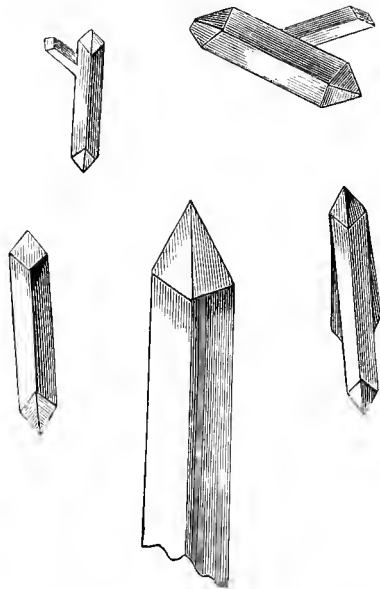

FIG. 175.—HÆMOGLOBIN CRYSTALS OF THE OX. (*Ellenberger.*)

Even in animals with nucleated red blood-cells, like the frog, similar change in shape may be seen; the red blood-cells may even be seen to pass out through the walls of the blood-vessels, becoming in the process drawn out into a fine thread.

The red blood-corpuscles are composed of the "stroma" and "hæmoglobin."

Early observers regarded the red blood-corpuscle as a vesicular body in which a cell-membrane inclosed fluid contents; at present it is believed to be composed of a semi-fluid net-work or frame-work, the stroma, denser at the periphery than at the

centre, in the meshes of which are inclosed the other constituents of the cell. The stroma may be demonstrated by alternately freezing and thawing the blood, which then loses its opacity and becomes a clear, lake-colored fluid, the hæmoglobin having left the corpuscles to pass into solution in the plasma, and the stromata remaining as colorless bodies, which sometimes retain the original form of the blood-cell, but usually are either more globular or more shriveled than normal. The stroma is colorless and highly elastic and is albuminous in nature; it is insoluble in serum, dilute salt or sugar solutions, and water below 60° C., but it is soluble in serum containing alcohol, ether, or chloroform, in caustic alkalies, and in solutions of alkaline salts of the bile acids.

The most important constituent of the red blood-corpuscles, both in quantity and function, is the "hæmoglobin." Hæmoglobin, or the blood coloring-matter, is a complicated, crystallizable albuminoid body containing iron, and forms about 90 per cent. of the red blood-cells. When separated from the corpuscles, hæmoglobin readily crystallizes out



FIG. 176.—BLOOD-CRYSTALS OF MAN AND DIFFERENT ANIMALS. (*Thanhoﬀer and Frey.*)

1, hæmoglobin crystals: Mo, squirrel; Tr, guinea-pig; U, ground-mole; L, horse; Em, man; H, marmot; Ma, cat; T, cow; mv, from the venous blood of a cat. 2, hæmatin crystals; E, man; Vb, sparrow; M, cat. 3, hæmatoidin crystals from an old blood extravasation of man.

of its solutions in serum when concentrated. These crystals have different forms in different species of animals, depending, apparently, on varying amounts of water of crystallization. In the domestic animals they belong to the rhombic system; those of the squirrel are hexagonal. The

crystals are doubly refractive and soluble in water and weak alkaline solutions, those obtained from horses' blood being more soluble than the hæmoglobin of the dog or cat (Figs. 175 and 176).

Hæmoglobin solutions decompose after standing a few days, especially when concentrated and exposed to a warm temperature, and the red color is then replaced by a dirty-brown hue, which appears greenish in transmitted light. Concentrated alkalies, various metallic salts, and acids facilitate this decomposition, which consists of the breaking up of the hæmoglobin into certain albuminoids and a coloring matter, hæmatin, which is often found in old blood extravasations. Hæmoglobin crystals may be obtained in various ways from the blood of the dog, horse, guinea-pig, or cat. All the agents which deprive the red corpuscles of their coloring matter, so rendering the blood lake-colored, may serve to form oxyhæmoglobin crystals; such as repeated freezing and thawing, electricity, a temperature of 60° C., powdered salts, ether in vapor or substance, chloroform, and the bile salts. The simplest way is to defibrinate dog's blood, remove as much serum as possible, and then shake the blood with a little ether. As soon as the ether has partially evaporated the crystals commence to form.

The composition of hæmoglobin is as follows:—

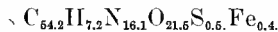

The following has been given as its empirical formula, assuming that the molecule contains one atom of iron:—



Hæmoglobin readily forms a loose chemical union with oxygen, called oxyhæmoglobin. It may be formed by shaking a solution of hæmoglobin with oxygen. The oxygen is again readily removed from this compound by exposure to a vacuum or by various reducing agents, such as ammon. sulph., iron salts, or metallic iron. That this union of oxygen with hæmoglobin is of a chemical nature is proven, in the first place, by the constancy of the equivalent of combination: Thus, one gramme of hæmoglobin will unite with 0.0024 gramme oxygen; this would place the molecular weight of hæmoglobin at about 13,000.

In the second place, the difference in optical characteristics of hæmoglobin and oxyhæmoglobin point to difference in chemical constitution. Thus, reduced hæmoglobin is characterized by an absorption-band in the yellow portion of the spectrum, while solutions of oxyhæmoglobin show two absorption-bands, one at the line D (sodium line), and the other at E of the solar spectrum, while the portion of the spectrum which with reduced hæmoglobin is dark, with oxyhæmoglobin is clear (Fig. 177).



In the animal body hæmoglobin is never saturated with oxygen, even in arterial blood, while oxyhæmoglobin is never absent from venous blood; consequently, physiologically, we have to deal with an association

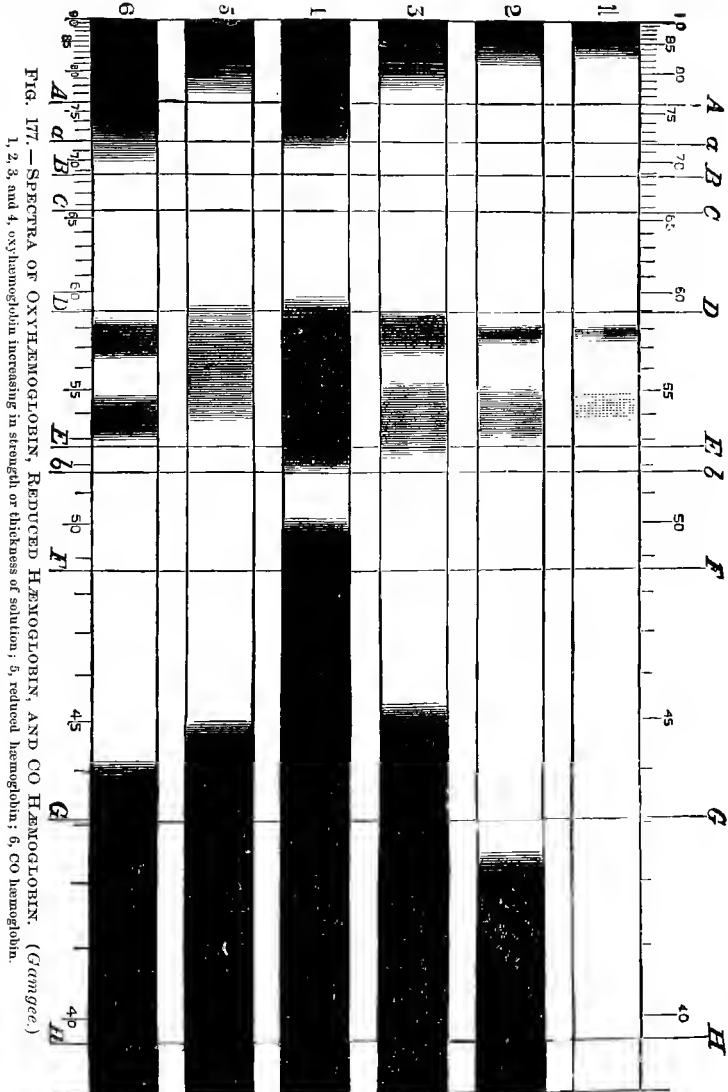

of hæmoglobin with oxyhæmoglobin, the relative proportions of each varying in different localities and under different circumstances. Further characteristics of these bodies will be studied in the chapter on Respiration.

Compounds similar to oxyhæmoglobin are formed between hæmoglobin and carbon monoxide and cyanogen. These two gases displace the oxygen from oxyhæmoglobin, and form compounds which cannot again be broken up with oxygen. These compounds, as well as those formed with nitrous oxide and sulphuretted hydrogen, are more stable in nature than the oxyhæmoglobin.

Hæmoglobin is chemically an even more complex body than albumen, since the latter, together with hæmatin, are decomposition products of hæmoglobin. This decomposition especially occurs under the action of acids, though it also takes place when solutions of hæmoglobin are exposed to a moderately warm temperature. Out of one hundred parts hæmoglobin, about four parts hæmatin and ninety-six parts albumen may be separated.

The inorganic constituents of the red blood-corpuscles differ very essentially from those found in the blood-plasma. While the latter is rich in chlorine and sodium, only traces are to be found in the blood-corpuscles, where, however, potassium and phosphates are present in large amounts, though they are almost entirely absent from the serum. The fact that we have here such a marked separate distribution of soluble salts, without any apparent tendency to their equal distribution, shows that there must be some force present which interferes with the working of the laws of diffusion and inhibition.

The following table shows the contrast between the inorganic constituents of the corpuscles and blood-plasma (Schmidt):—

1000 parts of Moist Corpuscles yield—		1000 parts of Plasma yield—	
Mineral matters (exclusive of iron), . . . . .	8.120	Mineral matters, . . . . .	8.550
Chlorine, . . . . .	1.686	CHLORINE, . . . . .	3.640
Sulphuric anhydride, . . . . .	0.066	Sulphuric anhydride, . . . . .	0.115
PHOSPHORUS PENTOXIDE, . . . . .	1.134	Phosphorus pentoxide, . . . . .	0.119
POTASSIUM, . . . . .	3.328	Potassium, . . . . .	0.323
Sodium, . . . . .	1.052	SODIUM, . . . . .	3.341
Calcium phosphate, . . . . .	0.114	Calcium phosphate, . . . . .	0.311
Magnesium, . . . . .	0.073	Magnesium phosphate, . . . . .	0.232

Too much importance must not, however, be laid upon this peculiar distribution of the inorganic constituents of the red blood-corpuscles and plasma, as given above for human blood, since it does not by any means hold in the case of other animals, for in most animals the sodium salts in the corpuscles actually preponderate over the potassium salts. The following table illustrates this:—

	BLOOD-CELLS.			LIQUOR SANGUINIS.		
	K.	Na.	Cl.	K.	Na.	Cl.
Man, . . . . .	40.89	9.71	21.00	5.19	37.74	40.68
Dog, . . . . .	6.07	36.17	24.88	3.25	39.68	37.31
Cat, . . . . .	7.85	35.02	27.59	5.17	37.64	41.70
Sheep, . . . . .	14.57	38.07	27.21	6.56	38.56	40.89
Goat, . . . . .	37.41	14.98	31.73	3.55	37.89	40.41

2. THE WHITE BLOOD-CORPUSCLES.—The white blood-cells are nucleated masses of free protoplasm destitute of any membrane, granular in appearance, and of the same nature as lymph and pus, or connective-tissue corpuscles. When in globular form these cells have a diameter of about 0.01 millimeter; like other forms of free protoplasm, such as the amœba, they are capable of assuming the most diverse shapes. Even after being drawn from the body, if a drop of blood is kept at the body temperature on a warm stage under the microscope, the white blood-

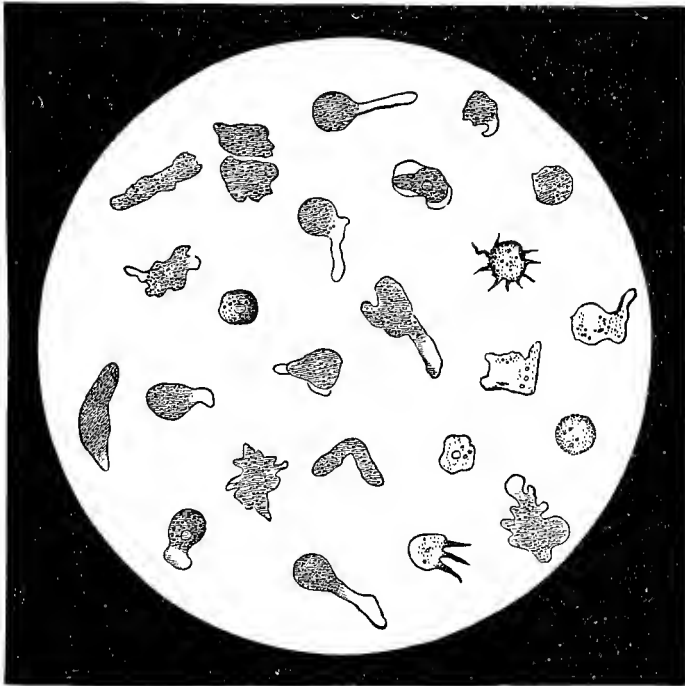

FIG. 178.—HUMAN LEUCOCYTES SHOWING AMOEBOID MOVEMENTS. (*Landois.*)

cells may be seen to change their shape and position, and even take fine granules, such as carmine, into their interior. In other words, they behave precisely like the amœba (Fig. 178).

The white blood-cells are found in much smaller numbers in the blood than the red cells; their relative proportions vary according to the nutritive condition of the animal, the locality from which the blood is taken, and various other circumstances. As an average, it may be stated that there are about three hundred to three hundred and fifty times as many red cells as white.

The white corpuscles are much lighter than the red, as is shown by their being found in greatest number near the upper surface of a blood-clot, and by the fact that when horses' blood coagulates the white blood-cells form a distinct layer on the surface of the red corpuscles.

The white blood-cells possess great adhesiveness, even while in the blood-current. This adhesiveness of the white cells may also be seen in blood drawn from the body. If a drop of blood is covered with a cover-slip and a drop of  $\frac{1}{2}$  per cent. salt solution passed under the cover by dropping a little of the solution at one side and drawing it through by placing a piece of bibulous paper at the opposite edge, the red blood-cells may be seen by the microscope to rapidly pass from one side of the field to the other, while the white cells remain adherent to the cover-slip. They, therefore, have a tendency to cling to the walls of the blood-vessel in which they may be circulating, and, since the white cells have an almost fluid consistence, they readily pass through the walls of the capillaries into the surrounding tissue. This especially occurs in inflamed tissues, when the slow blood-current and high pressure favors this transudation; in fact, according to many pathologists, nearly all pus-cells are supposed to originate in such a transudation of the white blood-cells.

After passing through the walls of the capillaries in normal circumstances the white blood-cells directly enter the lymph-spaces in which originate the lymphatic vessels, from which they may again enter the blood-current. It does not, however, follow that all lymph-corpuscles which are thrown into the venous current have originally been derived from white blood-cells which have passed from the blood through the walls of the capillaries into the lymph. We have already seen that many lymph-cells originate in the lymphatic glands, are developed in the blood into red blood-cells, and as such are again broken down. This change of the white into red blood-cells appears principally to take place in the red marrow of bones and in the spleen. In these organs capillary arterioles do not pass directly into the venous radicals, but into large spaces, or lacunæ, from which, after passing through a sieve-like cellular net-work, the modified blood-cells enter at once into large venous capillaries. The passage of the blood into these great expansions naturally produces a great slowing of the current, and it is quite conceivable that time will then be given for profound changes in the blood-cells; part of the protoplasm of the white cells is changed into hæmoglobin, the nucleus appears to be extruded and ultimately dissolved in the blood-serum, and a red blood-cell is thus developed.

The white blood-cells have a very complex chemical composition; various albuminoids enter into their composition, as well as carbohydrates, fats, lecithin, cholesterin, phosphates, and calcium, while the cell-nucleus appears to consist mainly of a phosphorized body, nuclein.

Albuminoids of various sorts form the great mass of the white blood-corpuscles. These correspond mainly to the albuminoids which are found in the blood-plasma, which, together with the paraglobulin, or fibrino-plastic substance, will be described in the consideration of the coagulation of the blood.

The protoplasm of the colorless blood-cells undergoes partial coagulation at 40° C. It swells and becomes transparent when treated with acetic acid, the nuclei becoming more distinct. With 10 per cent. salt solution the protoplasm swells and becomes dissolved (leaving the nuclei intact), the solution being coagulable with heat and the mineral acids and precipitated by dilution with water. The proteid constituents of the white blood-cells are thus largely of a globulin-like nature.

Of the *carbohydrates*, glycogen occupies the first rank in importance. When treated with a solution of iodine (one gramme) in iodide of potassium (two grammes in one hundred c.c. water) many of the white blood-cells assume a reddish, mahogany color, while in others the body of the cell stains deep yellow, numerous granules taking on the mahogany tint which is characteristic of glycogen. From the importance which glycogen has been found to possess for muscular contraction, it may be assumed that the contractility of the white blood-corpuscles is developed at the expense of the glycogen.

Variable amounts of *fat* are also found in the protoplasm of the white blood-corpuscles in the form of highly refractive granules. The importance of this fat for the life processes of the blood-cells is as yet undetermined. Whether it is formed as a result of the breaking down of the cell-protoplasm, or whether it exists as a result of absorption processes, is not certain, though the following experiment seems to indicate the former origin.

If a piece of dry pith is inserted into the abdominal cavity of a living animal, the pores of the pith are soon found to be filled with blood-serum and white blood-cells; the latter pass into the interior of the pith, and if, after remaining in the abdominal cavity for twenty-four hours, the pith is examined under the microscope, the external layers will be found to be occupied by perfectly normal, living, white blood-cells, while those which are found in the central portions have assumed a spherical form and undergone such extensive fatty degeneration that the pith seems to be impregnated with fat-globules.

*Lecithin*.—A phosphorized body which has already been described as a constituent of nearly all developing cells is also found as a constant constituent of the white blood-cells. As regards the origin of this substance, there is also the greatest uncertainty, though there is some evidence in favor of the view that it exists as a preliminary stage to the formation of fat. Lecithin is capable of a high degree of aqueous

inhibition, when it becomes a very adhesive, gummy substance, to which probably the adhesive properties of the white blood-cells are due.

*Cholesterin* is also a constant constituent of normal white blood-cells. It is not known whether the cholesterin is dissolved or suspended in the protoplasm of the white blood-corpuseles.

In addition to the above substances which are contained in the living white blood-corpuseles, there exists in breaking up corpuseles the fibrin ferment which originates in the death of the protoplasm. This substance, which possesses the power of converting soluble into insoluble fibrin, may be regarded as a complicated organic body, and possesses, even when in most minute quantity, the power of decomposing the peroxide of hydrogen, probably with the assistance of the elements of water, and of producing the modified forms of fibrinogen. That this ferment is set free by the breaking down of the protoplasm of the white cells, and is not contained dissolved in the plasma of the blood, is rendered probable by the following experiment:—

If the mesentery of the guinea-pig be examined under the microscope and a crystal of common salt placed near a small blood-vessel, as the salt melts the inner wall of the vessel will be found to be gradually covered with numerous white blood-cells until the lumen of the vessel is finally obstructed by a plug of white blood-cells. At first the margin of each separate cell is distinct, but soon they become indistinct and the vessel is then filled with a mass of fibrin, white thrombus, which exactly resembles the colorless coagulum which forms in clotting blood-plasma.

*Nuclein* is the most important constituent of the cell-nucleus. Nuclein is insoluble in water and dilute acids, but readily soluble in dilute potash solutions; when treated with hydrochloric acid it is changed into a stiff jelly. Nuclein is completely indifferent to the action of the digestive juices.

As every increase in the white blood-cells is preceded by a growth of the nucleus, it is possible that the nuclein plays an important rôle in the life of the white blood-corpuseles.

In addition to the white and red blood-corpuseles, microscopic examination of the blood will often reveal the presence of granular nucleated bodies, which are described as blood-plates or hæmatoblasts. These bodies vary considerably in size, being usually about one-third the size of a red blood-cell, and, like them, biconcave in shape, have about the same specific gravity as the white blood-cells, and possess the power of amœboid movement. They occur as pale, colorless, oval, round, or lenticular disks, of variable size, averaging about  $3\ \mu$ . By Hayem they are supposed to represent an early stage of development of the red blood-corpuseles. They are about forty times as numerous as the leucocytes, and may be recognized in the circulating blood in the mesen-

tery of the guinea-pig or in the wing of the bat. They are precipitated in enormous numbers upon threads suspended in fresh blood. They are believed by Bizzzero to be the agents which immediately induce coagulation and take part in the formation of fibrin. They become colorless and disintegrate during the act of coagulation (Fig. 179).

3. BLOOD-PLASMA AND BLOOD COAGULATION.—Blood-plasma is blood less blood-corpuscles. It may readily be obtained for study by preventing the coagulation of horses' blood by cold, when both the red and white blood-corpuscles settle to the bottom and leave the pure plasma, forming a clear, amber-colored fluid above.

Plasma is a somewhat viscid fluid of alkaline reaction. Its specific gravity is about 1027 or 1028. It contains about 90 per cent. water, with from 7 to 9 per cent. of various albuminoids, with small amounts

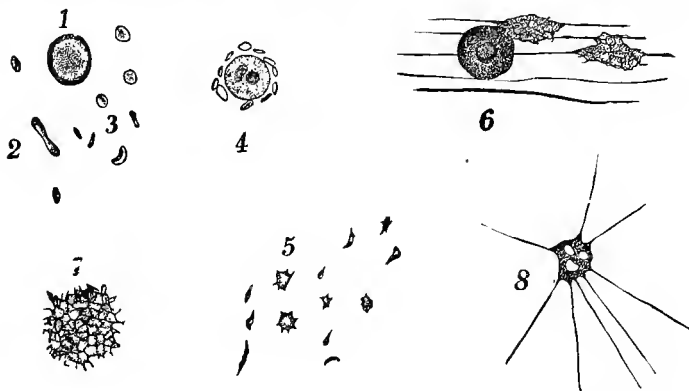

FIG. 179.—"BLOOD-PLATES" AND THEIR DERIVATIVES, AFTER BIZZZERO AND LAKER. (*Londons.*)

1, surface view of red blood-corpuscles; 2, side view; 3, unchanged blood-plates; 4, a lymph-corpuscle, surrounded with blood-plates; 5, blood-plates variously altered; 6, a lymph-corpuscle with two heaps of fused blood-plates and threads of fibrin; 7, group of blood-plates fused or run together; 8, a similar heap of partially dissolved blood-plates with threads of fibrin.

of urea, kreatin, kreatinin, and other nitrogenous organic bodies, as well as sugar, fat, eholesterin, and mineral bodies, of which compounds of sodium with chlorine and carbon dioxide are in excess. If horses' plasma, prepared as above, is allowed to become warmed a few degrees above the freezing point, it completely solidifies into a solid mass: the plasma is then said to be coagulated. This process of coagulation commences at the edges, in contact with the walls of the vessel which contains it, and on the free surface of the fluid, and rapidly extends throughout the entire mass until a firm jelly results, which is quite as transparent as the original fluid. Coagulation is due to certain albuminoids becoming transformed from the fluid to the solid state, resulting in the formation of fibrin. Shortly after the formation of the coagulum, a depression forms in the upper surface of the clot, in which a clear fluid, the *serum*,

collects ; the clot then gradually shrinks away from the sides of the vessel and contracts in every direction, and as the coagulum decreases in bulk the fluid serum increases, until, finally, the now opaque, small, firm clot swims in a large amount of clear, yellowish serum.

When horses' blood is not artificially cooled, and in blood of other mammals, the process of coagulation follows a somewhat different course. Here also it is only the fibrin which coagulates, and not the blood *in toto*; but the process takes place so rapidly that the corpuscles do not have time to settle, but remain entangled in the fibrin, and the coagulum, instead of being colorless, is of a deep-red color from the contained red blood-corpuscles, the whole forming a red, gelatinous mass,—the *crassamentum*, or clot. Here, also, the process of coagulation commences at the free surface of the blood and at the surfaces in contact with the walls of the vessel by the formation of a delicate pellicle, which rapidly thickens until in from seven to fourteen minutes the entire mass of blood is transformed into a stiff jelly ; and here, also, after the formation of the clot, there is a gradually progressive contraction, with exudation of serum, until finally there results a small, red, firm coagulum, floating in the yellowish serum.

Blood of different species of animals varies in the rapidity with which coagulation takes place. In the following series coagulation occurs in gradually increasing rapidity from the first to the last,—horse, cat, dog, ox, pig, goat, sheep,—the time varying from twenty-five to one and a half minutes. Normal horses' blood always clots so slowly that the corpuscles have time partially to settle to the bottom of the vessel which contains it. Immediately before coagulation, therefore, the horse's blood forms different-colored layers, the upper and smallest being yellowish, while the lower is red. When coagulation takes place the same arrangement holds, and the clot of horses' blood has, therefore, a yellowish upper surface, the so-called buffy coat, forming what used to be called an inflammatory clot (*crusta phlogistica*). Everything, therefore, which accelerates the settling of the red blood-cells, or which delays coagulation, will tend to develop the buffy coat on the clot.

In addition to cooling, coagulation may be retarded by pumping out the oxygen from the blood, by saturation with carbon dioxide (explaining the tardy coagulation of the blood in animals dying from suffocation, and why coagulation occurs sooner in venous than arterial blood), addition of certain salts, such as sulphate, borate, and carbonate of sodium, chloride of sodium, sulphate of magnesium, nitrate, acetate, and carbonate of potassium, and chloride of potassium, through the addition of small amounts of caustic potash or ammonia, sugar and gum solutions, or by acidulation with dilute acetic or nitric acids. By exact neutraliza-



tion of acidified blood with ammonia, or through the prolonged action of ozone, the coagulability of the blood may be completely removed.

The intravenous injection of 0.3 gramme peptone in 0.5 per cent. salt solution for each kilo of body weight in the dog likewise prevents the coagulation of the blood.

Warming of the blood above its normal temperature accelerates coagulation: so, also, the more extensive the contact of the blood with foreign bodies and with the atmosphere, the more rapid the coagulation.

If blood, as it escapes from a blood-vessel, is stirred or whipped with glass rods or twigs, coagulation occurs somewhat more rapidly than normally; but instead of the entire blood being transformed into a jelly, the substance—fibrin—on whose solidification blood coagulation depends separates in the form of fibrous lumps and shreds adhering to the body with which the blood is whipped. The blood is then said to be defibrinated, and the fluid in which the corpuscles remain suspended is termed *serum*, instead of plasma. Plasma is, consequently, the fluid constituent of blood which still contains uncoagulated fibrin elements; serum is plasma minus the fibrin elements. Serum may be obtained as a clear fluid by allowing the corpuscles to settle or by separating them with the centrifugal machine; or, as already stated, it exudes from the clot when blood is allowed spontaneously to coagulate.

The coagulation of the blood consists in the formation of fibrin, an albuminous body which results from the action of a ferment-like body on the albuminous constituents of the plasma, the process being similar to the spontaneous conversion of soluble into coagulated casein in milk from the action of the casein ferment.

The theory as to the formation of fibrin which has met with most general acceptance, though we shall find that it requires some slight modification, is that coagulation results when two albuminous bodies contained in blood-plasma, the fibrinogen and fibrino-plastic substances, unite under the influence of the fibrin ferment. The conditions governing this chemical process may be made clear by the following experimental facts (Foster):—

If the blood, as it flows from a divided vessel, is received in a beaker containing about one-third the volume of blood of a saturated solution of a neutral salt, such as magnesium sulphate, coagulation will be prevented, the corpuscles will settle in time to the bottom of the vessel, the fluid plasma—mixed, of course, with the salt solution—forming a transparent layer above them. If some of this plasma be drawn off with a pipette and diluted with eight or ten times its bulk of water, coagulation will be produced. The neutral salt has, therefore, merely prevented coagulation by its presence, and has not destroyed the substance or substances from which fibrin is formed. If to some of the

undiluted blood-plasma, in which coagulation has been prevented by cold or a neutral salt, an excess of sodium chloride in bulk be added, a sticky, white precipitate will be formed, and if it is filtered off it will be found that the plasma, even if warmed or diluted with water, has now lost its power of coagulation. If the precipitate collected in the filter be washed with a saturated solution of sodium chloride, in which it is insoluble, and then dissolved in a small amount of distilled water (enough salt will cling to the precipitate to make it a dilute saline solution) and filtered, the clear filtrate will rapidly solidify in the same manner as the blood-plasma prevented by cold from coagulation when gently warmed. This substance is termed *plasmine*, and it is evident that the coagulation of the blood is due to the conversion of plasmine into fibrin. Plasmine is not, however, a simple body, but a mixture of two proteids, as is shown by the following facts:—

If sodium chloride in bulk be added to the serum which separated from clotted blood, a precipitate will be formed which in its general characters resembles plasmine, but its solution will not coagulate spontaneously. This body is termed *paraglobulin* or *fibrinoplastin*.

If sodium chloride be added in bulk to some hydrocele fluid, a similar precipitate will also be formed, which also, when in solution, will not coagulate spontaneously. This substance is termed *fibrinogen*. If a solution of fibrinogen be added to a solution of paraglobulin, coagulation occurs in a manner precisely similar to that observed in blood-plasma or in solutions of plasmine. So, also, the addition of blood-serum to hydrocele fluid will likewise cause coagulation. These facts would seem to indicate that plasmine is a mixture of paraglobulin and fibrinogen. Another factor is, however, also concerned.

Both paraglobulin and fibrinogen may be precipitated from serum and hydrocele fluid by  $\text{CO}_2$ , and yet the solutions of these precipitates when mixed together will not coagulate.

If some defibrinated blood be poured into about twenty times its volume of strong alcohol, all the proteids will be coagulated. If, after standing some weeks in alcohol, the precipitate be filtered off and extracted with water, a few drops of this solution added to the above mixture of paraglobulin and fibrinogen obtained by  $\text{CO}_2$ , coagulation will rapidly result. If, however, the watery extract be first boiled, no clotting will result. This points to the presence of a ferment. Consequently we say coagulation results from the union of paraglobulin and fibrinogen in the presence of the blood ferment.

It has, however, been found that fibrin may result from the addition of the fibrin ferment to pure fibrinogen, without in any way requiring the assistance or presence of fibrinoplastin. Nevertheless, the amount of fibrin so formed is considerably less than would result from the coag-

ulation of the same amount of fibrinogen if fibrinoplastin were present. It would, therefore, appear that the fibrinoplastin in some way assists in converting the soluble fibrinogen into the insoluble fibrin, without itself directly taking part in the formation of the latter. This view is supported by the fact that while blood-serum is entirely free from fibrinogen it contains nearly as much fibrinoplastin as uncoagulated blood.

Fibrinoplastin perhaps acts in the same way as certain salts ( $\text{NaCl}$ ,  $\text{CaCl}_2$ ) and lecithin, which, when added in very small amounts to coagulable fluids, appear to increase the amount of fibrin formed.

The above-mentioned fibrin factors do not exist ready formed in the circulating blood of living animals, but originate in the breaking down of the white blood-cells in man and other mammals, and of the red nucleated blood-cells of birds and amphibia. As to how far the hæmatoblasts are concerned in this process is still the subject of controversy; it is, however, absolutely certain that immense numbers of the white blood-corpuscles disappear during coagulation.

*Fibrinogen* belongs to the group of globulins, *i.e.*, albuminous bodies which are insoluble in water, but soluble in dilute saline solutions, in which again they are rendered insoluble through the action of acids and alkalies.

Fibrinogen may be prepared by collecting horses' blood in one-fourth its volume of a saturated solution of magnesium sulphate, stirring and filtering, separating the corpuscles from the plasma by the use of the centrifugal machine, and adding to the latter an equal volume of a saturated salt solution. The precipitate is then collected, dried by pressing between layers of filter-paper, dissolved in an 8 per cent. salt solution, again precipitated with an equal volume of saturated salt solution, again drying and dissolving, and repeating the process until a precipitate is obtained, which, after drying with filter-paper, still retains enough salt adhering to it to render it soluble in distilled water, and which should contain no trace of serum-albumen or paraglobulin. The removal of the paraglobulin depends upon the fact that fibrinogen is very much more readily precipitated by 15-20 per cent. salt solution than is paraglobulin. So obtained, fibrinogen, in 1-5 per cent. salt solution, coagulates at  $52^{\circ}$ - $55^{\circ}$  C. It also may be obtained, mixed with fibrinoplastin, from hydrocele or pericardial fluid, by dilution with 10-15 volumes of water, or by the passage of a stream of  $\text{CO}_2$ .

The *fibrinoplastic substance*, or *paraglobulin*, is obtained as a white precipitate when perfectly clear and colorless blood-serum is faintly acidulated with acetic acid, and then diluted with fifteen or twenty times its volume of distilled water. The precipitate is then collected on a filter and washed with distilled water. Out of 100 c.c. ox-serum 0.7-0.9 gramme paraglobulin may be obtained by this process, though it is almost impossible to free it entirely from fibrin ferment.

The freshly precipitated paraglobulin is perfectly white, is insoluble in water, but is soluble in dilute solutions of sodium bicarbonate, sodium phosphate, sodium chloride, and other neutral salts of the alkalies. These solutions coagulate on heating like ordinary albumen (between  $60^{\circ}$  and  $80^{\circ}$  C.), and when diluted with distilled water again precipitate the paraglobulin.

If paraglobulin is added to certain serous fluids, such as hydrocele fluid, pericardial fluid, and serous effusions, coagulation is instantly produced through the action of the fibrin ferment, which always contaminates it.

There is less paraglobulin in horses' blood than in oxen's blood—0.3 to 0.5 per cent. in the serum of the former to 0.7 to 0.8 per cent. in the latter.

Paraglobulin, as well as fibrinogen, originates in the breaking down of white blood-corpuscles.

The *fibrin ferment* has never been obtained pure. Its aqueous solutions may be prepared by adding 15-20 volumes of absolute alcohol to the pure serum of

horses', oxen's, or dogs' blood, allowing the coagulated albuminoids to remain for at least two weeks under alcohol until they become completely insoluble, filtering, drying over sulphuric acid, and dissolving in water; traces of albumen which still cling to the ferment may be removed by the cautious addition of acetic acid, or  $\text{CO}_2$ . The ferment is not contained in living blood, but is a product of breaking down white blood-corpuscles. Its amount appears to have no influence on the quantity of fibrin formed, but only on the rapidity of the process. Its activity increases up to the temperature of the body, and the heat of boiling water destroys it; it may be preserved indefinitely, without losing its activity, at  $0^\circ \text{C}$ .

The serous transudations, especially of the horse, since they contain both fibrinogen and fibrinoplastin, but no ferment, coagulate at once on the addition of a drop of ferment solution; these fluids are, therefore, admirable tests for the presence of the ferment. The same also holds for the still fluid blood which remains in the blood-vessels after death.

*Fibrin* is an albuminous body which, in its percentage, composition, and behavior to most reagents, does not differ from other albuminoids. It may readily be obtained by whipping blood as it flows from a vessel, and then washing the coagulum in water until all the red blood-corpuscles are removed. It then forms a snow-white fibrous mass of the greatest elasticity, this latter property depending on the water contained in its molecular interspaces, for dry fibrin is as brittle as glass.

Fresh, spontaneously coagulated fibrin contains within its meshes large quantities of blood-serum, which are pressed out in the contraction of the fibrin.

The fibrin formed by the slow coagulation of the plasma of horses' blood possesses a less marked fibrous structure than the fibrin obtained by whipping blood, or even by the coagulation of other mammalian blood. It is rather more of an almost amorphous jelly, which will fracture along any line.

In hydrochloric acid of from 0.1-0.5 per cent., and in dilute phosphoric, acetic, and lactic acid solutions, fibrin swells up to a transparent jelly, but without, to any great extent, passing into solution, unless kept for some time at an elevated temperature, when it is nearly all converted into syntonin and passes into solution. On neutralization it is precipitated, the precipitate being insoluble in water, but readily soluble in very dilute acids and alkalies. Boiled fibrin is entirely insoluble in dilute acids and alkalies, but is partially soluble in the concentrated acids.

The cause of the constant fluidity of the blood in the living organism is found in the influence of the normal vascular wall on the blood contained in the vessels. That the fibrin factors are not found in the living blood is not a sufficient explanation, for it offers no reason why these substances develop in blood outside of the body.

Coagulation occurs as soon as contact with the living blood-vessels ceases, or when, through various causes, the walls of the blood-vessels lose their normal properties, from which we might infer that something in the vascular walls prevents the development of the fibrin factors; for injections of fibrinoplastin and the fibrin ferment, or transfusion of "lake-colored" blood, have, as an immediate consequence, the abundant formation of blood-clots even in perfectly normal vessels.

It is not necessary for the blood to be in constant motion in the vessels to prevent coagulation, for the circulation may be arrested in any part, provided the stoppage does not entail any injury to the walls of the vessels, and the blood still remain fluid. But if any circumscribed injury be made to the walls of a blood-vessel, as by the application of a ligature, even though it be subsequently removed, a deposit of fibrin will occur at that point.

4. THE BLOOD-SERUM.—Blood-plasma freed from fibrin constitutes blood-serum, and, as already stated, may be obtained by allowing blood to coagulate in a glass cylinder, when the gradual contraction of the fibrin in the clot presses out the serum.

Serum is an alkaline, transparent fluid, of a specific gravity of from 1026 to 1029, amber-yellow in the horse's blood, and almost colorless in that of the other domestic animals. In carnivora and omnivora, as well as in nursing herbivora, the serum is often milky from the contained fat-globules, which gradually rise to the top to form a layer of cream; this, however, only occurs at, or shortly after, the period of fat absorption.

In round numbers the composition of serum is as follows:—

Water, . . . . .	90 per cent.
Proteids, . . . . .	8 to 9 “ “
Fats, extractives, and salts, . . . . .	2 to 1 “ “

*The Albuminoids of the Serum.*—The following albuminoids are found in serum: Paraglobulin, alkali albuminate, serum-albumen, and frequently peptone.

*Paraglobulin* has already been considered under blood coagulation; in coagulation all the fibrinogen becomes solidified, while a considerable amount of paraglobulin still remains in the serum. The amount remaining in solution in the serum has been estimated at from 1.7 per cent. in the rabbit to 4.5 per cent. in the horse.

*Alkali albumen* (sodium albumen, serum-casein) is precipitated by exact neutralization with acetic acid. It is insoluble in distilled water, but readily soluble in dilute acid and alkalies.

*Serum-albumen* exists in larger amount than all the other albuminoids, the serum containing from 6 to 8 per cent. As already mentioned, it differs from egg-albumen in rotating polarized light  $56^\circ$  to the left, while egg-albumen rotates it but  $35.5^\circ$ , and in its behavior to ether and acids. After removing paraglobulin and alkali albuminate, serum-albumen may be completely coagulated after acidulation and dilution by heat ( $70^\circ$ – $75^\circ$  C.).

The quantitative proportions between serum-albumen and paraglobulin vary in different animal species. The proportion, while not even constant in any given species, varies about as follows, paraglobulin being represented by the numerator of the fraction, serum-albumen by the denominator: Horse  $\frac{0.5}{91}$ , Ox  $\frac{0.8}{42}$ , Man  $\frac{1.5}{11}$ , Dog  $\frac{1.8}{3}$ , Rabbit  $\frac{1.5}{5}$ .

*Peptone* differs from other albuminoids in that it is not coagulated by heat or acetic acid and potassium ferrocyanide, but is precipitated by tannic acid, corrosive sublimate, absolute alcohol in great excess, phosphowolframic acid, phosphomolybdic acid, and iodide of mercury and potassium.

Its other characteristics have been described under the head of Gastric Digestion.

To detect the presence of peptone in blood-serum, all the other albuminoids must first be removed. This may readily be accomplished by adding a solution of acetate of iron, to which a few drops of sulphate of iron solution have been added. The serum must first be diluted with five to eight volumes of water, heated on the water-bath, and the iron solution and then caustic soda added, until only a faint acid reaction remains. A thick, brown precipitate then falls, and the supernatant fluid is free from iron and all albuminoids but peptone, the presence of which may be recognized, after filtration, by the biuret reaction.

Peptone is only found in the serum during and shortly after albumen absorption.

*Other Organic Constituents of the Serum.*—Sugar may be detected, after removal of albuminoids, by the copper test. Sugar is a constant constituent of the serum of blood. Its origin and importance will be discussed later. Ox-blood contains 0.543 pro mille sugar, sheep's blood 0.521 pro mille, dogs' blood 0.787 pro mille.

*Fat* has already been mentioned. It is found only in scanty amount, except after a meal, being in largest amounts in the serum from suckling animals. Stearin, palmitin, and olein, with their respective soaps, are the principal representatives. The odor of serum is probably due to a volatile body of the fatty acid series. The yellow color of serum is due to the presence of a special pigment.

*Lecithin* is a constant constituent of the ethereal extract of blood-serum. A large proportion of the phosphoric acid of the serum is contained in this body. Its origin and uses are not well understood. Perhaps, since it is the carrier of phosphorus, it is of special importance in the nutritive processes of bone.

*Cholesterin* is also found in the ethereal extract of blood-serum, from which it coagulates in white, pearly flakes.

Further, small amounts of urea are found in serum, as well as kreatin, kreatinin, and other products of the retrograde metamorphosis of tissues, which will subsequently claim attention.

*The Inorganic Constituents of Blood-Serum.*—Serum yields about 0.75 per cent. of ash, in which the following bases are found: Na, K, Ca, Mg, Si, and Fe and  $P_2O_5H_2$ ,  $H_2SO_4$ ,  $CO_2$ , and Cl. K and Fe are in extremely minute quantity; Mg and Ca in somewhat larger quantity, though out of proportion to the richness of the organism in these bodies.

*The Gases of the Blood.*—Oxygen, carbon dioxide, and nitrogen are found in the blood in conditions of loose chemical union with certain blood constituents (haemoglobin) and in solution in the blood-plasma, which, like other fluids, is capable of dissolving a certain amount of different gases. Their consideration will be reserved for the chapter on Respiration.

## SECTION VII.

### THE CIRCULATION OF THE BLOOD.

It has been seen that digestion is the preparation of food for absorption; absorption is the process by which the results of digestion reach the interior of the blood-vessels; but that the blood, which by means of absorption has thus received the nutritive principles of the food, may satisfactorily meet the nutritive wants of the different tissues of the body, it must be in constant motion. The circulation of the blood is, therefore, that function by means of which the nutritive materials supplied by absorption are distributed to the economy after being subjected to aeration, and by which the refuse and effete materials are carried where they may be excreted.

1. GENERAL VIEW OF THE ORGANS OF CIRCULATION.—Circulation is an organic function, being present in both the animal and vegetable kingdoms.

In the simplest forms of life, both animal and vegetable, in which absorption takes place by imbibition from the entire external surface, no special circulatory apparatus is required. It is only when certain tissues become specialized organs for absorption and others for aeration that a necessity arises for some apparatus by which the materials absorbed are conveyed from the point of absorption to the respiratory organs and to the system at large. The development of the circulatory organs is, therefore, proportional to the degree in which absorption and respiration are limited to special tissues.

As might be expected from the definition of the circulation, in the lowest animals, as in plants, in which absorption takes place from the entire external surface, there exists no apparatus for carrying on a circulation of fluid, the contractile vesicles seen in many of the protozoa having, probably, rather a respiratory than a circulatory function; it is only when the digestive organs become highly specialized that a circulatory apparatus appears. Thus, in the coelenterata the somatic cavity is in free communication with the digestive cavity and with the exterior, and the fluid which it contains, representing the blood of higher orders, is moved by the contractions of the entire body and by the vibration of cilia lining the somatic cavity, there being no indication of either a heart or a vascular system. In the turbellaria, trematoda, and cestoidea the lacunæ of the mesoderm and the interstitial fluid of

its tissues are the representatives of a blood-vascular system—a condition closely analogous to what occurs as the first indication of a circulation in plants. In annelida, as is also the case in the rotifea, we find a perivisceral cavity lying between the splanchnopleure and the somatopleure, communicating with the segmental organs, as the water-vascular system. In the former group there is also to be found a system of canals (the pseudo-hæmal system), in some instances communicating with the perivisceral cavity, with contractile and often ciliated walls, and containing a clear, sometimes corpusculated fluid, which may be either red or green from the presence of a substance which resembles hæmoglobin and which is evidently of a respiratory value. These canals always communicate at some point by a tubular stem with the exterior. In the lowest forms of the arthropoda the same general conditions noted in the turbellaria are to be found, viz., a perivisceral cavity and an inter-

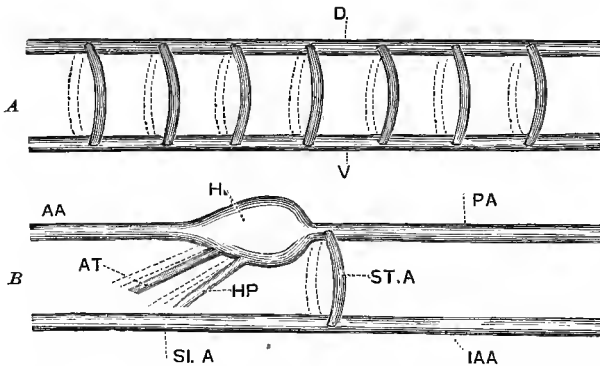

FIG. 180.—DIAGRAMS TO SHOW THE ARRANGEMENT OF THE GREAT BLOOD-VESSELS IN WORMS AND LOWER CRUSTACEANS. (*Jeffrey Bell*.)

*A*, earthworm: *D*, dorsal vessel. *B*, crayfish: *AA*, anterior aorta; *PA*, posterior aorta; *H*, heart; *AT* and *HP*, transverse vessels which supply the anterior regions of the body and the viscera; *ST.A*, sternal artery; *SI.A* and *IAA*, abdominal artery.

stitial fluid, in which, however, colorless cells may be detected. In the lower crustacea and in many insecta we find a single elongated, sometimes segmented, contractile vessel, the dorsal vessel, provided with lateral valvular openings by which the blood enters from an inclosing venous space or sinus (Fig.180). In the anodon (Fig. 181, *C*) the spaces or sinuses are much more developed, and no traces of a ventral vessel are now to be seen; the dorsal is, however, shown by the heart, with its anterior and posterior aortæ, while the terminal parts of the transverse vessels become enlarged to form the auricles of the heart. In the higher crustacea, as in the lobster, there is a single, well-developed, muscular, systemic dorsal heart surrounded by a venous sinus and giving off a number of arterics, which pass into capillaries; but the venous system still remains more or less laeunar. In the mollusea, also, the same gradual



differentiation of the blood-vascular system is observable. In some of the lowest forms, as in polyzoa, neither a contractile heart nor even vessels can be detected; circulation in them, as in lower forms, being carried on by mere imbibition. In the tunicata the heart, whose position closely resembles its ventral situation in the vertebrata, has no valves between its dilated chambers, and the blood is propelled by opposite peristaltic movements, first in one direction and then in another; hence, here the heart is sometimes systemic and sometimes respiratory. The most perfect form of circulation found in the mollusca exists in the cephalopoda. In them there is a systemic ventricle provided with valves at its orifice, with systemic arteries, the blood being returned into a large venous sinus, from which it passes to the gills through contractile vesicles, the branchial hearts, which serve to propel the blood through the gills; from there it passes again into

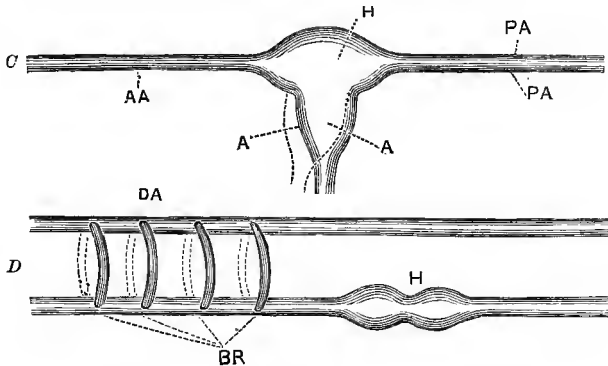

FIG. 181.—DIAGRAMS OF THE GREAT BLOOD-VESSELS IN THE FRESH-WATER MUSSEL AND THE FISH. (*Jeffrey Bell.*)

*C*, fresh-water mussel: *H*, heart; *AA*, anterior, and *PA*, posterior aortae; *A*, auricle. *D*, fish: *H*, heart; *BR*, branchial vessels; *DA*, dorsal aorta.

contractile venous sinuses, which, therefore, act as auricles, and is then driven to the heart.

Thus we find that in the invertebrata the circulatory apparatus, even in the highest forms, contrasted with what we shall find in the vertebrata, does not consist of a continuous series of tubes, but that the blood passes from such vessels into spaces (laeunæ or perivisceral spaces) without distinct walls. Connected with the vessels we often find several pulsating cavities more analogous to the lymphatic or venous hearts found in the vertebrata than to a true respiratory or systemic heart. When a heart is present in the invertebrates, it is single, is, as a rule, placed on the dorsal aspect of the body, contrasted with its ventral position in vertebrates, and is of a systemic and not respiratory function. In the invertebrata there is no trace of a portal system, the liver being supplied by the systemic arteries.

In the vertebrata, amphioxus, the lowest form of fish, has a system of blood-vessels with contractile walls, but no distinct heart, while in all the other vertebrates there is a heart with, at fewest, three chambers (sinus venosus, atrium, ventricle), arteries, capillaries, and veins, and a system of lymphatics connected with the veins.

In many of the lower forms of vertebrates we still find large venous sinuses, but in the higher forms these are for the most part replaced by definite vessels with muscular walls. Important peculiarities, however, exist in the vascular systems of the vertebrata dependent upon the character of their respiration, whether pulmonated or air-breathing, or branched or water-breathing; and further, as to whether their blood is warm or cold. Mammalia and birds are included in the group of warm-blooded pulmonated vertebrata; reptilia and amphibia in the group of cold-blooded pulmonated animals; and fish constitute the group of cold-blooded branched vertebrata.

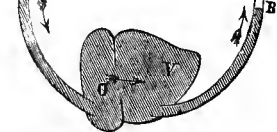

FIG. 182.—DIAGRAM OF THE CIRCULATION IN THE FISH. (Beclard.)  
A, dorsal artery, or aorta; C, systemic organs; O, auricle; V, ventricle; B, branchiae.

In all of these animals the character of the circulatory apparatus depends upon the manner in which the blood is oxygenated; therefore, in those animals (certain of the amphibia) which commence life as branched animals and subsequently become pulmonated, we find that their circulatory apparatus becomes modified accordingly, and presents two different styles corresponding to the stage of their existence. In all forms of vertebrata a portal system is present—that is, the liver receives a special supply of venous blood derived from the systemic capillaries of the abdominal organs.

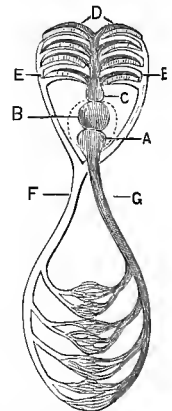

FIG. 184.—PLAN OF CIRCULATION IN THE FISH. (Carpenter.)  
A, auricle; B, ventricle; C, branchial artery; D, gills; E E, branchial veins uniting in F, the aorta; G, vena cava.

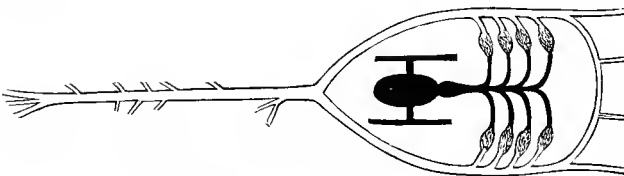

FIG. 183.—DIAGRAM OF THE ARTERIAL CIRCULATION IN FISHES, AFTER WIEDERSHEIM. (Jeffrey Bell.)

In fishes (see Fig. 181, D), the lowest forms of vertebrates, the heart consists of a single auricle with the sinus venosus, which is always present, and a single ventricle, the former receiving the dark venous blood from the

body and transmitting it through an opening, guarded by a valve, to the ventricle, from which the blood is propelled to the bulbus arteriosus, and then through four or five branching vessels supported on the cartilaginous branchial arches to the gills (Figs. 182 and 183). After being subjected to

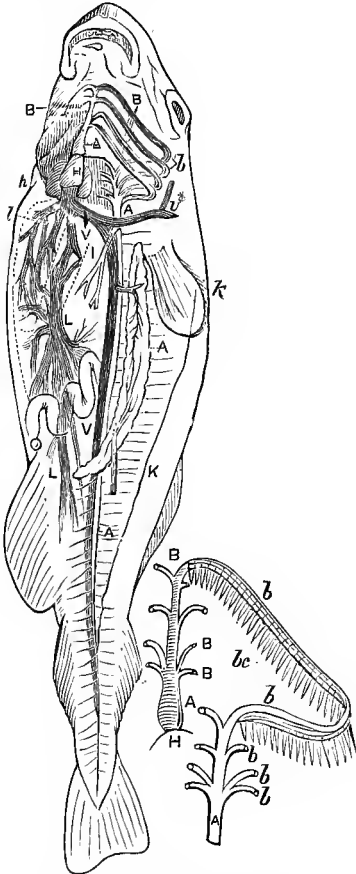

FIG. 185.—CIRCULATORY APPARATUS IN THE FISH. (Owen.)

A, bulbus arteriosus; B, branchial arteries; b, branchial veins; H, ventricle; h, auricle; L L, portal vein; V V, vena cardinalis; v, jugular veins; I, intestine; A' A', aorta; K, kidney.

The lower figure shows an enlarged diagram of a branchial arch, the lettering being the same as above, bc being the branchial cavity.

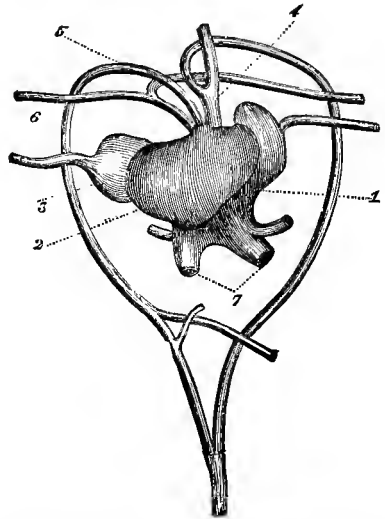

FIG. 186.—HEART OF TORTOISE. (Béclard.)

1, right auricle; 2, single left auricle; 3, left auricle; 4, right aorta; 5, left aorta; 6, pulmonary artery dividing into two branches; 7, venae cavae.

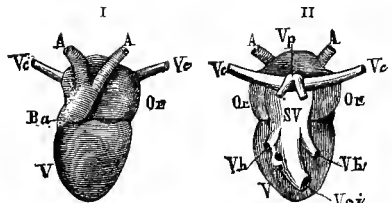

FIG. 187.—HEART OF FROG. (Livon.)

I, anterior view; II, posterior view. A A, aortae; Vc, superior venae cavae; Or, auricles; V, ventricle; Ba, aortic bulb; SV, venous sinus; Vc, inferior venae cavae; Vh, hepatic veins; Vp, pulmonary veins.

aeration in the capillaries of the gills, the blood is then collected by the branchial veins, which, uniting into a single arterial trunk situated on the dorsal aspect of the alimentary canal, and corresponding to the aorta of higher vertebrates, serves by a system of branching vessels to

distribute the arterial blood to the system at large; whence it is again returned by the venous system, after passing through the systemic capillaries to the auricle (Fig. 184). In fishes, therefore, the respiratory apparatus forms a part of the general systemic circulation, the heart being, therefore, a branchial and not a systemic organ, and the circulation being simple instead of imperfectly double, as in the reptilia, or perfectly double, as in the warm-blooded vertebrata. In the fish, a portal system, composed, as in all vertebrates, of veins from the digestive apparatus, conducts the blood from the abdominal organs through the kidneys and liver; hence, in the fish, both these glands receive venous blood (Fig. 185).

In the reptilia the heart consists of two auricles and one ventricle (Figs. 186 and 187). The right auricle receives venous blood from the

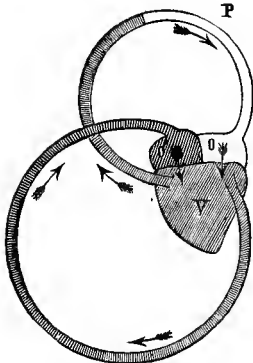

FIG. 188.—DIAGRAM OF THE CIRCULATION IN REPTILIA. (*Béclard.*)

P, lungs; O, left auricle; V, ventricle, whence the blood is driven through the systemic circulation to enter the right auricle, O', after being collected by the veins.

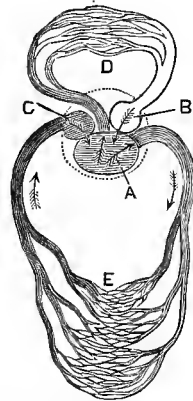

FIG. 189.—DIAGRAM OF THE CIRCULATION IN THE REPTILIA. (*Carpenter.*)

A, ventricle; B, left auricle; C, right auricle; D, pulmonary circulation; E, systemic circulation.

system at large; the left auricle receives arterial blood from the lungs; both discharge their contents into the single ventricle, which thus receives a mixture of venous and arterial blood. From the ventricle the blood is driven partly through the lungs and partly to the general system, so both lungs and system receive a partially aerated blood, forming an incomplete double circulation (Fig. 188 and 189). In the reptilia, as a rule, there is a distinct arterial and distinct pulmonary trunk arising from the ventricle, but in the amphibia there is only a single trunk, of which the pulmonary arteries are branches, rising from the ventricle. In the crocodile there exists a partial ventricular septum, so placed that it serves to direct the dark venous blood entering from the right auricle chiefly into the pulmonary arteries, whilst the arterial blood coming from the left auricle is sent out into the systemic

arteries, thus closely approaching the double circulation of birds and mammals (Fig. 190). A portal circulation is also present in the cold-blooded pulmonated vertebrata, and, as in the fishes, is connected with the renal veins.

In birds the heart, as in man, consists of four cavities, two auricles and two ventricles, and the general distribution of the circulation is the same, *i.e.*, the right auricle collects the blood from the systemic veins and transmits it to the right ventricle, which, by means of the pulmonary artery, forces the blood through the lungs. From the lungs the oxygenated blood is carried by the pulmonary veins to the left auricle, from there to the left ventricle, and thence, by means of the aorta and its branches, to the system at large. There is, therefore, in birds a perfect double circulation—a pulmonary and a systemic circulation (Fig. 191).

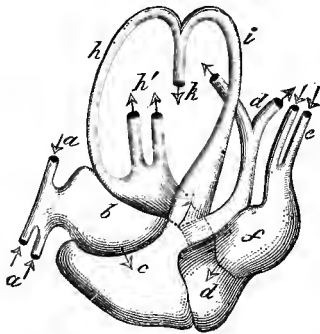

FIG. 190.—HEART OF THE CROCODILE. (Perrier.)

*a a*, venae cavae; *b*, right auricle; *c*, right ventricle; *d*, left ventricle; *e*, pulmonary veins; *f*, left auricle; *h h'*, aortae; *i*, second arch of the aortae, in which arterial and venous blood is mixed; *g*, pulmonary arteries.

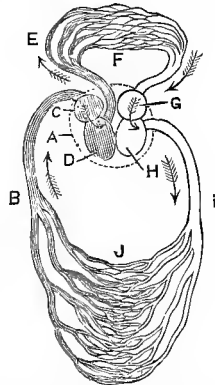

FIG. 191.—DIAGRAM OF THE CIRCULATION IN BIRDS AND MAMMALS. (Carpenter.)

*A*, heart; *B*, vena cava; *C*, right auricle; *D*, right ventricle; *E*, pulmonary artery; *F*, pulmonic capillaries; *G*, left auricle; *H*, left ventricle; *i*, aorta; *J*, systemic capillaries.

The portal system is also present in birds, and, as in the lower vertebrates, receives branches from the kidneys and from the lower limbs.

The circulation in mammals, of which man may be taken as a type, deserves to be treated at somewhat greater length than the circulation in inferior organisms. As in other vertebrates, with the exception of the openings of the larger lymphatics, the blood is contained in a completely closed system of vessels, whose course and general arrangement we will first trace in outline.

The circulation is carried on through a system of tubes of different functions and different properties. These are: (1) the central organ, the heart, a hollow muscle, which serves as both a pump and a reservoir, divided into four cavities, two auricles or receivers of blood, and two ventricles or pumps (Fig. 192); (2) the arteries, a system of muscular

and elastic tubes coming off from the heart, which gradually subdivide, like the trunk of a tree, into branches, and which serve to carry oxygenated blood to the tissues; (3) the veins, another system of branching tubes, also elastic and muscular, but less so than the arteries, which conduct to the heart the blood collected from (4) the capillaries, a system of fine tubes situated between the arteries and the veins.

In man, as in other mammals, we have to deal with a double circulation—the systemic circulation and the pulmonic. Their general outline may be given as follows: Starting from the heart, the arterial blood leaves the left ventricle through the aorta, which immediately gives off two vessels, the coronary arteries, for nourishing the tissues

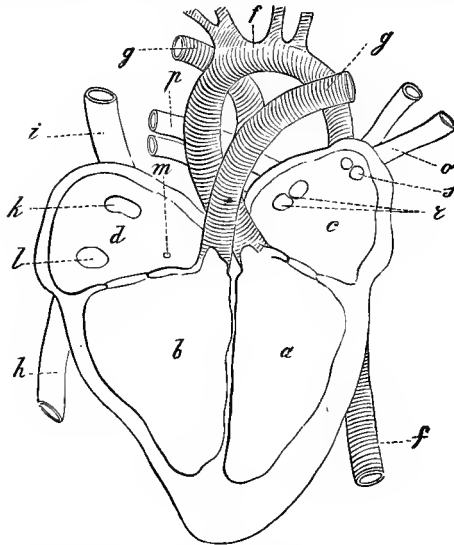

FIG. 192.—DIAGRAM OF MAMMALIAN HEART. (Béclard.)

*a*, left ventricle; *b*, right ventricle; *c*, left auricle; *d*, right auricle; *f*, aorta; *g g*, pulmonary arteries; *h*, inferior vena cava; *i*, superior vena cava; *k*, orifice of the superior vena cava; *l*, orifice of the inferior vena cava; *m*, orifice of the coronary vein; *o*, left pulmonary veins; *p*, right pulmonary veins; *r*, orifices of the right pulmonary veins; *s*, orifice of the left pulmonary veins.

of the heart itself; the aorta then divides into branches, which themselves become successively subdivided to supply arterial blood to the head, trunk, limbs, and all the organs of the body, the vessels becoming finally so minute as to allow merely the passage of a single blood-corpuscle, forming then the so-called capillary vessels. From the capillaries the blood is again collected by converging venous radicals, which finally are united to form two main venous trunks—the *vena cava superior*, bringing the blood from the head and upper extremities, and the *vena cava inferior*, collecting the blood from the trunk and lower limbs. Both of these large veins empty into the right auricle, com-

pleting the circuit of the greater or systemic circulation. From the right auricle the blood is emptied into the right ventricle, from which it is forced by the heart's contractions into a single large trunk, the pulmonary artery. This artery, which, however, contains venous blood, soon divides into two trunks, one going to each lung, each of which divides and subdivides in the lung-tissue to form a second capillary network, in which the dark venous blood is subjected to the influence of the air contained in the air-cells, gives up its carbon dioxide and certain organic impurities, and absorbs oxygen, becoming again bright-red arterial blood. It is then collected by the pulmonary veins and carried to the left auricle, thus completing the lesser or pulmonary circulation, and bringing us back to the point from which we started (Fig. 194).

2. THE ACTION OF THE HEART.—The circulation of the blood consists in the continuous movement of the blood in a series of ramifying tubules or blood-vessels, and

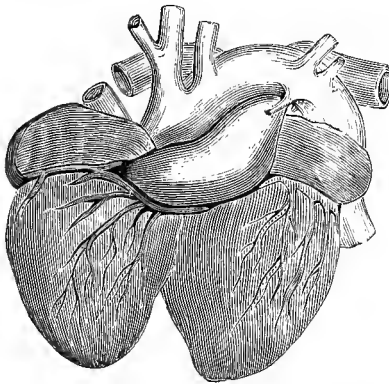

FIG. 193.—HEART OF DUGONG, SHOWING THE SEPARATION OF THE RIGHT AND LEFT, OR PULMONARY AND SYSTEMIC HEARTS. (Perrier.)

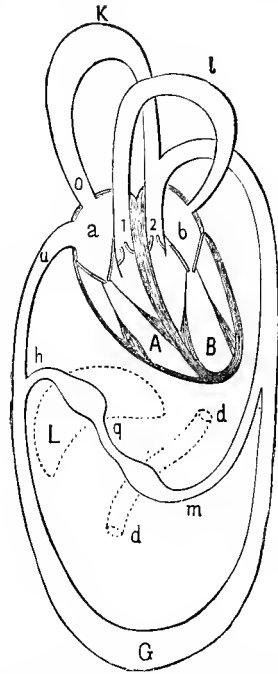

FIG. 194.—SCHEME OF THE CIRCULATION IN MAMMALS. (Landois.)

a, right auricle; A, right ventricle; b, left auricle; B, left ventricle; l, pulmonary artery; 2, aorta, with semilunar valves; L, area of pulmonary circulation; K, area of systemic circulation in region supplying the superior vena cava; o, G, area supplying the inferior vena cava; u; d d, intestine; m, mesenteric artery; q, portal vein; L, liver; h, hepatic vein.

owes its maintenance largely to the motor power derived from the contractions of the heart. The circulatory apparatus consists, therefore, of the heart, the arteries, the veins, and midway between the latter the capillaries. The conditions which govern the movement of the blood-current in these different parts of the circulatory apparatus will be studied in turn.

The heart is a muscular reservoir, divided, as already indicated, in

mammals into four cavities, two auricles and two ventricles. In its function it acts as a force-pump, and by the contraction of its walls empties the contents of its cavities into the arterial branches in connection with them, and therefore is the starting point of the circulation. Its action as a pump is therefore mainly physical, the effect produced by its contractions being governed by their frequency, force, and character, and the quantity of blood ejected at each beat. Its physical properties, as indicated by the above considerations, are governed by a number of vital conditions, which modify the various characters of cardiac pulsation. These will later demand attention.

The heart consists of interlacing muscular fibres, which are midway between the striped and unstriped muscular tissues. They are extremely short, transversely striated, are devoid of sarcolemma, and are usually bifurcated at their extremities and anastomose with each

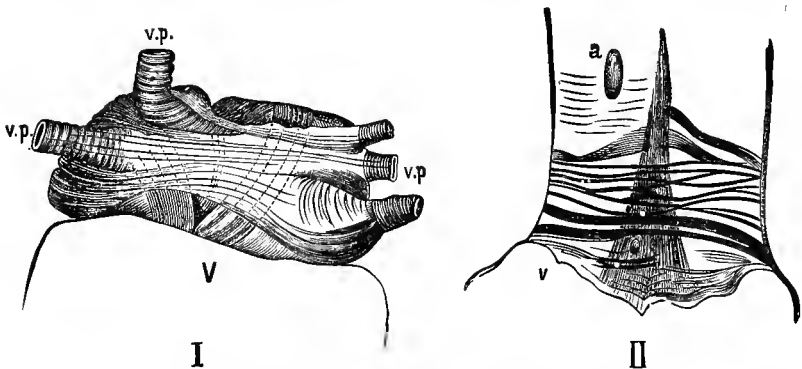

FIG. 195.—ARRANGEMENT OF MUSCULAR FIBRES IN THE AURICLES AND GREAT VEINS. (*Landois*.)

I, muscular fibres on the left auricle, showing the outer transverse and inner longitudinal fibres, and the circular fibres on the pulmonary veins, v.p. V, the left ventricle (*Reid*).

II, arrangement of the striped muscular fibres on the superior vena cava (*Efischer*). a, opening of vena azygos; v, auricle.

other. In the tubular heart of the embryo, microscopic inspection shows that the muscular fibres may at first be resolved into an outer circular and an inner longitudinal layer of fibres. And, from the fact that at first the heart consists of but one chamber, it is clear that a part of the fibres at least must be common to the two auricles and a part also to the two ventricles. While, however, this is true, the muscular fibres of the auricles are completely separated from those of the ventricles by the fibro-cartilaginous rings of the auriculo-ventricular orifices. In adult animals the fundamental circular arrangement of the embryonic fibres partly remains, while in the ventricles, as the septum becomes formed, the fibres become twisted into the form of spiral loops. The arrangement of the muscular fibres in the different cavities of the heart serves to a considerable degree to explain the



physiological characteristics of the different cardiac cavities, this physiological difference depending upon the anatomical structure of the different parts of the heart, as has been clearly traced out by Landois whose description of this subject has been mainly followed. In the auricles the fibrous auriculo-ventricular rings serve to separate the auricular muscular fibres from the ventricles, and, therefore, serves to explain the fact that the auricles are enabled to contract independently of the ventricles.

In the auricles the muscular fibres are arranged in an external transverse layer continuous over both auricles and an internal longitudinal layer. This double arrangement of the fibres enables them in their contraction to produce a uniform diminution of the auricular cavities (Fig. 195).

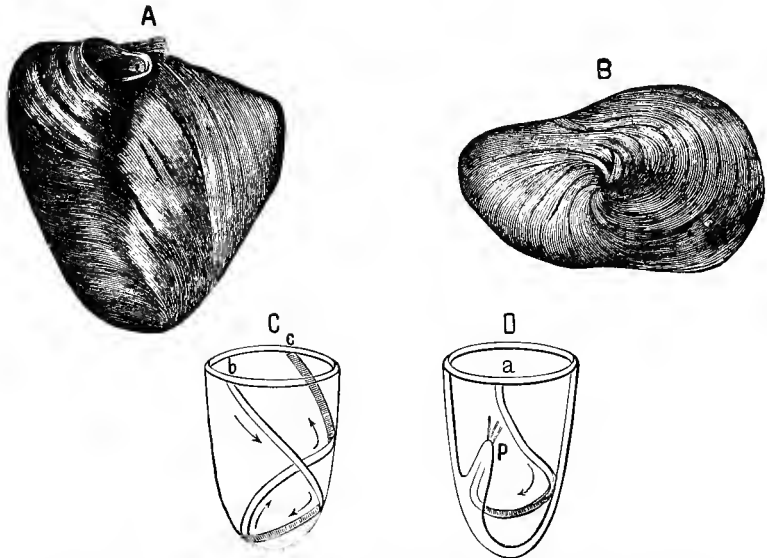

FIG. 196.—COURSE OF THE VENTRICULAR MUSCULAR FIBRES. (Landois.)  
A, on the anterior surface; B, view of the apex with the vortex (*Hendle*); C, scheme of the course of the fibres within the ventricular wall; D, fibres passing into a papillary muscle (*C. Ludwig*).

At the openings of the large veins into the auricles there is a special development of circular bands of striped muscular fibre. The contraction of these bands enables the veins to empty themselves into the auricle and also serves to prevent, to a certain degree, backward reflux of the blood from the auricles into the veins when the auricles contract, even though no valves are present in these vessels. In the ventricles the fibres are arranged in a number of separate layers so as to form figure of 8 loops. First, there is an outer longitudinal layer which is in the form of single bundles on the right ventricle and forms a complete layer

on the left ventricle, constituting about one-eighth of the thickness of the ventricular wall (Fig. 196). "A second longitudinal layer of fibres lies on the inner surface of the ventricles, distinctly visible at the orifices, and within the vertically placed papillary muscles, while elsewhere it is replaced by the irregularly arranged trabeculæ carnæ. Between these two layers there lies the thickest layer, consisting of more or less transversely arranged bundles, which may be broken up into single layers more or less circularly disposed. The deep lymphatic vessels run between the layers, while the blood-vessels lie within the substance of the layers, and are surrounded by the primitive bundles of muscular fibres (Henle). All three layers are not completely independent of each other: on the contrary, the fibres which run obliquely form a gradual transition between the transverse layers and the inner and outer longitudinal layers. It is not, however, quite correct to assume that the outer longitudinal layer gradually passes into the transverse, and this again into the inner longitudinal layers (as is shown schematically in C, Fig. 196), because, as Henle pointed out, the transverse fibres are relatively far greater in amount. In general, the outer longitudinal fibres are so arranged as to cross the inner longitudinal layer at an acute angle. The transverse layers, lying between these two, form gradual transitions between these directions. At the apex of the left ventricle the outer longitudinal fibres bend or curve so as to meet at the so-called vortex (Wirbel), B, and where they enter the muscular substances, and, taking an upward and inward direction, reach the papillary muscles (Lower), D, although it is a mistake to say that all the bundles which ascend to the papillary muscles rise from the vertical fibres of the outer surface; many seem to rise independently within the ventricular walls.

"According to Henle, all the external longitudinal fibres do not rise from the fibrous rings, but the roots of the arteries."

*The Movements of the Heart.*—The movements of the heart can be most readily studied in their simplest form in the frog.

The batrachian heart, as seen in Fig. 187, is an egg-shaped mass slightly flattened at the sides and marked by a furrow which crosses the heart nearly at right angles to its axis, dividing the heart (in an anterior view) into an upper globular part, the two auricles, and a lower conical, the single ventricle; the anterior surface of the ventricle is also marked by a slight groove inclining from above downward toward the right of the heart. Anteriorly, the ventricle is seen to be continuous with a cylindrical prominence, the *bulbus arteriosus*, which crosses over the right auricle and divides into the right and left aortæ. In viewing the posterior part, the right auricle is seen to be continuous with a bulbar expansion of the inferior vena cava, which receives the name of the *sinus venosus*, the line of junction of the *sinus* with the auricle being marked by a slight furrow. The two auricles are separated from each other by an antero-posterior septum, incomplete at its lower margin, where the two auricles communicate through a crescentic opening; the opening of the *sinus* into the auricle is marked by an Eustachian valve, which hangs downward and toward the right.

The auriculo-ventricular valve consists of an anterior and posterior segment, each of which is continuous at its edge with the inter-auricular septum.

To expose the heart of a chloralized frog, the integument is divided over the sternum and the anterior wall of the upper part of the visceral cavity, which is then to be carefully opened so as to expose the pericardium, taking care not to wound the large abdominal vein. The pericardium is then carefully slit up and the pulsating heart exposed. A large glass rod is now thrust down the œsophagus of the animal so as thoroughly to distend the parts and bring the heart more prominently forward.

On directing attention to the series of movements which constitute a cardiac revolution, taking first the anterior view alone, the wave of contraction is distinctly seen to commence in the auricles. The auricles become distended and full of blood; they suddenly contract and transfer their contents into the empty and relaxed ventricle, which is now gorged with blood, but it is not until the auricular contraction is complete that the ventricle, in its turn, contracts and discharges the blood into the relaxed bulbus arteriosus, which becomes distended and finally forwards, in its turn, its contents to the arterial system. From the fact that while the ventricle contracts the auricles are already filling, and that the ventricle does not contract until the auricular contracting is complete, it would appear, on superficial examination, as if there were a constant interchange of contents between the ventricle and auricles. But on lifting up the ventricle and dividing the little band which connects its posterior surface with the pericardium, so as to expose the posterior portions of the heart, the true sequence of contraction is immediately evident. The wave of muscular contraction distinctly originates in the *sinus venosus*, extends to the auricles, and it is not until their contraction is complete that the ventricle contracts; but by this time the *sinus* is again already full and the auricles filling. Therefore, while the ventricular contraction is determined by that of the auricles, and the auricular by that of the sinus, the contraction of the latter originates independently of any previous movement.

This sequence of contraction may be graphically represented by resting a lever of the second class on the contracting heart in such a manner that its point will describe its movements on the smoked surface of a revolving drum, as shown in the accompanying tracing (Fig. 197):—

In this curve the first slight ascent represents the contraction of the auricles, and its subsidence represents the interval between its contraction and that of the ventricle, thus showing that the one is complete before the other commences. The next more decided ascent is due to the vigorous contraction of the ventricle and the descent to its relaxation. We learn from this that the auricles have completed their systole before the ventricle contracts.

Passing now to the movements of the heart as seen in mammals the thorax is to be opened in a rabbit, rendered insensible by chloral, by dividing the integument from the larynx to the end of the xiphoid cartilage and then removing the

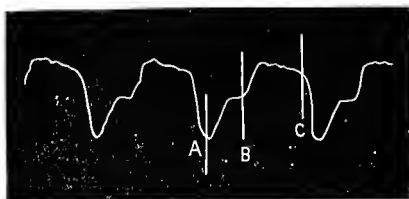

FIG. 197.—TRACING DRAWN BY A LEVER APPLIED DIRECTLY TO THE APEX OF THE FROG'S HEART. (Sanderson.)

A, contraction of auricles; B, contraction of ventricle; C, relaxation of ventricle.

sternum by cutting through the costal cartilages on each side with a pair of strong scissors. If the operation is performed carefully very little hemorrhage will occur. On dilating the opening in the thorax thus formed, and maintaining the opening by means of hooks fastened to weighted cords, the movements of the heart are readily followed. We have, however, by thus opening the thoracic cavity interfered with respiration, and to permit of a reliable study of the cardiac movements the animal's life must be prolonged by artificial respiration.

Having now the heart and great vessels well exposed, and the normal conditions as regards respiration imitated as nearly as possible, the sequence of events which make up a cardiac revolution may be readily followed.

Starting in the distended venous trunks at the base of the heart, as seen in the mammal, the wave of contraction extends rapidly to the auricles, now filled with blood, which contract with a sudden, sharp systole, discharging their contents into the flaccid ventricles, the auricular appendages becoming pale and the whole auricle being drawn down toward the auriculo-ventricular ring. During the systole of the auricles, the ventricles become more and more gorged with blood, but when felt are still soft and flaccid. Immediately, however, upon the completion of the auricular contraction, the ventricles harden and become globular, or, in other words, shorten and thicken. Examined more closely, it is seen that during repose the ventricles form an imperfect cone, its base being a transverse ellipse, but during systole they form a more perfect cone, shortened in its long axis, and having a circle for a base, the greatest contraction having taken place in its longitudinal and transverse axes, while the antero-posterior diameter of the base of the cone has been little altered, although the circumference of the base has been actually increased (Foster). At the moment of ventricular systole the heart rotates on its axis to the right, so as to expose more of the left ventricle, while the apex seems to approach the base. The rotation of the heart is due to the contraction of the muscular fibres which pass from the sternal surface of the auriculo-ventricular rings obliquely downward and to the left; when they shorten they raise the apex and bring more of the posterior surface of the ventricles in relation with the chest-walls. At this moment the aorta and pulmonary artery are seen to expand and lengthen, thus compensating for the shortening in the long axis of the ventricle. Then, as diastole commences, the ventricles flatten and elongate, the great arteries contract and shorten, the heart rotates back to the left, and the cardiac revolution is completed.

It has been stated that in the systole the apex seemed to be drawn up toward the base. This, however, is not exactly correct.

In the conditions in which we have been studying the heart its normal supports have been more or less interfered with, and although we have not thereby lessened the value of the conception obtained of the sequence of contractions, we may perhaps extend our knowledge as to the degree and character of the locomotion performed by different parts of the heart in its contraction.

This may be accomplished by the following experiment :—

A large dog should be rendered unconscious by a subcutaneous injection of morphine, fastened securely on his back, and a long, slender, steel needle then passed perpendicularly through the walls of his chest into his heart at the point of greatest intensity of the cardiac impulse. Then, following the line of the ventricle up to the aorta, three more steel needles should be inserted, one in each succeeding intercostal space above the first, and then again one on each side of the second needle, about one inch from it and in the same interspace. Then it will be seen that, although each of these needles moves at each contraction of the heart, the movements described by their free ends widely differ.

No. 1, inserted in the apex, merely quivers at each pulsation without describing any definite motion dependent upon the cardiac contraction, though it is seen to follow the ascent and descent of the diaphragm.

Nos. 2, 3, 4, inserted in the intercostal spaces above, describe an instantaneous upward movement at each contraction, the degree of excursion of their free ends being directly dependent upon their distance from No. 1. The fulcrum on which each needle moves is its point of transfixion of the chest-wall; therefore, an upward movement of the free end of the needle indicates a downward movement of the body in which the other end is inserted. Finally, Nos. 5 and 6 oscillate more or less horizontally, their free ends receding from each other as well as from No. 1 at each contraction of the ventricle.

From these facts we learn that the apex, the point at which the cardiac impulse is felt, is itself nearly motionless, while the base of the heart at each ventricular systole approaches the apex, and that the other parts of the ventricle are drawn toward the apex in a degree proportionate to their distance from it, while, as seen in the exposed heart, the shortening of the ventricles is compensated by the elongation of the great vessels at the base. The impulse, therefore, is the hardening of the ventricle, transmitted through the stationary portion which is in contact with the chest-walls, through the chest-wall to the finger. It is improper to speak of the impulse as a blow, as the apex never leaves the chest-wall. But while this is so, there is, nevertheless, a certain amount of motion in the apex which results in the elevation of the chest-wall at the point of cardiac impulse. If an excised heart is placed on a horizontal surface, the base of the ventricles in a state of diastole takes on the form of an ellipse with its largest diameter horizontal, while the apex falls until it is in contact with the supporting surface. When the ventricle passes into systole the base of the heart passes from an elliptical to a circular form, and since the apex takes a position in a line with the central point of the base of the heart it leaves the surface on which it rested and tilts forward, at the same time approaching the base from the reduction in the length of the ventricles. The state of affairs is somewhat similar while the heart is in its normal position in the thorax. There the base of the heart takes on an elliptical form from contact with the chest-walls, while the apex tends to fall away from the chest. In systole, the base, assuming a circular form, must cause the apex to move forward, and, so producing stronger pressure on the ribs, cause the elevation which constitutes the cardiac impulse, the base descending in systole as already described.

Ludwig and Hesse have shown that the shape which the heart assumes after death does not represent its shape during life, either during systole or diastole. They obtained the diastolic shape of the ventricle by making a plaster cast of the heart dilated under the pressure of a column of defibrinated blood equal to that of the mean arterial pressure (150 mm. of mercury in the dog). The systolic shape was obtained by immersing the heart, immediately after death, in a hot (50°C.) saturated solution of potassic bichromate, when the heart gives a single contraction and remains in systole, the proteids being coagulated from heart rigor. A plaster cast is then made as before. They found that in diastole the shape of the ventricle is nearly hemispherical, with the posterior surface

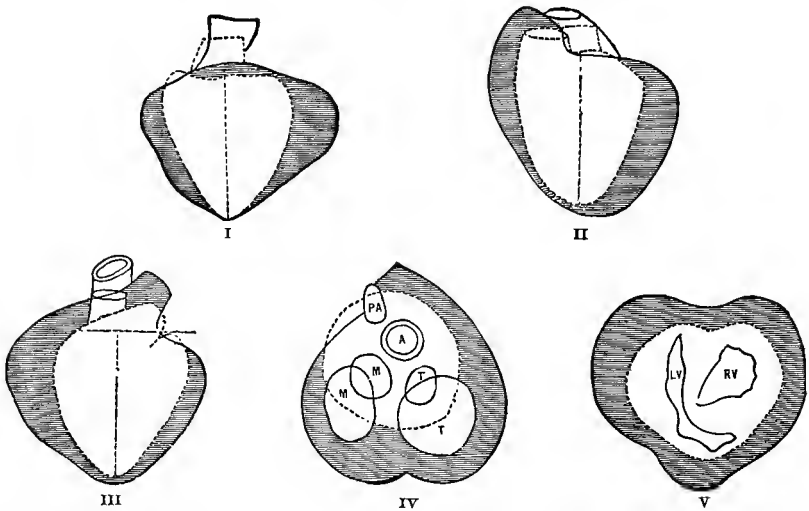

FIG. 198.—PROJECTIONS OF A DOG'S HEART, AFTER LUDWIG AND HESSE. (*Landois.*)

I, posterior surface. II, left lateral surface. III, anterior surface. IV, A, aorta; PA, pulmonary artery; M, mitral, and T, tricuspid orifices. V, projection of the base in systole and diastole: RV, right, and LV, left ventricles. The shaded outlines represent the projections of the heart in diastole, the dotted line the outline of the heart in systole.

flatter than the anterior, the greatest diameter being the transverse diameter of the base, and the shortest from the apex to the base. In systole the ventricle becomes more conical from the greater contraction of the basal diameters, the curvatures of the anterior and posterior surfaces being now nearly equal, and while the vertical diameter of the right ventricle shortens the left remains unchanged. In the systole, the area of the base of the heart is diminished nearly one-half, thus, by diminishing the auriculo-ventricular openings, greatly assisting the ventricular valves (Fig. 198).

The transmission of the ventricular contraction may be represented graphically by the cardiograph (Fig. 199).

Sanderson's cardiograph consists of a hollow disk, the rim and back of which are of brass, while the front is of thin rubber. To the back is fastened a flat steel spring, bent twice at right angles in the same direction, so that the free end, which is provided with an ivory button, hangs directly over the centre of the rubber membrane. The ivory button is on one extremity of a small screw which perforates the free end of the lever, while the other end of the screw rests on the rubber membrane, the rubber being protected from the point of the screw by a light metal plate. The instrument is further provided with three adjusting screws, by which it rests on the chest-wall. The cavity of the tympanum communicates by a rubber tube with the interior of a somewhat similar drum, the rubber surface of which is in communication with a long, light lever of the second order (Fig. 200).

On placing the ivory button of the cardiograph over the point of cardiac impulse, and regulating the adjusting screws so that the instrument is parallel to the chest-walls and the screw-point of the button in contact with rubber membrane, each movement of ascent of the button creates pressure on the rubber membrane, with a consequent diminution of the capacity of the tympanum. Then, since the drum is in air-tight communication with a second similar one, each diminution in the capacity of the first causes a proportionate increase in the contents of the second, a bulging of its rubber face, and a consequent elevation of the lever with which it is connected. Then, on causing this lever to record its movements on the smoked surface of a revolving drum, an exact record of the movement of the surface is obtained with which the button is in contact.

This instrument, applied to the study of the impulse of a healthy human heart, shows that each systole of the ventricle, when the button is precisely over the apex, is marked by a sudden ascent of the lever, and the end of the systole by a marked but more gradual descent (Fig. 201).

By shifting the cardiograph toward the sternum, so that the button is no longer over the point of impulse, a tracing of an entirely different character is obtained (Fig. 202).

Although the ventricular systole is indicated by an elevation of the lever, this ascent is immediately followed by a sudden fall below the position of rest of the lever,

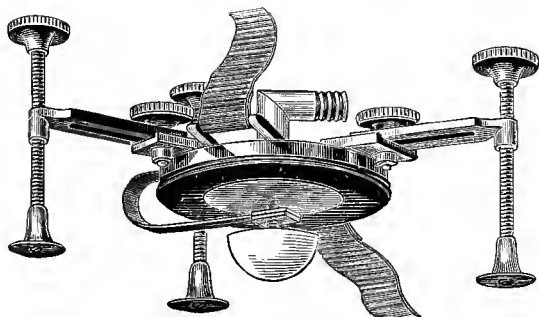

FIG. 199.—SANDERSON'S CARDIOGRAPH.

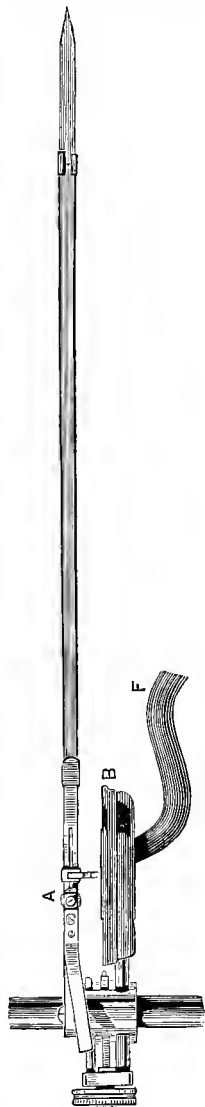

FIG. 200.—MAREY'S TYMPANUM AND LEVER. (Sanderson.)

A, bearings in which the steel axis of the lever works. It may be raised or depressed by the adjusting lever, the long arm of which extends downward and backward from A; B, tympanum; F, tube by which the cavity of the tympanum communicates with the cardiograph.

thus indicating that there has been an actual recession of the chest, and representing graphically the condition known in clinical language as the "negative impulse."

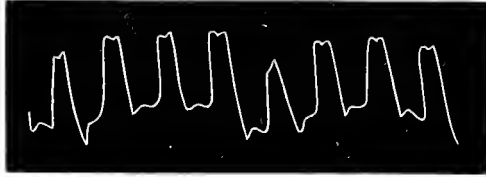

FIG. 201.—TRACING OBTAINED WITH THE CARDIOGRAPH WHEN THE BUTTON IS PLACED AT APEX BEAT OF THE HUMAN HEART. (Sanderson.)  
Each ascent in the curve coincides with the ventricular systole.

To recapitulate, it may be stated that a single pulsation of the heart may be divided into three phases:—1st. The auricles contract, while the

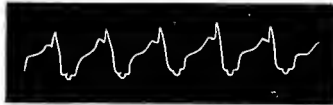

FIG. 202.—CARDIOGRAPH TRACING OBTAINED WHEN THE BUTTON IS PLACED TO ONE SIDE OF APEX BEAT. (Sanderson.)  
The line of descent coincides with the ventricular systole.

ventricles are relaxed, contraction and relaxation occurring synchronously on both sides of the heart. 2d. The ventricles contract, while the



FIG. 203.—HEART-BONES OF A COW, NATURAL SIZE. (Müller.)  
*a*, larger, *b*, smaller heart-bone; *c*, anterior, *d*, posterior extremity.

auricles are relaxed. 3d. Both auricles and ventricles are in a state of relaxation, the auricles being near the end and the ventricles at the

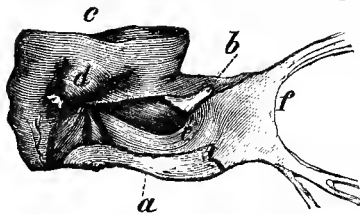

FIG. 204.—LOWER END OF THE AORTA OF A COW, SHOWING POSITION OF THE HEART-BONES, ONE-HALF THE NATURAL SIZE. (Müller.)  
*a*, larger heart-bone; *b*, smaller heart-bone; *c*, root of the aorta; *d*, right coronary artery; *e*, right semi-lunar valve; *f*, central part of the mitral valve.

commencement of their diastole; this phase is termed the *pause*, the condition of ventricular contraction being described as *systole*, of relaxation as *diastole*. The duration of a cardiac revolution, consisting of diastole, systole, and pause, is equal to the interval of time between two pulsations felt in any artery.

*The Action of the Valves of the Heart.*—The direction of the current

of circulating blood through the heart is rendered possible solely through the integrity of the cardiac valves. These valves, as already



mentioned, are situated between the two auricles and ventricles, and at the origin of the pulmonary artery and aorta. Their mechanical action is different, the two auriculo-ventricular valves operating upon the same principle, and the two valves at the starting point of the large arteries being similar in function and operation. Both the auriculo-ventricular valves at their bases constitute complete cylinders which originate in the auriculo-ventricular ring, which is often cartilaginous, and even, in some animals, as in the bird, furnished with a bone.

In the heart of the ox are found two bony structures at the origin of the aorta, to the larger of which are fastened the right leaflet of the aortic semi-lunar valve and the central portion of the mitral valve, while the smaller is in connection with the left semi-lunar valve of the aorta (Figs. 203 and 204).

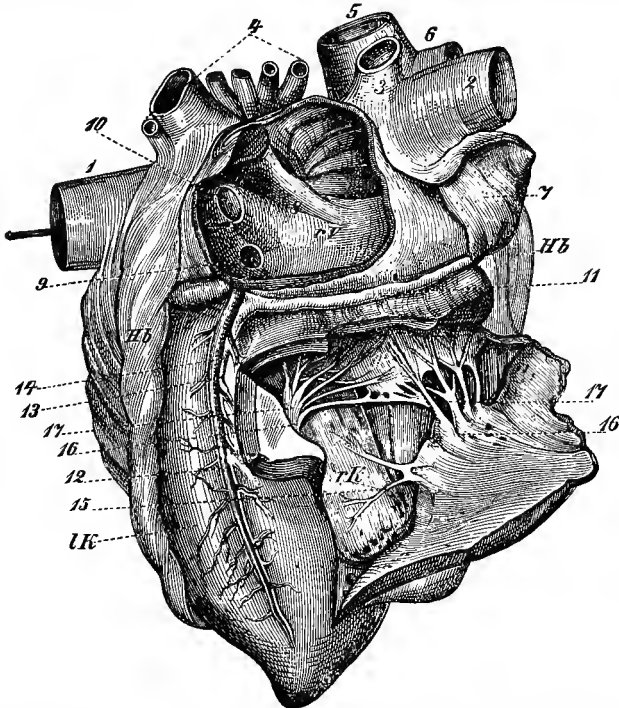

FIG. 205.—HEART OF THE HORSE, SEEN FROM THE RIGHT SIDE, THE RIGHT AURICLE AND RIGHT VENTRICLE BEING LAID OPEN. (Müller.)

*Hb Hb*, pericardium slit open and drawn to the sides; *rK*, right auricle; *rK*, right ventricle; *lK*, left ventricle; 1, inferior, or posterior, vena cava, with probe inserted in it; 2, superior, or anterior, vena cava; 3, azgyous vein; 4, pulmonary veins; 5, posterior aorta; 6, anterior aorta; 7, right auricular appendage; 8, Lower's ridge; 9, orifice of the coronary vein; 10, oval foramen; 11, right coronary artery; 12, longitudinal fissure, with 13, its artery, and 14, its vein; 15, columnæ carneæ; 16, 16, papillary muscles; 17, 17, chordæ tendinæ; and 18, a leaflet of the tricuspid valve.

The cylindrical form of these valves exists only a short distance from this ring, and then the valve divides into a number of different segments, which, in the right ventricle, are three in number, hence the name of tricuspid valves, and in the left are two, hence the name of mitral valves.

The leaflets of these valves again subdivide into numerous tendinous filaments which are inserted in the papillary muscles of the heart (Figs. 205 and 206). The tendinous threads which arise in the papillary muscles and are inserted in the valve are not in connection solely with the free border of the latter, but the entire surface of the valve, which is directed toward the walls of the ventricle, offers points of insertion for these tendons (Figs. 207 and 208).

Numerous theories have been proposed to explain the manner in which the auriculo-ventricular valves prevent, in the systole of the ven-

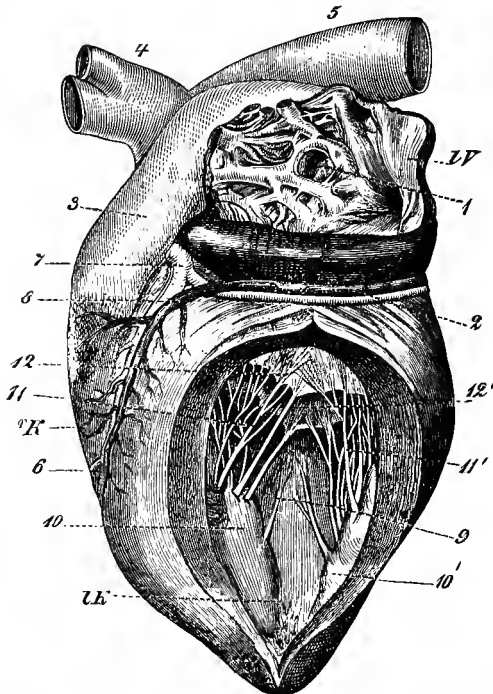

FIG. 206.—HEART OF THE HORSE, SEEN FROM THE LEFT SIDE, THE LEFT AURICLE AND LEFT VENTRICLE BEING LAID OPEN. (Müller.)

*LV*, left auricle; *LK*, left ventricle; *RK*, right ventricle; 1, trabeculae in left auricle; 2, coronary fissure, with its artery and vein; 3, pulmonary artery; 4, anterior aorta; 5, posterior aorta; 6, left longitudinal furrow; 7, left coronary artery; 8, coronary vein; 9, columnae carneae; 10, papillary muscles; 11, chordae tendinae; 12, mitral valve.

tricle, regurgitation of blood into the auricles. These may be classified into two different groups.

According to the one, the occlusion is purely passive, and is produced by the pressure of the blood behind the valves, causing their ascent, and so occluding the orifice between the ventricles and auricles. In this view of their action, the papillary muscles have for their sole function the regulation of the situation of the valves, and, consequently,

the degree of occlusion, and to prevent the valves being everted into the auricles. According to the other view, which seems to be supported by the largest amount of proof, the papillary muscles play an active rôle in the occlusion of the auriculo-ventricular orifices. This view has been strongly supported by Küss, who describes their operation as follows: "If the finger be introduced into the auriculo-ventricular region at the moment of the systole of the ventricle, we find that the kind of funnel

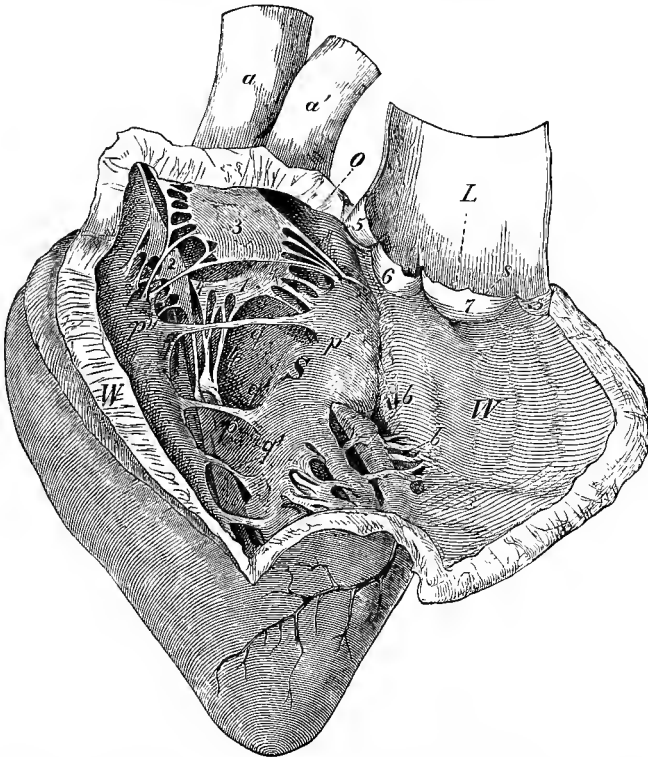

FIG. 207.—HEART OF A COW, WITH THE RIGHT VENTRICLE LAID OPEN, ONE-FOURTH THE NATURAL SIZE. (Müller.)

*a*, posterior aorta; *a'*, anterior aorta; *b b*, spaces in the lateral wall of the right ventricle; *p p'*, papillary muscles; *q q'*, columns carneae; *L*, pulmonary artery laid open; *O*, opening into right auricle; *S*, ventricular septum; *W*, lateral wall of ventricle; 1, 2, and 3, leaflets of the tricuspid valve; 4, chordae tendineae; 5, 6, 7, cusps of semi-lunar valve; 8, sinus of Valsalva.

which hangs from the auricle to the ventricle is continued; it even appears to lengthen itself out, and the finger, as it were, is drawn into the interior of the ventricle. In fact, the first result of the contraction of the papillary muscle is the lengthening of the auricular cone, the edges of which are afterward brought near each other. While this hollow cone descends into the ventricle, the sides of the latter contract and approach the cone in such a manner that the auriculo-ventricular

apparatus acts as a sort of hollow piston, which penetrates the ventricle and comes into close contact with its walls, and thus the ventricle (Figs. 207 and 208) empties itself completely, the contact becoming perfect between its sides and the auricular prolongation.

“The result of this mechanism, which is so simple, and yet so generally misunderstood, is that no reflux of blood into the auricle can take place; the auricle, even by means of the mechanism which we have described, exercises a sort of suction upon the venous blood, its cavity being

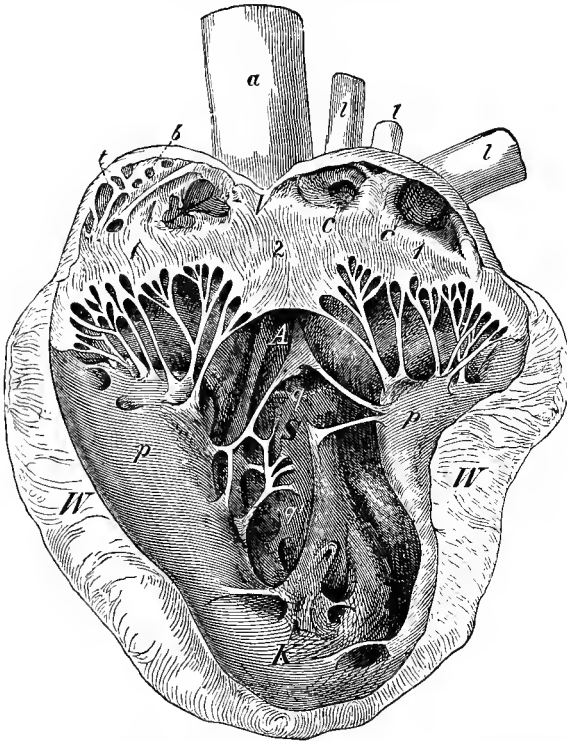

FIG. 208.—HEART OF A COW, WITH LEFT AURICLE AND VENTRICLE LAID OPEN. (Müller.)

*a*, root of the aorta; *b*, spaces in the wall of the auricle; *c, c*, orifices of the pulmonary veins; *l, l*, pulmonary veins; *p, p*, papillary muscles; *g, g*, columnae carneae; *t, t*, auricular trabeculae; *A*, orifice of the aorta; *K*, left ventricle; *S*, septum; *V*, left auricle; *IV*, lateral wall of left ventricle; 1, 2, leaflets of the mitral valve.

continued so far into the ventricle. We see, also, that when the ventricular systole is complete, the lengthened tube, the hollow cone which unites the ventricle and the auricle, is full of blood, and that a slight and rapid contraction of the auricle is sufficient to drive this blood into the ventricle and fill it.

“Nearly all the standard works admit without discussion the theory of the occlusion of the auriculo-ventricular orifices by the simple mech-

anism of a plug or valve, just as in the case of the arterial orifices (see farther on), but without remarking the entire difference of structure which distinguishes the auriculo-ventricular valves from the semi-lunar valves of the aorta and of the pulmonary artery. This theory has become, up to a certain point, the property of Chauveau and Faivre, on account of the interesting experiments which they have so often made upon horses killed instantaneously by section of the bulb, and in which artificial respiration was kept up. 'If, under these circumstances, the finger is introduced into one of the auricles, and the auriculo-ventricular orifices explored, the tricuspid valves will, at the moment that the ventricles begin to contract, be felt to straighten, push their borders, and stretch in such a manner as to become convex, and form a concave dome above the ventricular cavity.' This method of proof does not always furnish

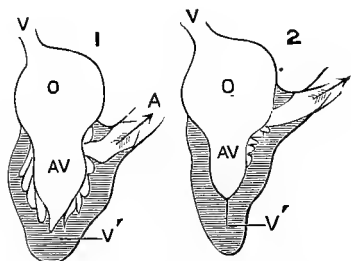

FIG. 209.—DIAGRAM OF THE AURICULO-VENTRICULAR APPARATUS DURING VENTRICULAR SYSTOLE, AFTER KÜSS. (*Beauvis.*)

1. During the first part of systole. 2. At the completion of systole. AV, valvular cone; O, auricle; V' ventricle; A, aorta or pulmonary artery.

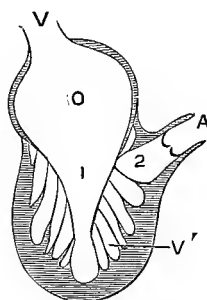

FIG. 210.—DIAGRAM OF THE AURICULO-VENTRICULAR APPARATUS DURING VENTRICULAR DIASTOLE, AFTER KÜSS. (*Beauvis.*)

V, vena cava; O, auricle; V' ventricle; A, artery; 1, valvular cone; 2, arterial infundibulum.

such decided results, and many observers, among others Spring and Onimus, have met with one entirely different. The latter found the auriculo-ventricular orifices effaced by the contraction of the muscular fibres, which, at this level, really form a sphincter (this is the case in the heart of birds, but not of the mammalia). The papillary muscles, being now contracted, lower the valves, and these, supporting themselves against the sides of the ventricles, have the effect of driving the blood ingulfed between them and the corresponding sides into the arterial orifices. Such is, in short, the working of the auriculo-ventricular membranes. This is the only theory which accounts for the existence and arrangement of the papillary muscles."

The action of the semi-lunar valves is more simple. The semi-lunar valves are composed of three free folds of serous membrane, which during

the systole of the ventricle are forced back by the escaping current of blood against the walls of the pulmonary artery and aorta; they, therefore, offer no obstacle to the escape of blood from the cavities of the ventricles. At the end of the contraction of the ventricles relaxation commences, the ventricles dilate, and there is, therefore, a tendency for the blood to return into their cavities from the aorta and pulmonary artery. This backward current carries the blood behind the free margins of these valves and, distending the pockets behind them, flattens out the valves, causing them to come into complete contact and thus completely obstruct the orifice of these arteries into the ventricles (Fig. 211). This closure of the semi-lunar valves is rendered more perfect by the fact that the three leaflets do not originate from the walls of the artery on the same plane, but their origins form a spiral line around the base of

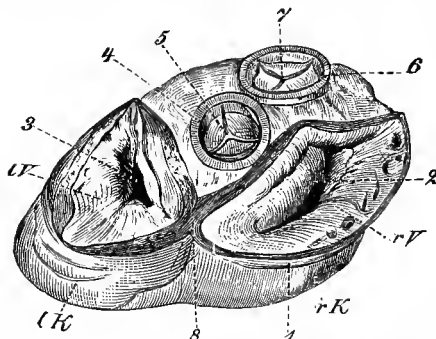

FIG. 211.—BASE OF THE HEART OF THE HORSE, BOTH AURICLES BEING REMOVED. (Müller.)

rV, right auricle; lV, left auricle; rK, right ventricle; lK, left ventricle; 1, coronary furrow; 2, right, 3, left auriculo-ventricular orifices; 4, origin of the aorta; 5, aortic semi-lunar valves; 6, origin of the pulmonary artery; 7, its semi-lunar valves; 8, auricular septum.

these arteries; consequently, the leaflets descend one over the other, and, to a certain extent, overlap each other, and thus completely prevent regurgitation of the arterial blood into the ventricles.

#### The Sounds of the Heart.—

When the ear is applied to the walls of the thorax over the heart, two sounds are recognized, which differ in intensity, in pitch, and in duration. These sounds are described as the first and second sounds of the heart. The first of these sounds

is dull and prolonged, and coincides with the systole of the ventricle; the second sound is shorter, sharper, and of higher pitch, and occurs at the end of the systole, or at the commencement of ventricular relaxation. The musical interval between these two sounds corresponds about to a fourth; the pitch of both sounds varies, but this interval is usually preserved. The first sound is heard with greatest distinctness at the spot where the impulse is felt, and is not dependent upon the cardiac impulse, from the fact that it exists after the removal of the chest-walls. As it coincides with the contraction of the ventricle, it also, of course, coincides with the closure of the auriculo-ventricular valves, and is largely due to the action of these valves.

The character of the first sound of the heart is not, however, purely valvular in nature, and is not what would be expected from the sudden closure of a membranous valve. That it is, however, largely due to the

action of these valves is proved by the alteration in its character which occurs when either the mitral or bicuspid valves are diseased, when this sound becomes obscure, altered, or replaced by murmurs.

While the valves in their closure are the principal factors in the production of the first sound of the heart, its characters are dependent upon the presence of several other factors. It will be found that whenever a muscle contracts a sound is produced which depends for its pitch upon the number of contractions occurring per second. At the moment of closure of the auriculo-ventricular valves the blood is forced out from the ventricles into the great arteries. The rushing sound of this moving column of blood is, therefore, another factor in the production of the first sound of the heart.

To recapitulate: It may be stated that the first sound of the heart is produced by the sudden tightening of the auriculo-ventricular valves, whatever view be accepted as to the nature of their action, to the sound of muscular contraction, and to the rushing of the current of blood from the ventricles into the pulmonary artery and aorta. In support of this view, it may be mentioned that when the muscular contraction of the heart becomes greatly weakened from any depressing cause, as in severe fevers, the first sound of the heart becomes distinctly sharper and more purely valvular in nature, evidently due to the diminished intensity of the contraction of the cardiac muscle.

The second sound of the heart is short and sharp, and is due to the sudden closure of the semi-lunar valves, which by their rapid increase in tension, like every other elastic membrane, produce a sound. In living animals, the second sound of the heart is best heard over the root of the large vessels. When the semi-lunar valves are destroyed, as by inserting a hook into these valves, the second sound disappears. The relative lengths of the auricular and ventricular systole and diastole, the time of the occurrence of the impulse, and the different sounds of the heart may be diagrammatically represented by a line divided into five parts, which represent the length of a cardiac revolution:—

	1	2	3	4	5
Auricle . . .	Systole.	Diastole or repose.			
Ventricle . . .	Repose.	Systole.		Repose.	
Sounds . . .	Silence.	1st Sound.			2d Sound.
Shock . . .		Impulse.			

We may now extend, somewhat, the sketch which has already been given as to the movement of the blood through the pulsating heart.

During the diastole of the auricles the blood streams into them from the large venous trunks which are in connection with the base of the heart, the propelling force being the pressure of the blood in the veins and the aspiration exerted by the lungs. Soon the elastic tension of the walls of the dilated auricles becomes sufficiently great to balance the forces which cause the entrance of blood into the auricles; but before the entrance of blood into the auricles is entirely arrested, the ventricles, which had, up to this point, been in systole, and thus prevented entrance of blood from the auricles, now relax, the auriculo-ventricular valves are forced open by the pressure of blood in the auricles, and the ventricles dilate, not only through the aspiration of the lungs, but in virtue of the elasticity of their own walls.

The auricles now pass into systole, and by the pressure of the contraction of their muscular walls force the blood from the auricles through the auriculo-ventricular openings into the relaxed and dilating ventricles. The blood passes from the auricles into the ventricles, and not back into the veins, because this is the direction in which the moving blood-current meets with the least resistance. We have seen that by the opening of the auriculo-ventricular valves the bottom falls out of the auricles and the dilatation of the empty ventricles exerts a negative pressure on the contents of the auricles. At the same time the contraction of the muscular fibres of the auricles serves somewhat to constrict the openings of the veins, and the pressure of the blood in the *venæ cavæ*, supported by the valves in the inferior vena cava, offer a sufficient resistance to prevent regurgitation into the veins.

The blood continues to flow from the auricles into the ventricles until the propelling force of the contracting auricles is balanced by the elastic tension of the dilated ventricles or by commencing ventricular systole, exit of blood from the ventricles being prevented by the closed semi-lunar valves at the openings of the aorta and pulmonary artery. The ventricles now being filled, systole commences, the closure of the auriculo-ventricular valves prevents regurgitation into the auricles, and, the force of the ventricular contraction being greater than the pressure of the blood in the aorta and pulmonary artery, the semi-lunar valves are forced open, and the ventricles empty themselves completely into these vessels. The ventricles then relax, regurgitation from the great arteries being prevented by the closure of the semi-lunar valves, the ventricles fill themselves from the auricles, and the process goes on as before.

3. THE HYDRAULIC PRINCIPLES OF THE CIRCULATION.—The physical principles concerned in the movements of the blood through the arteries of the animal body are largely governed by the purely physical laws of hydraulics. Before, therefore, we attempt to explain the movements of the blood, a glance at the most important of the physical principles of



hydraulics or hydrodynamics will greatly facilitate the explanation of the circulation.

Every fluid particle under the action of the law of gravitation falls like a solid body to the earth. When, however, a large mass of fluid is freely acted on by gravity the slight cohesion exerted by the molecules of liquid on each other leads to their separation one from the other.

Every fluid, therefore, in falling tends to separate into drops. This tendency to break up into drops may be prevented either by delaying the flow of the liquid, as by causing it to descend an inclined plane, or permitting the liquid to flow within a vessel in which the tendency of the particles to separate will lead to the production of a vacuum, and atmospheric pressure will, consequently, serve to strengthen the cohesive forces. Consequently, in a stream of liquid falling into a tube each particle is not only acted on by gravity, but also by the pressure of the mass of fluid behind it. If, therefore, an aperture be made in the bottom of any vessel, any particle of liquid on the surface of the fluid contained in that vessel, if we could imagine that it would fall freely without reference to the particles below, would have a velocity on reaching the orifice equal to that of any other body falling through the distance between the level of the liquid and the orifice. If the liquid in such a vessel be maintained at the same level, the particles will follow one another with the same velocity and will issue in the form of a stream; while, from the principle of transmission of pressures in liquids equally in all directions, a liquid would issue from an orifice in the side with the same velocity as from an aperture in the bottom of the vessel, provided the depth were the same.

The velocity of efflux, therefore, as formulated by Torricelli, is the velocity which a freely falling body would have on reaching the orifice after having started from a state of rest at the surface. It is expressed by the formula—

$$V = \sqrt{2gh}, \text{ in which } g = 32.16 \text{ ft.}$$

It further follows that while the velocity of efflux depends on the depth of the orifice below the surface and not on the nature of the liquid, the velocities of the efflux, from the laws of falling bodies, are directly proportional to the square roots of the depths of the orifices, while the quantity of fluid which issues from the orifices of different areas is very nearly proportional to the size of the orifice, provided the level remains constant. It is evident, however, that the mass of liquid in such an experiment at the side of the column vertically over the orifice of exit offers by friction more or less resistance to the line of movement.

And while the molecules vertically over the centre of the orifice pass directly down and out by the orifice, the molecules of fluid at the side of this moving column not only offer resistance to this downward

motion through attraction, but also through their own mobility tend to pass in an oblique line into the moving column. In fact, every particle above the orifice endeavors to pass out of the vessel, and in so doing exerts pressure on every particle near it. The result may be made clear by the diagram (Fig. 212).

Every particle above A B endeavors to pass out of the vessel, and in so doing exerts a pressure on those near it. Those that issue near

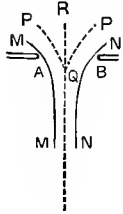

FIG. 212.

A and B exert pressures in the direction M M and N N, those in the centre of the orifice in the direction R Q, those in the intermediate parts in the directions P Q, P' Q'. In consequence of the fluid in the space P Q, P is unable to escape, and that which does escape, instead of assuming a cylindrical form, contracts and takes the form of a truncated cone. It is found that the escaping jet continues to contract until at a distance from the orifice about equal to the diameter of the orifice.

This part of the jet is called the *vena contracta*. It is found that the area of its smallest section is about five-eighths or 0.62 of that of the orifice. Accordingly, the actual value of the escape is only about 0.62 of its theoretical amount. If a cylindrical tube (termed *ajutage*), with a length two or three times its diameter, be made the channel of exit of the fluid, the amount discharged per second may be increased to about 0.82 of the theoretical amount. A contracted vein is formed within the

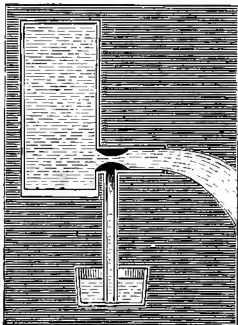

FIG. 213.

tube, just as it would do if issuing freely into the air; but from the adhesion of the water to the interior of this tube, the section of the column flowing from the tube is greater than that of the contracted vein (Fig. 213). (The contraction of the moving column of fluid within the tube causes a partial vacuum, and if a side tube, dipping into mercury, be connected with the *ajutage* at this point the mercury will rise in the vertical tube, demonstrating the existence of the vacuum. This fact is made use of in Bunsen's filter pump.) If a conical tube be fitted to the orifice of exit, with the

smaller end in connection with the vessel, the efflux may be still further increased, and fall very little short of the theoretical amount.

*Flow of Liquids Through Rigid Tubes.*—If the *ajutage* inserted in the side of the vessel has more than a certain length, the amount of fluid escaping is very considerably reduced. This fact rests upon the hydraulic friction produced between the moving liquid and the walls of the tube in liquids which exert a certain amount of adhesion against the

walls of the tube; for the movement of the portion of liquid in contact with the walls of the tube is delayed by adhesion, and the movement of the central column is delayed by friction with the external layers. It is evident that the resistance due to friction along the sides of the tube will depend upon the length of the tube. This may be illustrated by the accompanying diagram.

If a horizontal tube be connected with a reservoir of liquid and a number of vertical side arms be connected with the horizontal tube, the liquid will rise in the branch tubes to different heights inversely as the distance of the vertical tube from the reservoir, for the propelling force in the horizontal tube will diminish from point to point on account of the uniformly acting resistance (Fig. 214). The vertical tubes will, therefore, enable us to measure the pressure exerted by the fluid upon the walls of the tube through which it is flowing, and shows us that the pressure at any point of such a tube will be less the greater the distance from

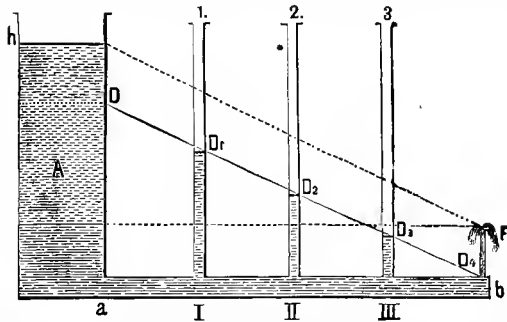

FIG. 214.—ESTIMATION OF PRESSURE OF LIQUID IN A HORIZONTAL OUTFLOW-TUBE CONNECTED WITH A CYLINDRICAL VESSEL FILLED WITH WATER. (*Landois.*)  
a b, outflow-tube, along which are placed at intervals vertical tubes I, II, and III to estimate the pressure. The line D, D1, D2, D3, D4 indicates the rapidly decreasing pressure.

the propelling force. Further, the resistance increases with the velocity of the current; for it is evident that, the resistance being mainly dependent upon friction, if the column of fluid is at rest there is, consequently, no friction and no resistance, while the greater the rapidity of motion the greater will be the friction, and, consequently, the greater the resistance. It follows from this that the smaller the tube the greater will be the resistance, for the smaller the tube the greater will be the velocity of motion. It may, therefore, be said that in a moving column of liquid "the resistance is directly proportional to the length of the tube and is inversely proportional to its cross-section, and increases with the speed of the stream."

It has been mentioned that the friction of the central moving column on the outer layer is a source of resistance, consequently increase in the cohesive nature of the fluid will increase the retardation of the central

column and accordingly increase the resistance, while heat, by diminishing the cohesion of the liquid, will lessen the resistance.

A similar state of affairs holds in tubes of varying calibre. In tubes of unequal calibre, as already pointed out, the velocity of the current will vary; that is, it will be slower in the wide part of the tube and more rapid in the narrower parts of the tube. And as the resistance is greater in narrow tubes, the propelling force will diminish more rapidly than in wide tubes. "When a small tube passes suddenly into a tube of larger diameter there is a sudden increase of pressure at the surface of junction, accompanied by a diminution in the speed of movement through the wider tube. The molecules of which the fluid consists cannot suddenly change the swift movement into a slower one, and on account of their inertia the pressure exerted by them on one another develops the increased force. On the other hand, the rapid transition from a slow to a quick movement at a place where a wide tube

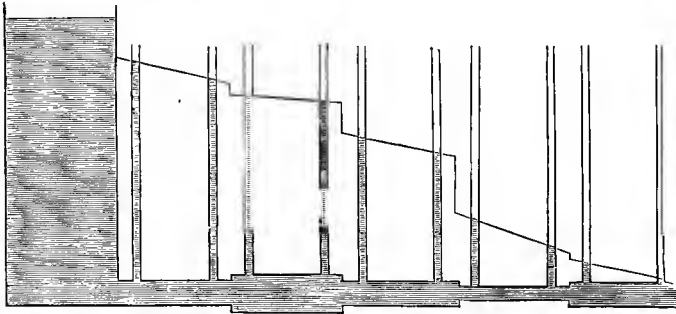

FIG. 215.—DIAGRAM ILLUSTRATING THE VARIATIONS OF PRESSURE IN AN OUTFLOW-TUBE OF VARYING CALIBRE. (*Rollet.*)

passes into a narrow one diminishes the pressure. The effect, however, in a system of tubes of a series of wider parts is to diminish the total resistance" (Robertson) (Fig. 215).

Bending the tube adds a new resistance, the fluid pressing more strongly on the convex than on the concave side of the bend, and, therefore, producing greater resistance to movement on the convex side. Consequently, resistance is increased behind the bend and diminished in front of it, with a consequent increase in the velocity of the current at this point. When a tube through which liquid is passing divides into two or more branches, still further resistance is added by not only increasing the surface, but by the production of angles and bends. The total calibre of the branches which originate from a single tube may be either greater or less, and so the surface of contact between the walls of the tube and the fluid arc either increased or decreased.

The most interesting case corresponds to that seen in the develop-

ment of the circulatory system of animals, where a vessel divides into several branches of greater total calibre than the parent stem, and where, after repeated subdivision, the branches again unite to form a single tube whose calibre is about the same as that of the original tube.

A simple representation of such a series of branching tubes is given in Fig. 216.

In such a series the pressures are seen in the broken line A, B, C, D, E. At B, taking into consideration only the increase in calibre, a sudden increase in pressure occurs. On the other hand, considering only the occurrence of bends and angles in the tube, the pressure would suddenly sink. These two causes, however, oppose each other, and the most ordinary representation of the case would be indicated by a slower sinking in the line of pressure than in the single parent stem. The condition is, however, different where the branches again unite to form a single trunk; here the pressure must fall, because the bed of the stream becomes contracted, while at the same time an angle is also met with. Both these facts, therefore, work in the same direction, and the pressure undergoes a sudden fall which would be greater than that produced by mere contraction of the stem.

It follows from the above that in a symmetrical system of tubes the pressure does not symmetrically increase and decrease, but will be greater in any portion in the centre of the system of the tubes (at M, Fig. 216) than the mean of pressure at any two points equally distant in front or behind this point. It may, therefore, happen that in a complicated system of branching tubes the resistance is not greater than in a single tube, or may even be smaller, since the increase in the diameter may diminish the resistance more than the branching increases it. If the resistance is the same, it is evident, also, that the rapidity is the same in both cases, and as a consequence more fluid will flow out of such a branching system of tubes when the resistance is smaller than would escape from a single tube (Fig. 217).

The angle formed by the branches with the original stem seems to produce no marked influence on the resistance and velocity of movement.

The above relationship between resistance and velocity of movement

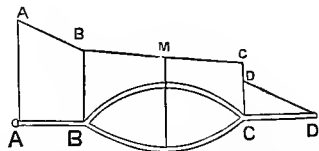

FIG. 216.—DIAGRAM OF VARIATIONS IN PRESSURE IN BRANCHING TUBES. (*Wundt*.)

The changes in pressure in the tube A, B, C, D are represented by the broken line A, B, C, D, E.

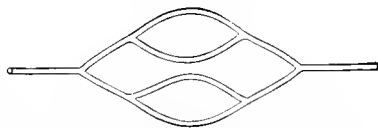

FIG. 217.—DIAGRAM OF SYSTEM OF BRANCHING TUBES. (*Wundt*.)

and diameter of the tube only holds as long as the calibre of the tubes does not fall below a certain diameter.

In capillary tubes the conditions are so far similar in that the resistance is proportional to the length of the tube. It has been found, however, that the discharge is not proportional to the calibre of the tube, but to the fourth power of the diameter. This is evidently to be explained by the greater prominence attributed to the adhesion of the fluid to the walls of the tube, and will, therefore, differ greatly in different liquids.

*The Flow of Liquids Through Elastic Tubes.*—When a constant stream passes through an elastic tube the conditions are precisely the same as have been described as governing the movement of liquids through rigid tubes. When, however, the current is intermittent, the elasticity of the tube then comes into play, and decidedly modifies the conditions of movement.

If a quantity of liquid be forcibly injected into an elastic tube already distended with fluid, the first part of the tube suddenly dilates to accommodate the quantity of fluid propelled into it.

This impulse communicates a movement of undulation to the particles of fluid, which is rapidly transmitted to all the particles of fluid within the tube. In other words, a wave movement is rapidly propagated throughout the entire length of the tube. If the elastic tube be imagined to be closed at its further end, the wave will be reflected from the point of occlusion, and will be conducted to and fro in the tube, gradually decreasing in intensity until it at length disappears. This propagation of the wave should not be confounded with the forward movement of the fluid. For when the fluid itself moves the movement of each particle is in the line of the axis of the tube, but in a wave movement the motion of the particles is simply one of undulation at right angles to the line of movement, and not of forward movement.

In a rigid tube, a movement of progression alone exists. In a closed elastic tube, filled with liquid, into which more fluid is suddenly injected, the wave movement alone exists.

If the peripheral end of the elastic tube be open and more fluid be injected, both movements co-exist; that is, there is a forward progression of the particles of the liquid added to the wave movement already described. When the wave movement passes in the same direction as the current, it is called a positive wave; when in the opposite direction, it is called a negative wave. The speed of propagation of the wave is proportional to the elastic force of the walls of the tube, while the height of the wave depends upon their extensibility.

It is evident from the above that the movement of liquids in open tubes will vary according to whether their walls are rigid or elastic. If in a rigid tube a definite amount of liquid be injected, no more or no less

can escape from the open end. If the calibre of a rigid tube be diminished, the increased resistance will react on the propelling power, and will likewise prevent injection of more than can escape by the open end.

Thus, suppose a rigid tube be connected with a pump which throws any definite quantity, say one ounce, of water at each stroke, the rigid tube being supposed to be already distended with liquid. At each stroke of the pump, therefore, one ounce of liquid will escape from the free end. Suppose, now, the free end of the rigid tube be so decreased in calibre as to allow only one-half the previous quantity to escape, this resistance will, therefore, react on the pump and prevent its throwing more than one-half the quantity into the tube.

If, on the other hand, the walls of the tube be elastic, the conditions will vary according as the resistance is increased or diminished.

If an elastic tube of the same length and diameter as the rigid tube already experimented with be connected with a pump throwing the same quantity of liquid at each stroke, it is evident that the conditions will be the same as in the rigid tube; that is, the same amount of fluid will escape from the free end as enters at the opposite end from the pump, and the time of injection and escape of liquid will coincide.

If, now, the distal end of the elastic tube be contracted so as to diminish the outflow, the pump still throwing the same amount of fluid, it is evident that if we say only one-half of the amount injected can escape from the free end of the tube the other half will collect in the tube and overdistend its walls.

In the intervals of action of the pump, the elasticity of the walls of the tube will lead to their contraction, and this recoil will act as a propelling power on the contents of the tube, and lead to its escape from the end of the tube. The stream, now, instead of being interrupted and in jerks, will tend to become continuous. Thus, elastic tubes have the power of transforming an intermittent into a continuous flow. The fluid thus contained in a series of elastic tubes is subjected to two pressures, one derived from the propelling force and the other exerted by the elastic walls, due to the overdistention of the tubes. In tubes with elastic walls, the velocity of the current is diminished before the quantity of fluid discharges is increased.

In the mechanics of the circulation the former of these forces is spoken of as blood pressure upon the walls of the vessels, and is due to the propelling power of the heart; while the second, the force exerted by the walls of the arteries upon the blood, due to the recoil of these vessels, is spoken of as arterial tension.

4. THE CIRCULATION IN THE ARTERIES.—The principal cause of the movement of the blood in the arterial system is the intermittent

contraction of the ventricles. At each systole of the ventricles the heart completely empties itself, and, consequently, throws into the blood-vessels the amount of blood capable of being contained in its cavity, while at the same time an equal quantity of blood enters the heart from the veins. This injection of new amounts of blood into the arterial system, as a consequence, occurs intermittently, as may be readily recognized by opening the artery of an animal, when it will be found that the blood will issue in spurts, each spurt corresponding to a contraction of the ventricles. It will, however, be remarked that there is also an escape of blood during the pauses of the contractions of the heart, and that the farther from the heart a blood-vessel be opened the less will be the apparent effect of ventricular contraction in increasing the velocity with which the blood flows from the divided vessel. In other words, the blood within the blood-vessels is subjected to a considerable tension, derived from the elasticity of the vascular walls, and this tension itself serves partly to assist in the onward movement of the blood. When a vessel divides, except in rare instances, the sum of the calibre of the branches is, as a rule, greater than that of the parent stem. In nearly all cases, however, the capacity of the branches is considerably greater than the original vessels before division, even though the sum of the diameters of the branches be but little greater than that of the parent stem. The arterial system may thus be regarded as a cone whose apex joins the left ventricle, and whose base is represented by the capillary system. The venous system, on the other hand, may be represented by an inverted cone, whose base is formed by the capillaries, and whose apex is in communication with the right auricle.

In the arteries the conditions of the movements of the blood are largely governed by the physical characteristics of the walls of the blood-vessels. The arteries consist of three coats—an inner serous coat or endothelium, the middle elastic and muscular coat, and an outer fibrous coat. It is to the middle coat that the physical characters of the circulation are largely due. The proportion of muscular fibre to elastic tissue varies considerably in different parts of the arterial system. In the large arteries directly in the neighborhood of the heart the middle coat is composed almost solely of yellow elastic tissue, while the muscular fibres are present in small amount. As the capillary system is approached, or, in other words, as the arteries become smaller and smaller by repeated subdivisions, the elastic coat diminishes in amount, while the muscular coat increases. The relative proportions of these two elements of the middle coat are, therefore, inversely as the diameter of the vessel.

The action of these two elements is to a certain extent antagonistic, although they both combined serve to assist in the onward movement of the blood.



The direction of the muscular fibres of the arteries is circular, while longitudinal fibres are absent. As a consequence, the contraction of the muscular coat of an artery tends to obliterate its calibre. On the other hand, the elastic element tends to keep the artery open. When, therefore, an artery is reduced in calibre by contraction of its muscular fibres, when the muscular coat becomes relaxed, the elastic coat dilates it. There is no active dilating mechanism in the walls of the blood-vessels. The combined action of these two forces, the expanding force of the elastic coat and the contracting force of the muscular coat, would serve to cause the arteries to assume the form of hollow ribbons with flattened sides, or flattened cylinders. This shape is found in the arteries of an animal when examined after death. In the act of dying the arteries empty themselves by the contraction of the muscular coat, forcing their entire contents over into the venous system; they, therefore, become completely emptied, and are then flattened cylinders; this condition holds until one of the larger arteries be opened; air then enters the arteries, the muscular force having been lost through death; the arteries then dilate through the action of the elastic tissue which is longer preserved, and they now become hollow cylinders filled with air. It is thus seen that the larger arteries are highly elastic tubes, and the influence of the elasticity of the walls of a tube on a moving column of fluid has been already alluded to. In other words, the elastic tissue in the walls of the large arteries tends to overcome the intermittent action of the heart and to render the flow of blood in the arteries continuous. In the smaller arteries the elastic tissue is reduced in amount and often becomes entirely absent, but, on the other hand, the proportion of muscular tissue is increased. Muscular tissue is itself a highly elastic tissue, consequently the smaller arteries are not only elastic but are also supplied with contractile walls, and as a consequence their calibre may be reduced, thus permitting variations in the supply of blood to different localities.

The conditions for permitting a satisfactory interchange between the blood and different organs are, therefore, fulfilled. For we have not only a constant flow of blood through all parts of the body, but this flow is susceptible of general and local alterations; general alterations, because the heart itself is capable, as already indicated, of being modified in its activity; and, second, because we see that the smaller arteries are supplied with tissue which, by regulating the calibre of the blood-vessels, is capable of regulating the amount of blood supplied to different organs. The mechanism by which this supply is governed will be alluded to directly.

*Blood Pressure.*—In the arteries in their normal state the elastic coat is in a condition of distention beyond its point of equilibrium. In other words, the arteries are vessels overfilled with fluid. The contents

of the vessels must, consequently, produce pressure on the walls of the blood-vessels to a sufficient degree to prevent the regaining by the elastic tissue of its position of equilibrium. Such a tension as already described is one of the important factors in blood pressure. By blood pressure is meant the pressure which the blood exerts on the walls of the vessels. By arterial tension is meant the pressure which the walls of the vessels exert on their contents. It is thus seen that these two terms are mutually convertible. The pressure which the blood exerts on the walls of the vessels is, of course, dependent upon the energy of the contraction of the heart and the resistance which the capillaries offer to the onward motion of the blood. The pressure which the elastic walls of the arteries exert on their contents will, of course, again depend upon the amount of blood contained in the arteries and their consequent distention, and while this, again, as we shall see, is capable of being modified by different causes, it is mainly dependent upon the activity of the heart. Blood pressure is measured by estimating the pressure which the blood exerts on the vascular walls.

It has been mentioned that when an opening is made in the walls of an artery the blood escapes therefrom in jets, and it is found that the larger the artery, and, consequently, the nearer the opening is to the heart, the higher will be the jet of blood and the more intermittent will be the flow; this indicates that the blood pressure is, therefore, greater in the large vessels than in the small arterioles, and is only what is to be expected from the conditions which are necessary for the maintenance of the circulation. It has been stated that the arteries subdivided into smaller and smaller vessels, and, consequently, the friction proportionally increases with the minuteness of the vessel. It is, therefore, evident, further, that the pressure in the large arteries must be higher than in the arterioles, and in all arteries higher than in the veins.

The blood pressure may be directly measured in any accessible artery by directly connecting a manometer with the interior of the vessel (Fig. 218). Such an instrument, in its simplest form, consists of a U-shaped tube containing mercury in its lower part, the distal end being free to the atmosphere, and the proximal end connected directly with the interior of the blood-vessel. If the pressure in the blood-vessel is greater than the atmospheric pressure, it is evident that the mercury will be depressed in the proximal arm and rise in the distal arm, until the difference in height between the columns of mercury in the two arms equals the pressure exerted by the fluid. Such an experiment is termed a blood-pressure experiment, and is readily performed on any of our domestic animals.

To make a blood-pressure experiment, the animal should be securely fastened and the artery exposed through an incision. In the dog, in which such experiments may be most conveniently performed, the arteries usually experimented on are the carotid or the femoral. To expose the carotid artery, the hair is removed from the front part of the neck, and an incision, about two inches in length, made in the middle of the neck, and an incision, about two inches in length, made in the middle of the neck, at the anterior border of the sterno-mastoid muscle: the platysma and subcutaneous fascia are then broken through with forceps or blunt hooks, and the sterno-mastoid muscle pushed to the outside, and the artery is readily found lying beneath it, the pneumogastric nerve running in the same sheath. The bundle containing the pneumogastric, the sympathetic, and

carotid arteries is then raised on a blunt hook, the connective tissue gently torn away with two pairs of forceps, and the artery freed from the surrounding nerves and fibrous tissue. After the blood-vessel is so isolated for a distance of about an inch, it is firmly ligated at the extremity of the free portion nearest to the head, and a thread is then tied in a loop-knot around the artery at the end of its freed extremity nearest to the heart. A small cut is then made in the intermediate portion with a pair of seissors, and a slightly constricted glass tube inserted into the interior of the artery and bound fast with a thread. This glass tube is then to be filled by a pipette with a saturated solution of sodium bicarbonate, to prevent coagulation of the blood, and the cannula then connected by thick rubber tubing, also filled with the same solution, with the proximal arm of the manometer. Care should be taken that all air-bubbles are removed from the cannula, rubber tube, and proximal arm of the manometer, so that the entire tubing, from the level of the mercury to the interior of the carotid, is completely filled with soda solution. If, now, the slip-knot previously tied around the carotid is

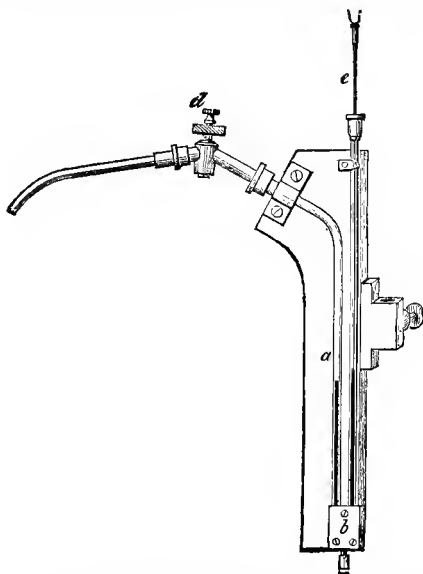

FIG. 218.—MERCURIAL MANOMETER FOR MEASURING AND RECORDING THE BLOOD PRESSURE. (Yeo.)

*a*, proximate limb of the manometer; *b*, union of the two limbs of the manometer; *c*, the rod floating in the mercury carries the writing point; *d*, stop-cock through which the sodium bicarbonate can be introduced between the blood and the mercury of the manometer.

loosened, thus establishing communication between the interior of the artery and the manometer, the blood at once rushes from the artery into the connecting tube, and so causes the level of mercury to be depressed in the proximal arm and rise in the distal arm. This rise of mercury occurs very rapidly, in jerks corresponding to the beats of the heart, and soon reaches its maximum. When this point is attained, the mercury does not remain level, but undergoes rapid oscillations, each rise corresponding to the systole of the ventricle, each fall corresponding to the diastole. If a float, swimming on the top of the mercury, in the distal arm of the manometer be allowed to record its up-and-down movements on a moving surface, as, for example, the revolving drum of the kymographion (Fig. 219), a series of curves will be produced, in which each ascent corresponds to the contraction of the ventricle, each descent to its diastole (Fig. 220). In the experiment, as above described, it is evident that a considerable quantity of blood will leave the arterial system and fill the tube of the manometer.

To avoid this loss of blood, it is therefore advisable to inject the sodium carbonate solution into the tube of the manometer until the column of mercury has been elevated to the height which will probably correspond to that of the mean arterial pressure.

Comparative experiments made in the above-described manner will show that the blood pressure is considerably higher in the arteries than in the veins, and greater in the large arteries than in the arterial branches (Fig. 221); so, also, the pressure may be demonstrated to be higher in the small veins than in the large veins at their opening into the heart. Experiment will further show that in the veins the pressure is almost constant, overlooking the insignificant variations which are due to respiration; so, also, the pressure will be found to be almost constant in

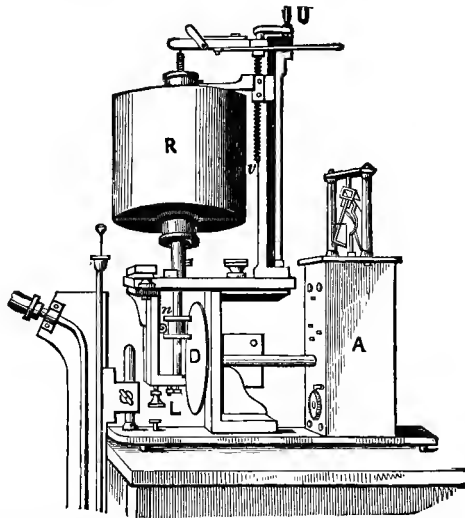

FIG. 219.—LUDWIG'S KYMOGRAPHION, AFTER HERMANN. (Yeo.)

The ordinary form of rotating, blackened cylinder (R), which is moved by the clock-work in the box (A) by means of the disk (D) pressing on the wheel (n), which can be raised or lowered by the screw (L) so as to rub on a part of the disk more or less near the centre, and thus rotate at different rates. The cylinder may be raised by the screw (v) which is turned by the handle (U).

the small arteries, while in the large arteries considerable variations, corresponding in their increase to the systole and their decrease to the diastole, are invariably found. It is evident that the mean between the maximum and minimum pressures in the arteries, as indicated by these oscillations, will represent the force which is concerned in the propulsion of the blood. Although theoretically and practically the pressure decreases as the distance increases from the heart, yet in any artery which is not too small to be subjected to such manometrical experiments it will be found that the pressure will be slightly affected, not more than one-tenth lower than the mean pressure in the aorta. This fact indicates that the blood in moving through the arteries has to overcome but slight

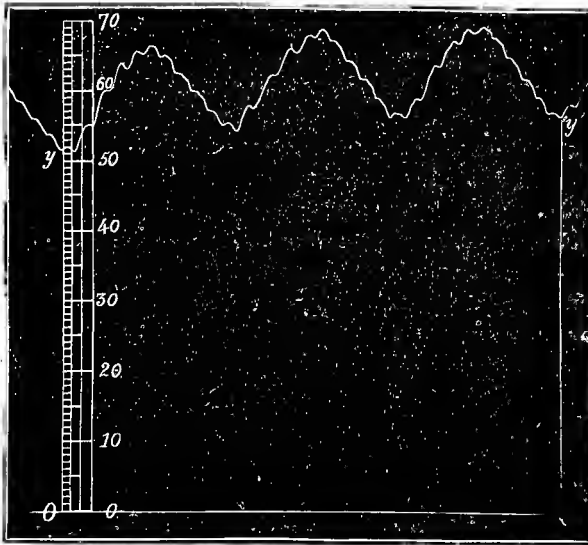

FIG. 220.—BLOOD-PRESSURE CURVE, DRAWN BY MERCURIAL MANOMETER. (Yeo.)

$O$  to  $x$  = zero line,  $y$  to  $y'$  = curve with large respiratory waves and small waves of heart impulse. A scale is introduced to show height of pressure in millimeters of mercury.

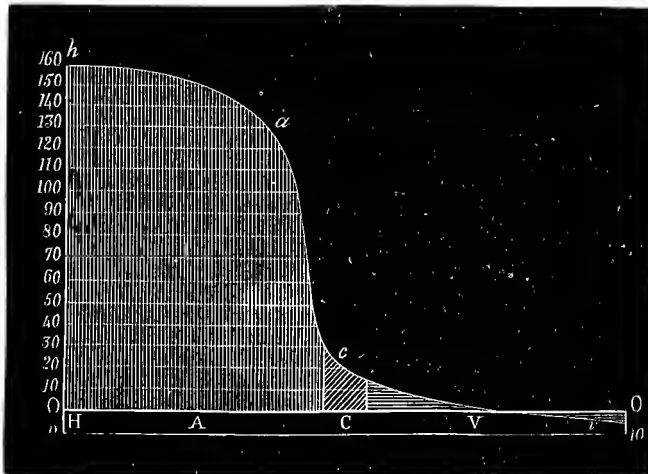

FIG. 221.—DIAGRAM SHOWING THE RELATIVE HEIGHTS OF BLOOD PRESSURE IN THE DIFFERENT REGIONS OF THE VESSELS. (Yeo.)

H, heart; A, arteries;  $a$ , arterioles;  $c$ , capillaries; V, small veins;  $v$ , large veins; H V, being the zero line, the pressure is indicated by the elevation of the curve. The numbers to the left give the pressures (approximately) in millimeters of mercury.

resistance, evidently to be explained by the fact that as the arteries divide their total calibre increases. If the mean pressure in the artery is measured at different times it will be found to be subject to very great variations, from causes which will subsequently receive attention.

The average blood pressure of mammals is by no means dependent upon the animal's size. In all cases the arterial blood pressure may be stated as exceeding the atmospheric pressure and varying between one hundred and two hundred millimeters of mercury.

The following table gives various estimates of the mean arterial pressure in different animals (Volkman) :—

Animal.	Mean Pressure in mm. of Mercury.			
Horse,	321 mm.	(Ludwig)	in the carotid	artery
Horse,	214	"	"	"
Horse,	150	(Spengler)	"	brachial "
Horse (old),	140	"	"	" "
Sheep,	206	(Ludwig)	"	carotid "
Sheep,	169	"	"	" "
Sheep,	156	(Blake)	"	brachial "
Sheep (old),	86	"	"	" "
Calf,	177	(Ludwig)	"	carotid "
Calf,	165	(Spengler)	"	" "
Calf,	153	"	"	brachial "
Calf,	133	(Ludwig)	"	" "
Dog (large),	172	"	"	carotid "
Dog,	157	(Blake)	"	brachial "
Dog,	166	(Spengler)	"	carotid "
Dog,	143	(Ludwig)	"	brachial "
Dog (young),	104	"	"	" "
Goat,	135	"	"	" "
Cat,	150	"	"	" "
Rabbit,	90	"	"	" "
Goose,	162	(Blake)	"	carotid "
Stork,	161	"	"	" "
Pigeon,	157	"	"	brachial "

The facts thus reached experimentally as to the gradual decrease in pressure from the arteries to the commencement of the veins and from there to the larger venous trunks completely explains the constant current of blood from the arteries to the veins. The blood, therefore, moves in a circle from the heart to the arteries, through the capillaries to the veins, and from the veins to the heart, to again enter the arterial system.

*The Velocity of the Blood.*—From the fact that the arteries as they pass into the capillaries increase immensely in area, and as the capillaries pass into the veins a corresponding decrease is found, it is to be expected that the velocity of the blood-current will be greatest in the vessels near the heart. As the blood leaves the heart to pass into the aorta the velocity of the current is at its maximum; it then gradually decreases as the capillaries are reached, then undergoes a sudden retardation, and again, as the blood is collected from the capillaries in the veins, the current moves with an increasing velocity as the right side of the heart is approached. No absolute figures can be given as representing the normal

velocity at any point in the blood-vessel system, since measurements show that at any one point the velocity is subject to very great variations.

The velocity and pressure of the blood at any given point do not correspond, and may even be in inverse ratio; thus many causes, such as obstruction of any part of the vascular system, will increase the blood pressure at that point and decrease the velocity. As a rule, the pressure at any point depends upon the distance of that point from the heart, whether in the arterial or venous system, while the velocity depends upon the capacity of the vessels at that point.

Where the area of the circulatory system is very large, as in the capillaries, the blood circulates slowly, just as the current of a stream becomes retarded as it widens into a lake.

Various methods have been employed for calculating the rapidity of the circulation in different blood-vessels. The following represents the estimations as to the flow in the arteries, capillaries, and veins of the horse (Volkman):—

Carotid artery,	. . . . .	300 mm. per second
Maxillary artery, . . . . .	. . . . .	165 " " "
Metatarsal artery, . . . . .	. . . . .	56 " " "
Capillaries, . . . . .	. . . . .	0.5 to 0.8 " " "
Jugular vein, . . . . .	. . . . .	100 " " "
Vena cava, . . . . .	. . . . .	110 " " "

Chauveau estimates the velocity of the blood-flow in the carotid of the horse as varying from 520 to 150 mm. per second, the highest velocity coexisting with the systole of the ventricle and the lowest with its diastole. In the larger veins respiration also produces considerable variation in the velocity of the flow, the velocity being increased in inspiration and decreased in expiration. The velocity of the circulation through any one vessel may be modified by a number of causes; provided the artery maintains its calibre unchanged, the velocity would evidently be dependent upon the propelling force. Therefore, an increase in the energy of the heart's contraction, the calibre of the arteries remaining unchanged, will produce an accelerated flow through those vessels, while a decrease in the heart's energy will correspondingly retard the arterial current. On the other hand, the heart's energy remaining the same, a dilatation of the artery will cause a slowing of the current, and a reduction in the calibre of the artery will cause the current to become accelerated. So, also, if the resistance to be overcome in the circulation of the blood be reduced, as by the relaxation of the capillaries, the energy of the heart's contraction and the calibre of the artery remaining the same, the velocity of the blood-current will be increased; while, again, an increase in the resistance, the other conditions being unchanged, will retard the blood-flow.

Various attempts have been made to calculate the time required by the blood for making one complete circuit of the body. The method which is generally accepted as giving reliable results is what is known as the "transfusion method" of Hering, and consists in injecting into one of the jugular veins toward the heart a solution of some salt, the presence of which in the blood may be readily recognized by chemical tests, and in finding how soon after the injection the salt appears in the blood coming from the head in the corresponding vein on the opposite side of the neck. As determined by Vierordt, the duration of the circulation in different animals is as follows:—

Horse,	31.5 seconds.	Goose,	10.86 seconds.
Dog,	16.7 "	Duck,	10.64 "
Rabbit,	7.79 "	Buzzard,	6.73 "
Hedgehog,	7.61 "	Fowl,	5.17 "
Cat,	6.69 "		

By comparing these numbers with the frequency of the pulse in these animals, the deduction has been made that the circulation is accomplished in 27 heart-beats. From this the amount of blood thrown out at each contraction of the ventricle may be calculated: for if the entire amount of blood passes through the heart in 27 pulsations, one pulsation will throw out  $\frac{1}{27}$  the total amount of blood in the body, and placing this amount at, for example,  $\frac{1}{13}$  of the body weight in a man weighing 65.8 kilos, the ventricles at each pulsation will discharge 187.5 grammes, the amount, of course, being the same for both ventricles. If we assume that these data are approximately correct, the work done by the heart may be calculated. One kilogramme-meter is a force which in the unit of time can raise one kilo one meter high. If, therefore, the left ventricle expels 0.188 gramme of blood against the pressure of blood in the aorta (250 milligrammes of mercury or 3.21 meters of blood), the work done at each systole is  $0.188 \times 3.21 = 0.604$  kilogramme-meter. If the number of beats is 75 per minute, then the work done in twenty-four hours =  $(0.604 \times 75 \times 60 \times 24) = 65,230$ . kilogramme-meters, while the work done by the right ventricle, since the pressure in the pulmonary artery is only one-third that of the aorta, will be one-third this amount, or 21,740. kilogramme-meters: and both ventricles together will do a work of 86,907. kilogramme-meters in the twenty-four hours. Since part of this work is converted into heat, the contractions of the heart assist in maintaining the body temperature.

In the case of the ox it has been estimated that 0.75 liter of blood is driven from the left ventricle at each systole, and since the pulse in this animal averages 50 per minute 37.50 liters of blood will pass through the heart in each minute, or 900 liters in twenty-four hours. The specific gravity of the blood being 1045, 18,810 pounds of blood, or



fifteen times the body weight, will be set in motion by the contractions of each ventricle, or 37,620 pounds in all. If it be admitted that the amount of blood in the ox is  $\frac{1}{3}$  of the body weight, or 52.18 pounds, and each systole propels 0.75 liter, or  $1\frac{1}{2}$  pounds of blood, thirty-five contractions of the heart would be needed to drive the entire amount once around the body; or, the pulse-rate being 50 per minute, the circulation would be completed in forty-two seconds. It is evident that these figures are in opposition to the estimates obtained by Hering's method, which, according to Vierordt, places the duration of the circulation as equal to the time required by the heart for making twenty-seven pulsations.\*

*The Pulse.*—As the left ventricle empties itself into the aorta it is compelled to overcome the pressure of the blood already contained in the arterial system and two phenomena result—an acceleration of the current of blood toward the capillaries and the dilatation of the aorta to accommodate the additional amount of blood thrown in by the ventricle.

In the description of the physical principles concerned in the passage of fluid through an overfilled system of tubes with elastic walls, it was stated that at each introduction of fluid a wave was produced which rapidly traversed the walls of the tube, its velocity of movement being proportional to the tension of the walls of the tube, while its cause was found not in the passage of the fluid, but in an up-and-down oscillation of the walls of the vessels. Such a wave of oscillation as seen in the arterial system is described as the pulse. The pulse is, therefore, the diastole of the arteries. In the arteries which are close to the heart this diastole is almost synchronous to the systole of the ventricle, but as the distance from the heart increases a sensible interval may be recognized between the contraction of the ventricle and the appearance of the pulse-wave. This time is required for the transmission of the wave through the walls of the vessels. To determine the time required for the transmission of this wave it is only necessary to estimate the interval of time elapsing between the contraction of the heart and the appearance of the pulse-wave in any locality. This time, together with the distance of the point examined from the heart, will enable us to calculate the rate of movement of the pulse-wave. It has been found that the transmission

\*It is probable that the data on which the above calculations are made are not even approximately correct, though they may perhaps serve to give a general idea of the subject. For experimental proof as to the different sources of error in Hering's method and the mode of calculating the amount of blood thrown out in the contractions of the ventricles, see papers by the author—"A New Method for Determining the Amount of Blood Thrown Into the Arterial System by Each Ventricular Systole," *Philadelphia Medical Times*, Jan. 26, 1884, and "The Time Required by the Blood for Making One Complete Circuit of the Body," *Transactions of the College of Physicians, Philadelphia*, 1884, and *American Journal of the Medical Sciences*, April, 1884. Also W. H. Howell and F. Donaldson, "Proceedings of the Royal Society," No. 226, 1883 and 1884, p. 139, and Stolnikow, *Archiv für Anat. u. Physiologie*, 1886.

of the undulation is not uniform in all segments of the arterial system. It progressively diminishes from the centre to the periphery, and increases with the resistance and thickness of the arterial walls. It is, therefore, more rapid in the arterics of the inferior extremities.

It has been found that in man in the arterial system of the upper extremities the pulse-wave travels with a velocity of 5.8 meters per second. In the arterial system of the leg the velocity of movement is about 6.4 per second. In young individuals before maturity, and when, therefore, the arteries are more extensible and, consequently, less elastic, the velocity of the pulse-wave is diminished, it then being only about four meters per second. So, also, the causes which reduced the blood-pressure will also reduce the rapidity of movement of the pulse-wave. It must not be forgotten that the time of appearance of the pulse-wave in any point of the arterial system by no means indicates that the blood thrown out from the left ventricle would in that interval reach the point at which the pulse-wave is perceived; for by comparing the velocities of movement of the blood, even in the vessels where the velocity of movement is highest, and the velocity of movement of the pulse-wave, it will be found that the latter moves with many times the higher velocity. The onward current of the blood in the arteries at points at a distance removed from the heart is due to the blood being mechanically pushed forward by the increased quantities thrown into the vascular system by the contraction of the ventricle.

When the finger is applied over a superficial artery resting upon some firm surface, as on a bone, a series of impulses are felt which coincide in number with the contractions of the heart. They are not, however, synchronous with the heart's contraction, but each dilatation of the artery will occur at an appreciable interval after the heart's contraction, the length of that interval corresponding with the distance of the point examined from the heart. This intermittent expansion is called the pulse, and corresponds to the intermittent outflow of the blood from a severed artery, and is present in the arteries only, being absent, except under certain circumstances, from the capillaries and veins.

The practical phenomena concerned in the production of the different degrees of the pulse-wave may be reproduced by forcing fluid intermittently through a tube with elastic walls, in which a variable resistance may be introduced, and by so arranging movable levers in contact with the walls of the tube as to enable them to record their movements on a revolving surface.

The following diagram, after Marey (Fig. 222), represents the curves produced by a series of levers placed at intervals of twenty centimeters along an elastic tube, into which fluid is forced by the intermittent strokes of a pump. With each stroke of the pump each lever rises and then falls, thus describing a curve and indicating an expansion of the tube, which travels along its walls in the form of

a wave. The rise of each lever is abrupt; its fall is more gradual, and usually marked by secondary fluctuations.

If two levers, separated by a considerable length of tube, be allowed to record their movements on a rapidly traveling surface, it will be found that on working the pump the movements described by the levers will not be synchronous; in other words, an appreciable interval of time will be required for the transmission of the wave through the length of tube separating the two levers. In

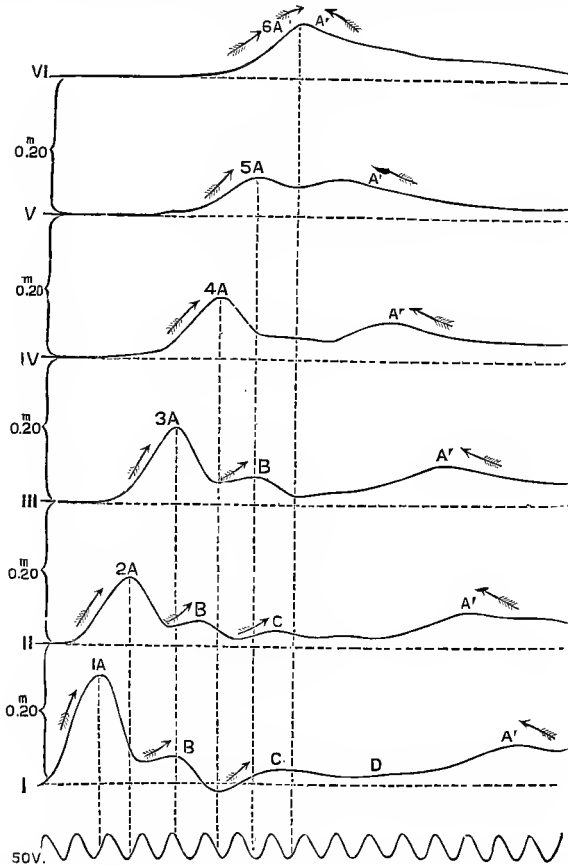

FIG. 222.—PULSE-WAVES DESCRIBED BY LEVERS PLACED AT INTERVALS OF TWENTY CENTIMETERS ON AN ELASTIC TUBE, INTO WHICH FLUID IS FORCED BY THE SUDDEN STROKE OF A PUMP. (Foster.)

The pulse-wave is traveling from left to right; A, primary, and B C secondary waves. The intervals between the dotted lines each correspond to 1/50 second, determined by the tuning-fork curve V', and permit measurement of the velocity of the wave. A'A' are reflected waves from the closed end of the tube.

such an apparatus the statement already made as to the conditions governing the rapidity of transmission of the wave-impulse may be readily demonstrated. The more rigid the tube, the more rapid the movement of the wave; the more extensible the tube, the slower the wave travels. It will also be noticed that the nearer the levers are to the pump, the greater will be their excursion, indicating a greater expansion of the tube at that point, while in very long tubes the wave gradually decreases in intensity until it often becomes scarcely distinguishable.

The same condition applies in the arterial system of animals: the nearer the artery to the heart, the greater will be its expansion on the systole of the ventricle and the stronger will be the pulse, while the greater the distance the less will be the expansion and the weaker, consequently, will be the pulse.

It has been mentioned that the descending limb of the curve described by such levers is ordinarily broken into a number of secondary undulations. These may be due to various causes. When by the injection of a mass of fluid the walls of the tube are distended, as they regain their position of equilibrium inertia carries them still farther, until the point of equilibrium has been passed; a recoil then takes place, and so on. In other words, each point of the tube is the seat of a series of oscillations following each succeeding wave, and which are due simply to the inertia of the walls of the tube.

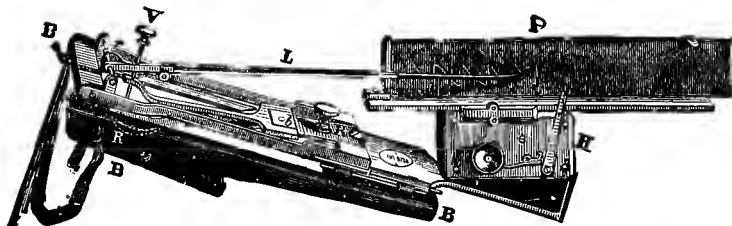

FIG. 223.—MAREY'S SPHYGMOGRAPH. (Yeo.)

The frame B, B, B, is fastened to the wrist by the straps at B, B, and the rest of the instrument lies on the forearm. The end of the screw, V, rests on the spring, R, the button of which lies on the radial artery. Any motion of the button at R is communicated to V, which moves the lever L up and down. When in position, the blackened slip of glass is made to move evenly by the clock-work, II, so that the writing point draws a record of the movements of the lever.

Again, in the artificial scheme of the circulation, if the resistance be considerable, or if the end of the tube be completely obstructed, the wave will be reflected from the distal end of the tube, and will again cause a secondary wave. If a lever (the sphygmograph, Fig. 223) be so placed on an artery in a living animal as to record the movements of its walls, various breaks will also be seen in the descending limb of the pulse-curve (Fig. 224). The most important of these is the so-called dicrotic wave, which is more or less marked in every pulse, although it may be so exaggerated as to produce the impression of a double impulse, or may, on the other hand, be scarcely perceptible. Anything which reduces the tension in the arterial system will facilitate the development of the dicrotic wave. Anything which increases the rigidity of the arteries reduces the degree of the dicrotic wave. It is, therefore, evident that the dicrotic wave is



FIG. 224.—TRACING DRAWN BY MAREY'S SPHYGMOGRAPH. (Yeo.)

mainly a wave of oscillation, due to the inertia of the walls of the vessels, possibly being reinforced by a wave of expansion reflected from the closure of the aortic valves. When the conditions are especially favorable for producing such waves of oscillation, or, in other words, when the walls of the arteries are especially relaxed, we will then sometimes find that the pulse-curve in its descent will be marked by two breaks, the first of which is then spoken of as the pre-dicrotic and the second as the dicrotic wave.

5. THE CIRCULATION IN THE CAPILLARIES.—The capillaries consist of minute tubules whose walls are constituted by a single layer of transparent, thin, nucleated, endothelial cells joined to each other by their

margins. These tubules divide and reunite to form networks which differ in shape and arrangement in different organs and tissues. Their diameter varies considerably, but is as a rule about that of the single red blood-corpuscle. In the lungs and brain, the capillaries are smaller than those of the skin; in the retina and muscle, are smaller than in bone,

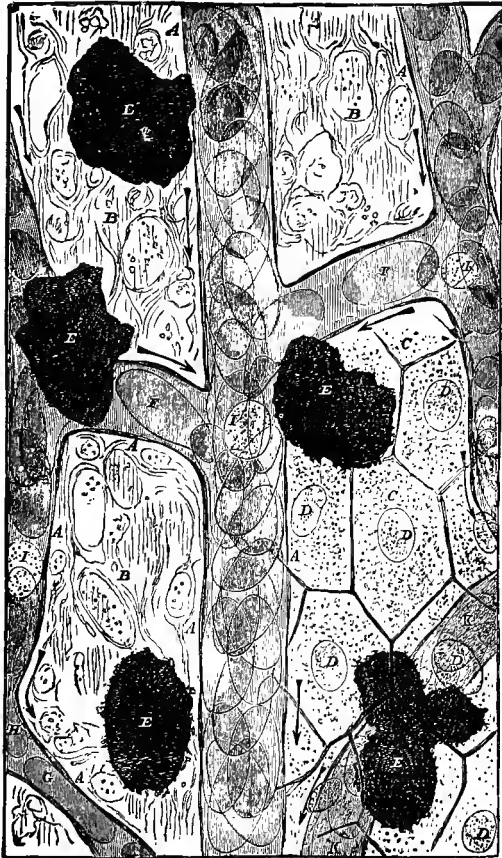

FIG. 225.—SMALL PORTION OF FROG'S WEB. VERY HIGHLY MAGNIFIED, AFTER HUXLEY. (*Yco.*)

A, wall of capillary vessels; B, tissue lying between the capillaries; C, epithelial cells of the skin, only shown in part of specimen where the surface is in focus; D, nuclei of the epithelial cells; E, pigment-cells, contracted; F, red blood-corpuscles; G, H, red corpuscles squeezing their way through a narrow capillary, showing their elasticity; I, white blood-cells.

marrow, liver, and the choroid tunic of the eye. In all probability the walls of the capillaries are not contractile, although they are capable of undergoing variations in diameter, this change in all probability being of a passive nature, owing to similar phenomena taking place in the small arteries and veins. Thus, the pulse which is evident in inflamed

organs is not due to rhythmic contractions of the walls of the capillaries, but to the paralysis of the walls of the minute arterioles and the consequent conduction of the impulse from the heart.

The circulation of the blood through the capillaries admits of ready study in the transparent tissues of different organs, such as the web of a frog's foot, the lung of the frog, or the mesentery of the guinea-pig. When such tissue is subjected to microscopic examination in an animal rendered motionless by the injection of curare, the blood may be seen passing in a continuous stream from the smaller arterioles through the capillaries to the veins (Fig. 225). The arterioles are readily recognized by the greater velocity of the flow within them and by the fact that occasionally faint pulsations synchronous with the contractions of the heart may be recognized. Under ordinary circumstances when the circulation through the capillaries is examined it will be found that the corpuscles pass in single file with a velocity usually of about 0.57 mm. a second. The calibre of the capillaries is, however, the seat of frequent changes whose mechanism will be subsequently studied. Often we shall find that the capillaries dilate, and we have then a stream of corpuscles moving several abreast through them, and even while undergoing inspection the capillaries may be seen to become smaller in diameter and occasionally in certain places so narrow as to refuse the passage of a single corpuscle; the blood then becomes blocked up behind this contraction, and then we have channels dilating behind this obstruction and carrying off the stagnated blood.

The mean blood pressure in the capillaries has been placed at about thirty-five millimeters of mercury, but it is evident that this pressure must be subject to very great variations.

When a microscopic examination is made of a frog's foot it is seen that the file of nucleated corpuscles move with their axes parallel with the stream, rotating sometimes on their axes, and occasionally we find an evidence of the flexibility of the red blood-cells by noticing that sometimes one of these cells, striking the bifurcation of a capillary, will become doubled on itself, part lying in one branch and part in another, until finally driven along by the cells coming behind it.

The white blood-cells will be found to be moving with a much lower velocity than the red blood-corpuscles (one-tenth or one-twelfth as fast), rolling slowly along in contact with the walls of the capillaries outside of the central, rapidly moving blood-current. Such a layer is termed the inert layer, and in nearly all cases it will be found that, while the red blood-cells move in a rapid stream through the centre of the vessel, a clear space between this central column and the walls of the capillaries may be recognized, in which inert layer, as already mentioned, the white cells may be nearly always found. The presence of the white blood-cells

in this peripheral layer is due to two causes. The white blood-cells are much more adhesive than the red, and therefore tend to cling to the sides of the capillaries. In addition to this, the white blood-cells are lighter in specific gravity than the red, and it has been noticed that when a fluid holding particles in suspension of two different densities is forced through a capillary tube, the heavier particles will always pass through the rapidly moving axial current, while the lighter particles will be in a current by the sides of the tube, where the friction is greatest and where motion is therefore slowest.

When the circulation is studied in the vessels of the mesentery of a warm-blooded animal, or where inflammation is produced in the tissues of the web of a frog's foot by mechanical irritation, the corpuscles may frequently be observed to pass through the walls of the vessel in great numbers (diapedesis). At first the colorless cells are found to move more and more slowly; several accumulate and adhere to the wall and ultimately pass out through it, during the act of passing being finely drawn out into slender, protoplasmic threads. It is doubtful whether actual stomata or openings exist between the cells which compose the vascular walls, or whether they simply pass through the cement substance between the endothelial cells.

6. **THE CIRCULATION IN THE VEINS.**—The veins are much less elastic than the arteries, and so do not remain open, even in a dead body, after the blood has been withdrawn; otherwise they resemble the arteries in structure, although the muscular element in them is unequally distributed. The veins are, nevertheless, contractile, although unequally so, and may often be noticed to reduce in diameter when the part is exposed to the cold or to various other irritations. The veins are very dilatable, and are in capacity much greater than that of the arterial system: the veins are, in fact, capable of containing the entire blood of the body.

When a vein is cut the flow from the divided extremity occurs usually from the distal end; that is, the one nearest the capillaries, alone. It is continuous and of comparatively slight velocity. The pressure of the blood within the veins, as determined by connecting a manometer with them, is always much lower than in the arteries, and decreases as the heart is approached, where during inspiration even a negative pressure may be noticed. This is proved by the constant entrance of the lymph, which is itself moved under an extremely low pressure, into the large, venous trunks at the root of the neck. In the sheep the mean pressure in the brachial vein has been found to be four millimeters of mercury; in the crural, eleven and four-tenths millimeters; in the axillary the pressure is usually negative, becoming one millimeter negative during inspiration, and three to five millimeters during strong inspiration, and becoming positive only during forced expiration. No pulse is

to be detected in the veins, except in cases where the small arterioles and capillaries are greatly dilated, as in the case of the secreting glands, and where the arterial pulse may be directly transmitted to the veins. The forces which occasion the movement of the blood in the veins consist in the propulsion of the blood by the heart through the capillaries, *a vis a tergo*; *a vis a fronte*, found in the aspiratory power of the lungs in inspiration and of the heart in diastole, aided by the compression of the venous trunks in the contraction of various muscular masses, by which the blood is forced on toward the heart.

The velocity of movement in the veins is much less than in the arteries, and it is greater in the large veins than in the small, from the reduction in the total capacity of the venous system.

In the dog the velocity of movement has been stated to be about two hundred millimeters per second. The veins are generally furnished with valves arranged in such a manner that when any increase of pressure takes place they become closed and obliterate the lumen of the vessel and prevent the blood from returning to the capillaries. The valves are formed by free folds of the inner endothelial coat arranged in the form of either single, double, or triple cusps. They serve to support the blood-column in the large veins, and here these vessels are furnished with especially thick coats. Where local pressures are not apt to undergo sudden modification, we find that valves are not present; they are, therefore, absent in the veins of the brain and lungs.

The portal vein differs from other venous trunks in that the blood circulating in it passes, not into a larger trunk or directly into the heart, but through a second capillary net-work in the liver. The forces, however, which move the blood in the portal vein are the same as in other veins.

7. THE INFLUENCE OF THE NERVOUS SYSTEM ON THE CIRCULATION.—The quantity of blood supplied to any organ is not a fixed quantity, but is governed by the demands of the organ. To accomplish this, it is, evidently, necessary that the influence which produces and maintains the circulation cannot be a fixed and constant force, but must be capable of modification. The modifications in the organs of circulation may be of two different kinds—modifications in the force and frequency of the heart's pulsation or modifications in the calibre of the peripheral vessels, which latter, evidently, may be either general or local. Both of these variations are dependent upon the influence of the nervous system.

*The Intrinsic Nervous System of the Heart.*—The conditions upon which the action of the heart depends, and the means by which it may be modified, will now be considered. That the heart contains within itself the conditions necessary for its rhythmical movement was known to Galen, but that the main factor of its motor apparatus consists of



small automatic nervous centres situated in the walls of the heart was first pointed out by Remak. These cardiac ganglia are three in number and are of different functions; two are motor ganglia, one an inhibitory ganglion. The motor ganglia are the ganglia of Remak, situated at the opening of the inferior vena cava; the ganglion of Bidder is situated in the left auriculo-ventricular septum. These ganglia are entirely independent of the will, and, under the excitation of the temperature and chemical composition of the blood, communicate to the muscular fibres of the heart their motor impulse. The inhibitory ganglion is that of Ludwig, situated in the inter-auricular septum. The function of this ganglion is to regulate the transmission of motor impulses, produced by the motor ganglia, to the fibres of the heart. It fulfills this end, however, not by acting directly on the muscular structure of the heart, but through the mediation of the motor ganglia; by this means it compels the motor ganglia to dispense the power which they develop during excitation rhythmically and moderately. As regards the manner in which these ganglia produce the rhythmical contraction of the heart, little is known, but that they are the prime factors in producing the rhythm of the cardiac revolutions, with its various modifications, is capable of experimental demonstration.

If the heart be removed from a frog and placed in a watch-glass containing a dilute saline solution, it will be seen that it still continues to pulsate in an exact rhythm and as vigorously as when in its normal condition. Under favorable circumstances it might be kept pulsating for many hours. This is not, however, the case with the frog alone; the heart of almost any cold-blooded animal will beat outside of the body, and a similar observation has even been made on the heart of man. But, to return to the share of the motor ganglia in producing cardiac pulsation: As before stated, one motor ganglion is situated at the opening of the inferior vena cava, and the other in the auriculo-ventricular septum. If the apex of the ventricle be cut off from the base of the heart with a pair of sharp scissors, dividing the ventricle at about its lower third, instantly the apex ceases to pulsate, while the remainder of the heart still goes on contracting as before. The apex has been cut off from its motor ganglia. It may be said that the section of the heart has destroyed the irritability of the muscular fibres of the apex, but if the apex be irritated with a weak induction current it responds; it will again pulsate, to again, however, become quiescent on removal of the irritation. It has, however, been stated by Meruncowicz that the apex fragment will again commence to pulsate if kept supplied with defibrinated blood or artificial serum; so, also, after an hour or more the apex will usually again spontaneously commence to pulsate.

Further, if in a narcotized frog the ventricle is compressed trans-

versely with the blades of a pair of forceps in the line of incision of the former experiment, the apex will cease to pulsate, though still supplied with its normal excitant and nutriment; it has been separated from its motor ganglion. If the apex be irritated it will beat, to again become motionless on removal of the irritation. This condition of affairs will remain for an indefinite length of time, even for as much as three weeks—the apex of the ventricle motionless and gorged with blood and the rest of the heart contracting normally. If, however, the intra-cardiac pressure be increased by clamping the aorta, the apex will commence to beat, but independently of the rest of the heart and at a slower rate. This being so, if we can be positive that there are no ganglia present in the apex, it must be concluded that the heart-muscle may contract independently of any nervous mechanism. It must not be forgotten, however, that it has not been definitely proved that there are no ganglia in the apex, only they have never been found. The position then is this:—

A fragment of cardiac muscle containing a motor ganglion will pulsate when removed from the body, and without any artificial stimulus. A fragment of muscular fibre unconnected with a motor ganglion will remain quiescent until it receives some external stimulus. By cutting a heart in halves it will be seen that one part pulsates while the other does not. If this subdivision be carried still further, gradually cutting the heart into fragments until they become microscopic in size, and some of them be placed under the microscope, it will be seen that some fragments are rhythmically contracting and others are motionless; if the subdivision be carried still further, until the ultimate fibres of the heart are isolated, in nearly all the contracting fibres will be found ganglionic nerve-cells, while none are to be found in those which are motionless.

The action of the inhibitory ganglion may be seen by exposing the heart of a frog in the usual way, and distending the œsophagus with a short glass rod in order to bring the parts exposed into more prominent view.

The apex of the ventricle should be seized with a pair of forceps and drawn forward and to the right, after dividing the little connecting band between the posterior surface of the ventricle and the pericardium. With the aid of a delicate aneurism needle, a silk ligature is to be passed between the vena cava inferior and the ventricle and between the vena cava superior and the right auricle in such a position that when tightened it will grasp the line of junction, which is marked by a slight groove, of the sinus venosus and right auricle. After seeing that the heart is pulsating rhythmically, the ligature should be suddenly tightened, and it will be found that after a few beats the heart will stop in diastole, while the sinus will continue to pulsate as before. After a few moments

the ventricle will again pulsate, but its rhythm will be no longer synchronous with that of the sinus.

In another frog, prepared in the same manner, the heart may be separated from the sinus venosus with a pair of scissors, following the line of the ligature in the preceding experiment, and the result will be the same. Cut off the ventricle, including the auriculo-ventricular groove, from the auricle before it starts spontaneously to pulsate, the ventricle immediately begins to beat; the same result might have been obtained after ligature as in the first experiment.

Or, if this line be irritated with an induction current, taking care to include the sinus in the current, the same result will follow. But in a frog in which  $\frac{1}{1000}$  of a grain of atropine has been injected irritation with the electric current will have no effect; while if the first experiment is repeated, by ligating this line, the heart will stop as before.

What inference can be drawn from these experiments? It has been stated that the ganglion of Remak, a motor ganglion, is situated at the opening of the inferior vena cava, that is, in the sinus venosus; also that the inhibitory ganglion of Ludwig is in the interauricular septum, and the motor ganglion of Bidder in the left auriculo-ventricular septum. We may assume that Remak's ganglion is an automatic motor centre, *i.e.*, "a ganglionic centre in which energy tends to accumulate and discharge itself in the form of motion at regular intervals, the length of which varies with the resistance to the discharge and with the rapidity of the accumulation," the physiological grounds for this assumption being as follows: The succession of acts which make up a cardiac revolution distinctly start in the sinus; this is the only portion of the heart that contracts independently, and electric excitation of this centre induces increased frequency of contraction of the whole organ. By separating the heart from the sinus venosus, either by ligature or by amputation with the scissors, we not only remove the heart from its main motor centre, but also irritate the inhibitory centre, and so cause arrest of the pulsation of the heart, while the sinus containing the motor centre goes on contracting as before. After a few minutes, however, the inhibitory effect induced through irritation passes off, and then the motor ganglion at the base of the ventricle starts the heart again. So, when, without waiting for the inhibition to pass off, we remove the ventricle from the auricles, the motor ventricular ganglion is released from its inhibition and starts the heart again. The effect is somewhat different, however, when we irritate this line with electricity; then the stoppage is due alone to the inhibitory action of the ganglion, and when this passes off the heart pulsates. So, when this inhibitory ganglion is paralyzed with atropine, electric irritation is powerless to stop the heart, while ligature by removal of the heart from its main motor centre prevents pulsation.

From these experiments it has been found that a heart will contract rhythmically outside of the body, that this function is probably due to

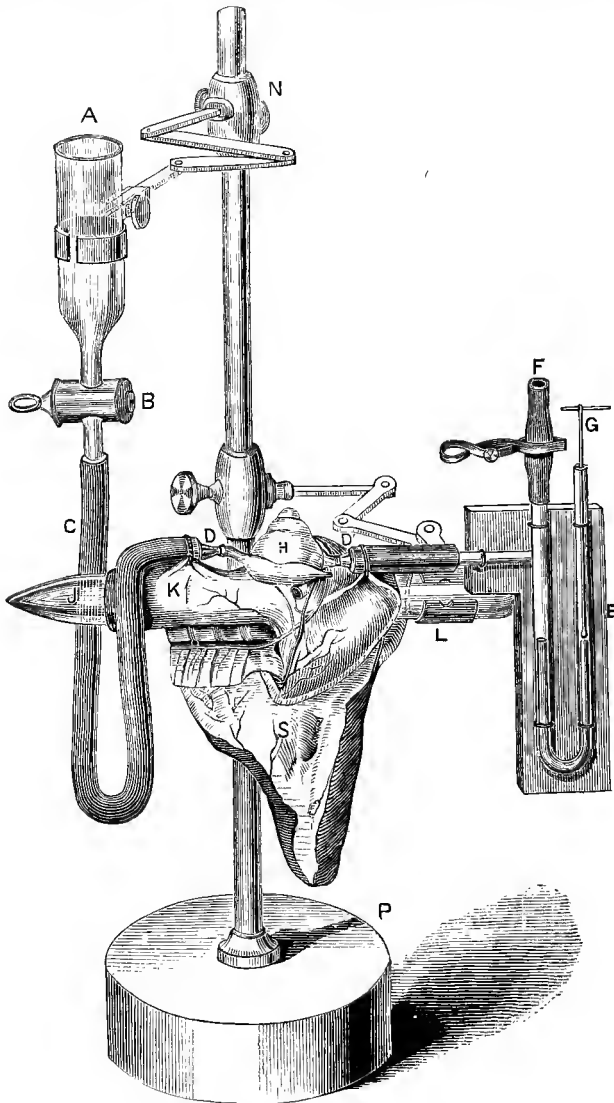

FIG. 226.—SIMPLEST FORM OF MANOMETER FOR FROG'S HEART. (Sanderson.)

(For description, see text.)

the presence of motor ganglia, and that the heart may be slowed or stopped either through inhibition from irritation of the inhibitory

ganglion or removal of the heart from the influence of the main motor ganglion.

To carry this subject still further, a more delicate means of experimentation must be used. Poisons must be employed as instruments of investigation. Pharmacology has indeed in this line almost run ahead of physiology, for it has been through the study of the action of poisons on the heart that our complete ideas of cardiac physiology have been derived.

Fig. 226 represents an apparatus devised by Dr. Coats, of Glasgow, and Professor Ludwig, of Leipsic. It consists of a reservoir, A, with a stop-cock, B, containing fresh serum; a rubber tube, C, leading from this, and a cannula, D, which is to be inserted into the vena cava inferior; another cannula, D', to be inserted in the aorta, connected by tubing with a mercurial manometer, E, *i.e.*, a fine U-shaped tube partly filled with mercury, and supporting on one limb of the column a piston with a long, delicate wire rod, G, above it.

The brain and spinal cord of a frog should be destroyed by introducing a needle into the cerebro-spinal canal, the heart freely exposed, and one of the pneumogastric nerves carefully dissected out. To find the vagus nerve, follow up the diverging aortæ to where they cross the cartilaginous tips of the posterior horns of the hyoid bone: from each of these tips the petro-hyoid muscles are seen passing upward and backward toward the occipital region. The lower border of these nearly parallel fibres is the guide to the vagus, which is found lying beneath its inner edge. Following these muscles back from their insertion in the hyoid bone to their origin in the petrous bone, they are seen to be crossed first by the hypoglossal nerve, ascending inward to the muscles of the tongue. Nearer the middle line and following the same course as the hypoglossal is seen the glosso-pharyngeal, and crossing over the top of the inferior horn of the hyoid bone is the laryngeal nerve (Fig. 227).

Place a thread loosely around the nerve, so that it can be easily found when required. The next step is to insert the cannula, D, into the inferior vena cava, and secure it with a thread; the cannula, D', is then inserted into one aorta, the other being ligated. All the other organs may be removed, leaving only the thorax, heart, and a large fragment of skin, S, to cover the heart and nerve, to prevent drying. The œsophagus is now distended with a large glass rod, firmly clamped to an upright stand. The next step is to connect the vena cava by means of its cannula with the reservoir containing serum. Open the stop-cock for a moment, and allow the serum to pass through the heart and apex of the arterial cannula, to wash out all the blood from the heart. The arterial cannula is then connected with the manometer, and the serum allowed to flow through the heart into the manometer until the air in the proximal is entirely expelled through at F. Then the apparatus is ready for use. The heart should be filled so full that a little tension exists, even during the diastole. It will be noticed that at each

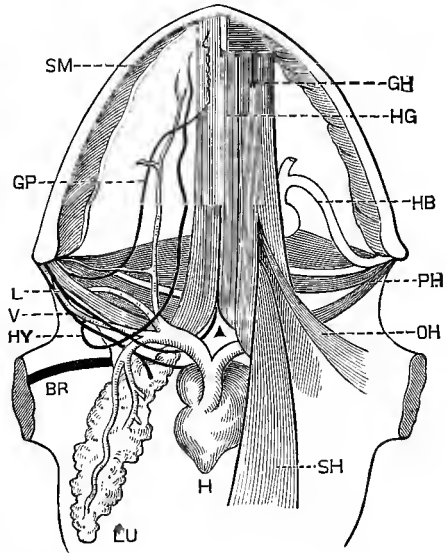

FIG. 227.—DIAGRAM OF THE COURSE OF THE VAGUS NERVE IN THE FROG. (*Stirling.*)

H, heart; LU, lung; BR, brachial plexus; HY, hypoglossal nerve; V, vagus; L, laryngeal nerve; GP, glosso-pharyngeal nerve; SM, submental muscle; GH, genio-hyoid muscle; HG, hypoglossal muscle; HB, hyoid bone; PH, petro-hyoid muscle; OH, omo-hyoid muscle; SH, sterno-hyoid muscle.

pulsation of the heart the column of mercury sinks in one arm of the manometer, while it rises a corresponding distance in the other, carrying with it the piston, which by means of its pen traces a line composed of a succession of curves on the smoked surface of the revolving drum. The ascending limb of each curve corresponds to the systole of the ventricle, and the descending curve to its diastole (Fig. 228). By irritating the vagus with a weak induction current the heart stops in diastole, a result similar to that obtained in the previous experiment when the line of junction of the auricle and sinus venosus was irritated. This identical result, however, has not been produced by the same mechanism, as may



FIG. 228.—PULSE TRACING OF THE FROG'S HEART. (Sanderson.)

be seen if to the serum in the reservoir a few drops of dilute solution of nicotine be added; if the vagus now be irritated, no arrest of the heart occurs. The vagus has been paralyzed by nicotine; it no longer is able to restrain the heart, which beats faster than before. (When the nicotine is first given the heart is slowed, and then quickened, the slowing being due to the first effects of the nicotine on the vagus, irritating it before it paralyzes it.)

It would seem that nicotine and atropine have the same action. But it will be remembered that after atropine poisoning it is impossible to stop the heart through electric irritation of the sinus venosus.

But if the sinus venosus be irritated in the heart which has received the nicotine, it will stop. Therefore, nicotine and atropine must act on different inhibitory organisms.

If in a frog which has been placed under the influence of nicotine the heart be removed and placed on a watch-glass, it will pulsate regularly. If a drop of saline solution containing a little of the alkaloid muscarine be placed on the heart, it ceases to beat entirely, and will remain motionless. But if while at rest a drop of a solution of atropine be placed in the heart, it will commence to beat again.

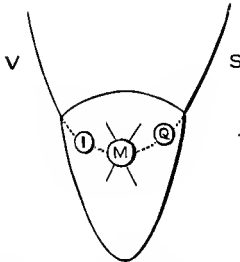

FIG. 229.—DIAGRAM OF THE HYPOTHETICAL NERVOUS APPARATUS OF THE HEART. (Lauder-Brunton.)

M, motor ganglion; I, inhibitory ganglion; Q, accelerator ganglion; V, inhibitory extra-cardiac nerves; S, accelerator extra-cardiac nerves. The intermediate apparatus of Schmiedeberg is represented by the dotted lines.

If in two fresh frogs a drop of muscarine solution be placed on the hearts, immediately they begin to beat more and more slowly, and at last stop in diastole. If into one frog nicotine be injected no effect will be observed; the heart still remains motionless in diastole; but the injection of atropine into the other frog whose heart was stopped by muscarine will cause it to commence to beat, and it will pulsate as strongly and rhythmically as before the operation. If, however, the atropine be injected first, and then the muscarine be applied, the heart will not be stopped.

It has now been stated that both nicotine and atropine render the heart insusceptible to irritation of the vagus, but that irritation of the sinus venosus will stop the heart in nicotine poisoning, but not in atropine poisoning. Therefore some part of the cardiac inhibitory apparatus escapes in nicotine poisoning which is paralyzed by atropine.

In the above diagrammatic sketch of the arrangement of the cardiac ganglionic apparatus, proposed by Schmiedeberg (Fig. 229, M), is the main motor ganglion acting on the muscular fibres of the heart by means of radiating fibres. It is regulated by an intermediate apparatus represented by the dotted lines, on the one side by the inhibitory ganglion, I, connected again with an intermediate apparatus with the vagus nerve, and on the other side by the accelerator ganglion, Q, connected in the same manner with the accelerator nerves. According to this arrangement, nicotine is supposed to paralyze the fibres intermediate between the inhibitory ganglion and the vagus nerve, while atropine paralyzes this portion,

the inhibitory ganglion and the apparatus intermediate between the ganglion, I, and the motor ganglion. On the other hand, muscarine slows the heart or stops it in diastole, similar to irritation of the vagus, while its effects are not interfered with by either the previous or subsequent injection of nicotine: therefore, muscarine must act on some apparatus more central than that affected by nicotine, and as the effects are gradually developed, it is supposed to act by irritating the ganglion, I. Again, we have seen that muscarine will have no effect after the injection of atropine, and that atropine will cause a heart stopped by muscarine to recommence beating; therefore, atropine acts on a more central apparatus than muscarine: in other words, on the apparatus intermediate between I and M. The effects of atropine may be removed by physostigma and is antagonistic to nicotine. These points are valuable in determining the antidotal effects of poisons.

The action of the accelerator apparatus has not been so thoroughly well worked up, but the action of poisons, as of veratrine, renders it necessary to assume a similar arrangement.

There is one more point in the action of these cardiac ganglia; that is, the influence of heat and cold on the heart.

The simplest method of studying the action of heat on the cardiac pulse is that of Lauder-Brunton (Fig. 230). His arrangement consists of a plate of glass about three inches by four inches, at one end of which a cork is cemented projecting about half an inch beyond the edge

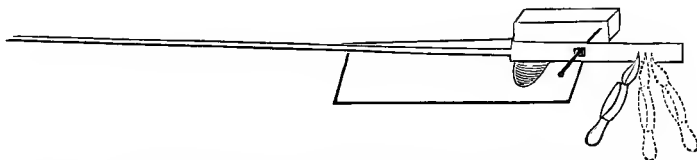

FIG. 230.—LAUDER-BRUNTON'S ARRANGEMENT FOR STUDYING THE EFFECT OF HEAT AND COLD ON THE HEART OF THE FROG.

of the glass plate. To this is fastened a long, light lever freely moving on a pivot, and projecting about one and one-half inches beyond one end of the plate and about four inches beyond the other end; the lever is counterpoised by fastening a small pair of forceps on the short end of the lever; by altering the angle of the forceps, the lever can be balanced to a nicety. A frog's heart may be placed on the plate close up to the pivot and lying so that the lever is lifted at each pulsation of the ventricle, the lever being balanced so as to make slight pressure by altering the position of the pair of forceps. If the glass plate is placed on some pounded ice the heart will beat gradually more and more slowly, until at length it will come to rest in diastole, thus indicating irritation of some portion of the inhibitory apparatus. If the plate be removed from the ice, the heart will commence again, and by gradually heating it over a spirit-lamp the heart will pulsate faster and faster, the extent of the contractions increasing up to  $20^{\circ}$  C., until at length it will stand at rest in what is called "heat-tetanus;" if, however, the temperature is lowered the heart will again commence to beat, but if the temperature is raised

still higher than before when the heart stopped from heat, the condition of heat-tetanus will pass into that of "heat-rigor," and no application of cold will have the slightest effect toward again starting the heart.

The influence of heat and cold on the amount of work done by the heart is an extremely complicated subject. We can only state here that within certain limits the mechanical work done by the heart increases with an increase of temperature, but that very soon the contractions increase in number in much greater proportion than the mechanical effect; hence, though the amount of work done at a comparatively high temperature is greater than can be accomplished at a low temperature, the effect of each individual contraction is much less.

The frequency of the normal rate of contraction of the heart varies greatly in different animals, as shown in the following table compiled by Colin:—

*Frequency of the Pulse per Minute.*

In the elephant, . . . . .	25 to 28
“ camel, . . . . .	28 to 32
“ giraffe, . . . . .	66
“ horse, . . . . .	36 to 40
“ ox, . . . . .	45 to 50
“ mule, . . . . .	46 to 50
“ tapir, . . . . .	44
“ ass, . . . . .	46 to 50
“ pig, . . . . .	70 to 80
“ lion, . . . . .	40
“ lioness, . . . . .	68
“ tiger, . . . . .	64
“ sheep, . . . . .	70 to 80
“ goat, . . . . .	70 to 80
“ leopard, . . . . .	60
“ female wolf, . . . . .	96
“ hyena, . . . . .	55
“ dog, . . . . .	90 to 100
“ cat, . . . . .	120 to 140
“ rabbit, . . . . .	120 to 150
“ marmot, . . . . .	90 to 175
“ mouse, . . . . .	120
“ goose, . . . . .	110
“ chicken, . . . . .	140
“ pigeon, . . . . .	136 to 138
“ snake, . . . . .	24
“ earp, . . . . .	20
“ frog, . . . . .	80
“ salamander, . . . . .	77

The following table shows the variation and frequency of the pulse per minute in the horse and ox at different ages:—

<i>Horse.</i>	<i>Ox.</i>		
Newborn, . . . . .	100-120	Newborn, . . . . .	92-132
Fourteen days old, . . . . .	80- 96	Fourteen days old, . . . . .	68
One-fourth year old, . . . . .	68- 76	One-fourth year old, . . . . .	.. ..
One-half year old, . . . . .	64- 72	One-half year old, . . . . .	50- 68
One year old, . . . . .	48- 56	One year old, . . . . .	50- 68
Two to three years, . . . . .	40- 48	Young cow, . . . . .	64
Four years of age, . . . . .	38- 50	Four-year-old ox, . . . . .	56
Aged, . . . . .	32- 40	Aged, . . . . .	45- 50



The frequency of the pulse in man and animals depends upon the age, sex, state of nutrition, size, and various other conditions.

In man the normal rate of the pulsations of the heart is about 72 per minute; in the female, about 80, though great variations may be met with in perfectly normal individuals. Up to fifty years of age the rate of the pulse is in inverse ratio to the age, as is shown in the following table:—

		<i>Beats per Minute.</i>	
Newly born infant,	130-140	Ten to fifteen years, . . .	78
One year, . . . .	120-130	Fifteen to twenty, . . .	70
Two years, . . . .	105	Twenty to twenty-five, .	70
Three " . . . .	100	Twenty-five to fifty, . .	70
Four " . . . .	97	Sixty, . . . . .	74
Five " . . . .	90-94	Eighty, . . . . .	79
Ten " . . . .	about 90	Eighty to ninety, . . .	over 80

The pulse-rate is increased by muscular exercise in creating a greater demand for arterial blood, by increasing blood pressure, by increased temperature (fever), in digestion, by various mental disturbances, and in extreme debility. It is more frequent in the erect than in the recumbent position, and varies inversely with the barometric pressure.

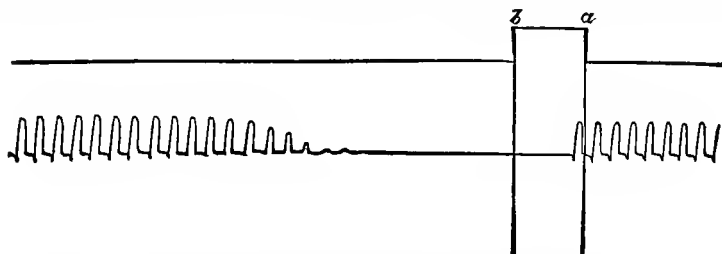

FIG. 231.—TRACING OBTAINED FROM THE FROG'S HEART ON STIMULATION OF THE PNEUMOGASTRIC NERVE. (*Foster.*)

The current entered the nerve at *a*, and was shut off at *b*. The latent period is indicated by the fact that one pulsation occurred after the stimulation entered the nerve. It is further evident that the inhibition persisted some time after the stimulation ceased.

In addition to the intrinsic nervous system of the heart, the pulsations of this organ are also governed by impulses coming from the central nervous system. These are of two different kinds,—inhibitory and accelerating.

*The Inhibitory Nerves of the Heart.*—It was discovered in 1848 that stimulation of the pneumogastric nerve or of its divided peripheral extremity had the effect, in the dog, of retarding the pulsations of the heart, and, when the stimulation was sufficiently strong, of entirely arresting the heart in diastole. This effect is not produced immediately on the application of the electric current to the nerve, but is preceded by a latent period amounting to about one-tenth of a second; so, also, the effect lasts a certain time after the shutting off of the current, if the application has not been too prolonged (Fig. 231). On the other

hand, if the current is very strong, the heart may be completely arrested and yet start again during the passage of the current. With weak currents no actual arrest of the heart takes place, but the pauses between the beats are prolonged during the earlier part of the application of the current, and the pulse is thus rendered slow. If the pneumogastric be stimulated in a dog during a blood-pressure experiment some such curve as represented in the diagram will be produced (Fig. 232).

The blood pressure is seen to undergo a rapid fall shortly after the application of the current, from the fact that on the cessation of the pulsation of the heart the arteries, through their contractility, empty themselves into the venous system. As the heart again commences to pulsate it throws its contents into the arterial system, which has been already largely depleted of blood, and, as a consequence, the walls of the arteries are rapidly stretched, and we have a correspondingly rapid

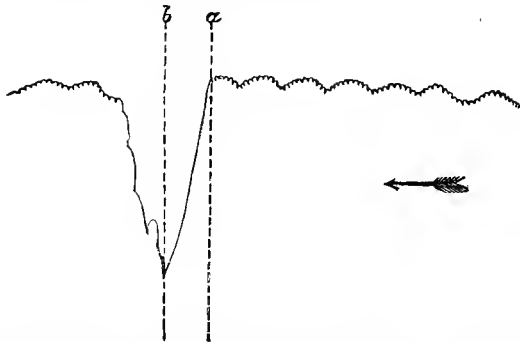

FIG. 232.—MANOMETER TRACING FROM THE CAROTID OF A RABBIT ON STIMULATION OF THE PNEUMOGASTRIC NERVE. (Foster.)

The current entered the nerve at *a* and was shut off at *b*.

increase in pressure, and therefore a rapid rise in the mercury in the manometer. When the heart is only slowed by stimulation of the pneumogastric, and not completely arrested, the mercury in the manometer undergoes extensive oscillations, partly due to inertia, which exaggerates these movements, and partly due to the same cause already mentioned. In other words, between the pulsations of the heart, which succeed each other slowly, the arterial system has time to partially empty itself into the veins.

Inhibition of the heart may not only be produced by direct stimulation of the pneumogastric, but also may be produced reflexly. If one pneumogastric nerve be divided, and the central end, in connection with the brain, be stimulated with the induction current, the heart will be arrested or slowed as before. If the abdomen of a frog be opened, and the intestine struck sharply, as with the handle of a scalpel, the heart

will be likewise arrested in diastole. If the mesenteric nerve be stimulated by an induction current the heart will also be brought to a sudden standstill. If both pneumogastric nerves be divided, the anterior roots of both spinal accessory nerves be torn out, or the medulla oblongata destroyed, the preceding experiments will all fail. This indicates that in the first case the impulse was conducted through the central stump of the divided pneumogastric to the brain, and there, from a collection of nerve-cells in the medulla oblongata, which is termed the cardio-inhibitory centre, is transmitted through the spinal accessory nerve to the pneumogastric plexus, and through the undivided vagus to the heart. If the spinal accessory nerve be pulled out by the roots, the cardio-inhibitory fibres of the pneumogastric undergo degeneration, and four or five days after the operation stimulation of the vagus fails to slow the heart. In the other instance, where irritation of the intestinal surface or mesenteric nerves produces inhibition, the impulse is conducted through the mesenteric and sympathetic chain to the spinal cord, from there to the cardio-inhibitory centre, and from there to the heart. It is probable that the syncope occasionally produced by severe pain, emotions, or sometimes from drinking ice-water when overheated is produced in the same manner, the heart being arrested or slowed through reflex inhibition.

It is thus observed that the pneumogastric nerve possesses a function directly opposed to that of most other nerves. When a motor nerve is stimulated it produces contraction of the muscles to which it is distributed. Stimulation of the pneumogastric, on the other hand, produces relaxation of the heart-muscle. The manner by which this effect is produced is in all probability through the inhibition of the motor ganglia of the heart.

The cardio-inhibitory centre in the medulla is in constant action, through reflex stimuli conducted to it through the abdominal and cervical sympathetic, and might be compared to the action of a brake on a moving machine. When both pneumogastric nerves are divided, the heart in the dog, and to a less extent in the rabbit, beats very much faster, so that this inhibitory centre is constantly restraining the action of the motor ganglia. The cardio-inhibitory centre may be *directly* stimulated by sudden anæmia of the medulla, as by sudden ligation of both carotids; by sudden venous hyperæmia, as by ligation of all the veins of the neck; or by increased vensity of the blood, as by dyspnœa or causing an animal to inhale  $\text{CO}_2$ . It may also be reflexly stimulated, as already indicated.

*The Accelerator Nerves of the Heart.*—The action of the heart may not only be retarded or arrested through the stimulation of the pneumogastric, but in the mammal, even after division of both pneumo-

gastriacs, it may be accelerated by stimulation of the cervical sympathetic, stimulation of the cervical spinal cord, or in a more marked degree by stimulation of the communicating filaments between the spinal cord and the inferior cervical and the first dorsal ganglia of the sympathetic. These latter fibres are described as the accelerator nerves of the heart, and when stimulated produce an increase in the rate of the heart's pulse, but with a decreased force, the loss in power being, however, compensated by the increase in rapidity. As a consequence, after stimulation of these

nerves the blood pressure remains unchanged. The course of these nerves is different in the rabbit and the dog.

The diagrams (Figs. 233 and 234) indicate their most usual course.

These accelerator fibres originate from centres in the medulla oblongata and spinal cord, though their exact location has not been determined. It is by means of stimulation of these fibres, therefore, that stimulation of either the cervical spinal cord or cervical sympathetic produces increase in the rate of the heart's pulsation. When the cervical spinal cord is stimulated a great increase in blood pressure follows from stimulation of vaso-motor nerves, but that the increased rate of the heart's contractions is not due to the high blood pressure alone is proved by the occurrence of acceleration of the pulse when the cervical cord is stimulated, even after section of the splanchnic nerves, when increased blood pressure is prevented. These nerves are not in constant activity; in other words, they do not antagonize the pneumogastriacs, and when divided the heart does not beat slower. A long latent period also characterizes these

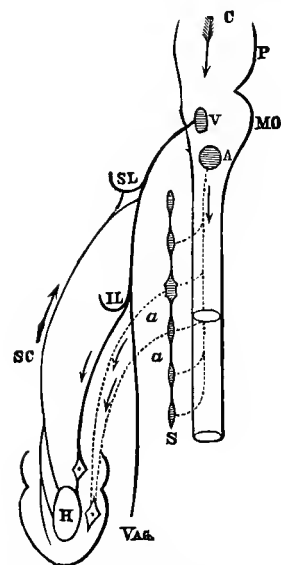

FIG. 233. — SCHEME OF THE COURSE OF THE CARDIAC ACCELERATOR FIBRES. (Landois.)

P, pons; MO, medulla oblongata; V, inhibitory centre for heart; A, accelerator centre; VAG, vagus; SL, superior, IL inferior laryngeal nerves; SC, superior cardiac fibres; H, heart; C, cerebral impulse; S, cervical sympathetic; a, a, accelerator fibres.

nerves, and it takes considerable time, as much as ten seconds, from the commencement of stimulation before the maximum acceleration of the heart is reached; while, again, it is only slowly and gradually that the normal heart-rate is regained even at the cessation of stimulation.

8. THE INFLUENCE OF THE NERVOUS SYSTEM ON THE ARTERIES.—Anatomical examination of the walls of the minute arteries shows that these vessels are not only supplied with circular muscular fibres, but are also supplied with nerve-fibres which come both from the sympathetic and cerebro-spinal nervous system, and numerous ganglia have also been

detected. Anatomical data, therefore, support the view—which would otherwise be rendered probable, as, for example, in the production of blushing from emotions—that the calibre of the minute arterioles is under the control of the central nervous system. Numerous experiments still further demonstrate the truth of this statement. When the web of a frog's foot is examined under the microscope it will be found that the smaller arterioles are constantly varying in calibre, sometimes being so contracted—evidently due to the contraction of their muscular fibres—as to almost shut off blood from the part supplied by the contracted

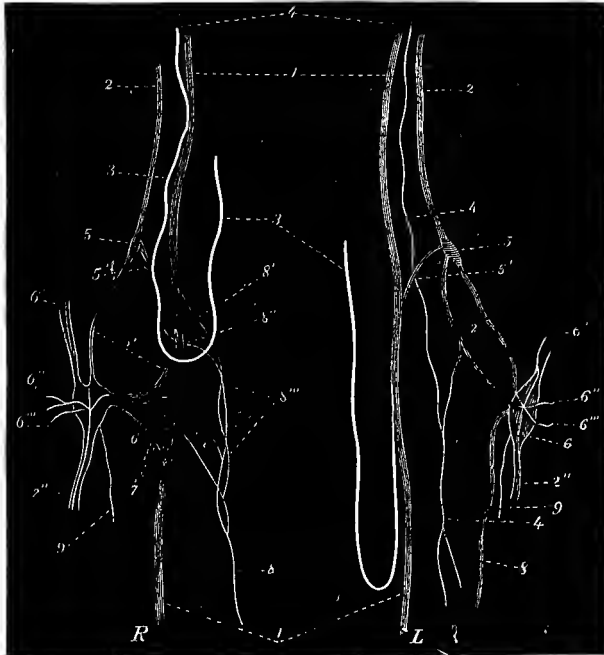

FIG. 234.—CARDIAC PLEXUS AND STELLATE GANGLION OF THE CAT. (*Landois.*)

R, right; L, left;  $\times 1\frac{1}{2}$ . 1, vagus; 2', cervical sympathetic; and in the annulus of Vieussens; 2, communicating branches from the middle cervical ganglion and the stellate ganglion; 2'', thoracic sympathetic; 3, recurrent laryngeal; 4, depressor nerve; 5, middle cervical ganglion; 5', communication between 5 and the vagus; 6, stellate (first thoracic) ganglion; 7, communicating branches with the vagus; 8, accelerator nerve; 8, 8', 8'', roots of the accelerator nerve; 9, branch of the stellate ganglion.

vessel, at other times so dilated as to cause the tissues supplied by the vessel to become gorged with arterial blood. If the web of the frog's foot be examined and an arteriole picked out which appears to be midway between the states of extreme relaxation and extreme dilatation, and a weak induction current be then applied to the sciatic nerve, the arterioles will all, as a rule, be found to become immediately contracted. If the effects of stimulation be allowed to pass off, and then, instead of stimulating the sciatic, this nerve be divided, directly opposite results will

ensue. The arterioles will now all dilate, and, as a consequence, the parts will become filled with blood.

Similar effects may be seen in warm-blooded animals. If the sympathetic nerve be divided in the neck of a rabbit, it will be found that the vessels in the lobe of the ear on that side will have greatly increased in calibre, will appear not only larger, but numerous vessels which before were invisible will now be readily seen. The entire tissue of the ear will be much redder than before, much warmer in temperature, and distinct throbbing of the pulse may be readily perceived. Here division of the sympathetic has produced dilatation of the auricular arterioles. If, on the other hand, the cervical sympathetic be stimulated with an induction current in the rabbit, directly opposite results will be produced. The auricular vessels will now all contract, and the tissues of the ear will become pale and free from blood.

So, also, if the sciatic nerve be divided in a mammal, a corresponding dilatation occurs in the small arterioles of the foot and leg, and may be readily determined through inspection of the balls of the toes, especially as seen in the cat, where they are hairless and not pigmented. So, also, the temperature of the foot on the side on which division of the sciatic nerve has been performed will be considerably elevated. Further, if the splanchnic nerves be divided, the vessels of the abdomen all undergo extensive dilatation. If the lingual nerve be divided, the vessels on the corresponding side of the tongue dilate, while in all cases in which a nerve supplying a muscle is cut a great increase in the flow of blood from the muscle may be made out. It is, therefore, evident that the blood-vessels of certain parts of the body are kept in a state of tonic contraction through impulses traveling along certain nerves. Section of these nerves has been found to produce dilatation in the corresponding vascular areas: therefore it is evident that the arteries before the division of their vascular nerves were in a state of constriction through contraction of their muscular fibres, and that this state of contraction was due to impulses coming along the vascular nerves or vaso-motor nerves of that part. Section of these nerves, therefore, produces paralysis of the muscular fibres, and the muscular tissue is no longer able to resist the pressure of the blood, and, as a consequence, these vessels passively dilate.

It has been found that the vascular condition of the specific parts of the body are governed by impulses coming along specific nerves, and that these nerves may be either of the sympathetic or cerebro-spinal systems. If the spinal cord is divided in the lumbar region it will be found that the blood-vessels of all the parts below will be paralyzed and gorged with blood. If the spinal cord, or even the lateral columns alone, be divided in the cervical region, the blood-vessels of the entire body

will become dilated. This, therefore, indicates that some portion of the brain higher up than the cervical spinal cord is the centre from which originate all the impulses which travel along the different vaso-motor nerves to innervate the muscular fibres of the different arterioles of the body. When the path of communication between any vascular area and the medulla oblongata is broken, the vessels of that part are deprived of the nervous impulse coming from the medulla, they lose tone, their muscular fibres relax, and their arteries dilate. When the entire body is cut off from the medulla all the vessels, therefore, dilate. It has been stated that stimulation of one of the vaso-motor nerves—such an example being the sympathetic, the sciatic, or splanchnic—leads to contraction of the arterioles in the corresponding vascular area. In other words, the electric stimulation has been added to that coming constantly from the medulla, and has therefore increased the contraction of the muscular fibres of the arteries. So, also, if the spinal cord be itself stimulated, the blood-vessels in all the parts below become still further contracted, while by directly stimulating the medulla oblongata all the blood-vessels of the body contract. These facts indicate that the normal degree of constriction of the arterioles of the body, or what is termed vascular tonus, is maintained by a series of impulses constantly coming from a collection of cells in the medulla oblongata, called the vaso-motor centre. These impulses reach the arteries after passing through the lateral columns of the cord, during which passage they make connection with the subordinate vaso-motor centres of the cord, either through the anterior spinal roots directly or by passing through the rami communicantes to the sympathetic.

The vaso-motor centre has been located in the floor of the fourth ventricle, its lower limit being a horizontal line about four or five millimeters above the point of the calamus scriptorius and the upper limit about four millimeters higher up, or one or two millimeters below the corpora quadrigemina. The vaso-motor centre, as already stated, may be directly stimulated, and so lead to increased vascular contraction throughout the entire body. Increased venosity of the blood and various poisons, such as strychnine, likewise directly stimulate the vaso-motor centre, and so cause increased blood pressure; so, after death, the venous character of the blood, through stimulation of the vaso-motor centre, leads to firm contraction of the arteries and a consequent emptying of these vessels into the veins. It may also be reflexly stimulated. Irritation of any sensory nerve will reflexly act on the vaso-motor centre and lead to arterial contraction, especially of the vessels of the abdomen. On the other hand, the vaso-motor centre may be inhibited.

If the small nervous filament which is formed in the rabbit by the union of branches from the pneumogastric and superior laryngeal nerves

be stimulated, it will be found that the blood pressure will steadily fall until it may be not more than one-third of the normal height (Fig. 235). During the production of this decrease of blood pressure no change occurs in the rate of pulsation of the heart. It must be, therefore, due to the diminution of the resistance in the peripheral vascular system. If the splanchnic nerves be divided previous to this experiment, no subsequent decrease in pressure will take place. The conclusion from this is evident. When this nerve, which has been termed the "depressor of Ludwig and Cyon" (the superior cardiac branch of the vagus), is stimulated the impulses pass to the vaso-motor centre in the medulla, and there so alter the impulses coming from it that it is unable to maintain the normal degree of contraction of the abdominal vessels, through the failure of the influence which it normally exerts on these vessels through the splanchnic nerves. The abdominal vessels, consequently, dilate and

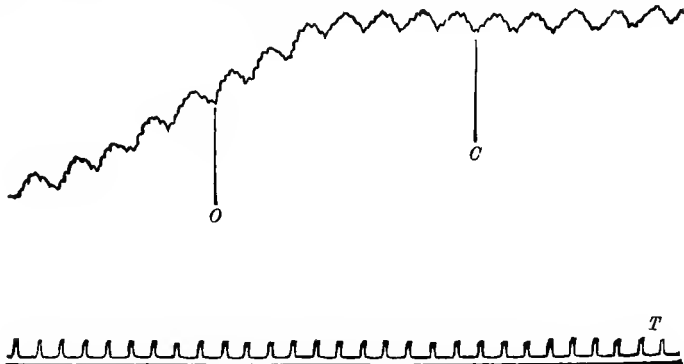

FIG. 235.—BLOOD-PRESSURE TRACING OBTAINED BY STIMULATING THE DEPRESSOR NERVE IN A RABBIT. (Foster.)

The current entered the nerve at *C* and was shut off at *O*. The intervals on the line *T* represent seconds.

draw off so much blood from the general arterial system that the blood pressure may be reduced two-thirds or more. On the other hand, if in an animal placed under curare the central end of the divided sciatic nerve be stimulated, directly opposite effects will be produced. Without any change in the heart's rate of pulsation the pressure will gradually rise until it may be one-third higher than before the experiment: here, again, the increased pressure being, evidently, due to constriction of the local arterioles, for previous division of the splanchnic nerves will largely interfere with the production of an increased blood pressure. These variations in blood pressure are of the greatest importance in governing the general character of the circulation.

The effects of local and general variations in vascular tone have been admirably formulated by Foster:—

Let us suppose that any artery, *A*, is in a condition of normal tone—



is midway between extreme constriction and dilation. The flow through *A* is determined by the resistance in *A* and in the vascular tract which it supplies, in relation to the mean arterial pressure, which again is dependent on the way in which the heart is beating and on the peripheral resistance of all the small arteries and capillaries, *A* included. If, while the heart and the rest of the arteries remain unchanged, *A* be constricted, the peripheral resistance in *A* will increase, and this increase of resistance will lead to an increase of the general arterial pressure. This increase of pressure will tend to cause the blood in the body at large to flow more rapidly from the arteries into the veins. The constriction of *A*, however, will prevent any increase of the flow through it—in fact, will make the flow through it less than before. Hence, the whole increase of the discharge from the arterial into the venous system must take place through channels other than *A*. Thus, as the result of the constriction of any artery there occur (1) diminished flow through the artery itself, (2) increased general arterial pressure, leading to (3) increased flow through the other arteries. If, on the other hand, *A* be dilated, while the heart and other arteries remain unchanged, the peripheral resistance in *A* is diminished. This leads to a lowering of the general arterial pressure, which, in turn, causes the blood to flow less rapidly from the arteries into the veins. The dilation of *A*, however, permits, even with the lowered pressure, more blood to pass through it than before. Hence, the diminished flow tells all the more on the rest of the arteries. Thus, as the result of the dilation of any artery, there occur (1) increased flow of blood through the artery itself, (2) diminished general pressure, and (3) diminished flow through the other arteries. Where the artery thus constricted or dilated is small, the local effect, the diminution or increase of flow through itself, is much more marked than the general effects, the change in blood pressure and the flow through other arteries. When, however, the area the arteries of which are affected is large, the general effects are very striking. Thus, if while a tracing of the blood pressure is being taken by means of a manometer connected with the carotid artery the splanchnic nerve be divided, a conspicuous but steady fall of pressure is observed very similar to that which is seen in Fig. 235. The section of the splanchnic nerves causes the mesenteric and other abdominal arteries to dilate, and these being very numerous a large amount of peripheral resistance is taken away, and the blood pressure falls accordingly; a large increase of flow into the portal veins takes place, and the supply of blood to the face, arms, and legs is proportionally diminished. It will be observed that the dilation of the arteries is not instantaneous, but somewhat gradual, the pressure sinking, not abruptly, but with a gentle curve.

Arterial tone, then, both general and local, is a powerful instrument

for determining the flow of blood to the various organs and tissues of the body, and thus becomes a means of indirectly influencing their functional activity.

In certain instances stimulation of spinal nerves will not only produce contraction of the arterioles of different parts of the body through reflex stimulation of the vaso-motor centre, but will also produce dilatation of the arterioles in the vascular area supplied by that nerve; thus, for example, if in a rabbit under the influence of curare the central stump of the great auricular nerve be stimulated with an induction current, the blood pressure will be increased through constriction of the general vascular areas, while inspection of the ear will show that its vessels have become largely dilated. So, also, as already described under the section on Digestion, when the chorda tympani nerve is stimulated, we not only have increased secretion of saliva, but we have, also, an increase of the supply of blood to the glands. Such nerves as the chorda tympani and the great auricular, with numerous others, are spoken of as vaso-dilator nerves, from the fact that their stimulation leads not to contraction of arterioles, but to an increase in their calibre; they, therefore, are of opposite function to the vaso-motor nerves. The vaso-dilator nerves, as a rule, come from the cerebro-spinal system; the vaso-constrictor nerves are, as a rule, branches of the sympathetic system. The explanation of the functions of the vaso-dilator system of nerves is somewhat simplified by the following observation: It has been stated that when the sciatic nerve of a frog is divided, the vessels of the parts supplied by that nerve dilate. Such dilatation is, however, usually transient. Twenty-four hours after the section of the nerve the vessels may be found to have quite regained their normal calibre, even if still cut off from the central nervous system. Such a fact, which must, of course, be due to the regained power of contraction of the circular muscular fibres, can only be explained through the assumption that the walls of the vessels are supplied with nervous ganglia which are themselves capable of originating impulses sufficient to produce varying degrees of contraction of the circular muscular fibres of the arterioles. Normally, the impulses originated by these peripheral ganglionic cells are dominated by the influences coming from the central vaso-motor centre. When the vaso-motor nerve of a part is divided these centres are suddenly deprived of this dominating influence, the muscular fibres are paralyzed, and the arteries dilate. When the shock of the operation has passed off, the peripheral ganglionic cells themselves acquire the power of governing the degree of contraction of the muscular fibres of the arteries and the vessels then regain their normal tone. When stimulation of the auricular nerve or of the chorda tympani produces dilatation of the vessels of the parts supplied by these nerves, the effect may be explained by assuming that the impulses com-



CAUSES OF ALTERATIONS IN BLOOD PRESSURE AND PULSE RATE.

<p>By slow action of the heart, By smallness in the amount of blood sent out of the heart at each systole, By dilatation of the small arteries, . . . . .</p>	<p>Irritation or increased excitability of vagus roots, . . . . . Irritation or increased excitability of vagus ends in the heart. Paralysis of sympathetic ends in the heart? Weakness of the heart, Imperfect systole of the heart. Diastole of the heart. Contraction of the pulmonary vessels. Great dilatation of the venous system. Paralysis of the vaso-motor centre, . . . . . Peripheral ends, . . . . . fibres, . . . . . muscular coat of the arterial walls.</p>	<p>Directly, by the action of drugs on them. Indirectly, " increased blood pressure. Reflexly, by irritation of some afferent nerve. Paralysis of the cardiac ganglia. " " cardiac muscular fibre.</p>
<p>By quick action of the heart, By larger amount of blood at each beat, . . . . . By contraction of the small arteries, . . . . .</p>	<p>Paralysis of vagus roots. " vagus ends in heart. Stimulation of sympathetic roots, . . . . . " ends in heart? the cardiac ganglia, . . . . . More perfect diastole and systole. Irritation of vaso-motor centre, . . . . . " peripheral terminations. Direct irritation of muscular coats of vessels. " vaso-motor fibres, . . . . .</p>	<p>Directly, by the action of drugs. Reflexly, through the depressor nerve. " " vagus and sensory nerves, when brain is removed or animal poisoned by opium. In operations, by division of the cord or of the splanchnics.</p>
<p>Blood pressure may be diminished.</p>	<p>Directly, by action of drugs. Indirectly, by lowered blood pressure. Directly. Reflexly, by stimulation of the sensory nerves of the endocardium. Indirectly, by causing increased temperature of body.</p>	<p>Directly, by action of drugs on it. Indirectly, by accumulation of CO<sub>2</sub> in the blood. Reflexly, through the cervical sympathetic nerve. " " vagus, when the brain is present and the animal is not narcotized. Reflexly, through sensory nerves.</p>
<p>Blood pressure may be increased.</p>	<p>In operations, by irritation of the peripheral ends of the divided spinal cord or splanchnics.</p>	<p>In operations, by irritation of the peripheral ends of the divided spinal cord or splanchnics.</p>

## SECTION VIII.

### RESPIRATION.

It has been seen that through absorption the products of digestion enter into the blood and are carried by means of the circulation to the various organs and tissues of the body. In spite, however, of the constant addition of these substances to the blood its general composition remains almost uniform, for the income from the alimentary tract is balanced by the outgo through the different tissues. The blood in its passage through the capillaries of the body nevertheless undergoes great alterations in its composition. It gives up to the tissues the substances brought from the alimentary tract which are destined to nourish the different tissues of the body. Every function of a cell is accompanied by chemical change in its composition, the resulting products in the majority of cases being no longer of use to the economy. The blood is charged to remove these substances from the tissues.

Again, it has been found that the vital functions of every cell necessitated a supply of oxygen. It is the function of the blood to act as carrier of this gas and to remove as well the gaseous products of cell decomposition. We thus find that the blood acts not only as an organ of nutrition, but as an organ of excretion; in fact, as a common carrier of the several substances essential to cell life, and the carrier of the deleterious substances resulting from the breaking down of cells, and it bears them to different parts of the body where special organs are set aside for their removal. The removal of these deleterious substances constitutes excretion, the mode of removal depending upon the nature of the substances to be eliminated.

One of the most striking changes which occur in the blood in passing through active organs is the yielding up of oxygen and the overloading of the blood with carbon dioxide. It has been stated that the difference between the arterial and venous blood is that the former contains an excess of oxygen, the latter an excess of carbon dioxide, the oxygen of the arterial blood being derived from the atmosphere and entering into composition with the hæmoglobin as the blood passes through the capillaries of the lungs. The carbon dioxide is derived from the breaking down of the cell-constituents, and is likewise removed from the blood while passing through the pulmonary capillaries. The process by which these gases enter and leave the blood is almost

purely physical, and is termed respiration. Respiration may therefore be defined as that function by means of which oxygen is taken into the system and carbon dioxide eliminated. Oxygen passes into the blood from the air, mainly by a process of gaseous diffusion; the same process is also largely concerned in the giving up of oxygen by the blood to the different tissues and the absorption of carbon dioxide from the different tissues by the blood, and the yielding of this gas to the air within the lungs.

1. GENERAL VIEW OF THE ORGANS OF RESPIRATION.—The function of respiration is an organic function, existing in the vegetable as well as in the animal, the products of respiration being the same in both. In the vegetable the introduction of oxygen and elimination of carbon dioxide takes place both during day and night, but during the day the function of respiration is masked by the processes of nutrition in which the reverse change takes place, carbon dioxide being appropriated by the plant and oxygen set free.

In examining the different forms of respiratory apparatus peculiar to different kinds of organic beings it is readily determined that in all the main respiratory tissue is that part of the respiratory apparatus which is concerned in the absorption of oxygen and in the elimination of carbon dioxide, and, like the digestive tube, is simply a modification of the external tegumentary surface.

In the simplest forms of plant life the external tegumentary covering constitutes the entire respiratory apparatus, and it is through this that oxygen is absorbed and carbon dioxide eliminated. But in the more highly organized forms of plants a system of tubes, known as the spiral vessels, are found ramifying through their stems and leaves, and even in their most perfect form seldom contain other than gaseous matters. These spiral vessels in the endogenous plants are universally distributed through the stem, and form a part of every bundle of fibro-vaseular tissue; but in the exogenous plants they are usually confined to the medullary sheath immediately surrounding the pith. In each case, however, they traverse the stems in such a manner as to enter the leaves through the foot-stalks. These vessels carry air from the exterior to the interior, and it is an especial fact to be noted that the atmospheric air contained in them possesses a larger amount of oxygen than the free atmosphere. On the under surfaces of leaves are also to be found distinct openings, or stomata, which, although apparently for the admission of materials necessary for nutrition, also seem to have the power of admitting air into the cavities existing in the leaves, especially beneath the inferior cuticle. Thus, it is the external surface of the plant through which respiration is practically performed.

So, also, in animals, respiration always takes place through an

external membrane, or some extension of such membrane, outward prolongations constituting gills, inward prolongations constituting the lungs; so that all animals may be classed as *air-breathers* or *water-breathers*, the latter breathing the air dissolved in water. To the former class belong myriapods, spiders, insects, reptiles, birds, and mammals, while all other animals, with few exceptions, are water-breathers; in the first class the organs of respiration are internal; in the latter class more or less external, but in all are to be regarded as modifications of the external integument (Fig. 237).

In the lowest forms of animal life, all of which are inhabitants of water, there are no prolongations of this membranous surface—aeration of the fluids being accomplished by their exposure to the surrounding medium containing oxygen in solution. No distinct respiratory organs are present in these forms of life, unless the contractile vesicles described as being constantly found in such organisms are of this character. In animals belonging to the group of protozoa the surface of the body is

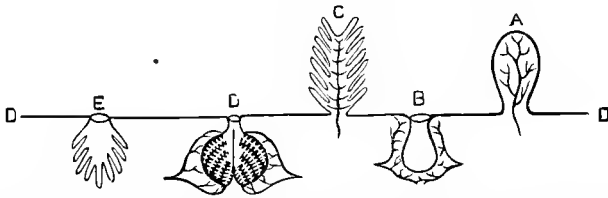

FIG. 237.—DIAGRAM ILLUSTRATING DIFFERENT FORMS OF RESPIRATORY APPARATUS. (Carpenter.)

A, simple leaf-like gill; B, simple respiratory sac; C, divided gill; D, divided sac; E, pulmonary branchia of spider.

usually more or less provided with cilia, which serve by their vibrations to continually change the stratum of water immediately in contact with the external surface. The presence of a fluid containing oxygen in solution in contact with the respiratory surface is thus always insured.

In sponges, as in infusoria and polyps, we find that the respiratory surface exists in the form of tubular passages through the body, provided at certain points with cilia, the air being absorbed from the currents of water passing through them.

In the coelenterata, which are all aquatic, no circulatory organs are present, and, as a consequence, no respiratory apparatus; for we find that while organs of circulation are dependent upon the complexity of the alimentary apparatus, so the presence of distinct circulatory organs governs the presence of organs of respiration.

In the coelenterata any part of the body surface appears to be capable of accomplishing the interchange of oxygen and carbon dioxide. In some the body cavity also, doubtless, fulfills this function. This would seem to

indicate a step higher in organization and a beginning of a specialization of certain tissues for carrying on the functions of respiration. This is the case in the polyps and in the sea-anemone, while in the bryozoa there is a marked dilatation of the pharynx, which seems to be particularly intended to provide for the aeration of fluids.

In certain members of the group of annuloida a still higher specialization of the respiratory apparatus is met with. Thus, in many there exist peculiar ramified contractile vessels, the trunks of which open upon the surface of the body, and are in part ciliated in their interior. These are the so-called water-vessels, and are supposed to be subservient to the respiratory process.

In various of the echinoderms, in addition to numerous gill-like fringes, two sets of canals are found, the one carrying the nutritive fluid, and the other radiating from a ring around the mouth, and distributing aerated water.

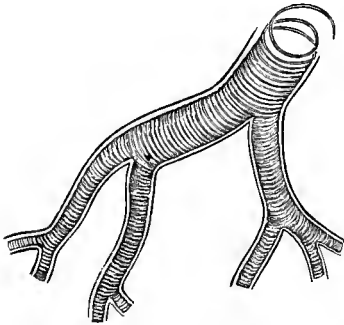

FIG. 238.—TRACHEÆ OF INSECT, SHOWING THE SPIRAL FIBRE. (*Jeffrey Bell.*)

In worms, especially in the silk-worm, a system of spiral vessels analogous to those of the plant and permeating the structure in every direction is often to be detected. These are called tracheæ, and communicate directly with the atmosphere by open breathing orifices on different portions of the body of the insect, and may be readily noticed in the caterpillar as dark spots upon the sides. In fresh-water worms,

like the leech and earth-worm, the body is covered externally by a viscid fluid which has the power of absorbing air; so such animals breathe by the skin, beneath which lies a dense net-work of blood-vessels. In insects one of these spiracles, as they are also named, traverses the body on either side along its whole length, sending out ramifications, as referred to above. The tracheæ are prevented from having their cavities obliterated by spiral elastic fibres which seem an analogue of the cartilaginous rings in the tracheæ and bronchiæ of the air-breathing vertebrates (Fig. 238).

Thus, in insects, as in mammals, the air is carried to the fluids to be aerated.

In marine worms, which are water-breathing animals, the simplest form of gill is seen; it consists of delicate veins projecting through the skin along the side of the body in a series of arborescent tufts. As these float in the water the blood is purified (Figs. 239 and 240).



In the spider the respiratory apparatus consists of a series of sacs, less numerous than the tracheæ of the silk-worm, and not communicating with each other; yet additional space is obtained by arranging the lining membrane into a series of folds, which lie in close relation to each other like the leaves of a book, thus forming the first indication of a lung. From the extensive surface thus produced, in which lies a net-work of vessels, the blood is brought into immediate relation with the air, which enters through the breathing parts referred to. The exchange of air in the sacs is accomplished by the movements of the body of the insect, which empty the sacs by compression and allow them to refill by the elasticity of their walls. These respiratory cavities are called pulmonary branchiæ from their resemblance on the one hand to the lungs of the higher animals, and on the other hand to the branchiæ or gill-sacs (Fig. 241).



FIG. 239. — THE LOB-WORM (*Arenicola*). (Carpenter.)

The arborescent gills are situated on certain segments only.

In the oyster and mollusk we have an approach to the respiratory apparatus of the fish. On opening an oyster a delicate membrane, known as the mantle, is seen lining the edge of the cell. The gill is constituted by a double fold of the mantle covered with cilia; upon the gill ramify the blood-vessels, which are bathed by the water which passes over them. From this water the blood receives oxygen and gives carbon oxide to it,

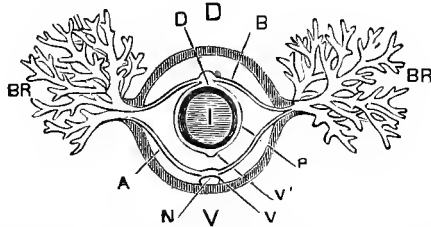

FIG. 240.—TRANSVERSE SECTION OF ARENICOLA, AFTER GEGENBAUR. (Jeffrey Bell.)

D, dorsal, V, ventral sides; N, ganglionic chain; I, intestine; BR, gills; V, ventral vessels; D, dorsal vessel; V', visceral vessel; P, vessel around intestine; A, B, vessels of gills.

—an exchange which is just as essential to the oyster as for breathing mammals (Fig. 242).

In the clam the gills are inclosed in the mantle, forming a tube, the siphon, through which the water is forced by cilia.

In the lowest forms of crustaceans, as in the branchiopods, the respiratory appendages are nothing more than thin plates, within which

the blood circulates, and outside of which is the oxygenated water in which they are bathed (Fig. 243). In the higher orders, as exemplified by the crab, we find external gills like those of the oyster, and attached to movable parts of the body, as the legs, exemplifying the association of locomotor with respiratory activity. They are kept in motion to bring the respiratory apparatus in contact with fresh portions of water. In the crab the gills are inclosed within a cavity formed by a doubling of the horny integument, and the stream of water is kept up through

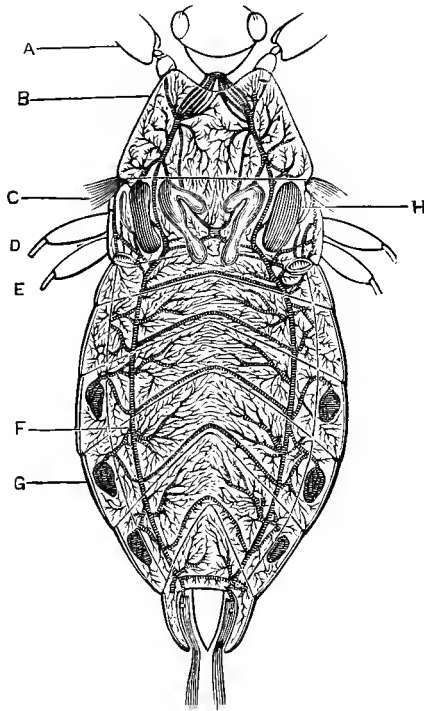

FIG. 241.—RESPIRATORY APPARATUS OF INSECT. (*Carpenter.*)

A, first pair of legs; B, first segment of thorax; C, origin of wing; D, second pair of legs; E, third pair of legs; F, tracheæ; G, stigmata; H, air-sacs.

these by means of a valve in the exit-pipe worked by the jaws. The constant movement causes a regular stream of water to issue from the gill-chamber.

In the fish the respiratory apparatus in all essentials corresponds with that of the mollusk, the branchial element only being modified and multiplied in accordance with the higher grade of life. The gills are formed of folds of membrane, between which are distributed the blood-vessels, and which are suspended from two bony or cartilaginous arches

(Fig. 244). The water is taken in by a process of swallowing, the mouth being first distended, and, as the muscles contract, the water is expelled through the aperture on either side of the pharynx into a cavity called the gill-cavity, and, as it passes over the gills, the oxygen of the atmosphere held in solution is absorbed by the blood.

Fish are thus admirably fitted for aquatic respiration, but die on removal from the water from the fact that, as the gills dry, absorption of oxygen is impaired, and the gills cling together, and so prevent exposure of their greater portion to the air. Under such circumstances fish then die from asphyxia. In some cases there is provided in addition an air-bladder or swimming-bladder, like a rudimentary sac of the air-breathing apparatus of the higher animals. In its simplest condition it is entirely closed, and can, therefore, serve no purpose except to

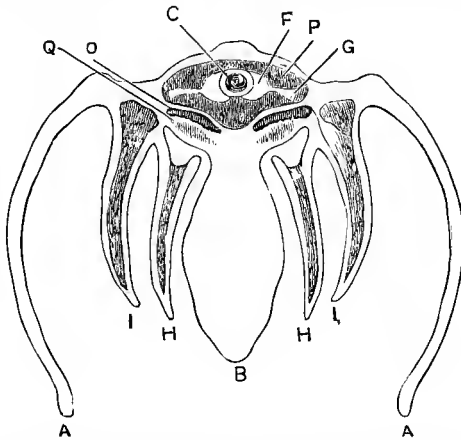

FIG. 242.—DIAGRAMMATIC SECTION OF A LAMELLIBRANCH (FRESH-WATER MUSSEL, *Anodon*) THROUGH THE HEART. (Huxley.)

F, ventricle; G, auricles; C, rectum; P, pericardium; H, inner gill; I, outer gill; O Q, organ of Bojanus; B, foot; A A, mantle-lobes.

regulate the specific gravity during swimming. In others this bladder is connected with the alimentary canal by a short, wide tube, called the ductus pneumaticus, and is filled by the process of swallowing.

If we admit, as seems perfectly reasonable, that the air-bladder of the fish is a rudimentary lung, it may be stated that all vertebrates in the course of their life have two different kinds of respiratory apparatus. Every form of vertebrate breathes through gills during embryonic life; in the fish and a few reptiles the gills are permanent, but in others they disappear, and, while traces of a lung are seen in all vertebrates, they acquire full development only in reptiles, birds, and mammals: while, again, certain amphibians, as the Proteus and Siren, retain both gills and lungs to adult life, and thus form a link between fishes and reptiles.

Vertebrates are the only animals that breathe through the nostrils or mouth. Fishes inspire only, and all vertebrate animals in whom the ribs are absent or solidly fastened together swallow air.

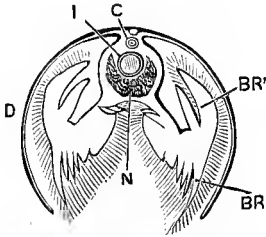

FIG. 243.—TRANSVERSE SECTION OF A BRANCHIOPOD, SHOWING THE LEAF-LIKE GILLS, AFTER GRUBE. (Jeffrey Bell.)

C, heart; I, intestine; N, ventral nerve-cord; D, fold of the integument; BR BR', gills, which are appendages of the body.

The greatest diversity is met with in these animals as regards the structure and mobility of the thorax. In the saurians, the thorax resembles that of mammals, with movable ribs; in the chelonia, the thoracic walls are rigid and immovable; in the ophidians, the ribs are very numerous and movable, the sternum being absent. A diaphragm is met with only in the higher saurians. In reptiles inspiration is not accomplished by inhalation, but by deglutition, air being drawn into the pharynx by depression of the hyoid apparatus, and the nares then being closed, the air is forced into the trachea.

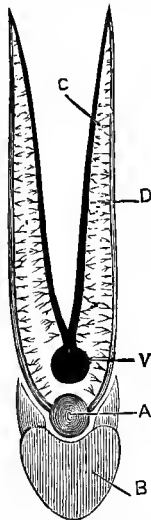

FIG. 244.—GILL OF THE PERCH. (Jeffrey Bell.)

A, branchial artery; B, branchial arch (seen in cross-section); C, branches of the branchial vein, V; D, branches of the branchial artery.

Expiration is accomplished mainly by the elasticity of the lungs, aided by the abdominal muscles, and in saurians and ophidians by the intercostal muscles and the elasticity of the chest-walls. In snakes, as a rule, there is a single, long, cylindrical lung, while the left lung is rudimentary.

In birds, though the diaphragm is still absent or rudimentary, the respiratory apparatus is more complicated than any yet considered, so that the energy of the respiratory process is much increased, and yet the general plan of the apparatus is much more closely allied to that of reptiles than of mammals. For each lung may be considered to be subdivided into lobules, each of which resembles the rudimentary lung of

the frog, flattened and fixed to the back of the thorax. In addition to the elementary lungs numerous large air-sacs, distributed in various parts of the body, as the abdomen, the muscular interspaces, interior of the bones, etc., are found communicating with the lungs. And as the lining membrane of the bones, as well as of all these cavities, is extremely vascular, it also, in these localities, serves to assist in the aeration of the blood by exposure to the air. In fact, if the wind-pipe be tied and an opening be made in the wing-bone, respiration may still go on. This large increase of respiratory surface serves as well as store-room for atmosphere and is well adapted to the purposes of flight, during which the respiratory movements are less free. The lungs and the accessory apparatus of birds is filled with air by the process of suction through the trachea, in consequence of the permanent distended condition of the whole cavity of the trunk from the nature of its bony encasement. Such is the natural condition of this bony frame-work that when no pressure is made upon it it is completely distended; as a consequence, the lung-tissue permanently attached to the ribs possesses such a degree of elasticity as to enable it to spontaneously dilate. Hence, the disposition of the air to fill the distended cavities until, by the action of the external muscles upon the bony frame-work, a portion of the air is expelled and its place again immediately taken by a fresh supply of air on relaxation of these muscles. Inspiration, therefore, in birds, in opposition to what we shall find to be the case in mammals, is passive, while expiration is active and is accomplished by drawing the sternum toward the backbone by muscular contraction, thus compressing the lung and expelling the air.

The organs of respiration in man and mammals generally consist of, first, the bony frame-work of the chest; second, the diaphragm and other muscles; and, third, the trachea, bronchial tubes, and air-vessels. In mammals alone is there a perfect thorax, *i.e.*, a closed cavity for the heart and lungs, with movable walls and a muscular partition, the diaphragm, separating the thoracic from the abdominal cavity.

The trachea is a cylindrical tube consisting of a varying number of cartilaginous rings, imperfect posteriorly in man and most animals. These posterior imperfect spaces are occupied by the muscles which control the calibre of the tube. The use of these cartilaginous rings is to keep the tube patulous, so as to permit the entrance and free egress of air, subserving the same function as the spiral fibres in the interior of the air-vessels of the plant and insect already described. Immediately within the cartilaginous rings, which are bound together by fibrous tissue, is found a fibrous connecting membrane; within that is a mucous membrane continuous with that of the mouth and the pharynx, supplied with cylindrical, ciliated, epithelial cells, the cilia of which vibrate toward the pharynx and serve the purpose of facilitating the discharge of the

secretions or of any foreign substance which may lodge upon it. When the trachea reaches the second or third dorsal vertebra it bifurcates into two principal bronchi, passing one to each lung, and subsequently these again divide and subdivide in various directions until they have attained the size of the most minute bronchial tubes.

The larynx, which is placed at the laryngeal extremity of the trachea, may be considered as corresponding to the base of a tree, the trachea, to its trunk, and the bronchi to its different branches; while the ultimate bronchi terminating in the air-vesicles of the lung may be regarded as representing the leaves of the tree. The bronchi have the same anatomical constituents as the trachea, and are composed of cartilaginous rings, musculo-fibrous membrane, and a lining mucous membrane (Fig. 245).

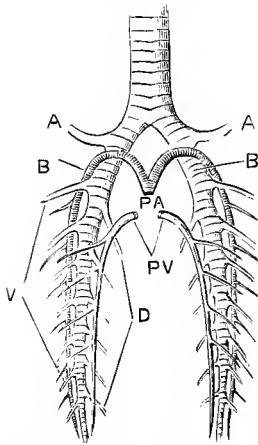

FIG. 245.—BRONCHIAL TREE OF A MAMMAL (HORSE), AFTER AEBY. (Jeffrey Bell.)

A, eparterial, B, hyparterial ventral (V), and, D, hyparterial dorsal bronchi; PA, pulmonary artery; PV, pulmonary vein.

The cartilaginous rings, musculo-fibrous membrane, and a lining mucous membrane (Fig. 245). The cartilaginous rings are also imperfect, but the imperfect spaces are irregularly distributed, sometimes in front and sometimes at the side. The object of the rings is, of course, the same as those of the trachea. The tubes are thus mere gaseous conduits kept patulous by their cartilaginous constituents. In the bronchi a fibrous basement membrane is found, as well as unstriped muscular fibres, and in the bronchi the muscular fibres do not merely connect the ends of the rings, but completely encircle the tubes in the form of annular fibres. These muscular fibres are unstriped and involuntary, and therefore possess the same characteristics as the unstriped muscular fibre found elsewhere, and serve to regulate the calibre of the tubes. The lining mucous

membrane of the bronchi is also a ciliated membrane and extends down to the commencement of the finest bronchi. In the mucous membrane are found tubular glands forming a mucous secretion. In the minute bronchi the cartilaginous rings disappear and the bronchioles are then constituted of a layer of circular muscular fibres with an inner epithelial membrane, the cartilaginous rings disappearing when the bronchi have been reduced to about one-thirtieth to one-fiftieth of an inch in diameter. The bronchi ultimately terminate in a dilated portion, termed lobules or infundibula, which consist simply of a homogeneous membrane abundantly supplied with blood-vessels. This dilatation is formed by the same material as constitutes the fibrous wall of the tube thrown up into folds, between which ramify the blood-vessels. The contained blood is, there-

fore, exposed on both sides to the atmosphere. As the capillary network is spread over several cells, aeration of the blood is thus thoroughly secured, and in this locality the venous blood is converted into arterial. The calibre of these capillaries is extremely small, being only in diameter equal to the thickness of a red blood-corpusele. It has been estimated, nevertheless, that the pulmonary capillaries in man are capable of containing about two liters of blood, and it has been further calculated that this amount is renewed ten thousand times in twenty-four hours. And, even making allowances for error in these calculations, it is evident how large is the surface for the interchange of gases between the air and blood.

The diameter of the air-vesicles is from one two-hundredth to one-seventieth of an inch. Their number is almost infinite. It has been calculated that about the termination of each bronchus in a mammal are collected seventeen thousand seven hundred and ninety air-cells, and their total number has been computed to be at least six hundred millions. It has been further calculated by Lieberkühn that the whole extent of respiratory surface of both lungs in man is fourteen thousand square feet, or two hundred square meters, and this surface is attained through the reduplications of the membrane, so occupying the least possible bulk. The air-vesicles gradually increase in number from infancy to adult life, when they remain stationary for a time, after which they decline, so that there is less respiratory surface in infancy and old age than in adult life.

The walls of the air-vesicles are highly elastic, from the presence of elastic fibres, which form a close net-work with very fine meshes. Through the presence of this elastic tissue the air-vesicles, therefore, tend continually to contract,—a phenomenon which, as will be later demonstrated, is of the greatest importance for the process of expiration. All the different parts of the lungs are held together by delicate elastic tissue, and outside of this by a serous membrane, termed the pleura, which covers the external surface of the lungs and is reflected on to the internal surface of the thorax. The pleural membrane thus forms a shut sac, and the lung lies on the outside of it.

The thorax is composed of a closed cavity in the form of a truncated cone, of which the sides, back, and a portion of the interior surfaces are formed by the ribs and costal cartilages with their intervening muscles. Its base is oblong, more or less flattened laterally in quadrupeds and antero-posteriorly in man. The ribs are always more or less curved, with their concavity directed internally. In general, the first rib is the shortest, is less curved, and less inclined to the vertebral column. As a rule, it may be stated that in animals in whom the thorax is short the ribs are more curved than in those where the thorax is longer.

The backbone forms a part of the posterior boundary of the chest, the sternum the anterior boundary. Below, the thorax is shut off from the abdominal cavity in mammals by the diaphragm; above, it is closed by the muscles of the neck. The lungs are suspended in a semi-distended state in the cavity of the thorax, and with the heart and great blood-vessels completely fill it. Since the thorax forms an air-tight cavity there is through the elasticity of the lungs a constant tendency to the production of a vacuum between the pleural surfaces. This tendency to contraction, due to the elastic fibres of the lungs, is of great importance in assisting respiration. If an opening be made into the pleural cavity the atmosphere at once enters, and the lungs then through their elasticity collapse. Atmospheric pressure being the same within and without the lungs, the resistance of the walls of the thorax is the only factor which prevents the collapse of the thorax from the elasticity of the lungs.

This tendency to retraction of the thoracic walls is readily seen in the intercostal spaces, particularly if the outer muscular layers be removed. Distinct depressions may then be recognized between each rib, and indicate the negative pressure produced upon the walls of the thorax by the constant tendency to contraction of the lungs. This negative pressure is likewise exerted on the upper and lower extremities of the thorax. There is, therefore, a constant depression of the soft tissues of the neck toward the thoracic cavity, until the increased tension so produced results in equilibrium. So, also, there is a constant tendency to the ascent of the diaphragm in the thoracic cavity by the same means. In the passive state of the thorax there is, therefore, a constant equilibrium produced, which results from the balance between this negative pressure exerted by the lungs and the resistance of the walls of the thorax.

The walls of the thorax, in so far as they are constituted by the ribs and diaphragm, are not, however, rigid, but are capable of undergoing change in position.

The ribs are acted on by various muscles whose contraction results in an increase in the lateral and antero-posterior diameters of the thorax. The diaphragm is also capable of changing its position, but when it contracts tends to depart from its concave, dome-like position, and become more horizontal. The contraction of the diaphragm, therefore, serves to increase the vertical diameter of the thorax.

As the thorax is increased in its dimensions the lungs are compelled to follow its movements, from the fact that otherwise there would be a production of a vacuum in the pleural cavity. As, however, the lungs likewise become increased in volume, the air in them becomes rarefied, and since the air within the lungs is in direct communication with the atmosphere the air streams in from without to the interior of the lungs,



until equilibrium is produced (Fig. 246). On the other hand, if the forces which produce enlargement of the thorax cease to act, the elasticity of the lungs, together with that of the cartilages of the ribs, is now sufficient to produce a return of the thorax to its original volume. The lungs, therefore, now decrease in volume, and as a consequence the air within them tends to become compressed, and, as a result, a portion of the air is expelled through the air-passages to the external atmosphere. The expansion of the thorax constitutes inspiration; the contraction of the thorax constitutes expiration.

As the tension of air in the lungs becomes decreased through inspiration, fresh air enters the lungs which is less charged with the carbon dioxide than that previously present in the lungs, while it is also

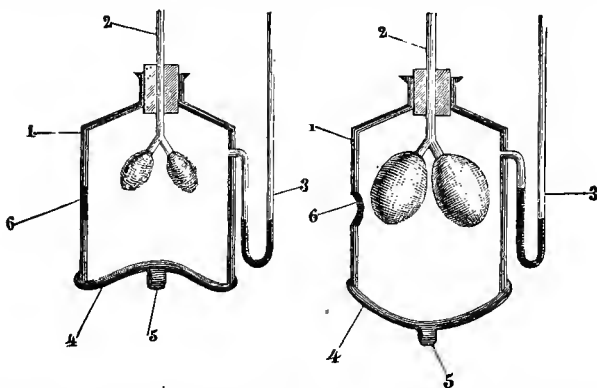

FIG. 246.—DIAGRAMMATIC REPRESENTATION OF THE RELATIONS BETWEEN THE LUNGS AND THE THORACIC CAVITY, AFTER FUNKE. (*Beaunis.*)

The bell-jar, 1, represents the thorax; the rubber membrane, 4, the diaphragm; the membrane, 6, the soft parts of an intercostal space; 2, the trachea, terminating in two rubber bulbs representing the lungs; 3, a manometer for measuring the pressure within the bell-jar.

In the figure to the left the atmospheric pressure within the bell-jar is the same as on the outside, and the mercury in the manometer stands at the same level in both arms. If the rubber membrane, 4, is drawn downward by the button, 5, the cavity of the bell-jar is increased and the atmospheric pressure diminished, as shown by the manometer and the depressed space, 6. The negative pressure thus produced leads to the entrance of air through the tube, 2, into the rubber bulbs, which consequently expand. The action of the diaphragm in producing inspiration is precisely similar.

richer in oxygen. By diffusion, from the inequality of these gaseous tensions, we have oxygen brought to the lowermost strata of air in the lungs and carbon dioxide diffusing from them, and when the air again leaves the lungs in expiration it has been the means of introducing oxygen into the lungs and removing carbon dioxide from them.

The amount of air which ordinarily enters the lungs in inspiration and is dispelled in expiration is spoken of as the tidal volume. By forcible muscular contractions the capacity of the thorax may be both increased and decreased beyond the dimensions present in gentle respiration. The amount of air so drawn in by a forced inspiration is spoken of as complementary air; that expelled from the lungs in violent expiration is spoken of as supplemental air; while, even after forced expiration, a

considerable amount of air remains in the lungs, and this quantity is spoken of as the residual volume.

2. THE MECHANICAL PROCESSES OF RESPIRATION.—*The Mechanism of Inspiration.*—Every increase in the diameters of the thorax produces, as a consequence, for the reasons already referred to, an expansion of the lungs; hence, air enters the lungs from the difference in atmospheric pressures. Such a movement is termed an inspiration. It is clear that in the production of inspiration the natural elasticity of the lungs and the thoracic walls must be overcome. Inspiration is, therefore, an active movement and requires the exertion of muscular force. The diameters of the thorax may be increased either through the elevation of the ribs or through the descent of the diaphragm. It is through the latter that in quiet respiration inspiration is produced. The diaphragm may, there-

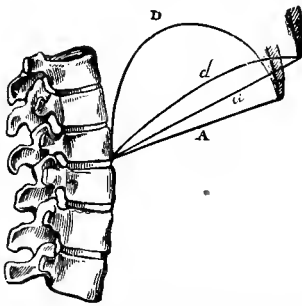

FIG. 247.—DIAGRAMMATIC REPRESENTATION OF THE ACTION OF THE DIAPHRAGM. (*Béclard.*)

If A represent a plane extending in expiration from the sternum to the vertebra, and D the position of the diaphragm, in inspiration the plane A will move to *a*, while the diaphragm will descend to *d*.

fore, be regarded as the principal muscle of inspiration. In its condition of relaxation the muscular fibres of the diaphragm together form a curved surface whose concavity extends far up into the thorax. When the muscular fibres of the diaphragm shorten they tend to form a straight line between their origins and insertions, and, therefore, the diaphragm in its condition of extreme contraction tends to form an almost plane surface across the lower portion of the thorax. The origins and insertions of the muscular fibres of the diaphragm may be regarded as comparatively fixed. The central tendon is, moreover, but slightly movable, since it is

firmly connected with the organs occupying the mediastinum above, and below is more or less supported by the liver and stomach. It is, therefore, evident that the diaphragm in inspiration cannot become completely flattened, since its curvature corresponds with that of the curvature of the abdominal organs. When the diaphragm, then, contracts, the curve is slightly flattened out, and this muscle may, therefore, be regarded as acting as a curved piston which descends in the cavity of the thorax, and so increases its long diameter; at the moment in which the diaphragm contracts, the ribs in which it is inserted anteriorly are actively elevated. Thus, while the diaphragm in descending tends to lengthen the vertical diameter of the chest, the elevation of the inferior ribs would appear to diminish this diameter.

The ascent of the lower ribs is, nevertheless, much less extensive than the descent of the diaphragm. It is further to be noticed that every

ascent of the ribs produces an increase in the antero-posterior diameter of the thorax; or, in other words, increases the distance between the sternum and vertebral column. Therefore, this ascent of the ribs, so far from diminishing the inspiratory effect of the diaphragm, tends even to increase it. This may be rendered clear by the diagram (Fig. 247).

At the same time the diaphragm contracts the abdominal organs are pressed downward, and so cause a projection of the abdominal walls.

In forced inspiration the power exerted on the ribs through the diaphragm is greater than that which tends to elevate the lower ribs. This is especially the case when there is any obstruction to the entrance of air into the lungs. In such cases there is a distinct constriction of the thorax at the points of insertion of the fibres of the diaphragm. This reduction in the circumference of the chest at these points is, however, of but slight importance, since the increase of the thoracic cavity by the greater descent of the diaphragm more than compensates for the decrease in its circumference. It is probable that in all circumstances this depression of the lower ribs would be more marked in strong contraction of the diaphragm were it not for the fact that the descent of the abdominal organs produces an increased tension in the abdominal walls, and, therefore, offers a certain resistance to the production of this constriction.

Colin has estimated that in the horse the diaphragm in inspiration descends from ten to twelve centimeters in the abdominal cavity, thus, to this extent, increasing the long diameter of the thorax, while the transverse diameter at the same time increases from three to four centimeters.

The movements of the ribs in producing inspiration are much more complicated. Each rib articulates by two facets with a costal cavity formed by the junction of the ribs and two contiguous dorsal vertebræ. The only movement possible in the ribs, therefore, must occur around a line which passes between these two points of articulation; or, in other words, nearly coincides with the axis of the neck of the rib. If the ribs were straight they would be only able to turn around on their own axes; since, however, the ribs are all curved in different degrees, the turning of the rib around the axis of its neck causes every point of the rib to describe an arc of a circle (Fig. 248).

Further, the point of articulation of each rib with the vertebral column is on a higher plane than its articulation with the sternum and costal cartilages, the degree of inclination being greatest in the first rib, least in the second, and then gradually increasing until the last rib forms almost the same angle as the first. From this arrangement it is evident that every elevation of the ribs will increase the distance between the sternum and the vertebral column, while the rotation of the ribs will

increase the lateral diameters of the thorax; for, since the ribs form arches, each increasing in its radius from above downward, it is evident that when the lower rib is so elevated as to occupy the position previously held by an upper rib the lateral diameter of the thorax at that point will be greater than before. Still further, the articulations of the ribs with the sternum are more or less fixed, and the resistance, therefore, which these articulations offer to the movement of the ribs

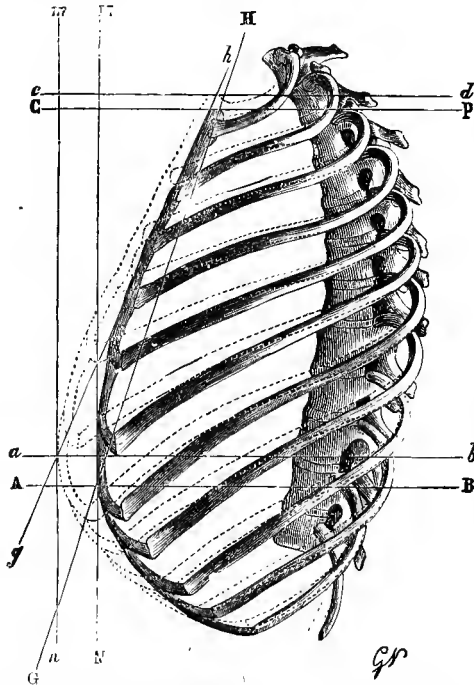

FIG. 248.—THE ACTION OF THE RIBS OF MAN IN INSPIRATION. (Béclard.)

The shaded parts represent the positions of the ribs in repose. The line A B represents a horizontal plane passing through the sternal extremity of the seventh rib; the line C D represents a horizontal plane touching the superior extremity of the sternum; the line H G indicates the linear direction of the sternum. When the ribs are elevated, as indicated by the dotted lines, the line A B becomes the plane a b, the line C D the line c d, and the line H G becomes the line h g, the projection of the sternum being the more marked inferiorly. The distance which separates the line M N from the line m n measures the increase in the antero-posterior diameter of the thorax.

will in the elevation of the ribs tend to open out the angles between the ribs and their cartilages.

By the elevation, consequently, of the ribs, the diameters of the thorax are increased both laterally and in an antero-posterior direction. Hence, everything that tends to elevate the ribs will produce an inspiratory movement; everything which depresses the ribs will produce an expiration. All muscles, therefore, which in any way may produce elevations of the ribs are inspiratory muscles.

The most important muscles of inspiration, which act by elevating the ribs, are the levatores costarum. These are small muscles which rise from the upper sides of the cervical and dorsal vertebræ, and are inserted in the posterior surfaces of the ribs. Although these are small muscles, they are inserted near to the axis of rotation of the ribs, and, consequently, but a slight degree of contraction, the lever being so long, will produce considerable elevation of the anterior extremity of the ribs. At the anterior extremity of the upper two ribs are inserted the scalene muscles, which rise from the cervical vertebra, and which in their con-

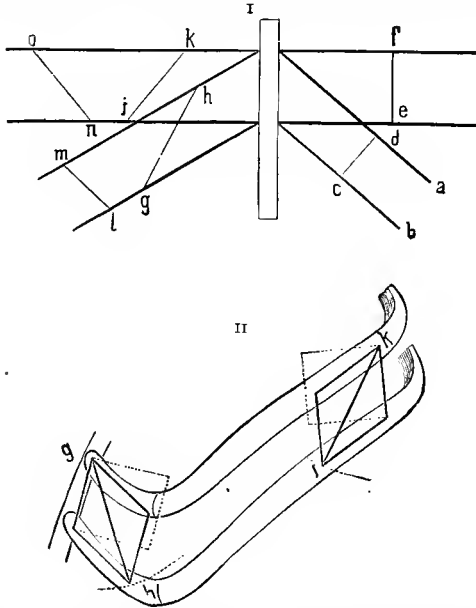

FIG. 249.—SCHEME OF ACTION OF THE INTERCOSTAL MUSCLES. (*Landois.*)

I. When the rods *a* and *b*, which represent the ribs, are raised the intercostal space must be widened ( $e/f > c/d$ ). On the opposite side, when the rods are raised, the line *gh* is shortened ( $ih < gh$ , the direction of the external intercostals); *lm* is lengthened ( $lm < on$ , the direction of the internal intercostals).  
 II. When the ribs are raised the intercartilaginei, indicated by *gh*, and the external intercostals, indicated by *ik*, are shortened. When the ribs are raised the position of the muscular fibres is indicated by the diagonals of the rhombs becoming shorter.

traction serve to elevate the first ribs, and so also tend to elevate the entire thoracic wall.

Between the ribs are found the intercostal muscles, which form two layers, the external and internal. The external intercostal muscles are attached to the adjacent margins of each pair of ribs, and extend from the tubercles of the ribs, behind, to the commencement of the cartilages of the ribs, in front, where they terminate into a thin, membranous aponeurosis, which is continued forward to the sternum. They arise from the outer lip of the groove on the lower border of each rib, and are inserted into the upper border of the rib below. Their fibres are directed obliquely

downward and forward (Fig. 249). When the external intercostal muscles, therefore, shorten, they tend, of course, to approximate their origins and insertions, and so bring the ribs into a position in which the distance between their point of origin and insertion will be the shortest possible. This condition is, of course, fulfilled when the ribs are horizontal; therefore, the contraction of the external intercostal muscles serves to elevate the ribs, and these muscles are, therefore, to that extent inspiratory.

In quiet inspiration the cavity of the thorax is increased by the contractions of the scalene muscles, the levatores costarum, and external intercostal muscles, which all serve to elevate the ribs. The diaphragm also, by its contraction, is perhaps the most important inspiratory muscle.

If the head be fixed, the sterno-mastoid muscle, by its contraction, serves to elevate the sternum, and, as a consequence, elevates all the ribs. It, therefore, may be regarded as an accessory muscle of inspiration, which is, however, only employed in forced inspiration. If the scapula be fixed, the pectoralis minor muscle, which rises from the coracoid process of this bone to be inserted into the anterior extremities of the upper ribs, will by its contraction also serve to elevate the ribs; so, also, the serratus posticus superior muscle may also, in forced inspiration, serve to elevate the ribs, and so act as an auxiliary muscle of inspiration.

*The Mechanism of Expiration.*—In the production of the enlargement of the chest, such as is essential to the accomplishment of inspiration, it has been mentioned that the elasticity of the lungs and thoracic walls has to be overcome by exertion of muscular force; when the inspiratory muscles relax, the elasticity of the lungs and thorax is alone sufficient to cause the lungs to return to their original volume. This contraction of the lungs, of course, occasions the expulsion of a quantity of air from their interior, and expiration is therefore produced. It is thus seen that expiration is mainly a passive movement, due to the reaction of the forces which have to be overcome in the production of inspiration.

It has been stated that when the diaphragm descends in inspiration, by forcing the abdominal contents downward the abdominal walls are put upon the stretch; when the diaphragm relaxes the abdominal walls tend to regain their original position, the abdominal organs are forced upward into the thoracic cavity, and the borders of the ribs, which had been slightly elevated, are now depressed. It is probable that the elasticity of these different organs is in quiet expiration entirely sufficient to balance the displacement produced in quiet inspiration. The thorax may, nevertheless, be also reduced in volume to a greater degree than is possible by the means already described. The muscles

which by their contraction lead to a decrease in the thoracic capacity, and which thus act as muscles of expiration, are mainly the muscles of the abdomen. When the abdominal muscles contract, they not only serve to still further force the abdominal organs up into the thoracic cavity, and thus lessen its vertical diameter, but they further serve to pull down the sternum and the middle and lower ribs. By so doing they lessen the antero-posterior and transverse diameters of the thorax. The internal intercostal muscles also probably assist in producing expiration by depressing the ribs. When expiration becomes extremely violent all the muscles are brought into play, which, through their contraction, may either depress the ribs, press on the abdominal viscera, or offer fixed support to muscles having those actions.

The movements of the thorax in respiration are accompanied by movements of the nostrils and glottis.

In inspiration the current of air enters through the nostrils, and not by the mouth, and by exposure to the vascular mucous membrane of the

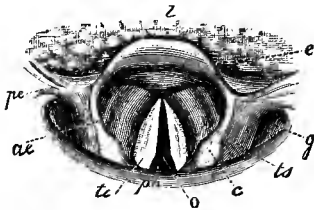

FIG. 250.—THE HUMAN GLOTTIS IN A GENTLE INSPIRATION, AFTER MANDL. (*Beauvis.*)

*l*, tongue; *e*, epiglottis; *pe*, pharyngo-epiglottic fold; *ae*, aryteno-epiglottic fold; *ph*, posterior wall of the pharynx; *c*, cartilage of Wrisberg; *th*, superior thyroarytenoid fold; *ti*, inferior fold; *o*, glottis.

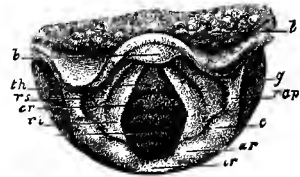

FIG. 251.—THE HUMAN GLOTTIS IN A FORCED INSPIRATION, AFTER MANDL. (*Beauvis.*)

*b*, tip of the epiglottis; *g*, pharyngo-laryngeal pouch; *l*, tongue; *rap*, aryteno-epiglottic fold; *ar*, arytenoid cartilage; *c*, cuneiform cartilage; *ir*, interarytenoid fold; *rs*, false vocal cords; *rr*, true vocal cords.

nasal passages becomes warmed up to the temperature of the body. At each inspiration the external nares expand by the contraction of their dilator muscles; this movement is especially marked in labored breathing. The horse is incapable of breathing through the mouth, and if the dilators of the nostrils be paralyzed, as by section of the facial nerve, asphyxia may be produced. In expiration, the elasticity of the cartilages of the nostrils is sufficient to cause these parts to return to their usual position. The current of air entering through the nose passes over the passive soft palate to enter the larynx, after passing through the pharynx. At each inspiration the vocal cords are separated and the glottis is thus widely opened (Figs. 250 and 251). At each expiration the arytenoid cartilages approach each other, so approximating the vocal cords, and the glottis is thus narrowed.

3. THE RHYTHM OF RESPIRATION.—The movements of the column of

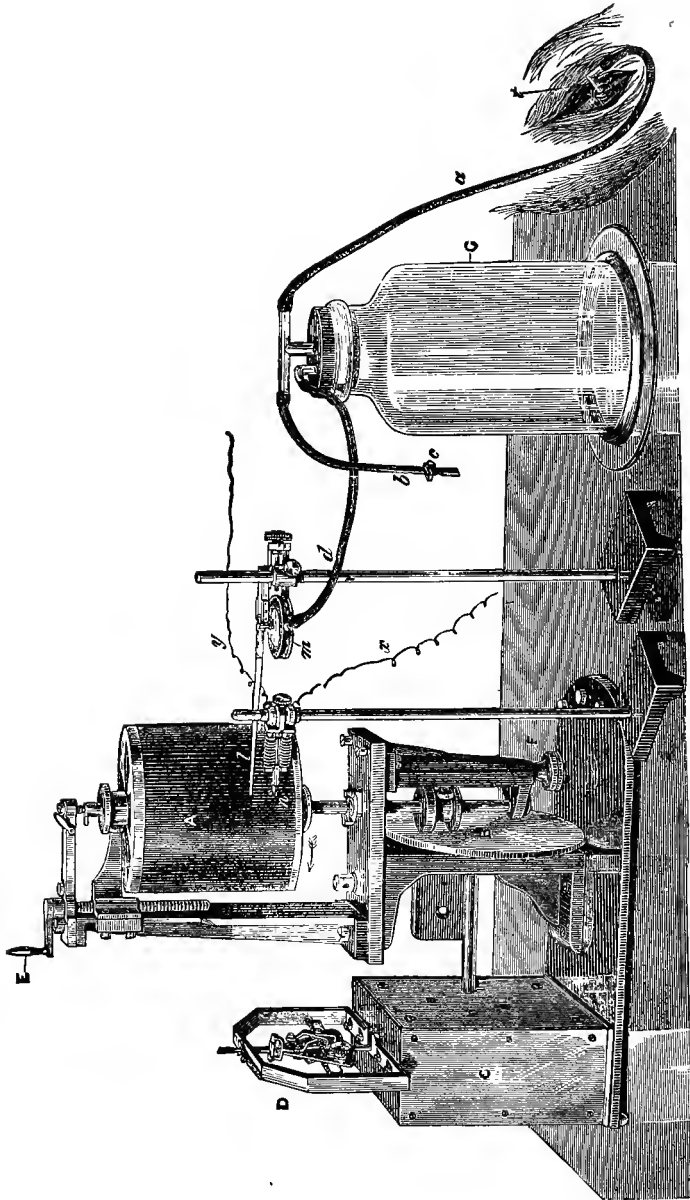

FIG. 252.—APPARATUS FOR RECORDING THE MOVEMENTS OF THE COLUMN OF AIR IN RESPIRATION. (*Foster*.)  
 The cylinder, A, covered with smoked paper, is, by means of the friction-plate, B, set into motion by the regulator, D. The cylinder may be elevated or lowered by the screw, E. The pendulum, G, is altered by means of the screw, F. The tracheotomy tube, f, fixed in the trachea is connected by rubber tubing, a, with the jar, D. The jar, D, may be opened or closed by the clamp, c. The jar is connected by tubing, d, with a Marey's sphygmograph (see Fig. 260), the lever of which writes on the drum. An electric current, broken by a pendulum, passes through the electro-magnetic time marker, h, through the wires, e and f.



air in respiration in the smaller mammals may be recorded by connecting the trachea by means of a tube with Marey's tambour:—

This instrument consists of a cylindrical box, the upper surface of which is formed by a sheet of rubber membrane, the interior being connected by tubing with the trachea, and a lever so adjusted to the rubber membrane as to record its movements (Fig. 252). If air is forced into this box it will, of course, produce bulging of the rubber membrane, and thus cause the ascent of the lever, while, on the other hand, if the air be rarefied in the interior of the box the membrane will be depressed and the lever descend. By allowing such a lever to record its movements on some revolving surface, as, for example, on the smoked paper of a kymographion, if the interior of the box be connected with the trachea of an animal, namely, in the dog or rabbit, a curve somewhat similar to the following will be produced (Fig. 253).

The descents in this curve represent the inspirations, the ascents the expirations. It is seen that the curve of inspiration begins suddenly and advances rapidly, and is then succeeded by an expiratory movement, which at first is more rapid than inspiration, but gradually becomes slower. No pause is present between the end of inspiration and the beginning of expiration, but a short pause is noted at the end of expi-

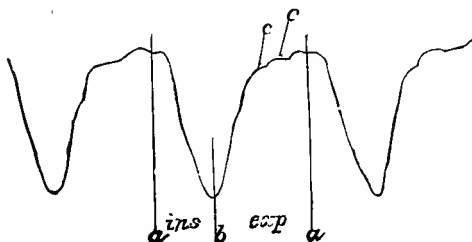

FIG. 253.—TRACING OF THORACIC RESPIRATORY MOVEMENTS. (Foster.)

(To be read from left to right.)

A whole respiratory phase is comprised between *a* and *a*, inspiration extending from *a* to *b*, and expiration from *b* to *a*. The undulations at *c* are caused by the heart's beats.

ration, the undulations in the curve at this point being caused by the heart's beats.

The duration of inspiration is, as a rule, shorter than expiration, the proportion being from ten to fourteen, although this is not invariable. The pause which is noted at the end of expiration will average in duration about one-fifth to one-third the time occupied by the entire respiratory movement.

The number of respirations in most animals may be placed, as a rule, as one respiratory movement to four pulsations of the heart. Exercise and a large number of other conditions will greatly increase the number of respiratory movements by increasing the amount of tissue change, and, therefore, increasing the amount of carbon dioxide in the blood which has to be eliminated in respiration.

In cattle the rate of respiration is higher in cows than in bulls or steers. During sleep the average rate in the cow is twenty-two in the

minute; during rumination it varies from twenty-four to thirty-six, the position appearing to be without influence. In bulls and oxen the rate of respiration averages twenty in the minute. The frequent eructation of gas and pauses caused by rumination render the rhythm of respiration more irregular in ruminant than in other mammals.

In the horse the normal respiratory movements may be placed at about ten in a minute; after only the slight exercise of walking two hundred yards, respiration in the horse may be increased to twenty-eight

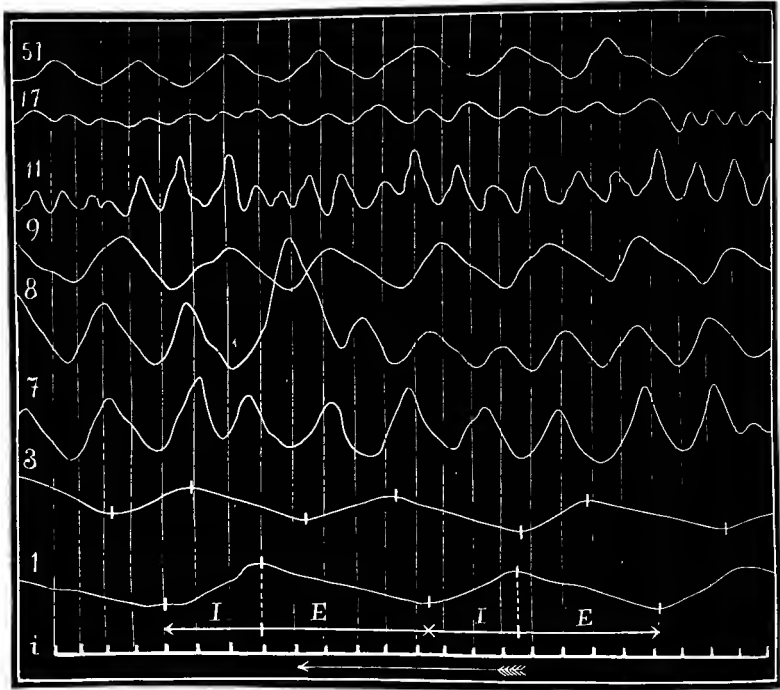

FIG. 254.—GRAPHIC REPRESENTATION OF THE RESPIRATORY MOVEMENTS OF A HORSE WHILE AT REST AND AFTER MOVEMENT. (*Thanhoffer.*)

1, standing at rest; 3, after a few minutes' walk; 7-8, after trotting; 9, after a short rest; 11, after several minutes' trotting and running; 17, after a short rest from the trot and run; 51, curve at the end of the experiment. I = inspiration; E = expiration; i = time in seconds.

in the minute, while after trotting five minutes the respirations were found by Colin to be fifty-two to the minute, falling to forty in the following three minutes, and were fifty-two, likewise, in a minute after five minutes' gallop (Fig. 254).

In all animals similar facts may be noticed. Thus, in the sheep the normal rate of respiration is fifteen in the minute, and after running may be raised to one hundred or one hundred and forty in the minute; or

even when frightened be raised from fourteen to forty-five, thus showing the effect of mental impressions. So, also, the lion has a normal respira-

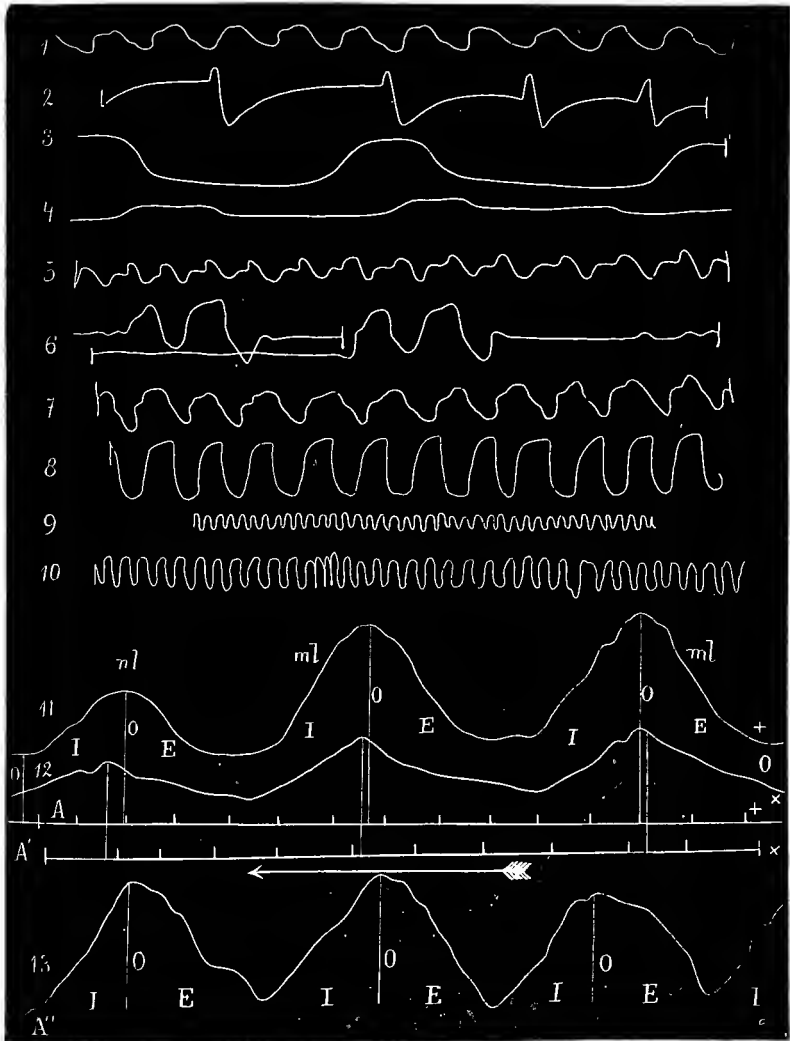

FIG. 255.—GRAPHIC REPRESENTATION OF THE RATES OF RESPIRATION IN DIFFERENT ANIMALS. (*Thanhoffer.*)

1, fish; 2, tortoise; 3, adder (in winter); 4, boa-constrictor (in summer); 5, frog; 6, alligator; 7, lizard; 8, canary-bird; 9, adult dog; 10, rabbit; 11, man; 12, dog; 13, horse. I = inspiration; E = expiration; ml = deep, nl = superficial respiration; A = abscissæ; O = ordinates.

tory rate of twelve to fourteen movements in the minute, and when excited has been found to breathe seventy times a minute. In insects

the rate of respiration is very much more rapid, being one hundred and sixty in the beetle, and in some other insects as high as two hundred and forty.

The following table, which is taken from that compiled by Paul Bert, represents the number of respiratory movements in different animals:—

Tiger,	6 in the minute.
Lion,	10 “ “
Cat,	24 “ “
Dog,	15 “ “
Ox,	15-18 “ “
Rabbit,	55 “ “
Rat,	{ 100 asleep. 210 awake. 320 excited.
Rhinoceros,	6 in the minute.
Hippopotamus,	{ 1 in the water. 10 out of water.
Horse,	10-12 in the minute.
Condor,	6 “ “
Pigeon,	30 “ “
Canary,	18 “ “

The rate of respiration varies also according to the age of different animals. This is shown in the following tables:—

Newborn infant,	44 per minute.
5 years,	26 “
15 to 20,	20 “
20 to 25,	18.7 “
25 to 30,	16 “
30 to 50,	18.1 “
In the foal,	10 to 12 “
Adult horse,	9 to 20 “
Young ox,	18 to 20 “
Adult ox,	15 to 18 “
Lamb,	16 to 17 “
Sheep,	13 to 16 “
Puppy,	18 to 20 “
Dog,	15 to 18 “

It is thus seen that young animals, as a rule, respire more frequently in the minute than adult animals; so, also, small animals breathe faster than large animals. Thus, the giraffe, camel, horse, rhinoceros, and hippopotamus breathe about ten times in the minute; the llama and deer, sixteen to twenty times a minute; the whale, four to five times a minute; the guinea-pig, thirty-five times a minute; the larger birds, twenty to thirty times, and the smaller birds, thirty to fifty times a minute.

As already described, the respiratory movements may vary in intensity. In other words, inspiration and expiration may be either shallow or deep. It is self-evident that the quantity of air taken in in a deep inspiration and expelled from the lungs in forced expiration

will be greater than the volume of air displaced in gentle respiration; and, of course, the deeper the inspiration or the more forced the expiration the more air will be displaced. There is a limit present in both cases beyond which the quantity of inspired and expired air cannot be increased. In the case of the domestic animals it has not as yet been established what is the average quantity of air displaced in respiration, but that it depends upon the size of the animal and the size and mode of structure of the thorax is self-evident. From the few experiments which have been made on this subject it may be assumed that in a quiet respiration about one-sixth of the total quantity of air capable of being contained within the lungs is displaced. It would follow from this that every six or seven respiratory movements would serve to completely renew the air within the lungs. In man, the volume of air changed in different respiratory movements has been subjected to close study. It was found that in an ordinary respiratory effort about thirty cubic inches of air enter the lungs. With this accepted as a fact, and placing the average number of respiratory movements at twenty in a minute, the whole amount of air passing through the lungs in a minute will amount to six hundred cubic inches; in an hour, to thirty-six thousand cubic inches; and in a day, to eight hundred and sixty-four thousand cubic inches, or five hundred cubic feet. Extending these periods, one hundred and eighty-two thousand five hundred cubic feet of air may be estimated to pass through the lungs of an adult man in a year, and to produce this displacement nine million respiratory movements are required. This quantity of air is employed in the aeration of about three thousand five hundred tons of blood sent out by the heart to the lungs in the same period. With these facts before us, we may obtain valuable suggestions upon the subject of ventilation. Though about five hundred cubic feet of air passes through the lungs in twenty-four hours, yet this amount of atmosphere is insufficient to sustain life for that period, for after the introduction of carbon dioxide into the air the liberation of gases in the lungs is to a certain degree rendered more difficult. There must be at least five hundred cubic feet of pure air supplied, and it has been found that to attain this at least eight hundred cubic feet of air should be provided for each individual.

The amount of air taken into the lungs at each gentle inspiration and displaced by the reverse movement constitutes the so-called pressure or tidal volume, and has been placed at about thirty cubic inches in man. At the end of every gentle inspiratory effort the lungs may be capable of still further inflation, and the additional quantity of air so inspired amounts to about one hundred and ten cubic inches (complemental volume). At the end of every gentle expiratory effort the lungs may be still further compressed; the amount of air so displaced by this

additional effort is termed the reserve volume, and also amounts to about one hundred and ten cubic inches. After a forced expiration there is still a certain amount of air which cannot possibly be forced out of the lungs; this constitutes what is termed the residual volume, and also equals about one hundred and ten cubic inches.

The vital capacity volume is the amount of air which man is capable of expiring by the greatest expiratory effort after the greatest inspiratory effort. It includes the complemental volume, the breathing volume, and the reserve volume, and is, therefore, the amount of air which may be displaced in respiration. It has been shown by Dr. Hutchinson that this volume bears a relation to the height of the individual, which is especially remarkable when we recollect that the height of individuals depends upon the length of the legs, and not upon the trunk, the same persons who may vary greatly in height while standing exhibiting but slight difference in height when sitting. It is curious, also, to observe that the vital capacity does not depend upon the capacity of the chest so much as upon the degree of mobility. Thus, a man of greater girth may have less amount of vital capacity than another with less girth but greater mobility of the walls of the chest. Mr. Hutchinson has constructed an instrument for measuring this vital capacity volume. It consists of a bell-jar so mounted as to be readily displaced by the power which is exerted by the air in passing from the mouth and air-passages. With the interior of the bell-jar communicates a tube and attached mouth-piece. The person to be experimented upon takes a deep inspiration, and then breathes out by the tube by a forced expiration, which causes the bell-jar to rise, and the number of cubic inches thrown out is measured by a graduated scale, suitably placed to indicate the rise and fall of the bell-jar. As a result of these experiments it was found that every inch added to the height of an individual increases about eight cubic inches the vital capacity. This appears upon examination of the following table:—

Height.		Vital Capacity.
5 feet 0 inches	to 5 feet 1 inch,	. 174 cubic inches.
5 " 1 inch	" 5 " 2 inches,	. 182 "
5 " 2 inches	" 5 " 3 "	. 190 "
5 " 3 "	" 5 " 4 "	. 198 "
5 " 4 "	" 5 " 5 "	. 206 "
5 " 5 "	" 5 " 6 "	. 214 "
5 " 6 "	" 5 " 7 "	. 222 "
5 " 7 "	" 5 " 8 "	. 230 "
5 " 8 "	" 5 " 9 "	. 238 "
5 " 9 "	" 5 " 10 "	. 246 "
5 " 10 "	" 5 " 11 "	. 254 "
5 " 11 "	" 5 " 12 "	. 262 "

The age has a marked effect upon the vital capacity volume; the volume increases from 15 to 30, remains about stationary from 40 to 45,

and above this age diminishes. In females it is about half that of males, although it may amount to almost as much. Weight also exerts a great influence. It has been shown that there is an average weight to every average height. If the weight increase above this amount by 7 per cent., the vital capacity decreases one cubic inch for every pound for the next thirty-five pounds above this weight. For every pound thus gained, an inch of vital capacity volume is lost for the next thirty-five pounds.

4. THE CHEMICAL PHENOMENA IN RESPIRATION.—The phenomena in respiration so far studied have been purely mechanical in nature, and have had for their object simply the introduction of air into the lungs for oxidizing the blood, and for expelling air from the lungs after its object has been served.

We have now to study the chemical changes which occur in respiration. We find that these are of two kinds,—the respiratory changes occurring in the air in the lungs and the respiratory changes occurring in the blood.

The atmosphere consists of a mechanical mixture of oxygen and nitrogen in the proportion of about twenty-one of the former to seventy-nine of the latter. Watery vapor is usually present in small but variable amount, while carbon dioxide is present in extremely small quantity, varying from about 0.03 to 0.05 per cent. During inspiration a certain quantity of this gaseous mixture, in man about thirty cubic inches in amount, is drawn into the trachea and upper air-passages. These air-passages, as well as the more deeply located portions of the lungs, are already occupied by a gaseous mixture, in which these gases are present in different proportions. It has been found that expiration immediately follows inspiration without any pause, and a certain amount of this inspired air is, consequently, at once again expelled. It has been calculated that about two-thirds which remain after expiration at once commences to mix by diffusion with the air already in the lungs. It has been found that when gases are placed in contact with each other at the same temperature and pressure they mix rapidly, until the one gas is uniformly diffused throughout the other. It has been stated in a previous section that this diffusion is independent of gravity, but is inversely as the square root of the densities of the gases. Mixtures of gases behave precisely like single gases, and diffusion will take place from one gas into another, precisely as if into a vacuum.

It has been stated that the object of respiration was to supply oxygen to the blood and to remove carbon dioxide from it. Without discussing, at present, the process by which this change takes place, it is evident that if this be a fact the air in the deepest portions of the lungs will have lost oxygen to the blood and will have taken up carbon dioxide.

The air in the air-cells will, therefore, be richer in carbon dioxide and poorer in oxygen than fresh air taken in in inspiration; as a consequence, we have the phenomena of diffusion at once taking place, the oxygen of the inspired air diffusing down into the deepest portions of the lungs, while the carbon dioxide diffuses up from the air-cells into the atmosphere through the larger bronchi and trachea. As the air penetrates, therefore, by diffusion deeper and deeper in the bronchial tubes it loses oxygen and receives more and more carbon dioxide, but the rate of diffusion is not interfered with: for in the deeper portions of the lungs the descending atmosphere is meeting with an increasing tension of carbon dioxide and a decreasing oxygen tension, so that, although the atmosphere now is poorer in oxygen than the external air, it is yet richer than the air in the air-cells, and diffusion, therefore, continues. This difference in tensions remains constant, for we have continually fresh air taken in in inspiration, and just as continually the removal of the oxygen from the air in the lower portions of the lungs and the addition to it of carbon dioxide.

The changes which the air undergoes in respiration may be recognized by a comparison of the composition and the physical characteristics of the expelled air as contrasted with the inspired air.

The temperature of the expelled air is, as a rule, higher than that of the inspired air, from the fact that the temperature of the body is almost invariably higher than that of the surrounding medium. The expired air is, as a rule, saturated with watery vapor, the water coming directly from the blood and the mucous membrane, the quantity being estimated in man as about one and one-half pounds. The watery vapor of the expired air becomes readily perceptible through its condensation in cold weather.

Expired air contains, further, numerous organic substances derived from the blood, resulting partly from the decomposition of the materials entering into the composition of the tissues, and partly from matters taken into the blood from without by absorption. Thus, various drugs, such as turpentine, are excreted by the pulmonary mucous membrane, readily revealing this in the odor of the expired air. Ammonia, also, is contained in small amount in the air leaving the lungs, the amount given off in ordinary respiration in twenty-four hours being calculated at 0.014 per cent. The presence of organic matter in the expired air may be readily proved by breathing into a vessel, stopping it tightly, and allowing it to stand a short time; the odor of putrefaction will develop itself, and it is, without doubt, to these organic substances in the inspired air that the odor of the breath is due. It has been estimated that in man about three and one-half grains of organic matter are so removed in the twenty-four hours in expired air. Many of these substances which are organic in



nature, and find their way into the expired air, are probably of a poisonous nature. For it has been found that expired air is much more poisonous to animal life than air which has not passed through the lungs of an animal, but which contains the same amount of carbon dioxide and the same degree of decrease of oxygen. It is, therefore, probable that these organic substances which are removed from the lungs are poisonous, rather than the carbon dioxide which accompanies them.

The air which passes through the lungs actually decreases in volume about one-fortieth or one-fiftieth of the amount taken in in inspiration, this falling off being probably due to the fact that all the oxygen inspired does not reappear as carbon dioxide, but enters into other compositions in the body.

The most striking contrast between expired and inspired air is in the relative proportions of oxygen and carbon dioxide, while the nitrogen undergoes but little change. The following represents this change:—

	Oxygen.	Nitrogen.	Carbon Dioxide.
Inspired air contains . . . .	20.81	79.15	.04
Expired " " . . . .	16.033	79.557	4.380

The expired air, therefore, contains from 4 to 5 per cent. less oxygen and 4 to 5 per cent. more carbon dioxide than the inspired air. Taking thirty cubic inches as the amount of air taken in in each inspiration in man, this will represent about one and one-half cubic inches of oxygen. Supposing five hundred cubic feet to be taken in per diem, the oxygen absorbed would amount to twenty-three cubic feet, or one and one-third pounds, avoirdupois, oxygen. The amount of oxygen varies according to different circumstances.

The following conclusions give at a glance some principal sources of variations. They will be studied more in detail under the subject of Nutrition:—

A man in repose and fasting, with an external temperature of 90° F., consumes 1465 cubic inches of oxygen per hour.

A man in repose, fasting, with an external temperature of 59° F., consumes 1627 cubic inches of oxygen per hour.

A man during digestion consumes 2300 cubic inches of oxygen per hour.

A man, fasting, while he accomplishes the labor necessary to raise in fifteen minutes a weight of seven thousand three hundred and forty-three kilos to the height of six hundred and fifty-six feet, consumes 3874 cubic inches of oxygen per hour.

A man, during digestion, accomplishing the labor necessary to raise in fifteen minutes a weight of seven thousand three hundred and forty-three kilos to the height of seven hundred feet, consumes 5568 cubic inches of oxygen per hour.

As already mentioned, the quantity of oxygen taken in at each inspiration does not all appear as carbonic acid; a certain quantity of the oxygen disappears, varying with the nature of the food.

If a dog be fed upon animal food, only 75 per cent. of the oxygen of inspiration returns in the form of carbon dioxide. If it be fed on vegetable food, 90 to 95 per cent. returns in the carbonic acid.

There is no absolute relation between the amount of oxygen inspired and the carbon dioxide expired, but a certain amount of oxygen always remains behind, the surplus quantity going to oxidize certain materials, such as sulphur, phosphorus, and, perhaps, certain food-constituents.

The expired air also contains a notable quantity of carbon dioxide, amounting to about 4 per cent.

If we take thirty cubic inches as the volume of each expiration, the average of carbon dioxide in each will be 1.29, or about twenty-three cubic inches per minute, about one thousand three hundred and ninety-three per hour, or twenty-seven thousand eight hundred and sixty-four cubic inches per day, or what is equivalent to about seven and one-half ounces of solid carbon.

The quantity of carbon dioxide thrown off by the lungs is notably diminished by the presence of a certain amount of carbon dioxide in the atmosphere we breathe.

To throw off the full amount, the surrounding atmosphere must be devoid of this gas. If we breathe the same air over and over again, so as to permit the accumulation of carbon dioxide, the difference in tension between the amount of carbon dioxide in the inspired air and the air in the lungs will be decreased, and diffusion interfered with.

It has been found that if 5 per cent. of carbon dioxide be allowed to remain in the air we breathe a fatal result ensues in consequence of the difficulty of elimination of the carbon dioxide from the blood. Even when carbon dioxide accumulates in the air below  $2\frac{1}{2}$  per cent. it soon begins to produce depressing influences, and this, together with the accumulation of other deleterious matters which are normally thrown off from the lungs, is the common cause of the languor which comes on in crowded rooms. When gradually subjected to these influences we do not appreciate them so much as when suddenly subjected to them, for when gradually brought under their influence the vital powers become depressed to such a degree that they do not require the same amount of oxygen as under ordinary circumstances. A person passing from the open air to a room which has been occupied for some time by a large number of persons at once experiences a depression, but after remaining there a little while the vital powers become similarly depressed and the inconvenience resulting from the presence of carbon dioxide in the atmosphere is no longer appreciated.

An experiment first performed by Bernard, showing how an individual may become accustomed to bad air, fully confirms this statement. He placed under a bell-jar a living sparrow, and, having allowed it to remain there for a certain period, he removed it but slightly influenced by the accumulated carbon dioxide: without replenishing the air, he placed a second sparrow, which had been breathing pure air, under the bell-jar, and death rapidly ensued. He then replaced the first sparrow in the same air, and it also died.

The influence of age in varying the quantity of carbon dioxide in the expired air is very striking. It has been shown that there is a notable increase in the quantity of carbon dioxide exhaled from infancy to puberty. In the male this quantity continues to increase after puberty until the age of thirty; from thirty to forty, it remains about stationary; at forty, it begins to decrease and continues decreasing until the age of sixty, when but little more carbon dioxide is exhaled than by a child of eight years. The same applies, also, to the female.

Not only does age, but time of day, amount of exercise, character of food, and the temperature also influence the quantity of carbon dioxide exhaled. More carbon dioxide is thrown off in winter than in summer, partly because more food is consumed in winter, and partly, also, because a cubic foot of atmosphere contains a larger quantity of oxygen in winter than in summer, when it has a lower density. During the day more carbon dioxide is thrown off than at night. Alcohol and other articles of the so-called accessory diet diminish the quantity of this gas removed through the lungs, probably by diminishing the waste of the tissues. This matter will be again referred to under the consideration of nutrition.

The quantity of carbon dioxide eliminated with each expiration is diminished after rapidly repeated inspirations, though the whole quantity exhaled is increased.

*The Respiratory Changes in the Blood.*—As has been already indicated, the main points of contrast between the arterial and venous blood consists, in the former in the presence of an excess of oxygen, in the latter of an excess of carbon dioxide, while as the venous blood circulates through the capillaries of the lungs it largely gives up its carbon dioxide and absorbs oxygen. We have now to consider the way in which the gases are held within the blood and the manner in which they enter and leave the blood in the pulmonary and systemic capillaries, and to trace a relationship between these changes in the blood and the changes in the air in respiration.

When blood is exposed to a vacuum produced by a mercurial air-pump, it will be found to yield about sixty volumes of gas to each one hundred volumes of blood, the temperature being zero C., and the

height of the barometer seven hundred and sixty millimeters. If the gas so collected be analyzed it will be found that in the gaseous mixture so obtained from the arterial blood there will be more oxygen than can be obtained from the venous blood; while, on the other hand, the gases so abstracted from the venous blood will contain more carbon dioxide than those obtained from the arterial blood. Further, it may be repeated that if venous blood be agitated with air or with oxygen, it will at once assume the arterial hue. It may, therefore, be concluded that the difference in the relative amounts of these gases present in the blood constitutes the real difference between arterial and venous blood, and all other differences, such as difference in color, are dependent upon this fundamental fact. The amount of gas which may be abstracted from blood has been placed at sixty volumes for each one hundred volumes of blood.

The following table represents the proportions of these gases which may be obtained from one hundred volumes of arterial and venous blood:—

	Oxygen.	Carbon Dioxide.	Nitrogen.
Arterial blood, .	20 volumes.	36 volumes.	1 to 2 volumes.
Venous blood, .	8 to 12 "	46 "	1 to 2 "
All measured at 760 millimeters and 0° C.			

The question is now raised as to the manner in which these gases are held in the blood. In the chapter on the diffusion of gases it was pointed out that every liquid possesses the power of absorbing gases, and that the co-efficient of absorption varies with the nature of the liquid, the nature of the gas, pressure of the gas, and the temperature to which it was subjected. Blood, therefore, like every other liquid, possesses the power of absorbing gases. When, however, we measure the quantity of oxygen which may be extracted from the blood by exposing it to a vacuum, we are struck by the fact that the amount so removed is greatly in excess of that which may be held in solution in the blood, regarding it merely as a fluid, by exposure to a gaseous medium in which the oxygen is in no higher tension than it is in the atmosphere.

Again, the fact is worthy of notice that the absorption of oxygen by the blood and its release from the blood are not governed by variations of pressure. If we expose blood containing little oxygen to a successive series of atmospheres in which the oxygen tension gradually increases, we shall find that at first there is a very rapid absorption of oxygen, and that this suddenly ceases; while if we submit blood highly charged with oxygen to an atmosphere containing decreasing amounts of oxygen, we shall find that at first but little oxygen will diffuse out from the blood until the pressure has been reduced almost to that of a vacuum. Oxygen then suddenly almost totally escapes from the blood. Again, if

we expose blood-serum to an atmosphere of oxygen it will absorb no more oxygen than water under the same conditions of pressure, and the amount so absorbed will be far less than that which is capable of being

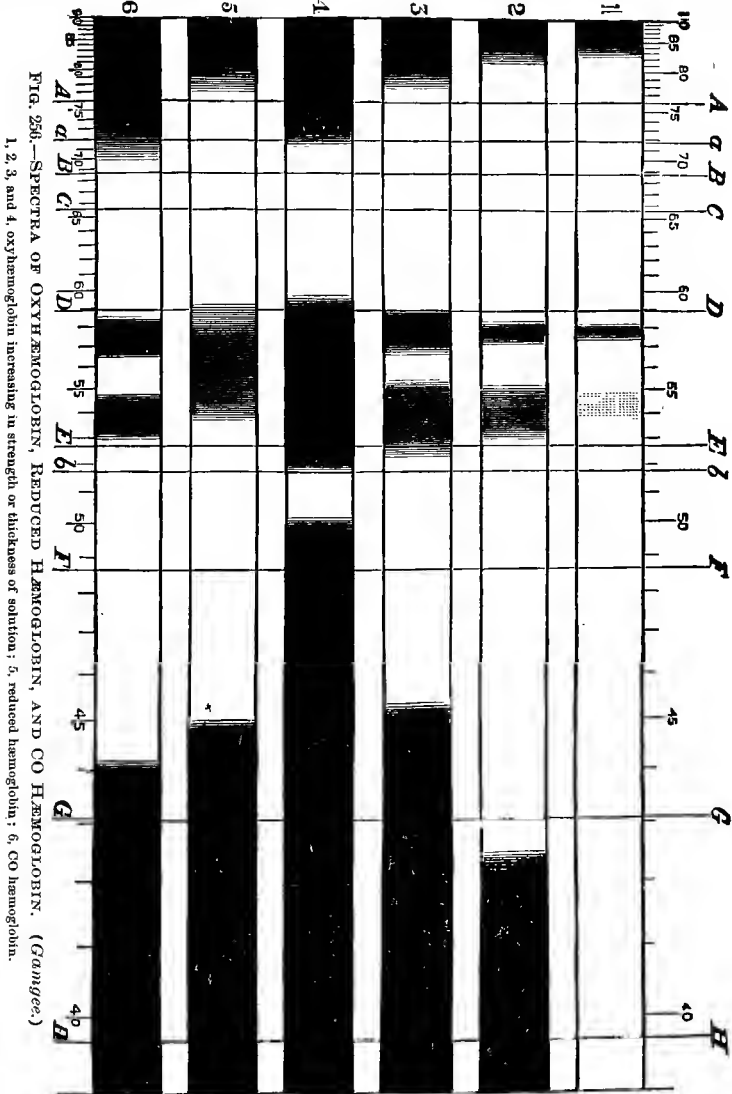

absorbed by the blood. The absorption, then, of oxygen by the blood is not due to its plasma. If, however, a solution be prepared of haemoglobin, or the coloring matter which forms 90 per cent. of the dried red corpuscles, and it be exposed to oxygen, it will be found capable of

absorbing nearly the total amount which may be absorbed by the blood. It, therefore, would appear that oxygen is absorbed by the blood through the mediation of the red coloring matter. The general characteristics of hæmoglobin have been already described under the subject of the blood. They, however, deserve more especial attention in their relationship to the respiratory functions of the blood.

When a tolerably dilute solution of hæmoglobin, which possesses the bright-red color of arterial blood, is placed before the spectroscope, it is found that a portion of the red end of the spectrum is absorbed, together with a portion of the blue end, while two absorption bands are found between the lines D and E; the line toward the red side of the spectrum is the narrowest, but is the most distinct, and with very dilute solutions is the only one visible. The other toward the blue side is much broader, but less distinct. These absorption bands are characteristic of solutions of hæmoglobin. When stronger solutions of hæmoglobin are used the bands broaden and become darker, while more and more light is shut out from each end of the spectrum, until finally the two bands become fused together, and only the green and red rays are now visible: with still stronger solutions the red rays alone pass, and finally they also may disappear, thus indicating the cause of the natural color of solutions of hæmoglobin in transmitted light (Fig. 256).

If crystals of hæmoglobin are subjected to a vacuum, oxygen is given up and the crystals become darker and more of a purple color. The quantity of oxygen which is given off is a fixed quantity, each gramme of hæmoglobin giving off 1.76 cubic centimeters of oxygen, measured at a pressure of seven hundred and sixty millimeters and at zero temperature. The hæmoglobin is then spoken of as reduced hæmoglobin. It also is soluble in water and forms a purplish solution. When examined under the spectroscope, instead of the two absorption bands, a single, less distinct, but much broader band is found, whose position lies about midway between that of the two absorption bands of the unreduced hæmoglobin.

In strong solutions of reduced hæmoglobin less of the blue than of the red end of the spectrum is absorbed, and with concentrated solutions the blue rays may still pass, thus accounting for the difference in color between the arterial and venous blood, the former allowing the red and orange-yellow rays to pass, the latter the red and bluish-green rays; hence arterial blood appears scarlet, venous blood purple.

The oxygen which is removed from venous blood or from oxyhæmoglobin by exposure to a vacuum, or by the use of reducing agents, is not the oxygen which enters into the molecular constitution of hæmoglobin, but is a definite volume which is capable of entering into loose chemical combination with it.

If, now, such a solution of reduced hæmoglobin, or the crystals of reduced hæmoglobin, be exposed to the atmosphere, they then again absorb oxygen and now change to a reddish color, the amount of oxygen absorbed being again precisely similar to that which was given off to the vacuum.

The above phenomena serve to explain what occurs in the process of respiration. As the venous blood leaves the right ventricle, its hæmoglobin has already largely lost its oxygen by passing through the systemic capillaries, and is now mainly reduced hæmoglobin. It absorbs oxygen from the atmosphere through the walls of the pulmonary vesicles while passing through the pulmonary capillaries, and now becomes oxy-hæmoglobin and is now arterial blood.

As the arterial blood passes through the systemic capillaries, the oxygen of the oxyhæmoglobin is largely yielded up and hæmoglobin becomes reduced.

The mode in which the carbon dioxide is held in the blood does not admit of as ready demonstration as is the case with the oxygen. It is, however, clear that almost the total amount of carbon dioxide which may be extracted by the vacuum pump from the blood is held, in some way or other, in the blood-serum, for almost quite as much of this gas may be extracted from the serum as from the blood itself. The carbon dioxide is not, however, simply dissolved, for here also the degree of absorption of this gas by the blood is not governed by the same laws as would apply to its absorption by water.

When blood-serum is exposed to a vacuum, about 25 volumes per cent. of this gas is extracted, and this amount is spoken of as the loose carbon dioxide. If, now, an acid be added to the serum, about 5 volumes per cent. more are released, and it may therefore be concluded that this latter amount exists, in all probability, in the serum in the form of carbonates, and probably united with sodium.

The corpuscles also contain about 5 volumes per cent. of carbon dioxide; for, if the corpuscles separated from the serum be exposed to a vacuum, they also will yield this amount of carbon dioxide.

If, now, corpuscles and serum, from both of which gas has been separately removed by pumping, be together exposed to a vacuum, 5 per cent. again of carbon dioxide is given up, from which it would appear that the corpuscles in this experiment play the rôle of an acid; and it may be assumed that perhaps the hæmoglobin in its decomposition liberates an acid, which again sets free the combined carbon dioxide from the serum.

It is not by any means established as to in what manner the free carbon dioxide is held in the blood-serum. A certain portion of it is, without doubt, held in solution under the simple laws of absorption of

gases by liquids, and increases with the gaseous tension; while, on the other hand, a larger amount must be held in some form of chemical combination, since blood is capable of absorbing under equal pressures much more carbon dioxide than water.

On the other hand, it is also clear that this chemical combination must be a very loose one, since it is broken up by exposure to a vacuum. It is probable that part of this carbon dioxide is present in the serum as a bicarbonate of sodium,—a combination which, by reduced pressure, is readily broken up into sodium carbonate and free carbon dioxide. It is further possible that another part of this carbon dioxide may be loosely combined with a sodium biphosphate,—a salt which is likewise present in the blood-serum, and which has been shown to readily combine with carbon dioxide. It is, however, to be noted that this salt, sodium biphosphate, is solely present in considerable amounts in the blood of carnivora and omnivora, while only traces of it are present in the blood of herbivora, so that in the latter this combination cannot exist. It, in any case, seems evident that the red blood-corpuscles in some way govern the presence of this gas in the serum.

The nitrogen, which may be removed from the blood by exposure to a vacuum in from 1 to 3 volumes per cent., is without doubt simply held in solution by the serum, since water likewise is capable of absorbing this gas to the same amount.

The exchange which takes place between these gases in the blood and the atmospheric air in the lungs is governed almost purely by the simple physical laws of gaseous diffusion. As already mentioned, the air within the pulmonary vesicles is separated from the blood in the capillaries only by the delicate epithelial walls of the vesicles and the structureless walls of the capillaries. The oxygen of the blood, as already indicated, is loosely combined with the hæmoglobin. When reduced hæmoglobin is exposed to an atmosphere of oxygen it readily absorbs that gas, provided the tension of the oxygen in the surrounding medium be greater than the tension of the oxygen in combination with the hæmoglobin. When, therefore, the blood from the pulmonary arteries reaches the capillaries of the lungs a large part of the hæmoglobin there present exists in the form of reduced hæmoglobin, while the atmosphere within the pulmonary alveoli contains oxygen, perhaps in a lower tension than in the atmosphere, but at any rate in a higher tension than is present in the hæmoglobin. As a consequence, diffusion phenomena set in, the oxygen passing from the interior of the alveoli through the moist walls of the alveoli and blood-capillaries into the interior of the latter vessels, and there combining with the hæmoglobin. It may be assumed that the oxygen tension in the alveoli of the lungs amounts to about 10 per cent. The oxygen tension in the venous blood will,



as a rule, amount to about 3 per cent. This difference in pressure is, therefore, sufficient to explain the entrance of oxygen from the air in the pulmonary alveoli to the blood in the pulmonary capillaries. The laws of absorption of oxygen by the blood-corpuscles are, while partially dependent upon the differences in oxygen tension in the blood and in the capillaries, not solely dependent upon them; otherwise an increase in the oxygen tension in the atmosphere would cause a proportionate increase in the amount of oxygen absorbed, a decrease in the oxygen tension a diminution of the amount of this gas which enters in the blood. This is not, however, the fact, for it has been determined, as already stated, that but a limited quantity of oxygen is capable of combining with hæmoglobin. If the oxygen of the atmosphere be decreased the tension of this gas in the lungs will also be decreased, and, therefore, to a certain extent the blood will be insufficiently aerated; this will perhaps explain the dyspnoea which is so often noted in ascending to great heights, as to the tops of mountains, and in balloons.

As regards the escape of carbon dioxide from the blood in the capillaries of the pulmonary artery, we are perhaps warranted in assuming that they are governed purely by the laws of gaseous tensions; since we may assume that even although we do not know exactly what the tension of carbon dioxide in the pulmonary alveoli is, and although it must be greater than that in the expired air, it is, nevertheless, less than that of the venous blood.

The tension of carbon dioxide in the air of the alveoli has been placed at twenty-seven millimeters of mercury.

The tension of carbon dioxide in the blood in the right side of the heart has been placed at forty-one millimeters of mercury, or, in other words, fourteen millimeters higher than the tension in the alveoli. This difference will, in all probability, be sufficient to inaugurate phenomena of diffusion.

Thus, in passing through the pulmonary capillaries the venous blood yields up carbon dioxide and absorbs oxygen, and becomes converted from a dark-red venous blood into the bright red arterial blood.

The characteristics of arterial blood are preserved throughout the entire arterial system until the capillaries are reached, and when the capillaries have been traversed we find that again the arterial blood loses its characteristic properties and now becomes venous. In other words, in the capillaries a part of the oxygen disappears and is replaced by carbon dioxide. In the tissues, therefore, a process takes place which is exactly the reverse of that which has been described as occurring in the lungs. It may be assumed that the oxygen leaves the blood in the same manner as it enters in the pulmonary capillaries; in other words, in the tissues it becomes exposed to a surrounding medium whose gaseous tension in

oxygen is less than that of the arterial blood. As a consequence, the oxyhæmoglobin is broken up and yields a large part of its oxygen to the tissues, passing through the walls of the capillaries by diffusion, to be used up in the tissues in the processes of oxidation which are there continually taking place. One of the principal results of such oxidation processes is the formation of carbon dioxide, and here, again, we have phenomena of diffusion taking place between the tissues and capillaries. In the tissues the gaseous tension of carbon dioxide is higher than in the capillaries, and, as a consequence, by diffusion this gas leaves the tissues to enter the blood-serum. This process of gaseous interchange in the systemic capillaries may, therefore, be spoken of as internal respiration, and varies in intensity in different conditions of the system. Thus the interchange is more rapid and extensive in muscles during contraction than in muscles at rest. It is more active in secreting glands than in quiescent glands.

As to the subsequent fate of the oxygen after leaving the blood-vessels, but little can be positively said. It is probable that processes of oxidation occur in the tissues, and that these result in the formation of carbon dioxide, but it does not follow that the oxygen as it leaves the blood directly unites with the organic tissue-constituents, and is thus directly returned to the blood as carbon dioxide; for we know that various tissues removed from the body and placed in an atmosphere entirely devoid of oxygen will still produce carbon dioxide. It is, therefore, possible that the oxygen that leaves the blood-vessels is stored up in some combination or other in the tissues, and is then drawn upon as the needs of the tissues demand, finally to be returned to the blood as carbon dioxide.

5. THE NERVOUS MECHANISM OF RESPIRATION.—Although the muscles of respiration are red, striped, voluntary muscles, and although through an effort of will the rhythm, number, and depth of the respiratory movements may be greatly modified and changed, the act of respiration is to be regarded as an involuntary action. Although the breath may for a certain time be held and the movement of respiration completely interrupted, after but a very short interval, probably not more than between two and three minutes, in spite of the strongest effort of the will, an inspiration must be made. The fact that respiration persists in the absence of mental effort points further to the fact of the independence of respiration of the will. Thus, during sleep and in states of unconsciousness, in various diseases and as an effect of various drugs, respiration may be perfectly performed. So, also, in the lower animals the brain may be exposed and may be gradually removed from the cerebrum down to the base of the brain, and still respiration be unaffected, provided loss of blood or some other accident does not interfere with the lower portions of the central

nervous system. It has been pointed out that the mechanical operations of respiration require the associated action of a large number of different muscles, different in function and in locality. It has been mentioned that during respiration muscular movements occur in the face, neck, thorax, and abdomen, and it is found that the character of the contraction of these muscles is the same in each group. Thus, in gentle inspiration we notice a gentle contraction of the diaphragm, of the scalene muscles, the external intercostals, and the elevators of the ribs. In gentle expiration we notice but a gentle contraction of the abdominal muscles. The degree of contraction of each of these muscles in such a respiratory movement is identical. When any one muscle or group of muscles is the seat of an especially violent contraction, the normal rhythm of respiration is departed from. Again, in forced expiration the same state of affairs holds; the degree of contraction of each muscle is proportionate to that of all the other muscles concerned in producing the respiratory movement. These facts indicate, as in the case of other complex associated muscular movements, the domination of some part of the central nervous system. In the ease of respiration such a state of affairs will also be noted. In other words, the movements of respiration are controlled by a single co-ordinating centre, located in the medulla oblongata. The proof of this statement may be reached in quite a number of ways.

If one of the phrenic nerves is divided, the corresponding half of the diaphragm is paralyzed, and, although motions of inspiration still are possible, it will be noticed that the excursions of the non-paralyzed half of the diaphragm will be greater than when the phrenic nerve has not been cut, and that the share in inspiration borne by the other respiratory muscles will be more marked than is normally the case.

Section of both phrenic nerves emphasizes this point still further; the diaphragm is then completely paralyzed, but inspiration is accomplished solely by the muscles which elevate the ribs.

Again, if one or more of the intercostal nerves be divided the muscles supplied by those nerves will be paralyzed, and the act of inspiration will then be produced by calling in the aid of an increased degree of contraction of other inspiratory muscles.

If the spinal cord be divided below the level of the seventh cervical nerve, consequently below the origin of the phrenic nerves, all thoracic and abdominal movement will cease, but respiration will still be possible, and inspiration will be accomplished solely by the contraction of the diaphragm, while expiration will be dependent entirely upon the recoil of the elastic tissue of the lungs and thorax. In this state of affairs the transmission of impulses to the muscles of respiration, with the exception of the diaphragm, has been interrupted. The thorax will then be

quiescent, but that the respiratory centre, whose location we have assumed to be in the medulla, is still sending out its motor impulses is evidenced by the increased movements of the nostrils and glottis. If, now, the facial and laryngeal nerves be cut this movement will also cease.

These facts indicate that in some part of the central nervous system arise the motor impulses which are conducted to the muscles of respiration. As one after the other of the paths of communication between these centres and the muscles are interrupted, we find that one after the other these muscles become paralyzed.

It has been found, as already mentioned, that the brain may be removed down to the level of the medulla oblongata and still respiration take place, thus marking the upper limit of this centre. On the other hand, the spinal cord may be divided up to the calamus scriptorius, and through the movements of the face the evidence of the activity of the respiratory centre may still be made out. The respiratory centre, therefore, lies some place between these two points. Its exact locality has not been determined, but it is clear that it lies in the floor of the fourth ventricle, somewhat lower down than the vaso-motor centre, and nearer the tip of the calamus scriptorius. When this locality is injured, as by puncturing with a sharp-pointed instrument, all respiratory movements at once cease. The motions of the heart are, also, at once arrested from a simultaneous irritation of the cardio-inhibitory centre. This point, therefore, when injured causes instantaneous death, and was, consequently, termed by Flourens the vital centre, the *nœud vital*.

The action of this centre is automatic and is not reflex, though it may be influenced by afferent impulses coming through various sensory nerves. Thus, for example, a dash of cold water on the skin causes a deep inspiration by exalting the action of this centre through the conduction of impulses to it from the external integument.

Again, the activity of the respiratory centre may be influenced by impressions coming from above. Thus, the various emotions, which may be regarded as impulses originating in the cerebrum, also, are capable of modifying its activity. The respiratory centre, while not dependent, however, upon impulses coming through afferent nerves, is especially modified in activity by impulses traveling through the pneumogastric nerves; and though the pneumogastric nerves may be regarded as the principal paths of conduction of afferent impulses, modifying the activity of the respiratory centres, their integrity is not essential for the manifestation of the peculiar action of this ganglionic centre. This fact is demonstrated by the modifications produced in respiration by section of these nerves.

If one pneumogastric nerve be cut respiration becomes slower and

deeper, while the pauses between the respiratory movements are more prolonged. If both pneumogastric nerves are divided the respirations are still further slowed, the pauses are prolonged, and each respiratory movement is deeper than normal. If the quantity of air displaced in any given number of respiratory movements before and after section of these nerves be estimated, it will be found to be almost unchanged; in other words, the increased depth of the respiratory movements after section of the pneumogastric compensates for their decrease in frequency. The amount of carbon dioxide exhaled and oxygen absorbed from the pulmonary surfaces, therefore, remains unchanged.

If after section of the pneumogastrics the central end of one of the divided nerves be irritated, the rapidity of respiration will be increased. By carefully graduating the strength of stimulation the normal rhythm of respiration may be again almost exactly restored. If the irritation be gradually increased, the movements of respiration will increase in vigor until, finally, they will apparently run into each other, and respiration will then be arrested with the diaphragm in a condition of tetanic contraction. Respiration is thus stopped in the phase of extreme inspiration.

If the central end of the superior laryngeal nerve be stimulated with the faradic current the respiratory movements will be slowed, and with a powerful irritation will be arrested, the diaphragm being completely relaxed, and the thorax and lungs being in the condition seen in forced expiration. It would therefore appear that the trunks of the pneumogastric nerves are the paths of impulses traveling from the lungs, which, reaching the respiratory centre, tend to exalt its activity. The vagus may, therefore, be regarded as a stimulating nerve for this centre. The laryngeal nerves, on the other hand, may be regarded as inhibitory nerves of the respiratory centre, and, when stimulated, arrest respiration, the diaphragm being in a state of relaxation and the thorax contracted (Fig. 257).

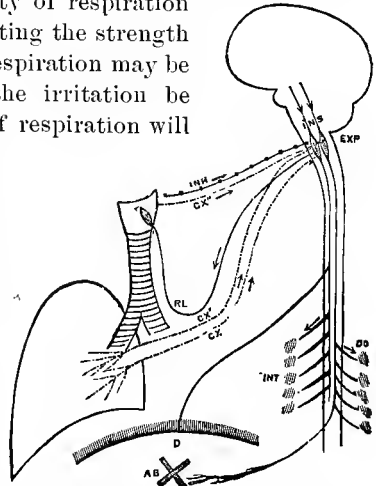

FIG. 257.—SCHEME OF THE CHIEF RESPIRATORY NERVES, AFTER RUTHERFORD. (Landois.)

INS, inspiratory, and EXP, expiratory centres—motor nerves are in smooth lines; expiratory motor nerves to abdominal muscles, AB; to muscles of back, DO; inspiratory motor nerves, phrenics to the diaphragm, D; INT, intercostal nerves; RL, recurrent laryngeal; CX, pulmonary fibres of vagus that excite inspiratory centre; CX', pulmonary fibres that excite expiratory centre; CX'', fibres of superior laryngeal that excite expiratory centre; INH, fibres of superior laryngeal that inhibit the inspiratory centre.

While the respiratory centre is thus capable of being modified by impulses coming from these nerves, its degree of activity is, above all,

mainly dependent upon the character of blood supplied to it. Deficient oxygenation of the blood acts as a stimulus to this centre and causes the respiratory movements to become quicker as well as deeper, while expiration becomes especially increased in power. In a greater degree the deprivation of oxygen from the blood appears to cause the extension of the stimulus from the respiratory centre to other adjoining motor centres, and we then find that not only the ordinary muscles of respiration are thrown into violent action, but that every muscle in the body which is connected with respiration is thrown into forced contraction. Such a state is described as dyspnoea.

On the other hand, the blood may become overcharged with oxygen, as by causing an animal to breathe an atmosphere overcharged with this gas, or by making forced artificial respiration in one of the lower animals. The blood then becomes saturated with oxyhæmoglobin. The stimulus of the respiratory centre is thus removed, and, as a consequence, we find that in such an animal the motions of respiration cease, and the animal may remain perfectly quiescent without breathing for a number of minutes until the blood has freed itself from the excess of oxygen. These facts show that a want of oxygen in the blood is a natural stimulus to the respiratory centre. Blood which is poor in oxygen is also to be regarded as rich in carbon dioxide. That it is the poverty of oxygen and not the excess of carbon dioxide which brings this centre into activity is shown by the fact that if an animal be caused to breathe an atmosphere deprived of oxygen, or one which will not interfere with the removal of carbon dioxide, the phenomena of dyspnoea will still appear. Thus, an animal placed in an atmosphere of hydrogen will not be prevented from removing carbon dioxide from its venous blood, but will, of course, be shut off from all supply of fresh oxygen. In such an animal the phenomena of dyspnoea rapidly appear. This action on the respiratory centre is produced directly, and not through the mediation of any nerves, for even when the spinal cord is cut and the supply of oxygen from the medulla shut off the phenomena of dyspnoea are evidenced in the spasmodic contractions of the nostrils and glottis, even though their expression through the muscles of respiration is rendered impossible. So, also, ligating the vertebral and carotid arteries produces the same result by decreasing the supply of oxygenated blood brought to this centre. Again, if the blood distributed to the respiratory centre be heated above normal, dyspnoea is also produced, from the fact that the increased temperature of the blood leads to an increased activity of the chemical processes in the body, and so to the more rapid exhaustion of oxygen. Here, also, we find dyspnoea produced through the shutting off of the supply of oxygen from this centre.

As has been mentioned, if the supply of oxygen be interfered with,

either through some mechanical obstruction of the air-passages or through the reduction of the amount of oxygen in the air, as by breathing in a confined space, normal respiration gradually is replaced by dyspnœa, in which simply all the accessory muscles of respiration are brought into play, and respiration then, instead of being an almost imperceptible involuntary movement, now becomes convulsive. If this interference with the normal oxygenation of the blood continues, the animal then passes into a state of asphyxia, which proves rapidly fatal.

When the reduction of oxygen in the blood supplied to the respiratory centre becomes decreased, the overexcitation of the respiratory centre becomes evident in the increased violence of the respiratory movements; expiration becomes gradually convulsive, until often every muscle which may react on the thorax is brought into play. Very soon almost all of the muscles of the body are implicated and the animal is then in a state of active convulsions. It would appear that these convulsions are due simply to the extension of the activity of the respiratory centre to other closely associated centres in the medulla. For we notice that first the ordinary respiratory muscles contract with greater vigor, we then have the accessory muscles brought into play, and eventually the entire muscular system of the body; and although a convulsive centre in the medulla is sometimes spoken of, it is evident that this centre must be closely connected with the respiratory centre. After a variable period the violent muscular contractions suddenly disappear, from the exhaustion of the nervous system, the pupils are then found to be dilated to their utmost and are unaffected by light, and the cornea insensible to the touch. All the muscles of the body are now in a condition of relaxation; and although the respiratory movements have not entirely ceased, they are, however, far between, are gasping, accompanied by twitching of other muscles, especially of the face, and the intervals between them become gradually increased; the rhythm of the respiratory movements becoming irregular, each inspiration shallower and shallower, again implicating the other muscles of the body, with the head thrown back and the mouth open, the face drawn and the nostrils dilated, the last breath is taken in.

It is thus evident that the phenomena resulting from the deprivation of oxygen may be divided into three different stages:—

First, a stage of dyspnœa, characterized by an extraordinary muscular effort in the muscles of respiration, expiration being especially convulsive. Second, an extension of the convulsive muscular contractions to all the other muscles of the body, and therefore characterized by general convulsions, while the final stage is one of exhaustion, in which the inspirations become slower and slower, more and more shallow, and are finally arrested.

. The duration of asphyxia varies considerably in different animals and in the same animal under different circumstances. As a rule, young animals will bear a longer deprivation of fresh air than adults. It has thus been stated that while a full-grown dog will rarely recover from an immersion in water over one and one-half minutes, a puppy has been known to recover after an immersion of fifty minutes. This is evidently to be explained by the fact that in younger animals the processes of tissue change are less active than in adults, and, as a consequence, the demand on the oxygen in the blood is less.

During asphyxia the circulation is the seat of various departures from normal.

In the stage of dyspnoea and convulsions the blood pressure is reduced, while in the final stage it rapidly falls far below normal, until at the period of death the blood pressure does not exceed the atmospheric pressure.

The heart also is modified in its activity. At first it beats more rapidly than normal and then is slowed, but each pulsation is greatly increased in force. As a rule, the heart continues to beat for some time after the final cessation of respiration. During the first and second stages of asphyxia, the great increase in blood pressure from the contraction of the arterioles leads to great increase in the resistance met with by the heart in emptying itself. We find, therefore, if the chest of an animal is opened during asphyxia, that the right side of the heart especially is gorged with blood. The lungs and the pulmonary vessels are overfilled and distended, and, as a consequence, blood collects in the venous system, so accounting for the cyanosed appearance seen on all external surfaces, and so characteristic of asphyxia.

*Modified Respiratory Movements.*—In addition to the normal respiratory rhythm, various modifications of the respiratory movement are often noticed. Many are involuntary, and yet nearly all of them may be reproduced by a direct effort of the will.

Sighing is produced by a long, deep inspiration, air being inhaled through the nose and the inspiration followed by a number of shorter expirations.

Yawning is accomplished by a deep inspiration through the mouth, and is accompanied by a depression of the lower jaw and elevation of the shoulders.

Hiccough is produced by a sudden contraction of the diaphragm and a sudden closure of the glottis, so arresting the entrance of air into the lungs, and, by the striking of the column of air against the closed vocal cords, producing the sound characteristic of this phenomenon. Hiccough is, as a rule, due to the stimulation of the gastric branches of the pneumogastric, especially in some disturbance of digestion.



Sobbing is produced by a series of similar convulsive inspirations, in which the glottis is closed earlier than in hiccoughing, and no air, consequently, enters the chest.

The foregoing are the principal modifications of the inspiratory phase of the respiratory rhythm.

The following owe their characteristics mostly to some modification of expiration :—

Coughing is produced by a long, deep inspiration, after which the glottis becomes firmly closed. A forced expiration is then made through the violent contraction of the abdominal muscles and serves to force open the glottis, the vibration of the vocal cords producing the characteristic sound. The starting point of the act of coughing may be found in the contact of any foreign body with the mucous membrane of the air-passages, the impression being conducted through the superior laryngeal nerve. Other parts of the body may, however, also serve as the starting point to the act of coughing. Thus, stimulation of the auricular branch of the pneumogastric, as is often the case in numerous ear diseases, may produce coughing, as may the stimulation of other nerves.

Sneezing is produced by a mechanism closely similar to that of coughing, with the exception that the expelled column of air passes through the nose instead of the mouth.

The point of origin of the afferent impulses is usually found in the mucous membrane of the nose and is conducted through the fifth pair of nerves. In certain individuals the optic nerve may also be the path over which the afferent impulses travel to originate the act of sneezing.

Laughing consists of a long inspiration followed by a series of short expirations, during which the glottis is open and the vocal cords thrown into vibration by the movement of the column of air.

Crying is produced by the same mechanism as laughing, the only difference being in the facial expression. As a consequence, laughing frequently verges into crying, and the reverse, and the two are frequently indistinguishable.

**6. INFLUENCE OF THE RESPIRATION ON THE CIRCULATION.**—In the examination of a tracing obtained in a blood-pressure experiment, in addition to the undulations caused by the variations in the blood pressure due to each individual heart contraction, a larger series of waves, each composed of a number of cardiac pulsations, may be noticed. These undulations have already been referred to as being due to the influence of the respiratory movements on arterial blood pressure. Their mode of production is now to be considered. Roughly speaking, it may be stated that during every inspiration the blood pressure falls, and during every expiration it rises. This statement is, however, not absolutely correct, but requires some slight modification.

The large vessels of the thoracic cavity vary in capacity according to the degree of pressure to which their walls are subjected. Naturally, the veins, possessing thinner and less rigid walls, are more influenced by external pressure than are the arteries. When the thorax becomes expanded in inspiration, naturally a negative pressure is likewise exerted on the walls of the veins, and they consequently tend to expand. As a consequence the flow of blood toward the heart is accelerated, and, as has been already indicated, the pressure within the veins in the neighborhood of the great vessels at the base of the heart becomes negative during inspiration. If an opening be made in a vein, as, for example, at the root of the neck, at each inspiratory movement there is a tendency for air to enter the venous trunks, forming one of the serious sources of danger in wounds of the large veins. As a consequence of the greater increase in the venous blood-current during inspiration a larger quantity of blood enters the right auricle.

Further, if an opening be made in the skull of an animal, a distinct rate of pulsation, which is synchronous with the respiratory movements, may be noticed, in addition to that due to the arterial pulsation. At each inspiration the brain sinks, and at each expiration it rises. The production of this phenomenon is evidently due, in the first place, to facilitation of the flow of blood from the brain in inspiration and, in the second place, to retardation in expiration, since it disappears on ligature of the large arteries going to the brain or when a free opening is made in the venous sinuses. During inspiration, therefore, a larger quantity of blood enters the right side of the heart, and, as a consequence, a larger quantity escapes from the left ventricle, more blood escapes into the aorta, and the blood pressure is increased.

During expiration opposite conditions obtain. The pressure on the walls of the great veins of the thorax is now increased by the reduction in the volume of the thorax, and entrance of blood into the thorax is hindered, less blood enters the heart, less is thrown out by the left ventricle, and, as a consequence, arterial pressure falls.

This state of affairs is, however, not quite so simple as this would seem to indicate. In the first place, the effect of the respiratory movements on the arteries must be different from that on the veins, for while inspiration tends to facilitate the flow of blood in the veins toward the thorax, it likewise tends to hinder the escape of blood in the arteries from the thorax; while at the same time a negative pressure is exerted not only on the veins but on the arteries, and, therefore, tends to produce expansion of the arterial trunks in the same way as expansion of the veins is produced. Therefore, the effect of inspiration on the great arterial trunks would be to reduce blood pressure. But from the fact that, as already indicated, the walls of the arteries are less yielding than those

of the veins, the effect of inspiration in producing expansion of the blood-vessels is less marked on the arteries than on the veins, and, as a consequence, the reduction of blood pressure from arterial expansion is less marked than the increase of blood pressure from venous expansion. During expiration, on the other hand, increase of pressure without the aortic arch acts, of course, in a similar manner to reduction of the calibre of the aorta, and so would lead to an increase in the blood pressure. This reduction is, however, likewise less than the compensating reduction in the volume of the veins; so that although expiration would therefore tend to increase arterial pressure, it is more than compensated for by the reduced amount of blood brought to the heart through the veins.

If, however, a simultaneous tracing be made of the blood pressure and of the respiratory movements, it will be seen that the increase of blood pressure does not exactly coincide with the commencement of inspiration, nor is the fall of blood pressure synchronous exactly with expiration; but it will be found that at the commencement of inspiration blood pressure is falling, while it begins to rise before inspiration is completed, and does not attain its maximum until after expiration has commenced. Then, before expiration is completed, the fall again commences, and continues during the first part of the succeeding inspiration. These facts show that, in addition to the mere mechanical changes in the blood supply produced by the varying pressure in inspiration and expiration, some other causes are at work.

The respiratory undulations in the blood pressure are due, in part, to varying degrees of stimulation of the vaso-motor centre. In other words, the degree of tonicity of the blood-vessel walls is subject to rhythmical variations, these variations depending upon coincident changes in the degree of stimulation of the vaso-motor centre, to which are added the changes produced in a purely mechanical way by alterations in the intra-thoracic pressure.

If the pulsations be counted in the ascending and descending phases of the blood pressure, it will be noticed that the pulse beats faster during increase of pressure than where it is decreasing. This variation in the pulse-rate is especially marked in the dog, and is due to changes in the activity of the cardio-inhibitory centre in the medulla oblongata, as is proven by the fact that section of both vagi causes the difference in pulsation to disappear.

It is therefore evident that the vaso-motor, the respiratory, and the cardio-inhibitory centres to a certain extent act in unison.

The state of affairs is different in cases where artificial respiration is carried on, as in curarized dogs, when the mechanical causes at work must necessarily be reversed. If a dog be curarized and subjected to artificial respiration, and tracings of the intra-thoracic pressure and of

the blood pressure be simultaneously made, the respiratory undulations, although in a modified form, will still be present. In this case the conditions are exactly reversed, for in inspiration air is forced into the lungs instead of being aspirated<sup>o</sup>, so that the pressure in the thorax is increased during inspiration instead of being decreased, as in normal inspiration. So that we are compelled to attribute the greatest influence in the production of these respiratory undulations to varying changes in the vasomotor centres rather than to the mechanical causes producing changes in the intra-thoracic pressure.

Another cause which may be concerned in the production of these respiratory undulations is also, to a certain extent, mechanical, and depends upon varying pressures within the abdomen. As the diaphragm descends in inspiration, the abdominal contents, including the abdominal vessels, are pressed upon, and, as a consequence, the blood pressure must be increased. The reverse naturally obtains during expiration, and it is found that section of both phrenic nerves and opening of the abdominal cavity causes an almost entire disappearance of the respiratory undulations; so that, therefore, the mechanical changes in the abdominal pressure are likewise, to a certain extent, concerned in the production of the respiratory undulations.

## SECTION IX.

### THE MAMMARY SECRETION.

THE milk is the secretion of the mammary glands of the females of the mammalian group, and is poured out, as a rule, only in the last stages of pregnancy and after the birth. Sometimes, especially in goats, the secretion of milk is formed by the rudimentary glands of the male. In many cases the mammary glands of newly-born infants of both sexes also pour out a scanty secretion, which is, probably, closely similar in composition to milk, although it has been but slightly investigated. This secretion commences usually three or four days after the birth, increases up to the eighth day, remains a few days stationary, and then commences to decrease, and by the end of the first month has usually entirely disappeared.

The mammary glands of various animals of the mammalian type also frequently pour out a secretion immediately after birth. These facts, as well as the morphological characters of the mammary gland, indicate that they are exceptionally developed sebaceous glands; the close similarity in composition of the milk and the secretion of the sebaceous glands of the skin also supports this view.

The following table represents the composition of this secretion from the rudimentary mammary gland:—

	Newly-Born Infant.	Five-weeks- old Foal.
Water, . . . . .	95.705	93.10
Solids, . . . . .	4.295	6.90
Casein, . . . . .	0.557	0.50
Albumen, . . . . .	0.490	1.02
Fat, . . . . .	1.456	(?)
Milk-sugar, . . . . .	0.956	3.67
Inorganic salts, . . . . .	0.826	0.44

Before and shortly after delivery pregnant females secrete a fluid from their mammary glands which differs considerably from that of the later secretion. It is termed colostrum.

Colostrum is an opaque, yellowish fluid, containing a large amount of the so-called colostrum cells (true glandular cells in different stages of fatty degeneration), few milk-globules, a large amount of albumen, little or no casein, and but little fat, milk-sugar, and salts. On account of its large percentage of albumen, it coagulates when heated, differing in this respect from milk; in fact, colostrum when first secreted closely

resembles blood-serum, with the addition of colostrum corpuscles. Gradually, however, the colostrum secretion passes into a milk secretion, albumen and colostrum corpuscles become reduced in amount, fat, casein, sugar, and milk-globules increase. The specific gravity of colostrum varies from 1040 to 1060, being higher immediately after delivery and falling as it gives place to a true milk secretion. Thus, according to Quevenne, the specific gravity of colostrum of the cow on the first day after calving is 1060; on the second, 1053; on the third, 1035; on the fourth, 1040; on the fifth, 1027. The reaction of colostrum is ordinarily alkaline and becomes acid on standing. Immediately after calving the colostrum of the cow contains 8.5 per cent. albumen, after one day 6.4 per cent., after three days 3.4 per cent., after seven days 1.9 per cent., and after twenty-one days 0.6 per cent. On an average, colostrum may be said to have the following composition:—

Water,	78.7 per cent.
Casein,	7.3 “
Albumen,	7.5 “
Fats,	4.0 “
Sugar,	1.5 “
Salts,	1.0 “

The so-called uterine milk is a white or rose-colored, creamy, alkaline fluid, with specific gravity of 1030 to 1040, and is obtained by compression of the placental cotyledons of ruminant animals. It rapidly becomes acid and undergoes spontaneous coagulation. It contains fatty particles, free nuclei, and epithelial cells. The following table represents its composition in the cow:—

Water,	87.91 per cent.
Solids,	12.09 “
Fats,	1.23 “
Albumen cells,	10.40 “
Albuminates,	0.16 “
Ash,	0.37 “

1. THE PHYSICAL AND CHEMICAL PROPERTIES OF MILK.—Milk is an opaque fluid, with a sweetish taste and an opalescent bluish tint, in thin layers, and a characteristic odor due to the volatile substances derived from the secretions of the cutaneous glands.

Milk is not a homogeneous fluid, but is an emulsion, which consists of the so-called milk-globules suspended in milk-plasma, the latter consisting of a solution of albumen, sugar, and salts. Examined under the microscope the milk-globules appear as highly refractive drops of oil floating in the clear fluid (Figs. 258 and 259).

The size of these globules varies from 0.01 to 0.03 millimeter.

In colostrum the corpuscles are much larger than in milk, and are capable of amœboid movements. The milk-corpuscles consist almost

entirely of fat, and are composed of combinations of glycerin with oleic, palmitic, and stearic acids. They are surrounded by a thin layer of casein, not in the form of a solid deposition, but the casein probably exists in a condition of high imbibition rather than in a state of solidity or of true solution. The layer of casein cannot be regarded as constituting a membrane, although it, to a certain extent, fulfills the same function. If acetic acid is added to a preparation of milk, under the microscope it will be seen that the caseous envelope is dissolved and the oil-globules run together and form irregular masses of oil.

When cows' milk is shaken up with caustic potash and then agitated with ether the oil passes into solution in the ether. The previous subjection to the action of caustic potash is, however, essential, since ether will not dissolve the oil from cows' milk unless the casein envelopes be previously dissolved by acetic acid or potash.

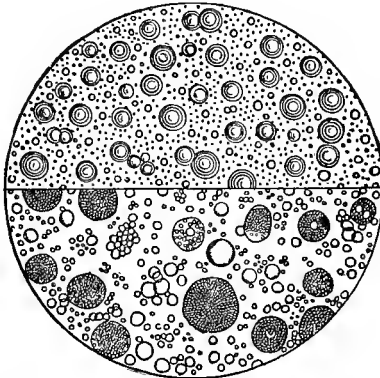

FIG. 258.—MICROSCOPIC APPEARANCE OF MILK AND COLOSTRUM. (*Landois.*)  
The upper half of the figure represents milk; the lower half colostrum.

If milk be allowed to stand for some time the oil-globules, which in freshly secreted milk are uniformly distributed through the milk, now rise to the surface and form a layer largely composed of fat, or the so-called cream.

The reaction of freshly secreted milk is alkaline in the herbivora and in the human female, while that of the carnivora is acid.

The milk of herbivora frequently will exhibit both an alkaline and an acid reaction, due to the presence of an acid sodium phosphate ( $H_2NAPO_4$ ) and of an alkaline disodic phosphate ( $NA_2HPO_4$ ). Such a reaction is spoken of as amphioter.

When milk is allowed to stand, the alkaline reaction, when present, gives place to an acid reaction, which is due to the fermentation of the milk-sugar and its conversion into lactic acid. When the cream is

removed from milk the skimmed milk is less opaque and white, while the edges in contact with the vessel have a distinct bluish tint.

The specific gravity of milk varies from 1018 to 1040. Cows' milk, when pure, may vary between sp. gr. 1028 and 1034, usually increasing from the first to the eighth month of lactation from 1031 to 1039.

In composition milk consists of solids partly dissolved and partly suspended in a fluid plasma, the amount varying from 12 to 13 per cent. Of these solids, 3 to 6 per cent. is represented by the fats, 9.25 per cent. by the other solids.

In composition, milk is composed of 85 to 90 per cent. water, casein, albumen, fat, milk-sugar, lecithin, and salts, with carbon dioxide,

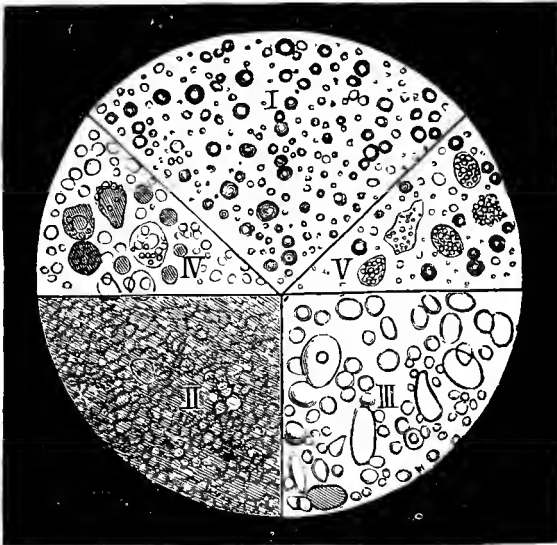

FIG. 259.—MICROSCOPIC APPEARANCES OF MILK, I; CREAM, II; BUTTER, III; COLOSTRUM OF MARE, IV; AND COLOSTRUM OF COW, V. (*Thanhoffer.*)

oxygen and nitrogen gases, urea, and various accidental constituents, such as lactic acid after milk fermentation, hæmatin, bile coloring-matters, and mucin. It often serves to eliminate various substances such as drugs, among which may be mentioned potassium iodide, iodine, salts of various metals, the oil of garlic, and various other bodies. When filtered through animal membrane or porous-clay filters, the milk-plasma is obtained as a clear, slightly opalescent fluid, which contains casein, serum-albumen, peptone, milk-sugar, salts—in fact, all the constituents of milk, with the exception of the oil-globules and a considerable portion of the casein, the amount of the latter which is kept back being greatly increased when a fresh animal membrane is used as a filter.



The following tables represent various analyses of this secretion in different animals:—

I. COMPOSITION OF THE MILK OF DIFFERENT ANIMALS. (AFTER GORUP-BESANEZ, LIEBERMANN, GAUTIER, ETC.)

CONSTITUENTS.	Woman.				Ass.	Cow.	Goat.	Sheep.	Mare.
				Colostrum.					
Water,	86.27	88.91	87.77	84.08	90.70	86.56	86.76	83.30	82.84
Solids,	13.72	11.09	12.23	15.92	19.30	13.44	13.24	16.69	17.16
Casein, }	2.95	3.92	2.34	3.23	1.70	{ 3.50	{ 2.92	5.73	1.64
Albumen, }						{ 0.58	{ 1.31		
Butter, . . .	5.37	2.67	3.68	5.78	1.55	4.03	4.48	6.05	6.87
Milk-sugar, . . .	5.13	4.36	5.55	6.51	5.80	4.60	3.91	3.96	8.65
Inorganic salts,	0.22	0.14	0.23	0.35	0.50	0.73	0.62	0.68	

II.

In 100 Parts.	Cow.	Goat.	Sheep.	Ass.	Mare.	Sow.	Woman.
Water, . . .	85.7	86.4	84.0	91.0	82.8	82.4	88.8
Solids, . . .	14.3	13.6	16.0	9.0	17.2	17.6	11.2
Casein, . . .	4.8	3.3	5.3	2.0	1.6	6.1	3.5
Albumen, . . .	0.6	1.2					
Fats, . . .	4.3	4.4	5.4	1.3	6.9	6.4	3.5
Sugar, . . .	4.0	4.0	4.1	5.7	8.7	{ 4.0	4.0
Salts, . . .	0.6	0.7	0.7			{ 1.1	0.2

Asses' milk is nearest in composition to women's milk; cows' milk has one-half more fat and almost one-half more albuminoids.

III. THE ASH OF MILK IN 100 PARTS.

	WOMEN'S MILK. (Wildenstein.)	COWS' MILK.	
		(Weber.)	(Haidlen.)
Sodium, . . .	4.21	6.38	8.27
Potassium, . . .	31.59	24.71	15.42
Chlorine, . . .	19.06	14.39	16.96
Calcium, . . .	18.78	17.31	56.52
Magnesium, . . .	0.87	1.90	
Phosphoric acid, . . .	19.00	29.13	0.62
Sulphuric acid, . . .	2.64	1.15	
Ferric oxide, . . .	0.10	0.33	
Silica, . . . . .	trace	0.09	

## IV. THE RELATIVE VALUE OF DIFFERENT KINDS OF MILK.

	Water.	Casein and Albumen.	Butter.	Sugar and Salts.
Mares' milk, .	91.15	1.03	1.27	6.12
Asses' " .	89.01	3.57	1.85	5.57
Women's milk,	87.24	2.88	3.68	5.78
Goats' " .	86.85	3.79	4.34	3.78
Cows' " .	84.28	4.35	6.47	4.34
Sheep's " .	83.30	5.73	6.05	3.96

## V. SOLIDS IN A PINT OF MILK.

Nitrogenous constituents,	23.9 grammes.
Fatty " "	22.7 "
Saccharine " "	30.3 "
Salts,	4.0 "

2. CASEIN AND MILK COAGULATION.—Casein is a proteid body of an acid reaction which is scarcely soluble in water but soluble in dilute acids and alkalis. In milk its solution is rendered possible by its combination with soluble alkali albuminates and through the presence of calcium phosphate. In amount it varies from 3 to 5 per cent., the relative proportions of casein and albumen being from 1.87 per cent. to 4.68 per cent. of the former and from 0.60 per cent. to 1.77 per cent. of the latter.

Casein, although closely similar in composition to alkali albumen, is not identical with it, but is probably to be regarded as a combination of alkali albuminate and nuclein. Casein may be obtained from milk by dilution with four times its volume of water, the addition of dilute acetic acid (0.1 per cent.) until a precipitate begins to appear, then passing a current of carbonic acid gas, filtering, and washing the precipitate with water, alcohol, and ether.

Casein may also be obtained from milk by the addition of magnesium sulphate to saturation.

When freed by ether from fats after its preparation by the latter process and dissolved in water, casein is a snow-white powder and in solution rotates yellow light eighty degrees to the left; in dilute alkaline solution, seventy-six degrees to the left; in strong alkaline solution, ninety-one degrees to the left; and in dilute hydrochloric acid, eighty-seven degrees to the left. It leaves no ash on incineration.

When milk is boiled the serum-albumen of milk becomes coagulated, while the skim formed is due to the deposition of a thin pellicle of casein due to evaporation, and which is renewed as fast as it is removed.

The coagulation of milk depends upon the precipitation of casein. Everything, therefore, which causes casein to become insoluble causes coagulation of milk. Such agents are acids, rennet, tannin, alcohol, and mineral salts.

Milk is coagulated by all acids. Several, especially acetic acid in excess, again dissolve the precipitate of casein. Casein is precipitated by acids only when a certain degree of acidity is reached, since alkaline phosphates must be first neutralized; if the alkaline phosphates are removed, even carbon dioxide is then capable of precipitating casein. The spontaneous coagulation of milk is produced by the development of lactic acid, which is formed from milk-sugar in the milk by the action of bacteria introduced from without or by the action of the lactic acid ferment which appears to be present in milk. In this process the neutral alkaline phosphate is converted into acid phosphate. The casein is separated from its combination with calcium phosphate and is precipitated, the sugar being decomposed into lactic acid and carbon dioxide. When milk coagulates spontaneously, or, in other words, curdles, it separates into a tough, jelly-like substance or curd, which consists of the insoluble casein and fat, floating in an opalescent acid fluid, or whey. The whey contains the greater part of the salts of the milk, the lactic acid, the undecomposed milk-sugar, and certain amounts of fat and the albuminoids. That the spontaneous curdling of milk is due to the action of the ferment contained itself in milk (which decomposes the milk-sugar into lactic acid) is proved by the fact that boiling greatly retards the spontaneous coagulation, evidently through the destruction of this ferment. This lactic acid ferment may be precipitated from milk by the addition of an excess of alcohol. If the ferment is then dissolved in water and added to solutions of milk-sugar it will produce rapid fermentation. The action of the milk-curdling ferment, as pointed out in the chapters on Digestion, is very different. Here, the casein is rendered insoluble by the action of the rennet ferment, even in alkaline fluids and without at all calling in the aid of lactic acid. The salts in milk, especially the calcic phosphate, are essential to the action of milk-curdling ferment; for, when milk is subjected to dialysis, rennet is then rendered incapable of producing coagulation.

Spontaneous coagulation of milk may be prevented by the addition of sodic carbonate, boracic or salicylic acids. So, also, the addition of one drop of the ethereal oil of mustard to twenty cubic centimeters of milk will likewise preserve its fluid condition.

Colostrum, sows' milk, and the milk of carnivora coagulate when heated. Boiled milk coagulates spontaneously only with difficulty, and is also more difficult to coagulate with rennet, but when acidulated the casein coagulates even more readily than in fresh milk.

A high temperature facilitates both forms of coagulation. Milk which has become acid, but which is still fluid, will coagulate when heated.

In addition to casein, milk contains other albuminoids, one of which

in all of its characteristics closely resembles serum-albumen. It is present in about 0.5 per cent., though in colostrum it is in much larger percentage. It is there present in about 15 per cent., but rapidly decreases for about four weeks, when it reaches its average percentage of 0.5 per cent.

When the plasma of milk is slightly acidulated and boiled it coagulates between 70° and 80° C. Peptone is also present in small amounts as a transudation from the blood.

3. MILK-SUGAR.—Milk-sugar is an animal carbohydrate found only in milk; its average percentage is 4.5 per cent., varying from 3 to 7 per cent. Of all the constituents of the milk the milk-sugar is least influenced by external conditions. It is found dissolved in milk-serum and in whey, whether after the spontaneous coagulation of the milk (acid whey) or after the action of rennet (sweet whey). It may be obtained by coagulating milk and evaporating the whey until crystals form. It occurs with one molecule of water in rhombic prisms soluble in from five to six parts of cold water and in three parts of boiling water. It is, therefore, very insoluble in comparison with the other forms of sugar. It is only slightly soluble in alcohol and water, and is not readily crystallizable.

Its formula may be placed at  $C_6H_{12}O_6$ . Heated up to 100° C. it loses some of its water, and may thus be represented by the formula  $C_{12}H_{22}O_{11}$ .

The specific rotation of milk-sugar containing water of crystallization is + 52.53° at 20° C.; anhydrous milk-sugar = + 81.3°. When warmed with alkalies it becomes brown, like dextrose (Moore's test), and likewise reduces Fehling's solution.

The milk-sugar of the human female, the cow, and the goat agree in their chemical characteristics, their form of crystallization, and their action on polarized light.

The spontaneous coagulation of milk is due to the formation of lactic acid from milk-sugar, one molecule of milk-sugar forming four molecules of lactic acid. The formula may be represented as follows:—

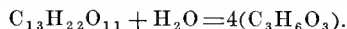

When lactic acid forms, it unites with the alkaline phosphates to form lactates of the alkalies and acid salts, and coagulation only occurs when all the alkaline phosphates have been converted into acid salts. A slight further development of lactic acid is then sufficient to cause coagulation.

If two glasses, one containing milk and the other a pure solution of milk-sugar, are subjected to the same conditions, after a few days the former will contain so much lactic acid that the milk will be coagulated, while not the slightest trace of acidity will be found in the milk-sugar

solution. This proves that the milk contains a ferment which is capable of splitting up milk-sugar into lactic acid. Such a ferment is widely distributed in the animal body. It may be often extracted from the gastric mucous membrane, and is entirely distinct from pepsin or the milk-curdling ferment, since it preserves its action even after the other ferments are destroyed by dilute caustic soda. The ferment may be obtained from milk after dialysis by precipitation with alcohol, and, after drying, dissolving the precipitate in water. Such a precipitate will coagulate milk and will cause the development of lactic acid in solutions of milk-sugar.

This ferment has a neutral reaction and is soluble in glycerin. It is destroyed by boiling, and appears to regain its activity when treated with oxygen. This would indicate that it is a ferment generator and not a true ferment, and explains why boiled milk may be kept longer than unboiled; while the fact that even boiled milk will ultimately coagulate is to be attributed to the subsequent development of the ferment through the action of the air.

Increase of temperature increases the activity of the ferment. Milk-sugar is not directly fermentable; that is, it cannot be directly converted into alcohol, though by the action of dilute sulphuric or hydrochloric acids it may be partly transformed into a fermentable lactic acid. This process is concerned in the manufacture of koumiss from mares' milk, which contains a large amount of sugar. A similar fermented liquid may be obtained from cows' milk through the action of the yeast-plant.

4. FAT AND CREAM.—Fat is present in milk in the form of minute globules, the average percentage being 3 to  $3\frac{1}{2}$  per cent., although it may vary from  $2\frac{1}{2}$  to  $5\frac{1}{2}$  per cent.

The following fatty acids have been found in milk: Butyric, caproic, caprylic, caprinic, myristic, palmitic, stearic, and oleic. The percentages of palmitic, oleic, and stearic acids vary. So the melting point of butter also varies, as does, also, its specific gravity. Normally, the melting point varies from  $32^{\circ}$  to  $37.5^{\circ}$  C.

Cows' butter contains about 68 per cent. palmitin, 30 per cent. olein, and 2 per cent. other fats, the solid fats apparently being more abundant in winter than in summer. The butter may be separated from milk by mechanical agitation (churning), the enveloping layers of casein being thus ruptured. It was formerly supposed that the fatty globule of milk had a solid envelope, because the fat does not pass into solution in ether unless caustic potash had been previously added. At most, however, we may assume that the fat is surrounded by an envelope of fluid casein, rendered more consistent here than elsewhere by the molecular attraction exerted by the fat-globules. Casein is not present in the milk in the form of a true solution, but rather in a high degree of

imbibition; so the effect of caustic potash is to enable the casein to pass into solution, and so render the oil accessible to ether. The absence of any solid envelope of the oil-globule is proved by the absence of any such formation after mechanically breaking up the oil-globules, while the proof of the fact of non-solution of casein in the milk is found in the fact that when milk is filtered through porous earthenware scarcely any casein passes through, while the other albuminoids which are really in solution do so pass. Casein, therefore, in milk acts like the gum around the oil-globules in an artificial mucilage emulsion.

On account of the lighter specific gravity, when milk stands the oil-globules rise to the top and, accompanied by varying amounts of the other constituents of the milk, constitute the cream; the largest rise first, while the smaller ones remain suspended in the body of the milk. The ascent of the cream is the more rapid the smaller the distance the fat-globules have to traverse. Hence, cream is formed more rapidly in broad, shallow vessels than in tall, narrow ones. Unless the temperature of the milk is constant, currents are set up in the milk from the differences of temperature, and the formation of cream is delayed until the entire volume of milk and the external medium are of the same temperature. Hence, shallow metal pans, by leading to a rapid equalization of temperatures, are usually employed for the separation of the cream. As the milk has a greater volume when warm than when cold, the cream will contain less serum when the molecules of the fluid are further separated from each other. So cream formed from warm milk has a higher percentage of fat in a small volume than cream formed from cold milk, and the higher the temperature at which the formation of cream takes place the smaller the amount of fat left in the skimmed milk.

If the cream has been removed from milk by means of the centrifugal machine the separation is much more complete (often only 0.1 per cent. of fat remaining in the milk), while the milk remains sweet instead of becoming sour, as ordinarily occurs in the usual method of separating the cream. Skimmed milk so obtained is, therefore, a more valuable food, since it still contains all the sugar and is less apt to produce disturbances of digestion.

The addition of a small amount of water facilitates, the addition of salt interferes with, the separation of the cream.

The following table represents the composition of cream:—

Water,	.	.	.	.	.	.	61.67
Fat,	.	.	.	.	.	.	33.43
Casein,	.	.	.	.	.	.	2.62
Sugar,	.	.	.	.	.	.	1.56
Salts,	.	.	.	.	.	.	0.72

By the process of churning, which is only effective after the milk has become slightly acid, only about two thirds of the fat are removed;

the other third remains in suspension in the buttermilk. Churning is best accomplished at about 14° C., with thirty to forty strokes of the churn per minute.

The average composition of buttermilk may be placed as follows: Fat, 0.50 to 0.75 per cent.; casein, 3.60 per cent.; albumen, 3.7 per cent.; sugar, 0.52 per cent.; ash, 0.52 per cent.; water, 91.7 per cent.

The amount of cream which may be obtained from milk varies very considerably in different animals and under different conditions, and will be subsequently referred to.

Usually about 80 per cent. of the entire amount of fat contained in the milk passes into the cream, and if the average percentage of fat in milk be placed at 3.5 per cent., the fat in cream would amount to 2.7 per cent.

When butter becomes rancid the volatile fatty acids are set free and acrolein and formic acid are formed from the glycerin.

Skimmed milk has a higher specific gravity than unskimmed milk, from the fact that the lighter constituents, that is, the oils, have been largely removed. The specific gravity of skimmed milk may rise to 1037, or even higher. Its composition may be placed as follows:—

Water,	. . . . .	89.65
Fat,	. . . . .	0.79
Casein,	. . . . .	3.01
Sugar,	. . . . .	5.72
Salts,	. . . . .	0.83

5. THE INORGANIC CONSTITUENTS OF MILK.—In addition to the albuminoids, fats, and carbohydrates contained in milk, the mineral constituents necessary for the support of the animal body are also present, their average amount being about as follows:—

Phosphoric acid,	. . . . .	28.31
Chlorine,	. . . . .	16.34
Calcium oxide,	. . . . .	27.00
Potassium,	. . . . .	17.34
Sodium,	. . . . .	10.00
Magnesium,	. . . . .	4.07
Ferric oxide,	. . . . .	0.62

Oxygen, nitrogen, and carbon dioxide are also present; and since these gases may be entirely removed by pumping, they are, therefore, in a condition of solution in the milk.

Nitrogen is present in 0.7 volumes per cent.; oxygen, 0.1 per cent.; carbon dioxide, 7.7 per cent.

6. VARIATIONS IN THE QUANTITY AND COMPOSITION OF MILK.—The variations which occur in the quantity and composition of milk are largely dependent on the quantity and composition of the food; insufficient food leads to a reduction in both the absolute quantity and solid constituents of the milk. In addition to these conditions, to be

studied in detail directly, the amount and character of the milk depends largely upon the period of pregnancy and suckling, as there is a close sympathy between the secretion of the mammary glands and the genital organs. The period of activity of the mammary gland is inaugurated shortly before the first birth, and shortly thereafter yields the largest amount of secretion, which in the best Dutch cattle may be as large as 30-35 liters each day. This maximum persists for several weeks, and then commences gradually to decline, there being a continual and gradual relative increase in the albuminoids and a decrease in the fats and sugar, and at the end of the tenth month only one-quarter or one-sixth as much milk is secreted as at first. During the first ten months of lactation in the best cows more than 6000 liters may be secreted; fairly good cows will form 3000 liters, and poor cows not more than 1000 liters of milk in the same time.

Quite frequently good cows will yield as much milk, nearly, after ten months as in the first week after birth.

Colostrum is far richer in solids than the later secretions of milk.

	Solids.	Water.
Immediately after calving, . . . . .	38.4	61.6
1st day after calving, . . . . .	30.1	69.9
2d " " " " . . . . .	23.1	76.9
3d " " " " . . . . .	15.3	84.7
4th " " " " . . . . .	14.9	85.1
5th " " " " . . . . .	13.7	86.3
6th " " " " . . . . .	12.9	87.1
14th " " " " . . . . .	12.6	87.4
28th " " " " . . . . .	12.4	87.6

The solids contain the following constituents:—

	Fat.	Sugar.	Albuminoids.
Immediately after calving, . . . . .	8.4	0.0	15.5
1st day after calving, . . . . .	5.9	0.2	13.7
2d " " " " . . . . .	6.2	0.9	10.9
3d " " " " . . . . .	4.0	2.5	8.6
4th " " " " . . . . .	4.5	3.6	5.1
5th " " " " . . . . .	3.7	3.9	3.4
6th " " " " . . . . .	3.0	4.3	2.0
14th " " " " . . . . .	2.5	4.3	1.6
28th " " " " . . . . .	2.6	4.4	0.7

Colostrum contains 3.3 per cent. salts, and it therefore follows that the percentage of casein must be 11.2 per cent.

The quantity of milk depends upon the breed of cow. Some races are good milkers, while others are better as meat producers and beasts of burden. Nevertheless, the quantity of milk is directly proportionate to the degree of development of the mammary gland. Even in two cows of the same breed, and on precisely the same food, the amount of milk secretion will depend upon the degree of development of the glandular tissue.



The following table gives the average milk given by different breeds of Irish and English cattle (Schmidt-Mülheim):—

<i>English Cattle.</i>		
Breed.	Duration of Lactation.	Total Milk.
1. Shorthorns (Wiltshire),	270 days.	2160 quarts.
2. " " "	240 "	2520 "
3. " " "	255 "	3060 "
4. Cross-bred (Cheshire),	240 "	2880 "
5. Yorkshire, . . . . .	270 "	3465 "
6. Half-bred and Shorthorns (Cheshire),	240 "	2640 "
7. North-bred and South Devon, Jerseys and Shorthorns (Devon),	320 "	3840 "
8. Yorkshire (Hunts), . . . . .	240 "	1440 "
9. Half-bred Yorkshire (Hunts), . . . . .	180 "	2520 "
10. Hereford, . . . . .	240 "	1920 "
11. Yorkshire (Surrey), . . . . .	270 "	3240 "
12. Shorthorns (Yorkshire), . . . . .	235 "	2142 "
Average, . . . . .	250 "	2652 "

<i>Irish Cattle.</i>		
Breed.	Duration of Lactation.	Total Milk.
1. Cross-bred, Durham, and Ayrshire (Kerry), . . . . .	285 days.	1995 quarts.
2. Cross-bred, Irish, and Shorthorns (Limerick), . . . . .	270 "	2430 "
3. Half-bred, Shorthorns (Cork), . . . . .	270 "	2700 "
4. Cross-bred (Cork), . . . . .	270 "	2970 "
Average, . . . . .	274 "	2524 "

As the milk-glands in the cow weigh only about five kilos, with 24 per cent., or 1.2 kilos, solids, it is evident that each gland produces two and a half times its own weight in solids.

Goats give one-half to one liter of milk daily.

Women produce one to one and one-third liters of milk daily.

The milk of different breeds of cattle varies not only in quantity, but also in quality. As a rule, the milk of the Dutch cattle contains the largest percentage of fat and albumen; then come the Swiss and Tyrolean cows and Normandy cows with greatest percentage of solids.

The composition of milk also varies according to the stage of lactation, casein and fat increasing in women up to the second month, while sugar decreases even in the first month.

In five to seven months fat decreases. Casein decreases after the ninth to tenth month. Salts increase in first five months and then decrease.

In goats casein first sinks, then remains constant, and then increases. Fat gradually decreases.

So, in dogs, albuminous diet increases the fat in milk. This influence is less marked in cows. Fat in food appears to decrease the fat in

milk if there is an insufficient amount of albumen given at the same time.

Carbohydrates in food of carnivora appear to be without influence on amount of milk-sugar. Also, in herbivora, milk-sugar depends for its origin principally on the albumen of the food.

The mode of living is of the greatest influence on the milk secretion. When a large quantity of milk is desired, the animals must remain perfectly at rest, as every excitement or movement, even of the animals' body muscles, decreases the milk secretion. When the animals are perfectly motionless the greater part of the blood-stream passes through the glands, and *vice versa*. So a much smaller quantity of milk is produced by grazing than by stall-fed animals, and it has been found that even leading cows out to drink decreases the amount of milk.

The feeding has also a certain influence on the composition of the milk; to produce a large quantity of good milk, the animal, naturally, must receive enough food to maintain a good condition. If a poor food is given the milk will not be very seriously influenced, nor will a rich food increase the quantity of milk to any great extent. The milk secretion is far more closely dependent on the breed of cattle than on the feeding; a certain maximum which is peculiar to each individual cannot by any artificial means be increased.

Water, of all foods, seems to have the greatest influence on the composition of milk. When large quantities of water have been drunk, the milk contains a higher percentage of water. The amount of albuminoid constituents of the food exerts great influence on both the composition and quantity of the milk. An increase in the proteids in the food increases the total quantity and solids of the milk, the fats being relatively more increased than the albuminoids. As an illustration of these facts, Weiske has found that a goat which on a diet of one thousand five hundred grammes potatoes and three hundred and seventy-five grammes chopped straw secreted seven hundred and thirty-nine grammes milk, secreted one thousand and fifty-four grammes milk when two hundred and fifty grammes of meat residue was added to the ration, the fat in the milk increasing from 2.71 per cent. to 3.14 per cent. In carnivora, also, a rich proteid diet leads to the production of a copious secretion, which may be almost completely arrested by confinement to a carbohydrate diet. In the human female, a rich albuminous diet leads not only to an increase in the amount of milk, but also of its solid constituents, as is seen in the following table:—

	Water.	Solids.	Fats.	Casein.	Sugar and Extractives.
On scanty diet, . . . .	914.0	86.0	8.0	35.5	39.5
One week later, after abundant meat diet, . . . .	880.6	119.4	34.0	37.5	45.4

In herbivora, carnivora, and omnivora, therefore, the same general rule holds, that an increase in the albuminous constituents of the food increases both the total amount of milk and its percentage in fats. In cows, however, it is to be noted that the relative percentages of casein and fat are not dependent so much on the amount of albumen of the food as on the breed and individual characteristics. The influence of the fatty constituents of the food on the composition of the milk is less marked.

It will be shown, under the subject of Nutrition, that the addition of fat to the food serves to reduce the waste of tissue-albumen, and therefore permits the deposition of nitrogenous tissue-constituents. To this extent, by yielding a greater supply of albuminous bodies to the glandular epithelium, a fatty diet may help the milk secretion, but not, as will be shown directly, by an immediate transfer of the fat of the food to the milk. In fact, the addition of fat to the food even seems to reduce the amount of butter in the milk if the amounts of albuminoids in the food are not amply sufficient for the nutritive needs of the economy. When, however, the albuminoids and other constituents of the food are ample for preserving nutritive equilibrium, the further addition of fat will increase the percentage of butter in the milk.

The milk secreted at different hours of the day shows certain constant, though small, variations in composition.

Morning milk has the largest percentage of water; midday milk the smallest.

In 100 Parts.	Morning.	Noon.	Evening.
Water, .	88.46	88.16	88.30
Solids, .	11.54	11.84	11.70
Butter,	2.69	2.94	2.82
Milk-sugar,	4.87	4.90	4.87
Casein,	3.15	3.27	3.21
Salts, .	0.828	0.725	0.802

So, also, the first- and last-drawn portions of milk have different compositions. The last portions have more solids, and especially more fat, than the earlier portions. A difference of four hours in time of milking makes this most apparent. It has been attempted to attribute this difference to the rising of the cream in the udder of the cow, just as occurs in milk standing in a vessel outside the body. The same differences may, however, be made out in human milk, where this mechanical explanation can have but little force. It must not be forgotten that in milking not only ready-formed milk is withdrawn, but during the act new milk is secreted, and it is quite warrantable to suppose the cell processes which result in the production of the solids of the milk are less active in the pauses than during the act of milking or suckling, when the process is stimulated from the irritation of the nipples.

## QUANTITATIVE COMPOSITION OF MILK.

In 1000 Parts.	Swiss.	Tyrolean.	Voigtland.	Steyermark.	Normandy.	Brittany.	Holstein Angles.	Durham.	Dutch.	Belgian.	Bohemian.
Water,	851.98	817.40	849.90	853.15	871.80	837.48	803.20	845.62	839.72	857.70	841.80
Solids,	148.02	182.60	150.10	146.85	128.20	162.52	196.80	154.38	160.28	142.30	158.20
Casein,	22.56	41.98	37.64	22.63	42.18	46.50	45.62	32.46	34.87	31.50	28.52
Albumen,	3.08	7.60	8.00	8.82	5.15	7.24	7.90	11.14	7.32	9.10	10.20
Butter, . . .	70.88	79.60	51.40	62.80	32.40	57.04	98.80	64.10	68.46	62.20	63.40
Sugar, . . .	45.90	48.42	46.26	46.20	42.12	45.54	37.26	39.70	43.50	32.92	49.68
Salts,	5.60	5.00	6.80	6.40	6.00	6.20	7.22	6.82	6.14	6.78	6.40

7. THE SECRETION OF MILK.—The mammary glands belong to the type of compound acinous glands, and are constructed on a similar plan to the salivary glands. The alveoli are lateral expansions at the terminations of the excretory ducts and are formed of a closed membrane covered, as is also the case with the ducts, with a single layer of cells, whose appearances vary according to the stage of activity of the glands. The secretory cells are composed of polyhedral cellular structures containing a round nucleus and usually a varying number of oily globules. During the stage of greatest activity the secretory cells increase in size, the nucleus often is apparently reduplicated, and the number of oil-globules greatly increased. In active secretion, during which the oil-globules and cell-contents appear to be extruded, the remaining cells are much smaller and only contain a single nucleus. The excretory ducts, which are short, are likewise supplied with flat epithelial cells and terminate in a canal which in each part of the gland becomes enlarged, especially at the base of the nipple, where it becomes dilated to form the so-called milk-cistern, which is connected at the exterior by several canals which open at the end of the nipple (Fig. 260). This cistern is lined with a mucous membrane composed of cylindrical epithelial cells (Fig. 261). In the canals and in the nipple the epithelial coat becomes converted into pavement epithelium. The excretory canals are abundantly supplied with unstriped muscular fibres, which at the opening into the nipple become developed into strong circular layers.

It is evident from the composition of milk that its most important constituents must result from a special cell activity, since neither casein nor milk-sugar are found in the blood, and, although fat is a constant constituent of the blood, the amount in comparison with that found in the milk is almost infinitesimal. It follows, therefore, that the milk, like the other secretions, cannot be regarded as a transudation, but is a result of the protoplasmic activity of the epithelial cells of the mammary glands. But, further, good cows may yield as much as twenty-five kilos of milk daily, containing as much as 2.5 kilos of albuminoids, fats, and sugar.

The weight of the milk-gland is not more than 4.8 kilos, with 24.2 per cent. solids, including all the glandular tissue (vessels, capsule, connective tissue, etc.), or 1.16 kilos solids. Consequently, the gland must renew itself 2.09 times daily to furnish this amount of organic matter if derived

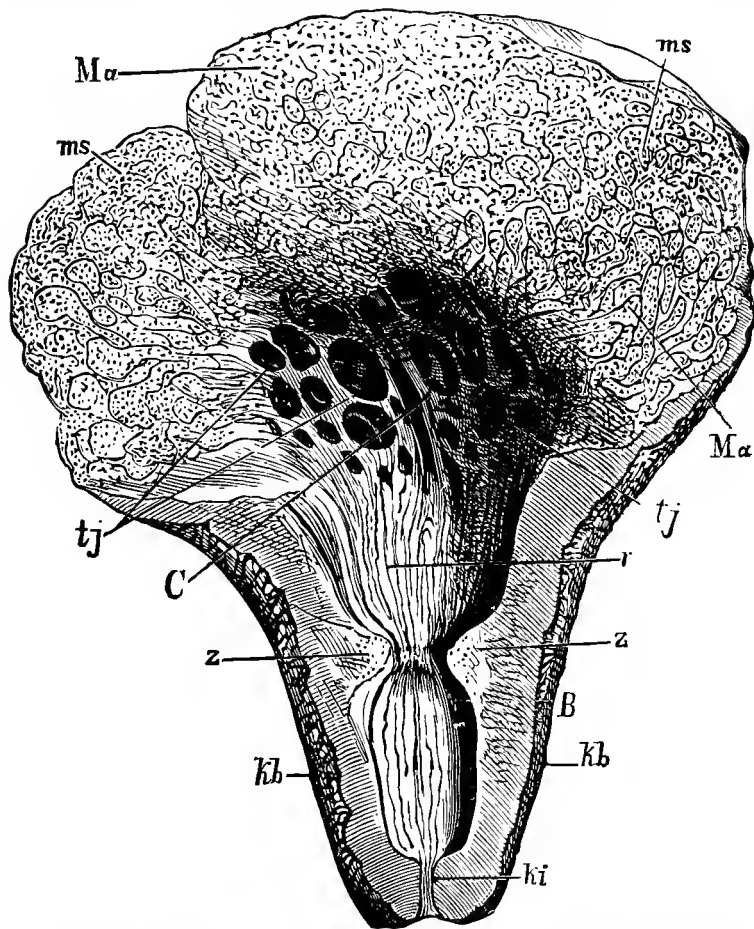

FIG. 260.—SECTION OF THE UDDER AND NIPPLE OF THE COW. (*Thanhoffer.*)

*Ma*, gland-substance; *B*, nipple; *ms*, acini of gland; *tj*, milk-ducts; *C*, milk-cistern; *r*, folds in wide milk-ducts; *z*, section of sphincter muscle; *kb*, external skin; *ki*, narrow milk-duct in the nipple.

solely from the secreting cells. This would, however, require an incredibly rapid cell growth, and we are compelled to assume that although the growth and disappearance of the secreting cells is of the greatest importance in furnishing the organic constituents of the milk, these substances are not derived solely from the breaking down of the cells, but

that in their functional activity they, to a certain extent, simply modify certain substances already existing in the blood and lymph.

As regards the production of the fat of milk, oil-globules may be seen to collect in the epithelial cells and escape into the excretory ducts, either by a breaking up of the epithelial cells or by a process of contraction similar to that observed in the amœba in the process of ejecting the residue from digestion. The origin of the fat is, without doubt, in a process of fatty degeneration of the protoplasmic cell-contents, for the

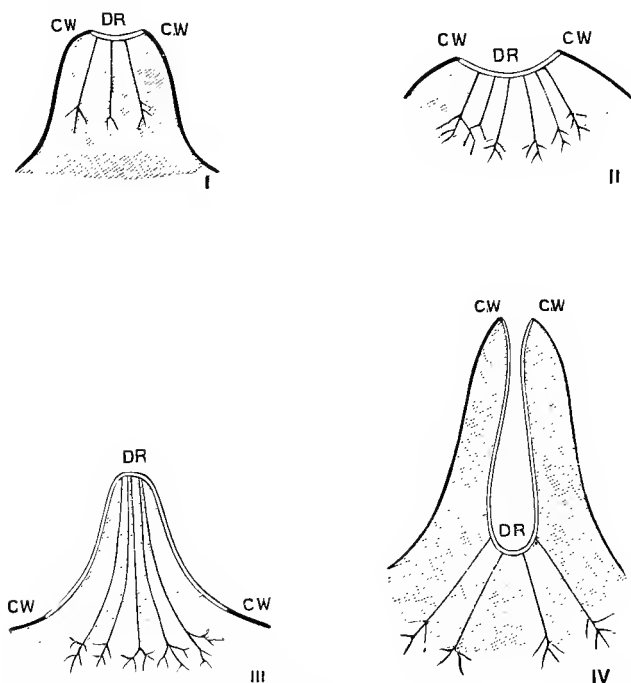

FIG. 261.—DIAGRAM OF THE FORMATION OF THE NIPPLE, AFTER KLAATSH.  
(Ellenberger.)

I, cat; II, mare; III, woman; IV, cow. DR, milk-cistern; CW, cutaneous surface.

amount of fat contained in milk, so far from being increased, is actually diminished by an increase of fat in the food; while, further, the fats in milk do not necessarily coincide in nature with the fats of the food. On the other hand, an increase in proteid diet increases the amount of fat in the milk. In microscopic examination of the epithelial cells of the mammary glands, oil-globules may be actually seen to increase in size and number until often the protoplasmic contents become almost entirely

replaced by oil-globules, which entirely agree in their characteristics with the oil-globules found in milk. So, also, in feeding animals on highly albuminous diet they may even be seen to increase in weight, while at the same time more fat is removed in the milk than could be taken in the food, while the increase in weight indicates that the origin of fat is not from the adipose tissue of the body. On the other hand, it is impossible that in the herbivora the fat of the milk should be derived from the breaking up of albuminoids in the gland, for the total amount of albuminoids breaking up in the body is insufficient to furnish the fat removed in the mammary secretion. Part must, therefore, be derived from the blood.

As regards the casein, this substance is, without doubt, developed at the expense of the albuminous cell-contents, since it is absent from the blood, the alkali albuminate being directly derived from the breaking down of the protoplasm, while the nuclein, which is to be regarded as a constant component part of the casein, is, without doubt, derived from the nucleus which disappears in the process of secretion. This conversion of the albuminous contents into casein is still further evidenced by the fact that the proportion of casein in the milk depends upon the degree of perfection of cell activity. Thus, in the earlier stages of lactation, in the formation of colostrum, the amount of albuminoid matter contained in the milk is greatly in excess of the amount contained in milk after lactation has become thoroughly established, while coincidentally with the decrease in albumen there is a proportionate increase in the percentage of casein. A ferment has even been extracted from the mammary gland which possesses the power of converting albumen into casein.

The origin of milk-sugar is less clearly established, although it also seems, without doubt, to originate in changes occurring in the protoplasmic contents of the epithelial cells of the mammary gland. For the amount of sugar in the milk is entirely independent of the amount of carbohydrate constituents of the food, and remains unchanged even when animals are fed on a purely meat diet. It would, therefore, appear that the milk-sugar, casein, and fats are all formed by the direct activity of the epithelial cells as a result of the decomposition of their protoplasmic contents or their action on the food-constituents in the blood.

The other constituents of the milk, the water and salts, evidently result from a direct process of transudation from the blood, with the exception that, without doubt, a certain percentage of the potassium salts and phosphates, like the specific milk-constituents, originate in the metamorphosis of the protoplasm of the secretory cells.

The process of secretion of milk may, therefore, be regarded as a process of molting of the epithelial cells, which undergo decomposition and discharge the resulting products into the excretory ducts.

According to the results of Heidenhain, the histological appearance of the cells of the mammary glands differs according as they are examined at the commencement or termination of secretion or while the secretion is at its height.

In the first stage of secretion the cells are flattened and lie against the walls of the alveoli, of which they may be regarded as forming a protoplasmic boundary. Their nuclei are at this period spindle-shaped, lying close to the contours of the cells, scarcely detectable on examina-

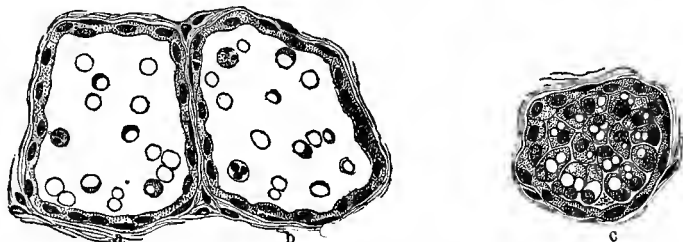

FIG. 262.—MAMMARY GLAND OF THE DOG IN FIRST STAGE OF SECRETION. (Heidenhain.)

a, b, section through the centre of two alveoli of the mammary gland of the dog, the epithelial cells seen in profile; c, surface view of the epithelial cells.

tion in transverse section. Seen from above, however, the epithelial cells are found to be polygonal, and each containing a round nucleus. In the terminal period of secretion the cells may be found to have greatly increased in size, possess one to three nuclei, and contain in the portions directed toward the alveoli large numbers of fat-globules. Often the cells may be seen to undergo subdivision, a part falling free into the alveolus (Figs. 262, 263, and 264). Between these two extreme periods

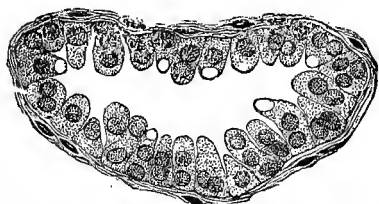

FIG. 263.—MAMMARY GLAND OF THE DOG IN SECOND STAGE OF SECRETION. (Heidenhain.)



FIG. 264.—MAMMARY GLAND OF THE DOG IN MIDDLE STAGE OF SECRETION. (Heidenhain.)

various intermediary stages may be recognized. From these histological changes Heidenhain concludes that in the formation of eolostrium the epithelial cells are not dissolved, and that, therefore, the eolostrium corpuscles are not fatty, degenerated epithelial cells, but that only the free end of the epithelial cells with their contained oil-globules is liberated; that the broken-down protoplasm becomes dissolved in the milk, and the fat-globules are thus set free.



As regards the influence on the mammary secretion of the nervous system, while certain data have been clearly established (thus, the influence of the emotions on the mammary secretion is well known), the process is by no means so thoroughly understood as is the case as regards the salivary secretion.

It is well known that the maintenance of the milk secretion is closely dependent upon periodic emptying, whether by suckling or milking, of the milk-gland, and the question arises, What connection is there between this emptying of the gland and the act of secretion? Does the reduced internal pressure which follows emptying the gland start the secretion anew, or does the act of suckling or milking stimulate the secretion reflexly? It is clear that when the milk-ducts and cistern are filled with fluid the activity of secretion must be reduced, and when the gland is emptied by milking it again fills itself, at first rapidly, and then more and more slowly; but that this augmented secretion is not due solely to decreased internal pressure is evident from the following facts: The cavities of the milk-gland of the cow are capable of containing about three thousand cubic centimeters of fluid,—a quantity very much less than may be withdrawn from the milk-gland in a single milking, so that evidently during milking renewed secretion is excited even before the gland is emptied, and, as is well known, frequent milking increases the total milk secreted. It would, therefore, appear that this renewed secretion is produced reflexly from stimulation of the nipple in a manner to be described directly.

The first stimulus to the activity of the mammary glands is found usually coincident with the birth of young, although the gland even for several days before birth is the seat of a more or less active secretion. In this way the connection between the generative organs and the mammary glands is clearly indicated.

The influence of the nervous system on the secretion of milk has been especially studied by Röhrig.

The mammary gland is innervated in quadrupeds (in addition to the ileo-inguinal nerve distributed to the skin) by the external spermatic nerve. This nerve originates from the lumbar portion of the spinal cord and passes out between the greater and lesser psoas muscles, dividing in the pelvis into three branches, of which one is distributed to the abdominal muscles, while the other two leave the abdominal cavity through the femoral ring accompanying the crural artery, and then, following the course of the external pudic artery, are distributed to the mammary gland. These nerves may be spoken of as the middle and inferior branches of the external spermatic nerve. The middle branch divides at the base of the gland into three twigs: first, a small filament which follows the course of the pudic artery and is lost in its walls;

second, a much larger branch, termed the papillary branch, which is distributed to the nipple; third, one, or occasionally two, glandular branches, which are supplied to the walls of the milk-ducts and the cistern.

According to Röhrig, section of the papillary branch produces no change in the milk secretion, but simply causes relaxation of the nipple. Irritation of the peripheral end of this nerve causes erection of the nipple without change of glandular secretion, while irritation of the central end of this nerve produces considerable increase in the secretion.

Section of the glandular branch, on the other hand, produces slowing of the amount of secretion by causing relaxation of the walls of the duct, while stimulation of this nerve may increase twenty-fold the secretion of milk by causing contraction of the milk-ducts and consequent discharge of their contents.

Section of the inferior branch produces great increase in the amount of milk secreted, while the stimulation of the peripheral end of this nerve produces arrest of secretion.

The explanation of these two classes of phenomena are understood through a study of the character of this nerve. The median branch is a compound nerve composed of both sensory and motor fibres, the latter being especially found in the papillary branch distributed to the nipple, while the glandular branch is almost solely motor. When the papillary branch is stimulated it produces, by a reflex action, the contraction of the muscular fibres of the excretory ducts, and so causes discharge of their contents, while it also, in all probability, acts through the inferior branch, and by it also increases the amount of milk formed in a manner to be referred to directly.

When the glandular branch is stimulated the muscular fibres of the ducts contract, and, although no more milk may be actually formed, there is, nevertheless, an increase in the amount poured out through the contraction of the walls of the milk-ducts.

On the other hand, the inferior branch is a vaso-motor nerve. When its peripheral termination is stimulated, the milk secretion is arrested through the constriction of the blood-vessels supplied to this gland.

On the other hand, when it is divided, the blood-vessels become greatly relaxed, more blood passes through the organ, and its activity is largely increased.

Whether any of these processes are associated with the action of true secretory nerves is not known, but from analogy, from what we have seen in the case of the salivary gland, it may be assumed that such is the case.

The explanation of the connection long known between the mechanical irritation of the nipple, as in suckling and milking, and the increased

secretion of the gland is thus evidently to be found in reflex action, the afferent impulses passing through the sensory nerves of the nipple, the secretory impulses passing through the inferior branch and the glandular branch of this nerve.

It is thus seen that, as far as we know, the mammary secretion is dependent upon the amount of blood passing through the glands. Changes in the general blood pressure, by modifying the blood supply of the mammary gland, also influence the amount of milk secreted.

Thus, various substances which act as stimuli to the vaso-motor centre, and so produce increase of blood pressure, produce likewise an increase in the amount of milk secreted. Strychnine in small amount, digitalis, caffeine, and pilocarpine are all galactagogues and probably act in this way, while through reduction of blood pressure, as by means of chloral, the milk secretion may be considerably reduced.

8. MILK INSPECTION AND ANALYSIS.—Good cows' milk is white, with a faint yellowish tint, and only bluish when diluted. If a drop of good milk is placed on the thumb-nail it retains its shape instead of spreading out, as occurs when diluted or unhealthy. Milk is most apt to be adulterated with water, which within certain limits may be detected by determination of the specific gravity. Unskimmed milk possesses a higher specific gravity than that of the skimmed milk from the effect of the removal of the fats, so that a milk from which all the cream has been removed might, if dependence be placed upon the specific gravity alone, be considered as a better specimen than the pure milk. The average specific gravity of normal cows' milk may be placed at about 1030 at 60° F.; if diluted with half its volume of water the specific gravity will fall to about 1014 or 1016. As a consequence, by the determination of specific gravity a general idea may be obtained as to how much water has been added to diluted milk. The following table may serve to assist in this determination:—

	With Skimmed Milk.	With Unskimmed Milk.			
A specific gravity of	1037 to 1033	or 1033 to 1029	indicates a pure milk.		
"	"	1033 to 1029	or 1029 to 1026	"	milk with 10 per cent. water.
"	"	1029 to 1026	or 1026 to 1023	"	" " 20 " "
"	"	1026 to 1023	or 1023 to 1020	"	" " 30 " "
"	"	1023 to 1020	or 1020 to 1017	"	" " 40 " "

The instrument by which the specific gravity of milk is determined is usually termed the lactometer, and simply consists of a hydrometer with a scale running from 1000, which is the specific gravity of distilled water and is marked zero on the scale, to 1034, marked 120, which is the specific gravity of a rich sample of milk. In using the lactometer special attention must be paid to the physical characteristics of the milk, since a little attention would readily detect skimmed milk from unskimmed, although their specific gravity might be the same. In milk rich in cream where the specific gravity might be abnormally low, its physical appearance and the fact that it clings to the instrument would enable it to be recognized, while watered or skimmed milk is bluish and does not cling to the lactometer; so, if a sample of milk should read above 110 on the lactometer without manifestly being full-bodied, it would be only fair to presume that a portion of the cream had been removed. Milk diluted with spring-water may be recognized by the detection of nitrates in the milk. Sulphuric acid is added to the milk, the precipitate filtered off, the filtrate distilled, and nitric acid looked for in the distillate. This may be readily accomplished by converting, through milk-sugar, the nitric into nitrous acid. A few drops of pure  $H_2SO_4$ , potassium iodide solution, and boiled starch solution are then added to the distillate; if nitrous acid is present iodine is liberated from the potassium iodide solution and the starch is colored blue.

The cream may be roughly determined in milk by placing it in a tall cylindrical glass, graduated into one hundred parts. The milk should be allowed to stand in this creamometer for twenty-four hours and the volume of cream separated on the surface may then be determined, one gramme of cream equalling about 0.2 grammes of fat. Good cows' milk should separate from ten to fifteen volumes of cream. This method is, however, not thoroughly reliable, since different specimens of milk will throw up their cream with different degrees of readiness. The second method, and a much more reliable one, of determining the amount of fat or cream present is, by means of the lactoscope. This instrument consists of a little cup with two of its sides formed of two parallel plates of glass, distant from each other half a centimeter. For applying this test, in addition to such a glass, a jar graduated to one hundred cubic centimeters and a pipette of three cubic centimeters are needed. Three cubic centimeters of milk are taken and shaken up well with one hundred cubic centimeters water, and the mixture then placed in the glass cup with the parallel sides and a lighted stearin candle placed one meter from it in a dark room. If at the first experiment the contour of the flame can be seen, the milk is poured back into the large measure and a further measured quantity of undiluted milk added until the contour of the candle-flame is entirely obscured. The percentage of fat is then determined by the following formula: If  $x$  equal the percentage of fat and  $n$  the number of cubic centimeters of milk required, then  $x$  equals  $\frac{23.2}{n} + 0.23$ . Thus, if three cubic centimeters of milk were required to

obscure the light, the formula would read:  $x = \frac{23.2}{3} + 0.23$ , or  $x = 7.96$ , the per cent. of fat in the milk. Six cubic centimeters of pure cows' milk with one hundred cubic centimeters water should form a mixture which will obscure the candle-flame; if more milk is required, then the milk has been diluted. Thus, twelve cubic centimeters indicate 50 per cent. water, and eight cubic centimeters about 30 per cent. water. The following table gives the percentages of fat in the milk when the candle-flame is obscured by different amounts of milk in Vogel's galactoscope:—

3 cubic centimeters of milk indicate	7.96 per cent. of fat.
3.5	6.86
4.0	6.03
4.5	5.38
5.0	4.87
5.5	4.45
6.0	4.09
6.5	3.80
7.0	3.54
7.5	3.32
8.0	3.13
8.5	2.96
9.0	2.80
9.5	2.77
10.0	2.55
11.0	2.43
12.0	2.16
13.0	2.01
14.0	1.86

Another ready method of estimating the fat in milk is by means of Marchand's lactobutyrometer. As improved by Caldwell and Parr (*Amer. Chem. Journ.*, Nov. 1885), this method is performed as follows:—

The instrument employed consists of a thick glass tube, open at each end, with a stem six cubic centimeters in diameter and twenty-three centimeters long, graduated in  $\frac{1}{10}$  cubic centimeter, and a bulb about eight centimeters in length, and of such a capacity that in passing from the lowest graduation on the stem to the inner end of the stopper in the lower mouth one passes from five to thirty-three cubic centimeters. Then the ether-fat solution will always come within the range of the graduation on the stem. Closing the lower mouth with a good cork, ten cubic centimeters of the well-mixed sample of milk are delivered into the well-dried tube from a pipette, then eight cubic centimeters of ether (Squibb's stronger) and two cubic centimeters of 80 per cent. alcohol. Close the smaller mouth of the tube with a cork and mix the liquids by thorough shaking (not violently nor prolonged). Both corks should be held in place by the fingers during this operation, and the upper one should be once or twice carefully

removed to relieve the pressure within, otherwise it is apt to be forced out, with consequent loss of material. Lay the tube on its side for a few minutes and then shake it again; add one cubic centimeter of ordinary ammonia diluted with about its volume of water, and mix as before by shaking; then add ten cubic centimeters of 80 per cent. alcohol and mix again thoroughly by moderate shaking, holding the tube from time to time in an inverted position.

Now, put the tube in water kept at 40° to 45° until the ether-fat solution separates; this separation may be hastened by transferring the tube to cold water after it has stood in the warm water for a few minutes, and then returning it to the warm water. Finally, transfer the tube to water at 20° C., and as the level of the liquid falls in the stem by contraction of the main body of it in the bulb, gently tap the side of the tube below the ether-fat solution to dislodge any flakes of solid matter that may adhere to the side. The readings are to be taken from the lowest part of the surface meniscus to the line of separation between the ether-fat solution and the liquid below it.

The following table gives the percentages of fat corresponding to each tenth of a cubic centimeter of ether-fat solution down to one cubic centimeter, and for each twentieth of a cubic centimeter thereafter:—

Reading.	Per Cent. of Fat.	Reading.	Per Cent. of Fat.
3.0 .	1.	13.5 .	3.51
4.0 .	1.23	14.0 .	3.63
5.0 .	1.47	14.5 .	3.75
6.0 .	1.71	15.0 .	3.87
7.0 .	1.95	15.5 .	4.00
8.0 .	2.19	16.0 .	4.13
9.0 .	2.43	16.5 .	4.26
10.0 .	2.67	17.0 .	4.39
10.5 .	2.79	17.5 .	4.52
11.0 .	2.91	18.0 .	4.65
11.5 .	3.03	18.5 .	4.78
12.0 .	3.15	19.0 .	5.01
12.5 .	3.27	19.5 .	5.14
13.0 .	3.39	20.0 .	5.27

This method has been applied with fairly satisfactory results to the milk of a herd of cows receiving bran and cotton-seed meal in their rations, the objection to the unreliability of this method under these circumstances being overcome by the use of the ammonia. Various other forms of lactoscope are used, depending on the property that the opacity of milk varies with and is proportional to the amounts of fats present. Skimmed milk contains smaller fat-globules than intact milk, and this causes a greater cloudiness in proportion to the amount of fat present than the large ones, and, hence, the application of this test to skimmed milk would give a higher percentage of fat than is actually present.

For the quantitative estimation of the different milk-constituents the following methods, taken from Charles's "Physiological and Pathological Chemistry," are the simplest and require the least apparatus:—

1. *The Solids.*—(j.) To ten grammes dry sand or powdered gypsum add five cubic centimeters milk, then dry the mixture for a long time at 100° until the weight is constant. The increase in weight is equal to the solids in five cubic centimeters milk. Suppose this to be = 0.5 gramme, then one hundred cubic centimeters milk contain ten grammes, or 10 per cent. solids (Baumhauer).

Instead of five cubic centimeters, ten grammes of milk and twenty grammes of dry sea-sand may be weighed in a tared capsule of about fifty cubic centimeters, and evaporated at 100° until the weight is constant. When quite cold, the capsule, with its contents, is weighed in a desiccator over sulphuric acid.

(ij.) Place a little milk in a platinum capsule, and, having weighed it, add a few drops of alcohol or acetic acid; evaporate over a water-bath, dividing the coagulum against the sides of the dish, and dry it at 100° to 110° until the weight is constant. It is generally completed in six hours (Gerber). Cover carefully before weighing, as the residue is very hygroscopic.

The total solids should not, as a rule, be much less than 11.5 per cent.; cows' milk, for example, varies between 10.5 and 15 per cent.; less than this indicates dilution.

2. *The Butter.*—(j.) Shake the milk well, and to twenty cubic centimeters of it add twenty cubic centimeters of a 10 per cent. caustic potash solution and then some ether (sixty to one hundred cubic centimeters), and agitate vigorously

for some time; on standing, the ethereal solution of the liberated fat rises to the surface and is to be carefully decanted into a weighed porcelain dish. Some more ether is to be added to the alkaline milk, and after vigorous agitation it also is to be transferred, as before, to the capsule. The same process may be repeated several times if necessary. The ethereal extract is now evaporated over a water-bath, and after having been dried in an air-bath at  $110^{\circ}$  the weight of the residue is to be ascertained; this multiplied by 5 gives the percentage. With cows' milk it varies between 2 and 5 per cent., but the normal minimum for fats is about 2.75 (Cameron).

3. *The Casein and Albumen.*—(j.) (a) Dilute twenty cubic centimeters milk with four hundred cubic centimeters water, and treat the mixture with very dilute acetic acid, added drop by drop, until a flocculent precipitate begins to appear. Now pass a current of carbonic acid gas through the fluid for fifteen to thirty minutes and lay aside for one or two days. Collect the precipitated casein on a weighed filter, wash it with spirit, and then with ether until a drop of the washings leaves no fatty stain on paper; dry at  $100^{\circ}$  and weigh. Subtract the weight of the filter, and the difference multiplied by 5 gives the percentage of casein. In human milk, precipitate the casein by saturating with magnesian sulphate.

(b) The filtrate from the casein precipitate is to be concentrated to a small bulk over a water-bath and an acetic acid tannin solution added so long as any precipitate occurs; after the precipitate has settled, collect it on a weighed filter, where it is to be washed with dilute spirit until the filtrate gives no blue coloration with ferric chloride (indicating absence of tannin); dry now at  $100^{\circ}$  and weigh. The weight multiplied by 5 gives the percentage of albumen.

In cows' milk the casein varies between 3.3 and 6 per cent., and the other albumens from 0.3 to 0.4 per cent. In diseased milk the casein may be as low as 0.2 per cent., and the other albumens as high as 10 per cent.

(i.) (a) Ten cubic centimeters milk are diluted with one hundred cubic centimeters distilled water and well mixed; a copper solution, made by dissolving sixty-three and five-tenths grammes of cupric sulphate in one liter of water, is then added slowly with stirring until the coagulum begins to settle quickly. The whole mixture, together with half the cupric sulphate solution already employed, is then added to some potash solution (fifty grammes of potash to the liter), and after a short interval the clear fluid is filtered off through a filter dried at  $110^{\circ}$  C.; the precipitate is washed until the washings amount to two hundred and fifty cubic centimeters, and the sugar is to be estimated in this subsequently.

(b) The coagulum on the filter is next treated with absolute alcohol, slowly dried, and extracted with ether; the ethereal and alcoholic extracts are then to be distilled, and the fatty residue dried and weighed. The coagulum, after having been dried at  $125^{\circ}$ , is weighed, then ignited, the ash deducted, and the difference taken as pure albuminoid (Ritthausen).

4. *The Sugar.*—(j) Take twenty-five grammes of milk, acidify with hydrochloric acid, boil, and filter, washing the coagulum with water; to convert the milk-sugar into glucose, boil the filtrate and washings for an hour or so in a flask, to the mouth of which a long tube has been attached. When the liquid cools, make its volume up to two hundred cubic centimeters and determine the sugar by Fehling's method, measuring twenty cubic centimeters Fehling's solution into a flask, diluting with eighty cubic centimeters water, and to the boiling mixture add the diluted filtrate from a Mohr's burette until the copper is entirely reduced.

(i.) This sugar determination may be readily effected by the polariscope. Measure forty cubic centimeters milk into a flask of one hundred cubic centimeters capacity, add some carbonate of sodium if the milk is not alkaline, and then twenty cubic centimeters moderately concentrated solution of neutral acetate of lead, and shake well; having next fitted the neck of the flask to a long glass tube or to the condenser of a Liebig's still, boil it over a small flame; then filter, and test the filtrate with the polariscope. With a one-decimeter tube the percentage of sugar is obtained by multiplying the rotation by 1.44.

\* For other ready methods of milk analysis and for the detection of foreign substances with which milk may be adulterated the reader is referred to the following articles:—C. Storch, *Oesterreicher Vierteljahresschrift für Wissen; Veterinärkunde*, 1884, Hefte II., s. 195; *Arch. f. Thierheilkunde*, 1885, Hefte 5 u. 6, s. 449; F. G. Short, *Amer. Chemical Journ.*, April, 1887, p. 100; Morse & Pigott, *ib.*, April, 1887, p. 108; F. A. Woll, *ib.*, February, 1887, p. 60; Morse and Burton, *ib.*, June, 1887, p. 222; *ib.*, July, 1888, p. 322.

## SECTION X.

### THE RENAL SECRETION.

THE blood not only bears to the different tissues the substances required for their nutrition, but also removes from the tissues the different waste products which result from their various metabolic processes. In the lungs, part of these oxidation products, especially of the carbon compounds, are removed, while the results of nitrogenous waste largely pass through the lungs to be carried through the aorta from the left ventricle to the kidneys, whose function is to remove these nitrogenous excrementitious substances, together with the carbon compounds which have passed the lungs, with various salts and water. The product of this functional activity of the kidneys is the urine, which is a pure excretion, since all its constituents are waste products which must be removed from the organism.

1. THE PHYSICAL AND CHEMICAL PROPERTIES OF URINE.—Urine is in general a thin, yellowish colored, transparent fluid (the depth of color depending on the concentration) of a salty taste and peculiar aromatic odor, due to the presence of various volatile acids. Its reaction may be faintly acid, neutral, or alkaline: it rotates the plane of polarized light to the left. The reaction in the carnivora and in fasting or suckling herbivora is acid; in the herbivora and omnivora, when on vegetable diet, it is alkaline. The explanation of the production of an acid renal secretion from the alkaline blood is to be attributed to a specific property of the renal epithelium similar to that possessed by the gastric mucous membrane. The more alkaline the blood, the less acid the urine; hence the great alkalinity of the blood of herbivora causes the urine to have an alkaline reaction. For although sulphuric acid is formed from the decomposition of vegetable just as it is from animal albumen, vegetable foods contain large amounts of organic salts which break up into alkaline carbonates, and so neutralize the sulphuric acid. These salts are absent from the food of carnivora, hence the acids are less perfectly neutralized. It is, therefore, the form of diet which, by modifying the alkalinity of the blood, determines the reaction of the urine. The specific gravity of urine varies between 1005 and 1050. When exposed to the air, the urea undergoes decomposition and is transformed into ammonium carbonate; a part of the ammonia then combines with magnesium phosphate, and ammonium-magnesium phos-

phates, together with calcium phosphate, are deposited as a crystalline precipitate. This process is known as ammoniacal fermentation, and is due to the action of ferments derived from the atmosphere. In some animals the urine always deposits mucus derived from the membranes over which it passes. Its quantity is subject to great variations.

The most important constituents of the urine are water, salts, gases, and certain specific constituents. Among the salts, potassium compounds are more abundant than sodium. Lime and magnesium are in varying amounts. Of the acids  $H_2SO_4$  and  $P_2O_5$  are most abundant.  $CO_2$  in combination is found in the urine of the herbivora. When NaCl forms part of the diet, this salt is also a large constituent of urine.

The following are the specific constituents of urine:—

1. The decomposition products of the albuminoids, as urea, uric acid, hippuric acid, kreatin and kreatinin, and the combinations of  $H_2SO_4$  with indol and phenol.

2. Coloring matters, of which urobilin is the best known.

3. Aromatic bodies which give the urine its peculiar odor.

The gases  $CO_2$ , N, and O are found free in the urine.

As regards quantitative composition there is great inconstancy.

	Horse.	Ox.	Sheep.	Hog.
Water, . . . . .	90.	91.	89.	98.
Organic matter, . . . . .	5.5	5.	8.	0.5
Inorganic matter, . . . . .	4.5	4.	3.	1.5

#### COMPOSITION OF THE URINE (BOUSSINGAULT).

	Horse (1).	Cow (2).	Pig (3).
Urea, . . . . .	31.0	18.5	4.9
Potass. hippurate, . . . . .	4.7	16.5	0.0
Alkaline lactates, . . . . .	20.1	17.2	. . .
Potass. bicarb., . . . . .	15.5	16.1	10.7
Mag. carb., . . . . .	4.2	4.7	0.9
Calcium carb., . . . . .	10.8	0.6	traees
Potass. sulph., . . . . .	1.2	3.6	2.0
Sodium chloride, . . . . .	0.7	1.5	1.3
Silica, . . . . .	1.0	traees	0.1
Phosphates, . . . . .	0.0	0.0	1.0
Water and undetermined substances, . . . . .	910.0	921.3	979.1
	<hr/> 1000.0	<hr/> 1000.0	<hr/> 1000.0

(1) Diet of oats and clover-grass.

(2) Diet of hay and potatoes.

(3) Diet of eoked potatoes.

The water, K, Na, Ca, and Mg compounds are derived directly from the blood, and in greater part directly from the food and drink, and in fasting animals from waste of tissues.  $H_2SO_4$  originates in oxidation of the sulphur compounds in food; the phosphates from the oxidation of albuminoids of food and tissues; carbonates, partly directly from



food and drink, partly from modifications of the vegetable acid compounds in vegetable foods.

The urea and uric acid are the nitrogenous end products of the decomposition of the albuminoids of food and of the tissues.

Kreatin and kreatinin are closely dependent on the animal matter taken as food, since, even in muscle, kreatin is formed as a modification of its own albuminoid constituents.

Hippuric acid is a combination of glycochol with benzoic acid, and originates, to a great extent, in the constituents of vegetable foods, the cuticular substance of which develops the benzoic acid.

Phenol is derived from the decomposition of albuminoids in the intestine, and in the excretory ducts of the kidney unites with  $H_2SO_4$ .

Indican originates in indol.

Many other substances are accidentally present in urine, such as aromatic constituents of food, alkaloids, metals, bile coloring-matter, etc.

The quantity of the urine is dependent on the amount of water taken in food and drink, on the diminution of excretion of water by other organs, especially the skin, on the amount of excretory products, especially urea, and on the amount of substances taken in food, *e.g.*, salts, which must be excreted.

It is to be noted that all the water taken as food is not excreted through the kidneys, but that part is removed by the lungs, skin, and intestinal canal. The proportion of water removed through these different organs varies in different species:—

	In the Urine.	Through the Lungs.
In herbivora,	20 per cent. of water is removed;	80 per cent.
In omnivora,	60 " " " "	40 "
In carnivora,	85 " " " "	15 "

Various conditions may, however, modify these proportions.

In fasting and suckling animals of both the herbivora and carnivora the urine has the same characters, since in them the tissues alone are undergoing waste.

There is the greatest difference between the urine of carnivora and herbivora.

In carnivora the urine is smaller in amount, is acid, clear, and richer in solids, especially urea, uric acid, and kreatin; sodium salts, sulphates, and phosphates are in excess, and the urine has a higher specific gravity. Phenol and sulphuric acid only are present in small amount and hippuric acid absent when on a purely flesh diet.

In herbivora it is larger in amount, is turbid, contains few solids, hippuric acid replaces uric acid, and the reaction is alkaline; urea is present only in small amount. Potassium salts are in excess unless sodium chloride is given with the food. Lime and magnesium, united with  $CO_2$ , are in abundance, phosphates often absent, sulphates abundant.

That this difference is dependent only on differences in diet is proved by the fact that during fasting the urine of the herbivora agrees in all its characteristics with the urine of the carnivora. Under such circumstances the herbivora are not consuming vegetable matters, but living at the expense of their own tissues, are then practically carnivorous, and their urine becomes acid, clear, and rich in urea and phosphatic salts.

*The Urine of the Horse* is cloudy and has an alkaline reaction. Its specific gravity varies from 1016 to 1060, 1050 being about the average. It contains a large percentage of mucin, and is therefore viscid and may be drawn into threads. It becomes brown on exposure to the air, deposits  $\text{CaCO}_3$ , and a pellicle forms on it, showing iridescent colors.

The characteristics of normal horses' urine depend largely on the mode of feeding. When fed exclusively on hay and straw the urine is always alkaline, while when oats constitute the principal food it is secreted in small quantity, is turbid, and of acid reaction, and more viscid than alkaline. The influence of the diet on the amount of solids in the urine is shown in the following table:—

DAILY RATION.			WATER.	URINE.	SOLIDS IN URINE.	
Hay.	Oats.	Wheat-Straw.			Kilos.	Kilos.
			Grammes.	Grammes.		
8 kilos.	2 kilos.	. . . .	22.31	5.04	11.2	566.6
7 "	2 "	1 kilo.	26.33	4.72	11.2	529.4
6 "	4 "	.	21.36	4.99	10.3	511.8
4 "	4 "	2 kilos.	27.55	4.66	10.2	477.0
4 "	6 "	.	23.73	4.53	10.4	460.7
1 "	6 "	2.6 "	24.60	6.03	5.7	346.1

A high percentage of calcium salts is characteristic of horses' urine. Of the amount contained in the food, from one-third to one-half passes into the urine, while in the ruminant, especially in the sheep, not more than 5 per cent. passes. In the case of potassium the conditions are just reversed. In the sheep 95 per cent. of the potassium in the food passes into the urine, while in the horse at most 66 per cent. appears. The following table gives the percentage of inorganic constituents in one hundred parts of the ash of horses' urine:—

Potassium, . . . . .	36.85 per cent.
Sodium, . . . . .	3.71 "
Calcium, . . . . .	21.92 "
Magnesium, . . . . .	4.41 "
Phosphoric acid, . . . . .	" "
Sulphuric acid, . . . . .	17.16 "
Chlorine, . . . . .	15.36 "
Silicic acid, . . . . .	0.32 "

Horses' urine contains urea and hippuric acid in inverse proportions. When one increases the other decreases, the amount of the latter depending on the amount of green forage or hay or straw, the former on the amount of oats, grains, roots, etc. The percentage of urea in ordinary feeding varies from 2.5 to 4.0 per cent.

Very large amounts of aromatic sulphur compounds are present, especially of phenol and indican. The former, with hippuric acid, causes the peculiar odor; the latter, the colors seen in the film which forms when exposed to the atmosphere. Brenzcatechin is also present and is the cause of the brown color which forms on standing.

CaCO<sub>2</sub> is the principal salt, and is rapidly deposited as a sediment. Sulphur compounds are found in varying amounts. Phosphates, except in abundant feeding with grains, are only present in traces. The amount of urine is only about five to six liters daily, evacuated in three to four portions, since a large amount of water is lost through the skin in perspiration.

*The Urine of the Ox.*—The amount of urine depends not only upon the amount of water taken, but especially on the amount of nitrogenous food. Thus, when the diet has been poor in nitrogen, the amount of urine passed daily will vary from 9.7 to 12.6 kilos, and when a richer nitrogenous diet is given the amount will be increased to from 16.3 to 16.8 kilos. This is, without doubt, partly to be attributed to the larger amount of water required in a rich, nitrogenous diet. The evacuation of the urine occurs from eight to ten times daily, averaging about one kilo each time. The character of the food exerts the greatest influence on the reaction of the urine. Fodder rich in alkaline carbonates or compounds of the organic vegetable acids occasions an alkaline reaction of the urine. The amount of carbonates in the solids of the urine is directly in proportion to its alkalinity. Carbon dioxide is especially abundant when fed on beets, clover, hay, or bean-straw, when it may amount to 10 or 12 per cent. When fed with oat-straw or barley-straw, the carbon dioxide sinks to from 3 to 6 per cent. Exclusive feeding with wheat-straw is said to cause an acid reaction of the urine on account of the poverty of carbonates and vegetable acids. The total amount of solids in the urine averages about 6.8 per cent., composed of—

C, . . . . .	27.8 to 53.1 per cent.
H, . . . . .	3.5 to 6.9 “
N, . . . . .	8.9 to 33.6 “
O, . . . . .	15.6 to 50.2 “

The quantity and quality of the organic matter in the urine varies greatly according to the food, varying between 4.2 to 11.3 per cent., and is especially dependent upon the digestible, nitrogenous food-stuffs. The non-nitrogenous food-stuffs are without influence on the organic urine

constituents. Uric and hippuric acids are the representatives of the nitrogenous organic constituents. Uric acid and hippuric acid are found in proportions which are governed by the character of the diet in the same way as in the case of the horse. The mineral constituents are likewise dependent on the food, potassium and lime combinations being especially abundant. The urine of the ox is clear, yellowish, or greenish, and possesses a peculiar, musky odor. Its specific gravity varies from 1020 to 1030, depending on the amount of water in the food. It is always poorer in solids than the urine of the horse. It also contains less sulphuric acid compounds, especially of the aromatic group, than horses' urine. The phosphates are entirely absent, or present only in traces.

*The Urine of the Sheep and Goat* is similar to that of the ox, but shows great variation in the salts derived from the food. Its specific gravity varies from 1006 to 1015; the amount from five hundred to eight hundred and fifty cubic centimeters daily. Urea and hippuric acid are present in the proportion of about two to three, the hippuric, contrary to what is the case in the horse, being more abundant when on a diet of young hay rich in proteids.

*The Urine of the Pig* is clear, yellowish, with a faint alkaline reaction; specific gravity, 1010 to 1015. It contains urea, but rarely uric or hippuric acids. The salts depend on the character of food. In general, the urine resembles that of carnivora.

*The Urine of the Dog* is deep yellow in color, acid reaction; specific gravity, 1050 when fed on meat. It is rich in urea, but contains but little uric acid. Kreatin and indican are present, but no phenol. Mg salts are in larger amount than Ca salts, while the chlorides are scanty; sulphates and phosphates abundant. It readily undergoes ammoniacal fermentations (from urea) and deposits phosphates. Its composition and character likewise vary greatly with the nature of the food.\*

2. THE MECHANISM OF RENAL SECRETION.—The substances which exist in the urine in a state of solution also exist in the blood, and the process of secretion of the urine is, therefore, largely a process of mere infiltration. Nevertheless, certain constituents of the urine are evidently manufactured in the kidney, since their presence has not yet been detected in the blood. Renal secretion is thus possessed of two factors,—a physical process of filtration and a process of true secretion dependent upon the activity of the renal epithelium.

The mechanism of the renal secretion is, to a certain extent, capable of explanation by the study of the structure of the kidney. The kidney is composed of a series of fine tubules, which, starting from the hilum

\* For further details as to the composition of the urine of the domestic animals under different forms of diet the reader is referred to the "Encyclopædie der Gesammten Thierheilkunde," Bd. iv, p. 202.

in the medullary portion of the kidney, form, by frequent subdivisions, a series of straight, branching canals, the so-called urinary tubules. After frequent subdivision each branch terminates in a looped tubule, which, after undergoing various convolutions in the cortical portion of the kidney, terminates in a bladder-like expansion. In each of these expansions enters a small branch of the renal artery, the *vas afferens*, which undergoes division into a bunch of capillaries which is so placed as to be surrounded by a double layer of the bladder-like expansion of

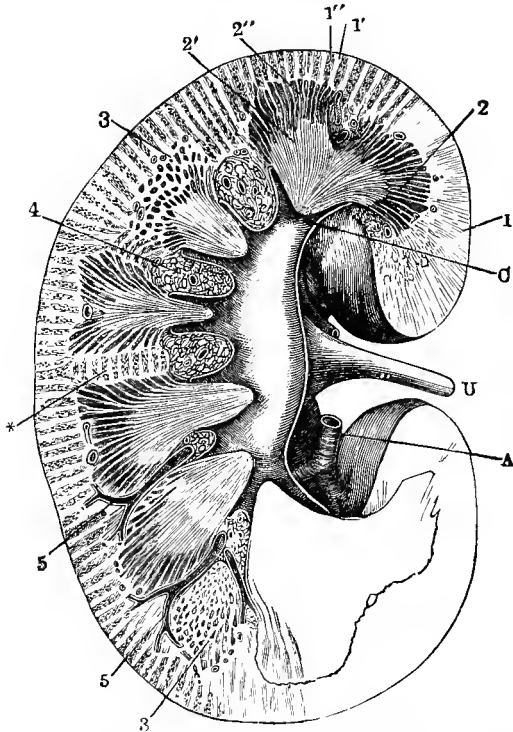

FIG. 265.—NAKED-EYE APPEARANCES OF THE KIDNEY OF MAN, AFTER TYSON AND HENLE. (*Laudius.*)

1, cortex; 1', medullary rays; 1'', labyrinth; 2, medulla; 2', papillary portion of the medulla; 2'', boundary layer of the medulla; 3, transverse section of tubules in boundary layer; 4, fat of renal sinus; 5, artery; \*, transversely coursing medullary rays; A, branch of renal artery; C, renal calyx; U, ureter.

the tubules. The relation between this bunch of vessels and the expansion of the tubules is similar to what would be expected if a tip of the finger of a glove was inverted from the outside. The collection of capillaries is, therefore, in contact with the external layer of the tubule, and is surrounded by a space which is in direct communication with the interior of these tubules. After having undergone subdivision into capillaries in this expansion of the tubules, the efferent vessel, which collects

the blood which has passed through this series of capillaries, again undergoes subdivision into a second net-work of capillaries distributed around the urinary tubules. In the glomerulus is represented the filtration apparatus, in which, through the influence of blood pressure, the substances held in solution in the blood-serum may be removed from the blood and forced into the interior of the commencement of the urinary tubules. The conditions are, therefore, evidently different here, where transudations directly enter into the excretory ducts, from what holds in the case of other glands, where the transudations simply pass into lymph and require some other force for their transference to the secretion.

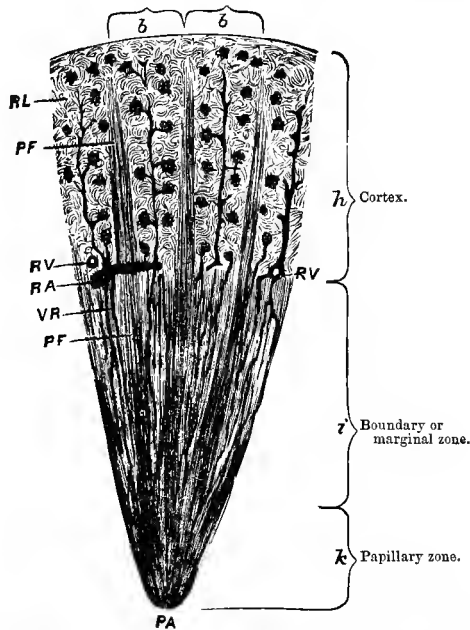

FIG. 266.—LONGITUDINAL SECTION OF A MALPIGHIAN PYRAMID. (*Landois.*)  
 PF, pyramids of Ferrein; RA, branch of renal artery; RV, lumen of a renal vein receiving an interlobular vein; VR, vasa recta; PA, apex of a renal papilla;  $\delta$   $\delta$  embrace the bases of the renal lobules.

That this separation of the constituents of the blood through the glomeruli of the kidney is actually dependent upon the blood pressure is shown by the fact that if the blood pressure be reduced below fifty millimeters of mercury secretion ceases, while if it be increased the secretion is correspondingly augmented. The contrast between this fact and the secretion of saliva is, therefore, very striking.

If, however, pressure is increased by venous obstruction, then, instead of an increased secretion, the reverse takes place. That this does not contradict the filtration hypothesis is explainable by the fact that obstruction of the veins increases the pressure in the capillaries, and these

so expand in the unyielding capsule of the kidney that the urinary tubules are completely compressed, and filtration is, of course, at once arrested.

Various conditions may modify the blood pressure in the kidneys. Thus, for example, the local blood pressure may be increased by general

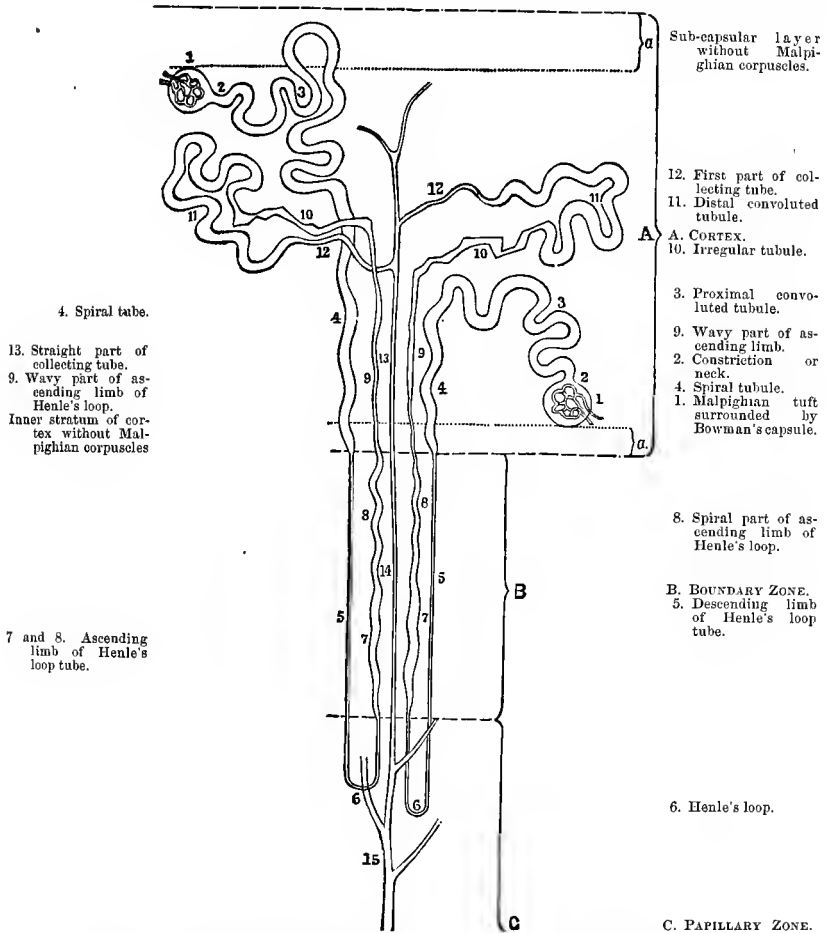

FIG. 267.—DIAGRAM OF THE COURSE OF TWO URINIFEROUS TUBULES, AFTER KLEIN AND NOBLE-SMITH. (*Landöis.*)

increase of blood pressure or by a relaxation of the renal artery, accompanied by the constriction of other vascular areas, which, while diminishing the pressure in the renal artery itself, increases the pressure in its capillaries. Of course, pressure may be reduced in the kidney by the reverse causes.

The principal constituent of the urine which is removed by a process of filtration is, of course, water. Therefore, in the quantity of urine,

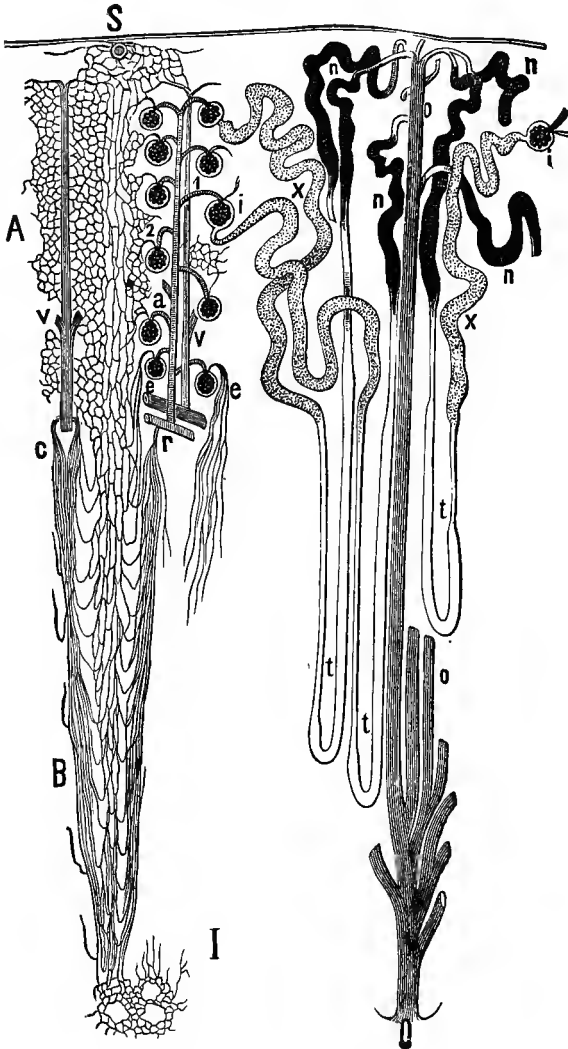

FIG. 268.—BLOOD-VESSELS AND URINIFEROUS TUBULES OF THE KIDNEY (SEMI-DIAGRAMMATIC). (*Landois.*)

A, capillaries of the cortex; B, of the medulla; *o*, interlobular artery; 1, vas afferens; 2, vas efferens; *r e*, vasa recta; *c*, venae rectae; *v v*, interlobular vein; S, origin of a vena stellata; *i i*, Bowman's capsule and glomerulus; X X, convoluted tubules; *t t*, Henle's loop; *n n*, junctional piece; *o o*, collecting tubes; O, excretory tube.

which, of course, means quantity of water, the variations in the activity of the process of filtration may be mainly made out. Wherever the



renal secretion is diminished, it may almost invariably be concluded that the process of filtration has been interfered with by some means or other; and, conversely and as a consequence, the so-called diuretics are, as a rule, substances which directly increase blood pressure and thus facilitate transudation. So, anything which reduces blood pressure in the kidneys will reduce the secretion. Section of the spinal cord acts in this way. By the universal vascular relaxation produced, the blood pressure is reduced in the kidney, as elsewhere, and filtration rendered almost impossible.

Stimulation of the spinal cord acts in the opposite direction by constricting the general vascular areas, together with the renal artery, and yet produces the same result; for the increase of general pressure does not compensate for the increased resistance in the renal artery. As a

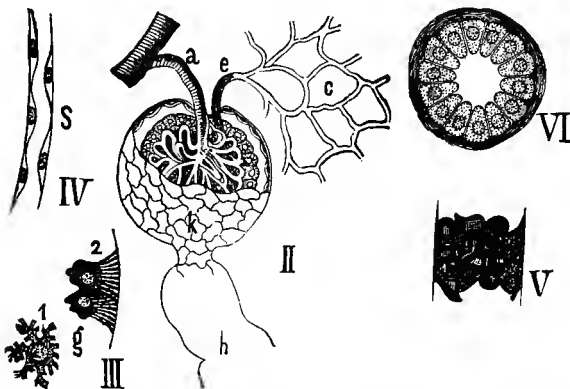

FIG. 269.—THE SECRETING PORTIONS OF THE KIDNEY. (Landois.)

I, Bowman's capsule and glomerulus; *a*, vas afferens; *e*, vas efferens; *r*, capillary network of the cortex; *k*, endothelium of the capsule; *h*, origin of a convoluted tubule. III, "rodged" cells from a convoluted tubule; 2, seen from the side, with *g*, inner granular zone; 1, from the surface. IV, cells lining Henle's loop. V, cells of a collecting tube. VI, section of an excretory tube.

consequence, the flow of blood in the latter is reduced and filtration prevented.

If the local pressure in the kidney be increased, as by section of the renal nerves or by section of the splanchnics, both of which lead to the dilatation of the renal arteries, and hence an increased pressure in the glomeruli, an increased secretion is produced. Conversely, stimulation of the splanchnic or renal nerves arrests filtration by reducing the blood supply to the kidney.

The correlation between the action of the kidneys and skin is explainable on these data: It is known that in cold weather the kidneys are more active than in warm weather, while the reverse holds with the skin. In cold weather the capillaries of the external integument are constricted and the blood pressure in the internal organs is, therefore,

increased and filtration through the kidneys facilitated. As a consequence, the urine in cold weather is of low specific gravity from the large amount of water forced through the glomeruli. In warm weather, on the other hand, the capillaries of the skin are relaxed, general blood pressure is, therefore, reduced and filtration to that extent interfered with, and the urine is now scanty and of a higher specific gravity from the decrease in its percentage of water.

Filtration is not, however, the only process concerned in the formation of urine. This is evident from the examination of the composition of urine; for if it were merely a filtrate from the blood it could contain no soluble constituent in greater proportion than it exists in the blood; for a solution cannot by filtration through a *moist* animal membrane become more concentrated. Yet the urine contains many substances, especially urica, in much larger amount than in the blood, and it must, therefore, be assumed that the fluid which is removed from the blood by filtration through the glomeruli differs in important respects from the urine. It must be almost identical with transudations from the blood in other localities. It is, however, probable that it is free from albumen. For the fluids which leave the blood must traverse not only the walls of the capillaries of the glomeruli, but also the walls of the capsule, and it is well known that such relatively thick membranes offer difficulty to the filtration of albumen.

It is well known that normal urine is free from albumen, and this is to be explained either by the statement above mentioned, or by the assumption that albumen does pass through the glomeruli into the interior of the urinary tubules, but is again absorbed by the epithelial cells lining the looped portion of the tubules. This, however, is perhaps supported by the fact that in kidney diseases, where the epithelium of the tubules is diseased or absent, and absorption, presumably, thus interfered with, albumen is then constantly found in the urine.

It is readily conceivable that various constituents may be added to the urine in its passage through the different portions of the uriniferous tubules. That such is the case is rendered probable by the histological structure of the kidney. The fluid removed by the glomeruli from the blood passes through a series of convoluted tubules lined with epithelial cells similar to those found in other secreting organs and surrounded by a second network of capillaries. The epithelial cells lining the tubules may be regarded as specific secretory cells which are concerned in removing the specific constituents of the urine from the blood. That they are capable of removing substances from the blood circulating in the capillaries may be demonstrated by the injection into the blood-current of indigo carmine, after previous section of the spinal cord, thus preventing the formation of the urinary secretion by filtration. If ani-

mals are killed at various periods after such an injection, indigo carmine may be traced from the blood into the interior of the epithelial cells and from there into the interior of the uriniferous tubules. No trace of this pigment passes through the glomeruli.

This experiment demonstrates that even when the blood pressure is greatly reduced the epithelial cells of the kidney do not lose their activity, but are still able to remove substances from the blood and transfer them into the interior of the tubules.

Certain substances which belong to the group of diuretics produce a flow of urine without at all increasing the blood pressure; such substances are urea, urates, etc. It follows that if the blood pressure has not been increased, or, in fact, may even have been decreased, and yet the flow of urine not be interfered with, some other portion of the kidney besides the glomeruli is concerned in the separation of the water together with the other constituents of the urine.

It is capable of demonstration that urea passes from the blood into the renal secretion through the activity of the renal cells.

In amphibious animals the kidney receives a supply of blood from the renal artery and also from the renal portal system, which is formed by a branch of the femoral vein which joins its fellow from the opposite side to form the anterior abdominal vein.

The renal artery alone supplies the glomerulus; the renal portal vein alone supplies the uriniferous tubules. If the renal artery be tied, the blood is, of course, shut off from the glomeruli, and all filtration is thus prevented. Urea, nevertheless, is still a constituent of the secretion formed by such a kidney, and when urea is injected into the blood it likewise causes a secretion of urine.

On the other hand, substances which are presumably removed from the blood by a process solely of filtration, viz., sugar, peptones, and various salts, do not appear in the urine after the renal artery has been tied.

It is thus evident that the secretion of urine is a double process, partly a process of filtration, in which water and crystalline substances are removed from the blood by a process of transudation occurring in the glomeruli. Everything, therefore, which increases blood pressure in the renal arteries will lead to transudation and to an increase in the watery constituents of the urine.

The renal secretion is also an active secretory process in which the epithelial cells lining the convoluted portions of the uriniferous tubules are concerned in removing the specific constituents of the urine from the blood, while perhaps completing the process of transformation of some of the antecedents of urea into that substance. This subject will again be referred to from this point of view when we consider the problems of nutrition which occur in the animal body.

3. **THE MECHANISM OF MICTURITION.**—The secretion of urine, like the bile, is constant, and if the ureters be divided it will be found that there will be a steady flow of urine, drop by drop. The urine has been described as a pure excretion—that is, it is composed solely of substances which no longer have any office to fulfill in the economy, and which are deleterious and must be removed. Arrest of the renal secretion, or so-called suppression of urine, by preventing the elimination of these substances invariably leads to a fatal result.

The urinary constituents eliminated from the blood through the action of the glomeruli and epithelial cells of the uriniferous tubules pass drop by drop through the straight canals into the pelvis of the kidney, and from there through the peristaltic contractions of the muscular walls of the ureters into the bladder.

The bladder is a muscular organ composed of an internal mucous coat and double muscular coat. The fibres, which are of the unstriped variety, are arranged in oblique and circular layers, the latter being especially developed at the neck of the bladder. Externally situated is a fibrous membrane, while the upper portion of the bladder is covered by the peritoneum. The ureters pierce the vesical walls obliquely, and at the orifice of entrance of the ureters into the bladder is located a valvular fold of mucous membrane. As the bladder fills the increased pressure on its walls tends to obliterate the orifice of entrance of the ureters, and so prevent regurgitation through the ureters back to the kidneys. Sometimes, as a consequence of obstruction to the flow of urine from the bladder, it will be found that the ureters are then the seat of considerable distention. Such distention is not, however, caused by a reflux from the bladder, but is only produced when, the bladder becoming distended to its full capacity, the constant secretion of urine still continues to collect in the ureters behind the bladder. As the urine accumulates in the bladder it rises from the cavity of the pelvis to occupy the lower portion of the abdominal region, where in man, when fully distended, it may be recognized by percussion, and extends from eight to ten centimeters above the symphysis of the pubes.

The urine is retained in the bladder by the normal tonic contraction of the circular sphincter of the bladder, aided by the tonic contraction of the sphincter urethrae and the elastic fibres surrounding the urethrae. As the bladder becomes distended the sphincter becomes relaxed, and the contact of the escaping urine with the upper part of the membranous portion of the urethra causes the desire to urinate. Escape of urine may at this time be prevented by the contraction of the sphincter urethrae muscle, which is a red, striped, voluntary muscle.

In animals and infants this contact of the urine with the mucous membrane of the urethrae starts the process of micturition, which, in

such circumstances, is a purely reflex action, and may be carried on without the assistance of the will.

The state of contraction of the vesical muscular fibres, as was found to be the case as regards the rectum, is governed by a spinal centre located in the lumbar portion of the spinal cord. When the spinal cord is divided in the dorsal region in a dog, after the shock of the operation has passed off the bladder may fill with urine, and, when distended, empties itself in a perfectly normal manner.

The distention of the bladder starts sensory impulses, which are conducted to the spinal cord through the posterior roots of the third, fourth, and fifth sacral nerves. The centre of micturition, which in dogs is situated opposite the fifth and in rabbits opposite the seventh lumbar

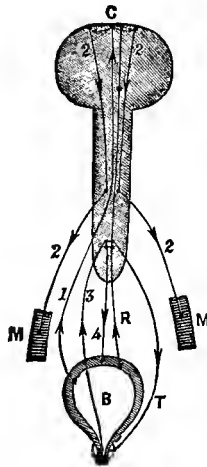

FIG. 270.—DIAGRAM OF THE NERVOUS MECHANISM OF MICTURITION. (Yeo.)

B, bladder; M, abdominal muscles; C, cerebral centres; R represents impulses which pass from the bladder to the centre in the spinal cord, whence tonic impulses are reflected and pass along T to the sphincter which retains the urine. When the bladder is distended, impulses pass to the brain by 1, and when we will, the tonus of the spinal centre stimulating the sphincter is checked, and the abdominal muscles are made by 2 to force some urine into the neck of the bladder, whence impulses pass by 3 to inhibit the sphincter centre and excite the detrusor through 4.

vertebra, is then called into play, and the muscular fibres of the sphincter of the bladder relax, while contractions of the longitudinal fibres, or the so-called *detrusor urinæ* muscle, are called forth.

The contraction of this muscle serves to contract the capacity of the bladder in all directions, its contents are thus forced out through the relaxed sphincter muscle through the urethræ, and urination is terminated by the rhythmical contraction of the bulbo-cavernosus, or ejaculator urinæ muscle.

Ordinarily the emptying of the bladder is assisted by the cooperation of the abdominal muscles in the same way as their contraction aids in defæcation. A deep inspiration is made as the bladder becomes

almost totally emptied, the glottis closes, and the abdominal muscles, contracting, serve to force down the abdominal contents into the pelvis, and so by pressure from above aid the emptying of the bladder. Section of the spinal cord above the level of this centre first causes retention of urine by increasing the reflex activity of the urethral sphincter and by interfering with the conduction of inhibitory impulses from the brain. As soon as the bladder becomes distended the sphincter becomes mechanically dilated, and the urine trickles away in drops, but less rapidly than it enters from the kidney; so the bladder becomes enormously dilated and the retained urine is apt to undergo ammoniacal fermentation. Goltz, however, has seen dogs micturate in a perfectly normal manner after complete division of the spinal cord above the lumbar region.

While urination is thus originally a purely reflex action, it is possible by education to bring it, to a very considerable extent, under the control of the will. The contact of the first few drops of urine with the mucous membrane of the urethræ, instead of inaugurating the act of micturition, may by an exertion of the will lead to an increase of the tonic contraction of the sphincter of the bladder instead of to its inhibition. The act of micturition is thus voluntarily postponed (Fig. 270).

In addition to this voluntary control of the act of micturition, this process is also largely governed by the emotions, and the starting point of the act may originate not only in the distention of the bladder, but in various forms of irritation of the genital apparatus. Such a cause will frequently be found to explain the urinary incontinence of children.

## SECTION XI.

### THE CUTANEOUS FUNCTIONS.

ANOTHER source of loss to the blood occurs in its passage through the capillaries of the external integument by means of the sweat and the sebaceous glands. As already indicated, the waste products of the animal economy are mainly urea and its antecedents, carbon dioxide, salts, and water. In the study of respiration we found that the pulmonary mucous membrane constituted the organ whose function as an excretory organ was mainly concerned in the removal of carbon dioxide, water, and certain organic products from the blood. The kidney we found to be especially active in removing urea, various salts, and water. These two organs constitute the main paths of elimination of substances no longer of use to the economy, and, as a consequence, constitute the most important excretory organs of the body.

The skin may be regarded as an organ supplementary in its action to the lungs and kidneys, since the skin by its secretion is capable of removing a considerable quantity of water from the blood, small amounts of carbon dioxide, and small amounts of salts, and in certain instances during suppression of renal secretion a small amount of urea.

The skin is thus an excretory organ, serving to remove gaseous, liquid, and solid waste products. The skin is also the chief organ for the regulation of animal heat, by, on the one hand, through conduction, radiation, and evaporation of water, permitting of loss of heat, while it also, through mechanisms to be considered directly, is able to regulate the amount of heat lost. Since the skin is more permeable to gases than a dry membrane, a certain amount of gaseous interchange takes place through the skin. The skin further, through the various forms which the epidermal organs may take on, whether hoofs, horns, claws, fur, or feathers, furnishes means of protection and offensive organs. Thus, the hairs (fur or feathers) furnish protection against extreme and sudden variations of temperature by the fact that they are poor conductors of heat, and inclose between them a still layer of air, itself a poor conductor of heat. The hairs are also furnished with an apparatus by which the loss of heat may be regulated; thus, in cold weather, through the contraction of the unstriped muscular fibres of the skin (the *erectores pili*), the hairs become erect and the external coat thus becomes thicker. Further, cold acts as a stimulus to the growth of hair, and we find, as a

consequence, a thicker coat in winter than in summer. This is not only seen in the thicker fur in animals which inhabit a cold climate, as contrasted with the same species in warmer latitudes, but also in the periodic growth and shedding of hair seen in the horse and ox in the change of the seasons. The hairs also furnish protection against wet, from the fact that they are always more or less oily, from the secretions of the sebaceous glands, and thus shed water. The hairs, through their elasticity, furnish mechanical protection, and through the thickness of the coat, to a certain degree, resist the attacks of insects; thus the external auditory meati, the external nares, and the eyes are protected by hairs. Finally, the hairs assist the sense of touch.

1. THE SWEAT SECRETION.—The sweat-glands, which are found only in mammals, occur in their simplest form in the domestic animals in the ox, where they are simply oval sacs, which in man and the horse and in the feet of the dog and cat and snout of the hog become developed into long, convoluted tubes, passing through the entire thickness of the skin.

In the horse the sweat-glands are comparatively highly developed, especially in the inguinal region, where they are also abundant in the sheep. In the ox the sweat-glands, as already mentioned, are rudimentary, and, as a consequence, this animal sweats but very little. Cats, rabbits, and rats do not sweat at all, the carnivora generally sweating only in the soles of their feet.

The sweat is a transparent, colorless liquid with a characteristic odor, varying as to its source from different parts of the skin, with a salty taste. Its specific gravity is about 1004. Its reaction may be said to be normally alkaline or neutral. The frequent acid reaction is to be attributed to the development of fatty acids in the decomposition of fatty matters formed by the sebaceous glands, and which are ordinarily mixed with the perspiration. Its quantity is very variable, governed by conditions to be referred to directly. It may be stated in a general way that, as a rule, twice as much water is given off by the skin as by the lungs, while, as a rule, in man eleven grains of solids are eliminated by the skin in twenty-four hours, in contrast to seven grains removed by the lungs. The sweat contains no structural elements with the exception of epithelial scales, which may be accidentally removed from the epidermis.

The sweat in its composition contains about 1.8 per cent. of solids, of which two-thirds are inorganic and mainly constituted by alkaline chlorides. The nitrogenous constituents of the sweat consist almost solely of urea, which by its decomposition may give rise to ammonia. The non-nitrogenous constituents of the sweat are composed of volatile fatty acids, such as formic, acetic, butyric, propionic, and caproic, which give to the sweat its characteristic odor. Cholesterin and neutral fats



coming from the sebaceous glands are also frequently found in it. The mineral matters are composed mainly of sodium chloride, potassium chloride, phosphates, and alkaline sulphates, phosphatic earths, and traces of iron. The sweat, in addition, contains traces of free carbon dioxide and small amounts of nitrogen.

The following table represents the different analyses of the sweat :—

In 1000 Parts.	Favre.	Schottin.	Funke.
Water, . . . . .	995.573	977.40	988.40
Solid matter, . . . . .	4.427	22.60	11.60
Epithelium, . . . . .	4.427	4.20	2.49
Fats, . . . . .	0.013	4.20	2.49
Lactates, . . . . .	0.317	4.20	2.49
Chlorine sudorates, . . . . .	1.562	4.20	2.49
Extractive matters, . . . . .	0.005	11.30	2.49
Urea, . . . . .	0.044	11.30	1.55
Sodium chloride, . . . . .	2.230	3.60	1.55
Potassium chloride, . . . . .	0.024	3.60	1.55
Sodium phosphate, . . . . .	traces	3.60	1.55
Alkaline phosphates, . . . . .	0.011	1.31	1.55
Phosphatic earths, . . . . .	traces	0.39	1.55
Other salts, . . . . .	traces	7.00	4.36

The quantity of sweat is very variable. In man its amount has been placed at five hundred to nine hundred grammes daily, although under different conditions it may be increased to fifteen hundred or two thousand grammes, or even more. Under all conditions in which the activity of the skin is not absolutely prevented a considerable quantity of perspiration is formed by the skin, the water of which evaporates as rapidly as it is poured out. The secretion of sweat is then spoken of as insensible perspiration. Under other circumstances fluid may be noticed to collect on the surface of the skin, and is then spoken of as sensible perspiration. The proportion of the sensible to the insensible perspiration will depend upon a number of external conditions. Thus, supposing the rate of secretion to remain constant, the dryer and hotter the air and the more rapid the circulation of air in contact with the body, the greater will be the amount of sensible perspiration which undergoes evaporation and is thus converted into insensible perspiration. On the other hand, when the air is cool, and especially when saturated with moisture, evaporation from the surface of the body is prevented, and, even although the rate of secretion by the skin be no greater than in the previous condition, the amount of sweat which remains on the surface of the body as sensible perspiration will be greatly increased.

The total amount of secretion poured out by the skin is not only modified by the condition of the atmosphere, but also by the character and quantity of the food and by the amount of exercise, and especially by the amount of fluid drunk. It is also influenced by the mental conditions, by medicines, poisons, and, as pointed out under the heading of

Renal Secretion, the activity of the skin as a secreting organ is, as a rule, inverse to that of the kidney. As a consequence, in warm weather the cutaneous blood-vessels relax, more blood circulates through the skin, and the perspiration is, therefore, increased, while the amount of water eliminated by the kidneys is decreased. Hence, in warm weather the urine is scanty and of high specific gravity. On the other hand, in cold weather the cutaneous capillaries are contracted, the activity of the sweat-glands diminished, while from the increased blood pressure in the internal organs the activity of the kidney, especially of the glomeruli, is increased, and the urine is now more abundant in quantity and of lower specific gravity.

The formation of sweat is a true secretion and is dependent upon the secretory activity of the epithelial cells of the sweat-glands. The relation between the activity of the sweat-glands and of the blood supply has been very clearly made out. Nearly all conditions which increase the blood supply to a part will lead to an increased secretion of sweat. This, as already mentioned, will probably explain the increased secretion when the skin is subjected to a high temperature.

Bernard also succeeded in producing secretion by the skin by division of the vaso-motor nerves supplying the part. Thus, division of the cervical sympathetic in the horse will cause an abundant secretion of sweat on the corresponding side of the face.

The sweat-glands are further governed by special secretory nerves. This statement is supported not only by the production of sweat in various pathological conditions and in the evident influence of the emotions on the sweat secretion, even in the absence of increased circulation, but also has been demonstrated by direct experiment.

If in a dog or cat the peripheral end of the sciatic nerve be stimulated with an interrupted current, a profuse secretion of perspiration is produced on the balls of the toes. Such a secretion is evidently not produced by modifications of the blood supply; for stimulation of the sciatic nerve, as a rule, may be said to lead to the constriction of the blood-vessels in this part, and the secretion may even be produced after ligation of the blood-vessels of the limb or even after its amputation. Moreover, the vaso-motor effects may be produced, as in the case of the secretion of the saliva, and the secretory effects prevented by the injection of atropine. The analogy, therefore, between the secretion of sweat and that of saliva is clearly established, and we are warranted in stating that the sciatic nerve, like the chorda tympani, contains special secretory fibres whose stimulation leads to an increased activity of the secretory epithelium.

Moreover, experiment enables us to determine that the sweating produced by exposure to high temperature is not solely due to the

increased blood supply of the part, but to direct action on the nervous system. For if the sciatic nerve be divided in a cat, on exposure to high temperature the part removed from the central nervous system will form no secretion, while the other surfaces of the body will form an abundant secretion of sweat, thus clearly showing that heat acts mainly as a stimulant to the secretion of sweat by calling into play the activity of the central nervous system.

Sweat may also be produced by stimulating the central end of the divided sciatic nerve, where, of course, its production is clearly of a reflex nature, and is attributed to the stimulation of the so-called sweat centres located in the spinal cord. The sweat secretion may also be called forth by various drugs, especially by pilocarpine, the alkaloid of jaborandi, which appears to act as a local stimulant to the sweat-glands, although it may also have some stimulating action on the sweat centres. As in the case of the secretion of saliva, it may be antagonized by atropine. The function of the sweat-glands in the formation of sweat is mainly that of an excretory organ, while, added to this, by the evaporation of the perspiration from the external surfaces of the body it exerts a considerable influence as a regulator of the temperature of the body. As a consequence, therefore, when, as in warm weather, the secretion of the skin is increased, the corresponding increase in evaporation tends to prevent the overheating of the body.

2. THE SEBACEOUS SECRETION OF THE SKIN.—In the derm are found a large number of racemose glands whose excretory ducts, as a rule, open into the hair-follicles. The excretory ducts are lined with pavement epithelium, which in the deeper portions gives place to true secretory cells in which a nucleus is present, although only capable of being detected with difficulty, its presence being usually obscured by the large number of fatty globules surrounding it. Such sebaceous glands are not uniformly distributed over the animal body, but are especially developed in points most abundantly supplied with hair. During fetal life the external body surface is covered with a thick layer of sebaceous matter, the so-called *vernix caseosa*, which protects it from maceration in the amniotic fluid. The secretion formed by these glands is a soft, crumbling, fatty mass, suspended in a tolerably small amount of water, and contains a small amount of albuminous matter and considerable amounts of potassium salts and of cholesterolin. The secretion is formed by the activity of the protoplasmic secretory cells, which remove certain substances from the transudations from the blood-vessels, and whose protoplasm itself undergoes fatty degeneration. The secretion, therefore, consists mainly of the breaking down of the cell-contents. It is composed of about 31 per cent. water, 61 per cent. of albuminous matter and epithelium, 5 per cent. of neutral fat and soaps, and 1 per cent. of

inorganic salts. Olein and palmitin are the principal representative fatty bodies, phosphatic earths and chlorides, and salts. The wool of the sheep contains a fatty potassium salt which is soluble in water, and which constitutes at least one-third in weight of raw merino wool.

The function of the sebaceous secretion is to act as a lubricant to the skin and epidermal appendages.

3. **CUTANEOUS ABSORPTION.**—When the body is plunged in a liquid medium, as into a bath, a considerable amount of water is absorbed by imbibition through the epithelium. From there it is able to pass by absorption into the vessels which circulate through the superficial layers of the derm, and from there into the general blood-current. This statement may be demonstrated by the increase in weight which, as a general rule, follows immersion in fluid. The result of such an immersion will, however, vary according to the temperature of the fluid. When the temperature of the bath is above that of the body, the increased secretion from the skin will more than counterbalance the gain in absorption, and, as a consequence, the weight of the body may be decreased. If, on the other hand, the temperature of the bath is lower than that of the body, the body may gain in weight through the absorption of water. The epidermis is, nevertheless, not equally permeable by substances brought into contact with it. And this interference with absorption is also increased by the sebaceous secretion of the skin. Substances held in solution in water are accordingly absorbed but to an extremely slight extent, unless this immersion be so prolonged as to permit of softening of the epidermis.

Absorption through friction of the skin surface with different substances, especially when suspended in a fatty excipient, is to be explained by the mechanical forcing of such substances into the sebaceous glands, and, it may be, even into the interstices of the epidermal cells. Thus, friction with tartar emetic suspended in oils may produce vomiting, with mercury may produce salivation, and with belladonna dilatation of the pupil.

Abrasion of the skin leads to a marked increase in its facility for absorption.

4. **CUTANEOUS RESPIRATION.**—The skin of man and animals in whom the skin is bare offers a certain analogy to the lungs in that it is abundantly supplied with blood-vessels which are nearly in contact with the external atmosphere. It is, therefore, conceivable that through the skin there may be an interchange between the gases of the atmosphere and blood. Experiments show this to be a fact. If the body be inclosed in an air-tight chamber extending to the neck, and after a time the air within this chamber be analyzed, it will be found that it will have decreased in the amount of oxygen and gained in carbonic acid. The

skin is, however, of considerable density, and from its structure, as compared with that of the pulmonary mucous membrane, must offer great resistance to the diffusion of gases. As a consequence, the amount of such interchange which occurs through the skin must be slight. In animals, however, in which the skin is not only bare, but thin and moist, gaseous interchange through the skin may be of much greater importance; thus, for example, it has been found that if the entrance of air into the lungs of the frog be entirely prevented by surrounding the head with a rubber membrane, life may be preserved in contact with the air for several days, and by examining the composition of the atmosphere, if the frog be placed in a confined space, it will be found that the frog has absorbed oxygen and set free carbonic acid. In other words, the frog is able to breathe without lungs, the respiration carried on through its skin being sufficient for its needs.

In cold-blooded animals this degree of cutaneous respiration is much more extensive than in warm-blooded animals, while the function is least developed in warm-blooded animals whose skin is covered with fur, hair, or feathers. In fact, it is probable that whatever gaseous interchange does occur takes place from the capillary net-work surrounding the sweat-glands. The exhalation of carbon dioxide may be readily demonstrated by placing the arm in a vessel containing distilled water and which is closed from the external atmosphere; after an hour's immersion only in the water the addition of lime-water, by the characteristic precipitate of carbonate of lime, will demonstrate its transudation through the skin.

The amount of carbon dioxide eliminated by the skin may be readily determined by collecting the total amount of carbon dioxide liberated both by the skin and lungs and then deducting the latter amount from the total. Or it may be directly measured by closing the body in an air-tight chamber and preventing entrance of the expelled air by breathing through a tube. It has been found in this way that the amount eliminated by the lungs is, in man, about one hundred and thirty times as much as passes through the skin. The following experiments by Regnault and Reiset indicate this amount in the rabbit and dog:—

ANIMAL.	Body Weight in Grammes.	Duration of Experiment in Hours.	CO <sub>2</sub> Exhaled in Grammes.	
			Through the Skin in One Hour.	Through the Lungs in One Hour.
Rabbit, .	2425	{ 8 hours 25 minutes 7 hours 25 minutes	0.358 0.197	20.63 19.38
Dog, .	4159	{ 7 hours 33 minutes 8 hours 50 minutes	0.136 0.176	39.15 42.50

It was long ago noticed that if the skin be covered with a thick varnish death will be rapidly produced. The most probable explanation is that in addition to the rapid cooling of the body by the dilatation of the cutaneous capillaries the suppression of perspiration causes the retention in the economy of some poisonous principle, for the general symptoms closely resemble those of poisoning—the respiration becomes slow and disturbed, the pulsation of the heart reduced in frequency, and convulsions frequently accompany the final stages.

5. THE LACHRYMAL SECRETION.—The lachrymal glands belong to the group of compound racemose glands, and secrete a fluid which is tolerably rich in albuminous constituents. The tears are a colorless liquid of salty taste and alkaline reaction. They contain about 1 per cent. of solids, which consist of a small amount of mucus and albumen, coagulable by heat, and traces of fat and mineral salts. Of the latter sodium chloride is the principal representative, with a small quantity of alkaline and earthy salts.

The following table represents their analyses:—

Water,	982.00
Albumen and traces of mucus,	5.00
Sodium chloride,	13.00
Other inorganic salts, . . . .	0.2

The lachrymal secretion is continuous and is produced by the direct protoplasmic activity of the secretory cells of this gland: the blood pressure is of special influence, and it is probable that the lachrymation which accompanies laughing, coughing, vomiting, etc., is produced by local increase of pressure through the arrest of the venous circulation.

The lachrymal secretion, like that formed by the other glands, is under the control of the nervous system. Normally the lachrymal secretion is of reflex origin, the afferent impulse being conducted either from the conjunctiva or nasal fossæ, over the first and second branches of the trigeminal nerve, from a retinal stimulation, as by intense light, or through some mental impression. As a rule, such stimuli lead to an increased secretion of the glands on both sides, with the exception of stimuli originating in the nasal fossæ or conjunctiva, in which case the secretion is unilateral. The secretory nerve is the lachrymal nerve. Its stimulation is followed by an abundant secretion of tears, while its section is followed after a time by a continuous secretion corresponding to the paralytic secretion which follows section of the chorda tympani.

Normally the tears, after passing over the anterior surface of the eyeball, partially evaporate and partially are conducted through the lachrymal passages to the nose, only when in excess overflowing the lower eyelid and running over the cheeks. The function of the tears is to protect the eye by keeping its surface moist and to wash away foreign bodies.

## SECTION XII.

### NUTRITION.

It has been found that the blood is constantly losing portions of its constituents in the formation of the different secretions and excretions of the body and in supplying nutritive substances to the different tissues. The excretions and the substances removed from the blood in supplying the tissues with nutriment are to be regarded as permanent losses to the blood, since in the former case the substances so separated are conducted directly without the body, while in the latter case they undergo modifications in the tissues which deprive them of all nutritive value. In the case of secretions, on the other hand, it has been found that the losses which the blood undergoes in their formation are temporary, the matters removed from the blood in these processes being again returned to it after the secretions have fulfilled their function. The milk alone is an exception to this statement.

On the other hand, we have seen that in absorption from the alimentary canal the blood is constantly receiving additions. The balance between this income and outgo of the blood constitutes nutrition. If the income exceed the outgo the body increases in weight; if the latter predominates, the body loses weight.

Two methods are open to us for studying the processes which are concerned in the maintenance of nutritive equilibrium. We have found that the income of the body or the substances which enter the blood and lymph in the form of peptone, sugar, albumen, salts, and fats are constituted of the elements of carbon, hydrogen, oxygen, and nitrogen in various proportions. It has been seen that the waste products of the animal body are urea, carbon dioxide, water, and salts.

We know that nearly all the carbon taken in the food is removed by the lungs and skin in the form of carbon dioxide; we know that nearly all the nitrogen taken in with the food is excreted in the form of urea. All the hydrogen is excreted in the form of water, while the oxygen leaves the animal economy in combination with carbon as carbon dioxide, or with hydrogen as  $H_2O$ .

The attempt to trace the intermediary stages through which the constituents of the food pass before reaching these final excretory products is accompanied by the greatest difficulty. But little is known as to the way in which these substances are transformed one into the

other, or as to the manner in which energy is set free and made use of. Certain of these processes of conversion may, however, be followed, and the fact that these processes may in certain instances be located in special tissues, in the continuation of the plan of specialization of function, we are, perhaps, warranted in speaking of certain tissues as set aside to elaborate the raw materials which result from the absorption of digestive products and to so modify the waste products as to permit of their ready removal from the body. Such tissues are spoken of as metabolic tissues, and the study of the chemical changes which occur in these tissues furnishes us with one method of tracing the conversion of the substances absorbed into the matters excreted.

The other method of studying the nutritive phenomena of the animal body is what is known as the statistical method.

We may, by chemically examining the composition of the food-stuffs, ascertain the total quantity of each constituent. By chemical analysis we may also determine the total amount of these different constituents removed from the body in the excretions. By the comparison of the results obtained in these two examinations valuable conclusions may be drawn as to the changes which occur in the body in the conversion of the income into the outgo. These methods will be referred to in turn.

#### I. THE FATE OF THE ALBUMINOUS FOOD-CONSTITUENTS.

It has been seen that the albuminous food-constituents in digestion, through a process of hydration by the action of ferments, are converted into peptone, which enters through absorption into the radicals of the portal vein, but an insignificant portion being absorbed by means of the lacteals. When once within the blood-current, possibly in the process of absorption itself, the peptone must apparently be reconverted to the form of albumen, for the amount of peptone capable of detection in the portal vein, even after an abundant albuminous diet, is too insignificant to represent the amount of albuminous matters absorbed. We may, therefore, state that almost immediately on entering the blood-current the albuminous food-constituents are converted mainly into serum-albumen. It has further been stated that urea represents the end product in the series of decompositions which the albuminous bodies of the tissues undergo. The attempt to trace the changes, commencing with albumen and terminating in the production of urea, is, however, shrouded with the greatest obscurity. It is known that the amount of urea removed gives an index of the amount of albuminous destruction occurring in the animal body. Numerous experiments have proved that with the withdrawal of all food the excretion of urea decreases, and that a small amount continues to be removed through the urine until the occurrence of death through starva-



tion, this evidently being formed at the expense of the albuminous constituents of the tissues. It is further clear that the excretion of urea may be increased by an albuminous food, and that the amount of urea eliminated increases proportionately to the increase in the albumen given in the food. Urea is not, however, a simple product of oxidation of albuminous bodies, but is a product of complicated decompositions which are peculiar to the animal body, and which are accompanied by the production of such bodies as kreatin, allantoin, guanin, xanthin, and uric acid. It is not improbable that the albumen, like many of these intermediary products, retains the nitrogen in the form of a cyanogen radical, and that it is only in its conversion into urea that by the re-arrangement of the nitrogen it becomes converted into a member of the amide group.

In the sketch which we have given of the chemical processes occurring in the animal body it was mentioned that uric acid might be regarded as an antecedent of urea, since the administration of uric acid to animals is followed by an increase in the amount of urea removed by the kidneys. This, however, applies only to the case of mammals, for the reverse is noticed in birds, where the administration of urea increases the uric acid of the urine, indicating in the latter case a process of synthesis rather than of destruction. It cannot be assumed, however, that urea is invariably preceded by the production of uric acid, or, in other words, that it results from a further oxidation of the latter.

From an examination of the constituents of the different tissues, such as the muscles, the liver, the spleen, and all organs in which it is known that the destruction of albuminoids takes place, the detection of nitrogenous crystalline bodies, such as kreatin, xanthin, hypo-xanthin, etc., would indicate that they are also products of the destruction of albumen and perhaps antecedents of urea. In the case of kreatin it has been found that muscular tissue, under nearly all circumstances, will contain from two-tenths to four-tenths of 1 per cent. of this body; and since kreatin is a diffusible, crystalline body, it must further be assumed that large quantities of it are continually entering the blood-current from the muscular tissue. An examination of the urine again shows that kreatin and kreatinin, into which the former is readily converted, are constant constituents, and the supposition might at first appear warrantable that the kreatin formed in the activity of muscular tissue after entering the blood is at once removed without change by the kidneys. This hypothesis is, however, negatived by the fact that increased muscular activity, which leads to the increase in the formation of kreatin, does not lead to increase in the kreatin eliminated by the kidneys. On the other hand, during starvation the kreatin entirely disappears from the urine; so that it would, therefore, appear that the kreatin eliminated through the kidneys does not represent tissue waste, but a product of

the breaking down of the albuminous food-constituents which has commenced in the intestinal canal, perhaps through the formation of leucin and tyrosin. Again, it seems clearly established that increase in muscular exercise leads to an increase in the elimination of urea. Since, as has been stated, the amount of kreatin formed by the muscles increases with exercise, and the amount of urea eliminated by the kidneys increases under the same circumstances, it would appear warrantable to assume that the kreatin resulting from the breaking down of the albuminous tissue-constituents of muscles and nerves represents the main source of urea. As to where this conversion—which, it should be stated, can only be acknowledged to have a certain degree of probability—takes place, but little positive information can be given.

It does not occur solely in the kidney, for the suppression of urine is followed by an accumulation in the system of a large amount of urea. Again, the urea, under all circumstances, is a constant constituent of the blood, indicating that even if a part of the urea be formed in the kidneys the renal epithelium is not the sole source of the manufacture of this body. As to where kreatin becomes converted into urea no data can be given.

Another possible source of urea may be found in the products of the decomposition of albuminous matter in the intestine. It has been seen that the introduction of a large amount of proteid in the alimentary canal is followed by a corresponding increase in the amount of urea eliminated. It is further known that the excess of proteid over and above that needed for nutrition in the alimentary canal breaks down under the influence of pancreatic digestion into leucin and tyrosin. If leucin be itself introduced into the intestinal tube the amount of urea eliminated will be proportionately increased. Leucin, therefore, may represent a step in the processes of conversion of albumen into urea. In the latter case we can probably locate the conversion of leucin into urea in the liver, for the liver, unlike other glands, normally contains large quantities of urea; and if we again assume, as perhaps seems warranted, that the leucin is absorbed by the portal vein, the formation of urea out of leucin would be a natural conclusion.

Uric acid has also been found to be a constant constituent of the urine of carnivora and of sneaking herbivora. It is never met with in the free condition, but in the form of uric acid salts. In the urine of birds and reptiles it replaces urea. It also evidently results from the decomposition of proteids, and, perhaps, under certain circumstances, is an antecedent of urea, since by oxidation one molecule of uric acid may be split up into two molecules of urea and one molecule of mesoxalic acid. This is not, however, to be regarded as invariably taking place, but the majority of evidence would, perhaps, point to the formation of

uric acid by a process of decomposition of albuminous matters, differing slightly from that which results in the production of uræa. Sarkin and xanthin, by progressive oxidation, might perhaps be converted into uric acid, and, since they are usually found accompanying each other, will, perhaps, indicate one source of uric acid.

Sarkin, xanthin, and uric acid differ from each other only in one atom of oxygen, thus:—

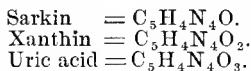

As to where this conversion takes place we have no data to fall back on, except that it does not occur in the kidneys, for the excision of the kidneys or the ligation of the renal vessels leads to an accumulation of uric acid in the economy. Of the different localities where uric acid is especially met with the spleen occupies the first position. In the spleen uric acid is constantly found in large quantities, even in the herbivora, whose urine is free from uric acid; and conditions which lead to an increased blood supply to the spleen, as in its enlargement in malarial diseases, lead also to an increased excretion of uric acid. The spleen may therefore be looked upon both as the place of origin of uric acid in the carnivora and of its destruction in the herbivora.

In the herbivora uric acid is represented by hippuric acid, which differs from uric acid in containing three atoms less of nitrogen, one atom more of carbon, and five atoms more of hydrogen.

Its formula is, therefore,  $\text{C}_6\text{H}_9\text{NO}_3$ .

In the herbivora the hippuric acid of the urine represents a peculiar decomposition occurring in their food. Hippuric acid is a compound of benzoic acid and glycochol, and the administration of benzoic acid to any animal, whether carnivorous or herbivorous, will result in the elimination of hippuric acid through the kidneys.

This process of synthesis may be represented as follows:—

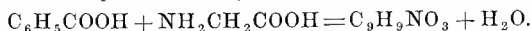

Hippuric acid has, therefore, its origin in the food. As long as the herbivora are being suckled, or when fasting, it is absent from the urine, but appears whenever vegetable matter is added in sufficient quantity to the food. Certain forms of vegetable food are not, however, followed by the elimination of hippuric acid. Hippuric acid is absent from the urine of animals fed on peas, wheat, oats, or potatoes, but nearly all grasses are, however, followed by its appearance in the urine.

When benzoic acid is given to animals, hippuric acid is invariably found in the urine, and an examination of the vegetable matters whose use as food is followed by the formation of hippuric acid will nearly always indicate the presence in such foods of benzoic acid or some allied body.

Glycochol, through whose union with benzoic acid hippuric acid is formed, is manufactured in the liver, the formation of hippuric acid occurring probably both in the liver and kidneys.

## II. THE FATE OF THE FATTY CONSTITUENTS OF FOOD.

It has been found that the fats contained in the food are largely absorbed unchanged in the form of an emulsion, a small fraction only being converted into fatty soaps. Such absorption was, moreover, found to occur mainly by means of the chyle-ducts and only partially through the blood-vessels. It may, therefore, be stated that fats are absorbed unchanged in the forms in which they enter the alimentary canal. The attempt to trace the progress of the fats through the animal body will be aided by the study of the changes which occur in the adipose tissue. This, of all the tissues of the body, varies most rapidly and in widest extremes. Within a short space of time, as in starvation, the adipose tissue of the body may almost totally disappear; while, on the other hand, it may, under exceptional circumstances, accumulate with the greatest rapidity. In describing the histology of adipose tissue it was stated that the oil-globules appeared in the centre of the connective-tissue corpuscles and at their expense, and the process was likened to the nutritive prehension of food in a small mass of undifferentiated protoplasm, such as the amœba.

The fat, we have seen, enters the blood in all important respects unchanged, and the simplest explanation of the development of the adipose tissue would be to suppose that the connective-tissue corpuscles, by a process of vital appropriation, pick out the oil-globules from the fluid in which they are bathed. Several difficulties, however, oppose this simple theory. In the first place, it is well known that but a small amount of fat deposited in adipose tissue can come directly from the fat of the food: for, as is well known, the butter in cream is far in excess of the fat contained in the food, and it has been shown that in a fattening hog for every one hundred parts of fat in the food four hundred and seventy-two parts are stored up as adipose tissue. Again, if animals are fed on a meat diet and soaps they accumulate adipose tissue—a process which is scarcely capable of being explained by the re-transformation of the fats by taking up glycerin and giving up alkali.

On the other hand, the fats of different animals differ in composition, and if two animals of different species are fed with the same fat the chemical composition of their adipose tissue will vary. Thus, for example, if a dog be fed with meat, palmitin, stearin, and soap, the fat of its adipose tissue will be found to contain olein fat as well as palmitin and stearin. So it is, therefore, clear that the latter neutral fat must have been manufactured by the organism.

If a lean dog be fed on a diet of meat and spermaceti, a large amount of adipose tissue may be accumulated, in which, however, but a trace of spermaceti may be found. Again, fat alone, as we know, is incapable, as a food, of sustaining life, although it, to a certain extent, saves the wasting of tissue; so, as a consequence, when fat alone is given as a food, the amount of urea excreted by the kidneys is less than would be excreted by a starving animal. This, evidently, is to be explained by the fact that fat, being readily oxidized, is rapidly converted into carbon dioxide, which is, of course, eliminated in the expired air and serves to a certain extent to spare the elimination of the proteids in oxidation.

It is, then, clear that in the animal body fats are made from something which is not fat. Two possible sources of fat suggest themselves. It is known that the nitrogen of urea represents the total amount of nitrogen passing through the body, and that a certain quantity of urea (one hundred grammes) represents a certain quantity of proteids (three hundred grammes). If, however, we estimate the quantity of carbon in one hundred grammes of urea, we will find that a large amount of carbon remains unaccounted for. Part of this evidently goes off as carbon dioxide. It is probable that the remainder is fixed in the body as fat. It may, therefore, be assumed that proteids split up into non-nitrogenous and nitrogenous compounds, the former, when not completely oxidized into carbon dioxide and water, being deposited as fat, the latter leaving the body oxidized as urea. Other illustrations as to the development of fats from proteids may be readily given. Thus, in the pancreatic digestion of proteids fatty acids may be developed. The fatty degeneration of muscle is evidently due to the decomposition of proteids, while animals fed on a pure diet of lean meat with a small amount of fat will deposit in their tissues more fat than is contained in the food.

Still other lines of study point to the development of fat from proteids. It is known that in poisoning with phosphorus various organs rich in proteids undergo fatty degeneration, and that the fat so formed is produced at the expense of the tissue-albumen, the fat being formed from the non-nitrogenous residue of the proteids after the formation of urea. The following experiment proves this:—

A large dog was allowed to fast for twelve days, so freeing its tissues almost entirely from fat, and was then slowly poisoned with phosphorus. Death occurred on the twentieth day of fasting. Before poisoning, from the fifth to the twelfth day of fasting, the elimination of urea in the urine was about constant, and amounted to 7.8 grammes daily; as a consequence of the phosphorus poisoning the elimination of urea was greatly increased, amounting at last to 23.9 grammes daily, or more than three times the normal amount removed during fasting. The post-mortem examination showed extensive fatty

degeneration of various organs, the increase in urea elimination proving that the fat was derived from the albumen.

As regards the carbohydrates, which may also be regarded as a possible source of fat, considerable doubt exists as to the manner in which they act. As is well known, carbohydrates are always an important constituent of fattening foods, and it may be assumed either that the carbohydrates, being themselves readily oxidized, save the non-nitrogenous bodies derived from the proteids, and so enable them to be converted into fat, or that they may be directly concerned in the formation of fats. It is clear that carbohydrates may undergo the butyric acid fermentation, and other ferment actions might likewise serve to manufacture other fats. Thus, Pasteur claims that glycerin, which is the basis of neutral fats, may be formed from pure carbohydrates. It is probable, therefore, that in both of these ways the carbohydrates serve to increase the adipose tissue of the body both directly and by enabling the non-nitrogenous matters derived from the proteids to be converted into fat and stored up as such.

The following experiments recently made in Vienna with a hog thirteen months old and weighing one hundred and forty kilos are of special interest in this connection: Two kilos of soft-boiled rice were given daily as fodder, and a comparison of the income and outgo demonstrated the daily deposit in the tissues of thirty-eight grammes of albumen and 351.8 grammes of fat. For the development of the latter at most only 65.4 grammes of proteid in the food, corresponding to 33.6 grammes fat and 7.9 grammes fodder fat can be reckoned on. The excess ( $351.8 - 41.5 = 310.3$  grammes), or 88.2 per cent. of the entire amount of fat deposited in the body, can only have been derived from the carbohydrates of the food.

So, also, in the case of geese and bees, the development of fat from carbohydrates admits of proof. The dog, however, like other carnivora, seems incapable of developing fat from carbohydrates.

### III. THE FATE OF THE CARBOHYDRATE FOOD-CONSTITUENTS.

The metamorphosis of the carbohydrate food-constituents may be somewhat more readily followed. It has been seen that under the influence of the salivary, pancreatic, and intestinal ferments, starch and dextrin are turned into maltose and cane-sugar into invert-sugar, the sugar as such entering the blood by absorption; or, in a rich amylaceous diet, splitting up in the intestine into lactic and butyric acids. In the blood, the sugar is either reconverted to a member of the starch group (glycogen) in a process to be considered directly, or is rapidly oxidized into  $\text{CO}_2$  and  $\text{H}_2\text{O}$ , the intermediary products being, however, unknown. That sugar is directly oxidized would seem probable from the fact that

when on an amylaceous diet a larger proportion of the inspired oxygen is returned to the atmosphere as  $\text{CO}_2$  than when on animal diet. It would appear, however, from the fattening which occurs on excessive carbohydrate diet, that this oxidation is not complete, but that part of the carbohydrates remain in the body. It has been already mentioned that albuminoids may split up into fat, and it will be shown under the statistical consideration of nutrition that the addition of carbohydrates to a rich albuminous diet spares a certain amount of albumen from destructive oxidation, and in this way carbohydrates may lead to the deposit of fat. On the other hand, the connection between the carbohydrates and fat must be closer than this, for bees on a pure diet of sugar are able to manufacture wax,—a substance closely allied to the fats. Besides, it has been shown that in the putrefaction of carbohydrates, in addition to lactic, butyric, and caproic acids, fixed fatty acids are also developed; and, since a similar fermentation occurs in the alimentary canal, it is possible that these fatty acids are in the body converted into neutral fats.

The seat of the oxidation of the carbohydrates is to be found mainly in the muscles, as evidenced by the shortness of breath produced by excessive muscular exertion, for it is only natural to suppose that the more rapid breathing is to enable the body to get rid of the decomposition products normally removed through the lungs, *i.e.*,  $\text{CO}_2$ , and to introduce larger amounts of oxygen. The fact may, however, be proved directly by estimating the  $\text{CO}_2$  in the venous blood coming from a contracting and resting muscle. That the  $\text{CO}_2$  thus formed in muscular action is from oxidation of the carbohydrate, and not albuminoid muscle constituents, is proved by the following facts: An animal in a given time accomplishes a certain amount of muscular work, and by the estimation of the urinary constituents it may be determined how much albumen has undergone oxidation. The comparison of the amount of work represented by the combustion of this amount of albumen and the amount actually accomplished shows that the latter must have been at the expense of the combustion of some other substance than albumen. This substance, in all probability, consists of carbohydrate material.

In addition to the changes already sketched, the carbohydrates are closely concerned in the function of glycogenesis, or the formation of glycogen in the liver,—one of the processes of metabolic change which has been most clearly localized. When comparative estimates are made as to the amount of sugar contained in the hepatic and portal veins, contrary to what would be expected, it will be found that in the hepatic vein sugar is constantly found, even though none may be present in the blood of the portal vein. So far, therefore, from destroying sugar, as was formerly supposed, the liver is evidently concerned in the manufacture

of sugar. Even after death, if the blood be removed from the liver by injecting water through the portal vein, it will be found that after every trace of sugar has disappeared, if the liver be allowed to stand for a time in a warm place, the repetition of these injections will again remove sugar from the liver.

If the liver be removed from an animal immediately after death and divided into two portions, if one of these is thrown immediately, after rapid mincing, into a large quantity of previously prepared boiling water, an opalescent decoction will be obtained which will contain barely a trace of sugar. If a decoction be made of the other portion of the liver, after allowing it to remain for several hours in a warm place, the decoction will be clear, and not opalescent, and will contain large quantities of reducing sugar.

On the other hand, if to a small quantity of the opalescent decoction which was free from sugar be added a few drops of saliva, or of the diastatic ferments of the pancreatic juice, sugar will be abundantly formed.

It is evident, therefore, that the liver contains something which is capable of being converted into sugar through the influence of some ferment contained either in the liver-cells or in the blood.

If the opalescent infusion be tested with iodine, a mahogany-red color will be formed; it is evident, therefore, that this substance is somewhat of the nature of dextrin or starch, and Bernard, its discoverer, gave to it the name of glycogen.

Glycogen may be obtained from such a decoction, after rapidly cooling by surrounding it by a freezing mixture of snow and salt, by the alternate addition of hydrochloric acid and the potasso-mercuric iodide solution\* until no further precipitate occurs. By this means the albuminous constituents are removed. This precipitate should be filtered off, and glycogen may be precipitated from the filtrate by the addition of alcohol until about 60 per cent. of absolute alcohol is present in the mixture. The glycogen is then to be collected on a filter and washed with 60 per cent. alcohol until the washings give no cloudiness with a mixture of dilute caustic potash, ammonia, and ammonium chloride. It is then to be washed with alcohol and ether. The glycogen remaining should then be dried on a piece of porous earthenware at a moderate temperature. It may be further purified, if necessary, by dissolving in hot water and precipitating with alcohol containing a little ammonia, redissolving as before, and precipitating with spirit containing a little acetic acid.

This last precipitate should then be washed with alcohol and ether, and then dried.

As obtained by this method, glycogen is a white, amorphous, non-nitrogenous substance, which, with water, forms an opalescent solution and rotates the plane of polarized light strongly to the right to about

\*The potasso-mercuric iodide solution is prepared by precipitating a saturated solution of potassic iodide with a saturated solution of mercuric chloride, and, after washing the precipitate, making a saturated solution of it in a hot solution of potassic iodide.



three times the degree possessed by grape-sugar; it is inodorless and insoluble in alcohol or ether. Under the action of the salivary or pancreatic ferments, namely, diastase, or the action of dilute mineral acids, it is converted, like other carbohydrates, into a mixture of maltose and dextrin. Its formula may be given as a multiple of  $C_6H_{10}O_5$ .

Glycogen is not confined to the liver-cells, although its presence may be recognized there by treating a section of hepatic tissue with iodine, when it may be recognized by the characteristic red staining with iodine in the neighborhood of the cell-nucleus. It is present, also, in the placenta, in muscular tissue, white blood-cells, the brain, and in various embryonic tissues. From the fact that it is found in largest amount in growing tissue it would appear to be especially concerned in the phenomena of development.

The amount of glycogen which may be present in the liver varies in very wide amount, from a maximum to an absolute absence, the amount being dependent upon the state of the nutrition of the animal. If a rabbit is allowed to starve to death, and its liver be treated as described above, it will be found that the decoction of the liver will be absolutely free from glycogen. In other words, it would appear that the glycogen is derived from the food-stuffs which are absorbed by the walls of the alimentary tract and are carried by the portal vein to the liver. If it be determined by experiment how long starvation must be continued to remove all traces of glycogen from the liver, and after the lapse of such an interval the animal be abundantly supplied with carbohydrate food and then killed, it will be found now that the liver has regained its store of glycogen, and that the decoction now made will show the maximum quantity of glycogen present. If after starving for the same length of time the animal be fed with a meat diet, a certain amount of glycogen will also be detected in the liver, but in much less amount than after the carbohydrate diet.

The question arises at this point as to whether the glycogen so developed originates from the albuminous constituents of the meat diet, as it is known that meat, especially the meat of the horse, which is employed in such experiments, contains representatives of the carbohydrate group. This question may be settled by substituting a pure albuminous substance as diet, and it will then be found that although the amount of glycogen obtainable from the liver is larger than that obtained from a starving animal, it still falls below the amount obtained after feeding with meat. It would, therefore, appear that the development of glycogen on the meat diet is only partially due to the conversion of the albuminous constituents of the food into glycogen, but mainly to the carbohydrate constituents.

If a starving animal be fed on a fat diet, even though abundant, no

more glycogen will be found in the liver than would be obtainable from this organ in a starving animal. It would, therefore, appear that while the amount of glycogen in the liver is dependent upon the food, it is especially the carbohydrates which are the sources of this substance.

As already stated, the digestible carbohydrates in the alimentary canal are converted into some form of sugar, are absorbed by the intestinal walls, and enter the blood of the portal vein, and are thus carried to the liver. As is well known, the food of herbivora is constituted largely of carbohydrates, and these substances can only be absorbed after being converted into sugar. On the other hand, it is well known that the presence of sugar in the blood above a very small percentage at once leads to its elimination through the kidneys, constituting glycosuria. Admitting, therefore, that large quantities of sugar in these animals enter the blood through the walls of the alimentary canal, two possibilities arise—either it is eliminated as rapidly as absorbed, or it at once, through combustion, serves in the development of heat.

Neither of these possibilities are, however, actually the case, since even after the richest carbohydrate diet but traces of sugar are to be found in the urine, and it is not conceivable that the large amount of sugar which may be absorbed in the food at once is converted into carbon dioxide and water.

The only remaining conclusion is that the sugar at once, after its absorption, is carried by the portal vein to the liver, and is there converted into some less diffusible form by which its immediate excretion by the kidneys is avoided. Such a substance is evidently found in glycogen, and the liver may, therefore, be regarded as a storehouse for one of the most important food-stuffs, which is again reconverted into sugar, as the needs of the economy demand.

Bernard believed that there is a continual conversion of glycogen into sugar going on in the liver, and that the sugar so formed is carried by the hepatic vein to the general circulation to be oxidized in the lungs and muscles.

It is evident that this hypothesis necessitates the presence of a larger amount of sugar in the hepatic than in the portal vein, and such a state of affairs is claimed by Bernard to be a fact, although his statements have met with a certain amount of contradiction. It may, however, be concluded that even if the estimates made by Bernard as to the comparative amount of sugar in the hepatic and portal veins are not absolutely conclusive, the statements of his opponents are no more trustworthy.

As to the ultimate end of the sugar derived from the conversion of the glycogen, but little can be accurately stated. It is known that normal blood contains always a definite amount of sugar. If this

amount be increased, sugar appears in the urine, and it appears that the sugar in the blood is largely made use of in the chemical processes occurring in contracting muscles. It would seem, therefore, that the object of the glycogenic function of the liver is to store up in a non-diffusible form the excess of carbohydrate matter taken into the blood during a meal rich in carbohydrates, and then to distribute it, little by little, to the economy as occasion may demand.

The liver converts glycogen into sugar through the action of its own peculiar diastatic ferment.

If a fragment of liver be washed with water and then with spirit to remove the blood, and then cut up into small pieces and immersed in absolute alcohol for twenty-four hours, if the alcohol be removed and a glycerin extract made of the residue, a solution will be obtained which will be capable of rapidly converting glycogen infusion into sugar.

In the process of making the decoction of glycogen this hepatic ferment is destroyed by heat, while in the experiment above alluded to, in which the liver was exposed to a warm temperature after removal from the body before making an infusion, the absence of glycogen from such infusion and the presence of sugar indicate the conversion by this hepatic ferment of the glycogen into sugar. Such a conversion also undoubtedly takes place during life. As to why, during life, all the glycogen of the liver is not rapidly converted into sugar, it being admitted that such a ferment is present, it can only be stated that this problem belongs to the same group of phenomena as to why the blood does not coagulate in the living blood-vessels, why the active and living pancreas and stomach do not digest themselves, and why the living muscle does not become rigid. That this process of conversion is, however, capable of occurring in the living liver, and that this ferment is not, as has been claimed, simply a post-mortem development, is proven by the various conditions which lead to the abnormal conversion of glycogen into sugar in greater amounts than the system can use, and the consequent elimination of the excess of sugar from the blood by the kidneys, constituting the disease glycosuria, or diabetes mellitus.

Bernard discovered that if the medulla oblongata be punctured in the neighborhood of the vaso-motor centre in a rabbit, after abundant feeding with carbohydrates, in an hour or less a considerable quantity of sugar may be detected in the urine, which, after a day or two, will disappear.

If a similar operation be performed on a rabbit which has been deprived of food for several days, no such glycosuria will result, and it therefore seems clear that this diabetic puncture produced the glycosuria through the rapid conversion of the glycogen of the liver into sugar. It therefore appears that the glycogenic function of the liver is under

the control of the nervous system, and the path of this influence, which originates in the neighborhood of the vaso-motor centre, may be traced along the spinal cord, and then, by means of the vagi, to the third and fourth dorsal ganglia, from this to the thoracic ganglia, and from there to the liver by some path not yet absolutely determined.

The production of diabetes by such an operation is probably to be regarded as of a vaso-motor nature. It seems clear that through this operation the small branches of the hepatic artery are largely dilated, and the liver, consequently, receives a larger amount of arterial blood, and that simple division of any part of this nervous path, such, for example, as removal of the first thoracic ganglion, will likewise produce diabetes.

If the splanchnic nerves be divided previous to this operation glycosuria will not result, evidently by withdrawing a large quantity of blood into the abdominal organs and so preventing relatively any dilatation of the hepatic artery.

#### IV. THE STATISTICS OF NUTRITION.

The preceding sketch as to the fate of the different organic food-constituents gives but an imperfect idea as to the metabolic processes occurring within the animal body. By a close comparison of the income and outgo of the economy statistics of nutrition may be formed which are of great value for obtaining an idea of the nutritive processes of the economy under different forms of diet, and thus assist in the formation of scientific methods of feeding.

When we compare the income with the outgo, the ingesta with the excreta, we learn not only what part of the ingesta is retained in the body, but by the detection of substances in the excreta not present in the food we may extend our idea of the changes which the body has undergone under the influence of the food.

In determining the true income of the body the constituents of the feces must be subtracted, for, as already noted, the feces consist almost solely of food-stuffs which have escaped digestion and absorption, the amount of excretory matter in the feces being so small as to be disregarded. From the study of the composition of the food we know that in certain amounts of proteids, fats, carbohydrates, salts, water, and inspired air, the animal body takes in definite quantities of nitrogen, oxygen, carbon, hydrogen, sulphur, phosphorus, salts, and water.

The determination of statistics of nutrition is based upon the following facts:—

1. With the exception of wool- and milk-producing animals, all the nitrogen is excreted in the urine; that found in the feces may be regarded as derived almost solely from undigested food.
2. From the difference between the amounts of nitrogen in the food

and in the urine and fæces it may be determined whether there is an increase or a waste of the nitrogenous matter (albuminoids) of the economy.

3. The nitrogen in the urine is a measure of the decomposition of albuminoids in the body, while from the sum of the amounts of nitrogen in urine and fæces may be deduced the amount of albuminoids which become fixed in the body.

4. The difference in amount of carbon in income and outgo (including that which is given off by lungs and skin), taking into account the carbon derived from decomposition of albuminoids, gives us a means of estimating the changes in the fat of the animal body, since with the exception of fat there is not, in any important amount, any other carbon compound in the body.

5. Differences in the amount of water in the economy are readily calculated. It is only necessary to compare the increase or decrease of body weight with the data determined as to the decomposition of albumen and fat.

For making the above estimates the composition of albumen is placed as follows:—

C.	H.	N.	O.	S.
53.6 per cent.	7.0 per cent.	16.0 per cent.	23.0 per cent.	1.0 per cent.

Albumen thus consisting of 16 per cent. of nitrogen, if the amount of nitrogen in the urine is multiplied by 6.25 ( $= \frac{100}{16}$ ) we are able to determine the amount of albumen represented by the nitrogen in the urine.

As regards the fats, all the animal fats are remarkably constant in their composition; they possess in mean 76.50 per cent. carbon.

From the difference in carbon in income and outgo the amount of carbon of the decomposed albumen is first deducted (53.6 per cent.), and from the remainder by multiplication by the factor 1.307 ( $= \frac{100}{76.50}$ ) the amount of fat may be calculated.

The behavior of the mineral constituents is calculated from the mineral constituents of the food and that of the urine and fæces. So, also, for water in a like manner.

The following example (quoted by Schmidt-Mülheim, who has been largely followed in this chapter) makes clear the method by which such statistics of nutrition are reached:—

Henneberg fed a full-grown ox, weight 712.5 kilos, for twenty-eight days with 5 kilos clover-hay, 6 kilos oat-straw, 3.7 kilos crushed beans, 0.06 kilo salt, and 56.1 kilos water. During the experiment the animal increased daily 1.035 kilos in weight.

From the analysis of the food, fæces, and urine, and from the esti-

mate of the excretion of  $\text{CO}_2$  by means of Pettenkofer's apparatus and carburetted hydrogen of the intestinal canal, the following data were obtained:—

<i>A. Daily Income.</i>						
	Water.	Mineral Matter.	C.	H.	N.	O.
70.975 kilos food, .	58.200	0.890	5.825	7.500	0.310	4.900
<i>B. Daily Outgo.</i>						
	Water.	Mineral Matter.	C.	H.	N.	O.
40.65 kilos fæces, .	35.075	0.575	2.585	0.310	0.105	2.00
13.9 kilos urine, .	13.075	0.305	0.22	0.025	0.170	0.105
9.795 kilos $\text{CO}_2$ ,			2.67			
0.03 kilo $\text{CH}_2$ ,			0.02	0.01		
Total, . .	48.150	0.880	5.495	0.345	0.275	0.230

In addition to the above, 9.5025 kilos water in the form of aqueous vapor were removed through the lungs and skin.

The total of amounts daily appropriated and kept in the body, consequently, were:—

Water.	Mineral Matter.	C.	H.	N.	O.
0.525	0.010	0.330	0.050	0.035	0.850

These figures corresponded to a daily increase of—

Albumen, . . . . .	0.220 kilo.
Fat, . . . . .	0.280 "
Salts, . . . . .	0.010 "
Water, . . . . .	0.525 "

The calculation of the statistics of nitrogen in milk- and wool-producing animals is somewhat more complicated than the above, as the amount of the above productions have also to be taken into account.

1. **TISSUE CHANGES IN STARVATION.**—Before attempting to study in detail the influence of food on tissue change, the changes which occur in the animal body when all food is withheld must first be studied. And here it should, in the first place, be recollected that the skeletal muscles form nearly one-half the body, and about one-quarter of all the blood in the body is contained within them, while another fourth of the blood is contained in the liver. These two facts are sufficient to indicate that a large part of the metabolism of the body is carried on in the muscles and liver.

In fasting animals there is a steady waste of the various tissues and an excretion of those waste products; and since this waste is not supplied by new matter, there is a progressive loss of body weight.

Thus, in a dog weighing one thousand and twelve grammes and fasting for fourteen days there was a daily loss of body weight as follows:—

1st day of fasting,	. . . . .	83 grammes.
2d “ “ “	. . . . .	44 “
3d “ “ “	. . . . .	38 “
4th “ “ “	. . . . .	40 “
5th “ “ “	. . . . .	32 “
6th “ “ “	. . . . .	27 “
7th “ “ “	. . . . .	31 “
8th “ “ “	. . . . .	25 “
9th “ “ “	. . . . .	26 “
10th “ “ “	. . . . .	26 “
11th “ “ “	. . . . .	22 “
12th “ “ “	. . . . .	23 “
13th “ “ “	. . . . .	21 “
14th “ “ “	. . . . .	19 “

From this table it is seen that the loss is far greater on the first day of starvation than on any other, and that after the first day the loss gradually becomes less and less marked.

It has also been found that age is of marked influence on the degree of loss of body weight in starvation. The younger the animal, the greater the loss.

It is also noticed that birds can stand a greater relative loss of body weight from starvation before death occurs than mammals and other warm-blooded animals; in the latter death only occurs when 40 per cent. of the body weight has been lost.

It has been found that if water is freely given, a horse may stand a complete fast for from eight to fifteen days without any serious consequences. If this time is, however, passed, even feeding will then be unable to prevent death.

Herbivora stand starvation worse than carnivora, even although they lose only one-half as much tissue-albumen; it is stated that death from starvation in the horse does not occur until the twentieth to the thirtieth day, while a dog may live from forty to sixty days without food before death takes place.

If the body of an animal dead of starvation is examined there will be found the greatest difference in the loss which the different tissues have undergone. Adipose tissue suffers most, muscles and viscera less, and nervous system least of all, and this latter fact is worthy of especial notice, since fat forms a large constituent of the nervous system. The body is greatly emaciated; all subcutaneous and perivisceral fat has disappeared; the muscles and other organs are atrophied; and with the exception of the alimentary canal, in which fluid is generally found, all the tissues are markedly dry and free from water. In the stomach the fluid has an acid reaction; in the intestine there is a slimy fluid matter which is evidently decomposed bile.

Since fat and muscle have disappeared in largest amount, it is evident the starving animal feeds on its own flesh, and, under such circumstances, the urine of the herbivora and carnivora are identical.

Of the different organs the percentage of loss of original weight is as follows:—

Bones	. . .	13.4	per cent.	or	5.4	per cent.	of total loss.
Muscles,	. . .	30.5	“	“	42.2	“	“
Liver, .	. . .	53.7	“	“	4.8	“	“
Kidneys, .	. . .	25.9	“	“	0.6	“	“
Spleen,	. . .	66.7	“	“	0.6	“	“
Pancreas, .	. . .	17.0	“	“	0.1	“	“
Testicle, .	. . .	40.0	“	“	0.1	“	“
Lungs,	. . .	17.7	“	“	0.3	“	“
Heart,	. . .	2.6	“	“	0.02	“	“
Intestine, .	. . .	18.0	“	“	2.0	“	“
Brain and Cord, .	. . .	3.2	“	“	0.1	“	“
Skin, .	. . .	20.6	“	“	8.8	“	“
Fat, .	. . .	97.0	“	“	26.2	“	“
Blood, .	. . .	27.0	“	“	3.7	“	“
Other organs, .	. . .	36.8	“	“	5.0	“	“

Since in fasting all the nitrogen leaves the body in the form of urea, the amount of urea in the urine gives a means of measuring the waste of the albuminoid constituents of the body. Even up to the time of death the body continues to eliminate urea without, of course, any new albuminoid matter entering the economy, thus showing that there is a gradual and constant waste of proteids in the body. The amount of urea eliminated progressively decreases, as, of course, there is no repair of the stock of proteids from which it is drawn. Thus, a dog, which during feeding eliminates daily 63.96 grammes of urea, during the first day of starvation removes only 14.91 grammes, and there is then a gradual diminution in the amount up to the time of death. Thus, on the fifty-ninth day of starvation the dog alluded to above only eliminated 3.50 grammes of urea.

Of course, the richer the tissues are in proteids, the greater will be the difference between the amount of urea eliminated in the first and subsequent days of starvation. If before the commencement of the starvation experiment the animal has been on a spare diet, less urea will be eliminated in the first days of fasting, and then the decrease in amount will be more gradual than if it had been well fed.

The destruction of albumen in starvation is, however, by no means parallel to the amount of proteids in the entire body; or, in other words, an animal which on the first day of starvation destroys five times as much albumen as on the tenth does not have on the first day five times as much proteid in the body as on the tenth.

Voit has found that the excretion of urea on the first day after full feeding is so much greater than under other circumstances that he concluded that the amount of proteids in the body is of less importance



than the amount of albumen in the preceding diet in determining the degree of albumen destruction in the first days of starvation, and that the albumen destruction from starvation is dependent upon two causes:—

1. A very variable one, which only acts in the first days and which is dependent on the preceding diet and the general condition of the body.

2. A constant cause, which alone remains in force after the cessation of action of the first.

The following table shows how the amount of urea excreted increases with the amount of nitrogenous matter in the preceding meals:—

Food given Before Starvation.	Urea in Last Day of Feeding.	Urea in First Day of Fasting.
2500 grammes meat, . . . . .	180.8	60.1
2000 " " . . . . .	142.9	33.6
1500 " " . . . . .	110.8	29.7
800 " " and 200 grammes fat, . . . . .	51.8	19.8
Decreasing amount of meat on last day		
176 grammes, . . . . .	26.2	16.9
Abundance of fat after starvation, . . . . .	16.1	15.4

Voit concludes that animals possess, first, a considerable available "store" of albumen, which is capable of being increased by a previous meal rich in albuminoids and which is again rapidly removed in any drain on the economy; and, second, a much larger amount of proteid matter, which represents all the proteids of the animal body and which he terms "tissue-albumen." Of this latter but a small portion comes under the conditions of decomposition. The rapid fall in elimination of urea in starvation depends upon the using up of the "stored" albumen; when, however, this is all consumed, then the tissue-albumen in its turn undergoes destruction. Of course, the stored-up albumen is also located in the various tissues.

Herbivora contain in their tissues a lesser amount of this stored-up or reserve albumen than do the carnivora; even the tissue-albumen is present in relatively smaller amount. Thus, it has been found that a full-grown ox during starvation will only use up 1.27 kilos of proteids, while, measured by the albuminoid waste in carnivora, at least double the amount of nitrogenous excretion products might be expected.

In addition to the influence of these amounts of albumen on the proteid waste of fasting animals, the amount of fat in the animal body is also of moment; the greater the amount of fat, the less the nitrogenous waste, and this holds whether the fat is already stored up in the economy or is given to thin animals in the food.

Voit, by giving one thousand five hundred grammes of meat daily to a dog, brought it to a nutritive condition in which the excretion of

urea remained constant. He was then allowed to fast for ten days and the urea estimated (A). He was then fed with the same food, and then for ten days received nothing but one hundred grammes of fat (B). The following results were obtained:—

	A. Urea in Grammes.	B. Urea in Grammes.
Last day of feeding, . . . . .	110.8	111.8
1st day of fasting, . . . . .	26.5	27.2
2d " " . . . . .	18.6	16.3
3d " " . . . . .	15.7	14.1
4th " " . . . . .	14.9	12.9
5th " " . . . . .	14.8	12.4
6th " " . . . . .	12.8	10.8
7th " " . . . . .	12.9	10.5
8th " " . . . . .	12.1	10.7
9th " " . . . . .	11.9	10.2

Through the administration of the fat 14.1 grammes of albumen escaped destruction, or, as Voit expresses it, was "saved."

Water also exerts a considerable influence on the destructive processes in starvation, a large consumption of water always increasing the excretion of urea. This evidently points to an increased decomposition of proteids, and not a mere increase in the amount of urea washed out, since it has been proved that when water is withheld there is no accumulation of urea in the economy.

On the other hand, the most violent muscular movements during starvation produce but little appreciable increase in the amount of urea eliminated, thus showing that the combustion of albuminoids is not the source of muscular force.

In earlier times, with the exception of the lime salts in the bones, the inorganic substances found in the animal body were regarded as secondary in importance and, in fact, almost as accidental constituents. Liebig and his scholars first recognized the importance of these bodies; especially Na, Cl, Ca, K, Mg, Fe, and  $P_2O_5$  are absolutely essential for the health of the animal body. If these bodies are removed from the food, or even reduced in amount, the animals rapidly perish, even though supplied with an abundance of organic food.

This disturbance of nutrition is not, as was first supposed, because the removal of salts interferes with the activity of the digestive secretions, since digestion and absorption, even under such circumstances, is perfectly carried out, but because salts are removed constantly from the body, and if they are not supplied in food the animal rapidly perishes, as these salts are essential to the various functions of the economy.

Forster fed a dog with food which was as much as possible freed from salts; as proteids, he used the residue from the manufacture of beef extracts, butter freed from salts, potato-starch washed with HCl, and distilled water.

A dog weighing thirty-two kilos, which experience showed could be kept in constant weight by receiving six hundred to seven hundred grammes meat and one hundred and fifty grammes fat, was allowed to eat as much as he would take of the above foods, and yet he rapidly commenced to fail, and in fourteen days was unable to stand from his great weakness. After three weeks disturbance of digestion appeared—indigestion, diarrhœa, and finally vomiting.

The comparison of the inorganic income and outgo showed that, as regards phosphoric acid, 21.9 grammes were taken in while 51.7 grammes were excreted; consequently, the dog had lost 29.8 grammes of phosphoric acid, or ten times the amount which is normally contained in the blood; 7.24 grammes of NaCl were lost.

These results show that the body cannot be sustained by organic substances alone, but must also receive a certain amount of inorganic salts. If the amount of salts in the food sinks below a certain figure or is entirely suspended, salts are excreted by the economy, and the body passes into such a state of malnutrition that death speedily results.

As regards the amount of inorganic salts required by different animals in order to preserve perfect nutrition, it appears that the amount of NaCl in meat, which amounts to 0.11 per cent., is sufficient for the needs of the carnivorous animal. As a consequence, these animals prefer unsalted to artificially salted foods.

It is quite different with the herbivora, for, although these animals, as a rule, receive proportionately quite as much salt in their food as the carnivora, they will, nevertheless, always greedily devour salt.

As regards the relative proportion of these salts required by different animals, it appears that all animals require relatively similar proportions of chlorine and sodium, but that herbivora take in their daily food at least double as much potassium as carnivora.

Thus: One kilogramme cat, fed with mice, takes daily 0.1434 gramme K, 0.0743 Na, 0.0652 Cl. One kilo ox, fed solely with clover-hay, 0.3575 gramme K, 0.0266 Na, 0.0433 Cl; when fed with beet-roots and oat-straw, 0.2923 gramme K, 0.0674 Na, and 0.0603 Cl.

The following table gives the amounts of K, Na, and Cl in various foods:—

	K.	Na.	Cl.
Oat-straw, . . . . .	10.40	1.36	2.97
Clover, . . . . .	21.96	1.39	2.66
Sweet grasses, . . . . .	20.80	2.57	3.67
Prairie-grass, . . . . .	15.28	2.65	4.35
Acid grasses, . . . . .	20.60	5.74	4.52
Vetches, . . . . .	33.93	6.77	3.65
Beet (roots), . . . . .	34.79	10.24	5.40
Beet (tops), . . . . .	46.68	30.80	22.56
Carrot (roots), . . . . .	19.65	12.32	2.90
Sugar-beet (tops), . . . . .	50.07	25.76	20.16

Bunge has stated that it is this large amount of K in the food of the herbivora that causes them to require so much NaCl. For when potassium salts, the electro-negative constituent of which is other than chlorine, such as carbonate, phosphate, or sulphate of potassium, come into watery solution with NaCl at the body temperature they are partly decomposed, both salts give up their acids, and, in addition to potassium chloride, the carbonate, phosphate, and sulphate of sodium result through double decomposition. If these K salts enter the alimentary canal they are rapidly absorbed and meet with NaCl in the blood. As the above interchange then takes place, the blood in attempting to preserve its normal composition allows the new substances rapidly to diffuse away through the kidneys. Consequently, through the taking in of potassium sulphate, carbonate, or phosphate, the blood loses both Na and Cl, and this loss must be replaced by the ingestion of extra amounts of NaCl. Consequently, herbivora, whose diet is rich in K salts, require more NaCl than the carnivora.

It is thus seen that the character and extent of the tissue changes in starvation will be largely governed by the previous nutritive condition of the animal. The following table, after Lawes & Gilbert, shows the percentage of albumen, fat, salts, and water in the tissue of animals in different conditions:—

	IN 100 PARTS.		THE SOLIDS CONTAIN.		
	Solids.	Water.	Inorganic Matter.	Fat.	Albumen.
1. Fattened oxen, . . .	51.4	48.6	4.1	31.9	15.0
2. Half-fattened oxen,	43.9	56.1	5.1	20.7	18.0
3. Fattened sheep,	53.8	46.2	2.9	37.9	13.1
4. Thin sheep,	39.0	61.0	3.4	19.9	15.9
5. Fattened hogs,	57.1	42.9	1.7	44.0	11.9
6. Thin hogs,	41.8	58.2	2.8	24.6	14.1

## 2. THE NUTRITIVE PROCESSES IN FEEDING.—(a) *Feeding with Meat.*—

When animals are fed exclusively with fats or carbohydrates there is but little difference in the metamorphosis of proteids other than is seen in starvation. So, also, exercise, water, and various other conditions are of little influence. When, however, proteids are given with the food there is an immediate increase in the amount of urea eliminated, for the albumen of the food after being absorbed almost at once undergoes decomposition.

Bischoff and Voit found that a fasting dog which eliminated daily twelve grammes of urea, when fed with twenty-five hundred grammes of meat eliminated one hundred and eighty-four grammes of urea daily; the destruction of albumen, therefore, increased more than fifteen fold.

It would at first appear that if the same amount of albumen is

given to an animal as is lost during starvation, the destruction of the proteids of the tissues would cease. But since the administration of albumen increases the tissue waste this is not the case, and at least two and a half times as much albumen must be given as the body loses in starvation in order to preserve the balance. If enough of albumen is given to an animal to prevent its drawing on the albuminoids of its tissues, then the amount of nitrogen eliminated will just equal the amount contained in the food, and a nitrogenous balance is thus preserved.

If, now, to such an animal a larger amount of meat is given, the eliminated nitrogen does not at first increase, and a certain amount of the nitrogen remains in the body to increase the albuminoids of the tissues. Soon, however, the nitrogen eliminated increases until finally a nitrogenous balance is again regained. Every increase in the albumen of the food has the same result—first, an increase in the store of proteids of the body, and then an increase of urea, until the nitrogen of the latter equals the nitrogen of the food. A maximum is soon, however, reached in which the limit of albumen which can be digested and absorbed is attained.

A similar state of affairs holds in animals in a condition of nitrogenous balance when the albumen of the food is diminished. At first there is no decrease in the amount of urea eliminated, so the albuminoids of the tissues must have been drawn upon to make up the excess of nitrogen in the urine over that of the food. Then in a few days the elimination of nitrogen becomes reduced, until again a nitrogenous balance is regained. Every further decrease in the ration of albumen has the same effect—first, decrease of the store of tissue-albumen, and then nitrogenous balance. The minimum limit is then reached. When too small an amount of albumen is given in food to balance the tissue waste inanition then commences.

These facts show that the requisite amount of albumen in the food to prevent excess of tissue waste is dependent on the store of albumen in the body, and that the better the body is nourished by previous feeding the more food must be given to preserve a nutritive balance. Consequently, well-nourished animals require more food, badly-nourished animals less food, to preserve an equilibrium.

The amount of albumen in the food has, also, an influence on the body fat. If a small amount of albumen undergoes destruction, fat must be given up by the body in order to supply the amount of carbon necessary to form  $\text{CO}_2$ . If the body is rich in fat, and in consequence of abundant albuminous food a large amount of albumen undergoes destruction, the fat decreases; but if only a little fat is stored up and still a large amount of albumen is given in food, and there is, consequently, a large destruction of albumen, all the nitrogen is eliminated in the urine,

while a part of the carbon remains behind to be stored up as fat. Consequently, the body may be kept stationary as regards its store of albumen and fat through the administration of meat alone, but then a large quantity is required. An increase in tissue-fat and albumen may also, to a slight degree, take place from the administration of albumen alone, but only in illy-nourished individuals.

If peptone is given as food it is entirely destroyed, and the destruction of the tissue-albumen is completely prevented; but there is no increase in the body albumen, thus showing that peptone is earlier destroyed than albumen and can only partially replace the albumen of the food.

If gelatin and gelatinous tissue (bones, tendons, etc.) are given exclusively the destruction of albumen does not cease, thus showing that gelatin cannot replace albumen. But if gelatin and albumen are given together the destruction of albumen is greatly reduced.

(b) *Feeding with Fat.*—The influence of fat on the destruction of albumen is seen in the fact that in fasting animals the destruction of albumen is less in fat than in thin animals; this action is also seen in the administration of proteid foods alone, where the destruction of albumen is less in fat than in thin animals. Indeed, we have seen that in an abundant albuminous diet, whereby the excretion of urea is increased, in fat animals there may even be an increase in the body fat.

If fat is given alone as food to a carnivorous animal the destruction of albumen is reduced but not prevented; when large amounts of fat are given the fat of the body may even increase and yet the animals pass into a state of starvation, for the tissue-albumen is gradually being reduced.

If enough albumen is given to cause a nitrogenous balance and then fat is added to the food, the nitrogenous elimination is reduced and all the carbon of the fat does not appear in the  $\text{CO}_2$ ; carbon is, therefore, kept back in the body and stored up in the form of fat, while a certain amount of nitrogen also being retained indicates an increase of the body albumen. So, the addition of fat to the food leads to both an increase of tissue-fat and albumen, though this only occurs when a large amount of fat is added to a moderately small amount of albumen.

If the amount of albumen is increased the elimination of urea also increases, and, as a consequence of the great destruction of albumen, a certain amount of the fat is spared and is stored up in the body. But if the amount of albumen is reduced more fat is used up, and fat may even be taken away from the body.

The amount of fat in the body in feeding with albumen and fat is also of influence on the metabolism of the body; a body poor in fat, which needs and destroys more albumen, more readily stores up fat;

while a body rich in fat, since it needs and destroys less albumen, must draw on its store of fat. Young animals, since they are thin, therefore need more albumen and fat than older ones, while young animals, to fatten, require more food than older ones. It is also easier to fatten thin animals than to make tolerably fat animals still fatter.

(c) *Feeding with Carbohydrates.*—The action of the carbohydrates in nutrition is especially seen in the herbivora, which are incapable of being supported with albumen alone or with albumen and fat. Experiment has shown that in so far as they are digestible all carbohydrates have the same influence on the metabolism of the body. This applies to starch, cane-, grape-, and milk-sugar, dextrin, and, to a certain extent, to cellulose.

It is generally assumed that all the carbohydrates which enter the animal body unite with the oxygen obtained in inspiration to form  $\text{CO}_2$  and  $\text{H}_2\text{O}$ , so that an increase in carbohydrate diet means an increase in the  $\text{CO}_2$  of the expired air. This is not, however, universally true, since under many circumstances the carbohydrates may be retained in the body as fat; on the other hand, it cannot be positively stated whether the carbohydrates which are converted into sugar in digestion are directly oxidized as sugar, or are all first converted into glycogen.

Feeding dogs exclusively with carbohydrates has proven that the destruction of tissue-albumen and fat is under such circumstances less than when the animal is deprived of all food, but that the destruction of albumen is constant, and that such animals finally perish from inanition. If albumen is given together with the carbohydrates in increasing quantities, the excretion of nitrogen increases correspondingly, but in a much less degree than when albumen alone or albumen and fat constitute the diet; therefore the carbohydrates in food serve to spare the tissue change in proteids to a greater extent even than fat. Hence, to keep the body in a state of nutritive balance a moderately small amount of albumen is required with a large amount of carbohydrates, and, as a consequence, the herbivora are kept in good nutrition with the small amount of albumen found in their food. If the smallest amount of albumen is given with the corresponding amount of carbohydrates under which the body weight may be maintained without losing albumen or fat, and then the albumen of the food is increased, the elimination of nitrogen is also increased, but to a less degree than if albumen was given alone; there is, therefore, now an increase in the albumen and fat of the body. If, now, the amount of carbohydrates is increased without diminishing the quantity of albumen in the food, fat then accumulates in the body; and if the albumen is also increased both albumen and fat accumulate.

It is not yet quite clear whether this fat is formed from the carbon

of the albumen, as is generally acknowledged to be the case in the carnivora, or whether fat may not also be formed from the carbohydrates directly. It thus seems clear that the addition of carbohydrates to the diet spares the waste of tissue-albumen and body fat, and the attempt has been made to determine the amount of carbohydrates which in their nutritive value are equivalent to a given amount of fat. This has been fixed by Voit at the ratio of one hundred and seventy-five to one hundred; in other words, one hundred and seventy-five grammes of starch are equivalent to one hundred grammes of fat.

#### V. THE FOOD REQUIRED BY THE HERBIVORA UNDER DIFFERENT CONDITIONS.

The nutritive processes in the herbivora differ in many respects from those of the carnivora. In the first place, less albumen is destroyed during fasting by the herbivora than is the case in the carnivora. Thus, while in the example given above a dog weighing thirty-five kilos destroys daily one hundred and sixty-eight grammes of albumen, an ox weighing five hundred and twenty-two kilos only destroys twelve hundred and seventy grammes. So, also, the herbivora on feeding with carbohydrates and fat show much less tissue waste than the carnivora. In other respects, with allowances for the different digestive peculiarities of carnivora and herbivora, the nutritive process may be said to be similar.

It has been already stated that foods must not only contain representatives of the proteid, carbohydrate, and fat groups, with salts and water, but the different constituents must be present in definite proportions, which may, however, vary according to the demands on the animal. The proportion of albuminous to non-nitrogenous matter in food, *i. e.*, the proportion of albumen to starch and fat, is spoken of as the nutritive proportion. The average nutritive proportion is attained when the food contains one part proteid to from five to eight parts of non-nitrogenous matter, it being remembered that one hundred parts fat may be replaced by one hundred and seventy-five parts carbohydrates; 1: 2-4 is spoken of as a narrower nutritive proportion, and 1: 8-12 as a wider nutritive proportion.

The natural food of the domesticated herbivora has a nutritive proportion of 1:4-1:7; thus, ordinary hay has a proportion of 1:5-1:7, and, although it may be regarded as the normal food of ruminants, is not suitable when there is a demand for rapid fat, milk, or work production. In grass the proportion is only 1:4-6, and on such foods cattle produce the most milk; young cattle thrive on it and rapidly put on flesh. Clover has a proportion of 1:5-6, but on account of its large percentage of cellulose is not completely digested, so it is usually combined with some more concentrated food. Before blossoming clover has a proportion of



1:4, or even 1:3, and its use then entails a waste of valuable proteïds unless combined with chopped straw so as to bring the proportion down to 1:5. In the cereals the proportion on an average is 1:5-7, being broader in barley and eorn than in oats, rye, and wheat; in the hulled fruits, malt, brewers' grains, and distillery residues the proportion is 1:3, and in rape-seed cake 1:1-2. These latter fodders are, therefore, only applicable under special conditions. After this recapitulation we may consider the principles of feeding somewhat more in detail.

Animals which have no work to do besides growing and keeping up their nutrition are nourished perfectly well by grazing if the grass is abundant and of proper composition; this is the case for sheep, two- to three-year-old horses, and young cattle. If these animals are stalled, instead of being put to grass, on account of the perfect quiet and even temperature, the nutritive demands are reduced; so now feeding with hay or straw with some nitrogenous food suffices. A similar state of affairs holds in animals which are stall-fed without being worked, such as oxen in winter months, and the amount of food may here, also, be considerably reduced. The data showing the amount of food required are about as follows:—

For unworked animals, for every one hundred kilos body weight, 2.5 kilos of solids in the grasses (green fodder) is sufficient; therefore, for the herbivora, for every one hundred kilos body weight, ten kilos of grass, containing 2.5 kilos of solids, and of this 1.3 kilos of digestible matters, is sufficient. In this amount 0.25 kilo is represented by albumen, non-nitrogenous extractive one kilo, and fat 0.05 kilo; so the ratio of the amount of food to the amount of digestible matter is 1:4.2.

Thus, a horse weighing five hundred kilos may preserve a nutritive equilibrium on a daily ration of seven hundred grammes albumen, two hundred and ten grammes fat, three thousand seven hundred and fifty grammes starch and cellulose, and about twenty kilos of water; the ratio of nitrogenous to non-nitrogenous food being thus 1:5.5. Starch and fat may replace each other, seventeen parts of starch being equivalent to ten parts of fat. In the horse, the carbohydrates are more important heat-producing foods than is the case in man. Wolff has found that of the heat produced, 76 per cent. is due to carbohydrates, 13.5 per cent. to proteïds, and 10.1 per cent. to fats.

In a general way it may be said that for each kilo of body weight the herbivora requires daily one hundred and fifty grammes albumen, fifty grammes fat, and seven hundred and fifty grammes carbohydrates. Smaller animals require proportionately larger amounts, since the destructive processes are more active in them. In fattening animals the carbohydrates must be increased; in milking animals the albuminous food-constituents.

Experiment has proved that cattle preserve a nutritive equilibrium when they receive a daily ration calculated for ten hundred kilos of body weight, as follows:—

19.5 kilos clover-hay.								
3.7	“	“	“	13.0 kilos oat-straw, and 0.6 kilos rape-seed cake.				
2.6	“	“	“	14.2	“	“	“	0.5
3.2	“	“	“	13.3	“	barley	“	0.6
25.6	“	fodder-beets,	12.6	“	oat	“	“	1.0

In the above feeding the animals digested and absorbed for ten hundred kilos body weight on an average 0.57 kilo albumen and 7.4 kilos non-nitrogenous matter; hence, the nutritive proportion was 1:13. The above fodder contains on an average 0.05 kilo phosphoric acid, 0.1 kilo lime, and 0.2 kilo alkalies; in addition, for ten hundred kilos body weight, fifty-five kilos water were given.

For pregnant animals which are not worked, as brood mares, pasture is sufficient; or if stall-fed, hay and straw, the latter with some nitrogenous food, will answer if the total composition is made to correspond with that of grass. If the grass and hay are not of the proper composition some accessory food must be added. Especial reference must be paid to the amount of albumen and salts in the food, such as lime and phosphates, as of special importance for the development of the osseous system of the young. In such cases some albuminous food rich in salts is necessary, such as grains.

Male breeding animals which do not work must have their food so adjusted that they do not put on fat; not that the amount of organic matter may be reduced, but the food must be concentrated, have a small percentage of indigestible matter, and little water and much albumen. Especially in the coupling season must the food be rich in albumen to make up for the losses through copulation. Fat stallions and bulls are not fruitful.

Animals for labor require more than pasture; they require a large amount of albumen, for by it the muscles are enabled to appropriate a larger amount of oxygen; so, also, fat and carbohydrates must be increased, since they give to the muscles the substance which is consumed in muscular activity. If the work is constant the carbon of muscles must always be in excess. Voluminous and watery food must be avoided. The former distends the alimentary canal, and so interferes with respiration, and the latter leads to an accumulation of water in the tissues, and reduces the tension and elasticity of the muscles. So the food must be concentrated, as oats and barley, which are especially valuable on account of their fat.

Cattle on moderate work require per thousand kilos body weight, from 0.7 kilo to 1.6 kilos albumen, non-nitrogenous matters from 8.4 to 12 kilos; the nutritive proportion should thus be 1:7.5.

This proportion may be reached in the administration of suitable amounts of hay with some concentrated food, or clover-hay with chopped straw. When severe work is required it is advisable to increase the quantity of fat given (as by adding some oil-cake), the nutritive proportion being brought to 1:6.

Working oxen can stand a larger amount of raw food (hay, etc.) than horses. If rapid work is required of horses, a rich albuminous food such as oats must be given; if prolonged work is demanded, one richer in fat, as corn, is better.

If animals are fed for food purposes an increase in the solids and digestible matter of the food is requisite; so the appetite must be stimulated, and yet overloading of the alimentary canal avoided. It is, therefore, advisable gradually to increase the amount of the usual food, to stimulate the secretion by small quantities of salt, if possible, to aid digestion by a previous preparation of the food, such as by giving ground meal, and so to choose the foods that the waste of the organism will be at a minimum.

At the commencement of such fattening, the organism must be made rich with albumen: so thin animals must receive a large amount of digestible food, with an extra proportion of fat and carbohydrates, since we have found that under such circumstances there will be least waste of albuminoids. This is accomplished by feeding for about two weeks with 2.5 kilos albumen and 12.5 kilos non-nitrogenous matters per thousand kilos body weight, thus giving a nutritive proportion of 1:5. Then the non-nitrogenous matters must be increased to from 12.5 to 16.25 kilos per thousand kilos body weight, so making the proportion 1:6.5. When the economy becomes rich in albumen and then commences to put on fat, the albumen of the food may be increased to 3.0 kilos, making a proportion of 1:5.5; when it becomes very fat, the solids, especially the indigestible solids, must be reduced, and some oil-cake added to the food.

In fattening oxen the water given should be in the proportion of 4-5:1 of the solids given, in sheep 2-3:1.

In fattening sheep it has been proved that highly albuminous foods are especially valuable. Ground beans may be used for this purpose (0.5 kilo daily) combined with hay. In fattening sheep the preparatory treatment necessary with cattle may be usually dispensed with, and the diet more rapidly changed from one poor in nitrogenous matters (1:5.5) to one rich in proteids (1:4.5). The diet for sheep must not be too rich in water, so beets are not as valuable as with cattle; the best results are obtained from feeding with good hay and a corresponding amount of crushed beans or cereals. Sheep fatten more rapidly after shearing than before, for then the appetite is better and the thirst less.

Young animals which are designed for food purposes will slowly take

on flesh in a good pasture; if an accumulation of fat is desired, additional carbohydrates and fatty food must be given.

As a rule, the hog is more readily fattened than the sheep, and the latter than the ox. Race is also of influence. Thin, full-grown hogs at the commencement of fattening require large amounts of food, forty kilos of solids per thousand kilos body weight. Good results are obtained by feeding with crushed barley, corn, or peas, the latter especially, if mixed with steamed potatoes. The use of buttermilk or sour milk enables the amount of food to be reduced and still give satisfactory results.

For milk animals the conditions of food have been already considered, and a good pasture is all that is required.

When stall-fed, nutritive change is reduced; when food corresponding to pasture is given the quantity of milk and butter is increased.

In wool-producing animals a larger percentage of proteids is required in the food than in cattle, goats requiring less than sheep. Experiment has proven that sheep (ninety-six kilos in weight) on feeding with hay for one thousand kilos body weight require daily twenty-six kilos, and of this digest 1.32 kilos albumen and 10.53 kilos non-nitrogenous matters (with 0.322 kilo fat). On such feeding the weight increased somewhat, 0.181 kilo albumen and 0.299 fat (reckoned for one thousand kilos body weight) being deposited. The nutritive proportion, therefore, for sheep should be 1:9.3. It has further been determined by Wendee and Hohenheim that slight loss of weight, within limits, does not interfere with wool production, especially if the food be rich in proteids.

By chopping food mastication is, to a certain extent, facilitated, but it cannot be regarded as a substitute for mastication, since the mixing with saliva can only be perfectly performed when the food is thoroughly masticated. The principal object in chopping food is to enable it to be mixed with other materials so as to increase its tastefulness and digestibility, or to assist in the administration of other substances. Chopping should never be carried so far as to permit of the food being swallowed without undergoing a certain amount of mastication. The cereals are especially suited for administration under the forms of meals and may be readily mixed with other foods. The readily digestible grains, of course, do not need to be ground, but in the form of meal they may be mixed with less digestible, bulky substances, such as chopped straw. Thorough mastication of the latter is so attained and the grain gives taste to the mixture, without which, probably, the food would be rejected. To horses and sheep all grains the hulls of which are not too hard and thick may be given uncrushed by mixing with chopped straw and the like as long as their organs of mastication are in good condition. Barley is best given to sheep when roughly ground, while the seeds of the leguminous plants and corn may likewise be ground for sheep and horses.

Grinding of oats is only necessary for old horses or those in which the teeth are changing. Oxen and hogs, as a rule, digest the ground cereals better than the whole grains. According to Lehmann, of the entire grains in a fourteen-months-old ox 48.2 barley and 19.6 per cent. oats remained undigested. In a five-months-old ox 33.0 barley and 6.5 per cent. oats remained undigested.

Even after mixing with chopped straw a large part of the entire grains escape digestion and pass through the faeces almost entirely unchanged, and still possess the power of germination. Of one hundred kilogrammes of the unground grains fed to hogs Lehmann found in the faeces 50.6 kilos of oats, 49.8 kilos of rye, 54.8 kilos of barley, and 4.8 kilos of peas. The experiment, therefore, points in the most emphatic manner to the administration to the ox and hog of all the cereal grains mealed and mixed with other foods. About the only exception to this statement is found in the case of oats. The chopping of dry fodder enables it to be mixed readily with large amounts of more tasty substances. So, also, the young, tender, highly albuminous green foods may be chopped and mixed with less nutritious substances, such as straw. The transition of dry to green feeding and the reverse is facilitated by the mixture of the green fodder with dry, chopped straw. Horses should always receive good hay unchopped, but the straws of the cereals should always be given in a chopped state, since horses will only take the hard straw in small amounts. Chopped food for horses should not be shorter than from one and one-third to two centimeters in length of each piece, since smaller pieces readily lead to obstructive colic, especially if given with meal in a moist condition. For the ox, straw may be chopped into pieces two and one-half to three centimeters long, and mixed well with corn-meal or chopped beets or potatoes in order to make it more tasty.

The duration of the interval between different times of feeding of the domestic animals is a matter of considerable importance. Too frequent feeding should be avoided on account of the shortening of the necessary pauses between the digestive processes. The ruminants, especially, should not receive more than at most three meals in the day, so as to allow time for rumination. Horses likewise should receive three meals and hogs from three to four meals a day. On the other hand, the intervals between feeding should not be too long, on account of the great increase of hunger so produced leading to faulty mastication and imperfect insalivation of the food. This state of affairs may produce much more serious disturbance in the non-ruminants than in the ruminants. In young cattle from four to six meals may be given a day on account of the relatively smaller size of their stomachs, since three meals scarcely furnish enough to sustain them. So, also, when the fodder is especially fluid the meals may succeed each other every two or three hours, for in

## NORMAL AMOUNTS OF FOOD FOR CATTLE, HORSES, SHEEP, AND SWINE.

For every kilogramme of body weight the following amounts of digestible food-stuffs must be contained in the daily ration:—

CLASS OF ANIMAL.	SOLIDS.			NITRO-GENOUS MATTERS.			NON-NITRO-GENOUS EXTRACTIVE MATTERS.			FAT.			Average Digestible Matter.	Nutritive Proportion.
	Minimum.	Maximum.	Mean.	Minimum.	Maximum.	Mean.	Minimum.	Maximum.	Mean.	Minimum.	Maximum.	Mean.		
Kilogrammes.														
<i>1. Young Cattle.</i>														
2-3 months old, 75 kg. weight, . . . . .	21.0	26.0	23.5	3.0	5.0	4.0	9.5	12.5	11.0	1.5	2.5	2.0	17.0	1:4.0
3-6 months old, 150 kg. weight, . . . . .	23.5	27.0	25.0	3.0	3.5	3.0	9.5	12.0	11.0	0.75	1.25	1.0	15.0	1:4.2
6-12 months old, 250 kg. weight, . . . . .	25.0	30.0	26.0	2.0	3.0	2.5	9.5	12.0	11.0	0.4	0.8	0.6	14.1	1:5.0
12-18 months old, 350 kg. weight, . . . . .	25.0	30.0	26.0	1.8	2.5	2.0	9.5	11.0	10.5	0.3	0.5	0.4	12.9	1:5.7
18-24 months old, 425 kg. weight, . . . . .	25.0	30.0	26.0	1.4	1.8	1.5	9.0	10.5	9.5	0.2	0.4	0.3	11.3	1:6.8
<i>2. Oxen.</i>														
At rest, . . . . .	15.0	20.0	18.0	0.6	0.9	0.7	5.5	7.0	6.5	0.1	0.2	0.15	7.35	1:1.0
Working, . . . . .	24.0	28.0	26.0	1.4	1.8	1.6	8.0	10.0	9.0	0.2	0.4	0.3	10.9	1:6.0
Severe working, . . . . .	24.0	32.0	28.0	2.0	2.8	2.4	10.0	12.0	11.0	0.4	0.6	0.5	13.9	1:5.1
<i>3. Fattening Cattle.</i>														
1st period, . . . . .	27.0	30.0	28.5	2.3	3.0	2.5	11.0	12.5	12.0	0.5	0.7	0.6	15.1	1:5.4
2d " . . . . .	26.0	29.0	27.5	2.8	3.5	3.0	11.0	12.0	11.5	0.6	1.0	0.7	15.2	1:4.5
3d " . . . . .	25.0	28.0	26.5	2.5	3.3	2.7	11.0	12.0	11.5	0.5	0.8	0.6	14.8	1:4.8
<i>4. Milk Cows.</i>														
	21.0	32.0	26.0	2.2	2.8	2.5	9.5	12.0	10.0	0.35	0.6	0.4	12.9	1:4.4
<i>5. Horses.</i>														
Working, . . . . .	21.0	27.0	24.0	1.6	2.0	1.8	8.0	10.0	9.0	0.5	0.8	0.6	11.4	1:5.8
Heavy work, . . . . .	23.0	30.0	26.5	2.5	3.0	2.8	9.0	12.0	10.5	0.6	1.0	0.8	14.1	1:4.5
<i>6. Young Sheep.</i>														
5-6 months old, 28 kg. weight, . . . . .	28.0	32.0	30.0	2.5	3.5	3.2	9.5	11.5	10.5	0.7	1.0	0.8	14.5	1:4.0
6-8 months old, 33-34 kg. weight, . . . . .	26.0	28.0	27.0	2.5	2.8	2.7	8.5	10.5	9.5	0.5	0.8	0.6	12.8	1:4.0
8-11 months old, 37-38 kg. weight, . . . . .	23.5	26.0	25.0	2.0	2.5	2.1	7.5	9.5	8.5	0.4	0.8	0.5	11.1	1:4.7
11-15 months old, 41 kg. weight, . . . . .	23.5	25.0	24.5	1.5	2.0	1.7	6.5	8.5	7.5	0.3	0.5	0.4	9.6	1:5.0
15-20 months old, 42-43 kg. weight, . . . . .	21.5	25.0	23.5	1.2	1.6	1.4	6.5	8.5	7.5	0.25	0.4	0.3	9.2	1:6.0

NORMAL AMOUNTS OF FOOD FOR CATTLE, HORSES, SHEEP, AND SWINE.  
(Continued.)

CLASS OF ANIMAL.	SOLIDS.			NITROGENOUS MATTERS.			NON-NITROGENOUS EXTRACTIVE MATTERS.			FAT.			Average Digestible Matter.	Nutritive Proportion.
	Minimum.	Maximum.	Mean.	Minimum.	Maximum.	Mean.	Minimum.	Maximum.	Mean.	Minimum.	Maximum.	Mean.		
Kilogrammes.														
<i>7. Wool Sheep.</i>														
Coarse-wooled sheep, .	19.0	24.0	22.0	1.0	1.5	1.2	6.5	8.5	7.5	0.1	0.3	0.2	8.9	1:6.7
Fine-wooled sheep,	21.5	27.0	24.5	1.1	1.7	1.5	7.5	9.0	8.5	0.2	0.4	0.3	10.3	1:6.2
<i>8. Rams.</i>														
	23.5	27.0	25.0	2.0	2.5	2.2	9.0	12.0	10.5	0.4	0.6	0.5	13.2	1:5.3
<i>9. Fattening Sheep.</i>														
1st period,	27.0	32.0	29.0	2.5	3.5	3.0	11.0	13.0	12.0	0.4	0.6	0.5	15.5	1:4.5
2d "	25.0	30.0	27.0	3.0	4.0	3.5	11.0	12.0	11.0	0.5	0.7	0.6	15.1	1:3.5
<i>10. Young Pigs.</i>														
2-3 months old, 25 kg. weight, .	50.0	58.0	54.0	7.0	8.0	7.5	26.6	31.0	28.5					
3-5 months old, 33-50 kg. weight, .	41.0	47.0	44.0	5.0	7.0	6.0	22.0	26.0	24.0					
5-6 months old, 62-63 kg. weight, .	39.0	43.0	41.0	4.0	5.0	4.5	20.0	24.0	22.0					
6-8 months old, 85 kg. weight, .	32.0	38.0	35.0	3.0	4.0	3.5	18.0	20.0	19.0					
8-12 months old, 125 kg. weight, .	24.0	30.0	27.0	2.5	3.5	3.0	15.0	18.0	16.5					
<i>11. Fattening Pigs.</i>														
1st period,	45.0	48.0	46.0	4.5	6.0	5.0	24.5	26.5	26.0				31.0	1:5.2
2d "	37.0	45.0	40.0	3.5	4.5	4.5	21.0	24.5	23.0				27.0	1:5.8
3d "	26.0	33.0	30.0	2.5	3.5	3.0	17.0	19.0	18.0				21.0	1:6.0
<i>12. Breeding Pigs.</i>														
(Sows and Boars), .	26.0	32.0	32.0	1.5	2.0	1.8	1.25	15.0	14.0				15.8	1:7.8

this condition the stomach rapidly empties itself and the feeling of hunger again appears. So, also, when feeding with dry fodder is commenced it is better at the beginning to give at least four different meals, so as to avoid overdistention and filling of the stomach with this more bulky food. At the end of fattening the meals may be increased in number and reduced in amount, digestion of small amounts of readily digestible foods being now more readily accomplished.

## VI. HUNGER AND THIRST.

The sensations which lead to the prehension of solid and liquid foods are known as hunger and thirst. It was previously supposed that hunger was a local sensation which was produced by the absence of food in the stomach. Evidently this is a mistaken idea, else would the ruminants never experience this sensation, for in them the stomach is never free from food, even when death occurs from starvation. The appearance of hunger coincides with absorption of the matters digested at the previous meal. Although the sensation is apparently referred to the abdomen, it cannot be regarded as a localized sensation, but rather as a peculiar modification of the general system similar to that produced in dyspnoea; nor, indeed, is the stomach even the starting point of hunger, for the pneumogastrics, the sensory nerves of this organ, may be divided, and if the animals be deprived of food the clearest evidences of hunger are, nevertheless, capable of detection. In spite of this fact, the sensation of hunger is, nevertheless, to a certain extent dependent upon the condition of the stomach, as is indicated by the temporary relief of hunger which follows introduction into the stomach of matter which is not in the slightest respect nutritious. So, again, even when the stomach is filled with food, if through any disease digestion or absorption or the passage of food into the small intestine are interfered with the hunger may, nevertheless, be intensely felt; and, again, even after a hearty meal digestion may be complete, and the stomach empty for some time before the sensation of hunger appears.

In the case of thirst the state of affairs is somewhat similar, except that there the sensation is more distinctly localized in the fauces and may be relieved by the application of moisture to that part. When an animal is deprived of liquid, the blood, from the continued formation of secretions and excretions, rapidly loses its normal percentage of water. The sensation of thirst is evidently due to the irritation of the sensory nerves of the mucous membrane of the pharynx produced by the drying of the mucous membrane, and while it may be relieved, as already mentioned, by moistening this part, the arrest of thirst is only temporary. But, on the other hand, the thirst may be permanently relieved by the injection of water into the veins and even by enemata of water, and while thirst, therefore, has a local expression, like hunger, it represents the needs of the economy for water; thirst may thus be abolished, even although no water enter the mouth. Every cause, therefore, which diminishes the proportion of fluid in the blood, whether intense heat or exercise which favor cutaneous and pulmonary evaporation, dropsies, abundant hemorrhages, or diabetes, all lead to thirst; so, also, salts occasion thirst by withdrawing water from the blood.



## SECTION XIII.

### ANIMAL HEAT.

It has been seen that the income of the animal body is represented by complex combinations of carbon, hydrogen, nitrogen, and oxygen, and the introduction of free oxygen in respiration; the outgo of the body, on the other hand, is represented by similar combinations of the same elements in the form of carbon dioxide, water, and urea.

The conclusion is thus evident that the absorbed oxygen has within the body undergone combination with carbon and hydrogen with the production of carbon dioxide and water, and that the substances introduced as food have all in different degrees united with oxygen. In other words, the nutritive processes in the animal body are represented by a series of oxidations by which the organic food-products are restored to the inorganic form. Oxidation of any kind will invariably be accompanied by a production of heat, and we thus see that one of the principal sources of the heat of the animal body is to be looked for in such processes of oxidation. It is a well-established fact that the combustion of any body, whether rapidly or slowly produced, is accompanied by the evolution of a fixed quantity of heat, provided the energy be not otherwise employed. Thus, the complete combustion of one gramme of sugar invariably corresponds to the development of four heat-units.\*

If this combustion takes place in the animal body, it is evident that the same amount of heat must be developed, no matter what may be the character of the substances developed between the starting point and the final termination of the process of oxidation.

In the animal body, however, such processes of combustion are rarely as complete as would occur in the incineration of food-stuffs outside of the body. Thus, for example, in albumen the process of oxidation results in the formation of urea, which itself is capable of still further oxidation. Nevertheless, it may be stated with a tolerable degree of accuracy how much heat is set free in such processes of oxidation of the food-stuffs in the animal body. Knowing the amount of heat developed in the oxidation of one gramme of albumen and the amount developed in the oxidation of a proportionate quantity of urea, deducting the latter from the former will evidently represent the

\*By this term, heat-unit, is meant that amount of heat which is required to raise one kilogramme of water from 0° C. to 1° C.

degree of oxidation occurring in the animal body. This factor has been estimated as corresponding to five heat-units. With these data the amount of heat developed in twenty-four hours may be readily calculated: Thus, taking the example given by Fick, the income of the body was represented in round numbers by one hundred and twenty grammes of fat, two hundred and sixty-three grammes of carbohydrates, and one hundred and seventeen grammes of albumen, with the excretion of thirty-nine grammes of urea. The combustion of one gramme of fat is represented by the development of nine and six-tenths heat-units, and, as already seen, one gramme of carbohydrates by four heat-units, and one gramme of albumen by five heat-units. The total amount of heat, therefore, developed is represented by  $120 \times 9.6 + 263 \times 4 + 117 \times 5$ , or, in round numbers, two thousand eight hundred heat-units. The confirmation of these figures and their influence in maintaining the heat of the animal body is determined by calorimetric experiments. To accomplish such an experiment, first, the tissue change in twenty-four hours must be calculated; second, the amount of heat liberated by the body in that time; third, the average temperature of the animal body at the commencement and end of the experiment; and, fourth, the average heat capacity of the body. As a rule, the difference between the body temperature at the commencement and end of such experiments is so slight as not to deserve attention, and the amount of heat set free in twenty-four hours may be regarded as indicating the amount of heat developed in the body.

Such experiments do not, however, serve with absolute accuracy to confirm the theoretical figures deduced from the co-efficient of heat production represented above as belonging to the different food-stuffs. In nearly all cases there is an apparent loss of heat over what should be expected from these data. It is to be recollected, in the explanation of this discrepancy, that the energy set free in such oxidations may take on the form either of heat or of mechanical work. In the animal body all these sources of loss of energy occur. All forms of muscular movement are accompanied by liberation of energy, and a continual loss of heat is taking place through radiation from the surface of the body, by conduction, by the evaporation from the skin and mucous surfaces, and by the warming of the ingesta. The amount of heat dissipated by the animal body in a condition of health is in close dependence upon the amount produced, upon the difference in temperature between the animal body and the surrounding medium, and especially upon the relationship between the external surface of the body and the body weight. Thus, small animals for each kilogramme of the body weight set free more heat than large animals. It has been estimated that for each kilogramme of body weight the horse in each hour sets free two and one-tenth heat-

units; sheep, two and six-tenths heat-units; the dog, four heat-units; and the sparrow, thirty-two heat-units. The cause of this difference may be found in the fact that the smaller a sphere the greater is its superficial area in comparison to its cubic contents. The same rule applies, also, to the irregular form of the animal body, in which the smaller it is in proportion to the weight of the animal the greater will be its superficial area. It is, however, from the external surfaces that the greatest amount of body heat is dissipated, and it is, therefore, seen why small animals lose proportionately more heat than larger animals.

Two different conditions are noted in reference to the heat which is retained in the animal body, and which, therefore, causes the body temperature. In the cold-blooded animal the temperature of the body is not constant, but varies with that of the surrounding medium, rarely being more than a few tenths of a degree above it. In the warm-blooded animals, as in mammals and birds, on the other hand, the body temperature is, as a rule, higher than that of the surrounding medium, and is independent of variations in the latter. The cause of this difference of body heat lies in the difference in energy of the tissue changes. In the cold-blooded animals the development of heat is so slight that this amount of heat is at once given up to the cold atmosphere. If the external temperature be increased, this dissipation of heat is accordingly diminished, and as a consequence part of the heat produced is retained in the body and increases its temperature. On the other hand, if the external temperature falls, the amount of heat dissipated is increased and the body temperature falls. In animals with a constant body temperature the amount of heat, on account of the greater energy of tissue change, is so much greater that but a part alone is given up to the surrounding medium. From the fact that the source of temperature is found in the chemical changes occurring in the tissues, it is evident that the development of heat will be greater in tissues in which such processes are active than where they are sluggish. The temperature of the animal body will, therefore, vary in different localities; it will be greater in secreting glands and contracting muscles; it will be less where loss of heat is favored, and, as a consequence, the exterior surfaces of the body will possess a lower temperature than the inner cavities.

In the lungs the blood gives up so much heat to the air that the temperature of the blood in the left side of the heart is cooler than that of the right, in spite of the development of heat which accompanies the oxidation of hæmoglobin. With this exception the arterial blood, as being less exposed to loss of heat, may, as a rule, be stated to be warmer than venous blood.

The temperature of an organ will, therefore, depend upon the amount of blood circulating through it. Under certain circumstances the venous

blood may increase in temperature over that of the arterial blood; such a state of affairs is seen in the blood coming from the contracting muscles or from a secreting gland. The blood by its continuous circulation through the body tends to equalize the body temperature, giving up heat to tissues which are cooler than itself and withdrawing heat from those which are warmer. The mean between the highest and lowest temperature of the animal body is spoken of as the body temperature, and is generally represented by the temperature taken in the mouth or in the rectum.

The following figures represent the mean average temperatures of the different domestic animals:—

Horse,	37.5° to 38° C.
Ox,	38° to 38.5° C.
Dog,	38.5° C.
Sheep,	39° to 40° C.
Chicken,	42° C.
Hog,	39° to 40° C.
Ass,	39.5° to 38° C.
Rabbit,	39° to 39.5° C.
Mouse,	41.1° C.
Cat,	38.5° to 39° C.
Goose,	41.5° C.
Pigeon,	42° C.

While these figures represent the average body temperature, variations within narrow limits may often be observed even in perfectly healthy individuals. A variation of one degree or more indicates some failure in the organism or some departure from the natural process of metabolism. It is, therefore, evident that the mechanisms which regulate the balance between the production and loss of heat must be extremely sensitive. Such a regulating mechanism will prevent an increase of the body temperature either by diminishing the production or increasing dissipation of heat, or, in the other case, by increasing the production and diminishing the loss.

Heat, as already indicated, is lost to the body by conduction to the ingesta and egesta, to the expired air, and by conduction and radiation from the skin and through the evaporation of fluid from the surface of the body. The relative amounts of heat lost by these different channels have been calculated by Helmholtz as follows: through the expired air, 5.2 per cent.; through the water of respiration, 14.7 per cent.; through the skin, 77.5 per cent. The chief means, therefore, of heat dissipation are through the lungs and skin. The more rapid the respiration the greater will be the loss of heat, and in animals which do not perspire the lungs will represent the main source of heat dissipation. In other animals the skin is, no doubt, the great regulator of the body temperature. The more blood passes through the cutaneous vessels, the greater will be the loss of heat through radiation, the greater will be the cuta-

neous secretion, and, as a consequence, the greater will be the loss of heat through evaporation. Everything, therefore, which dilates the cutaneous blood-vessels will increase the heat dissipation. The working of the mechanism of heat regulation through increasing heat dissipation is well seen in the case of exercise. Every muscular contraction, as already pointed out, leads to an increase of heat production, and, as a consequence, the blood coming from a contracting muscle may be several degrees warmer than the arterial blood supplied to it. Nevertheless, the body temperature, even in severe exercise, is but little elevated above the average, for the increased exercise leads to an increased demand of oxygen in the inspired air, and, as a consequence, respiration is increased and the amount of heat eliminated through the expired air thereby augmented. The action of the heart is likewise accelerated, the circulation through the skin is augmented, perspiration is increased, and a greater amount of heat is given up from the skin by radiation and by the evaporation of the perspiration. By this means enough heat is lost to the animal body to balance the increased production.

Increase of external temperature likewise prevents an increase in the body temperature by increasing the circulation through the skin and the cutaneous perspiration, and so also increases the loss of heat. On the other hand, if the external temperature is reduced the cutaneous vessels contract, the evaporation of perspiration is prevented, and again a balance is struck between the production and the heat dissipation.

The influence of the nervous system on the temperature of the animal body is both directly and indirectly exerted. It has been mentioned in a previous section that division of the cervical sympathetic nerve is followed not only by contraction of the pupil, but also by an increased temperature of the corresponding side of the head and neck. If this experiment be performed upon a rabbit the increase of temperature is so great as to be readily perceptible to the touch; and if the ears of the rabbit be examined in transmitted light the blood-vessels of the auricle on the side of section of the sympathetic will be found to be greatly dilated. Section of the sympathetic, therefore, by paralysis of the vaso-motor nerves, has occasioned dilatation of the blood-vessels, and the consequent increased vascularity facilitates radiation of heat and so causes a perceptible increase in the temperature of the part. But the increased radiation of heat is also attended with increased heat production; for the hyperæmia produced by vaso-motor paralysis is accompanied by increased nutritive activity, and heat production is thereby augmented. Thus, it has been shown by Bidder that excision of a part of the cervical sympathetic in the rabbit is followed within two weeks by a marked increase in the size of the ear on the side of operation; and excision of the celiac plexus has been said to produce intense hyperæmia

of the stomach. Numerous instances of pathological increase of nutritive activity from increased blood supply and consequent increased temperature will doubtless suggest themselves.

In addition to this indirect influence of the nervous system through the vaso-motor nerves on calorification, the central nervous system is stated to both directly and reflexly govern the development of heat, though much of the evidence brought forward as to a special nervous mechanism for regulating animal heat is imperfect. Experiments have chiefly been directed toward locating special heat-centres in various parts of the brain. Ott claims that there are four localities in the brain irritation of which increases bodily temperature by from  $2.2^{\circ}$  to  $3.3^{\circ}$  C. These heat-centres are said to be located as follows: 1. In front of and beneath the corpus striatum. 2. The median portion of the corpora striata. 3. Between the corpus striatum and the optic thalamus. 4. The anterior inner end of the optic thalamus. A heat-centre is also claimed to be present in the dog, in the cortex of the anterior portion of the upper surface of the brain, near the median line, the locality agreeing with that of the motor centres of the hind limbs, and for the movements of flexion and rotation of the fore limbs. According to Wood, section of the brain between the pons and medulla oblongata causes increased radiation of heat and diminished heat production, due to the cutting of the paths of communication with the cerebral heat-regulating centre. There seems to be little doubt but that irritation of various parts of the brain does lead to modifications in the heat-producing mechanisms of the body, and that fibres in connection with these centres decussate in the medulla; but as to whether the effects produced are stimulating or inhibitory, whether they act through the production of change in circulation, or whether they directly influence the chemical operations concerned in the production of heat, is quite unknown.

BOOK II.

THE ANIMAL FUNCTIONS.





## SECTION I.

### PHYSIOLOGY OF MOVEMENT.

1. THE CONTRACTILE TISSUES.—It was stated that the function of contractility represents one of the fundamental properties of protoplasm, and in the simplest forms of life, consisting of undifferentiated protoplasm, as in the structureless amœba, the contractility of protoplasm renders locomotion possible. The first attempt at localization of this function of contractility, in the general specialization of function in the development of the animal kingdom, was noted in the development of protoplasmic prolongations of cells, so-called cilia, which in numerous infusoria constitute organs of locomotion; in various shell-fish, organs for aiding the prehension of food and the functions of respiration, and in the higher animals for producing motion of particles brought in contact with them. The first attempt, therefore, at the development of organs in which the function of contractility is specialized is seen in the development of vibratile cilia. In a step higher in the progress of specialization, contractility reaches its highest degree in the muscular tissue, which may be regarded as a mass of protoplasm inclosed within a cylindrical or polygonal cell. In the higher animals each of these three different representations of contractile substances are met with: undifferentiated protoplasm, as found in the lymph-corpuseles, white blood-corpuseles, connective-tissue corpuseles, mucus- and pus-cells; ciliated cells, lining various mucous cavities in the body; and muscular tissues of the striped and unstriped varieties.

The characteristics of motion as occurring in undifferentiated protoplasm and ciliated cells have already been studied. The conditions of muscular contractility now deserve attention. In muscular tissue the contractile substance is inclosed in a tubular sheath, constituting a muscular fibre. Muscular fibres may be either striped or voluntary fibres, or unstriped or involuntary fibres. The striped or voluntary muscles, which have a red appearance, constitute the great mass of contractile tissues of the body. They are ordinarily connected with the bones, and are therefore spoken of as skeletal muscles; their contractions, as a rule, are under the control of the will. Each muscle-fibre is more or less cylindrical, varies in length from one one-hundredth to one six-hundredth of an inch, and consists of the sarcolemma, an elastic sheath, probably of the nature of connective tissue, with transverse partitions which stretch

across the fibre at regular intervals (membrane of Krause). Within this is inclosed the sarcous substance, or the contractile tissue of the muscular fibre, which is a broad, highly refractive, doubly refractive disk, and the nuclei or muscle-corpuscles. The muscle-corpuscles are thus within the sarcolemma, and it is at the expense of their protoplasm that

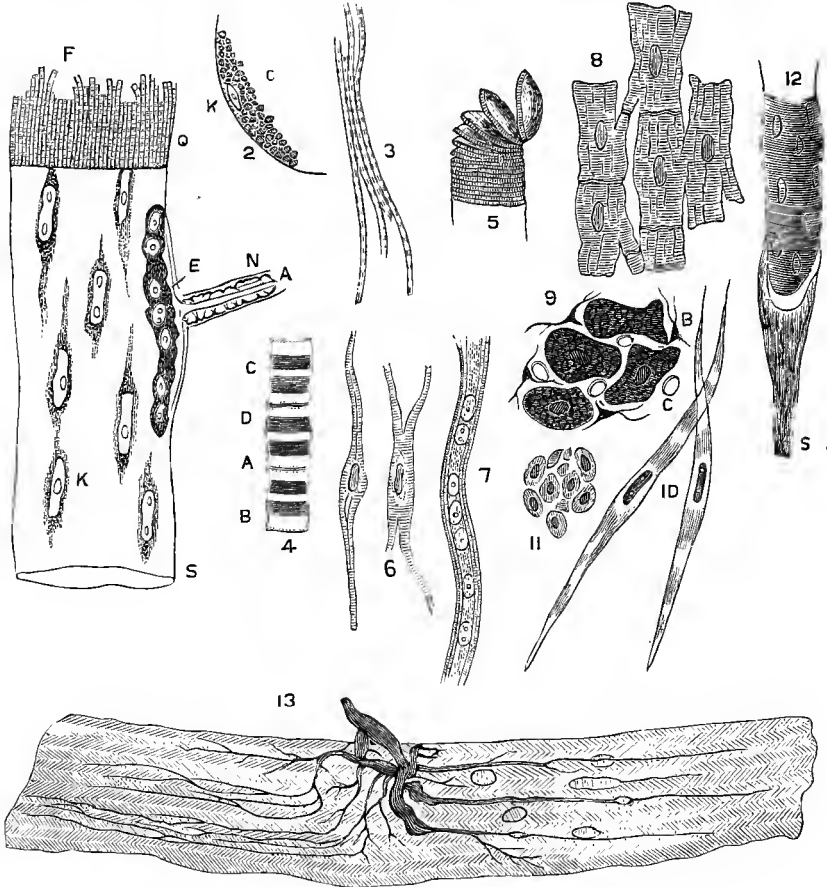

FIG. 271.—MUSCULAR TISSUE, AFTER GERLACH. (*Ellenberger.*)

1, scheme of the different parts of striped muscular fibre: S, sarcolemma; K, nucleus; 2, striation; F, fibrillae; N, nerve; E, nucleated nerve-plate; 2, part of a cross-section; 3, isolated fibrillae; 4, highly magnified fibril of insect muscle; A, Krause-Amici's line; B, anisotropic substance; C, central disk; D, isotropic substance; 5, separation of disks; 6, cell of heart-muscle of frog; 7, embryonal development of muscular fibre; 8, cells of heart-muscle; 9, cross-section of heart-muscle; 10, unstriped muscle-cells; 11, cross-section of unstriped muscle-cells; 12, muscular fibre with tendon; 13, interfibrillar muscular nerves.

muscular tissue is formed. Between the contractile disks and Krause's membrane is a transparent, isotropic, semifluid layer (the lateral disk of Engelmann), which is composed of prismatic, rod-shaped elements, the sarcous elements of Bowman.

The striated appearance of muscular tissue is due to the arrangement of the sarcous substance in alternate light and dark layers or disks.

Each muscular fibre is made up of a large number of primitive fibrillæ placed side by side and united by a semi-fluid cement substance, the fibrillæ being so arranged that the transverse markings lie at the same level.

The muscular corpuscles in the muscular fibres of man and most

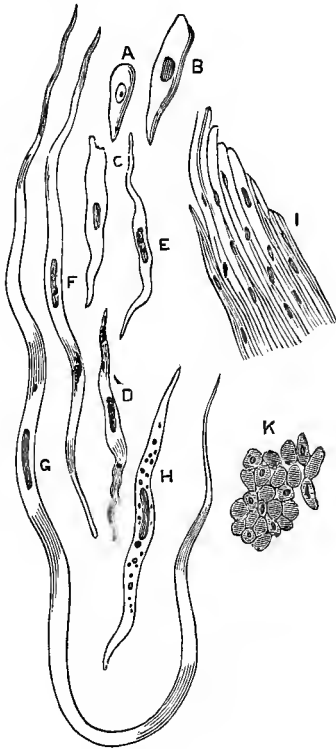

FIG. 272.—UNSTRIPED MUSCULAR TISSUE. (*Ellenberger.*)

A and B, fetal cells; C, H, fully formed fibre; I, bundle of fibres; K, cross-section of bundle of pale muscular fibres.

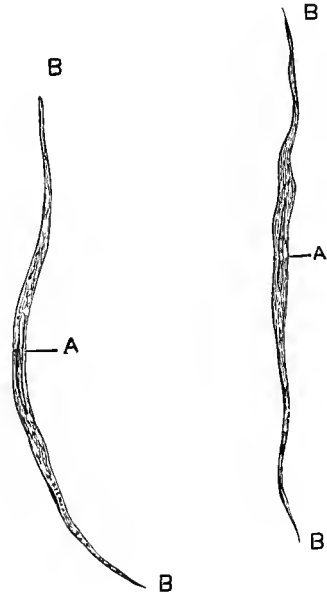

FIG. 273.—MUSCULAR CELLS FROM THE MUSCULAR COAT OF THE STOMACH, ENLARGED TWO HUNDRED AND FIFTY DIAMETERS. (*Ellenberger.*)

A, elongated nucleus; B, pointed ends of the cells.

vertebrates, with the exception of the tissue of the heart, are situated on the surface of the muscular substance, but in invertebrates they are usually found in the central part of the fibres. The muscular fibres are united in bundles by connective tissue and terminate in tendons which are composed of connective-tissue fibrillæ.

The unstriated muscular fibres are composed of elongated spindle-shaped nucleated cells, which are contractile in one direction. These

cells are arranged in bundles connected by a cement substance; they do not terminate in tendons, but are arranged in groups, usually in the form of a membrane; such muscular fibres are found in the walls of the alimentary canal, in the walls of the genito-urinary passages, in the bronchi, and in various other localities.

(a) *The Chemical Composition of Muscle.*—The chemical constituents found in muscles differ greatly according as the examination is made on fresh, living tissue, or after rigor mortis has set in. All muscles after death lose their irritability, and pass from their flexible, transparent condition into a state of rigidity and opacity, which is described under the general term of rigor mortis. Analogy may be traced in this respect between the living and dead muscle and blood.

Blood in the process of coagulation produces the proteid fibrin; muscle, in the act of dying, produces the proteid myosin.

Before taking up the characteristics of these bodies, further comparison of the characteristics of living and dead muscle deserves attention.

In the first place, in a state of rest, living muscle has an alkaline reaction; in dead muscle, and in muscle in contraction, the reaction is acid, due to the development of paralactic acid, as well as acid potassium phosphate, and carbonic acid.

Living muscle is to a certain extent translucent, extensible, and elastic; dead muscle is opaque, rigid, inextensible, and has lost its elasticity. The main difference, however, between living and dead muscle is found in the coagulation of myosin in the latter. If a living muscle be freed from blood by repeated washing and injection

of saline solution through its blood-vessels, be then frozen, chopped up, and rubbed up in a mortar with four times its weight of powdered ice, containing 1 per cent. of sodium chloride, a mixture is obtained which, below the freezing point, is sufficiently fluid to be filtered. This opalescent filtrate is known as muscle-plasma, and remains fluid only while kept at 0° C. If allowed to be heated above this point it is gradually transformed into a solid jelly, which subsequently separates into a clot and serum. The clot is myosin, and originates in the doubly refractive substance; the serum contains serum-albumen and various extractives.

If a muscle which has already passed into the condition of rigor mortis be washed with water so as to remove the albumen and the dif-

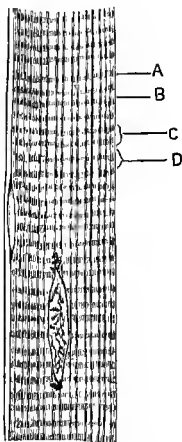

FIG. 274. — PRIMITIVE BUNDLE FROM THE BICEPS BRACHII OF THE HORSE. (*Tereq.*)

A, intermediary disks; B, central disks; C, dark striation; D, light striation.

ferent extractive matters, and then be extracted with 10 per cent. solution of sodium chloride, a large portion of the muscular tissue will be dissolved and will form a viscid fluid. If this fluid be allowed to fall drop by drop into distilled water a flocculent precipitate will be produced; this precipitate is likewise myosin. As is seen from its method of preparation, myosin is a globulin which is soluble in strong solution of sodium chloride, and which may be precipitated therefrom by dilution with water. Myosin, like other globulins, may be coagulated by heat, although it coagulates at a lower temperature than does serum-albumen, its point of coagulation being from  $55^{\circ}$  to  $60^{\circ}$  C. It is coagulated by alcohol and may be precipitated by an excess of sodium chloride. It is through the action of dilute acids converted into syntonin, or acid albumen. Myosin is, therefore, the result of coagulation of the proteid of muscle-plasma.

In addition to myosin, dead muscle contains serum-albumen and various extractive matters, and bodies belonging to the gelatin group.

In living muscle, on the other hand, myosin is not present, but some substances or substance which in the death of the muscle become converted into myosin, just as the fibrin factors present in living blood in the act of coagulation become converted into fibrin.

The differences already alluded to between living and dead muscle are, without doubt, caused by the appearance of myosin. The process of coagulation of muscle, however, is not directly comparable to that of the coagulation of the blood, for, while in the latter case the alkalinity is preserved, in the former case the alkaline reaction of living muscle gives place to a strongly acid reaction.

Dr. W. D. Halliburton has found that the muscle-plasma of warm-blooded animals is a yellowish, viscid fluid of alkaline reaction, which remains uncoagulated at  $0^{\circ}$  C., and at the temperature of the air sets into a jelly-like clot, on the subsequent contraction of which muscle-serum of an acid reaction is squeezed out.

It was found, however, that cold is not the only agent which will prevent the formation of myosin, but that, as in the case of the blood, solutions of certain neutral salts will act similarly. The solutions found most convenient to use were a 10 per cent. solution of sodium chloride, a 5 per cent. solution of magnesium sulphate, or a half-saturated solution of sodium sulphate. The salted muscle-plasma was prepared either by receiving the expressed muscle-juice into excess of one of these solutions, or else by extracting the finely divided pieces of frozen muscle with the solution in question.

A further resemblance between salted muscle-plasma and salted blood-plasma must be noticed, namely, that on dilution of the mixture of muscle-plasma and salt-solution with water the influence of the latter

in preventing coagulation is removed and a clot of myosin forms. This is first a jellying through the whole liquid; the clot subsequently contracts, squeezing out a colorless fluid or salted muscle-serum; this does not occur if the temperature is kept about  $0^{\circ}$  C., and it occurs much more quickly at the temperature of the body than at that of the air. The formation of the clot at  $36^{\circ}$  C. takes, as a rule, five or ten minutes; at the temperature of the air, several hours. The formation of the clot is accompanied by the development of an acid reaction due to sarcolactic acid; in this the formation of myosin contrasts with that of fibrin. The resemblances between the coagulation in muscle and in blood is, however, so striking as to suggest that the cause is similar; namely, a ferment in both cases. The theory most generally accepted regarding the formation of fibrin is that it is the result of a ferment action on a previously soluble proteid of the globulin class occurring in blood-plasma, called fibrinogen; and the theory Dr. Halliburton now puts forward is that myosin is also the result of a ferment action on a previously soluble globulin occurring in a muscle-plasma, for which he proposes the name myosinogen. This ferment can be prepared from muscle in the same way as Schmidt's fibrin ferment is prepared from blood; muscle is kept for some months under alcohol, dried, and extracted with water. This aqueous extract contains the ferment, and on adding it to the salted muscle-plasma coagulation occurs much more quickly than if water alone be added. Myosin ferment is not identical with fibrin ferment, as it does not hasten the coagulation of salted blood-plasma, nor does the fibrin ferment hasten the coagulation of muscle-plasma. The aqueous solution of the myosin ferment gives the reaction of a proteid of the albumose class, and especially of that variety of albumose to which Kühne and Chittenden have given the name deutero-albumose. This is the same albumose as will be shown presently to exist normally in the muscle-plasma.

The proteids of muscle-plasma can be separated by fractional heat coagulation, by fractional saturation with neutral salts, and by the occurrence of spontaneous coagulation and the separation of the plasma into clot and serum. The proteids were found to be five in number; the names Dr. Halliburton proposes for them and their chief properties are as follow:—

1. *Paramyosinogen*.—This forms a flocculent heat coagulum at  $47^{\circ}$  C. It is precipitated from its solutions in an uncoagulated condition (that is, it can be redissolved in weak saline solutions) by magnesium sulphate or sodium chloride; by the former, when the percentage of salt present reaches 37 to 50; by the latter, when the percentage reaches 15 to 26. The precipitate so obtained occurs in white, curd-like flocculi. It is precipitated also by dialyzing out the salts from its solutions.

2. *Myosinogen*.—This is coagulated by heat at  $56^{\circ}$  C., and the coagulum so formed is a sticky one. It is precipitated by dialyzing out the salt from its solutions; and it is also insoluble in magnesium sulphate solutions of the strength of 60 to 94 per cent. and in saturated solutions of sodium chloride. Weak acetic acid added to its saline solutions gives a characteristic stringy precipitate.

3. *Myoglobulin*.—This resembles serum-globulin in most of its properties. It is coagulated by heat at  $63^{\circ}$  C., and thus differs from serum-globulin, which is coagulated at  $75^{\circ}$  C. It is completely precipitated by saturating its solutions with magnesium sulphate, sodium chloride, or by dialyzing the salts out.

4. *Albumen*.—This appears to be identical with serum-albumen.

5. *Myo-albumose*.—This is not precipitated by heat, by copper sulphate, by magnesium sulphate, or sodium chloride. It is precipitated by saturation with ammonium sulphate; by nitric acid in the cold. The precipitate produced by nitric acid disappears on heating and reappears on cooling. It also gives the biuret reaction—that is, a pink color—with copper sulphate and caustic potash. This proteid is closely associated with the myosin ferment.

Peptones and alkali albumen do not occur in muscle-plasma.

In coagulation of the muscle-plasma the first two proteids go to form the clot, and the three latter remain in the muscle-serum. The name paramyosinogen is given to the first on the list, because, although it forms part of the clot, it seems rather to be accidentally carried down than to form an essential part of the myosin. If pure solutions of paramyosinogen and myosinogen respectively be prepared and ferment added to each, in the former no coagulation occurs, but in the latter myosin is formed. Moreover, paramyosinogen is sometimes absent, or only present in exceedingly minute quantities in the muscle-plasma.

Saline extracts of rigid muscle, or of muscle from which rigor has passed off, differ from the salted muscle-plasma in being of an acid reaction, but otherwise very closely resemble it. Such an extract contains the same five proteids, and, on dilution, myosin separates as it does from muscle-plasma; pure myosin, also, if redissolved in a 10 per cent. magnesium sulphate or sodium chloride solution can similarly be made to undergo a re-coagulation on dilution and addition of the ferment. Moreover, this re-coagulation resembles in all particulars the coagulation which takes place in muscle-plasma; it is first a jelly; the jelly contracts, squeezing out a colorless fluid; it is inhibited by cold, occurs most readily at the temperature of the body, is accompanied by the formation of sarcolactic acid, and is hastened by the addition of myosin ferment. In this particular we have, also, an important difference between the coagulation of blood and of muscle. Fibrin cannot be reconverted into fibrinogen in

the same way as myosin can be converted into myosinogen, which will again coagulate with the formation of myosin. The ease with which myosin can thus be made to clot and unclot outside the body might seem to be a confirmation of Hermann's view that a similar clotting and re-resolution of myosin accompanies the contraction and relaxation of muscle during life; in other words, that each contraction is the partial death of a muscle. We must remember that the most important similarity between rigor mortis and contraction is the formation of sarcolactic acid, and not the development of a clot of myosin; in fact, as a muscle becomes more extensible during contraction, it becomes in a sense more liquid, not more solid, as it does when myosin is formed post-mortem.

Dr. Halliburton further suggests that the passing off of rigor mortis is due to the reconversion of myosin into myosinogen, brought about by the pepsin present in muscle. For when muscle becomes acid in rigor mortis the pepsin which it contains is enabled to act, and at the suitable temperature ( $35^{\circ}$ – $40^{\circ}$  C.) albumoses and peptones are formed by a process of self-digestion. This is a more satisfactory explanation of the disappearance of rigor mortis than putrefaction, for rigor mortis occasionally persists after putrefaction has set in, and at other times disappears within an hour after death.

The chemical processes continually occurring in living muscle also undergo change on the death of the muscle. It has been found that living muscle is continually appropriating oxygen from the arterial blood and setting free carbon dioxide. In the death of the muscle the absorption of oxygen ceases, while the exhalation of carbonic acid may continue for a certain time, even if the dead muscle be placed in an atmosphere free from oxygen; it is, therefore, evident that in the act of death or in the production of rigor mortis some complex compound is split up and carbon dioxide set free.

Living muscle is, then, alkaline and contains in solution in the substance of its fibres a coagulable proteid in the muscle-plasma.

Dead muscle, on the other hand, is acid in reaction from the development of sarcolactic acid, and the coagulable plasma has become converted into a solid myosin in muscle-serum. When muscles are subjected to the vacuum of a mercurial air-pump, a certain amount of gas, which is almost solely  $\text{CO}_2$ , is extracted, which has been in part dissolved in the muscle-plasma and in part combined with its salts. In muscles in which rigor mortis has not taken place, 2.74 volumes per cent. of  $\text{CO}_2$  represent the free gas, 1.95 per cent. the fixed gas. If, however, rigor mortis be produced, then 15 volumes per cent. of  $\text{CO}_2$  may be obtained. Therefore, in rigor mortis a large amount of  $\text{CO}_2$  becomes free, but this is not due to the decomposition of carbonates by the acid formed in the same process. So also in muscular contractions there is an increase in



the amount of CO<sub>2</sub> in muscles capable of withdrawal by the air-pump amounting to 12.08 per cent. by volume of the muscle. The other constituents of the muscle are represented in the following table (Charles):—

ANALYSES OF MUSCLE.

COMPONENTS IN 100 PARTS.	Mean of Human Muscle.	Mean of Muscle of Mammals.	Muscle of Birds.	Muscle of Fish.	Muscle of Frogs.
Water,	73.50	72.87	73.00	71.08	80.43
Solids coagulated,	26.50	27.13	27.00	25.92	19.57
Albumen (myosin, etc.) and other derivatives, sarcolemma, vessels, nerves, etc, insoluble in water.					
Soluble albumens or albuminates:					
Hæmoglobin,	1.84	2.17	3.13	3.61	1.86
Fat,	3.27	3.71	1.94	4.59	0.10
Gelatin,	1.99	3.16	1.40	4.34	2.48
Kreatin,	0.22	0.18	0.33	...	0.28
Ash,	3.12	1.14	1.30	1.49	

The constituents of muscle are, therefore, nitrogenous, non-nitrogenous, and inorganic. Under the former group occur myosin, alkali albuminate, and serum-albumen, with extractives such as kreatin, sarkosin, sarkin, xanthin, and carnin.

Of the non-nitrogenous bodies, inosite, fat, and glycogen are the most important, while phosphoric acid, potassium, sodium, magnesium, and lime are the principal inorganic constituents.

(b) *Muscular Irritability*.—The principal physiological difference between living and dead muscle is that the former, under the action of various stimuli, is thrown into contraction. This property of contraction results from what is termed irritability of the muscle.

If the spinal cord and brain of a frog be destroyed the animal remains perfectly passive, without any contraction occurring in any of its muscles. If, however, any stimulus, mechanical, electrical, or thermal, be applied to its muscles they at once shorten, and it is only on the onset of rigor mortis that this power disappears. If the stimulus be applied to a motor nerve-trunk a similar state of contraction is produced.

In the destruction of the central nervous system the peripheral nerve-branches have, of course, not been destroyed, and yet the contractility of muscle is not dependent upon the stimulation of nerve-fibres distributed to it, for muscle, like other forms of protoplasm, possesses an independent excitability. This may be demonstrated by a number of different methods. In the first place, various chemical stimuli, such as ammonia, lime-water, etc., do not produce muscular contraction when applied to motor nerves, but do evoke contraction when directly applied to muscle. Again, in various muscles it is impossible to recognize the

presence of nerve-filaments, as in the extremes of the sartorius muscle of the frog, and yet in them stimulation applied directly to a muscle produces contraction. The most conclusive evidence, however, of the independent irritability of muscles is found through the use of the poison, curare.

This substance, a South American arrow-poison, possesses the property of entirely paralyzing the terminal filaments of the motor nerves. If an animal, such as the frog, be poisoned with this drug, stimuli applied to the motor nerves will be entirely incapable of producing muscular contraction. The same stimulus, however, applied directly to the muscle still produces a characteristic normal contraction. This poison acts, not on the nerve-trunks, but on the intra-muscular terminations of the nerves. This fact may be demonstrated by ligating the sciatic artery in one hind leg of the frog and injecting curare into the dorsal lymph-sac. The poisoned blood will then, of course, circulate in every part of the body with the exception of the limb in which the circulation has been arrested. If a stimulus be then applied to the sciatic nerve of the non-poisoned limb it will still succeed in calling forth a contraction, even although the sciatic trunk has been exposed to the action of curare. Stimulation of the sciatic, on the other hand, in the limb in which the circulation has been maintained, and in which, of course, the poison has had access to the nerve-filaments produces no contraction, while local stimulation of the muscle does.

Muscular contraction may be produced by various stimuli, acting either indirectly upon the muscle through its motor nerve, or directly by being immediately applied to the muscle substance.

Muscular stimuli may be either chemical, thermal, mechanical, or electrical. All chemical substances, such as acids and various metallic salts, which alter the composition of muscle are muscular stimuli. Variations of temperature also produce muscular contraction. Thus, if an excised frog's muscle be heated rapidly to about  $28^{\circ}$  C., contraction commences and reaches its maximum at  $45^{\circ}$  C. If the temperature be raised above this point the muscle passes into a condition of heat-rigor, due to the coagulation of the proteids of muscle. Sudden mechanical stimuli, whether applied directly to the muscle or indirectly to the nerve, if repeated with sufficient rapidity, also produce contraction of muscle. Strong local irritation, as by a blow, produces a long-continued, weak-like contraction of the part stimulated.

(c) *The Phenomena of Muscular Contraction.*—Muscular contraction consists in the shortening of muscle-fibres in the direction of their long axes, with a proportionate and simultaneous increase in their transverse diameter. Such a contraction is accompanied by a number of phenomena, of which the most evident is the change in form.

When a single induction shock is allowed to pass through the motor nerve of a muscle, the muscle at once gives a single short contraction. The phenomena of such a muscular contraction may be best studied on

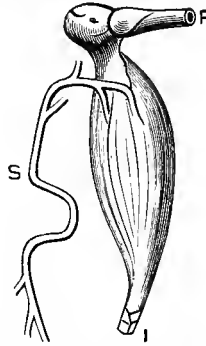

FIG. 275.—THE NERVE-MUSCLE PREPARATION. (*Stirling.*)  
F, lower third of femur; S, sciatic nerve; I, tendon of gastrocnemius muscle.

the gastrocnemius muscle of the frog. Various contrivances have been devised for graphically representing the results of the muscular contraction. The simplest method is to support the knee-joint of a frog's leg in a clamp, connecting the tendon of the gastrocnemius by

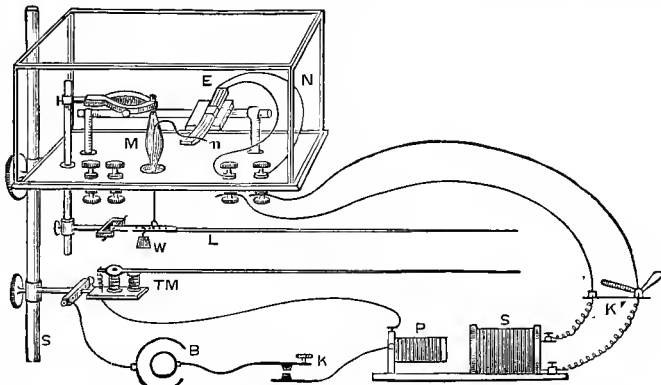

FIG. 276.—ARRANGEMENT OF APPARATUS IN CONDUCTING EXPERIMENTS ON NERVE AND MUSCLE. (*Stirling.*)

B, galvanic battery; K, electric key in primary circuit; P, primary coil of induction machine; S, secondary coil of induction machine from which the current is conducted, when the key, K, is open, to the electrode, E, on which rests the nerve, *n*; the muscle, M, is supported by a clamp, under a glass shade, its tendon being connected by a thread with a lever, L, resting on the smoked surface of a revolving drum. The time-marker, TM, is included in the primary circuit, so that when the current passes through P, by closing the key, K, it also traverses the electro-magnet and causes a record of the instant of stimulation to be made on the surface of the drum. S, stand supporting moist chamber; W, weight by which muscle is extended, and which is lifted in the contraction.

means of a thread to a lever, which records its movements on a rapidly moving surface. If a single induction shock is then passed through the sciatic nerve or directly applied to the muscle the so-called muscle curve will be obtained (Figs. 275 and 276).

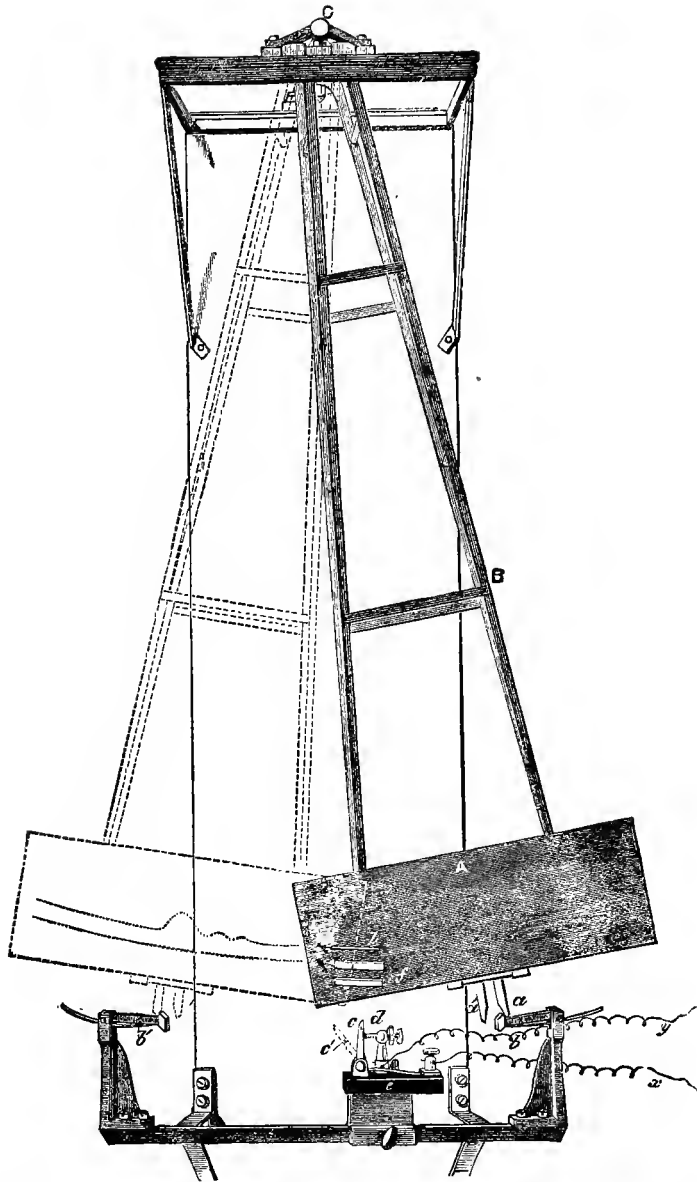

FIG. 277.—THE PENDULUM MYOGRAPH. (Foster.)

The figure is diagrammatic, the essentials only of the instrument being shown. The smoked-glass plate, A, swings on the "seconds" pendulum, B, by means of carefully adjusted bearings at C. Before commencing an experiment the pendulum is raised up to the right, and is kept in that position by the tooth, *a*, catching on the spring-catch, *b*. On depressing the catch, *b*, the glass plate is set free, swings into the new position indicated by the dotted lines, and is held in that position by the tooth, *a'*, catching on the catch, *b'*. In the course of its swing the tooth, *a'*, coming into contact with the projecting steel rod, *c*, knocks it on one side into the position indicated by the dotted line, *c'*. The rod, *c*, is in electric continuity with the wire, *e*, of the primary coil of an induction machine. The screw, *d*, is similarly in electric continuity with the wire, *y*, of the same primary coil, both rod and screw being insulated by the ebonite block, *e*. As long as *c* and *d* are in contact, the circuit of the primary coil is closed. When in its swing the tooth, *a'*, breaks this contact, the circuit is broken, and a "breaking" induction shock is sent through the electrodes connected with the secondary coil of the induction machine to the nerve. The lever, *l*, is connected with the tendon of the muscle, and is brought to bear on the glass plate, and when no muscular contraction is produced in the swing of the pendulum traces a straight line, or rather an arc of a circle. When the muscle is stimulated during the swing of the pendulum, the muscle curve is produced. The tuning-fork, only partly shown, serves to mark the rapidity of motion of the pendulum.

Such a curve (as produced by the pendulum myograph, Fig. 277) is represented in Fig. 278. To study the characteristics of such a curve more fully certain additional apparatus is necessary. In the first place, it is necessary to know the rate of motion of the recording surface. This may be accomplished by means of a recording tuning-fork writing on the traveling surface. It is further necessary to indicate the instant at which the nerve or muscle receives the stimulus. This may be done by including an electro-magnet writing on the traveling surface in the current through which the stimulus to the muscle passes. If the curve be examined, it will be noticed that the muscle does not commence to shorten instantaneously with the entrance of the stimulus into the nerve, but an appreciable interval elapses after the application of the stimulus before contraction commences. This interval is termed the latent period, and is usually about one-seventieth part of a second. The duration of the latent period will depend upon the distance through which the stimulus

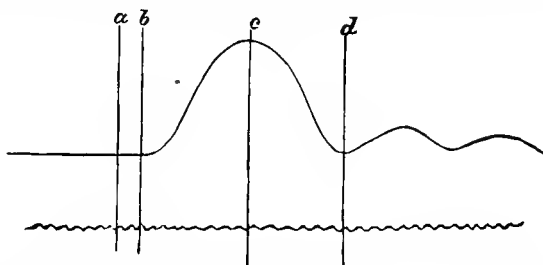

FIG. 278.—MUSCLE CURVE OBTAINED BY MEANS OF THE PENDULUM MYOGRAPH. (Foster.)

(To be read from left to right.)

*a* indicates the moment at which the induction shock is sent into the nerve; *b*, the commencement; *c*, the maximum; and *d*, the close of the contraction. The two smaller curves are due to oscillations of the lever. Below the muscle curve is the curve drawn by a tuning-fork, making one hundred and eighty double vibrations a second, each complete curve, therefore, representing 1/180 of a second.

has to pass through the nerve before entering the muscle. If the electrodes be moved along the sciatic nerve farther from the muscle, the latent period will be increased. If moved down closer to the muscle, or applied directly upon the muscle, although not absent, the duration of the latent period will be greatly reduced (Fig. 279). It is, therefore, evident that while part of the latent period is consumed in the conduction of the stimulus through the nerve, yet a considerable fraction of it is taken up in changes in the muscle itself which precede active contraction, and this process occupies the greater portion of the latent period.

When the stimulus or induction shock is applied to the nerve the latent period is partly due, in the first place, to the production of a nerve impulse in the nerve; and, second, the progression of that impulse through the nerve to the muscle; and, third, the changes already alluded to which occur in the muscle itself.

In the second case the rate of transmission of the nerve impulse has been placed about twenty-eight meters per second. After the latent period has been completed the muscle then commences to shorten, at first slowly and then more rapidly, and then again more slowly until the maximum shortening is reached, the duration of active contraction occupying about the one-twentieth part of a second. As soon as the maxi-

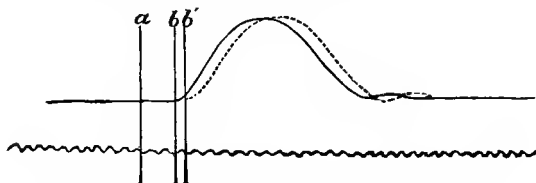

FIG. 279.—DIAGRAMMATIC CURVES ILLUSTRATING THE MEASUREMENT OF THE VELOCITY OF A NERVOUS IMPULSE. (Foster.)

(To be read from left to right.)

The same nerve-muscle preparation is stimulated (1) as far as possible from the muscle, (2) as near as possible to the muscle, both contractions being registered in the same manner on the pendulum myograph.

In (1) the stimulus enters the nerve at the time indicated by the line, *a*; the contraction, shown by the dotted line, begins at *b'*; the whole latent period is, therefore, indicated by the distance from *a* to *b'*.

In (2) the stimulus also enters the nerve at *a*, the contraction begins at *b*, and is shown in the unbroken line; the latent period, therefore, is indicated by the distance from *a* to *b*. The time taken up in the passage of the nerve impulse in the length of nerve between 1 and 2 is indicated by the distance between *b* and *b'*, and may be measured by the tuning-fork curve below. The distance between these curves is exaggerated for the sake of simplicity, no value being given for the rate of vibration of the tuning-fork.

imum contraction is reached relaxation commences, following the same general course as in shortening, relaxing first slowly then more rapidly, and then more slowly again, the general duration of the active relaxation being somewhat longer than that of contraction. Such are the general characteristics of the curve of a single muscular contraction produced by a single stimulus.

If a single stimulus be allowed to follow the first it will be followed,

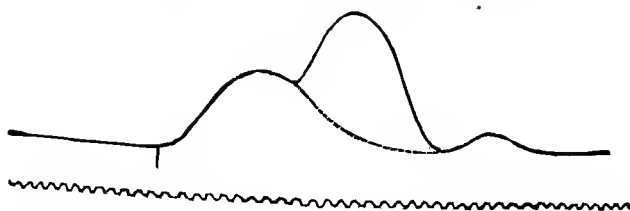

FIG. 280.—TRACING OF A DOUBLE MUSCLE CURVE. (Foster.)

(To be read from left to right.)

While the muscle was engaged in the first contraction (whose complete course, had nothing intervened, is indicated by the lower line in the muscle-curve) a second induction shock was thrown in at such a time that the second contraction began just as the first was beginning to decline. The second curve is seen to start from the first, as does the first from the base line.

like the first, by a single muscular contraction. If the interval between the second and first muscular contraction be gradually reduced, a point will ultimately be reached in which the second stimulus enters the nerve before the contraction produced by the first has passed off. The result will be that the muscle will undergo a second shortening, and such a

curve will be produced as is represented by Fig. 279. The two contractions are thus added together and the total shortening may be nearly double that produced by a single contraction (Fig. 280).

If a third stimulus is then allowed to pass into the nerve before the second contraction has passed off, a third contraction will be added to the second, and so on in the case of the fourth, fifth, or more. It will be, however, noticed that while the second contraction may be nearly or quite as extensive as the first, the third and fourth progressively decrease in extent, until finally simply a broken line without any extensive increase in contraction will indicate the entrance of the separate stimuli, the stimuli merely serving to keep up the contraction already produced.

When the stimulation ceases the muscle then rapidly passes into a condition of rest, relaxation occurring very rapidly.

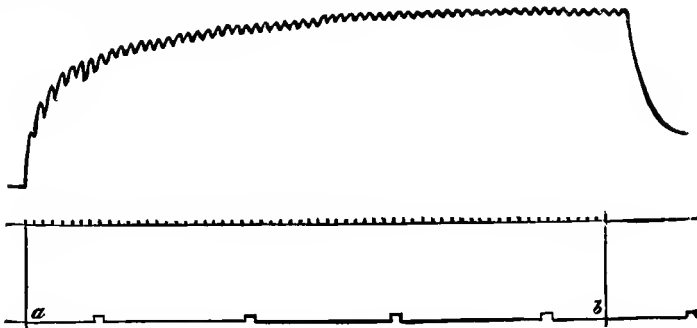

FIG. 281.—MUSCLE THROWN INTO TETANUS WHEN THE PRIMARY CURRENT OF AN INDUCTION MACHINE IS REPEATEDLY BROKEN AT INTERVALS OF SIXTEEN IN A SECOND. (Foster.)

(To be read from left to right.)

The upper line is that described by the muscle. The lower marks time, the intervals between the elevation indicating seconds. The intermediate line shows when the shocks were sent in, each mark corresponding to a shock. The lever, which describes a straight line before the shocks are allowed to fall into the nerve at *a*. Having risen to a certain height it begins to fall again, but in its fall is raised once more by the second shock, and that to a greater height than before. The third and succeeding shocks have similar effects, the muscle continuing to become shorter, though the shortening at each shock is less. After a while the increase in the total shortening of the muscle, though the individual contractions are still visible, almost ceases. At *b* the shocks cease to be sent into the muscle, the contractions almost immediately disappear, and the lever forthwith commences to descend. The muscle being only slightly loaded, the relaxation is very slow.

When the separate stimuli do not follow each other more rapidly than sixteen in a second, the contraction produced by one stimulus has had time to undergo partial relaxation before the following stimulus enters; as a consequence, the point of the lever traces a broken line on the traveling surface (Fig. 281).

If, however, the stimuli follow each other more rapidly than this, an apparently constant shortening is produced, in which no variation whatever in length can be made out. The gradual production of this state of affairs indicates that this apparently constant and uniform contraction is, nevertheless, made up of a large number of individual contractions added to each other. Such a condition is spoken of as tetanus, and the

curve produced in such a tetanic muscular contraction is represented in Fig. 282.

Tetanic contraction requires for its production at least a greater number than sixteen stimuli per second. It may thus be most readily produced by the employment of a rapidly interrupted induction current.

Tetanus may, however, also be produced by mechanical stimulation, provided the impulses succeed each other with sufficient rapidity. In the case of chemical stimulation tetanus is the ordinary expression of muscular contraction.

It is thus evident that the tetanic contraction is composed of a series of vibrations of the muscular fibre, and, as would be expected from this statement, is accompanied by the production of a musical note, the pitch of the note depending upon the number of vibrations of the muscular fibre. Wherever the muscle is artificially thrown into tetanus, as by the action of an interrupted induced current, the number of vibrations, of course, corresponds to the number of contractions, these depending



FIG. 282.—TETANUS PRODUCED WITH THE ORDINARY MAGNETIC INTERRUPTER OF AN INDUCTION MACHINE, THE RECORDING SURFACE MOVING SLOWLY. (Foster.)

(To be read from left to right.)

The interrupted current being thrown in at *a*, the lever rises rapidly, but at *b* the muscle reaches the maximum of contraction. This is continued until at *c*, when the current is shut off and relaxation commences.

upon the number of interruptions of the current, and, as a consequence, the number of vibrations of the muscle and the corresponding note produced have a pitch which corresponds in vibration to these data.

When the ear is placed over a muscle which is thrown into contraction by means of the will a musical tone is likewise appreciated. This serves to indicate that even in a single sharp contraction of a muscle through the action of the will, that apparent single contraction is made up of a number of contractions, and every single muscular movement of the animal body is, therefore, of the nature of a tetanus.

The musical note heard indicates that the rate of vibration is 19.5 per second.

We may now study the changes which occur in contracting muscle in somewhat more detail. The most obvious is, of course, the change of form. Such a change of form is represented by a decrease in the long axis of a muscle, the shortening, perhaps amounting to three-fifths, of the length of the muscle, with a corresponding increase in the cross diameter.



There is no actual change in bulk in muscular contraction, the increase in thickening being almost precisely proportionate to the decrease in length.

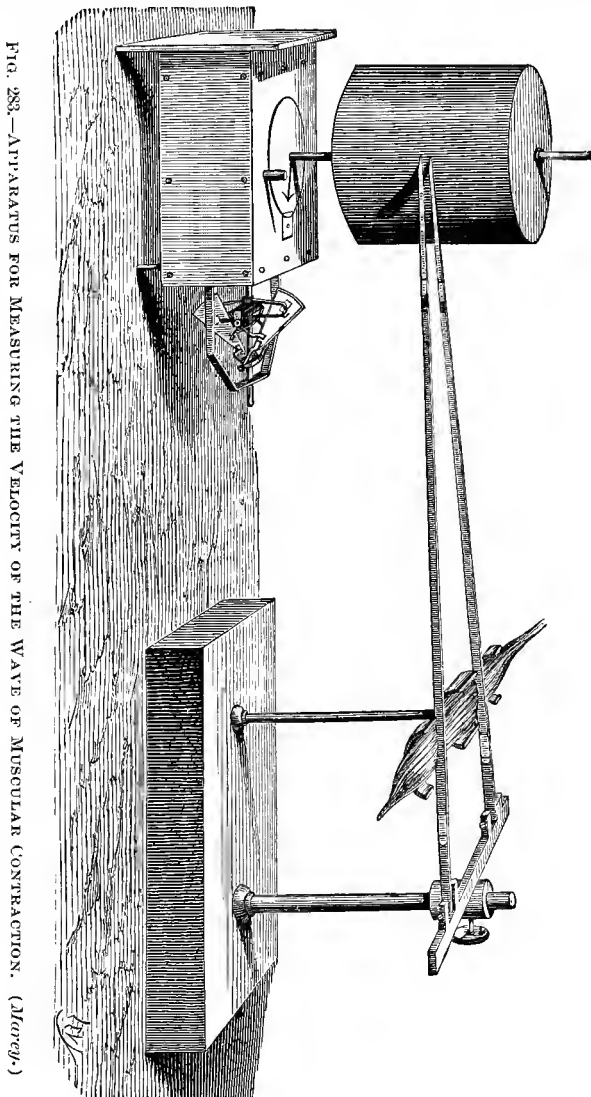

FIG. 283.—APPARATUS FOR MEASURING THE VELOCITY OF THE WAVE OF MUSCULAR CONTRACTION. (Morgan.)

This fact may be demonstrated by connecting the sciatic nerve of a frog's leg with the poles of an induction machine and then placing the leg in a bottle filled with dilute saline solution, in the stopper of which is inserted a capillary tube. Care should be taken that no air-bubbles are present in the bottle, that the bottle is filled, and that the fluid ascends up a certain distance in the capillary tube. If the leg is then thrown into contraction by passing a current through the wires,

the level of the fluid in the capillary tube will remain almost constant, thus indicating an absence of change in the bulk of muscle, for a decrease would, of course, be indicated by a fall of fluid, and increase of bulk would raise the fluid in the capillary tube. By extremely accurate measurements a slight actual decrease in volume may be made out. Thus, Valentine has determined that a muscle with a volume of two thousand seven hundred and six cubic centimeters in contraction in tetanus is reduced to two thousand seven hundred and four cubic centimeters, while its specific gravity increases from 1061 to 1062.

When a muscle is thrown into contraction, it does not occur simultaneously in all the muscle-fibres. If a muscle-fibre be placed under a microscope and then thrown into contraction a wave of undulation may be seen to be rapidly propagated from one end of the fibre to the other. This wave is especially sensible if the muscular fibre is fixed at each extremity. If a long muscle, such as the sartorius of the frog, have its motor nerve-filaments paralyzed by curare, and the muscle then thrown into contraction by stimulating one extremity with an induction current, the wave of contraction travels so slowly as almost to be capable of being seen by the eye. If such a muscle be supported

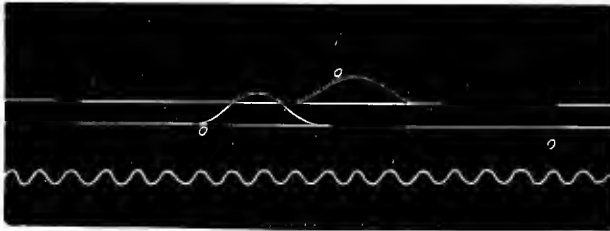

FIG. 284.—CURVE ILLUSTRATING THE PROPAGATION OF THE WAVE OF MUSCULAR CONTRACTION. (*Marey.*)

The lower of the two straight lines represents the point of the lever resting on the muscle nearest the point of stimulation. If the time between the moment of commencing contraction at this spot and that of commencing contraction at the spot on which the second lever rests be measured by counting the vibrations of the tuning-fork, the rate of progression of the contraction may be determined.

horizontally and two light levers be placed at a distance from each other bearing on the muscle and writing over each other on a recording surface (Fig. 283), if the muscle be then thrown into contraction by direct stimulation the levers will not be elevated simultaneously, but a curve similar to that represented in Fig. 284 will be produced. By measuring the distance between the commencement of these two contractions and knowing the rate of movement of the recording surface, the rate of progression of the wave may be calculated. If, instead of stimulating the muscle, the nerve (in such an experiment) be stimulated, if no curare have been given both levers will be simultaneously elevated.

According to Bernstein, the rate of progression in the muscles of cold-blooded animals of the wave of contraction is about two to three meters per second. Its rate of progression is much more rapid in the case of warm-blooded animals.

The irritability of muscle is subject to great variation, and a single irritant is, under different circumstances, capable of producing different results. In an excised muscle the irritability rapidly disappears, although it persists much longer in the muscles of cold-blooded animals than in warm-blooded. In the latter case the irritability of warm-blooded muscles may be somewhat prolonged if the animal be artificially cooled before death.

Temperature is of great influence on the irritability of muscle, both an increase or decrease above the normal temperature of the muscle being followed by a decrease in irritability. Again, through repeated contraction the muscle loses its power of being thrown into contraction; it is then said to be in a condition of fatigue, due either to the insufficient supply of nutritive substances or to the accumulation of the products of decomposition, which, as has been experimentally demonstrated, produce a hurtful action upon the muscle-fibres. In all probability both of these factors are concerned in fatigue.

When a contracting muscle is examined under the microscope marked changes in structure may be made out. If a living muscular fibre of an insect, for example, which is especially fitted for such study, be examined under the microscope while contracting, a wave of contraction, as already mentioned, may be seen traveling along the surface of the fibre, while at the same time the transverse striations approach each other. In the contracted portion each disk has become shorter and broader, while the band which in a relaxed muscle is light, in a contracted muscle becomes dark, and the band which in a relaxed muscle was dark in the contracted muscle becomes light (Fig. 285).

In the process of contraction chemical changes occur; these have been already to a certain extent indicated. The muscle in which reaction was alkaline, in contraction becomes acid through the development of sarcolactic acid, which may even be excreted by the kidneys. During its contraction the muscle absorbs more oxygen from the blood than during its stage of rest, and, as a consequence, venous blood from a resting muscle contains 8.5 per cent., that from a contracting muscle 12.8 per cent. less oxygen than the arterial blood; while the venous blood from a resting muscle contains, as an average, 6.7 per cent., that from a

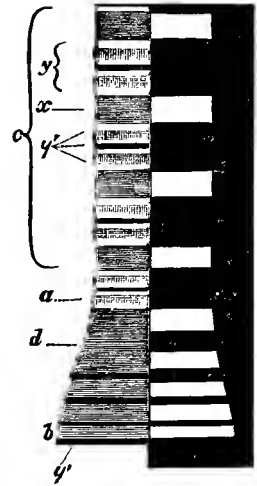

FIG. 285.—MUSCULAR FIBRE UNDERGOING CONTRACTION, AFTER ENGLMANN. (Foster.)

The muscle is that of *Telephorus melanurus* treated with osmic acid. The fibre at *c* is at rest, at *a* the contraction begins, at *b* it has reached its maximum. The right-hand side of the figure shows the same fibre as seen in polarized light.

contracting muscle 10.8 per cent. more carbon dioxide than arterial blood. The amount of oxygen consumed, as may be noticed from these figures, bears no relationship to the amount of carbon dioxide liberated; whence it follows, as already stated, that the formation of carbon dioxide in a contracting muscle is not a simple process of oxidation, but rather the splitting up of some complex compound.

During contraction the glycogen of the muscles becomes reduced, while, on the other hand, there is an increase in the amount of kreatin obtainable from the contracted over that found in the resting muscle.

The question, What is the source of the carbon dioxide and lactic acid developed by a contracting muscle? may, perhaps, be answered by the statement that they are derived neither from the albuminous nor fatty constituents of the muscle, but from the carbohydrates, especially from the glycogen, which may even entirely disappear during the stage of contraction of a muscle, even although the amount of nitrogenous decomposition products in the muscle is not increased and the amount of fat not diminished. From the greater demand of oxygen by a contracting muscle we find, as a consequence, a greater increase in the supply of the arterial blood furnished to a muscle in contraction.

When a muscle contracts, its arterioles dilate, more blood passes through the muscle, and, as a consequence, the removal of the increased carbon dioxide formed is facilitated. It would appear from this that the source of muscular force is found, not, as was formerly supposed, in the breaking up of albuminoids, but in the chemical changes occurring in muscle which are evidenced by the breaking up of the carbohydrates.

This statement may appear contradictory to common experience, which teaches that animals fed with albuminoids do more work than those fed on a diet less rich in albuminoids. Our studies on nutrition have, however, indicated that a large supply of albuminous matter renders possible the use of the larger amount of carbohydrates. This will, perhaps, explain the fact that well-nourished herbivora are able to develop more force than the apparently much more powerful carnivora, and that the activity of muscle does not increase the breaking up of albuminates but increases the elimination of carbon dioxide. The few examples in which muscular work is accompanied by an increased excretion of urea, such, for example, as may be occasionally seen in the horse, are only to be accounted for by the insufficiency of the quantity of carbohydrates administered in the food, this insufficiency necessitating a destruction of the proteids for the development of force.

As might be supposed from the above, every muscular contraction is accompanied by an elevation of temperature. Such a heat production may be determined experimentally by a thermometer, and, in a general way, it may be stated that within certain limits the greater the work

demand of a muscle, in other words, the greater the resistance to be overcome, the greater will be the amount of heat production; and, as a consequence, in a contracting muscle, not only is energy liberated but heat is developed, which is capable of being converted into actual energy. The heat development of a contracting muscle is not only dependent upon the amount of work done, but also on the tension of the muscle, and the heat production reaches its maximum when the tension exerted on the muscle is so great that it is not able to contract.

Since a muscle in contracting is capable of lifting a weight, it is, therefore, likewise capable of accomplishing work. The amount of work will depend upon the size of the weight, upon the distance to which the weight is lifted, and upon the time during which this lifting continues. It was found that the degree of contraction was proportionate to the degree of stimulation. Therefore, the maximum amount of work capable of being produced by a muscle is accomplished when the maximum weight is lifted. The amount of work which a muscle may perform is, therefore, equal to the product of the weight lifted and the height to which it is lifted: thus, if a muscle contracts where no load is present, it accomplishes no work; or, if it be loaded beyond the point at which the load may be lifted, again no work is accomplished. If the weight be gradually increased, even although it may be lifted, the height to which that lift is accomplished becomes reduced, and, as a consequence, the work diminishes.

The amount of work which a muscle may accomplish is greater in proportion to the transverse section of the muscle, for the longer the muscle the greater is the shortening, and, accordingly, the higher the lift. In muscles within the animal body the amount of shortening which they may attain is never capable of reaching the maximum obtained in a similar excised muscle. The force with which a muscle contracts is greater at the commencement of contraction, and, when a muscle begins to contract, it can, therefore, lift the largest load. If a muscle loaded with a weight be stimulated with a rapidly interrupted induction current, after the muscle has once contracted no further lift is produced and no external work is evident; but if the muscle sustain a weight at the height to which it raised it, the amount of work, in this case the amount of energy developed by the prolonged contraction of the muscle, is converted into heat.

When a muscle is stimulated with a feeble induced current and the current then gradually increased in strength, it will be found that the height to which the load may be lifted increases with the strength of the stimulus.

(d) *The Electrical Phenomena in Muscle.*—If the gastrocnemius muscle of the frog be excised and its tendinous insertions cut off, and two

points of this surface, or the longitudinal surface of the muscle and the transverse section, be connected by non-polarizable electrodes with a sensitive galvanometer, at the moment of making the contact a deflection of the galvanometer needle will take place, indicating the presence of a galvanic current. The strongest effect is produced when one point of the transverse section and one point of the longitudinal surface are connected with a galvanometer; even single fibres, nevertheless, if brought into connection with a galvanometer also develop galvanic currents. The direction of the current is from the longitudinal section through the conducting wires to the transverse section; within the muscle itself the current passes from the transverse to the longitudinal section. The nearer the one electrode is to the equator and the other to the centre of the transverse section the stronger will be the current, while the current becomes more feeble when one electrode is approached to the outer surface and the other to the edge of the transverse section.

The existence of a muscle current may further be proved by an experiment which is termed the rheoscopic frog. If the gastrocnemius muscle of a frog be prepared with a long piece of sciatic nerve still in connection with it, and the end of the nerve be placed over another excised, fresh gastrocnemius muscle, so as to be in contact with its transverse and longitudinal surfaces, contraction of the muscle connected with the nerve occurs at the moment of contact. A single contraction is, however, only produced, but if the nerve be removed from the muscle a second contraction occurs; thus pointing out that the current circulating through the muscle is a constant current and may serve to stimulate other muscles or nerves at the moment of breaking and making the contact. If a muscle be prepared as before, connected with a galvanometer, and be found to yield a strong galvanic current, if the muscle be then thrown into tetanus by electrical stimulation of the muscle itself, or of its motor nerve, the needle of the galvanometer will be found to swing back to zero, indicating the disappearance of the muscle current; such a state of affairs is spoken of as the negative variation of the muscle current.

2. THE APPLICATIONS OF MUSCULAR CONTRACTILITY.—The contractility of muscles serves especially to produce changes in form of the animal body by which single members are thrown out of their condition of equilibrium and changes of location in the animal parts thus produced; or in the case of the unstriped muscles to diminish the capacity of the various cavities of the animal body. Hence, muscles may be classified into two different groups: those without a definite origin and insertion, and those in which definite origin and insertion are present. To the first group belong the hollow muscles surrounding the urinary bladder, gall-bladder, uterus, heart, intestinal canal, blood-vessels, ureters, etc. In such instances the muscular fibres are unstriped and involuntary and are

arranged in several layers, an oblique, circular, and longitudinal layer being in nearly all cases distinguishable; all these sets of fibres acting simultaneously, the result is to diminish the capacity of the cavity which they inclose. They thus aid in various motions of animal life, such as the propulsion of the blood from the heart and in assisting its onward passage through the arteries, the evacuation of the bladder and rectum, the emptying of the pregnant uterus, and various other operations which have been already alluded to. In addition to this group of muscles, the sphincters likewise have no definite origin or insertion, but are found at the various openings of the body, whether the anus, urethra, or mouth, and several other localities. The muscular fibres of the sphincters are circular, and by their contraction serve to close the orifices of these several openings.

Of the muscles with definite origin and insertion, either the origin is fixed or both origin and insertion may be movable. In many cases belonging to the former of these groups the origin is only fixed during muscular action; thus, in the case of the palato-pharyngeal muscles their characteristic action is only rendered possible by the fixation of their origin through the contraction of the levator palati muscle.

Again, both origin and insertion may be movable, the part moved being usually under the control of the will. Thus, in the case of the sterno-mastoid muscle, through its contraction the head may be depressed or the chest elevated.

Movement of the animal parts or of the entire animal body is rendered possible through the manner in which the skeletal muscles are inserted in the long bones by which lever motion is possible, the bones being regarded as levers, the joint as the fulcrum, the insertion of the muscle the point of application of the power, and the centre of gravity of the bone with the resistances overcome by its motion as the load.

Thus, muscles arising in one bone and inserted in another will, in their contraction, either move both bones toward each other, or, if one be fixed, will approach the movable to the fixed bone. From the definition of the power-arm of a lever, it is evident that in general the direction of muscles relative to the levers on which they act is very disadvantageous, since their course is almost always more or less parallel to the bony levers. This parallelism is diminished by the swelling of the articular extremities and by the development of more or less marked eminences, such as the olecranon or the trochanters, or by the presence of sesamoid bones. In movements of flexion, however, this parallelism becomes diminished according to the degree of flexion, so that, therefore, at the termination of the act of flexion the muscles are more favorably situated for the development of power. Certain muscles, however, such as the muscles of mastication, the flexors of the head, the psoas muscles, and the abductors

and adductors of the arm have their insertion almost perpendicular to the bones on which they act.

Although all three classes of levers are met with, in general the lever of the first class comes into play in movements of extension, and that of the third class in movements of flexion.

A lever may be defined as an inflexible bar capable of being freely moved about a fixed point or line, which is called the fulcrum. In the first class of lever the fulcrum lies between the weight and the power, and may be illustrated by a common crowbar or a pair of seissors. In levers of the second class the weight lies between the fulcrum and the power, and may be illustrated by the wheelbarrow or nutcracker. In the third class of lever the power falls between the fulcrum and the weight, and may be illustrated by a pair of fire-tongs or sheep-shears (Fig. 286.)

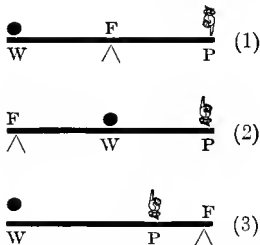

FIG. 286.—THREE CLASSES OF LEVERS. (*Landois.*)

W, weight; F, fulcrum; P, power; 1, in levers of first class the fulcrum is between the power and the weight; 2, in levers of second class the weight falls between the power and fulcrum; 3, in levers of third class the power is applied between the fulcrum and weight. The index shows the direction in which the power acts.

In considering the development of power by the use of levers, the relationship between the power- and the weight-arm has to be considered. The power-

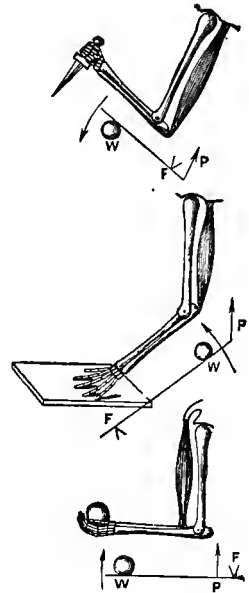

FIG. 287.—DIAGRAMS SHOWING THE MODE OF ACTION OF THE THREE ORDERS OF LEVERS, NUMBERED FROM ABOVE DOWNWARD, ILLUSTRATED BY THE ACTION OF THE ELBOW-JOINT. (*Yeo.*)

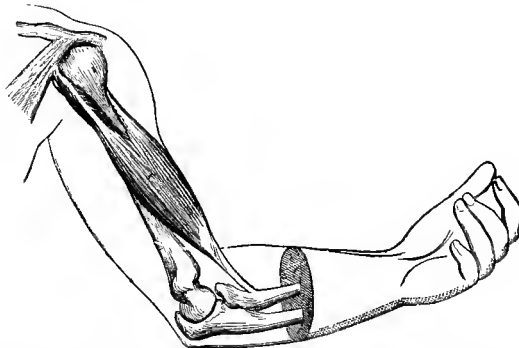

FIG. 288.—PARTIAL CONTRACTION OF BICEPS. (*Perrier.*)

arm of the lever may be defined as the perpendicular distance from the line in which the power acts to the fulcrum; the weight-arm, the perpendicular distance



from the line in which the weight acts to the fulcrum. The law of the lever may be expressed as follows: A power will support a weight as many times as great as itself as the power-arm is times longer than the weight-arm. Thus, for example, in a lever of the first class, if we suppose that the power-arm be ten times as long as the weight-arm, a weight of one pound at the extremity of the power-arm will support a weight of ten pounds at the extremity of the weight-arm. It must be recollected, however, in the case of the lever, as in every other machine, what is gained in



FIG. 289.—COMPLETE CONTRACTION OF BICEPS. (Perrier.)

power is lost in velocity, and *vice versa*. Thus, in the case of the third class of lever, power is exchanged for velocity. This may be well represented in the movement of flexion of the human forearm (Figs. 288 and 289). The fulcrum is there found in the elbow-joint, the power is the insertion of the biceps muscles in the bone of the forearm in front of the joint, the weight is carried by the hand. In this arrangement it is evident that slight motion at the insertion of the biceps will be greatly multiplied in the case of the hand. Thus, say that the distance from the elbow-joint to the tip of the hand is eighteen inches, the distance from the elbow-joint to the point of insertion of the biceps one inch, motion of one inch at the insertion of the biceps will produce motion at the hand of an arc of a circle whose cord is eighteen inches. The forearm is, therefore, in this action an example of the third class of lever.

In general, in the animal body, the point of application of the power developed by muscular contraction lies near the fulcrum: hence the conditions favor the production of velocity of movement at the expense of power, for the power-arm is always shorter than the weight-arm.

The conditions are, however, reversed in the case of the extensor muscles of the limbs when in contact with the ground. Here the joint nearest to which the muscle is inserted is the point of application of the weight, and the fulcrum is the

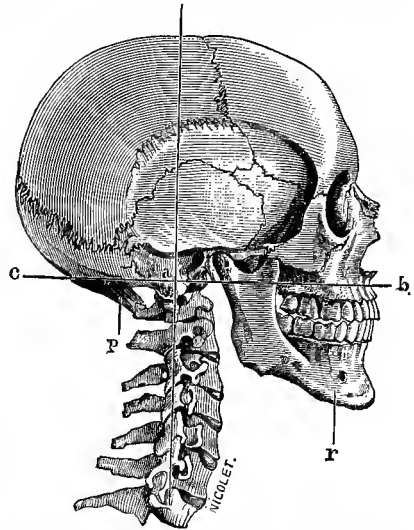

FIG. 290.—MOTION OF HEAD AS ILLUSTRATING ACTION OF LEVER OF FIRST CLASS. (Béclard.)

*a*, fulcrum of the lever, *c b*: *a b* is the weight-arm, for the head tends to fall forward by its own weight acting in the line, *r*. This is prevented by the contraction of the muscles of the back of the neck acting on the power-arm, *c a*, in the line, *p*.

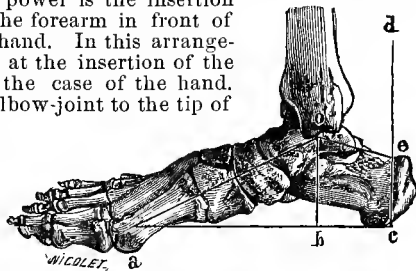

FIG. 291.—MOTION ILLUSTRATING ACTION OF LEVERS OF THE THIRD CLASS. (Béclard.)

The fulcrum is at *a*, the power from contraction of gastrocnemius muscle, acting in the line, *d e*, is applied at *c*, while the weight (of the body) acts in the line, *o b*. *a c* is thus the power arm, *a b* the weight-arm.

joint above, far from the insertion of the muscle. Hence, the power-arm is greatly increased. Thus, in the horse, while the foot is on the ground in the contraction of the extensors the point of application of the weight is in the hock-joint, the point of application of the power in the calcaneum, where the extensors are inserted, and the pastern-joint the fulcrum; hence the power-arm is long, and, although motion is slow, it is accompanied by a corresponding increase in power. If, however, the hind foot is not on the ground, but is extended as in kicking, then the fulcrum is in the hock-joint, and the power-arm is now short and power is exchanged for velocity.

The first class of levers may be represented in such movements as in nodding the head, where the fulcrum is the articular surface of the atlas, the weight being found in the back of the head when the throat muscles contract, in the front of the head when the posterior neck muscles contract (Fig. 290). Movement due to the action of levers of the second class is seen when the body is raised up on tiptoe by the muscles of the calf (Fig. 291).

All three orders of levers may come into play in the action of the human elbow-joint. Thus, the first class is illustrated when the forearm is extended on the arm through the contraction of the triceps muscles; in this instance, the hand is the weight, the elbow-joint the fulcrum, and the insertion of the triceps in the olecranon the power (see upper diagram Fig. 287).

If the hand rest on the table and the body be raised on it, then the hand is the fulcrum, the triceps is the power, and the humerus, at its articulation in the elbow-joint, the weight, thus illustrating the action of a lever of the second class (see middle diagram 287). The third order, as already mentioned, comes into play when the forearm is flexed on the arm.

In the horse the extensors of the forearm (*A D*, *B D*, and *C D*, Fig. 292) act as levers of the first class, the power-arm being the distance between the summit of the olecranon and the centre of the humero-radial articulation, which forms the fulcrum, while the weight-arm is represented by the length of the radius. In man the triceps brachialis (*B*, Fig. 293), which is the analogue of the olecranon muscles of quadrupeds, acts also as a lever of the first class, the power-arm, however, being much shorter in man. In the posterior extremity of the horse (Fig. 294), the gluteus medius, the fascia lata, the triceps cruralis, the bifemoro-calcaneus, the vastus externus, etc., are also examples of the first class of levers. In the case of the gluteus medius (*A B*, Fig. 294) the power-arm is the distance from the trochanter to the centre of the acetabular articulation, which is the fulcrum, while the weight-arm is the length of the femur. For the gastrocnemius the power-arm is the distance from the summit of the calcaneum to the centre of the hock-joint, which is the fulcrum, while the weight-arm is the length of the metatarsus. The first class of levers is thus mainly represented by the extensors.

Levers of the third class are mainly represented by the flexors. In the anterior extremity of the horse (Fig. 295) the infraspinatus, the biceps flexor, the metacarpal flexor, and the flexor pedis are all examples of muscles whose action operates through levers of the third class, in each instance the power acting between the fulcrum and the weight. In operations of levers of the third class power is exchanged for velocity of motion, from the fact that the power-arm is always shorter than the

weight-arm. In the posterior extremity of the horse (Fig. 296) the superficial gluteus muscle and the ischio-tibial muscles are levers of the third class.

Levers of the second class are more rarely met with. In the horse

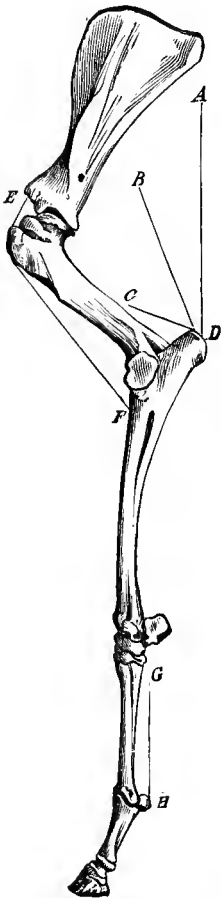

FIG. 292.—ANTERIOR EXTREMITY OF THE HORSE IN EXTENSION. (*Colin.*)  
*A D*, *B D*, and *C D*, lines of action of the triceps extensor brachii, scapulo-ulnaris, and aconeus muscles. *E F*, flexor brachii. *G H*, line of action of flexor pedis muscles.

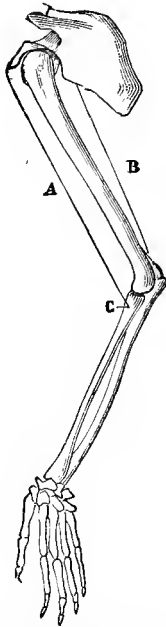

FIG. 293.—SUPERIOR EXTREMITY OF MAN. (*Colin.*)  
*A C*, line of action of the biceps flexor. *B*, triceps extensor.

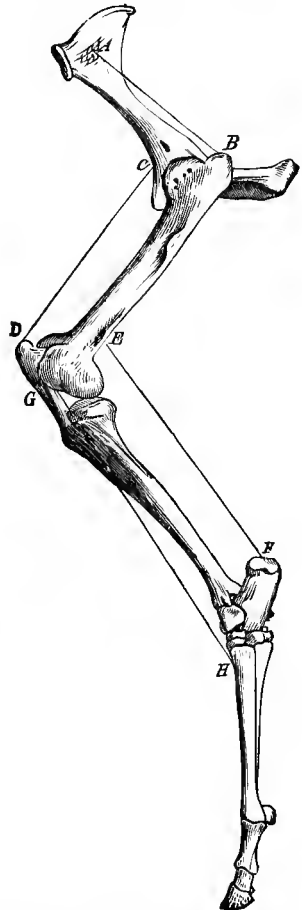

FIG. 294.—POSTERIOR EXTREMITY OF THE HORSE IN EXTENSION. (*Colin.*)  
*A B*, line of action of gluteus medius. *C D*, line of action of triceps extensor. *E F*, line of action of gastrocnemius. *G H*, line of action of metatarsal flexor.

the gastrocnemius acts through a lever of the second class when the foot is in contact with the ground. Then the fulcrum is at the point of contact of the foot with the ground, the power-arm is the distance from the calcaneum to the ground, the weight-arm the distance from the

astragalo-tibial articulation to the ground, and the resistance is the weight of the body. This mode of action of the gastrocnemius is more evident in man (Fig. 297) when the weight of the body is raised on the toes through the action of this muscle. In the anterior extremity of quadrupeds the extensors of the forearm (*A D*, *B D*, and *C D*, Fig. 292) also act through levers of the second class when the foot is on the ground,

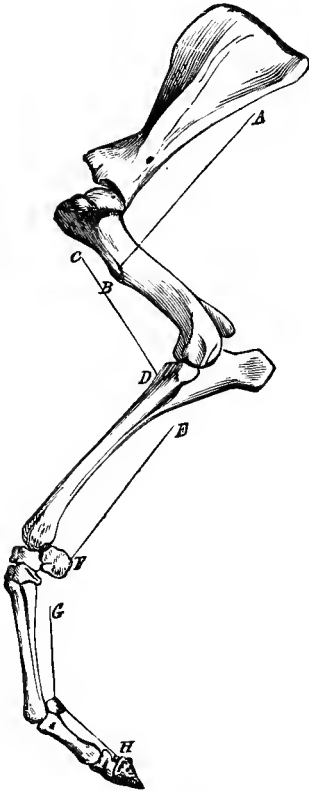

FIG. 295.—THE ANTERIOR EXTREMITY OF THE HORSE IN FLEXION. (*Colin.*)

*A B*, line of action of infraspinatus. *C D*, line of action of biceps flexor. *E F*, line of action of metacarpal flexor. *G H*, line of action of flexor pedis.

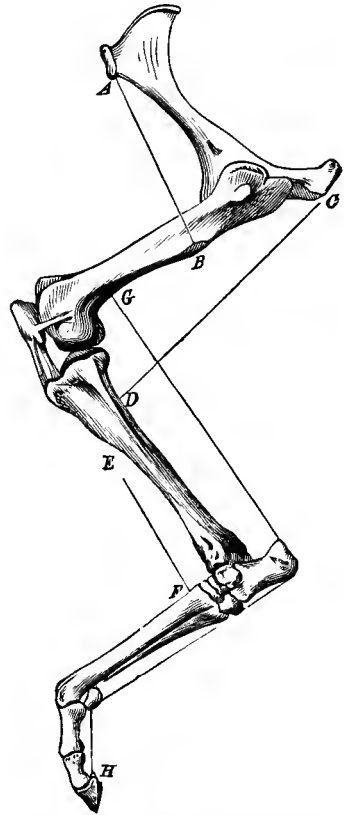

FIG. 296.—POSTERIOR EXTREMITY OF THE HORSE IN FLEXION. (*Colin.*)

*A B*, line of action of superficial gluteus muscle. *C D*, line of action of ischio-tibial muscles. *E F*, line of action of metatarsal flexor. *G H*, lines of action of flexors of foot.

their action serving then to flex the humero-radial articulation, instead of extending it, as occurs when they act with the foot in the air.

The movements of the different parts of the animal body depend upon the union of the different parts of the skeleton with each other and the mode of insertion of the muscles. The movable parts of the skeleton are designated as joints, the relative positions of the bones forming a

joint being determined by muscular action; for when by the action of muscular force the positions of the bones are changed, the original position is not regained in the cessation of that force.

The form of the joint, in which two bones are united end to end, is subject to considerable variation, depending on and governing the direction in which the movement may take place. The articular extremities of the bone are covered with articular cartilage, surrounded by closed serous sacs containing a serous fluid, the synovia, which tends to diminish friction between the movable parts. Since the space between articular surfaces contains only the synovial fluid, it may be regarded as a vacuum, and atmospheric pressure is itself sufficient to keep the articular surfaces in contact, even sustaining the entire weight of the limbs and thus sparing muscular action. The movement between the joint ends is not only governed by the character of the joint, which we will find may be resolved into several different types, but is further restricted by the capsular ligament which holds the joints in apposition and by the tendinous bands which surround them, in all cases only those movements being possible in which the articular surfaces remain in contact.

The articulations are divided into three classes: the immovable articulations, or the *synarthroses*; the mixed, or *amphiarthroses*; and the movable, or *diarthroses*.

To the first class belong the sutures and other articulations where the surfaces of the bones are in almost direct contact, not separated by a synovial cavity, and immovably connected with each other. In the second class the osseous surfaces are connected together by disks of fibro-cartilage, as between the bodies of the vertebræ, or the articulating surfaces are covered with fibro-cartilage, partly lined by synovial membrane, and bound together by external ligaments, as in the sacro-iliac and pubic symphyses.

The third class includes the greatest number of joints in the animal body, and as mobility is their distinguishing characteristic they are the

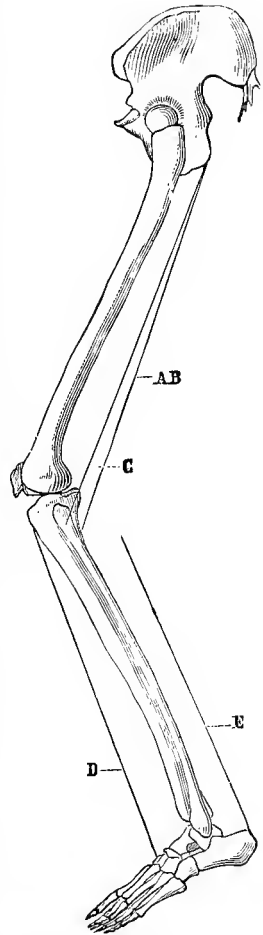

FIG. 297.—INFERIOR EXTREMITY OF MAN. (Colin.)  
*ABC*, line of action of biceps flexor.  
*D*, lever of third class. *E*, gastrocnemius.

only ones with which we are concerned. Four different varieties of this form of joint have been described, according to the kind of motion permitted in each.

*a. The Rotatory Joint, or Diarthrosis Rotatoria.*—In this class of joint the movement is limited to rotation, the joint being formed by a pivot-like process turning within a ring or the ring on the pivot, the ring being formed partly of bone and partly of ligament. The articulation of the atlas and the occiput is an example of such a joint. In the elbow-joint a similar rotatory articulation is met with, where in the radio-ulnar articulation the ring is formed by the lesser sigmoid cavity and the orbicular ligament while the head of the radius rotates within the ring. Only in animals in whom pronation and supination of the hand are possible does this movement occur; it is, therefore, absent in the horse and ox. In general, it may be said that in animals provided with the clavicle this motion of supination and pronation is usually present.

*b. The Ball and Socket Joint, or the Enarthrosis.*—In this joint motion in all directions is possible, and it is formed by the reception of the globular head of a long bone, into a deep, cup-like cavity, hence called ball and socket, the parts being kept in apposition by a capsular ligament and accessory ligamentous bands. The hip- and shoulder-joints are examples of this class.

*c. The Hinged or Ginglymous Joint.*—In this form motion is only possible in one plane and only in two directions, forward and backward, the articular surfaces being moulded to each other in such a way that a solid cylinder moves within a greater or lesser segment of a hollow cylinder. The joint between the ulna and the humerus is a most perfect example of a ginglymous joint, while the joints between the phalanges and between the inferior and superior maxillary bones of the carnivora are other examples. The pastern-joint of the horse is a modified form of this joint and is often spoken of as a screw-joint.

*d. The Gliding Joints, or the Arthrodia.*—In this class motion of a gliding character takes place. Such joints are formed by the approximation of plane surfaces, or one slightly concave, the other slightly convex, movement between them being limited by the ligaments or the osseous processes surrounding the articulation. Such articulations are seen between the vertebra, metatarsal and tarsal bones, and others.

The forces which move the joints are found in the contraction of striped muscular fibres. The extent of contraction for which the muscle is capable depends upon its length, and therefore we speak of long and short muscles. A muscle whose function it is to bring its points of origin and insertion nearer to each other must necessarily be a long muscle, while the muscles whose contraction only leads to slight change of place are usually short muscles. It will always be found that the

length of the muscle-fibre corresponds to the degree of movement which the muscle has to produce. It does not necessarily follow that a muscle whose points of origin and insertion are widely separated should be a long muscle, since the interval between these two points may be largely taken up by tendons.

3. ANIMAL LOCOMOTION.—The essential factor for animal locomotion consists in the movement of the centre of gravity of the body. By the term “the centre of gravity” is understood the point about which all the matter composing the body may be balanced. The attraction of gravity tends to draw every particle of matter downward in a vertical line. The factors of this force may be, therefore, regarded as the sum of an almost infinite number of parallel forces, each of which is acting upon one of the molecules of which that body is composed. Just as the resultant of the force exerted by two horses harnessed to a swingle-tree is equal to the sum of the forces exerted by the horses but applied at a single point at or near the centre of the swingle-tree, so, also, the sum of the forces of gravity may be regarded as acting upon a single point which is near the centre of gravity of that body. In other words, the weight of the body may be considered as concentrated at the centre of gravity. When the centre of gravity is supported the whole body will be in a state of equilibrium; or when the line of direction of the force of gravity, which is thus a vertical line passing through the centre of gravity, falls within the base of the body, or base on which the body stands, it is then said to be stable.

In all regular bodies the centre of gravity will coincide with the central point, while in irregular bodies it will be nearest to that part in which the greatest weight is concentrated. As the centre of gravity of the animal body is within the body it can be directly supported. The stability of the body will be greater the broader the base and the nearer the centre of gravity to the support. The animal body when standing is, however, only at best in a state of unstable equilibrium; for when slightly displaced from its position of equilibrium, it tends to fall still farther from that position, owing to the fact that the disturbance has lowered the centre of gravity, and equilibrium is not restored until it reaches its lowest possible point. An animal in a recumbent position is in a state of neutral equilibrium; when its position is changed it tends neither to return to its former position nor to fall farther from it. Stable equilibrium is when a body is so supported that when slightly displaced from its position of equilibrium it tends to return to that position. Such a condition can only occur when displacement raises the centre of gravity. The pendulum is an example of stable equilibrium.

Standing is thus a condition of unstable equilibrium in which the centre of gravity is supported from the fact that the line of direction

falls within the base of the figure. The mechanism of standing differs in bipeds and quadrupeds. In man the centre of gravity lies within the pelvis, about one and a half millimeters in front of the promontory of the sacrum. In the erect attitude of man the feet are directed outward (forming an angle of about fifty degrees), so increasing the base of support, the heels touching, the knees extended, the thighs rotated externally, and the pelvis and trunk bent slightly backward, the arms hanging at the side.

In the act of standing, the body not being rigid, balancing must be aided by the assistance of the contraction of various muscles. In a certain number of joints the action of ligaments in the erect position assists the maintenance of the upright posture; thus, in the attitude already described, where the knees are extended to the utmost, the trunk thrown back, and the head balanced, the anterior hip-ligaments are rendered tense, and the knee- and hip-joint remained fixed without any effort upon the part of the joint-muscles. In the position known as "standing at ease" the weight of the body rests mainly on one leg, the other forming simply a support to assist the muscles around the supporting ankle. In this position the joints are not kept locked by the tension of the ligaments, for the pelvis is now somewhat oblique, so as to bring it directly over the head of the femur. Varying tension in the muscles serves to preserve the balance and prevent fatigue. In the erect posture the ankle supports the weight of the body; the line of gravity falling slightly in front of the axis of rotation of the ankle-joint, the tendency is thus for the body to fall forward at the ankles; this is, however, checked by the calf-muscles, which keep the parts nearly in position of exact equilibrium. In the erect position, the ankle-joint being neither flexed nor extended to the utmost forward or backward, motion must be prevented by muscular contraction. Lateral motion at the ankle-joint is prevented by the malleoli. When the knee-joint is completely extended no muscular action is required to prevent it from bending, because the line of gravity then passes in front of the axis of rotation and the weight of the body tends to bend the knee backward. Although the ligaments which exert their contraction behind the axis of rotation tend to render this impossible, ordinarily the position is maintained by muscular action so exerted that the line of gravity passes slightly behind the axis of the knee, the tendency thus produced of the knee to bend being checked by the extensor muscles of the thigh.

In the hip-joint the line of gravity falls behind the line uniting the joint. When the person is erect, the tendency thus produced of the body to fall backward is prevented by the ileo-femoral ligament. If, however, the knee is not extended to the full extent the line of gravity passes a little behind the axis of rotation of that joint, and the pelvis



being slightly flexed on the femora, the axis of the joint lies a little behind the line of gravity, and the inclination thus produced to fall forward is prevented by the glutei muscles, which are likewise concerned in regaining the erect posture after bending the trunk forward. The motions between the pelvis and vertebræ are practically so slight as to be disregarded, and the vertebral column, with the exception of the motions existing between the head and the upper cervical vertebræ, may be regarded as a rigid column. Between the occiput and atlas lateral and rotatory motions are possible to a considerable extent, so that balancing the head is rendered possible only by co-ordinated muscular contractions, since no ligaments are present which can fix the occipito-atlantoid articulation.

Sitting is that position of equilibrium where the body is supported on the tubera ischii. The line of gravity may pass either in front of the tubera ischii, in which the body must be supported by some fixed object, or the line of gravity may fall behind the tubera in the backward posture, in which case falling backward may be prevented by leaning upon a support or by the counter-weight of the extended legs. In sitting erect the line of gravity falls between the tubera themselves, and but slight muscular action, such as is required in the balancing of the head, is sufficient to maintain equilibrium.

In quadrupeds the four limbs act like four columns, as in a chair or table, in supporting the centre of gravity of the body, so that the base of support is a parallelogram whose corners are represented by the point of contact of the feet with the ground, and which is about four times as long as it is broad. In consequence of the greater base of support, equilibrium is more readily preserved in quadrupeds than in bipeds. The centre of gravity in the large quadrupeds, such as the horse, ox, etc., lies at the intersection of a line passing vertically behind the xyphoid cartilage and one passing horizontally through the end of the second third of the sterno-vertebral diameter. In the small quadrupeds, such as the dog, the centre of gravity is located somewhat more anteriorly. From the fact that the centre of gravity lies below the vertebræ in quadrupeds, in the erect position the tendency of the weight at the centre of gravity is to curve the vertebral column inward. This is prevented by both muscular action and ligamentous support. The fore extremities and scapula are only attached to the trunk through muscular and ligamentous connections which are continually on a stretch and so serve to render the shoulder-blade immovable, while by means of the greater serrati muscles the trunk is supported as in a sling, so that it cannot be pushed forward against the shoulder-blade. In the posterior extremities the relationships differ in that the single bones are not, as in the fore extremities, vertically over each other. Here, also, the erect position is maintained through

muscular action. When the body is uniformly supported on all four extremities, in the fore limbs the line of direction passes from the shoulder through the centre of the elbow-joint in the axis of the forearm, through the centre of the knee-joint in the axis of the ulna, through the centre of the pastern-joint perpendicular to the ground behind the ball of the foot. Three principal angles are thus formed whose degree depends partly on the angle between the scapula and vertebræ and partly on the relative lengths of the different bones.

In the case of the anterior extremity the line of direction of the lower bones is almost vertical, but in the case of the upper bones becomes considerably inclined; thus, the scapulo-humeral angle tends constantly to become smaller and smaller on account of the depression of the superior extremity of the scapula and by the projection anteriorly of the scapulo-humeral articulation. This depression and projection are hindered by the action of numerous muscles. The most important muscle concerned in the fixation of the upper extremity is the serratus magnus, which, arising in numerous fan-shaped bundles from the five posterior cervical vertebræ and the first eight ribs, converges to be inserted in the ventral surface of the scapula. This muscle, with its fellow, serves as a muscular sling in which the body is supported between the fore limbs, the axis of motion of the shoulder-blade passing through its insertion in the scapula.

The superior extremity of the scapula is sustained by the rhomboid muscles, which draw it upward, as well as by the trapezius, which tend to elevate and advance this bone, so opposing the depression of the scapula through the weight of the trunk. These muscles thus give fixity to the scapula. Further, the anterior projection of the scapulo-humeral angle is prevented by the greater and lesser pectoral muscles, which by their contraction tend to retract this angle. The obliquity of the humerus tends to become exaggerated during standing as well as at each act of striking the foot upon the ground. The pectoralis major and the infra-spinalis muscles, as well as the coraco-radial, tend to prevent this, the latter muscle being especially efficacious, acting not only as a muscle, but a band of unyielding tendinous material running through it enables it to act as a ligament preventing exaggerated flexion of the humerus on the shoulder. That the coraco-radial should fulfill this function it is necessary that its insertion in the inferior extremity should be fixed. This fixity is accomplished by the five olecranon muscles. At the elbow-joint the lower end of the humerus is fixed by the strong lateral ligaments; reduction of the elbow angle being prevented by the fixation of the olecranon through the contraction of the extensors of the forearm, and anterior deviation by the tendinous expansion of the long flexor of the forearm, its tension increasing with the weight on the shoulder.

Below the humerus the bones lie, with the exception of the phalanges, in an almost vertical line, flexion being prevented by the five extensors of the forearm. The metacarpus continues the vertical column of which the forearm forms the superior segment, its flexion being prevented by

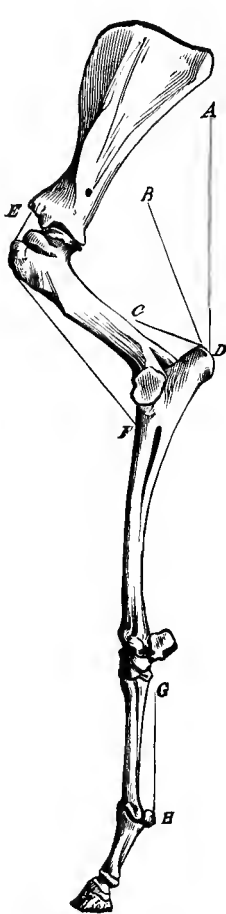

FIG. 298.—ANTERIOR EXTREMITY OF THE HORSE IN EXTENSION. (*Colin.*)  
*A D, B D, and C D,* lines of action of the triceps extensor brachii, scapulo-ulnaris, and aconeus muscles. *E F,* flexor brachii. *G H,* line of action of flexor pedis muscles.

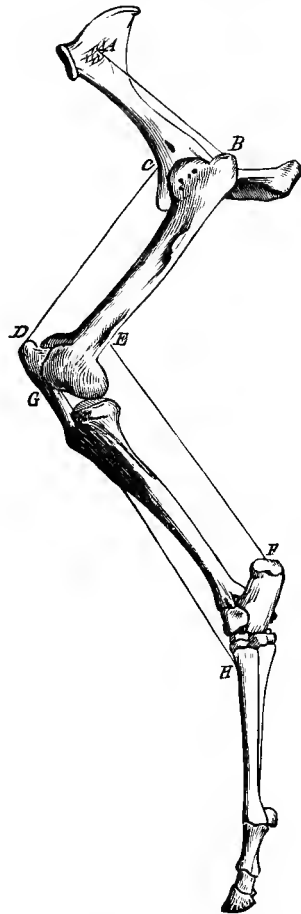

FIG. 299.—POSTERIOR EXTREMITY OF THE HORSE IN EXTENSION. (*Colin.*)  
*A B,* line of action of gluteus medius. *C D,* line of action of triceps extensor. *E F,* line of action of gastrocnemius. *G H,* line of action of metatarsal flexor.

the extensor inserted in its carpal extremity, and which receives in about the middle of its fleshy belly an aponeurotic cord fixed superiorly to the external tuberosity of the humerus. In the phalangeal region the direction of the bony support now becomes oblique, and, while its obliquity

constantly tends to become exaggerated by the weight which the upper extremity supports, it never passes certain limits on account of the presence of the spiral ligament of the pastern-joint. Without this ligamentous support muscular action would be insufficient to prevent extreme flexion, but by means of the ligament, which in the horse and ruminant is composed of powerful non-elastic tendinous fibres, represented in the carnivora by muscular fibre, the support of the body is rendered possible without fatigue.

In the case of the posterior limbs great deviation from the vertical is met with, and that their obliquity should be restrained within certain limits considerable muscular effort is required and the mechanical dispositions of the power is more complex (Fig. 298) than in the case of the thoracic members. In the hind leg four angles are met with, viz.: in the hip-joint, the knee-joint, the hock-joint, and the pastern-joint, the degree of these angles being governed by the angle which the axis of the femur makes with the vertebræ and the position in which the hind foot is placed. In the resting position of the hind extremity the line of direction of the body weight passes from the centre of the hip-joint vertically downward to the centre of the hock-joint, and then, deviating about  $10^{\circ}$  from the direction of the metatarsus, passes behind the pastern-joint to the ground. The pelvis is very oblique relatively to the trunk in the horse, ox, and most ruminants and carnivora. The femur is obliquely connected with the pelvis, downward motion of the pelvis and backward motion of the femur from the body weight being prevented by the abdominal recti muscles, whose tendons, being inserted in the pelvis, by their tension tend to draw the hip-joint anteriorly. The gluteal muscles, arising from the ilium and passing over the hip-joint to the femur, act in the same direction, not only preventing forcing backward of the hip-joint, but in its contraction pressing the hip-joint forward. The leg is, like the femur, flexed, its obliquity being limited by the tension of the tendons of the extensor muscles, which pass over the anterior surface of the knee-joint, by the ligaments of the knee-joint, and by the tibio-tarsal muscle, which in the solipedes throughout its entire length consists of a strong aponeurotic band, thus being analogous in its action to the coracoradial muscle of the anterior extremity. The flexion of the metatarsus on the leg is limited especially by the gastrocnemius muscles and by the superficial flexor of the phalanges, which in the suspensory ligament becomes reduced to a cylindrical cord and flattened out at its passage over the summit of the calcaneum. The inclination of the phalanges on the metatarsus is prevented by a ligamentous suspensory apparatus similar to that of the anterior extremity.

From the above it is seen that the extremities in standing support the body only by muscular effort, principally that of the extensors.

Although the flexors participate in many joints, as an example of which it is only necessary to mention the coraco-radial, which, as already stated, offers resistance to the flexion of the arm on the forearm, this action is only rendered possible when the radius is fixed by the olecranon muscles. The support of the head in standing in the case of quadrupeds is accomplished mainly by the ligamentum nuchæ, which, originating in the spinous processes of the dorsal vertebræ, terminates in the occipital protuberance, being connected at the same time with all the cervical vertebræ.

While standing quietly the weight of the horse is supported by both of the fore legs and only one hind leg, the other hind leg being flexed and only the tip of the toe touching the ground. By this means the muscles of the posterior extremity which are concerned in the act of standing are enabled to rest, the weight being borne alternately at varying intervals by the opposite hind legs. From the fact that the centre of gravity in quadrupeds lies nearer to the anterior than the posterior extremities, the fore limbs sustain the greater part of the weight of the body. In riding two-thirds of the weight of the rider are borne by the anterior extremities and one-third by the posterior.

In every form of animal locomotion the position of the centre of gravity of the body in space is changed, inertia tending to continue the motion inaugurated by the muscular contraction until friction, resistance of the atmosphere, or opposed muscular action arrests it.

In man, movements of locomotion are much simpler than in quadrupeds, and will, therefore, be first analyzed. The movements in man consist in walking, running, and jumping. In the act of walking in man, by the alternate action of each leg the centre of gravity is advanced so that at each step there is a moment in which the body rests vertically on the foot of one leg (say the right), while the other (the left) is inclined obliquely behind with the heel raised and the toe resting on the ground. Then the latter, slightly flexed to avoid touching the ground, is swung forward like a pendulum, and the toe of the moving leg (the left) then brought to the ground. On this point, as a fulcrum, the body is moved forward by a propulsive act of the supporting leg (the right), the centre of gravity becoming thus advanced until it lies vertically over the leg (the left) which has last touched the ground. The body then rests vertically on the left foot, the right now being directed obliquely backward. The propulsive movement of the active leg, the one concerned in pushing the body off the ground, gives sufficient impetus to the centre of gravity to carry it by inertia beyond the vertical line on the passive or supporting leg, so that this movement from inertia assists in swinging forward the active leg until it advances a step beyond the passive supporting leg (Fig. 299). Hence, after the act of walking is once started, inertia is largely instrumental in maintaining the motion, and but slight

muscular exertion is required in walking on level ground. In ascending an incline, however, the active limb has at each step to clevate the weight of the body by extending the knee- and ankle-joint by the thigh-extensors and calf-muscles, therefore greatly increasing the muscular power required. During walking the trunk leans toward the active leg, owing to the contraction of the glutei muscles and the tensor fascia lata, and is inclined slightly forward to overcome the resistance of the air. The more anteriorly the trunk is advanced the more the centre of gravity of the body tends to lie in the line of the active leg, and, consequently, the stronger is the forward propulsion of the body. Hence, in rapid walking the body is more bent forward than in slow walking. During the advancing of the passive leg the trunk rotates on the head of the active femur and is compensated by the arm of the side of the oscillating leg

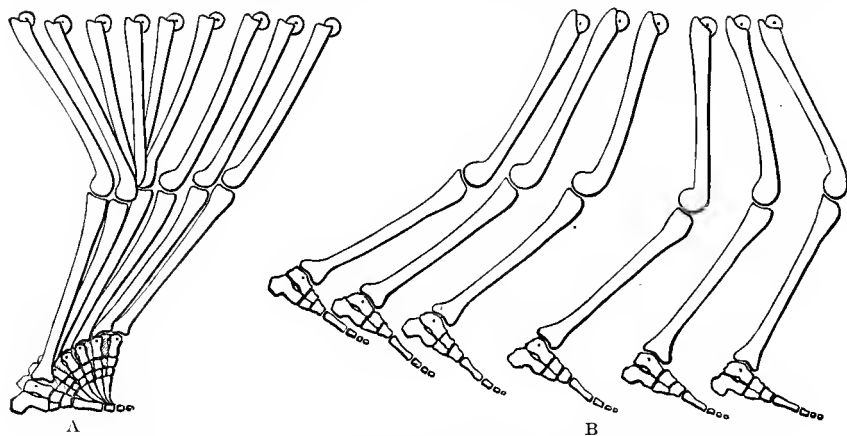

FIG. 300.—THE DIFFERENT POSITIONS OF THE LEGS OF MAN IN WALKING, AFTER WEBER.

A, the propelling leg; B, the "pendulum" leg.

swinging in the opposite direction, while that on the other side swings in the same direction as the oscillating leg.

Running is distinguished from walking by the fact that at a certain moment the body is raised in the air, neither leg touching the ground. In walking, on the other hand, both feet rest on the ground for the greater part of the step. In running the active leg, as it is forcibly extended from a flexed position, gives the body the necessary impetus, the active leg leaving the ground before the swinging foot has reached the ground. There is thus an interval during which both feet are off the ground, and as each foot comes to the ground it executes a new swing without waiting for the pendulous swing which occurs in walking.

In jumping the propulsion of the body takes place from both feet

simultaneously. A running jump may be made higher or broader than a standing jump from the additional impetus acquired through inertia.

4. THE GAITS OF THE HORSE.—Although the acts of locomotion in quadrupeds are much more complicated than in man, they may be all reduced to variations of three main types—the walk, the trot, and the gallop.\* Since in quadrupeds the centre of gravity lies in front of the centre of the trunk, it can only be advanced by power acting from the hind extremities, the fore legs being concerned simply in supporting the trunk. In the horse the posterior extremities are especially fitted for this act by the angular character of their joints, so that in the action of the extensor muscles the hind legs become considerably longer, and the foot remaining in contact with the ground, through the contraction of the extensors the result must be to advance the upper extremity of the leg forward; and the greater the angles of the posterior extremity, the farther the trunk will be advanced in the straightening of the hind leg. The extremity, which in the commencement of the extension of the hind leg was behind, will now be advanced so as to support the trunk, exactly as has been found to be the case with the swinging leg of the walking man, which, immediately after the impulse of the active leg, swings forward, and then on its part assumes the rôle of the propulsive leg, while the previously active leg now becomes passive. The force of the shock communicated to the trunk by the hind legs will be somewhat diminished by the oblique insertions of the extremities and by the angles between the single bones of the hind leg, while in the fore extremities the shock of the foot striking the ground will be diminished by the soft parts, muscles and fascia, which connect the shoulder-blade to the trunk.

Before taking up the consideration of the different gaits of the horse the characters and mode of production of the different movements in the individual limbs first deserve attention, taking up, first, the movements of the fore leg and then of the hind leg:—

The animal being supposed to be in the erect position, before movement of the fore leg takes place the body weight is first shifted, through the contraction of the pectoral muscles, aided by the latissimus dorsi, to the opposite extremity. The shoulder being elevated by the rhomboid and trapezius muscles, flexion commences with the contraction of the levator humeri, approximating the humerus to the scapula and diminishing the shoulder angle. The principal reduction in the length of the

\*In the account of the different movements in the gaits of the horse the author has mainly followed the analysis published by Brüchmüller, "Lehrbuch der Physiologie," *Oesterreicher Vierteljahresschrift für Veterinärkunde*, liii, 1880, pp. 97-120, based on instantaneous photography. Acknowledgment is also due to Colin, "Traité de Physiologie Comparée;" Munk, "Physiologie des Menschen und der Säugethiere;" Boehm, *Archiv für Wissenschaftliche und Praktische Thierheilkunde*, Bd. xiii and xiv; and Schmidt-Mülheim, "Physiologie der Haussäugethiere."

axis of the fore leg occurs through the flexion of the knee-joint, which is elevated and advanced by the action of the coraco-radial and humero-radial muscles; then by the action of the flexors of the carpus and digit the fetlock and pastern-joints are flexed.

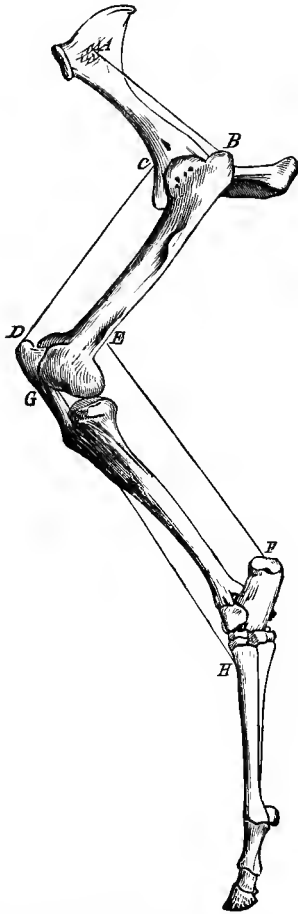

FIG. 301.—POSTERIOR EXTREMITY OF THE HORSE IN EXTENSION. (*Colin*).

*A B*, line of action of gluteus medius. *C D*, line of action of triceps extensor. *E F*, line of action of gastrocnemius. *G H*, line of action of metatarsal flexor.

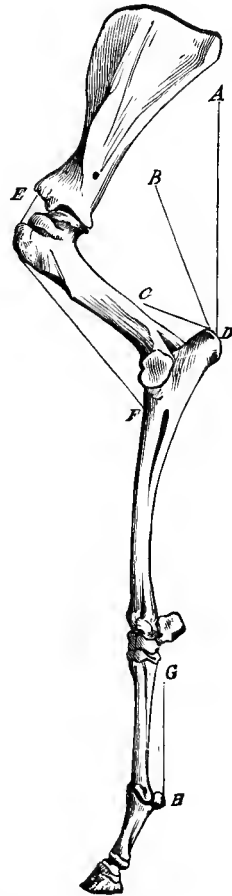

FIG. 302.—ANTERIOR EXTREMITY OF THE HORSE IN EXTENSION. (*Colin*).

*A D*, *B D*, and *C D*, lines of action of the triceps extensor brachii, scapulo-ulnaris, and aconeus muscles. *E F*, flexor brachii. *G H*, line of action of flexor pedis muscles.

Extension of the fore leg is the reverse of the preceding motions and serves to open out the angles reduced in flexion and so increase the length of the axis of the limb. Extension is still further the reverse of flexion in that the motion commences in the pastern-joint, instead of in



the shoulder, through the action of the extensor pedis, which, with the metacarpal extensors, converts the angle of the pastern-joints into a straight line, the axis of the phalanges forming an angle anteriorly with the axis of the metacarpus. Simultaneously with this movement the knee becomes extended, the axis of the metacarpus forming a straight line with that of the radius, this movement also being accomplished by the contraction of the metacarpal extensors. Finally, the forearm returns to its extended position in a line with the upper arm, partly through the action of the ligaments of the elbow-joint and partly from the contraction of the five olecranon muscles. During this forward motion of the foot in extension the humerus leaves its position of flexion, and the foot striking the ground, the fore limb again becomes vertical, and by the action of the pectoral latissimus dorsi muscles the body weight is again transferred to it. The lever motion of the muscles producing these movements is seen in Figs. 301 and 302. Instead, however, of the simple motions of flexion and extension above described, which occur when one forefoot is simply raised from the ground and again returned to the same spot, the flexed forearm and carpus may be carried beyond the vertical line through the extension of the humerus by the contraction of the various extensors, aided by the abductors of the humerus, while at the same time the posterior angle of the scapula is drawn backward and downward by the contraction of the rhomboid and trapezius muscles. At first, in the forward motion of the lower end of the humerus flexion is increased, but the farther it advances forward and the more the scapula rotates backward the more the shoulder angle becomes opened, and, under the action of the adductors of the humerus, directed outward and upward, so that the extensors of the lower joints are put on the stretch and their contraction converts the flexion of the limb into extension, the fore leg thus describing a pendulum-like motion, and in its extended position is directed forward and downward and strikes the ground in front of its previous position (Fig. 303). Then, from the impulse communicated to the trunk from the hind legs, the weight of the body is gradually transferred to the fore leg, which, the foot remaining on the ground, gradually becomes more and more vertical from the forward motion on it of the trunk (Fig. 304). As, however, the inertia of the moving body carries the shoulder beyond the vertical, the axis of the fore limb is then directed downward and backward, the assumption of this position being aided by the forward rotation of the scapula, while the extensors of the forearm (the foot being fixed on the ground) not only sustain the elbow- and shoulder-joints, but, by their contractions, give an additional forward impetus to the body. The extreme extended position of the limb puts the flexors of the lower joints on the stretch and so leads to their contraction, and

the limb, passing now into flexion, again describes its forward pendulum motion, the point of support of the scapula being the centre of rotation, while the hoof describes an arc of a circle. On the other hand, while

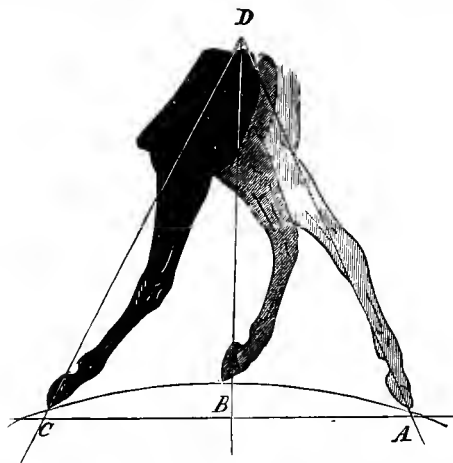

FIG. 303.—OSCILLATION OF THE FLEXED FORE LEG. (*Colin.*)  
The hoof describes an arc of a circle,  $C B A$ , the cord,  $C A$ , being a measure of the extent of oscillation.

the foot is on the ground the shoulder describes the arc of a circle and the centre of rotation is in the foot. The combination of these two movements in both fore legs is seen in Fig. 305.

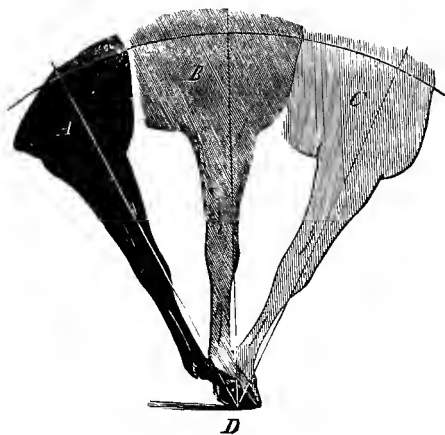

FIG. 304.—OSCILLATION OF THE EXTENDED FORE LEG. (*Colin.*)  
The foot being on the ground at  $D$ , the shoulder describes an arc of a circle,  $A B C$ .

In the case of the hind leg flexion likewise results in a shortening of the axis of the leg and the reduction of the angles between the different bones. The weight being thrown on the opposite extremity by

the contraction of the adductors, the femur is approached to the ilium by the contraction of the rectus and lumbar and iliac psoas muscles, the knee being elevated anteriorly by the ischio-tibial muscle and the hock-joint flexed by the contraction of the metatarsal flexor, whose tendinous portion, when the stifle-joint is flexed, becomes tensed and mechanically repeats the action on the joint below, the digital region being flexed on the metatarsus. As a consequence of these flexions, produced almost simultaneously, the axis of the limb becomes shorter, is raised from the ground, and advanced in a more or less oblique line. That the foot may again be placed on the ground the above muscles must relax and their antagonists contract. First the femur is extended on the pelvis by the action of the gluteus maximus, whose principal trochanteric branch acts as a lever of the first class. The leg is then extended on the thigh by

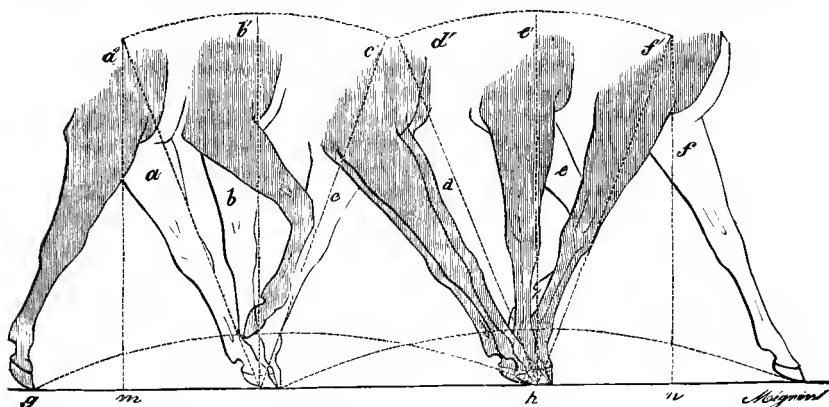

FIG. 305.—OSCILLATION OF THE ANTERIOR EXTREMITIES. (Colin.)

The figure shows that while one fore leg is describing the pendulum motion the other is acting as a support, while the right fore foot describes the arc,  $gh$ , the left shoulder describes the arc,  $alhl'$ , from the impulse given to the centre of gravity of the body through the extension of the hind legs. Then the right shoulder describes the arc,  $al'cl'$ . The six positions of the left leg in one complete step are shown at  $abcde$ , the centre of gravity having been advanced from  $m$  to  $n$ .

the rotuleus muscles, the metatarsus in its turn regaining its position on extension through the contraction of the gastrocnemius, the digital region being extended by the phalangeal extensors. The lever action of the muscles which produce these motions is seen in Figs. 249 and 251.

In movements of progression each hind limb alternately serves to give an impetus to the body by passing into a condition of extreme extension, the foot being on the ground, and then, passing into a condition of flexion, describes a pendulum motion through the air until the foot again strikes the ground in front of the position which it left. The pendulum motion commences with flexion of the hip-joint and forward motion of the lower end of the femur followed by flexion of the other joints. The greater the advance of the knee the greater the tension of the extensors, until the limb becomes extended and its increased length brings

the foot to the ground, the axis of the limb being now directed obliquely downward and forward. The body weight is then shifted to this limb through the action of the adductors, the limb again passing into a more or less marked position of flexion. The eroup muscles then contracting, the pelvis is advanced, assisted by the extensors of the femur, which find a fixed point in the knee, while at the same time the gastrocnemius muscle, contracting, opens the angle of the hock-joint and elevates the pelvis from the increase in the length of the axis of the limb. Through these motions the line of the hind leg gradually becomes vertical, passes the perpendicular, and is then directed downward and backward from the advance communicated to the body (Fig. 306). When the highest

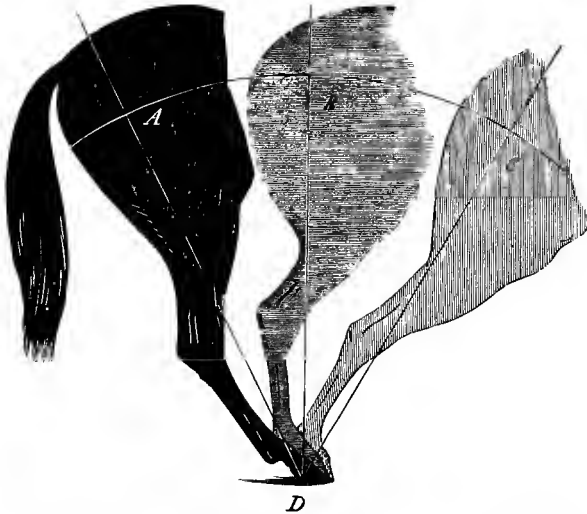

FIG. 306.—OSCILLATION OF THE EXTENDED HIND LEG. (*Colin.*)

The foot being on the ground at D, the hip-joint describes an arc of a circle, A B C, the lines A D, B D, and C D representing the changing axis of the hind leg.

degree of extension is reached the weight is shifted to the opposite limb, and after complete flexion the pendulum motion is repeated.

In these motions the hind leg does not move in the plane of the line of direction; in rapid movement the knee and tip of the foot are somewhat everted through the action of the iliaeus muscle until the foot strikes the ground. In slow motions, on the other hand, especially when bearing heavy weights, the knee is directed inward from the action of the adductors and tension of the femoral fascia, while the hock is everted, thus turning the toe toward the median line.

(a) *The Walk.*—In *walking* the body is supported by two legs while the other two are describing the pendulum motion, the support being alternately on diagonal feet and then on the two feet of the same side;

but as the impulse of the supporting feet is not simultaneously produced, four strokes of the hoof are heard with each step, but at unequal intervals; for when the support comes from the two feet on the same side the preservation of equilibrium compels a more rapid shifting of the body weight to the opposite side than when the diagonal limbs are in action.

If we commence the consideration of the act of walking in quadrupeds at the moment in which the one hind leg after completing its pendulum motion comes again to the ground, then it occupies a position in which the axis of the limb is directed from behind forward and from above downward. The centre of gravity in consequence of the propulsive movement advances, the leg and trunk describe an arc of a circle around the foot as a centre, so that the axis of the leg gradually becomes vertical and then advances, and the axis now tends to become

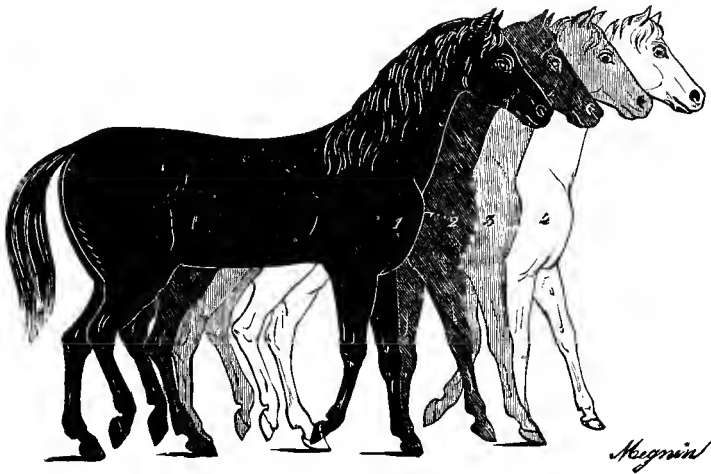

FIG. 307.—THE WALK. (Colin.)

directed from before backward and from above downward. At this moment active contraction of the extensor muscles occurs and the leg which was the supporting member now becomes an active propulsive member. It leaves the ground, becomes flexed, and swings forward, the femoral articulation now being the centre of movement and the foot describing an arc of a circle until it becomes advanced in front of its point of support. It then strikes the ground and the movements are repeated (Fig. 307). At the moment when the hind leg is thus swinging forward the fore leg of the opposite side is likewise advanced, the movement commencing as soon as the propulsive hind leg is in a vertical line. Through the forward movement of the trunk the line of

direction of the fore extremity becomes changed, so that instead of being vertical it is directed from above downward and from before backward. The foot must, therefore, be raised from the ground and advanced in the direction in which the trunk is moving, and, striking the ground, again becomes vertical at the moment when the pendulous hind leg strikes the ground. At the moment, then, when the fore leg becomes vertical, the propulsive movement in the opposite hind leg occurs. Then the motion commences in the opposite hind leg and fore leg, the alternation of the limbs being perfectly regular. Thus, suppose the right hind foot to be the propulsive foot, the left fore foot is extended on the ground, the left hind leg is swinging forward, and the right fore foot is just leaving the ground, the body thus being supported on a diagonal pair of feet. Then the right hind foot leaves the ground, the left fore foot is on the ground, the limb having passed the vertical line, the left hind leg is giving the impulse to the body, while the right fore foot is swinging forward. The body is then supported on unilateral feet, the support being of shorter duration than in the first case. Hence, in walking, there is always at any one time an anterior and a posterior limb in the air and an anterior and posterior limb acting as a support, the limbs being raised and replaced in such an order that of the two limbs in the air one is always in advance the half of its course over the other, while of the supporting limbs in one the line of the support is vertical when the other first reaches the ground.

In quadrupeds the length of the step is measured by the distance between the track formed by each separate foot, so that it is, therefore, twice as extensive as in man. When the hind feet reach the foot-prints of the fore feet it is twice as long as the base of support, *i.e.*, the distance between the pairs of feet at rest. As the motion in walking in quadrupeds is produced by the action of the diagonal extremities, the centre of gravity is first moved to one side and then returned to the centre and then cast to the opposite side. The duration of the step is dependent upon the duration of the swinging of the leg. The higher an animal raises its leg, the shorter is the pendulum and the more rapidly it swings.

The rapidity of motion in the walk in the horse varies from one to two meters in the second. In drawing heavy weights or in a very slow walk the relative movement of the feet is somewhat different from that detailed above. Then the elevation of each foot is delayed until the supporting feet are firmly on the ground; the body is then always supported on three limbs, by which equilibrium is better preserved. The same sequence of movement is, however, preserved.

(b) *The Amble*.—The amble is a modification of the walk, and is seen in the dromedary, giraffe, and occasionally in ruminants, and more

seldom still in the horse. It is characterized by the fact that the elevation of the second leg on the same side occurs sooner than in the walk.

The walk merges into the amble when, the body being supported by the two legs on the same side, the two opposite legs are elevated simultaneously instead of separately, as in the walk (Fig. 308).

In the walk the fore leg is always one-half the extent of its movement behind the hind leg on the same side, while in the amble both legs on one side move together, so that, therefore, there is a regular change between the feet on each side of the body. Consequently, in the amble the centre of gravity is first shifted to the one side and then to the other, the length of the step in the amble and walk being the same. But from the fact that the supporting limbs are on the same side of the body, to preserve equilibrium the movements must be more rapidly performed

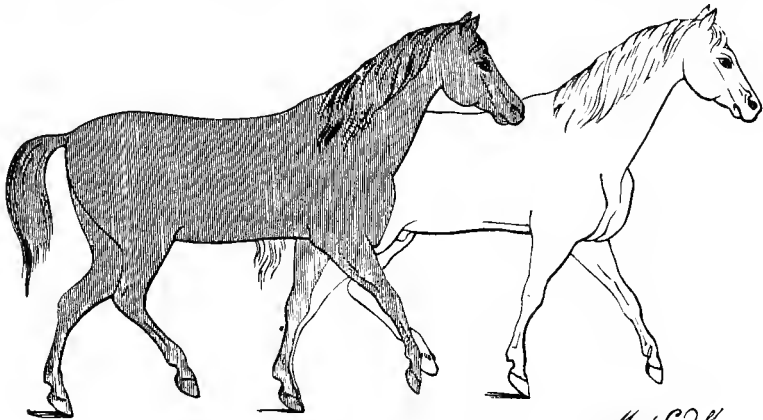

FIG. 308.—THE AMBLE. (Colin.)

than in the walk. The gait is, therefore, a faster one, the greater rapidity of the pace being accomplished by the reduction of the time, which corresponds to the half of the duration of the movement of one leg, since on each side one-fourth of the time is saved. The rate of movement in pacing may approach that of the trot, the velocity often rising to three meters per second. Since the two unilateral propulsive and the two swinging feet always move together, and are always at one time in the same phase of motion, the swinging feet strike the ground together, so that after one pace but two strokes of the feet have been heard.

In the rack, which is simply a modification of pacing, the unilateral feet act together, but the hind leg in propulsion is somewhat later than the fore foot of the same side in leaving the ground. Four strokes of the feet are heard in this gait, two rapidly following sounds when the feet of one side strike the ground, separated by a longer interval

from the two rapid sounds when the feet of the opposite side strike the ground.

It has been seen that in the movement of locomotion in man there are two periods of time in which both feet are on the ground and only one interval in which only one foot is in contact with the earth. In running, on the other hand, there is a moment in which one of the legs is raised up while the other is still performing the pendulum motion, and, consequently, both legs are at one time in the air. This interval is, however, much shorter than that in which both feet are on the ground.

(c) *The Trot*.—The form of locomotion seen in the horse and more seldom in the ox and other quadrupeds which corresponds to the act of running in man is termed the *trot*, in which the fore leg completes its movement with the diagonal hind leg; so that in the trot the diagonal feet and hind limbs at the same moment leave the ground and at the same

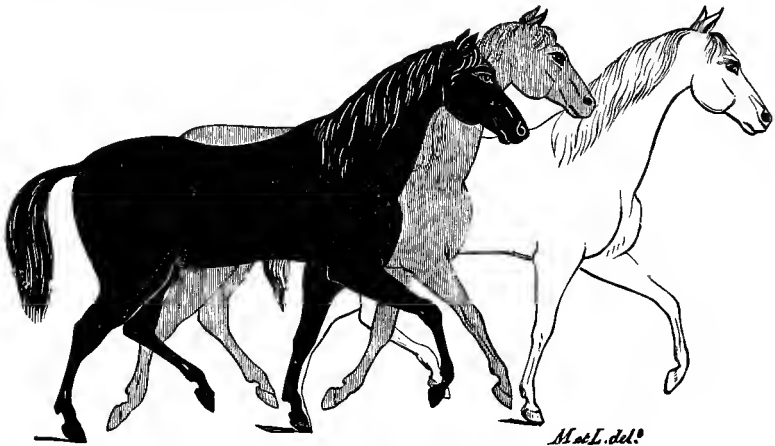

FIG. 309.—THE TROT. (Collin.)

moment again reach it. Therefore, in the trot two strokes of the feet on the ground are heard at each step. In the fast trot an interval occurs between this double stroke of the feet against the ground in which the body is moving through the air with all four feet raised from the ground. This interval is variable, usually being about half the time that the feet are in contact with the ground.

In the trot the impulse is communicated to the pelvis from each hind leg alternately, so tending to strain the articulation between the sacrum and vertebrae. This is, however, reduced to a minimum by the contraction of the ilio-spinalis of the opposite side.

In a very fast trot the second pair of feet leave the ground as soon as the first pair have reached the vertical position. Each step in the trot is twice as long as the step in the walk, in rapid trotting the hind feet



striking the ground considerably in front of the track of the fore feet and the velocity of motion rising to from eight to twelve meters per second. The walk turns into the trot when, the body being supported on two diagonal feet, the opposite hind foot rapidly leaves the ground and swings forward so that it strikes the ground simultaneously with the diagonal fore foot, or by one hind foot, as soon as it strikes the ground, rapidly passing into extension simultaneously with the diagonal fore foot.

(d) *The Gallop*.—The more the long axis of the body coincides with the axis of the propelling hind legs, the greater is the propulsive power of the legs. The angle between the hind legs and the body may be increased by elevation by means of the fore legs, and in the act of galloping the fore legs are raised up, while the main propulsive power comes from the hind legs, so that the gallop is a series of jumps. According to the rapidity of the gallop or run of quadrupeds, four strokes of the feet on the ground are heard in a slow gait or canter, three in the ordinary run, and two in running at full speed. Ordinarily, the legs of the two sides of the body do not act simultaneously, and, according as the right or the left hind leg is extended farthest behind, one speaks of a right- or a left-handed gallop. Thus, in the right-handed run, the left hind leg, stretched far under the body, first in its extension gives the impulse to the body, the right hind leg at this moment swinging forward to add the impulse of its extension a moment later, while both fore feet are off the ground, swinging forward, the left being the farthest advanced in commencing extension, while the right fore leg is still flexed. Then, while the left hind leg is still on the ground, though extended far behind the body, the right hind leg strikes the ground and adds its impulse in extension, while the extended left fore foot approaches the ground and the swinging right fore foot passes into extension. Then the left fore foot, reaching the ground, acts as a support on which the weight of the body is sustained, both hind legs being extended behind the body, the left being farthest extended, while the extended right fore foot is just about to touch the ground. Finally, the right fore leg reaches the ground and receives the weight of the body, while flexion commences in the left fore leg, both hind legs being now flexed under the body, the left hind foot being somewhat the farthest advanced.

At this moment the left fore foot is raised and the right fore leg, which alone sustains the weight of the body, leaves the ground after having passed the vertical, the body being then entirely free from all support, the fore legs flexed, and the hind legs drawn under the body, the left first reaching the ground.

Thus, there is a moment in which, alternately, each limb alone sustains the weight of the body, and a moment in which both hind legs are

propelling the body, and one in which both fore legs are supporting it. In the analysis of the movements of the limbs in the run the greatest confusion has existed as to the functions of the fore limbs; this has now, thanks to instantaneous photography, been cleared up. In the first place, it is seen that at one time the body is entirely clear from the ground, and that the weight of the body is not received on one or both of the fore legs, but on one hind leg, advanced under the body so that the foot is nearly under the centre of gravity. In the second place, the fore legs do not serve merely as "props or stilts" for the support of the body in motion, but are themselves also propelling organs. At first sight this might seem impossible, for the insertion of the fore limbs, acting on the body at rest, and being inserted in front of the centre of gravity, could not advance, but only elevate it, as in rearing. In the running animal, however, the propulsion from the hind legs advances the centre of gravity, but at the same time tends to lower it, and if the fore feet were immovable, the animal would tend to fall forward on its head. This is prevented by the shifting of the fore feet, while at the same time a distinct upward impulse is communicated to the centre of gravity. This may be seen in Mr. Muybridge's photographs, where there is a distinct elevation of the body at each time the fore legs leave the ground. The centre of gravity of the body is thus acted on by two forces, one from the hind legs tending to advance and lower it, the other from the fore legs tending to elevate it; the resultant of these two forces will evidently be a diagonal between the two; and the upward lift from the fore feet will more than compensate the downward tendency, and the body will be lifted and advanced.

In this gait but two strokes of the feet are heard, the first produced by the contact of the left hind leg, lengthened by the fall of the right hind foot, the second by the contact of the left fore foot with the ground, lengthened by the fall of the right fore foot. The interval between the first and second sounds is very short, that between the second and first, while the hind legs are swinging through the air, somewhat longer. The length of the strides in the full run may amount to six or seven meters, and a velocity of nearly fifteen meters per second be attained.

In a slower run or gallop three strokes of the feet are heard, the body, as in the trot, being supported on the diagonal limbs. The difference of this gait from the trot consists in the fact that in the latter the support on the diagonal limbs is equally prolonged, while in the gallop the support on one pair is longer than on the other. A conception of this gait is obtained if it is imagined that one pair of feet are acting as in the trot, the other as in the movement of jumping.

1. In this gait, when right-handed, the left hind leg is extended on

the ground and gives the forward impetus to the body; the right hind leg and left fore-leg are swinging forward, while the flexed right fore leg is being advanced. 2. The right hind foot and left fore foot then strike the ground and receive the weight of the body; the left hind leg is extended behind the body and about to leave the ground, while the fully extended right fore leg is advanced. 3. Then the right fore leg reaches the ground and sustains the weight of the body until the limb is vertical; the left hind leg leaves the ground, and the flexed right hind leg and left fore leg are swinging forward. Finally, the right fore foot leaves the ground, the leg being strongly flexed, and the body moves through the air from the impetus from the left, aided by the right, hind leg. The three strokes of the hoof correspond to the three actions described above as 1, 2, and 3. The pause between the first and second sounds is short, that between the second and third still shorter, while between the third and first, and while the body is moving through the air, the pause is considerably longer.

In this gait, as in the run and long jump, and occasionally in the high jump, the weight of the body when it first reaches the ground is not received on the fore legs, but through rapid flexion the hind legs first touch the ground.

In the canter the action of all the limbs is much slower, the vertebral column being more raised, the gait, therefore, more resembling the high than the long jump. The fall of the diagonal feet is separated by a short interval; so in the canter four strokes of the hoofs are heard.

The plates following page 921, through the kind permission of Provost Pepper, of the University of Pennsylvania, and Mr. Muybridge, are reproduced from the elaborate series of instantaneous photographs made by Mr. Muybridge in the University of Pennsylvania.

5. OTHER MOVEMENTS IN THE HORSE.—(a) *Rearing*.—In the act of rearing the fore part of the body becomes raised up on the hind extremities, so that the vertebral column leaves the horizontal direction and becomes nearly vertical. The first stage of rearing consists in the fixation of the hind legs, the elevation of the neck and head, and the contraction of the back and lumbar muscles, by which the vertebral column becomes rigid; then the elevation of the fore legs commences with a slight bowing of the extremities and subsequent powerful extension, by which the feet are raised up from the ground and become flexed. Then there is a powerful contraction of the back muscles (the ilio-spinal, the gluteal muscles, and the ischio-tibial muscles), the anterior extremity of the vertebral column is somewhat raised up, its elevation being assisted by the drawing down of the pelvis by means of the lumbar muscles, so that the weight of the body is now borne by the flexed hind legs (Fig. 310). The vertebral column ordinarily does not quite reach the vertical line, but yet the line of

direction of the centre of gravity may fall behind the hind legs, and then the animal falls over backward. In rearing, the fore legs and hind legs are parallel to each other and always somewhat diagonal; likewise, both fore legs are not elevated simultaneously, but one somewhat precedes the



FIG. 310.—REARING. (*Colin.*)

A B, line of action of ilio-spinal muscles; F G, gluteus maximus; D C, ischio-tibial muscles, D E, pyramidal prolongation of the vastus.

other. The return to the normal condition is accomplished by the dropping of the head and neck, the return of the fore legs from their flexed to the extended condition, so that gravitation alone is sufficient to cause

the body to return to its natural position supported on all four of its extremities.

(b) *Kicking*.—By this term is understood the elevation and violent extension of the hind legs, with raising of the posterior part of the vertebral

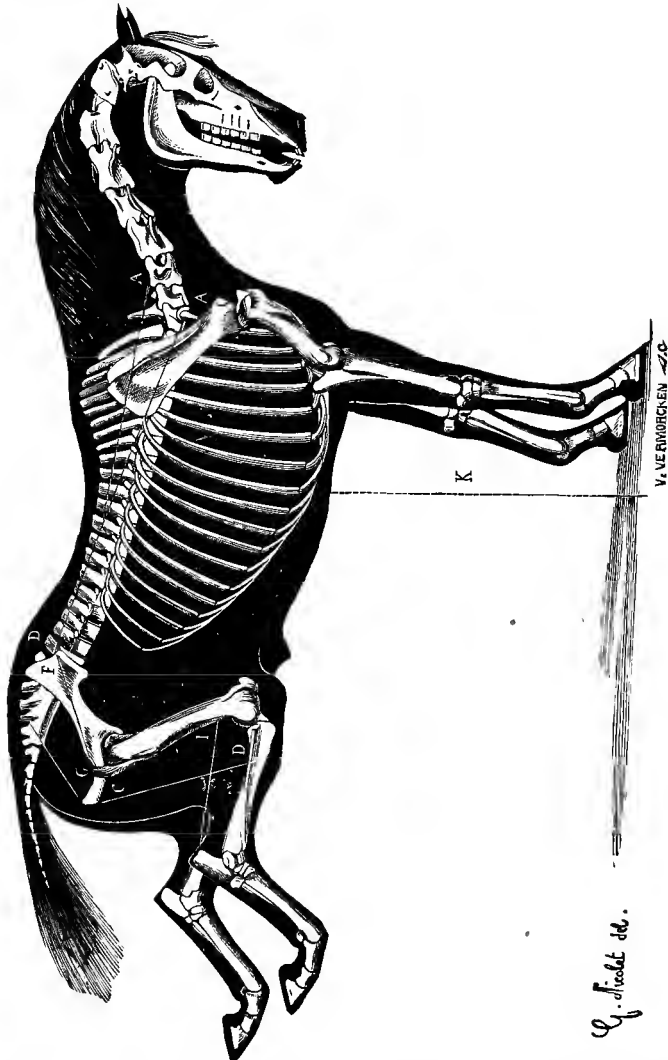

FIG. 311.—KICKING. (Coitz.)  
C D, ischio-tibial muscles; A A D, ilio-spinal muscles; F G, gluteal muscles.

column. The first stage of this act consists in the extension of the neck and the dropping of the head toward the ground between the firmly extended fore legs, while the hind legs are flexed by the powerful contraction of the back muscles, which find a fixed point of support in the last

cervical vertebræ. The pelvis and posterior part of the vertebral column is raised, this elevation being assisted by and coinciding with the sudden extension of the hind legs, the feet leaving the ground and being extended by the muscles of the upper joint of the leg, the lower joints likewise being subsequently extended. Here, also, both fore feet are not parallel on the ground, but one is somewhat advanced in front of the other. The hind foot on the diagonal side is somewhat sooner raised, and, therefore, further extended than the other (Fig. 311). In this act the centre of gravity never nearly approaches the line of direction of the fore legs, so that this position can be maintained but for an instant, the trunk sinking again by its own weight, and is supported by the hind legs, which are now flexed and drawn under the body.

(c) *Lying Down and Rising Up.*—The first stage of lying down in the horse consists in the backward motion of the fore feet and the forward motion of the hind feet, thus greatly reducing the base of support. A sudden flexion of the fore legs then occurs, so that the animal falls on its knees; then the hind legs become flexed, so that the posterior surface of the tibiæ touches the ground. The act of lying down, therefore, in the horse is practically falling down. While lying one side of the body completely touches the ground, the limbs being extended from the body either in slight flexion or in complete extension. In rising up the extended extremities are drawn to the body, and by the unilateral action of the trunk muscles the body is brought in such a position that the chest and abdomen are in contact with the ground, the fore feet are then extended on the ground, and a fixed point for the back muscles thus being acquired, the contraction of these muscles draws the pelvis forward, so that the hind legs are now enabled to bring the feet against the ground, and by sudden extension of all the legs the body is raised up.

(d) *Walking Backward.*—In walking backward in the horse the head and neck are elevated, the spinal column, through the contraction of its muscles, rendered rigid, and the fore legs in a somewhat flexed condition are directed from above backward and downward, and then, in contact with the ground, gradually extended, being assisted by the contraction of the pectoralis major and latissimus dorsi, serve to push the body backward from the flexed hind legs. The backward movement occurs by the alternate movement of the diagonal feet; thus, it may commence with the fixation and extension of the right fore foot, then the left hind foot, then the left fore foot, and then the right hind foot. The foot which is raised up is, however, again placed on the ground and commences to act as a supporting member before the foot which is next elevated has left the ground. Consequently, support continues on three feet at one time, and the period of support lasts much longer than that of forward movement. Walking backward in quadrupeds is, therefore, an extremely slow

gait. In this act the centre of gravity is not moved directly forward, but oscillates from side to side.

(e) *Swimming*.—In swimming the trunk is almost entirely immersed in the water, the neck extended, and the head held high. The horse swims readily, since its lungs contain a large amount of air, and the rapid movement of the limbs gives to the body an impulse in a horizontal direction, the weight of the body being largely overcome by the buoyancy of the water. The movement of the feet consists in rapid pendulum-like motions from before backward, and the forward motion of the body results from the resistance which the water offers to the backward movement of the feet. The swimming motions in the horse occur regularly in the same direction on each side of the body.

The power developed by any mechanical contrivance is estimated by the weight multiplied by the height to which it may be raised in one second; this is described as a kilogram meter. Animals, therefore, may be regarded as machines, since they possess the power of raising a weight to a certain height. Likewise, the motion of a weight on a level surface is to be regarded as a production of work, and whose movement equals the sum of all the resistances which have to be overcome by the animal and the velocity produced. The power of a horse is placed, as an average, at sixty kilogram meters, an ox at sixty kilogram meters, and an ass at thirty-six kilogram meters. The average velocity communicated to the weight in work continued for several hours each day has been placed in the horse at 1.25 meters, the ox 0.8 meter, and the ass 0.8; consequently the unit of power in the horse has been placed at seventy-five kilogram meters, in the ox forty-seven, and ass twenty-nine: so that, therefore, one horse-power would mean a power which would be able to raise seventy-five kilograms one meter high in one second. In referring these figures to the body of animals, it has been calculated that the development of power in animals in one hour, reckoned for each kilogram of body weight, is—

In the horse,	.	.	.	.	.	940 kilogram meters.
“ “ mule,	.	.	.	.	.	800 “ “
“ “ ass,	.	.	.	.	.	640 “ “
“ “ ox,	.	.	.	.	.	620 “ “
“ “ man,	.	.	.	.	.	560 “ “

In the application of animal power in hauling, or in employing the horse as a draught animal, resistance has to be overcome, since the centre of gravity must be advanced by the power exerted by the hind extremities (Fig. 312). In general, the hauling power of an animal, as in all motors, is governed by the mass moved, therefore through the weight of the animal and through the velocity communicated. The power thus acts in two relationships, through the overcoming of the resistance of the

weight and the transference of the velocity of the animal to the moving mass. All the arrangements of the hind extremities are especially favorable for the production of power; thus, reduction of the anterior pelvic angle, accompanied by powerful development of the hips and lumbar muscles. In animals, therefore, with short bones, slight angularity, and short muscles the conditions are most favorable for drawing heavy weights, while animals with long bones, long muscles, and highly angular joints are especially adapted for speed. The position of the centre of gravity in the animal body is especially of influence in the developing power. Since the body weight is the moving force its

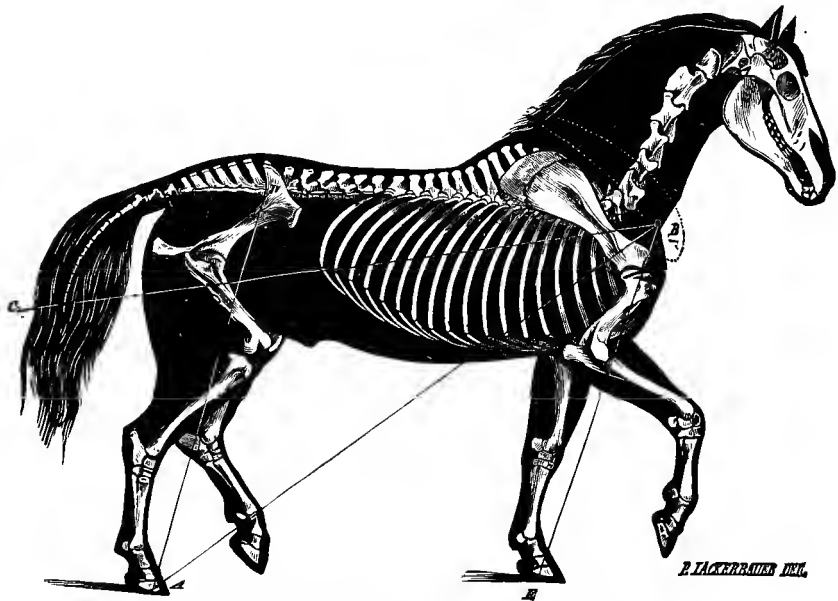

FIG. 312.—HAULING FROM A COLLAR. (*Colin.*)

The line, *A B*, indicates the direction of the resultant of the propelling forces through the lines, *A D* and *B C*.

action will be the more developed the farther forward the centre of gravity, since in this way the power-arm of the lever will be increased. Consequently, draught animals sink the head and neck. The power developed by horses has been estimated by raising a certain weight to a certain height by a rope passing over a pulley. Experiments so made have shown that a moderately strong horse may raise a weight of ninety-five kilos in one second to 0.8 meter high, from whence horse-power of seventy-six kilogram meters has been deduced. In the same way the power of an ox has been found to be forty-seven and an ass twenty-nine kilogram meters. In drawing a weight, the full power of an



animal is never employed, but there is always a certain amount of loss from friction and other causes. As most of the contrivances which are employed to enable horses to draw weight consist of attachments which applies the weight to the horse's shoulders, the weight falls in front of the centre of gravity of the body, and the animal may thus be regarded as pushing the weight; and as the mass moved is the animal's body plus the applied weight, the greater the latter the more the centre of gravity of the common mass will be advanced. Hence, in drawing heavy weights the fore limbs will be behind the common centre of gravity, and they, also, in their extension will aid in propelling the body.

6. SPECIAL MUSCULAR MECHANISMS.—*The Voice.*—By the term voice is meant the sound produced in man and the higher animals through the vibration of the column of air forced by the contraction of the thorax between the vibrating vocal cords of the larynx. Speech, of which man

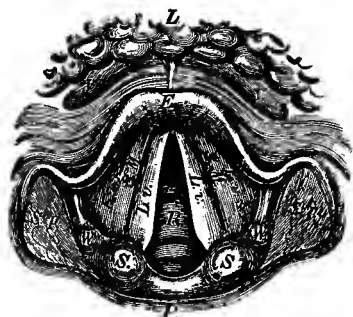

FIG. 313.—THE HUMAN LARYNX, AS SEEN WITH THE LARYNGOSCOPE. (*Landois.*)

*L.*, tongue; *E.*, epiglottis; *V.*, vallecula; *R.*, glottis; *L v.*, true vocal cords; *S. M.*, sinus Morgagni; *L v. s.*, false vocal cords; *P.*, position of pharynx; *S.*, cartilage of Santorini; *W.*, cartilage of Wrisberg; *S. p.*, sinus pyriformes.

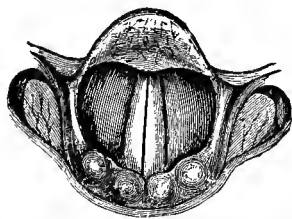

FIG. 314.—POSITION OF THE HUMAN VOCAL CORDS ON UTTERING A HIGH NOTE. (*Landois.*)

alone is capable, consists in certain modifications of the voeal sounds by the parts situated above the larynx; that is, the pharynx, mouth, soft palate, nasal fossæ, tongue, teeth, and lips. Speech may, therefore, be described as articulate voice.

Voice is produced by the imparting of the vibrations of the voeal cords to the column of air within the respiratory organs. The means by which this is accomplished is entirely analogous to that by which sound is produced in reed instruments. The vocal cords consist of free rims of highly elastic membrane whose tension may be varied by muscular action and whose edges may be approximated or separated (Figs. 313 and 314). When the edges of the voeal cords are in close contact, through a strong muscular expiratory motion the air below the voeal cords becomes greatly condensed and finally its tension is sufficient to overcome the resistance of the closed voeal cords; when the voeal cords are thus

separated air passes between them, and, consequently, rarefaction of the air below takes place, while the cords being elastic, their tension serves to again readily overcome the propulsion of the air from the contraction of the thorax. As a consequence, the edges of the vocal cords are set into rapid vibration and these vibrations are communicated to the column of air both below and above the vocal cords, and as a result a sound which is due to these vibrations is produced; the vibrations of condensation and rarefaction of the air are the principal causes of the tone, while the cavities above the vocal cords fulfill the part of resonators.

Sounds produced in this way, like other musical sounds, may vary in regard to their pitch, intensity, and quality. The *pitch* of the sound will depend upon the length of the vocal cords, the shorter the vocal cords, the more rapid are the vibrations and the higher the pitch of the note produced. The pitch of the note is further dependent upon the degree of tension of the vocal membrane. As in the case of musical instruments of a similar nature, stringed instruments, or reed instruments, the pitch of the note is proportionate to the square root of the tension. In man and other mammals in whom vocal cords are present, the pitch of the note may, therefore, be modified by varying degrees of tension of the vocal cords through the action of different muscles.

The *intensity* of the sound depends primarily upon the strength of the blast of air, so that, therefore, the more vigorous the expiration, the greater will be the amplitude of the vibration of the vocal cords and the greater will be the intensity of the sound, while the action of the different resonators of the vocal organs, through the sympathetic vibrations induced in their cavities by the vibration of the column of air set into motion by the swaying vocal cords, is added to the fundamental tone that is produced and its intensity is modified.

The *timbre*, or quality of the vocal sounds, as in other musical instruments, depends upon the over-tones or harmonics which accompany the fundamental note. Changes in the shape of the different resonating cavities of the vocal organs will, by modifying the prominence of different over-tones, account for the difference in the voice of different animals.

The mode of production and the character of the voice differ very greatly in different members of the animal kingdom. Voice may be produced in all vertebrates possessed of lungs and larynges, while in fishes, where the respiration is branchial and not pulmonary, the production of voice is impossible. In invertebrates the sounds produced in such great variety are in no respect analogous to the voice, since they are produced by entirely different mechanisms. Thus, insects produce sounds (which are especially distinguished for their acuteness) either by the rapid movement of their wings, as in flies and bees, or by rubbing their legs

on their wing-cases, or their wing-cases on each other or on the thorax or abdomen. In humming insects sound may be produced by forcing the expired air from their stigmata, which are provided with muscular rods and which are thus thrown into vibration, so that in this group of insects, represented by the humming-bees and many diptera, the closest analogy exists between the production of sound and the production of voice in the vertebrates.

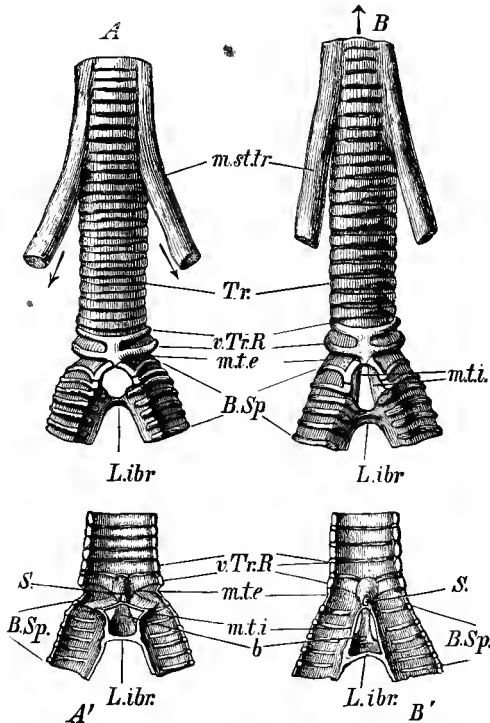

FIG. 315.—INFERIOR LARYNX OF THE TURKEY. (Grützner.)

*A*, during voice production; *B*, in free respiration. (In *A'* and *B'* the anterior wall is removed.) *m. st. tr.*, sterno-tracheal muscles in contracted condition in *A* and *A'*; *Tr.*, trachea; *v. Tr. R.*, united tracheal rings, forming the tympanum with its antero-posterior bridge, *S.*; *B. Sp.*, bronchi; *m. t. e.*, external tympanic membrane; *m. t. i.*, internal tympanic membrane stretched out flat in *B* and *B'*, in *A* and *A'* forming sharp folds in the lumen of the bronchi; *L.ibr.*, interbronchial ligament; *b.*, band running to the dorsal wall of the trachea.

Animals below insects, as radiates and mollusks, are all entirely incapable of sound. Among reptiles, certain of them, such as frogs, lizards, and other batrachians, possess true vocal organs. Among amphibians the frog has a larynx provided with muscles, which produces a sound of varying pitch, dependent upon the strength of the muscular contraction and the force of the expiratory blast. The range of such vibrations is, however, extremely limited. In the *Rana esculenta* there is on each side of the angle of the mouth a membranous bag which may

be inflated with air, and whose walls, being thin and membranous, are thrown into vibration, and, together with the column of air contained in the oral chamber, aid in producing the characteristic resonance of the croaking of the frog (Fig. 315).

In birds the vocal organs are double, a larynx situated at the upper termination of the trachea and a syrinx at its bifurcation constituting a true vocal organ. Two folds of mucous membrane, or three in the case of song-birds, project into each bronchus, and are so acted on by muscles as to vary their tension and adapt them to the production of voice. The superior larynx acts only as an accessory in the production of sound. The number and complexity of the muscular fibres acting on these membranes varies in proportion to the range of voice. In the gallinacea simply a trace of muscular fibre can be recognized; but one pair of muscles is found in the eagle, three pairs in the paroquet, while five pairs are found in song-birds. These muscles have a common origin in the trachea, and their other extremities are inserted into the first ring of the bronchus. In addition to these intrinsic muscles there are others concerned in varying the length of the trachea, so as to alter the length of the vocal tube and, therefore, the pitch of the note produced. The superior organ, or the larynx, is entirely negative in the production of sound, and the performance of tracheotomy below the larynx produces but slight modification in the character of the sound produced.

In mammals, as is well known, the greatest variation exists in the character of the sounds produced. The organs for the production of sound are here the larynx and the upper resonating chambers, varying in shape and general character among each other, although in all built on the same general plan as in man. The variations in the voice are dependent upon modifications in the larynx, in the depth of the nasal chambers, the shape of the pharynx, of the various sinuses, and the formation of the mouth and of the laryngeal ventricles. Sound is, however, primarily due in all cases to the vibrations transmitted to the column of air by the swaying to and fro of the vocal cords. The superior or false vocal cords of man are absent in many species of mammals. The glottis of the horse is distinguished by the formation of a semi-lunar fold of mucous membrane below the epiglottis, which serves to form a funnel-shaped cavity. The laryngeal ventricles are also well developed. The voice in the horse is produced by a succession of interrupted expiratory movements, the tension of the vocal cords gradually diminishing during each complete expiration, so that, therefore, the first sounds produced have a higher pitch than the last; the superior ventricles are wanting (Fig. 316).

The larynx of the ass differs but slightly from that of the horse. Here, also, there are two vocal cords, the ventricles are well developed,

but the opening to them is narrow. The voice of the ass is characterized by the fact that it commences in an inspiratory movement in the production of a sound of high-pitch and it terminates in expiration in the production of a deeper sound.

The larynx of ruminants offers considerable differences to that of solipedes. The glottis is short, and the vocal cords can scarcely be distinguished from the lining membrane of the larynx, and there are no ventricles. The voice in ruminants is, therefore, more imperfect than in the horse, and consists of a sound of low pitch capable of but little variation (Fig. 317).

In the hog below the epiglottis is found a large, membranous sack, which fulfills the purpose of a resonator, greatly

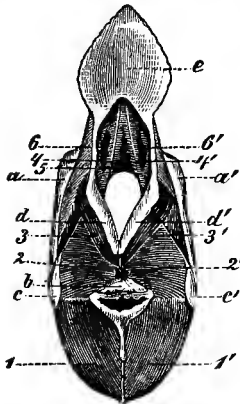

FIG. 316.—LARYNX OF THE HORSE FROM ABOVE AND BEHIND. (Müller.)  
*a a'*, thyroid cartilage; *b b'*, arytenoid cartilages; *c c'*, arytenoid muscles; *d d'*, aryepiglottic folds; *e*, epiglottis. *1 1'*, posterior crico-arytenoid muscles; *2 2'*, oblique arytenoid muscles; *3 3'*, superior thyro-arytenoid muscles; *4 4'*, true vocal cords; *5*, glottis; *6*, ventricles of larynx.

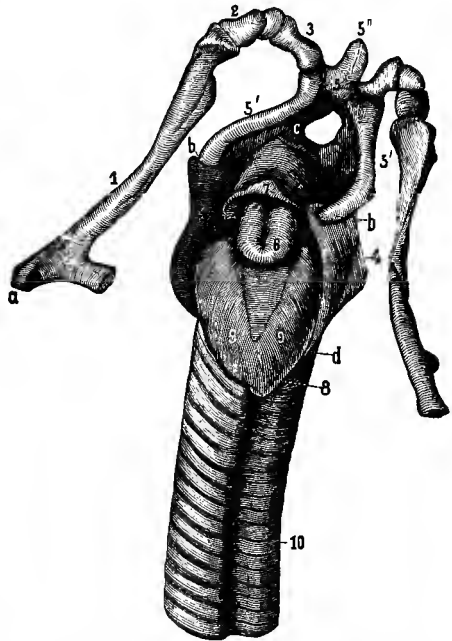

FIG. 317.—LARYNX AND HYOID BONE OF OX. (Müller.)

1, 2, 3, arms of the hyoid bone; 4, thyroid cartilage; 5, body of the hyoid bone; 5' and 5'', fork of the hyoid bone; 6, arytenoid cartilages; 7, epiglottis; 8, cricoid cartilage; 9, posterior crico-arytenoid muscles; 10, trachea.

strengthening the intensity of the voice and giving to it its peculiar character. In the hog the inferior vocal cords are inserted into the tracheal border of the thyroid cartilage and the arytenoid cartilages are fused together, the vocal cords are rudimentary, the ventricles are deep and communicate with the interior of the larynx only by a narrow slit. Two characters of sound may be produced by the hog, the one of low pitch, a grunt, which is the habitual sound, while another of very high pitch is only produced when the animal is maltreated or excited.

In the dog the vocal cords are well developed, while the false vocal

cords are scarcely perceptible; the ventricles are ample, but their openings are very narrow. The voice in dogs is capable of greater scope than in other of the domestic animals, with the exception, perhaps, of the cat, which is characterized by an almost equal development of the upper and lower vocal cords.

The mechanism of the production of the voice, therefore, depends upon the expulsion of a blast of air between two free membranous rims, which are thus thrown into vibration and whose tension and position are capable of modification. The change in the position and tension of the vocal cords is accomplished through the action of the laryngeal muscles. The laryngeal muscles fulfill a double function. In respiration, as has been already mentioned, the glottis is widened during inspiration and the vocal cords tend to approach each other during expiration. In the production of voice the vocal cords are almost always in close contact.

The glottis may be dilated by the action of the crico-arytenoid muscles. When they contract the arytenoid cartilages are drawn backward, downward, and toward the middle line, so that, therefore, the vocal processes in which the vocal cords are inserted must be separated. A large triangular space is thus formed between the vocal cords as in inspiration.

The glottis is constricted by the contraction of the transverse arytenoid muscles, which extend from both outer surfaces of the arytenoid cartilages along their entire length. When these muscles, together with the oblique arytenoid, contract, the arytenoid cartilages are approximated and the glottis closed. During the production of voice the vocal processes of the arytenoid cartilages must be closely approximated, and to accomplish this it is necessary that they be rotated inward and downward. This result is brought about through the contraction of the thyro-arytenoid muscles, which are imbedded in the substance of the vocal cords, and when they contract they so rotate the arytenoid cartilages that the vocal processes turn inward. The glottis is, therefore, narrowed to a mere slit in the anterior part, while a triangular space through which respiration takes place remains open posteriorly.

The vocal cords vary in tension according to the degree of contraction of the crico-thyroid muscles, which pull the thyroid cartilage downward and forward. At the same time the crico-arytenoid muscles act upon the arytenoid cartilages, drawing them slightly backward and maintaining them in that position.

In the production of voice, not only must the vocal cords be thrown into tension in the manner above described, but the triangular space of the respiratory part of the glottis between the arytenoid cartilages must likewise be closed. This is accomplished by the contraction of the

transverse and oblique arytenoid muscles, added to the contraction of the internal thyro-arytenoids. At the same time a concave margin is produced in the vocal cords through the action of the crico-thyroid and the posterior crico-arytenoids (Figs. 318, 319, and 320).

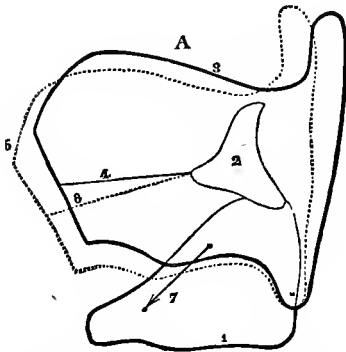

FIG. 318.—ACTION OF THE MUSCLES OF THE LARYNX. (*Beaunis.*)

The dotted lines indicate the new positions assumed by the thyroid cartilage in the action of the crico-thyroid muscles.

1, cricoid cartilage; 2, arytenoid cartilage; 3, thyroid cartilage; 4, true vocal cord; 5, new position of the thyroid cartilage; 6, new position of the vocal cords.

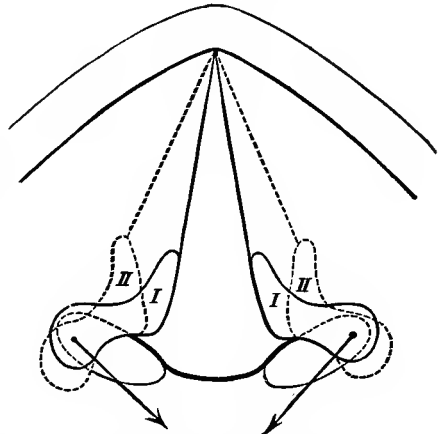

FIG. 319.—SCHEMATIC HORIZONTAL SECTION OF THE LARYNX. (*Landois.*)

I, position of the horizontally divided arytenoid cartilages during respiration; from their anterior processes run the converging vocal cords. The arrows show the line of action of the posterior crico-arytenoid muscles, resulting in the assumption of the positions indicated by the dotted lines, II, II.

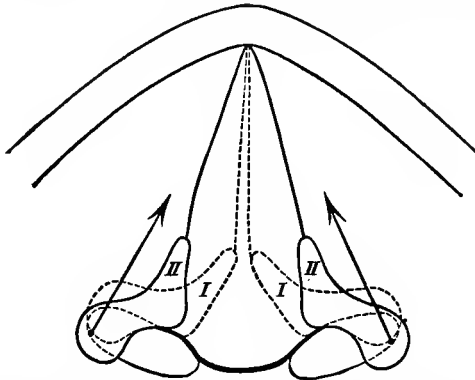

FIG. 320.—SCHEME OF THE CLOSURE OF THE GLOTTIS BY THE THYRO-ARYTENOID MUSCLES. (*Landois.*)

II, II, position of the arytenoid cartilages during quiet respiration; the arrows indicate the direction of muscular traction. I I, the position of the arytenoid cartilages after the muscles contract.

The thyro-arytenoid muscle is the one which principally causes variations in the tension of the vocal cords and, consequently, variations in the pitch of the sounds.

When the muscles acting on the vocal cords relax the vocal cords themselves likewise relax from the reduction of the extending force, and

the elasticity of the displaced thyroid and arytenoid cartilages comes into play and causes them to assume their original position. The thyro-arytenoid and the lateral crico-arytenoids may likewise serve to produce relaxation of the vocal cords.

To recapitulate: the tension of the vocal cords is principally due to the crico-thyroid and the posterior crico-arytenoids; the narrowing of the respiratory part of the glottis is accomplished by the transverse and oblique arytenoids; and the narrowing of the vocal glottis is accomplished by the contraction of the thyro-arytenoid and the lateral crico-arytenoids, the former muscle likewise increasing the tension of the vocal cords.

With the exception of the crico-thyroid all the intrinsic muscles of the larynx are supplied by the inferior laryngeal nerve. The superior laryngeal nerve supplies the crico-thyroid, and is at the same time the sensory nerve of the mucous membrane of the larynx.

For the mechanism of articulated speech the reader is referred to text-books on human physiology.



## SECTION II.

### THE PHYSIOLOGY OF THE NERVOUS SYSTEM.

THE different functions of the animal body have been found to require for their fulfillment divers structures different in location and in mode of action. In any one of the single functions of the animal body, such, for example, as the contraction of a muscle, a number of processes are concerned; thus, the inauguration of the muscular contraction requires the conduction to a muscle of a stimulus. The muscle in contracting uses up a large supply of oxygen and liberates more carbon dioxide and other retrograde products. Increased muscular contraction, therefore, necessitates a supply to the muscle of a larger amount of arterial blood and the removal from the body through the lungs and kidneys of the products of the waste of muscular tissue. Muscular activity, therefore, implies accelerated circulation, accelerated respiration, and increased excretion. A similar complexity may be traced in all the other different functions of the animal body. Each modification or even manifestation of function implies a reflection upon the activity of other associated processes. This co-ordination of operations, which may be widely different in character and yet closely interdependent, is accomplished by means of the nervous system. The primary object of the nervous system is, therefore, to link together different and widely distant organs, and thus act as the regulator of the actions of the animal body.

In animals where specialization of function has not yet appeared no such communication between different parts of the body is required, and, as a consequence, in such no nervous system is present. As we found that the organs of circulation were largely dependent for their degree of development on the complexity of the alimentary apparatus, so it may be found that in a general way the nervous system is developed in proportion to the muscular system. This indicates one of the main functions possessed by the nervous apparatus for controlling and modifying movement. This is, however, but one side of the importance of the nervous system.

In the nervous system is developed in the highest degree the function of automatism. By this term is meant the power possessed by the lowest forms of protoplasm of receiving impulses from without and modifying them into efferent impulses, which may take on the form of motion as their most usual manifestation. It is thus seen that automatism

implies at least four different operations—the conduction of afferent impulses, the reception and conversion of these afferent into efferent impulses, and the liberation again and conduction of efferent impulses.

In the scheme of specialization of function it would only be expected that for the division of labor we should also find that these operations become separated and located in different structures. We find, therefore, the nervous system, in accordance with this purpose, divided into organs of conduction and organs of receiving and liberating nervous impulses.

The organs for transmitting nerve impulses constitute the nerves. The organs for modifying and liberating nerve impulses are found in the ganglia or nerve-cells of the nervous system.

The scheme of the nervous system, therefore, implies the presence on the periphery of a receptive organ for receiving external impressions. Such an organ is represented by the terminal filaments of the sensory nerves, or, rather, the nerves of general or special sense. It implies a means of communication between this external receptive organ and the nervous ganglia at a distance, the latter possessing the power of receiving the impressions transmitted from the exterior through the afferent sensory nerves. Such a receptive ganglion is again in connection with a cell or collection of cells in which the automatic powers are especially developed, and which, therefore, modify the impressions coming from without and convert them into efferent impressions. The latter are conducted from the centre through the efferent or motor nerves to various peripheral organs, whether to the terminal plates in the muscular tissue or to glands, blood-vessels, or the other structures of the animal body.

Like all other organic systems, the nervous system becomes more complicated and diversified, reaching a higher stage of perfection in passing from the lowest forms of animal life, in which it first appears, to the higher examples of the animal series.

In the protozoa, the lowest subdivision of the animal kingdom, a nervous system in the sense in which we have described it, as constituted of nerve-cells and nerve-fibres, is entirely absent. The undifferentiated protoplasm fulfills all the purposes of the nervous system as demanded by the needs of such an organization.

In the animals belonging to the group of infusoria, where we find the first appearance of the development of organs as seen in the contractile cilia as organs of locomotion, the nervous system has not appeared, the movement of such organs being dependent simply upon the automatic properties of the undifferentiated protoplasm; and we find as an illustration of this that even in animals higher in the scale, where ciliated organs are commonly found, that such are independent of the nervous system.

In the star-fish is found the first clear evidence of nerve fibres and

cells connected together to receive and convey impression (Fig. 321). It consists of a ring around the mouth composed of five ganglia of equal size with radiating nerves. From this circle delicate fibres may be traced into the different rays. In lower zoöphytes all traces of the nervous system is wanting, and in them the functions of nutrition are accomplished through the operations of undifferentiated protoplasm.

In the mollusks the nervous system has reached a somewhat higher form of development, and two or more ganglia are found located around the gullet and communicating by nerve-fibres with other ganglia in different regions of the body, sending off nerves to the different organs. Usually in the mollusks there is a circular ganglion located in the cephalic side of the animal and two abdominal ganglia placed below the œsophagus

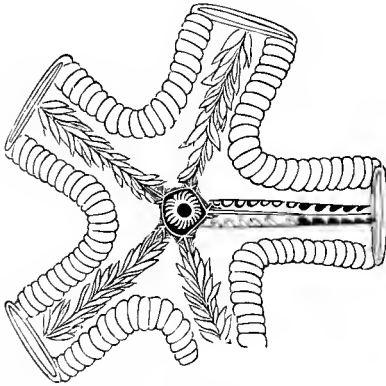

FIG. 321.—NERVOUS SYSTEM OF THE STAR-FISH. (*Carus*.)

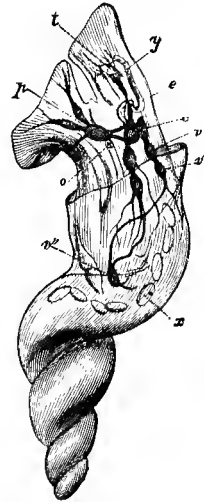

FIG. 322.—NERVOUS SYSTEM OF A GASTROPOD MOLLUSK. (*Perrier*.)

*c*, cerebroid ganglia; *p*, pedal ganglia; *o*, otcysts; *v*, *v'*, *v''*, ganglia of second œsophageal collar; *t*, tentacles; *y*, eyes; *x*, excrement.

and united to the cephalic ganglion and the œsophageal ring (Fig. 322). These ganglia are frequently connected with others whose locations will vary in different species.

In the articulata, represented by the insects, annelida, and crustaceans, the nervous system has become symmetrical (Fig. 323).

The ganglia which compose the nervous system may be arranged in pairs on each side of the median line of the body, each pair corresponding to a segment of the body, extending throughout its entire length and united to each other so as to form a longitudinal chain of ganglia, which are connected further by transverse commissures. Sometimes the ganglia consist of a single median row. Usually one of the ganglia is more voluminous than the others, and being, as a rule, located in the anterior extremity of the animal, might be compared to

the brain of vertebrates. Such a comparison is warranted by the fact that when nerves of special sense are present they invariably originate from this collection of nerve-cells. Where a distinct cephalic ganglion is present it is situated above the œsophagus, while all the other portions of the ganglionic chain lie on the ventral side of the body, the commencement of the chain being connected with the cephalic ganglion

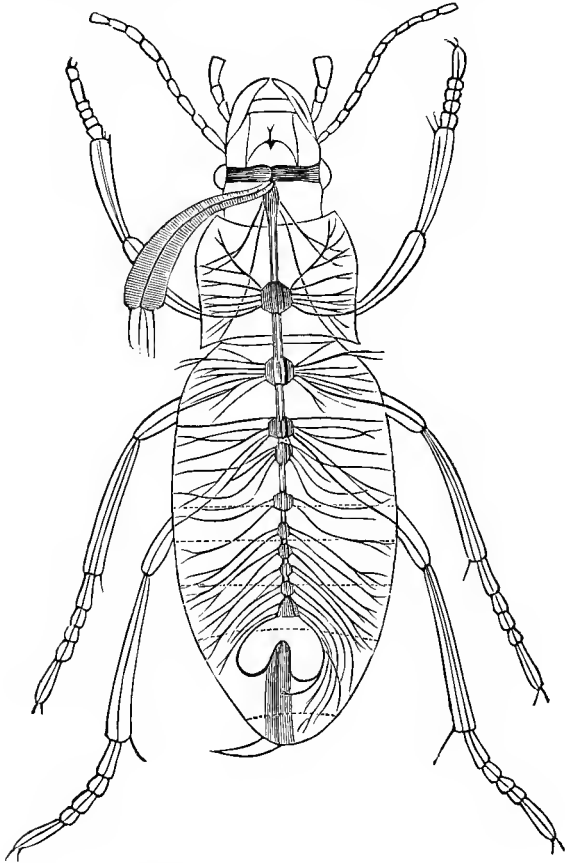

FIG. 323.—NERVOUS SYSTEM OF AN ARTICULATE. (*Perrier.*)

by a collection of circular fibres around the gullet and spoken of as the œsophageal collar.

The number of ganglia in the articulata is very variable; there may be twelve or fifteen pairs or but three. The larger the number of ganglia, the greater their tendency to fusion along the middle line.

In all invertebrates the nervous system is composed of such a series of separate and distinct ganglia.

In vertebrates the nervous system has reached a much higher stage of development, and here is placed above the digestive canal, in contradistinction to the position which it occupies when present in the invertebrates, and is usually inclosed within a bony or cartilaginous cavity; it is divided into a cephalic portion, confined within the cranium, connected to a long trunk of nerve-cells inclosed within the vertebral canal, constituting the spinal cord (Fig. 324). From this central nervous system,

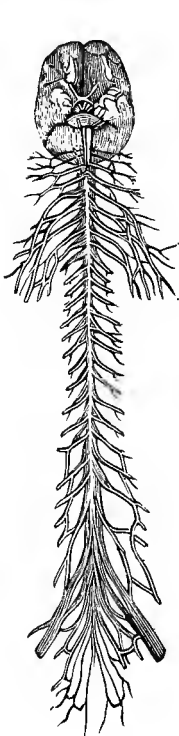

FIG. 324.—BRAIN AND SPINAL CORD OF MAN. (Carpenter.)

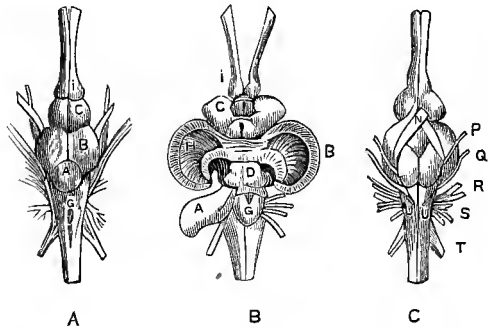

FIG. 325.—BRAIN OF PERCH, AFTER CUVIER. (Rymer Jones.)

A, cerebellum; B, cerebrum; C, olfactory ganglion; i, olfactory nerves; D, optic ganglion; G, supplementary lobe; H, transverse fibres in the walls of the cerebral ventricle; N, commissure of the optic nerves; P, Q, R, S, T, U, the third, fourth, fifth, sixth, seventh, and eighth pair of cerebral nerves.

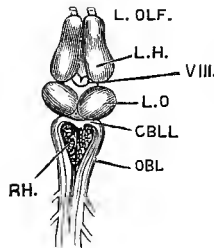

FIG. 326.—BRAIN OF FROG SEEN FROM ABOVE. (Nünn.)

L. OLF., olfactory lobes; L.H., hemispherical lobe (fore-brain); VIII., lobe of the third ventricle; L.O., optic lobes (mid-brain); CBLL, cerebellum (hind-brain); OBL, medulla oblongata; RH, rhomboidal sinus.

both from the brain and spinal cord, originate series of fibres which fulfill the functions of conduction of both motor and sensory impulses and which extend to all parts of the body. In connection with this system, which is spoken of as the cerebro-spinal system, there is usually found a more or less independent series of ganglia, which constitutes the sympathetic system.

While such a cerebro-spinal system characterizes all vertebrates, it is

capable of great variations in development in different members of this group. In fishes and reptiles the brain is less developed than in higher members, no convolutions are found on its surface, and, while the cerebral hemispheres are not highly marked, the optic and olfactory lobules are usually comparatively voluminous, while the cerebellum of reptiles and fishes is reduced to a single lobe (Figs. 325 and 326).

In birds the hemispheres or cerebral lobes are still, as in the mammals, the most voluminous portions of the brain, but here, also, no convolutions are found and they are not closely united to each other, since the corpus callosum, as well as the pons varolii, is absent (Fig. 327).

In birds the analogue of the tubercula quadrigemina, which are four in number in the mammals, are here reduced to two, and, therefore, receive the name of the tubercula bigemina or optic lobes, and are visible at each side of the brain when looked at from above.

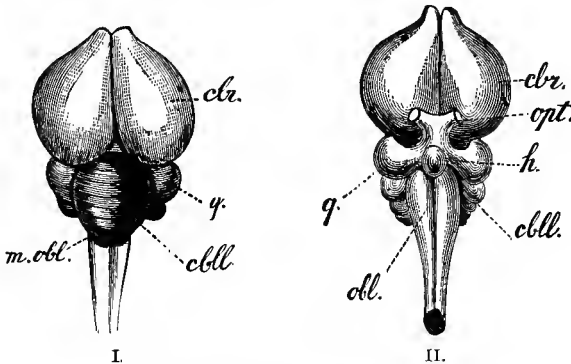

FIG. 327.—BRAIN OF BIRD (*Falco buteo*). (Nühn.)

I, view of upper surface. II, view of lower surface: *chr.*, cerebrum; *g.*, corpora quadrigemina, or bigemina; *cbl.*, cerebellum; *obl.*, medulla oblongata; *h.*, hypophysis; *opt.*, optic nerve.

In birds the cerebellum is likewise reduced to a single median lobe, and is entirely uncovered by the cerebrum, and being single it possesses no lateral hemispheres; the pons varolii, or the transverse fibres which serve as a commissure for the cerebellar hemispheres, as in mammals, is likewise absent.

The characteristics of the mammalian brain will be subsequently alluded to.

The nervous system is composed of central masses which are in constant communication with different parts of the body by means of peripheral prolongations which act as organs of conduction. The nervous system exists, therefore, under two forms—the central, composed largely of the so-called nervous ganglia, or nerve-cells, and the organs of conduction, or nerve-fibres. As already indicated, the peripheral terminations of the nerves are likewise in connection with corpuscular bodies,

which vary in accordance with the character of the nerves with which they are in communication. The nerves or nerve-fibres are simply

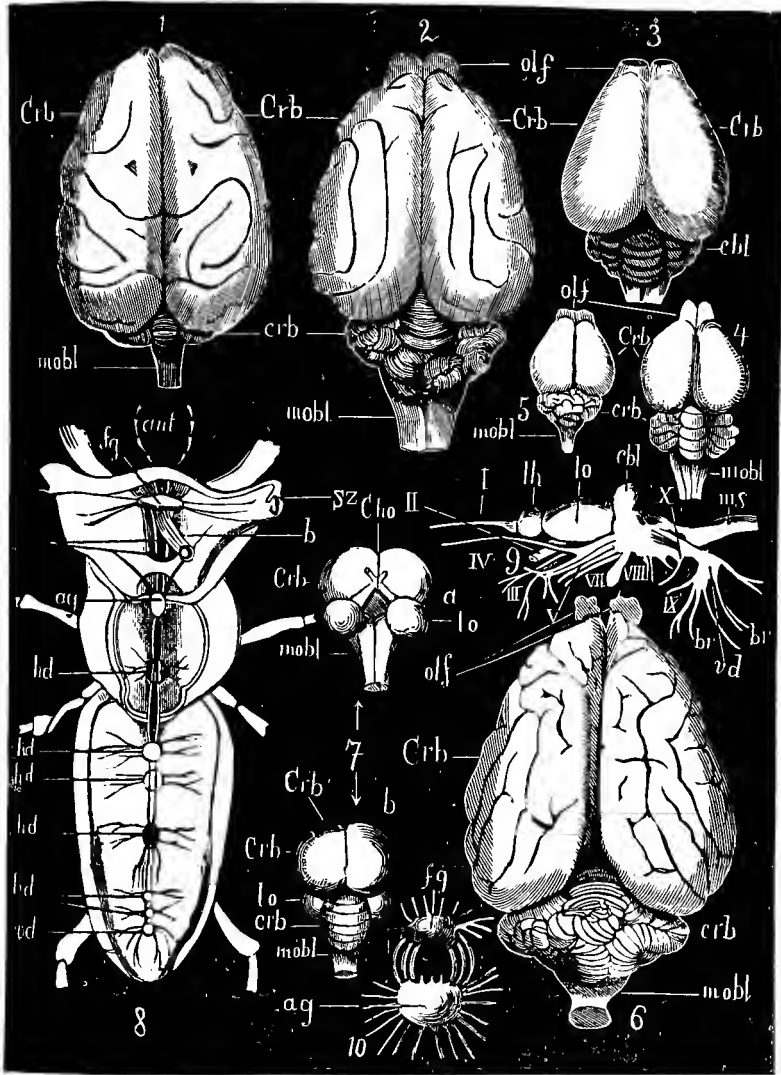

FIG. 328.—BRAIN AND NERVOUS SYSTEM OF DIFFERENT ANIMALS, NATURAL SIZE. (Thanhofer.)

1, brain of ape; 2, domestic cat; 3, squirrel; 4, water-rat; 5, mole; 6, fox; 7, quail; 8, nervous system of horned beetle; 9, perch; *fg*, supra-pharyngeal ganglion; *hd*, abdominal ganglion; *vd*, end ganglion; *b*, oesophagus; *e*, nervous cord connecting the pharyngeal ganglion; *chl*, cerebellum; *chl*, medulla oblongata; *olf*, olfactory tract; *lo*, optic lobes; *Ch*, hemispherical lobes; I-IX (in Fig. 9), cerebral nerves; *vd*, vagus ganglion; *br*, branchial nerves; 10, nervous system of the snail; *fg*, supra-pharyngeal ganglion; *ag*, infra-pharyngeal ganglion.

organs of conduction, and the nerve-cells, in which each nerve at each end terminates, are for receiving and liberating impulses.

Nerves may be of two kinds: afferent or centripetal nerves, which are concerned in the carrying of impulses from the exterior to the central organs; such nerves are frequently spoken of as sensory nerves: and efferent or centrifugal, which carry impulses from the central portions of the nervous system to the exterior; such nerves are motor nerves.

These two distinctions between nerves are not based on any difference in anatomical structure, but are simply functional differences, since it has been found by experiment that nerves may carry impulses in either direction, and by dividing a motor and sensory nerve and connecting the divided extremities of the one with the other the sensory nerve, after union has taken place, may now carry motor impulses and the motor sensory impulses.

The essential part of the nerve-trunk is the so-called axis cylinder, which is composed of a thin filament of undifferentiated protoplasm in no way different, as far as may be determined, from that found in other examples of free protoplasm. This protoplasmic centre, which is composed of a number of fine fibrils and constitutes the axis cylinder, is always covered by a thin, transparent membrane, which is termed the primitive sheath. In many instances this is the only covering to the ultimate fibrils of the nerve, such nerves being called non-medullated nerve-fibres; in others, which are called medullated nerves, within this primitive sheath, and surrounding directly the fibrils of the axis cylinder, is found a thick layer of double refractive substance, which is termed the medullary sheath or white substance of Schwann (Fig. 329).

Each nerve-trunk consists of bundles of nerve-fibres held together by fibrous connective tissue called the epineurium, in which are the blood-vessels with which the nerve-trunk is supplied, lymphatics, and numerous fatty cells. The neurilemma closely resembles sarcolemma in its character; when subjected to long boiling both yield gelatin.

Ganglionic cells or nerve-corpuseles vary greatly in size. They may be spherical, ovoid, pyramidal, or of other shapes, and send off usually numerous branched processes, which serve to characterize the cells as multipolar nerve-cells. No cell-membrane is to be detected, but the ganglia are of soft consistence, containing numerous granules and pigment matter.

The nucleus is ordinarily well developed and is disproportionately large to the size of the cell. Two nucleoli are nearly always present. One of the processes of the ganglion is always unbranched and forms the axis cylinder of the nerve originating or terminating in such a nerve-cell. A nerve, therefore, may be regarded simply as a process of the nerve-



cell, the white substance of Schwann being added after the separation of the nerve-filament from the ganglion.

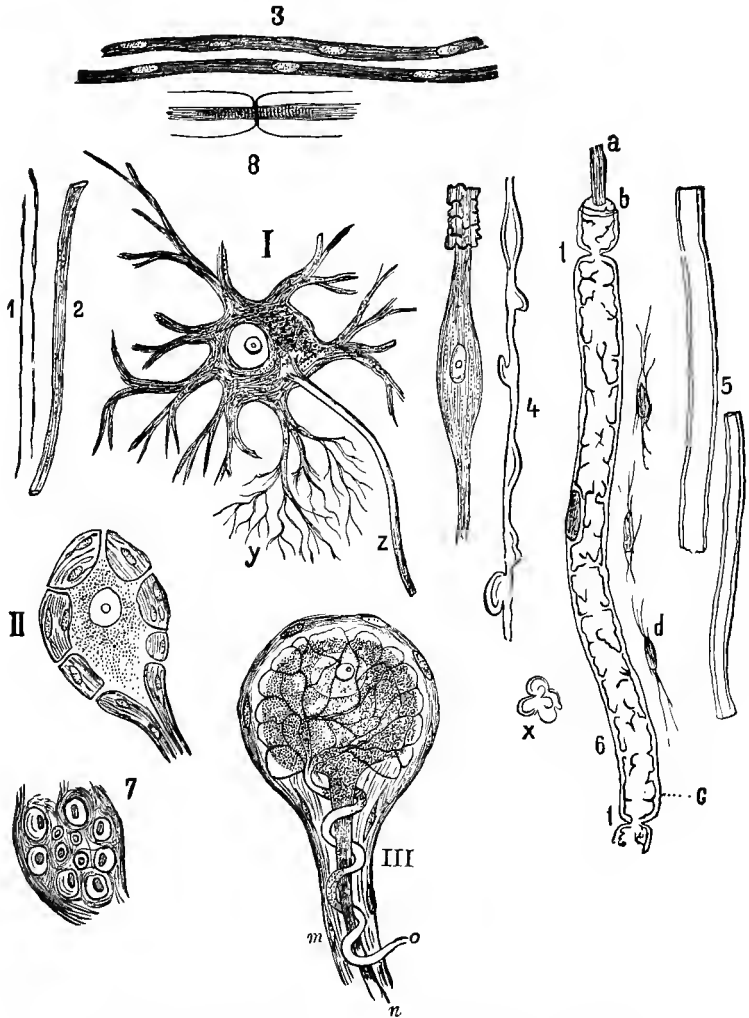

FIG. 329.—THE STRUCTURE OF NERVOUS TISSUE. (Landois.)

1, primitive fibrilla; 2, axis cylinder; 3, Remak's fibres; 4, medullated varicose fibre; 5, 6, medullated fibre, with Schwann's sheath; c, neurilemma; t, t, Ranvier's nodes; b, white substance of Schwann; d, cells of the endoneurium; a, axis cylinder; x, myelin drops; 7, transverse section of nerve-fibre; 8, nerve-fibre acted on with silver nitrate; I, multipolar nerve-cell from spinal cord; z, axial cylinder process; y, protoplasmic processes—to the right of it a bipolar cell; II, peripheral ganglionic cell, with a connective-tissue capsule; III, ganglionic cell, with, o, a spiral, and, n, straight process; m, sheath.

The branched processes of nerve-cells are not, as a rule, concerned in the formation of other nerve-trunks except in the bipolar or multipolar cells, but are concerned in bringing in communication other

adjacent cells, so that impulses may be conducted from one to the other. In the peripheral ganglia connective-tissue corpuscles surround the nerve-cells.

### I. CHEMICAL AND PHYSICAL CHARACTERISTICS OF NERVOUS TISSUES.

The composition of nervous tissue varies according as the examination is made of the white matter of the cerebrum or of the spinal cord, or of the gray matter. The following table represents their average composition:—

#### CHEMICAL COMPOSITION OF NERVOUS TISSUE.

	Gray Matter.	White Matter.
Water,	81.6	68.4
Solids,	18.4	31.6
Proteids,	55.4	24.7
Lecithin, . . . . .	17.2	9.9
Cholesterin and fats,	18.7	52.1
Cerebrin, . . . . .	0.5	9.5
Substances insoluble in ether,	6.7	3.3
Salts,	1.5	0.5

When brain-matter is incinerated the greater part of the phosphorus of the lecithin becomes phosphoric acid, and the ash, hence, has an acid reaction. The following is the composition of the ash of one hundred grammes brain after removing lecithin:—

$\text{SO}_4\text{K}_2$ ,	0.411
KCl,	2.524
$\text{K}_2\text{HPO}_4$ ,	0.266
$\text{Ca}_3\text{P}_2\text{O}_8$ ,	0.013
$\text{MgHPO}_4$ ,	0.084
$\text{Na}_2\text{HPO}_4$ ,	1.752
$\text{Na}_2\text{CO}_3$ ,	1.148
Excess $\text{CO}_2$ ,	0.082
$\text{FeP}_2\text{O}_8$ ,	0.010
	<hr/>
	6.290

The reaction of the gray matter during life is said to be acid from the presence in the ganglionic masses of lactic acid. The reaction of the white matter is neutral or alkaline.

From the above table it is seen that more than half the solids in the gray matter and about one-fourth the solids in the white matter of the nerve-centres consist of proteids, and yet our knowledge of these bodies is very imperfect.

The proteids consist of albumen, which is found in the axis cylinder and in nerve-cells; it is soluble in water and coagulates at  $75^\circ \text{C.}$ ; a globulin-like substance, which may be extracted by means of a 10 per cent. solution of common salt, and which is precipitated by dilution with water and by saturation with salt; and alkali albuminate, which remains

in solution when a 10 per cent. salt solution of brain is boiled; it may be precipitated after filtering by the addition of acetic acid.

Nuclein, also, is found, especially in the gray matter; while in the sheath of nerve-fibres after the removal of the fatty matters by boiling alcohol and ether a nitrogenous body is found which is termed neurokeratin, and which in its composition appears closely related to keratin and is especially characterized by the sulphur (2.93 per cent.) which it contains.

Neurokeratin is not affected in gastric or pancreatic digestion; it swells in caustic potash and strong sulphuric acid, but only dissolves in these liquids when boiled.

Gelatin is likewise found in nerves, but is evidently derived simply from the connective tissue of their sheaths.

Fats are present in large amounts, especially in the white matter and in the white substance of Schwann, which appears to be almost solely of a fatty nature.

The specific constituents of the brain and nerves are of a highly complex character and may be divided into two groups—those which contain phosphorus in combination and those which are free from phosphorus. As an example of the first of these, protagon may be mentioned, which, discovered by Liebreich, has been regarded by many chemists, not as a distinct body, but as a mixture of lecithin, a phosphorized fat, with cerebrin, a nitrogenous, non-phosphorized body. Experiments by Gamgee have, however, apparently proven that protagon is a definite chemical body, soluble in cold alcohol with difficulty, readily soluble in warm alcohol and ether. To this substance Gamgee attributes the empirical formula  $C_{160}H_{308}N_5PO_{36}$ . It forms a clear solution with glacial acetic acid.

Cerebrin is an example of the special brain-constituents which are free from phosphorus; it appears, however, that cerebrin, as described by Müller, is not a distinct body, but a mixture of cerebrin, homocerebrin, and encephalin.

The entire subject of the organic constituents of the nervous system needs to be re-examined, since on any matter where such diametrically opposite opinions are held the error on both sides must be considerable.

Like the muscular tissue, nervous substance when passive has a neutral or even faintly alkaline reaction; after prolonged stimulation or functional activity, produced in any way, the reaction becomes acid.

After death the reaction likewise becomes acid and the nerves become more solid, thus resembling the similar changes which occur in muscle, and, although not thoroughly investigated, in all probability are due to a similar process.

Nerve-fibres are free from elasticity, and if divided do not retract;

their cohesion, due to their connective-tissue constituents, is considerable. It has been found that a weight of one hundred and ten to one hundred and twenty pounds was required to rupture the sciatic nerve of a man at the popliteal space. The nerves lengthen very considerably before breaking; they, therefore, are extensible.

## II. NERVOUS IRRITABILITY.

As in the case of muscle, nerves are capable of having their functional activity called into play by various stimuli; they are, therefore, said, like muscles, to possess the power of irritability.

Stimuli which call nervous activity into existence, like muscular stimuli, may be either mechanical, thermal, chemical, electrical, or physiological, by which is meant the normal stimuli which excite the nervous system in living bodies.

In the case of the nervous system the influence of various stimuli may be made evident, either by allowing them to act upon motor nerves, when the contraction of the muscles evoked will indicate the stimulation of the nerve; or, in the case of sensory nerves, by the pain produced on their application.

A mechanical irritant produces stimulation of the nerves by producing change in the molecular arrangement of the nerve-particles. If the mechanical stimulus, which may be of the nature of a blow, pressure, pinching, and stretching, be sufficiently severe the nerve may then become completely and permanently destroyed, and then lose its power at that point of conducting impressions. A single mechanical stimulation of a motor nerve will produce a single contraction of a muscle. If the stimuli be repeated rapidly at short intervals the contractions may, as in the case of electrical stimulation, be blended together, and when the stimuli succeed each other more frequently than sixteen in the second a prolonged tetanic contraction is produced.

The action of variations in temperature on nerve-trunks is somewhat similar to that exerted on muscles.

If the nerve of a frog be heated to 45° C. its excitability is first increased and then diminished, and the higher the temperature the greater the excitability and the shorter its duration. If the temperature be raised above 60° the medullary substance becomes disorganized and the nerve loses its excitability. Sudden application of cold or heat acts as a stimulus, and may cause muscular contraction. Increase of temperature above 45° produces tetanus with rapid exhaustion of the nerve.

Anything which will rapidly change the chemical composition of a nerve-trunk may act as a nerve stimulus, and, although such stimuli may at first increase a nerve's excitability, they rapidly diminish its irritability and often result in complete nervous paralysis.

Rapid desiccation of nerves by abstracting the water comes under the head of a chemical stimulus. Sugar, urea, glycerin, and many metallic salts likewise act as stimuli and often produce paralysis.

Nerves may likewise be thrown into activity by the application of the electrical current, whether on employing the constant or induced current. When a constant current is allowed to enter a nerve a single contraction is produced at the moment of application of the current, and no other apparent effect is evident until the current is broken. The breaking of the current again causes a contraction to occur. So, also, in sudden increase or decrease in the strength of a constant current passing through a nerve the same effect will be produced as on making or breaking the current.

When a constant current which is too feeble to produce a contraction is allowed to pass into a nerve, and the strength of a current then gradually increased, the degree at which the contraction is produced is spoken of as the minimal stimulus. As the current increases in strength the degree of contractions produced, at first rapidly and then more slowly, increases until a maximum is reached; such a stimulus is spoken of as the maximal stimulus. As a rule, the effect produced by making the current is more powerful than when the current is broken.

Nerves are more sensitive to electrical stimuli than muscles, and a current which, applied directly to a muscle, may be too feeble to produce contraction may throw the muscle into contraction when allowed to pass through its motor nerve. When a strong current is allowed to pass through a motor nerve for some time and the circuit then suddenly broken, instead of a single contraction the muscle will be thrown into tetanus; such a condition is especially produced when the positive pole, or anode, is nearest to the muscle, while, when the negative pole, or cathode, is nearest to the muscle, tetanus occasionally follows the making of the current. This effect is to be explained by the production of a condition which is known as electrotonus, which will be alluded to directly.

When a stimulus is applied to any part of a motor nerve a condition of increased excitation is produced and the impulse travels along the nerve, the direction of the motion depending upon the character of the terminal organs with which the nerve is in communication. When, therefore, a motor nerve is stimulated the impulse travels to the periphery; when the nerve terminates on a cutaneous surface it travels toward the centre, although it must be understood that nerves may conduct impulses in either direction and even carry impulses simultaneously in different directions without interfering with each other.

The rate of conduction of nerve impulses is about twenty-seven

and a quarter meters, or ninety feet, per second, in both motor and sensory nerves, and is influenced by various conditions. Reduced temperature or a great increase in temperature reduces the velocity of nerve impulse. Anelectrotonus decreases the velocity of conduction, while kathelectrotonus increases it.

The conduction of nerve impulse is destroyed by all conditions which injure the nerve, as by section, ligature, compression, or the use of chemical agents which destroy its excitability at any part of its course, by the removal of blood, or by the action of certain poisons, as curare, which destroys the conductivity of the terminal motor-nerve filaments.

When a nerve is subjected to continued stimulation the irritability of the nerve rapidly diminishes; such a nerve is said to be exhausted or to be in a condition of fatigue. A nerve in which exhaustion has occurred may again regain its activity, provided the stimulation has not been too excessive or too greatly prolonged.

In cold-blooded animals stimulation may be much more severe and protracted without producing exhaustion than in warm-blooded animals, and, while nerves are more slowly affected than muscles, the recovery of the former is more slowly accomplished than in the latter.

When a nerve-fibre is separated by section from the central nervous system the condition of the nerve will vary according as to the function of the nerve. Provided a nerve be in connection with the nerve-centres which govern its nutritive processes, it may be divided at any part of its course and degeneration of the nerve will only occur in those parts which have been separated from the nutritive centre. Thus, for example, if a motor nerve be divided the peripheral extremity of the nerve will become disorganized, while the part still in connection with the spinal cord will remain intact.

If a purely sensory nerve be divided it would at first appear that the same condition prevailed; and if, again, a mixed nerve be divided the peripheral part of the nerve, including all its branches, will degenerate, while the central parts will remain intact.

The centres governing the nutrition of motor and sensory nerves are not, however, as might appear from the above statements, the same.

If the anterior root of a spinal nerve be divided before it joins the posterior root the motor fibres in the spinal nerve formed by the union of this anterior and posterior root will degenerate, while the portion remaining in connection with the cord will remain intact. If the posterior root be divided between the spinal cord and its ganglion the part of the nerve lying between the point of division and the spinal cord will degenerate, while the peripheral portions of the part between the point of section and the posterior ganglion will remain intact. This indicates

that the nutrition of motor nerves is controlled by the ganglia in the spinal cord, while the ganglion on the posterior root controls the nutrition of the sensory fibres. Such ganglia controlling nutrition are spoken of as trophic centres, and nerves, therefore, which are separated from their trophic centres undergo permanent degeneration. The nature of the influence exerted by trophic centres is, however, entirely unknown (Fig. 330).

If a nerve be divided and the divided ends again brought into contact by means of sutures, regeneration takes place, and after a varying time the nerve is again capable of conducting impulses.

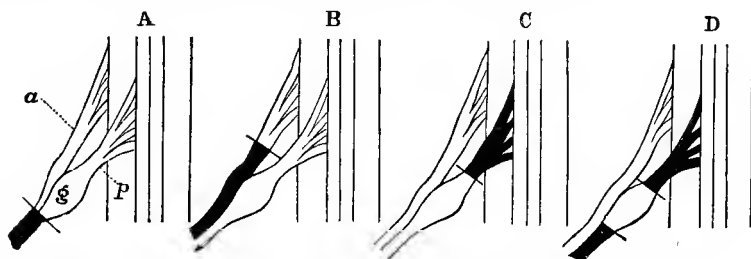

FIG. 330.—DIAGRAM OF THE ROOTS OF A SPINAL NERVE SHOWING THE EFFECTS OF SECTION. (*Landois.*)

The black parts represent the degenerated parts. A, section of the nerve-trunk beyond the ganglion; B, of the anterior root, and C, of the posterior root; D, excision of the ganglion; a, anterior, p, posterior roots; g, ganglion.

### III. THE ELECTRICAL PHENOMENA IN NERVES.

As in muscles, evidence of the presence of a constant electrical current may be found in nerves. If a section of a nerve be removed from the body and placed upon non-polarizable electrodes in connection with a sensitive galvanometer, a strong electrical current may be observed when the transverse section of the nerve is placed in contact with one of the electrodes and the surface in connection with the other. The current will then pass from the longitudinal section to the transverse section; or, in other words, the natural surface will be positive and the artificial surface negative. The nearer one electrode is to the equator, and the other to the centre of the transverse section, the stronger will be the current produced, and when two points on the surface at equal distance from the equator are connected with the galvanometer no current is obtained. The electro-motor force of the strongest nerve-current has been placed at 0.02 of the Daniells' element.

Like muscle, again, the natural current of nerve undergoes a negative variation when the nerve is artificially stimulated. If a section of nerve be so connected with a galvanometer as to develop a strong current, and it then be stimulated either by the application of electricity or a chemical or mechanical stimulus, the nerve-current will be found to

disappear. This negative variation travels toward both ends of the nerve, and, like the production of the negative variation of muscle-current, is due to the rapid succession of interruptions of the origin of the current.

The statement as regards the negative variation of the nerve-current when the nerve is stimulated by an electrical current requires some modification. The statement holds when the induced current, either in single or rapid shocks, is employed. If the constant current be applied to a nerve which is in connection with the galvanometer the effect on the nerve-current will depend upon the direction of the stimulating current.

If the constant current be passed through a nerve outside of the part in connection with the electrodes of the galvanometer, so that its current coincides in direction with that of the nerve-current (descending current), the deflection of the galvanometer needle will be increased instead of decreased; such a state of affairs is spoken of as the positive phase of electrotonus, and is directly proportional in its intensity to the length of nerve, the strength of the galvanic current, and the nearness of application of the stimulus to the section of the nerve in connection with the galvanometer. If, now, the direction of the constant current be reversed, so as to cause the constant current to pass in the opposite direction to the nerve-current, the latter will be diminished; such a condition is spoken of as the negative phase of electrotonus. By the production of electrotonus by means of such a constant polarizing current the excitability of the nerve is greatly modified, not only in the part through which the current is passing, but throughout the entire extent of the nerve. It has been found that at the positive pole the excitability is diminished; this condition is spoken of as anelectrotonus; at the negative pole the excitability is increased and forms the region of kathelectrotonus, the variation in irritability being most marked in the neighborhood of the poles and decreasing in proportion to the distance from the poles.

Between the poles of the polarizing current a point exists where the region of over-stimulation and under-stimulation meet, and where, consequently, the excitability of the nerve is unchanged; such a point is spoken of as the neutral point, and with a weak current lies nearer the anode and with a strong current nearer the kathode.

The production of this condition serves to explain the character of contractions produced on making and breaking a constant current in a motor nerve. When a constant current is allowed to pass through a motor nerve, or, in other words, when a current is closed, the point of greatest stimulation is located at the negative pole and spreads from this point throughout the remainder of the nerve. As a consequence, when the



current is closed the stimulation occurs only at the negative pole at the moment when electrotonus takes place. On the other hand, with the breaking shock, or when the current is opened, the point of greatest stimulation is at the anode and coincides with the disappearance of the electrotonus.

The contraction which is produced on opening and closing a constant current varies not only with the direction but with the strength of the current. Very feeble currents produce a contraction only on the closing of the current, both with an ascending and descending current, from the fact that the occurrence of kathelectrotonus produces a greater effect on the irritability of the nerve than the disappearance of anelectrotonus. When the current is increased in strength contractions are produced both on opening and on closing the current with either an ascending or descending current. If, again, the current is greatly increased, contraction is only produced on closing the descending current and on opening an ascending current. This is to be explained by the fact that with very strong currents the entire intra-polar portion of the electrotonic nerve is incapable of conducting an impulse, and, as a consequence, ascending currents can cause only an opening contraction. These results may be expressed in the following table, in which R = rest, C = contraction :—

	Ascending.		Descending.	
	On Closing.	On Opening.	On Closing.	On Opening.
Weak,	. C	. R	. C	. R
Medium,	. C	. C	. C	. C
Strong,	. R	. C	. C	. R

IV. GENERAL PHYSIOLOGY OF THE NERVE-CENTRES.

The nervous system, as already indicated, consists of a combination of ganglion cells united together by nerve-fibres. The second element of the nervous tissue, or nerve-cell, is a mass of protoplasm supplied with a nucleus and nucleolus, from which originate at least two protoplasmic strands or nerve-fibres, which serve to bind the different elements of the nervous system together. Unfortunately, it is not possible to obtain as decisive results by experimentation as to the functions of the nerve-centres as may be determined as regards the nerve-fibres.

The properties of the central organs of the nervous system can, therefore, be only indirectly determined. The nerve-centres, by which is meant simply a collection of nervous ganglia, may be divided into two general classes; one group is located on the surface of the body, and it is adapted to the reception of stimuli originating in various external influences brought to bear on the body surface; the other group of nerve-centres is located in the central nervous system, so-called,—in other words, the spinal cord and brain, or the cerebro-spinal axis. In addition

to these two groups various so-called sporadic ganglia are also to be found in different parts of the body, whose functions, while in the main of the same character as all nerve-cells wherever found, differ according to the functions of the organs with which they are in connection; they will subsequently receive attention.

The external ganglia, or the so-called nerve-corpuseles, vary in character according to the nature of the stimulus which it is their function to receive. They may be distributed over the skin surface and are fitted for recognition of tactile and thermic changes, or they may be specialized for receiving special sensations; in such cases they constitute the organs of special sense.

In addition to these terminals of nerves, which, it will be recognized, are simply in connection with afferent nerves, another set of nerve-corpuseles is in connection with the peripheral terminations of the motor nerves and act as organs of distribution for motor impulses. In this group fall the nerve-plates on the voluntary muscles and the ganglionic cells in the walls of the intestinal tube.

The central nervous ganglia, located in the cerebro-spinal axis, possess the power of developing, *first*, reflex action; *second*, automatism; *third*, inhibition; *fourth*, augmentation; *fifth*, co-ordination. These will be alluded to in detail.

Nervous centres are capable of receiving impulses brought to them through afferent nerves, multiplying them, and reflecting the impulses so changed through an efferent nerve. A reflex action, therefore, requires for its expression an afferent nerve, starting from some receptive surface, some stimulus applied to that receptive surface, a nervous centre, and an efferent nerve.

1. REFLEX ACTION.—Reflex actions may occur in a number of different ways. The impulse reaching the centre through a sensory nerve may be reflected through a motor nerve and produce muscular contraction. Such muscular movements, occurring reflexly as the result of stimuli, are entirely involuntary and independent of the will. Such reflex actions are almost innumerable and form an important part of the organic acts of a living animal. As examples may be mentioned the involuntary weeping which almost instantly follows the applications of a stimulus to the conjunctiva, the movements of the limbs which occur on tickling the soles of the feet during sleep, movements of vomiting which occur when the soft palate or pharynx are mechanically irritated, coughing following irritation of the laryngeal or tracheal mucous membrane, and a large number of other movements (Fig. 331).

The spinal cord offers the best example of the production of reflex motor actions, and, in fact, reflex action may be said to be the main function of the spinal cord and its ganglionic cells may be regarded as

collections of reflex centres. The special characters of reflex action as produced by the conduction of a stimulus through the spinal cord will subsequently receive attention more in detail. At present a general outline of the production of such reflex action is all that is needed.

If in an animal the cerebrum be removed by section from the spinal cord,—and such an experiment may be best performed on a cold-blooded animal,—stimuli applied to varying parts of the body surface will result in the production of muscular movement. If in a frog the cerebrum be removed by a section forming a tangent to the anterior part of the tympanic membrane, the frog will apparently be in a normal condition, as far as its posture is concerned. If after the shock of the operation has passed away the toe of such a frog be pinched, the animal will jump; or, in other words, conduction of the sensory impulse to the spinal cord is reflected in the complicated co-ordinated movement of jumping. It is evident, therefore, that the sensory impulse is not simply reflected from the nerve-cell, but that, reaching the nerve-cell, it may there be converted into afferent impulses which may be of the most complex character.

Coughing and sneezing, also, are illustrations of this statement, where the slightest mechanical irritation of various parts of the respiratory mucous membrane may produce complex muscular movements which are out of all proportion in their complexity and vigor to the afferent impulses which inaugurate them. While this is, however, to a certain degree true, within limits the nature of the efferent impulse is dependent upon the nature of the afferent impulse.

If after removing the cerebrum from a frog the flank of the animal be gently stroked, muscular movement will occur simply as feeble twitching of the muscles at the point of stimulation. If the stimulus be increased in intensity the neighboring muscles are also implicated, and a still further increase in severity in irritation may lead to the implication of nearly all the muscles of the body.

A connection may also be recognized between the locality of stimulation and the nature of the resulting movement; thus, stimulation of the larynx will invariably cause coughing; of the mucous membrane of the nostril, sneezing; of the mucous membrane of the eye, weeping and lachrymation, or, to go back to the lower animals, reflex action following from a stimulus applied to the skin of the brainless frog will be so adapted as to remove the irritating body. Thus, if a scrap of paper moistened with acid be placed on the right flank of a frog, the

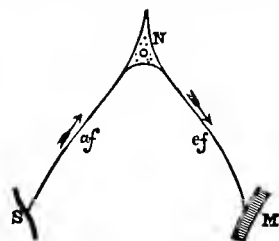

FIG. 331.—SCHEME OF A REFLEX ARC. (Landois.)  
S, skin; M, muscle; N, nerve-cell, with *af*, afferent, and *ef*, efferent, fibres.

right foot will be gradually drawn up and swept over the point of stimulation to remove the stimulus. The apparently purposeful character of such an action is still more strongly manifested if in such an experiment the right foot be firmly held; after a few ineffectual contractions of the muscles of the right leg the left leg will then be drawn up to remove the offending body. In all cases, therefore, except in those of the very simplest character, the resulting motion produced reflectively from a stimulus is out of all proportion in complexity to the nature of the stimulation. This complexity is much more marked when the stimulus is applied to the terminal corpuscles of sensory nerves, as in the case above alluded to.

If the stimulation be applied to a sensory nerve-trunk the character of the resultant reflex action is, as a rule, of simpler character; or, at least, is to a certain extent free from the apparent purposeful character noticed above. Thus, for example, if an induced current be applied to the central end of a divided sciatic nerve general convulsive movements are produced, but no apparently co-ordinate attempt to remove the stimulus can be detected, even with the employment of the weakest current. It, therefore, is evident that the character of the reflex action depends upon the nature of the locality of application and intensity of the afferent impulses.

2. AUTOMATISM.—By automatism is meant the power possessed by nerve-centres of apparently originating nervous impulses. It is, however, difficult to draw a line between so-called automatic action and reflex action. Thus, the act of respiration, which is a favorable example of the so-called automatic action, is in all probability due to, or, at any rate, largely governed by, the character of the impulses brought to that centre through the various afferent nerves. So, again, the regulation of the calibre of the blood-vessels, which is controlled by the automatic power of the vaso-motor centre, is again largely modified by the nature of the afferent impulses brought to it.

The clearest example of pure automatic action is to be found in the pulsations of the excised heart. As was seen in the chapter on circulation, the heart might be removed from a cold-blooded animal and yet preserve for many hours its power of rhythmical contraction, and it was demonstrated that such automatic action was the result of the function of the nervous ganglia found in the heart.

So, also, the movements of the alimentary canal were described as of an automatic character, for although their character is influenced by the contents of the intestinal tube, just as the movements of the heart might be influenced by various afferent impulses, the movements of the intestine may occur in an empty condition of the bowel or they may be absent when the canal is filled. In the spinal cord, therefore, centres

arc found which are capable of regularly and rhythmically governing complex movements, and, to that extent, it is automatic: the brain, however, as the seat of mental activity, perception, volition, thought, and memory, is the highest expression of the automatic functions of nervous centres. The automatic functions of the cerebrum will subsequently receive consideration in detail.

3. **INHIBITION.**—In a number of examples which were given as illustrations of reflex action, as is well known, the will by its exertion may prevent the appearance of the ordinary reflex result of the stimulus. Thus, for example, touching the eyeball tends to result in the production of winking; touching the throat, movements of vomiting and coughing; tickling the soles of the feet, contractions of the muscles of the legs. All of these, as is well known, may be controlled by a voluntary impulse.

One of the clearest illustrations of such inhibition of reflex action and of its development by education is seen in the mechanism of defæcation. In the lower animals defæcation is a purely reflex action and, as was described, results from the contact of the fæcal mass with the mucous membrane of the rectum.

In infants, likewise, the same state of affairs occurs. By education the will-power is capable of inhibiting the operations which result in defæcation, or, in other words, checking the action of the nerve-cells which control the co-ordinated movements in this process.

A number of other illustrations might be given, of which, perhaps, the clearest instance is seen in the action of the heart.

If the pneumogastric nerve be stimulated in an animal in whom the heart is beating in a normal manner with an interrupted current, the heart is almost immediately slowed and may even be brought to a stand-still; such a result is explained by the statement that the pneumogastric contains cardio-inhibitory fibres whose stimulation arrests the automatic action of the motor ganglia of the heart.

4. **AUGMENTATION.**—In contradistinction to inhibition an afferent impulse may increase action of nerve-centres. Thus, for example, the vaso-motor centre located in the floor of the fourth ventricle controls the calibre of the blood-vessels and keeps their walls in a state of contraction. The action of the vaso-motor centre may, however, be augmented through various afferent impulses, the most striking of which is seen in the great increase of blood pressure which follows stimulation of sensory nerves in curarized animals.

5. **CO-ORDINATION.**—By this term is meant the power possessed by the cells of the central nervous system of combining complex muscular movements ordinarily of a reflex nature. Thus, for example, the act of deglutition necessitates co-ordinate action of a large number of different

groups of muscles, which must in their contraction follow each other in a certain definite sequence; so, also, the act of coughing requires the association of a number of different muscular movements. Numerous other illustrations might be given of the combination of complex movements which are governed by so-termed co-ordinating centres; that is, a collection of ganglia located, usually, in the spinal cord or medulla oblongata which govern certain specific movements.

#### V. THE FUNCTIONS OF THE SPINAL CORD.

The spinal cord is contained within the vertebral canal and is composed of white matter externally and gray matter internally, inclosed in membranous sheaths of which the pia mater is adherent to the white

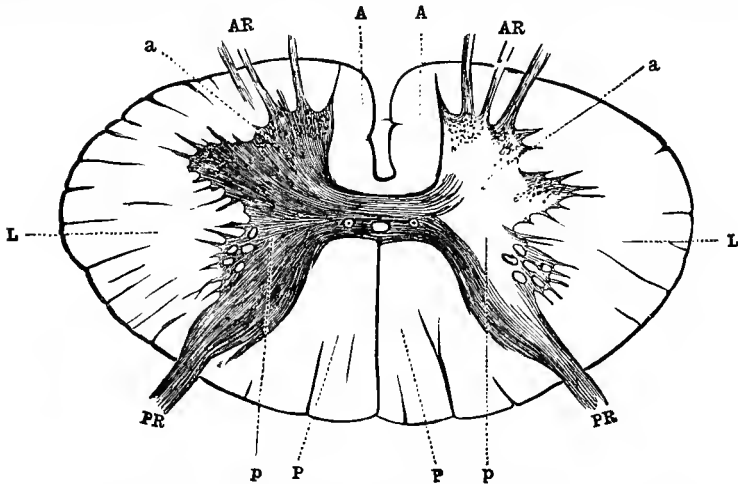

FIG. 332.—TRANSVERSE SECTION OF THE SPINAL CORD. (*Landois.*)

In the centre is the butterfly-form of the gray matter surrounded by white matter. p, posterior, and a, anterior horns of the gray matter; PR posterior roots, AR anterior roots of a spinal nerve; A A the white anterior, L L the lateral, P P the posterior columns.

matter; externally is found the dura mater, which lines the vertebral canal and forms a protective coat for the cord, while between the two is found the arachnoid membrane.

The white matter of the spinal cord is composed of nerve-fibres arranged longitudinally and divided into the so-called anterior, lateral, and posterior columns by the passage of the roots of the spinal nerves. The anterior fissure is a depression which separates the two anterior columns of the cord, which are bounded, therefore, on one side by the fissure and on the other by the points of origin of the anterior spinal nerve-roots.

The anterior fissure does not extend down to the gray matter, which composes the centre of the cord, but is separated from it by the white commissure.

Between the origins of the anterior and posterior nerve-roots are found the lateral columns, while the posterior columns are found between the origin of the posterior nerve-roots and the posterior fissure, which is deeper than the anterior, extending completely down to the gray matter, and filled up by an inner layer of pia mater (Fig. 332).

In certain regions of the cord each posterior column may be subdivided into an inner part lying next the fissure, the *postero-median*, or column of Goll, and a larger part next the posterior nerve-roots, the *postero-external* or column of Burdach.

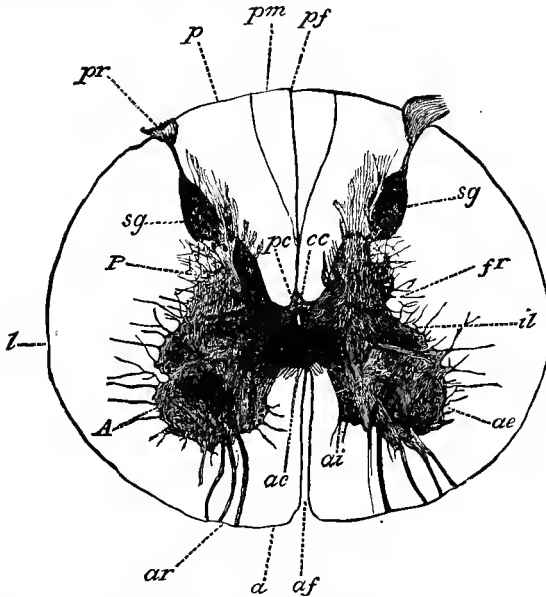

FIG. 333.—TRANSVERSE SECTION OF THE SPINAL CORD IN THE CERVICAL REGION, AFTER BEVAN LEWIS. (Yeo.)

*A*, anterior gray column; *a*, anterior white column; *l*, lateral white column; *ac*, anterior commissure; *ar*, anterior roots; *af*, anterior median fissure; *il*, intermedio-lateral gray column; *cc*, vesicular column of Clarke; *P*, posterior gray column; *p*, posterior white column; *pm*, posterior median column; *pc*, posterior commissure; *cc*, central canal; *pr*, posterior roots; *pf*, posterior median fissure; *ae* and *ai*, external and internal anterior vesicular columns; *sg*, substantia gelatinosa.

The white matter of the spinal cord is composed of medullated fibres, in which the sheath of Schwann is absent, arranged for the most part longitudinally. The nerve-fibres of the nerve-roots have an oblique course, passing from the gray matter through the columns to form spinal nerves; transverse fibres, also, are found, which unite the different columns of the spinal cord and connect the gray matter with the columns of the cord.

The gray matter is composed of collections of nerve-cells arranged in the form of two crescents, the convex surfaces of which are united by the gray commissure. In the centre of the gray commissure runs the

central canal, which passes from the floor of the fourth ventricle downward and is lined by a layer of cylindrical epithelial cells.

The cells of the gray matter of the spinal cord differ greatly in size, those in the anterior horn being much the largest. The gray matter is, also, like the white matter, arranged in columns, although the distinction between these columns may be less readily demonstrated. Thus, the anterior and posterior horns form the anterior and posterior gray columns, while between the two lies the lateral column.

The distribution of white and gray matter varies in shape in different portions of the spinal cord. In the cervical region the lateral white columns are large, the anterior horn of the gray matter is wide and

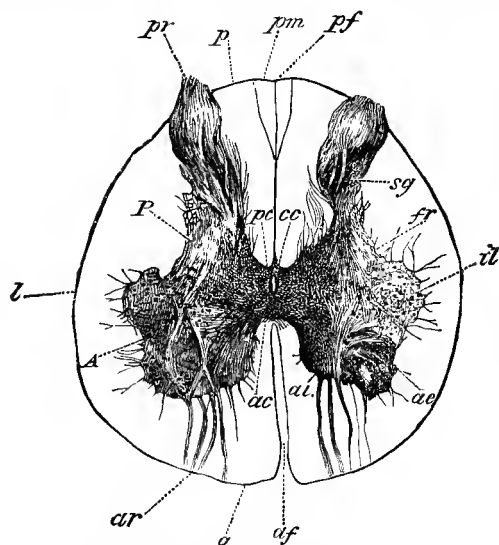

FIG. 334.—TRANSVERSE SECTION OF THE SPINAL CORD IN THE LUMBAR REGION, AFTER BEVAN LEWIS. (Yeo.)

(For references see description under Fig. 333.)

large, while the posterior horn is narrow and the transverse diameter of the cord is the longest (Figs. 333, 334 and 335). In the dorsal region both cornua are narrow and of nearly equal breadth, while the cord is smaller and cylindrical.

In the lumbar region the gray matter is largest in amount, while the lateral columns are small and the central canal is nearly in the middle of the cord.

As a rule, the anterior horn of gray matter is shorter and broader, and does not extend so near to the surface of the cord as does the posterior horn, which is more pointed, longer, and narrower, and usually extends nearer to the surface.



The spinal cord is not only the path of conduction of nerve impressions from the periphery of the brain and the reverse, but is also the seat of a large number of nervous centres which are capable of acting as reflex centres, or even of originating impulses.

The functions of the spinal cord are, therefore, to be considered—*first*, as a collection of nerve-centres, and, *second*, as a conductor of afferent and efferent impulses.

(a) *The Spinal Cord as a Collection of Nerve-Centres.*—It has been already stated that reflex action requires for its performance afferent and efferent nerve-fibres and a nerve-centre, and the spinal cord has been mentioned as the main seat of the centres of reflex action.

When the spinal cord is divided in an animal, the application of a stimulus to its skin produces muscular movements of the most diverse kinds, depending, as already indicated, upon the nature, intensity, and the locality of the stimulus.

The histology of the spinal cord indicates that, from the direct communication of the posterior roots (which have been found to be paths of conduction of sensation) through the gray commissure with the anterior roots (which have been found to be the paths of motor impulses), afferent impulses reach the spinal cord through the sensory nerves and are directly conducted to nerve-centres, which again are in communication with motor nerves. It is, therefore, evident that afferent impulses are brought directly to nerve-cells, which again communicate the modified nerve impulse to motor nerves (Fig. 336). In the spinal cord such centres of reflex action may be

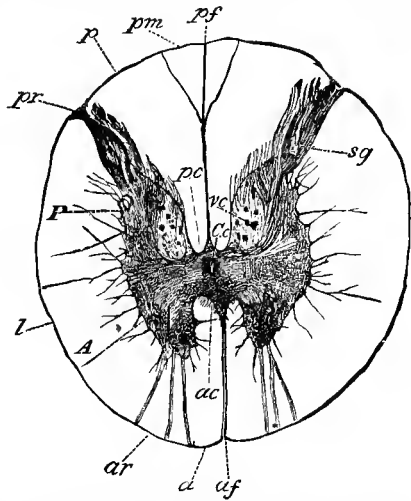

FIG. 335.—TRANSVERSE SECTION OF THE SPINAL CORD IN THE DORSAL REGION. AFTER BEVAN LEWIS. (*Yeo.*)  
(For references see description under Fig. 333.)

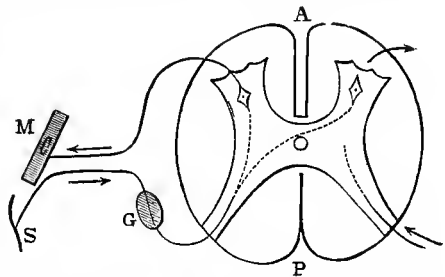

FIG. 336.—SECTION OF A SPINAL SEGMENT, SHOWING A UNILATERAL AND CROSSED REFLEX ACTION. (*Landois.*)  
A, anterior, and P, posterior surfaces; M, muscle; S, skin; G, ganglion.

readily proved by the entire failure to evoke reflex movements after destruction of the cord. Thus, while reflex movements are produced with the greatest readiness in frogs in whom the cerebrum has been removed, if the spinal cord be then disorganized by passing an instrument down the vertebral canal all reflex movements are then impossible, even although the nerves possess their power of conductivity and the muscles their power of contraction.

To appreciate the functions of the spinal cord as a collection of centres for producing reflex action we have only to recall the statements made on the nervous system as met with in the lowest articulates, in which we have a collection of nervous matter, ganglionic in its nature and comparable to the medulla spinalis of vertebrates, with afferent fibres running to and efferent fibres running from these ganglia. Such a type of nervous system is seen in the star-fish. If an irritation be applied to an extremity of the limb of a star-fish a sentient impression is conducted along the sensory nerve to the ganglionic centres, and a motor impulse goes out along the motor nerve and contraction of the muscles supplying the body results. So, if a decapitated centipede be placed upon the ground it begins to make forward locomotive efforts as soon as the impression is made upon the sentient extremities of the nerves distributed to its feet; this impression is conveyed to the spinal ganglia, and motor impulses are sent out along each one of the legs and locomotion results. If it comes in contact with an obstacle, however, as high as itself it will mount over it, but if higher it will butt against it its decapitated extremity until all nervous force is exhausted, when it becomes quiet. Still more striking phenomena are present when, after decapitation, the remainder of the body be cut in two; if then the halves of the body be placed upon the ground locomotive efforts will continue in each, but they will not be harmonious. All these movements depend upon physical excitation, and in some instances they require to be excited by the elements in which the animal naturally moves. Thus, if we take a decapitated water-beetle and place it upon the floor no motion results, but place it in water and it begins to move with vigor. The above are examples of reflex action, and result from excitation of sentient surfaces and the conduction of that irritation to a nervous ganglion, and the reflection of that stimulation through a motor nerve.

It has been mentioned that the impulses reaching the cord through a single sensory nerve may spread to the adjacent receptive ganglia, and so lead to the transmission of motor impulses through a number of different motor nerves. Ordinarily the degree of reflex action is in proportion to the stimulus.

Under certain conditions the irritability of the spinal cord may be so modified that a gentle stimulus may produce excessive stimulation of

the motor ganglia of the cord, and so produce violent convulsive movements; or the receptivity of the cord may be obtunded through disease or through the action of various poisons, and the most violent stimulus now fail to evoke any reflex action. As an example of the first condition strychnine furnishes a most striking illustration.

If a frog be poisoned with strychnine and the cerebrum removed, a degree of stimulation which otherwise would produce but a feeble or perhaps even no reflex action now produces tetanic contractions. Such a result indicates that in the spinal cord every sensible fibre is in direct communication through the gray substance with every motor fibre.

In the frog at breeding seasons the spinal cord is in a physiological state of overexcitation; the frog is found at this time clinging obstinately to pieces of bark or stone, just as it does to the body of the female in the act of copulation. Such a condition may be produced by gentle stimulations of the skin of the sternum and of the thumb of the frog, in which an increase of sensibility exists. Here the result is to be attributed not only to the increased receptivity of the spinal cord, but also to the increased sensitiveness of the receptive surfaces.

In the normal condition of animals, whether mammals or cold-blooded animals, in whom the brain has been separated from the spinal cord, reflex action only takes place through the application of irritants of a certain intensity and a certain duration.

Single electric shocks as a rule produce no result, but if repeated sufficiently often produce a reflex action; such single impulses are conducted to the spinal cord and there become added to each other by what is known as a process of summation until a maximum result is attained. If, then, the number of stimulations per second be increased or the degree of stimulation be made more severe no further increase in the reflex action is possible.

Pflüger has formulated the following laws of reflex action:—

1. The reflex movement occurs on the same side on which the sensory nerve is stimulated, while only those muscles contract whose nerves arise from the same segment of the spinal cord.

2. If the reflex occur on the other side only the corresponding muscles contract.

3. If the contractions be unequal upon two sides, then the most vigorous contractions always occur on the side which is stimulated.

4. If the reflex excitement extend to the other motor nerves, those nerves are also affected which lie in the direction of the medulla oblongata.

5. All the muscles of the body may be thrown into contraction. (Landois.)

In the human body are found mechanisms which may inhibit or

control reflex action, before mentioned, as produced after a mechanical irritation of the conjunctiva. Tickling of the feet leads to an inclination to movement; this also is a reflex action, and, as is well known, such a movement may, by an exertion of the will, be suppressed, such a suppression being an inhibition of reflex action. This voluntary control of reflex action may be educated to a certain extent, but only within certain limits.

If the stimulus be severe and frequently repeated reflex action occurs in spite of the effort of the will to prevent it. On the other hand, numerous reflex actions are entirely beyond the control of the will; thus the contraction of the iris and parturition are reflex actions over which the will has no control.

It may be demonstrated by experiment that a spinal nervous mechanism exists for the purpose of keeping reflex action in control. If the cerebrum be removed from a frog on a line with the anterior edges of the tympanic membrane reflex action may be readily produced.

The best method of studying the influence of different agents on the production of reflex action is that of Türck, of Vienna.

The frog, from which the cerebrum has been removed, should be suspended vertically by the nose, and if after the shock of the operation has passed away the tip of one toe be dipped in a solution of sulphuric acid it will be rapidly withdrawn; the duration of immersion before the foot is withdrawn may be taken as indicating the degree of reflex activity of the spinal cord. After each immersion the foot should be dipped into distilled water, so as to wash off the excess of acid and prevent constant corrosion of the skin. If the time be determined which elapses before the foot is withdrawn from the acid in the frog from whom the cerebrum has been removed, and the cerebro-spinal axis be then again divided on a line tangent to the posterior borders of the tympanic membranes and the toe be again immersed in acid, it will now be found that the foot is withdrawn after a much shorter interval than in the previous experiment. This result would indicate that in some portion of the cerebro-spinal axis between the lines of the two incisions is located a mechanism which has for its function the controlling of reflex action.

If in another frog the cerebrum be removed and the time of immersion in the acid determined before reflex action takes place, and now one of the optic lobes be exposed and irritated, as by placing a crystal of common salt in contact with it, it will be found that the frog will retain its foot in the acid for a much longer time than before, or may even entirely fail to remove it. That this result is due to the stimulation of the inhibitory apparatus and not to a paralysis of reflex mechanism is proved by the fact that if the spinal cord be now divided below the medulla oblongata the foot will be as promptly withdrawn, or even more

rapidly, from the acid than before; such a mechanism is spoken of as Setschenow's inhibitory centre.

Reflex action may, likewise, be inhibited by stimulation of sensory nerves. As an example of this may be mentioned the familiar experience of our ability to arrest a sneeze by compressing the skin of the nose over the exit of the nasal nerve.

Reflex action does not take place when strong electrical irritation is applied to the trunk of a sensory nerve, but tetanus results; while, on the other hand, a much weaker stimulation of the skin, either chemical or mechanical, will readily produce reflex movement. This would, perhaps, indicate that, together with the sensitive fibres, inhibitory nerves pass in the trunks of the nerve to the spinal cord.

The reflex functions of the spinal cord may be looked upon as one of the preservative influences of the animal body, guarding all the inlets and outlets of the economy. Through it the movements of respiration are permitted to occur during the hours of sleep and waking. Let this reflex action be lost in the medulla, and respiration ceases, the contents of the rectum are involuntarily evacuated, the useful operation of winking, by which the conjunctiva is kept moist and the eye is protected, is lost, and the acts of coughing and sneezing, so important for removing foreign substances, would be alike impossible.

The movements of the intestinal canal, although not entirely dependent upon reflex action, are in a certain degree due to it. Many of the phenomena which we consider as voluntary may be classed among those which are reflex in their nature, as when, in walking, we may unconsciously pass around an obstacle in our path, or unconsciously perform many acts which are apparently purely voluntary in nature.

As already mentioned, reflex actions are not solely motor in nature, but may result in the production of changes in secretion, in the distribution of blood to a part, or in changes in nutrition. Illustrations of excito-secretory phenomena are very numerous.

If we touch the tongue with irritating or sapid substances the secretion of saliva begins to flow through the instrumentality of the lingual nerve; the impression is conveyed to the medulla oblongata, whence an efferent impulse is emitted through the chorda tympani, as a result of which the blood-vessels supplying the submaxillary gland are dilated and an increased flow of saliva is produced. It has also been found that if we stimulate the oral cavity the gastric secretion is poured out in large quantities, indicating the action of condiments and spices in conditions of feeble digestion.

The reflex vaso-motor results are clearly evident as examples of reflex action. If a sensory nerve is stimulated the tonic action of the vaso-motor centre is increased, and the blood-vessels of the body are

contracted through the reflection of that impulse from the spinal cord through the efferent vaso-motor nerves to the muscles composing the walls of the arterioles. In vaso-motor reflex action phenomena of inhibition are likewise capable of demonstration. Thus, the vaso-motor centre in the body, which is a purely reflex centre, may be inhibited by stimuli passing through certain nerves. If the so-called depressor nerve be stimulated the vaso-motor centre in the medulla is inhibited and dilatation of the blood-vessels ensues, as is evidenced by the great fall of blood pressure. So, also, certain nerves when stimulated lead to a dilatation of the blood-vessels by inhibition, in all probability, of the ganglia contained within their walls. Such a reflex inhibition of vaso-motor action is seen in the case of the chorda tympani, already referred to, in the reflex stimulation of the *nervi errigentes*, and a number of other instances.

As an example of changes in nutrition due to reflex action, illustrations are not as readily found; what is spoken of as sympathy is an example, however, of changes in nutrition of reflex nature. Surgeons are well aware that when disease of an inflammatory character exists in one eye it is not unusual to find the eye of the other side becoming affected in a similar manner, purely in a reflex manner; as a proof of this may be mentioned that extirpation of the diseased eye is almost invariably followed by a cure of the disease in the remaining one. So, also, section of the supraorbital branch of the fifth pair of nerves leads to disturbances in the cornea which are of a nutritive character and which are probably due to some disturbances of the reflex control of nutrition.

It has been already mentioned that in the spinal cord are located a number of collections of cells which have for their function the control of certain complicated co-ordinate movements; such centres exert their action in a reflex manner by the modification which they produce on the afferent impulses brought to them. These centres retain their activity even after the spinal cord has been removed from the medulla by section, but all are to a certain extent controlled by the action of higher reflex centres found in the medulla oblongata and cerebrum.

The following represents the most important of these collections of nerve-centres:—

*First*, vaso-motor centres which control the calibre of the blood-vessels are found in the floor of the fourth ventricle of the medulla oblongata and distributed throughout the entire spinal axis, as is evidenced by the fact that the dilatation of the blood-vessels which follows division of the spinal cord below the medulla is only transitory, the blood-vessels regaining their normal tone as the shock of the operation passes off. If, however, the spinal cord be entirely destroyed, the blood-vessels become then permanently paralyzed.

It is probable that in the cerebro-spinal axis are likewise found

vaso-dilator centres. It thus appears that the calibre of the blood-vessels in the body is regulated by a collection of centres located in the central nervous system.

*Second*, the cilio-spinal centre; this collection of nerve-cells is located in the lower cervical portion of the cord; its functions will be again alluded to. The other centres, as of defæcation, micturition, etc., have been already mentioned.

(b) *The Spinal Cord as an Organ of Conduction.*—It has been seen in the consideration of reflex action that modes of communication exist between the different nerve-cells in the spinal cord. It is also evident that in the spinal cord must exist paths of conduction of sensory impulses reaching the cord through the posterior roots of the spinal nerves to the brain, and of the conduction of motor impulses from the brain through the anterior spinal roots to the muscles. For when the spinal cord is divided, or when it is altered by disease or injury, the parts which receive their nerves from the portion of the spinal cord situated below that part are paralyzed, both as regards sensation and motion. Impressions made upon these parts are no longer appreciated and voluntary movements can no longer occur in them, even although reflex action may still be present. When the spinal cord is divided above the points of origin of the nerves coming to the muscles of respiration, respiration is interfered with; thus, if the spinal cord is divided between the last cervical and the first dorsal vertebræ, all the respiratory muscles, with the exception of the diaphragm, are paralyzed. If the spinal cord is divided above the origin of the phrenic nerve, then the diaphragm is likewise paralyzed and death occurs from asphyxia. From these facts it is evident that the spinal cord is the means of communication between the exterior and the brain, and we have now to consider the paths which different impulses follow in passing from the centre to the periphery and the reverse.

In the first place, it would be scarcely conceivable that the irritation from any localized portion of the skin surface could communicate a definite localized sensation to the brain if the afferent impulse was compelled to travel through the labyrinthine communications of the gray cells of the spinal cord. Nor, again, could we suppose that a single muscle could be thrown into contraction by the will by passing through the same complicated net-work of cells and fibres. It would be much more natural to look for the paths of communication between the voluntary muscles and the brain on the one side and the sensory end organs and the brain on the other in the white columns of the cord. It does not follow from this fact that the spinal cord may be regarded as a bundle of white fibres connecting the periphery with the brain. Were this the case we should expect that the spinal cord would increase in

size in proportion to the number of nerves entering into it; and that, therefore, the spinal cord should be largest in the cervical portion and gradually taper down to a point in the lumbar region, as if each spinal nerve were a direct loss to the fibres of the spinal cord. Such is not, however, the fact.

Sections of the spinal cord taken at different parts of its length indicate that the gray matter of the cord increases with the amount of nerve-fibre passing into each part of the cord, and that, therefore, the largest amounts of gray matter are found in the lumbar and cervical regions at the points of origin of the nerves for the lower and upper extremities; while, if the proportionate area of the lateral columns is compared, it will be found that there is a steady increase in the sectional area of this portion of the cord from the lumbar to the cervical region. This fact would indicate that the latter regions are the main paths of conduction between the brain and the periphery. The proportion between

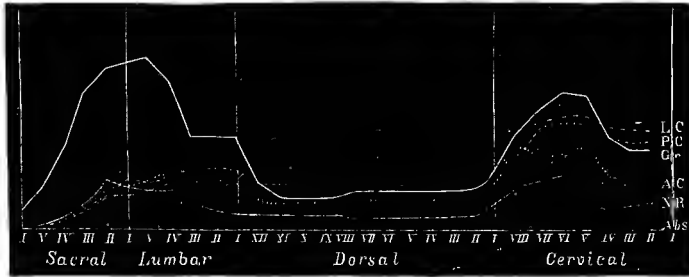

FIG. 337.—DIAGRAM OF THE ABSOLUTE AND RELATIVE EXTENT OF THE GRAY MATTER AND OF THE WHITE COLUMNS, IN SUCCESSIVE SECTIONAL AREAS, AS WELL AS THE SECTIONAL AREAS OF THE NERVE-ROOTS. (Landois.)

N R, nerve-roots; A C, L C, P C, anterior, lateral, and posterior columns; Gr, gray matter.

different parts of the spinal cord in the different regions and the different areas of the spinal nerves are indicated in the diagram (Fig. 337).

In addition to the anatomical division, already alluded to, into anterior, lateral, and posterior columns, the white fibres of the spinal cord have been divided into several secondary columns, according to their functions. In addition to the experimental method, to be alluded to directly, this grouping of the longitudinal fibres of the spinal cord into different systems has been reached through facts acquired through the study of the degeneration of certain parts after specific injury and through the developmental history of the cord in the embryo. Thus, injury of certain parts of the brain is followed by a *secondary descending degeneration* of certain nerve-fibres (Türk); section of the cord causes *ascending degeneration* of certain fibres (Schieferdecker); and Flechsig showed that the fibres of the brain and cord in the embryo became



covered with myelin at different periods of development, those receiving their myelin last which had the longest course. On the data obtained by this method Flechsig mapped out the following system (Landois):—

1. In the anterior column lie the (a) *uncrossed, or direct pyramidal tract* (a in Fig. 338), and, external to it, (b) the *anterior ground-bundle, or anterior radicular zone*.

2. In the posterior column he distinguishes (c) Goll's column, or the *postero-median column*, and (d) Burdach's *funiculus cuneatus*, the *posterior radicular zone, or the postero-external column*.

3. In the lateral columns are (e) the *anterior* and (f) the *lateral mixed paths*, (g) the *lateral or crossed pyramidal tract*, and (h) the *direct cerebellar tract*. The relations of these fibres in the cervical region are shown in Fig. 339.

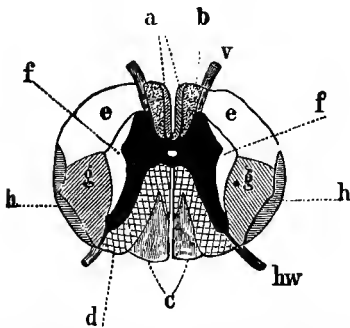

FIG. 338.—SCHEME OF THE CONDUCTING PATHS IN THE SPINAL AT THE THIRD DORSAL NERVE, AFTER FLECHSIG. (Landois.)

The black part is the gray matter. v, anterior, hw, posterior roots; a, direct, and g, crossed pyramidal tracts; b, anterior column ground-bundle; c, Goll's column; d, postero-external column; e and f, mixed lateral paths; h, direct cerebellar tracts.

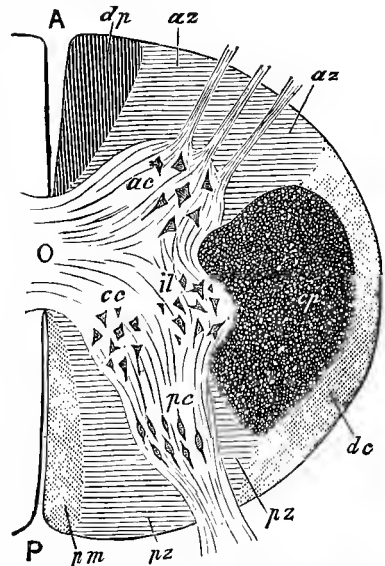

FIG. 339.—SECTION OF THE CERVICAL PORTION OF THE SPINAL CORD, SHOWING BY DIFFERENCES OF SHADING THE WHITE TRACTS SUPPOSED TO BE FUNCTIONALLY DISTINCT. (Yeo.)

A, anterior, P, posterior median fissures; dp, direct pyramidal, cp, crossed pyramidal tracts; dc, direct cerebellar, pm, posterior median column (Goll); ac, anterior, pz, posterior root-zones.

Of these columns, as we shall find directly, the pyramidal tracts may be traced to the anterior pyramids of the medulla oblongata, where each lateral pyramidal tract crosses to the opposite side, through the pons to the middle third of the crusta, thence to the internal capsule, where they diverge like the rays of a fan through the white matter of the cerebrum to the central convolutions.

The direct cerebellar fibres may be traced to the cerebellum, reaching it through the restiform body from Clarke's column of gray cells, thus directly connecting part of the fibres of the posterior roots with the cerebellum.

The other systems of fibres terminate in the medulla oblongata, the column of Goll serving to connect part of the fibres of the posterior roots with the gray nuclei of the funiculi graciles of the medulla oblongata; and the column of Burdach the posterior roots through the restiform body with the vermiform process of the cerebellum, while the anterior and lateral mixed columns communicate with the *formatio reticularis* of the medulla oblongata.

Of these columns the pyramidal tract, the cerebellar tract, and the column of Goll are the only ones which steadily increase in size as the medulla oblongata is approached.

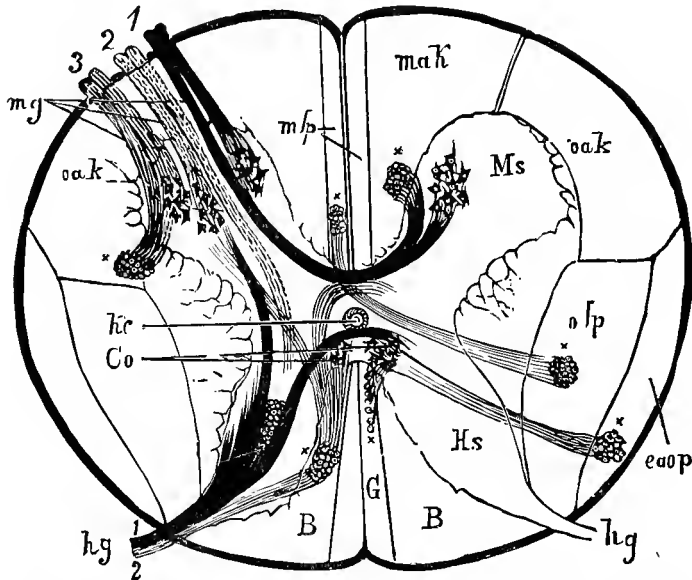

FIG. 340.—COURSE OF THE FIBRES IN THE SPINAL CORD, AFTER F. FLESCH. (Thanhoffer.)

*Ms*, anterior horn; *Hs*, posterior horn; *mg*, anterior root; *mg*, 1, 2, 3, fibrous bundles of the anterior root; *hg*, posterior root; *hg*, 1, 2, fibrous bundles of the posterior root; *mp*, direct pyramidal tract; *oip*, crossed pyramidal tract; *oak*, lateral ground-bundle; *eap*, direct cerebellar tract; *mak*, anterior ground-bundle; *hc*, central canal; *Co*, intermedio-lateral column of Clarke; *G*, funiculus gracilis of Goll; *B*, funiculus euneatus of Burdach; *x*, oblique bundles of fibres.

If we trace by means of the microscope the origins and terminations of the spinal nerves it will be found that the posterior roots of the spinal nerves pass through the white substance of the cord to reach the posterior gray column, in which they break up into fine twigs, uniting with the ganglia of the cord, although their mode of connection with the cells is not capable of ready detection. Having entered the cord, the fibres of the posterior nerve-roots are seen to divide into three different bundles.

The fibres of the anterior roots may likewise be divided into three

different bundles: 1. The median bundle, represented by the black line in the figure (Fig. 340), partly enters into direct union with the cells of the anterior horn, while part passes through the gray matter to enter the anterior commissure and pass to the opposite side of the cord, to terminate, in part, in the cells of the anterior horn on this side and partly to pass directly into the anterior white columns. 2. The central bundle of motor fibres passes in part through the anterior horn without forming any connection with its cells, to be lost in the posterior horn, where, in all probability, through union with ganglionic cells it is in communication with the fibres of the posterior roots; the other part of this bundle directly unites with the cells of the anterior horn. 3. The lateral bundle is likewise partly in direct communication with the gray matter of the anterior horn and partly runs up in the lateral columns of the cord (Fig. 341).

Further examinations of sections of the cord (right half of above figure) show that the *direct* and *crossed pyramidal* tracts of opposite sides of the cord are in communication by means of fibres passing through the gray substance into the anterior commissure, and that the direct cerebellar column communicates with Clarke's gray column and the latter with the column of Goll on the same side of the cord.

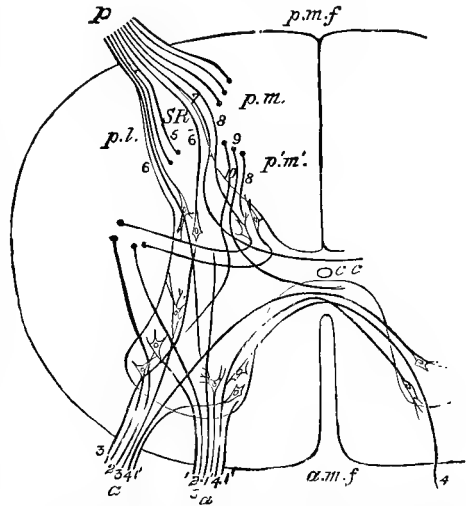

FIG. 341.—DIAGRAM ILLUSTRATING THE PATHS PROBABLY TAKEN BY THE FIBRES OF THE NERVE-ROOTS ON ENTERING THE SPINAL CORD, AFTER SCHÄFER. (Yco.)

*a.m.f.*, anterior median fissure; *p.m.f.*, posterior median fissure; *c.c.*, central canal; *SR*, substantia gelatinosa of Rolando; *a*, funiculi of anterior root of a nerve; *p*, funiculus of posterior root of a nerve. By following the fibres 1, 2, 3, etc., their course through the gray matter of the spinal cord may be traced.

Some of the fibres of the posterior roots pass upward in the posterior column. They thus form longitudinal commissures between the different ganglia and make up the greater part of the posterior columns. These commissural fibres are evidently concerned in upward conduction of sensations, for when the cord is divided they undergo ascending degeneration.

The lateral fibres from the posterior root ascend obliquely and divide in the posterior horn, with whose cells they, in all probability, communicate, though part of these fibres may be traced as far as the anterior horns. The inner bundle has been traced to the posterior commissure; its further course or termination is unknown.

It is thus seen that the white fibres of the spinal cord are not in direct communication with the nerve-roots, but only connect different segments of the spinal cord. In each segment of the spinal cord are to be found nerve-centres for the afferent and efferent nerves of definite regions of the body, and commissural fibres connecting that segment with other segments of the cord and with the brain (Fig. 342).

Leaving these anatomical considerations of the moment, we have now to examine the data as to the paths of conduction of motor and sensory impulses through the spinal cord attained through experiments performed upon the spinal cord. The method of such experiments consists in attempting to make isolated sections of different parts of the cord and determine the interference of function which results from such mutilations. The difficulty of such experiments is twofold: In the first

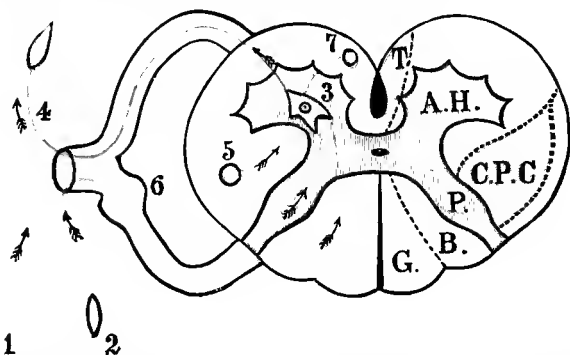

FIG. 342.—DIAGRAM ILLUSTRATING THE VARIOUS CHANNELS THROUGH WHICH A MOTOR CELL OF THE CORD MAY BE CALLED INTO ACTION. (Ranney.)

A.H. anterior horn; C.P.C. crossed pyramidal column; P. posterior horn; B. column of Burdach; G. column of Goll; 1, fibre for painful sensations; 2, fibre for tactile sensations; 3, motor cell; 4, motor fibres; 5, fibre from opposite cerebral hemisphere going to cell, 3; 6, ganglion on posterior nerve-root; 7, fibre from cerebral hemisphere of same side going to motor cell, 3.

place, it is difficult to separate the temporary result, due to the shock of the operation, and the permanent results; and, in the case of sensation in the lower animals, to distinguish between reflex action and purely voluntary movements. In the second place, it is almost impossible to make a section of any isolated portion of the spinal cord without more or less damaging the adjacent portions. Thus, for example, it is almost impossible to cut transversely the posterior white columns of the cord without at the same time more or less injuring the gray matter. This difficulty applies to isolated sections attempted on all parts of the spinal cord. Nevertheless, a number of valuable results have been obtained by this method.

In the first place, it has been found that section of the cord causes immediate loss of both sensation and motion in all parts supplied by

nerves which arise behind the point of injury, with temporary vaso-motor paralysis. The remote effects are secondary descending degeneration in the *crossed* and *direct pyramidal* tracts and ascending degeneration in the *postero-internal* columns. If the section is made on one lateral half of the spinal cord (hemisection) paralysis of voluntary movement and vaso-motor paralysis occur on the side of the operation in the parts below, with loss of sensation on the side opposite to the injury and increased sensitiveness on the side of operation, with the exception of a limited area of anaesthesia in the part supplied by the sensory nerves destroyed in the operation. There is also the usual ascending and descending degeneration, the former also appearing in the column of Goll on the opposite side.

If a longitudinal section is made through the posterior fissure of the cord in the median line, little if any loss of motion results (some fibres of the pyramidal tract cross in the anterior commissure), but a considerable reduction of sensibility. If the posterior white columns are divided there is considerable loss of the tactile, temperature, and muscle senses, although the sensation of pain may still be felt; no loss of motion results. If the antero-lateral columns of white fibres be divided there is a loss of voluntary motion in a corresponding part of the same side of the body. Such a loss of motion, provided the gray matter be not interfered with, is temporary, and indicates that the gray matter may take on the function of conduction, ordinarily carried on by the white columns, past the seat of injury.

The respiratory and vaso-motor fibres also pass through the antero-lateral white columns. If the gray matter and the posterior white columns be divided sensory or tactile impulses no longer reach the brain, showing that sensory impulses travel in these parts.

These facts would indicate that sensory impulses entering the posterior roots of the spinal nerves pass for a certain distance in the posterior columns and then cross over to the gray matter of the opposite side to ascend to the cerebrum in the lateral column in front of the pyramidal tract, while some may pass into the posterior column and others ascend in the gray matter; the fibres concerned in the conduction of "muscular sense" apparently do not decussate until the medulla is reached: or they may pass to the cerebellum by the *direct cerebellar* tract and posterior columns to the restiform body and thence to the cerebellum.

On the other hand, voluntary motor impulses after having crossed in the pons varolii and medulla oblongata descend in the antero-lateral columns of white fibres (*crossed pyramidal* tracts) to leave the cord through the anterior roots of the spinal nerves, after forming communication with the motor cells of the anterior cornua. The *direct pyramidal*

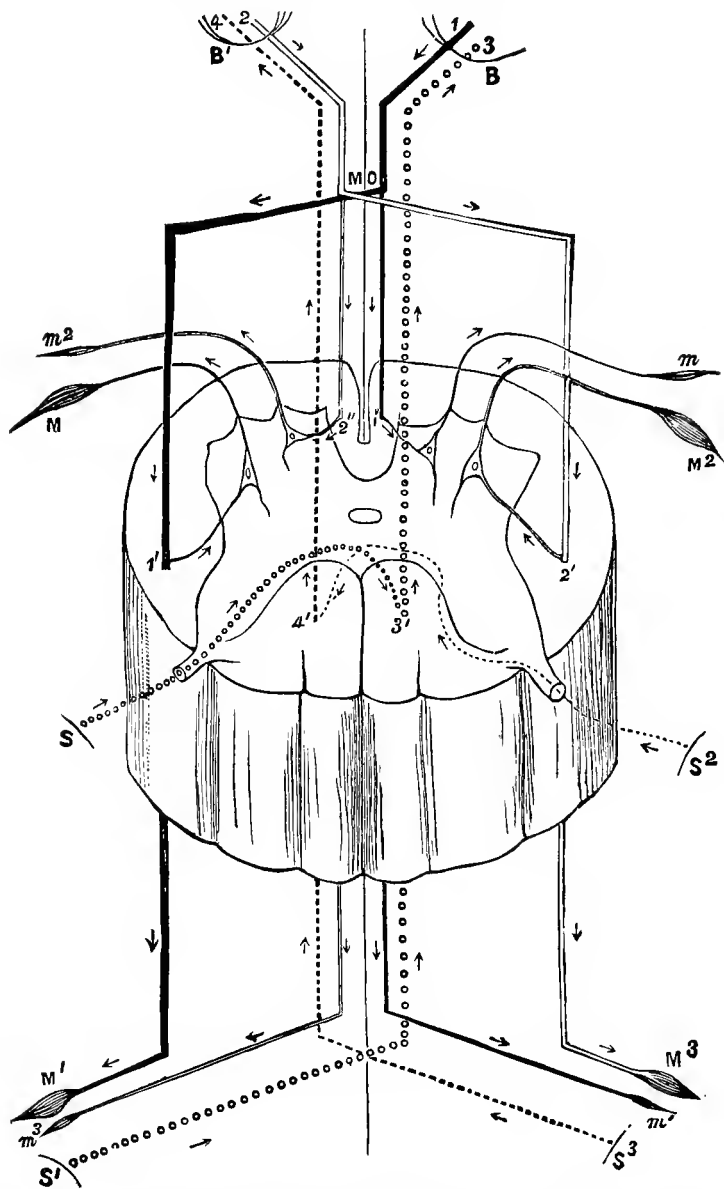

FIG. 343.—DIAGRAM OF A SPINAL SEGMENT AS A SPINAL CENTRE AND CONDUCTING MEDIUM, AFTER BRAMWELL. (*Landois*.)

B, right, B', left cerebral hemispheres; M O, medulla oblongata; 1, motor tract from right hemisphere, largely decussating at M O, and passing down the lateral column of the cord on the opposite side to the muscles M and M<sup>1</sup>; 2, motor tract from left hemisphere; S, S<sup>1</sup>, sensitive areas on the left side of the body; 3, 3', the main sensory tract from the left side of the body; it decussates shortly after entering the cord; S<sup>2</sup>, S<sup>3</sup>, sensitive areas, and 4', 4, tracts from the right side of the body. The arrows indicate the direction of the impulses.

tract descending in the anterior column may either supply the muscles which always act together on both sides of the body; or, according to other observers, they cross in the anterior commissure to join the lateral pyramidal tract (Fig. 343).

The paths of conduction of motion and sensation will again receive attention when the upward connections of the different columns of the cord have been traced.

VI. THE FUNCTIONS OF THE BRAIN.

In its earliest stage of development the brain simply consists of the dilated extremity of the medullary tube formed by the turning in of the medullary folds of the ectoderm. Almost immediately after the closure of the medullary canal its anterior termination is seen to become differentiated into three bilateral symmetrical vesicular dilatations, which are the starting points of the fore-, mid-, and hind-brain. From the fore-brain the cerebral lobes

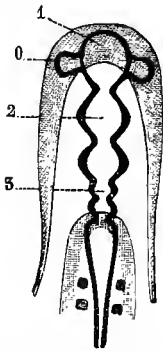

FIG. 344.—DIAGRAM OF THE CEREBRAL VESICLES OF THE BRAIN OF A CHICK AT THE SECOND DAY OF INCUBATION, AFTER CADUAT. (Yeo.)

1, 2, 3, cerebral vesicles; 0, optic vesicles.

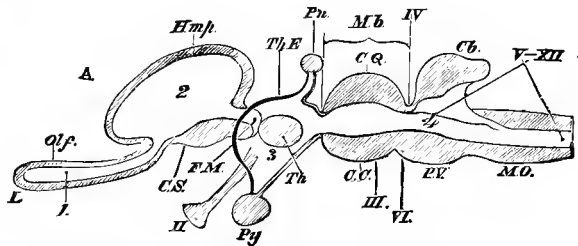

FIG. 345.—DIAGRAM OF A VERTICAL LONGITUDINAL SECTION OF A DEVELOPING BRAIN OF A VERTEBRATE ANIMAL, SHOWING THE RELATIONS OF THE THREE CEREBRAL VESICLES TO THE DIFFERENT PARTS OF THE ADULT BRAIN, AFTER HUXLEY. (Yeo.)

Olf, olfactory lobes; F.M, the foramen of Monro; CS, corpus striatum; Th, optic thalamus; Pn, pineal glands; Mb, mid-brain; Cb, cerebellum; M.O, medulla oblongata; Hmp, cerebral hemispheres; ThE, thalamencephalon; Py, pituitary body; C.Q, corpora quadrigemina; C.C, crura cerebri; P.V, pons varolii; I-XIII, regions from which spring the cranial nerves; I, olfactory ventricle; 2, lateral ventricle; 3, third ventricle; 4, fourth ventricle.

develop as two hemispherical vesicles (*prosencephalon*), which, in the brain of the highest mammals, so increase in size upward and backward as to cover more or less completely the remainder of the primary cerebral vesicle, the mid-, and hind-brain, so that the mid-brain, composed of the optic thalamus, corpora quadrigemina, and corpora striata (*mesencephalon*), lies beneath the hemispheres. From the hind-brain originate the cerebellum, pons varolii, and the medulla oblongata (*myelencephalon*). At first all these parts consist of thin-walled vesicles communicating with each other and with the interior of the central canal of the spinal cord (Figs. 344, 345 and 346).

In higher stages of development the walls of these cerebral vesicles become not only thicker and their cavities smaller and smaller, but

elevations (gyri) and depressions (sulci), convolutions and fissures, form so as to give to the brain its characteristic appearance, the degree of external complexity differing in different classes of animals.

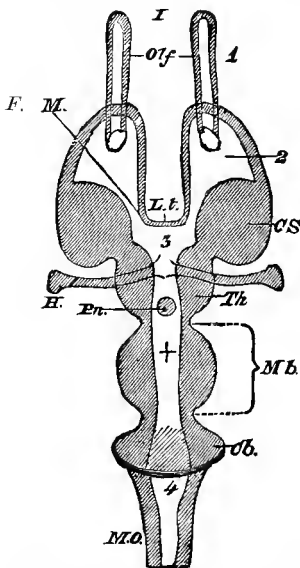

FIG. 346.—DIAGRAM OF A HORIZONTAL SECTION OF A VERTEBRATE BRAIN, AFTER HUXLEY. (Yeo.)

Olf, Olfactory lobes; L.V., lamina terminalis; C.S., corpus striatum; Th, optic thalamus; Pn, pineal gland; M.B., mid-brain; Cb, cerebellum; M.O., medulla oblongata; 1, olfactory ventricle; 2, lateral ventricle; 3, third ventricle; 4, fourth ventricle; + itar e tertio ad quartum ventriculum; F.M., foramen of Monro; H, optic nerves.

In fact, the strongest point in favor of the high importance of the cerebrum, and especially its connection with the mental functions, is seen in the progressive complexity of its surface in passing from the lower to the higher animals.

In fishes, amphibia, and reptiles the cerebral cortex is smooth, and but a faint trace of the formation of fissures is to be seen in birds. In the lowest mammals also the hemispheres are smooth, as in the marsupials, the lowest rodents, if not also in the lowest so-called quadrumana, as in the lemurs. But, ascending to the higher orders of mammals, the hemispheres become more and more sulcated on the surface, until the ridges or convolutions become more and more numerous and complex as we reach the highest mammals or the highest genera in the several orders.

The cerebral convolutions may be said to be characteristic of the brains of

mammals, and may be considered, firstly, in regard to their general plan, and, secondly, their relative complexity within that plan.

The highest degree of complexity of the cerebral convolutions is seen in the brain of man, of which the most important are represented in the following diagrams (Figs. 347, 348, 349). Each cerebral hemisphere is subdivided on its external surface into five lobes—the frontal, parietal, occipital, temporo-sphenoidal, and island of Reil.

In the (1) *frontal lobe* are found three convolutions—the *superior*, *central*, and *inferior* frontal convolutions. Behind these comes the *ascending frontal*, separated from them by the precentral fissure and bounded posteriorly by the fissure of Rolando, which forms the anterior boundary of (2) the *parietal lobe*, the latter being limited below by the fissure of Sylvius and behind by the parieto-occipital fissure. In this lobe are found the *ascending parietal* convolutions immediately behind the fissure of Rolando, *supramarginal* convolution arching around the posterior extremity of the fissure of Sylvius, and the *angular gyrus* arching around the end of the first temporo-sphenoidal fissure.

(3) The *temporo-sphenoidal lobe*, bounded in front by the fissure of Sylvius, contains three horizontal convolutions, *superior*, *middle*, and *inferior temporo-sphenoidal* convolutions, the first two being separated by the parallel sulcus.

(4) The *occipital lobe* is separated from the parietal lobe by the parieto-occipital fissure, and likewise contains three convolutions on its outer surface,—the *superior*, *middle*, and *inferior occipital* convolutions.



(5) The *central lobe*, or island of Reil, consists of five or six short, straight convolutions (*gyri operiti*) radiating out and back from the anterior perforated spot, and can only be seen when the margins of the fissure of Sylvius are separated.

On the inner surface of each hemisphere is the *gyrus fornicatus*, or convolution of the corpus callosum, which terminates posteriorly in the *gyrus uncinatus* or *gyrus hippocampi*. Above is the marginal convolution, which is simply the inner surface of the frontal and parietal convolutions, while the inner surface of the ascending parietal convolution is termed the quadrate lobe, or *præcuneus*. The *parieto-occipital* fissure terminates in the *calcarine* fissure and, running backward in the occipital lobe, incloses the wedge-shaped lobule,—the *cuneus*.

The importance of an acquaintance with the principal cerebral convolutions as here sketched will be seen when the functions of the cerebral cortex are considered.

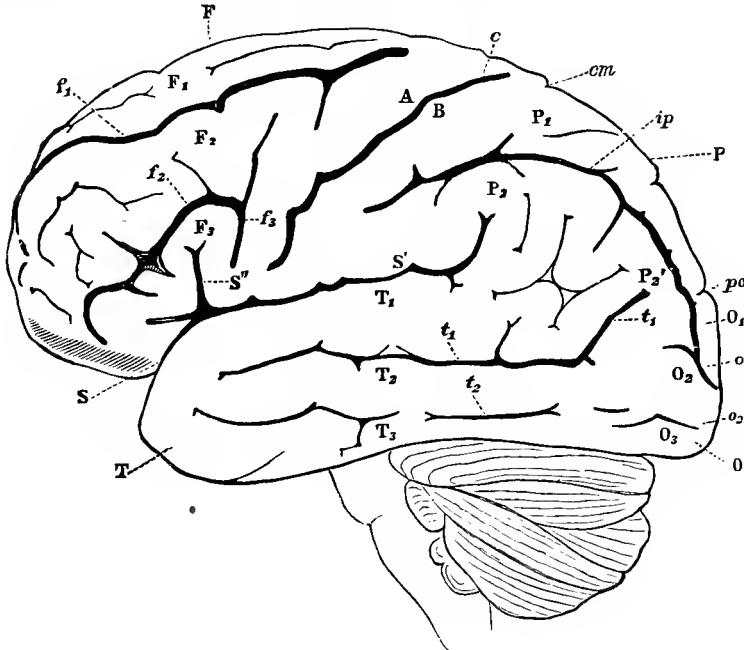

FIG. 347.—LEFT SIDE OF THE HUMAN BRAIN (DIAGRAMMATIC). (Landois.)

F frontal, P parietal, O occipital, T temporo-sphenoidal lobes; S fissure of Sylvius; S' horizontal, S'' ascending ramus of S; c, sulcus centralis, or fissure of Rolando; A ascending frontal and B ascending parietal convolutions; F<sub>1</sub> superior, F<sub>2</sub> middle, and F<sub>3</sub> inferior frontal convolutions; f<sub>1</sub> superior and f<sub>2</sub> inferior frontal fissures; f<sub>3</sub>, sulcus fraecentralis; P, superior parietal lobule; P<sub>2</sub>, inferior parietal lobule, consisting of P<sub>2</sub>, supramarginal gyrus, and P<sub>2</sub>', angular gyrus; ip, sulcus interparietalis; cm, termination of callosal-marginal fissure; O<sub>1</sub> first, O<sub>2</sub> second, O<sub>3</sub> third occipital convolutions; po, parieto-occipital fissure; o, transverse occipital fissure; o<sub>2</sub>, inferior longitudinal occipital fissure; T<sub>1</sub> first, T<sub>2</sub> second, T<sub>3</sub> third temporo-sphenoidal convolutions; t<sub>1</sub> first, t<sub>2</sub> second temporo-sphenoidal fissures.

In most ruminants the convolutions are arranged in the form of parallel folds, extending from the front to the back of each hemisphere, but are much more complicated than in the carnivora, where the surface of the hemispheres is divided into four pairs of antero-posterior convolutions, distributed around the upper end of the Sylvian fissure and passing from the frontal to the parieto-temporal lobe (Fig. 350).

In the ruminants traces of the fissure of Rolando may be detected, but in none of the ruminants, rodents, marsupials, or even carnivora, with the exception of the seal, is there to be found a backward prolongation of the lateral ventricle forming a posterior cornu.

In the quadrumana the plan of the arrangement of the cerebral convolutions to a certain extent resembles that seen in the cerebrum of man.

The characteristics of this organization are found—first, in the existence of the occipital lobe, with the prolongation into it of the lateral ventricle; second, the fissures occupy the position of the fissures of the human brain, of which the most important are the fissure of Rolando, dividing the frontal from the parietal lobe, the parieto-occipital fissure

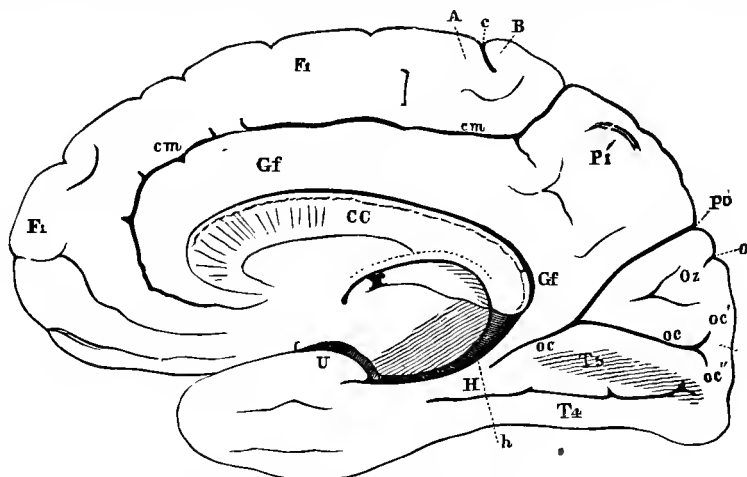

FIG. 348.—MEDIAN ASPECT OF THE RIGHT HEMISPHERE. (*Landois*.)

CC, corpus callosum divided longitudinally; Gf, gyrus fornicatus; H, gyrus hippocampi; *h*, sulcus hippocampi; U, uncinatus gyrus; *cm*, callosomarginal fissure; F1, first frontal convolution; *c*, terminal portion of fissure of Rolando; A, ascending frontal convolution; B, ascending parietal convolution and paracentral lobule; Pi, præcuneus, or quadrate lobule; Oz, cuneus; Po, parieto-occipital fissure; *o*, transverse occipital fissure; *oc*, calcarine fissure; *ocl*, superior, *ocl'*, inferior ramus of the same; D, gyrus descendens; T2, gyrus occipito-temporalis lateralis (lobulus fusiformis); T3, gyrus occipito-temporalis medialis (lobus linguæ).

distinguishing the occipital from the parietal lobe; and, third, the fissure of the hippocampi, formed by the folding inward of the cerebral substance along the posterior cornua. In the higher monkeys numerous other fissures complicate the cerebral surfaces and to a certain extent correspond with the arrangement of the convolutions in the human brain. In all these may be recognized certain primary frontal, parietal, occipital, and temporal convolutions, which have a general longitudinal direction. As a rule, the cerebral hemispheres are more convoluted in the larger species of any group of mammals than in the smaller species of the same group. For example, in the pachydermata the highest degree of complexity of the convolutions is found in the elephant.

The basal ganglia likewise depend for their degree of development upon the position of the animal in the zoölogical series. Thus, the corpora quadrigemina are, as their name implies, divided into four eminences in all mammals, the anterior pair being larger in herbivora and the posterior in carnivora.

In birds, reptiles, and fishes they consist only of a single pair of ganglionic masses, and are termed the corpora bigemina, or optic lobes.

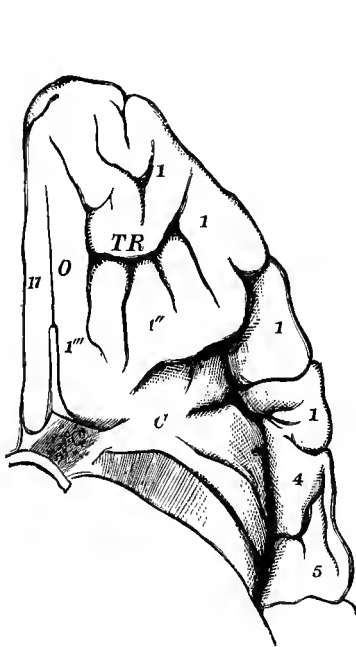

FIG. 349.—ORBITAL SURFACE OF THE LEFT FRONTAL LOBE AND THE ISLAND OF REIL, THE TIP OF THE TEMPORO-SPIENOIDAL LOBE REMOVED TO SHOW THE LATTER. (Landois.)

17, convolution of the margin of the longitudinal fissure; O, olfactory fissure, with the olfactory lobe removed; TR, triradiate fissure; III and III', convolutions of the orbital surface; I, I, I, I, under surface of the infero-frontal convolution; 4, under surface of the ascending frontal, and, 5, of the ascending parietal convolutions; C, central lobe, or island.

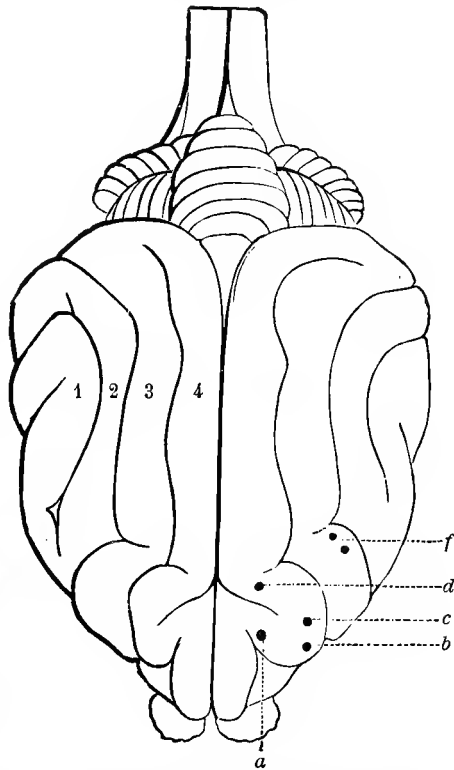

FIG. 350.—BRAIN OF DOG, SUPERIOR SURFACE. (Colin.)

1, 2, 3, 4, the four primary convolutions; a, centre for superior cervical muscles; b, for adductors and extensors of anterior extremity; c, for flexors and rotators of anterior extremity; d, motor centre for posterior extremity; f, centre for facial muscles.

So, also, the corpora striata in all vertebrates are covered by the cerebral hemispheres, but in descending the animal series the reduction in the size of the cerebral lobes gives a relatively greater importance to the corpora striata. The size of the optic and olfactory lobes varies in different groups of animals, being largest in those in which the special senses associated with these parts of the brain are most highly developed.

Further, in descending the vertebrate series, the lateral ventricles become smaller in extent and of simpler form, the posterior cornua being absent in all animals below the quadrumana, with the exception of the seal. The gray matter of the hemispheres likewise diminishes, until in fishes the gray cortex is so thin as to be almost indistinguishable to the naked eye. The corpus callosum has its highest development in man, and in the lower mammals becomes both shorter from before backward and thinner, and gradually becomes inclined upward and backward. In the marsupials it is rudimentary, and in no vertebrate lower than mammals is there any trace of the corpus callosum, it being represented in birds, reptiles, amphibia, and fishes merely by transverse commissural fibres crossing at the base of the cerebrum. As the hemispheres become reduced in importance there is a corresponding simplification in the medulla-oblongata and a diminution of the cerebellum and pons, the pons being absent in reptiles, amphibia, and fishes.

No olivary bodies or corpora dentata are to be distinguished in animals lower than mammals, the anterior and posterior prominences and restiform bodies often constituting the entire mass of the medulla oblongata.

The fourth ventricle, on the other hand, is more clearly marked in the lower animals and is more directly continuous with the central canal and spinal cord.

Like the cerebrum, the cerebellum likewise diminishes in passing from the highest to the lowest vertebrates. In birds the bulk of the cerebellum is composed of the vermiform process, while in reptiles, amphibia, and fishes this median portion is alone present. Like the cerebrum, the cerebellum, also, becomes progressively simplified, the laminae or convolutions diminish until they are comparatively few in the bird, while they are absent in reptiles, amphibia, and fishes, in which the surface is quite smooth.

In the frog the cerebellum forms a simple, smooth band, and in the lowest fishes is so reduced in size as to no longer cover the medulla oblongata.

In many carnivora and ruminants the cerebellum, instead of being composed of broad, smooth, lateral hemispheres joined by the vermiform processes, is very uneven on its surface, and apparently consists of a cluster of a number of lobules.

The internal structure of the cerebellum likewise becomes simplified and the internal laminae of gray matter disappear. In general, it would appear that the more complex the character of the movements of which the animal is capable the higher will be the plane of development of the cerebellum.

Only in the large cetaceans and pachyderms is the brain absolutely

heavier than in man; thus, in the whale its weight is about five pounds, while in the elephant it varies from eight to ten pounds.

Compared with the weight of the body, the brain diminishes in weight in the following order:—

In mammals, 1 to 186; in birds, 1 to 212; in reptiles, 1 to 1321; and in fishes, 1 to 5668.

In mammals the relative proportion of the brain to the body is smaller in the larger species. Thus, in the ox it is as 1 to 860; the elephant, 1 to 500; the horse, 1 to 400; sheep, 1 to 350; dog, 1 to 305; the cat, 1 to 156; the rabbit, 1 to 140; the rat, 1 to 76; field-mouse, 1 to 31; man, 1 to 36. It is thus seen that in few animals is the brain heavier compared to the body than it is in man, though in a few singing-birds it may amount to as much as 1 to 12.

It must not be forgotten that the estimates of the weight of the brain include the sensory and motor ganglia at the base of the cerebrum, the optic thalami, the corpora striata, and the cerebellum, and in the lower mammals these portions of the brain constitute by far the greater part; hence the size of the cerebral lobes as an index of the power of intelligence is not disturbed by these figures.

To recapitulate, the principal difference noticed in the brain in passing from the highest to the lowest vertebrata is not only in its relative decrease in size but also in its gradual simplification in form and structure, more especially in the cerebral hemispheres and cerebellum. These organs, indeed, gradually become smaller in proportion to the sensory and motor ganglia at the base of the cerebrum; or, in other words, the ganglia exhibit a greater proportionate size as compared with the cerebral hemispheres and cerebellum.

In the highest mammals the cerebral hemispheres completely cover the olfactory lobes in front and the corpora quadrigemina behind, and in man even overlap the cerebellum; but in the carnivora, ruminants, and lower mammals the cerebral hemispheres no longer overlap, but even fail to cover any part of the cerebellum, while in the ruminants the anterior part of the hemispheres is so diminished as to permit the projection of the olfactory lobes beyond them.

In rodents the cerebral lobes have become still more retracted and now a portion of the corpora quadrigemina becomes visible. In birds, while the olfactory lobes are covered, the optic lobes are exposed, and in reptiles, amphibia, and fishes the cerebral hemispheres become so much further reduced in size as to merely cover the corpora striata with a thin layer of cerebral substance.

In the lowest vertebrata the parts of the encephalon thus appear to be arranged in a double symmetrical row, one behind the other. The most anterior in this row are the ganglionic masses which form the

olfactory lobes; behind them come the cerebral lobes covering the corpora striata, and the third and usually the largest mass, corresponding to the optic thalami and corpora quadrigemina; behind them is seen the cerebellum as a small central mass, while the medulla oblongata is the connecting link between the spinal cord below and the basal ganglia of the brain above. These different parts of the brain will be taken up in turn, commencing with the medulla oblongata as the cranial prolongation of the spinal cord.

1. MEDULLA OBLONGATA.—The medulla oblongata, like the spinal cord, is composed of two symmetrical halves, each capable of separation

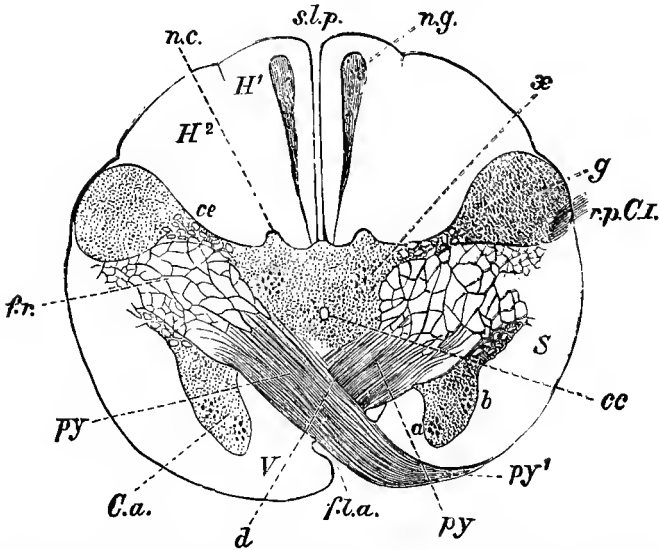

FIG. 351.—SECTION OF THE DECUSSATION OF THE PYRAMIDS. (Landois.)

*f.l.a.*, anterior median fissure, displaced laterally by the fibres decussating at *d*; *V*, anterior column; *C.a.*, anterior cornu, with its nerve-cells. *a, b*; *cc*, central canal; *S*, lateral column; *f.r.*, formatio reticularis; *cc*, neck, and *g*, head of the funiculus cuneatus; *r.p.C.I.*, posterior root of the first cervical nerve; *n.c.*, first indication of the nucleus of the funiculus cuneatus; *n.g.*, nucleus (clava) of the funiculus gracilis; *H¹*, funiculus gracilis; *H²*, funiculus cuneatus; *s.l.p.*, posterior median fissure; *æ*, groups of ganglionic cells in the base of the posterior cornu.

by the naked eye into three different divisions, the anterior pyramids, the olivary and restiform bodies, and the posterior pyramid, or *funiculus gracilis*. The lower end of the medulla oblongata, at the point of exit of the roots of the first cervical nerves, is characterized by a deviation of the lateral columns (crossed pyramidal tract) of the cord, which, up to this point running parallel with the axis of the cord, here turn in through the gray substance of the anterior horn and cross to the opposite side of the cord in the anterior white commissure to join the direct pyramidal tract. The lateral columns of the cord consequently form a decussation at the bottom of the anterior longitudinal fissure in the

medulla, this point of crossing being termed the decussation of the pyramids (Fig. 351).

The anterior pyramids are thus made up of the crossed pyramidal tract from the lateral column of the opposite side of the cord, and the direct pyramidal tract from the anterior column of the same side of the cord.

Of the pyramidal fibres some pass through the pons directly to the cerebral cortex in a manner to be described directly, some pass to the cerebellum, and some join fibres coming from the olivary body to form the olivary fasciculus.

The remainder of the anterior column, the antero-external fibres, lie under the anterior pyramids and form part of the *formatio reticularis*.

In the neighborhood of the first cervical nerve and the point of origin of the first root of the hypoglossal nerve, laterally from the anterior pyramids, lie the remainder of the lateral columns of the cord which have not undergone decussation, the direct cerebellar tract passing backward to rejoin the restiform body and go to the cerebellum; the remaining fibres, passing underneath the olivary bodies and appearing in the floor of the medulla, form the *fasciculus teres* and pass to the cerebrum.

Farther outward from the anterior pyramids are found the gray masses of the olivary bodies, the pyramidal nucleus, and the accessory olivary nucleus, through which passes toward the middle line and backward the remainder of the anterior column. The gray substance of the olivary bodies on section possesses the form of a horseshoe, whose arch is thrown up into numerous folds and whose opening is directed toward the centre of the medulla. It contains numerous small, yellow, pigmented multipolar ganglion cells, and embraces like a capsule a tract of medullated nerve-fibres which enter through the hylus of the olivary bodies and spread out over the entire inner surface of the gray substance. In all probability some of these fibres terminate in the ganglion cells of the olivary body. The remainder pass through the gray substance of the olivary body and partly unite with the fibrous columns of the restiform bodies and partly surround the exterior surface of the olivary bodies. The gray substance of the pyramidal nucleus and the accessory olivary nucleus resembles in all respects that of the olivary bodies. The former lies in the hylus of the olivary bodies toward the posterior central line of the pyramidal and olivary columns; the latter, in the form of a thin, concave plate of gray matter, lies between the olivary hylus and the corpora restiformes, which, by a collection of gray matter (Clarke's column), form an unbroken continuation of the posterior columns of the cord to the cerebellum.

The restiform bodies form the posterior division of the medulla

oblongata and appear to the naked eye as the immediate continuation of the posterior white columns (postero-external fibres) of the spinal cord. At the level of the foramen magnum they divide and expose the interior gray substance of the spinal cord, which, previously covered by the posterior columns, here becomes exposed on the posterior surface. The gray matter at this point also becomes flattened out through the opening of the central canal of the spinal cord, its borders being flattened out laterally. The posterior pyramids form the upward continuation of the postero-median fibres of the posterior columns of the cord.

While the gray substance of the spinal cord forms a compact mass traversed only by the narrow central canal and is everywhere surrounded by a sheath of white substance, in the medulla it becomes exposed and forms a flattened layer, and is divided into two symmetrical halves lying on each side of the median line and bounded only by a slight rim, the last trace of the central spinal canal. This exposed surface of gray matter in the medulla oblongata has the form of an elongated rhomb, whose longest diagonal coincides with the median line, and it forms the floor of the fourth ventricle, communicating above with the aqueduct of Sylvius and below with the central canal of the spinal cord, the lower pointed end of this surface bearing the name of the *calamus scriptorius*. The gray substance of the floor of the fourth ventricle is entirely similar to that of the spinal cord; it contains a large mass of multipolar ganglion cells, of which a few form distinct roots and appear to be in direct communication with the cranial motor nerves.

The ganglionic origin of the sensory cranial nerves is less distinctly made out. It is, however, clear that all the cranial nerves, from the oculo-motor to the hypoglossal, originate in the medulla oblongata and its annexes. Only the optic and olfactory nerves originate within the cerebrum. The gray matter of the floor of the fourth ventricle forms a direct continuation of the gray matter of the spinal cord, and is to this extent analogous to the anterior columns, the pyramids, and cerebellar fibres, which pass without interruption from the spinal cord into the medulla oblongata.

The anterior divisions of the lateral columns of the spinal cord likewise pass without interruption into the medulla oblongata and force themselves between the olivary body and restiform body, without, however, passing farther toward the median line (Fig. 352).

From the *raphé* originate numerous nervous fibres, or so-called internal transverse fibres, which cross the longitudinal fibres of the medulla at a right angle and split up into a large number of smaller bundles, the net-work so formed being described as the reticular formation of the medulla oblongata. This net-work incloses in its spaces numerous multipolar ganglion cells, in which terminate, in all probability,



certain of the fibres of the lateral columns of the cord, and so enable the medulla, by bringing it into communication with impressions coming from below, to act as a reflex centre. The transverse fibres of the medulla are to be regarded as commissural fibres connecting the two halves of the medulla, especially the olivary bodies.

Closely allied to the anterior surface of the olivary columns are to be found the gray nuclei, or the column of Goll (*Keilstrang*), from which originate the arciform fibres, or the external transverse fibres which surround the entire external surface of the medulla to unite with the internal transverse fibres, from there to pass into the restiform bodies, and from there to the cerebellum.

The internal interweaving of the centrifugal and centripetal fibres, the presence of numerous ganglionic cells, and, to a certain extent, the evident union of different classes of nerve-elements, the symmetrical connection by transverse fibres of both halves of the medulla, all speak in the clearest way as to the high physiological importance of this portion of the central nervous system, both as the seat of reflex centres, as the origin of numerous cranial nerves, and as the paths of communication from the spinal cord to the brain.

As is evident from the anatomical description of the medulla, in many respects it forms the most important part of the central nervous system. It forms the ganglionic termination of a large number of fibres; most of the cranial nerves find in it their origin, and in it the most diverse systems of the animal body are brought into nervous connection. For the ascending motor and sensory nerves of the spinal cord it forms not only the means of conduction, but is the seat of important centres of co-ordination. These paths, and the most important centres, are represented in diagrammatic form in Figs. 353 and 354.

It has been seen that when the spinal cord is divided below the level of the medulla oblongata in the frog it remains perfectly motionless and

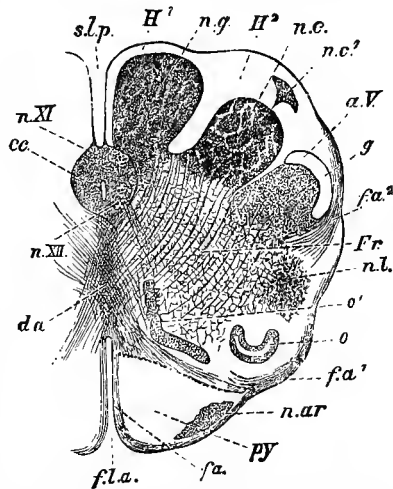

FIG. 352.—SECTION OF THE MEDULLA OBLONGATA AT THE SO-CALLED UPPER DECUSSATION OF THE PYRAMIDS. (Landolt.)

*f.l.a.*, anterior, *s.l.p.*, posterior median fissures; *n.XI*, nucleus of the accessorius vagus; *n.XII*, nucleus of the hypoglossal; *da.*, the so-called superior or anterior decussation of the pyramids; *py*, anterior pyramid; *n.ar.*, nucleus arciformis; *ol.*, median olivary body; *o.*, beginning of the nucleus of the olivary body; *n.l.*, nucleus of the lateral column; *Fr.*, formatio reticularis; *g.*, substantia gelatinosa, with (*a.V.*) the ascending root of the trigeminus; *n.c.*, nucleus of the funiculus cuneatus; *n.c.¹*, external nucleus of the funiculus cuneatus; *n.g.*, nucleus of the funiculus gracilis (or clava); *H¹*, funiculus gracilis; *H²*, funiculus cuneatus; *c.c.*, central canal; *fa.*, *fa.¹* *fa.²* external arciform fibres.

in an apparent condition of almost total paralysis, yet after the shock of the operation has passed off a number of highly complex reflex motions may be evoked. If, however, the section of the cord be made at the anterior border of the medulla the position of the frog after the shock of the operation has passed off is more nearly normal, and allusion has been

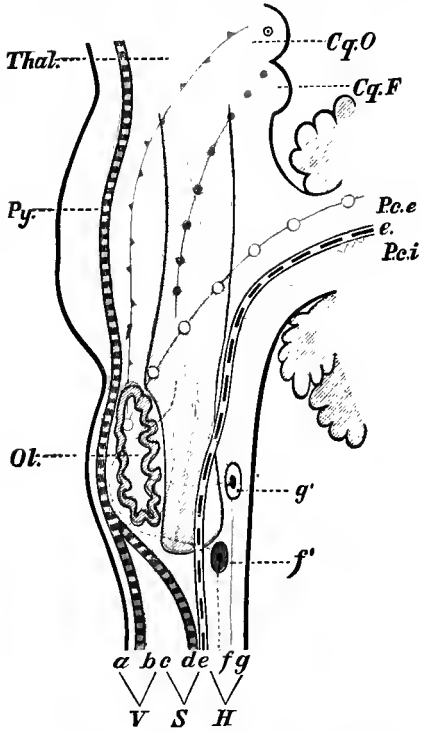

FIG. 353.—DIAGRAM OF THE CHIEF TRACTS IN THE MEDULLA, AFTER ERB. (Ramney.)

The formatio reticularis is represented by shading. *Ol.*, olivary body; *V* anterior, *S* lateral, and *H* posterior spinal funiculi; *a*, pyramido-anterior tract; *d*, pyramido-lateral tract; *Py.*, pyramidal tract; *b*, remainder of anterior column; *c*, remainder of the lateral column; *e, e*, cerebello-lateral tract; *f*, funiculus gracilis, and *g*, nucleus of the same; *g*, funiculus cuneatus, and *g'*, nucleus of the same; *P.c.i.*, internal fasciculus of the pedunc. cerebelli; *P.c.e.*, external fasciculus of the same; *Cq.F.*, tract from corp. quadr. to format. retic.; *Cq.O.*, the same to the olivary body; *Thal.*, tract from the thalamus opticus.

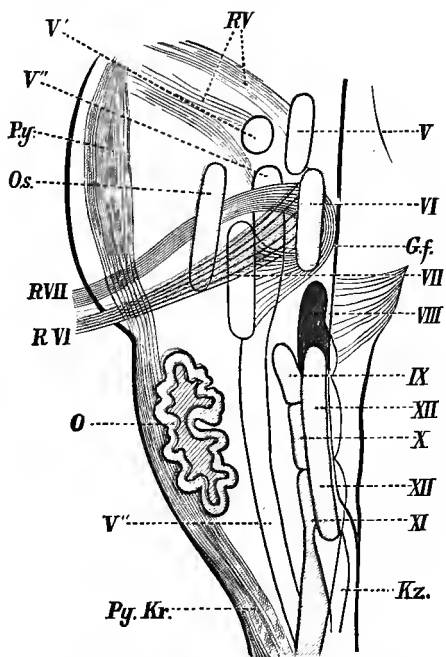

FIG. 354.—TRANSPARENT LATERAL VIEW OF THE MEDULLA, SHOWING THE RELATIVE POSITIONS OF THE MOST IMPORTANT NUCLEI; RIGHT HALF OF THE MEDULLA, SEEN FROM THE SURFACE OF SECTION; THE PARTS THAT LIE CLOSER TO THIS SURFACE ARE DEEPER SHADED, AFTER ERB. (Ramney.)

*Py.*, pyramidal tract; *Py. Kr.*, decussation of pyramids; *O.*, olivary body; *O.s.*, superior olivary body; *V*, motor, *V'*, middle sensory, *V''*, inferior sensory nucleus of trigeminus; *VI*, nucleus of abducens; *G. f.*, genu facialis; *VII*, nucleus facialis; *VIII*, posterior median acoustico nucleus; *IX*, glosso-pharyngeal nucleus; *X*, nucleus of vagus; *XI*, accessory nucleus; *XII*, hypoglossal nucleus; *Xz.*, nucleus of the funiculus gracilis; *RV*, trigeminus roots; those of the *RV'*, abducens, and *RVII*, facialis.

made to the fact that in the mid-brain is seated a centre which inhibits reflex action.

When the cerebral lobes only have been removed in the frog, volition is apparently the only function of the animal which is wanting, and in the absence of stimuli of all characters the animal remains absolutely inert. If such a frog is thrown into water it swims; by stimulating its

body it may be made to leap; when placed on its back it regains its normal attitude. When placed on an inclined plane it crawls up until it gains a new position, and if such an experiment be made by placing a frog on a small piece of board, by gradually inclining the board more and more the frog may be made to climb up the board, pass over to the other side, and the piece of wood may be turned over a number of times, the frog always moving with it as long as its equilibrium is disturbed. Such a frog will likewise be apparently sensible to light, and if made to jump will avoid objects casting a strong shadow. Such movements as above described are evidently carried out by co-ordinating mechanisms and governed by definite afferent impulses (Figs. 355 and 356).

It is evident, from the existence of these motions in the frog deprived of its cerebral hemispheres, that the mechanism governing them must lie in parts of the central nervous system below the line of section. No such operations can be effected in a frog in which the medulla has been removed. It follows, therefore, that in the medulla, or perhaps in the corpora quadrigemina and optic lobes, are found the co-ordinating centres of the most complex muscular movement.

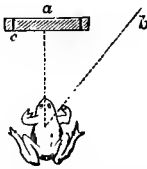

FIG. 355.—FROG WITHOUT ITS CEREBRUM AVOIDING AN OBJECT PLACED IN ITS PATH. (Landois.)

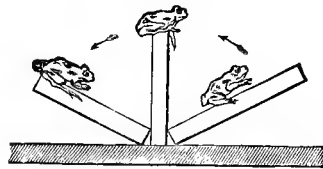

FIG. 356.—FROG WITHOUT ITS CEREBRUM MOVING ON AN INCLINED BOARD, AFTER GOLTZ. (Landois.)

In the mammal or bird a similar state of affairs is present, although, as might be expected, complicated to a greater degree by the more severe shock of the operation.

In a bird or a mammal in which the medulla remains after removal of the cerebral lobes the attitude may become perfectly normal. If placed on its side it will regain its feet. If a bird be thrown into the air it will fly for a considerable distance, perhaps avoiding obstacles, but its movements more resemble those of a stupid, sleepy animal than one in full possession of its faculties. A mammal, also, so operated on can stand, run, and leap, and if placed on its back can regain its normal position, but if left alone it remains absolutely motionless. If food is placed in the mouth of the animal in whom ablation of the cerebrum has been successfully performed the animal will eat, and the complicated motions of mastication and deglutition will be accomplished with perfect regularity.

In the case of mammals it ought, perhaps with more correctness, to be stated that these highly co-ordinate movements owe their performance to parts above the medulla, since the removal of the optic thalami, crura cerebri, corpora quadrigemina, cerebrum, and pons varolii is usually followed by various forced movements, or the animal lies partly on its side, and, although various complex movements may be produced, they are much more limited than when the higher parts of the brain are left intact.

The medulla oblongata is the seat of a large number of centres governing complex co-ordinate movements, of which the following are the most important:—

(a) *The Respiratory Centre.*—This is located in the medulla behind the point of origin of the pneumogastric nerves on both sides of the apex of the calamus scriptorius, between the nuclei of the vagus and spinal accessory nerves. This centre is symmetrically situated, and may be separated by a longitudinal incision without interfering with the respiratory movements. Conditions governing the actions of this centre have been already given under the subject of respiration.

(b) *The Cardio-Inhibitory Centre.*—As has been previously stated, when the pneumogastric nerve is stimulated it may slow or arrest the heart in diastole, according to the degree of stimulation. The inhibitory fibres of the pneumogastric reach the latter nerve through the spinal accessory and have their origin in the medulla oblongata. The conditions for its action have been likewise given.

(c) *The Vaso-Motor Centre.*—The collection of nerve-cells which govern the vaso-motor nerves, and through them the calibre of the blood-vessels, is located in the floor of the medulla oblongata, extending from the upper part of the floor to within four or five millimeters of the columns of the cerebellum. This centre is also a double one, situated symmetrically on each half of the medulla and each part corresponding to the upward continuation of the lateral columns of the spinal cord. Stimulation of this centre causes contraction of all the arteries with a consequent increase in the blood pressure; paralysis causes relaxation and dilatation of the blood-vessels and fall of blood pressure. Its action has also been described.

(d) *Centre for Closure of the Eyelids.*—The centre for the closure of the eyelids lies close to the calamus scriptorius. The afferent impulses reach it through the sensory branches of the fifth cranial nerve from stimuli applied to the cornea, conjunctiva, and skin in the neighborhood of the eye; reaching the centre of impulse, are transferred to the special nerve, through which the afferent impulses reach the orbicularis palpebrarum.

(e) *Centre for Sneezing.*—The location of this centre has not been

accurately determined. Stimuli pass through the internal nasal branches of the trigeminus or olfactory nerves and efferent fibres are found in the nerves coming to the muscles of expiration.

(f) *The Centre for Coughing.*—This centre is placed a little above the respiratory centre. The afferent fibres pass to the centre through branches of the pneumogastric, the efferent in the nerves of expiration and in those that supply the muscles that close the glottis.

(g) *Centre for the Movements of Suckling and Mastication.*—This centre also has escaped close localization. Afferent paths reach the medulla through the trigeminal and glosso-pharyngeal nerves. The efferent fibres in the case of suction reach the lips through the facial, the tongue through the hypoglossal, and the muscles which depress and elevate the lower jaw through the inferior maxillary division of the fifth nerves. The same nerves are concerned in the movements of mastication, with the exception that when the food passes within the dental arch the hypoglossal is concerned in the movements of the tongue, and the facial with the buccinator.

(h) *The Centre for the Secretion of Saliva.*—This centre lies in the floor of the fourth ventricle. When the medulla is stimulated, if the chorda tympani and glosso-pharyngeal nerves are intact, a profuse secretion of saliva is the result, indicating the efferent course of this impulse. Afferent impulses reach the centre through the nerves of taste.

(i) *The Centre for Deglutition.*—This, likewise, is located in the floor of the fourth ventricle. The afferent paths reach the centre through the second and third branches of the fifth pair, the glosso-pharyngeal and the pneumogastric. The efferent channels are found in the motor branches of the pharyngeal plexus.

(k) *The Centre for the Dilatation of the Pupil.*—This centre, likewise, lies in the medulla oblongata, the efferent fibres passing partly through the trigeminal nerve and partly in the lateral columns of the spinal cord, as far down as the ilio-spinal region, and from there passing out by the lowest two cervical and the two upper dorsal nerves into the cervical sympathetic. The centre is normally excited in a reflex manner by diminishing the amount of light entering the eye. Its action, together with that of the centre for contracting the pupil, will be referred to subsequently.

(l) *The centre for vomiting* is likewise found in the medulla. Its functions have been already described.

(m) The medulla oblongata, as discovered by Bernard, exerts a certain influence on the glycogenic function of the liver. When, as already described, a puncture is made in the floor of the fourth ventricle in the neighborhood of the origin of the pneumogastric nerve temporary glycosuria appears within an hour or an hour and a half after the

operation. The method by which this influence on the liberation of sugar by the liver is accomplished has been described under the heading of Glycogenesis.

2. THE COURSE OF THE FIBRES OF THE MEDULLA OBLONGATA.—We have now to attempt to trace the paths of communication of the different divisions of the medulla oblongata with the cerebrum, pons varolii, corpora quadrigemina, and, still more important than all, the formation of the hemispheres of the cerebrum and their means of communication by the cerebral peduncles with the mid-brain and its ganglia and with the cerebellum.

In tracing up the fibres from the medulla, those most readily followed are the continuations of the restiform bodies, which may be readily detected to pass directly into the cerebellum. Their termination after reaching the cerebellum is only partially cleared up, and before attempting its explanation we must first consider the mode of construction of the cerebellum itself.

The cerebellum consists, in the domestic animals and man, of two flattened hemispheres connected across the middle line by the middle lobe or vermiciform appendix, which is the fundamental portion of the organ. The white substance of the cerebellum exceeds to a considerable degree the gray matter. The latter is deposited over the entire surface of the two hemispheres of the cerebellum, forming the gray cortex of the cerebellum; within the inner white medullary substance of the hemisphere is a collection of gray matter known as the dentate or ciliary body, which in its general appearance somewhat resembles that of the olivary bodies found in the medulla oblongata, and which here, also, has the shape of a horseshoe, thrown up into numerous folds, and near which are also found associate nuclei. Although it is clearly established that the main function of the gray matter is to bring the nerve-fibres and nerve-cells into connection with each other, still, as yet, no direct termination of nerve-tubes in the ganglion cells of the cerebellum has been detected. Of course, this does not imply that the terminations of the gray cells in the cortex of the cerebellum with nerve-cylinders may not be readily determined. All attempts, however, to follow up these nerve-fibres has as yet resulted in almost total failure. If, however, we follow the restiform bodies (which form the inferior peduncles of the cerebellum) it may be seen that a certain amount of their fibres decussates and then enters into the dentate body, forming the so-called intra-ciliary fibres, while another passes externally and forms the extra-ciliary column.

In addition to its communication with the medulla, the cerebellum is likewise in communication with the corpora quadrigemina and the pons varolii. The fibres passing from the cerebellum to the corpora quadrigemina and crura cerebri (superior cerebellar peduncles) originate not

only from the extra-ciliary fibres around the corpora dentata, decussating in the pons, but also from the associate nuclei, while the fibres from the extra-ciliary columns alone have been traced into connection with the pons. It, therefore, is evident that the cerebellum is to be regarded as a complicated collection of gray ganglionic masses in unbroken connection with the medulla oblongata and pons on the one side and with the cerebrum on the other.

The *pons varolii* is formed by a collection of the continuations of the reticular formation of the medulla, the pyramids and anterior columns of the medulla, together with the fibres, coming directly by the middle peduncle from the cerebellum.

Above the pons the two collections of fibres known as the *cerebral peduncles* (*crura cerebri*) approach each other, the point at which the union is accomplished above the medulla being the locality in which the upper end of the fourth ventricle terminates in the aqueduct of Sylvius.

In the interior of each cerebral peduncle is found a mass of gray matter, the *substantia niger*, which separates the fibres of each crus into two layers, the upper layer forming the so-called *tegmentum cruris* and the lower the *basis cruris*. The upper division of the tegmentum contains also a gray nucleus (*nucleus tegmentis*).

Although these two divisions of the crura are in close anatomical connection, it has been determined with a considerable degree of positiveness that the pyramidal fibres are in direct communication through the basis of the cerebral peduncles with the central convolutions of the cerebral hemisphere on the same side, although whether a direct communication, as in the case of the cerebellum, of these fibres with the ganglionic cells in the upper surface of the hemispheres exists or not has not yet been determined. Nevertheless, it appears that they form no direct communication with the other gray masses of the hemispheres, the lenticular nucleus, optic thalamus or striated body. And since they undergo degeneration only after injury of the central convolutions, it is probable that they are in direct communication with the cortex of the brain.

Flechsigg claims to have followed them in an unbroken course from the pyramidal columns through the white mass between the lenticular nucleus and optic thalamus, the so-called internal capsule, direct to the gray cortex of the cerebral convolutions. The course of these fibres, together with the other important cerebro-spinal tracts are shown in Fig. 357.

The cerebrum is divided by a longitudinal fissure into two hemispheres in man, mammals, and birds, and its external surface is divided by a number of lesser fissures into lobes and convolutions. The cerebrum contains the ganglia of the brain, the optic thalamus or corpus

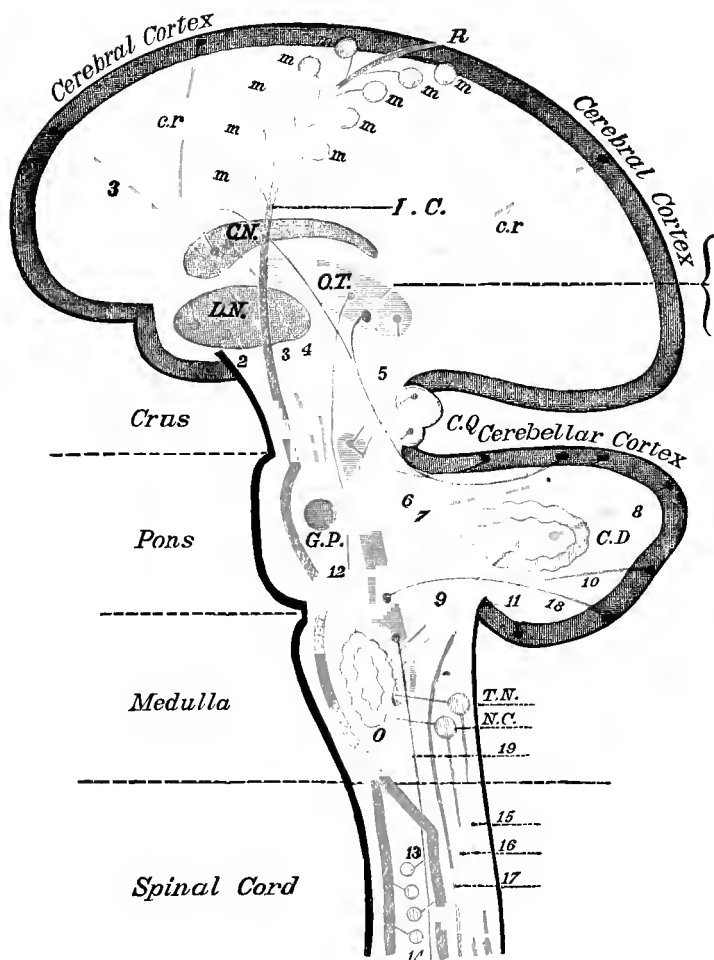

FIG. 357.—A DIAGRAM DESIGNED TO ILLUSTRATE THE COURSE OF CERTAIN NERVE-TRACTS WITHIN THE CEREBRUM, CRUS, PONS, MEDULLA, AND SPINAL CORD. MODIFIED FROM FLECHSIG. (Ranney.)

*C.N.*, caudate nucleus; *L.N.*, lenticular nucleus; *O.T.*, optic thalamus; *G.P.*, gray matter of the pons; *F.R.*, formatio reticularis; *C.D.*, corpus dentatum; *O.*, olivary body; *N.C.*, clavate nucleus; *T.N.*, triangular nucleus; *C.Q.*, corpora quadrigemina; *I.C.*, upper limit of the capsular fibres; *m, m'*, motor centres around the fissure of Rolando; *c.r.*, fibres of the "corona radiata." 1, the "pyramidal tract," arising from the motor centres of the cerebrum and terminating in the cells of the anterior horns of the spinal gray substance (13 and 14); 2, 3, and 4, fibres connecting the cerebral cortex, the caudate nucleus, and the lenticular nucleus with the gray matter of the pons after densation, and then prolonged as 6 and 7 to the cerebellum; 5, fibres of the superior cerebellar peduncle; 6, 7, 8, 9, and 10 show by their colors the tracts with which they are associated, as well as their origin and termination; 11 and 17, the "direct cerebellar tract" of the spinal cord (whose probable termination is not correctly shown in the cut, as it probably ends in the vermiform process); 12, the *lemniscus* or "fillet" tract, connecting the olivary body with the optic thalamus and the corpora quadrigemina; 13, the cells of the cord connected with the *direct pyramidal tract*; 14, the cells of the cord connected with the *crossed pyramidal tract*; 15, fibres of the *column of Burdach*, terminating superiorly in the *triangular nucleus*; 16, fibres of the *column of Goll*, terminating superiorly in the *clavate nucleus*; 19, fibres of the cord which terminate in the so-called "*reticular formation*" directly; 18, fibres of the *ret. form.* going to the cerebellum.



striati, the caudate and lenticular nuclei, and the corpora quadrigemina, being connected with the medulla by means of the cerebral peduncles, above which are situated the corpora quadrigemina.

In the domestic animals the anterior pair of the corpora quadrigemina are composed of gray matter, while the posterior are white, in direct opposition to what is the case in man. In herbivora and in the hog the anterior pair are the larger, while in carnivora they are of equal size, or the posterior may be somewhat more developed. Between the corpora quadrigemina and the optic thalamus lies the third ventricle, while under the corpora quadrigemina is situated the aqueduct of Sylvius, connecting the third and fourth ventricle.

We have now to attempt an explanation of the functions of these different parts of the brain.

3. **THE PONS VAROLII.**—We have seen that the pons, the superior continuation of the spinal cord, is composed of two sets of fibres. The one, the transverse fibres, constituting the median cerebellar peduncles, serves to connect the two lateral hemispheres of the cerebellum and exists only in animals in which the cerebellum consists of two lobes. The other part of the pons is composed of a mass of gray substance in continuity with that of the medulla and traversed in an antero-posterior direction by the fibres of the medulla, passing up to form the cerebral peduncles.

As in the study of other portions of the nervous system, we attempt here to determine the functions of the different parts of the brain by the method of excitation and excision.

When the pons is stimulated, either mechanically or by an electric current, pain and muscular spasms are produced, evidently by the mere implication of adjacent motor and sensory paths. Where section of the pons is performed there may be sensory, motor, or vaso-motor paralysis, together with forced movements when the middle cerebellar peduncles are involved. Thus, if there be an injury to the lower half of one side of the pons there will be both sensory and motor paralysis of the face on the same side and more or less general paralysis of the opposite side of the body; if the injury be to the upper half of the pons the facial paralysis will be on the same side as the paralysis of the body.

The pons, like the spinal cord and medulla, also acts as a reflex centre; although this fact is not capable of direct demonstration, its truth is rendered probable by the higher degree of muscular co-ordination preserved by an animal in which the pons has been retained over animals in whom the section has been carried through the brain below this point.

4. **THE CEREBRAL PEDUNCLES.**—The cerebral peduncles form the upward prolongation of the pons, and are constituted by those portions of the spinal cord which, after having traversed the pons and medulla, pass upward through the optic thalamus and corpora striata to enter the

cerebral hemispheres. When one of the cerebral peduncles is completely divided it produces paralysis of voluntary movement on the opposite side of the body, with a diminution of the sensibility and vaso-motor paralysis.

Section of the *basis* of both cerebral peduncles totally abolishes all voluntary movements, although reflexes apparently of *cerebral* origin still persist.

Section of the *tegmentum*, on the other hand, on both sides entails the loss of these cerebral reflexes, but allows voluntary motion to remain.

Injury to one cerebral peduncle causes pain and convulsions on the opposite side of the body, while the blood-vessels contract. As the irritative effects pass off these symptoms give place to paralysis.

5. THE CORPORA QUADRIGEMINA.—Destruction of the corpora quadrigemina on one side causes blindness, which may be either on the side of the injury or on the opposite side, according to the location of the mutilation. Total destruction causes absolute blindness in both eyes, with the absence of the reflex contraction of the pupil when exposed to the light. In addition to blindness, disturbance of equilibrium and inco-ordination of movement result. When stimulated the pupils have been noticed to dilate either on the same side or the opposite side of the body; this result is probably produced by conduction of the stimulus to the origin of the sympathetic nerve, for after section of the sympathetic dilatation of the pupil no longer takes place. Stimulation of the right anterior tubercle causes the eyes to deviate to the left, while if a vertical incision is made, so as to separate the right and left corpora quadrigemina, stimulation of one side only causes this movement to take place on one side.

The most striking result of injuries to the corpora quadrigemina are the so-called forced movements, evidently due to peculiar unilateral disturbances of equilibrium causing variations from the symmetrical movements of the two sides of the body. These movements may be of various kinds. In the so-called circus movement, instead of moving in a straight line, the animal runs around in a circle; rolling movement, where the animal rolls on its long axis, and the index movement, when the anterior part of the body is moved around the posterior part, which remains at rest. These different forms of movement frequently pass into each other, and they may be produced by injury either of the corpus striatum, optic thalamus, cerebral peduncle, pons, middle cerebellar peduncle, and certain parts of the medulla.

6. THE FUNCTIONS OF THE BASAL GANGLIA.—(a) *The Corpus Striatum*.—We have seen that the corpus striatum consists of two parts, the intra-ventricular portion projecting into the lateral ventricle to form the caudate nucleus, and the external portions the lenticular nucleus.

Lying between these are found the fibres of the anterior division of the internal capsule, which seem to have no connection with these ganglia.

Electrical stimulation of these ganglia causes general muscular contraction on the opposite side of the body. Lesions of either of these ganglia, provided the internal capsule be not injured, do not appear to cause any permanent symptoms, but destruction of the internal capsule causes paralysis of motion or sensibility or both on the opposite side of the body.

External to the lenticular nucleus is the external capsule, whose function is unknown, as is also the case as regards the claustrum, which is located externally to the external capsule.

(b) *The Optic Thalamus.*—Scarcely anything definite is known as to the functions of this organ, since we have been compelled to abandon the theory supported by Carpenter as to its purely sensory nature. Injury to the thalamus of one side sometimes produces partial paralysis on the opposite side of the body, and, again, sometimes after such an injury hemianæsthesia of the opposite side of the body, with or without disturbance of motion, has been observed. Frequently the thalamus may be irritated without producing any evidence of sensation or motion. Since the posterior portion is connected with the origin of the optic nerve it is in all probability concerned in the sense of vision. Together with the corpus striatum, the optic thalamus is perhaps mainly concerned in co-ordinate and complex muscular movements, since the cerebrum may be removed and motion still be normal, provided these basal ganglia are left intact; when, however, they are disturbed normal progression and co-ordinated movements are then rendered impossible.

The principal difficulty in determining facts in regard to the functions of this part of the brain is that they do not admit of experimental investigation without the most extensive injury to the other parts of the brain.

7. **THE FUNCTIONS OF THE CEREBRAL LOBES.**—In man and the higher mammals the cerebral lobes represent the greatest part of the brain-substance, and usually will constitute twelve-thirteenths of the entire weight of the brain. The cerebral hemispheres are composed of an internal white substance, representing the continuations of the fibres coming from below which terminate in an external layer of gray matter. The external matter, the cerebral cortex, is folded into convolutions separated from each other by fissures, some of which being so marked as to permit of the division of the cerebrum into adjacent lobes. From the cells of the cortex, in all probability, proceed all the motor fibres which are concerned in the production of voluntary movement, and to them come all the fibres from the organs of special and general sense which enable the brain to appreciate external impressions. Some of the fibres

terminating in the cortex traverse the basal ganglia; others, constituting the so-called pyramidal tracts, proceed from the motor regions of the cerebrum and pass through the white matter and converge in the internal capsule, and from there enter the crura cerebri, thence to the pons, and thence to the opposite side of the medulla oblongata.

The white matter of the cerebral lobes may, therefore, be considered merely as the continuation of the paths of conduction of the cord and medulla which terminate in the cells of the gray matter of the convolutions.

The consideration of the cerebral lobes resolves itself, therefore, into the study of the functions of the gray matter of the cortex. While the cerebrum has been from time immemorial looked upon as the seat of the will and intelligence, and, in fact, of all the psychological functions, it is only since 1870 that attempts to localize the different functions of the cortex have been attended by any measurable success.

In the lower animals, when the cerebral hemispheres are removed slice by slice, the animals simply become more and more dull and stupid, until finally they lose all intelligence. When in pigeons both cerebral hemispheres are removed the animals apparently appreciate no pain during the operation, nor are any movements produced by operations on the cerebral substance. After extirpation of the cerebral lobes they pass into a semi-comatose or stupid condition, and, if not disturbed, remain absolutely motionless, apparently experiencing no sensation of hunger, and will die of starvation in the midst of food without making any effort to feed. If mechanically disturbed, provided the basal ganglia are intact, they are capable of moving in a perfectly normal manner, will, to a certain extent, avoid obstacles, the pupils of their eyes react to light, and they are capable of reacting to violent sudden noises. If food is placed in their mouths they are capable of swallowing it, and, in fact, they preserve the power of completing numerous co-ordinated movements which depend upon reflex stimuli, indicating that the mechanisms concerned in the maintenance of equilibrium are located in the mid-brain, probably in the corpora quadrigemina.

If a single cerebral lobe is removed in the lower animals no effect other than the apparent dulling of intelligence is evident. In the higher animals after such a mutilation there is evident a certain dulling of sensibility and difficulty in movement on the opposite side of the body, which, however, finally in the majority of cases gradually disappear. It is concluded from these experiments that the cortex is the chief if not the exclusive seat of intelligence.

From the experiments of Fritsch and Hitzig in 1870 dates a new era in our knowledge of the functions of the cerebral cortex. They found that stimulation by means of electricity of certain circumscribed regions on the surface of the cerebral convolutions was followed by

co-ordinated movements in distinct groups of muscles of the opposite side of the body. They indicated certain areas of the cerebral cortex as the actual centres for the production of various movements, and their experiments have been confirmed and extended by a large number of subsequent observers. These points are termed the motor centres of the cortex, and have been located in the dog, the monkey, the cat, sheep, and the rabbit, but are absent in lower animals, such as the frog and fish. They are all found in the anterior part of the parietal lobe, the most important being shown in Fig. 358. When any centre which has been determined to govern any special group of muscles is destroyed or removed the corresponding part of the body is not permanently paralyzed in the dog, but movements which are produced in that part of the body become irregular and variable, and after a time the disturbance of movement may almost completely disappear.

In the monkey and man, on the other hand, destructive lesions of definite motor areas of the cortex cause permanent paralysis, this difference being, perhaps, explainable as due to the higher importance of the cortex in higher species, where it assumes more and more the functions subserved by the basal ganglia in lower animals.

A similar series of experiments has led to the localization in the cortex of certain parts which are in close relationship with the organs of sense, for we know that sensory impulses from the opposite side of the body pass upward through the posterior third of the posterior limb of the internal capsule to pass, in all probability, to the cortex of the occipital and temporo-sphenoidal lobes. Excision of these localities leads to disturbances in the appreciation of sensations coming through the sensory organs. Thus, for example, in the dog a locality has been found in the posterior cerebral lobe (outer convex part of the occipital lobe) the destruction of which produces blindness in the opposite eye; or, if both corresponding parts are removed, total blindness results. After extirpation of this part the channels which connect it with the optic nerves undergo degeneration. Centres for hearing and for smelling have also been located. The centre for hearing in the dog lies in the second primary convolution, while in man and the monkey it has been located in the first temporo-sphenoidal convolution. Such disturbances produced by removal of parts of the cortex are, like the motor disturbances, not permanent, but gradually disappear, and dogs rendered deaf or blind by excision of these parts of the cortex again learn to see and to hear,—a fact which is explained by the substitution of function in some corresponding part of the brain-cortex.

8. THE FUNCTIONS OF THE CEREBELLUM.—Experiments as to the function of the cerebellum have led to the conclusion that it is the great organ for the co-ordination of muscular movements,—a fact which would

alone be rendered probable when it is recognized that the cerebellum is in direct connection not only with all the columns of the spinal cord,

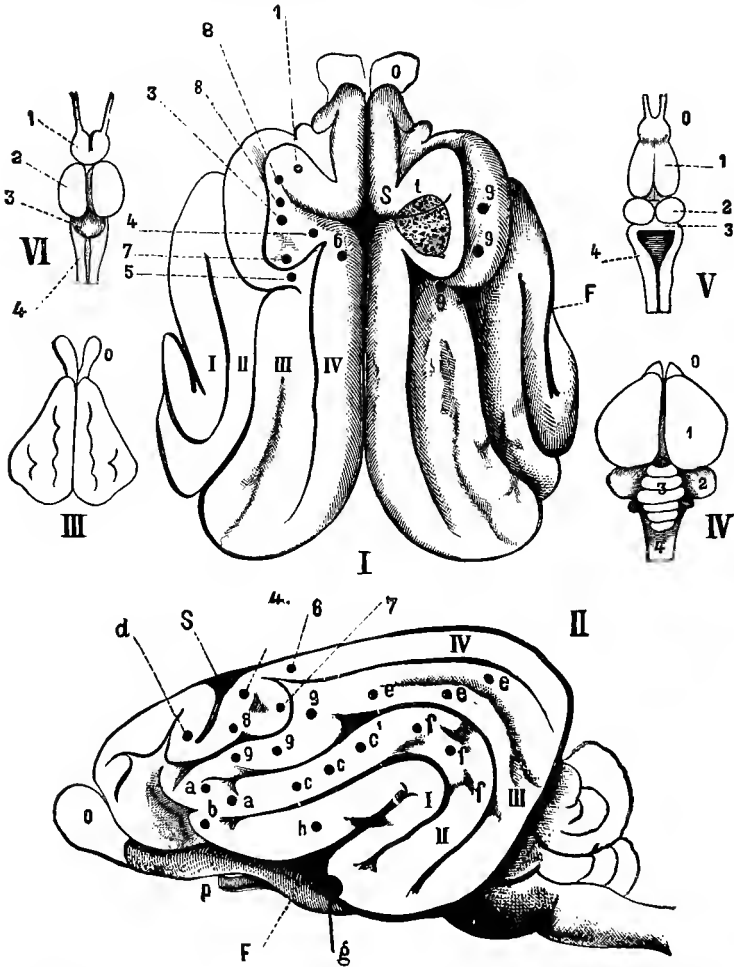

FIG. 358.—UPPER SURFACE VIEW OF THE CEREBRUM OF VARIOUS ANIMALS. (Landois.)

I, cerebrum of the dog; I, II, III, IV, the four primary convolutions; s, sulcus cruciatus; f, Sylvian fossa; o, olfactory lobe; l, motor area for the muscles of the neck; 2, extensors and abductors of the fore limb; 3, flexors and rotators of the fore limb; 4, the muscles of the hind limb; 5, the facial muscles; 6, lateral switching motion of the tail; 7, retraction and abduction of the fore limb; 8, elevation of the shoulder and extension of the fore limb, as in walking; 9, 9, orbicularis palpebrarum. II, *aa*, retraction and elevation of the angle of the mouth; *b*, opening of the mouth and movements of the oral centre; *cc*, platysma; *d*, opening of the eye; *p*, optic nerve; *h*, cerebrum of the frog, from above; I, *t*, thermic centre. III, cerebrum of rabbit, from above; IV, cerebrum of the pigeon, from above; V, cerebrum of the frog, from above; VI, cerebrum of the carp, from above. In all these *o* is the olfactory lobe; 1, cerebrum; 2, optic lobe; 3, cerebellum; 4, medulla oblongata.

especially with the posterior columns, whose division has been found to lead to inco-ordination, but with the basal ganglia of the cerebrum, which we have found to be especially concerned in this function. It is

supposed that the direct cerebellar paths of the cord conduct sensory impressions to the cerebellum, and thus indicate the posture of the trunk and the position of the limbs, while the motor impulses passing through the cord may be influenced by fibres passing from the cerebellum through the restiform body to the lateral columns. Injuries of the cerebellum produce no disturbance of the psychical function, nor do they give rise to pain. When, however, the cerebellum is gradually removed, as in a pigeon, at first symptoms of weakness and slight disturbance of movement are evident; as more and more of the cerebellum is removed great excitement appears, and the animal now makes violent irregular movements, which, while not similar to convulsions, are yet free from all apparent purpose; while co-ordinated movements are impossible vision and hearing, nevertheless, remain intact.

Again, section of the middle cerebellar peduncle on one side almost always gives rise to forced movements, the animal revolving rapidly on its own longitudinal axis, and this disturbance is accompanied by nystagmus, or oscillation of the eyeballs.

Injury or removal of the lateral lobe produces the same forced movement as section of the middle peduncle.

In mammals the dangers are so great in operations on the cerebellum that but few successes are on record. In operations of extirpation performed on mammals which have proved successful, at first the symptoms are those of irritation of the divided peduncles, and consist in clonic contractions of the muscles of the fore limb, neck, and back, while no sensory disturbances are perceptible. When recovery from the operation is complete the symptoms dependent upon the loss of the cerebellum then appear and consist mainly in disturbances of equilibrium, and, while many muscular groups apparently maintain their muscular tone intact, the power of associating various groups of muscles to produce complex actions is lost. When the injury to or extirpation of the cerebellum has been but superficial the disturbances of co-ordination soon pass off, while if the injury affects the lowest third of the cerebellum the effects are permanent.

We may now return to the subject of the conduction of motor and sensory impulses through the central nervous system, summarizing the statements which have been made during the consideration of the functions of the spinal cord, medulla oblongata, and brain (Fig. 359).

Sensory impulses originating in stimulation of the peripheral terminations of afferent or sensory nerves pass into the cord through the posterior roots of the spinal nerves, and the impulse passes either to the cerebrum or cerebellum or both. After entering the cord the fibres of the posterior roots diverge, and carry the afferent impulses in different

directions: part of the fibres communicate with the direct cerebellar tract and others with the posterior columns, thus furnishing through the restiform body a direct path to the cerebellum. Other fibres of these roots cross the middle line of the cord a little above where they

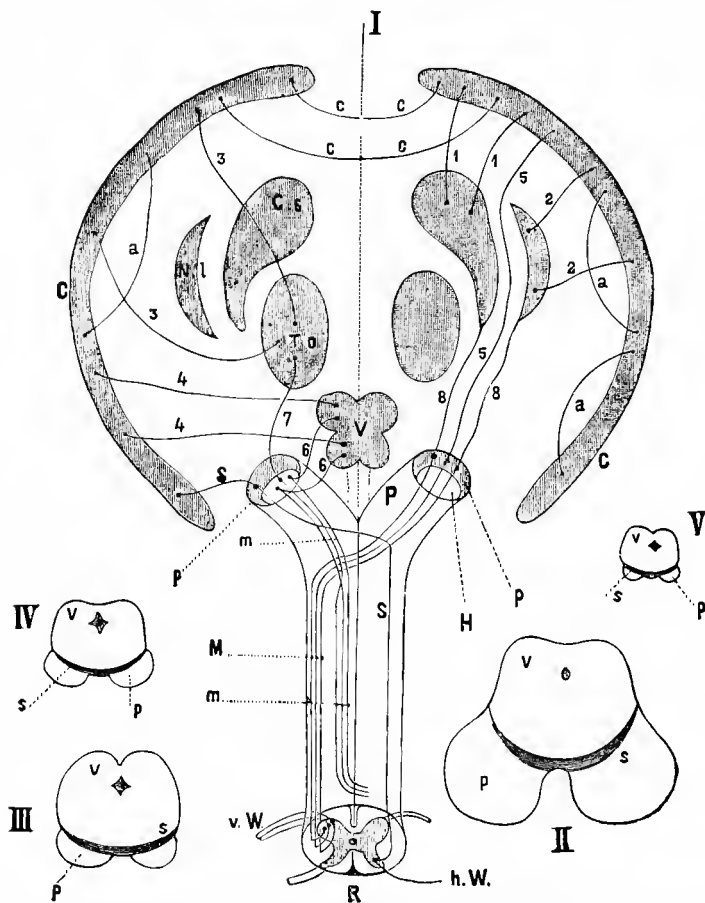

FIG. 359.—SCHEME OF THE BRAIN. (Landois.)

C.C., cortex cerebri; C.S., corpus striatum; N.l., nucleus lenticularis; T.o., optic thalamus; V., corpora quadrigemina; P., pedunculus cerebri; II., tegmentum, and p., crusta; I., corona radiata of the corpus striatum; 2, 2., of the lenticular nucleus; 3, 3., of the optic thalamus; 4, 4., of the corpora quadrigemina; 5, direct fibres to the cortex cerebri (Flechsig); 6, 6., fibres from the corpora quadrigemina to the tegmentum; m., further course of these fibres; S.S., fibres from the corpus striatum and lenticular nucleus to the crusta of the pedunculus cerebri; M., further course of these; S.S., course of the sensory fibres; R., transverse section of the spinal cord; v.W., anterior, and h.W., posterior roots; a., association system of fibres; c.c., commissural fibres; II., transverse section through the posterior pair of the corpora quadrigemina and the pedunculi cerebri of man; p., crusta of the peduncle; s., substantia nigra; v., corpora quadrigemina with a section of the aqueduct; III., the same of the dog; IV., of an ape; V., of the guinea-pig.

enter, and some pass up in the lateral column in front of the pyramidal tract, others into the posterior column, and still others ascend in the gray matter on the opposite side of the cord. In the medulla the



sensory impulses travel through the reticular formation, through the posterior half of the pons, and enter the tegmentum of the crura cerebri, pass under the corpora quadrigemina to enter the posterior third of the posterior limb of the internal capsule, and thence radiate to the cortex of the occipital and temporo-sphenoidal lobe. The path of the sensory fibres, therefore, in some part of its course undergoes decussation, either in the cord, the medulla, or the pons, so that the cortex of each cerebral hemisphere receives sensory impulses which originate in impressions made on the opposite side of the body: hence, a destructive lesion of the cerebral cortex, internal capsule (posterior third), or of one-half of the cord causes anæsthesia of the opposite side of the body. The major part of the crossing, however, occurs in the posterior commissure of the cord.

Voluntary motor impulses originate in the cells of the cortex in the motor areas of the cerebrum, pass through the radiating fibres of the white matter of the cerebral hemispheres, to converge into the internal capsule, which is a collection of white nerve-fibres lying between the caudate nucleus and optic thalamus internally and the lenticular nucleus externally. They then enter the basis of the crura cerebri, occupying its middle third, the fibres for the face being next the middle line and those for the leg most external, the fibres for the arm lying between the two; they then pass to the pons, the facial fibres here undergoing decussation (becoming connected with the nuclei of the facial and hypoglossal nerves), the others continuing on the same side to the anterior pyramids of the medulla oblongata, where the major part crosses to the opposite side of the cord, where they descend in the lateral column (the crossed pyramidal tract); while the uncrossed fibres descend in the anterior columns of the same side, ultimately, in all probability, crossing through the white commissure. All the fibres of both pyramidal tracts terminate at different levels in the multipolar cells of the anterior cornua of the gray matter of the cord, and from each of these cells originates a single unbranched process which, joining with similar fibres, passes out of the cord in the anterior roots of the spinal nerves. The course of these motor and sensory fibres is likewise shown in Figs. 360 and 361. The cerebellum receives through its inferior peduncle the afferent fibres derived from the lateral (*direct cerebellar tract*) and posterior columns of the cord, as well as from the gray matter. The muscular sense is supposed to be conducted by means of Clarke's column, together with the direct cerebellar columns, while tactile sensations pass through Burdach's column. While, therefore, the sensations of pain are conducted directly to the cerebrum, tactile and muscular sensations first reach the cerebellum and may from thence be conducted to the cerebrum through the superior peduncle of the cerebellum, passing into the posterior part of the corpora quadrigemina and then, perhaps, forming connection with the caudate nucleus.

## I.

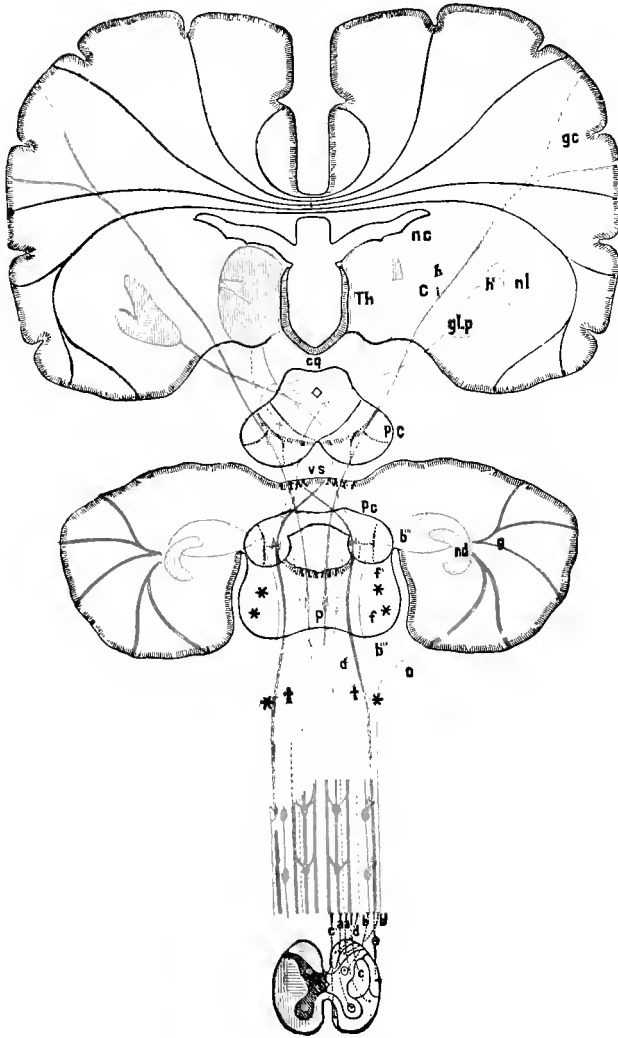

FIG. 360.

FIGS. 360 AND 361.—DIAGRAMS OF THE COURSE OF THE NERVE-FIBRES IN THE SUBSTANCE OF THE BRAIN AND SPINAL CORD, AFTER AEBY. (Ranney.)

I, view of a transverse section; II, profile view; III, the nuclei of the medulla (partly after Erb). The crosses of color corresponding to the lines upon which they are placed designate the point of section of each tract as it passes through different levels (the crus and pons). C i, *internal capsule*, with radiating fibres (in yellow), pyramidal fibres (red), and fibres going to the pons (in purple); P C, the *crura cerebri*, with the pyramidal fibres and the fibres going to the ganglia of the pons anteriorly, and posteriorly the substantia niger, the fillet tract (in dotted lines), the fibres of the superior peduncle of the cerebellum (in blue); P c, the *peduncles of the cerebellum*, showing the fibres going to the cerebrum, the pons, and the

II.

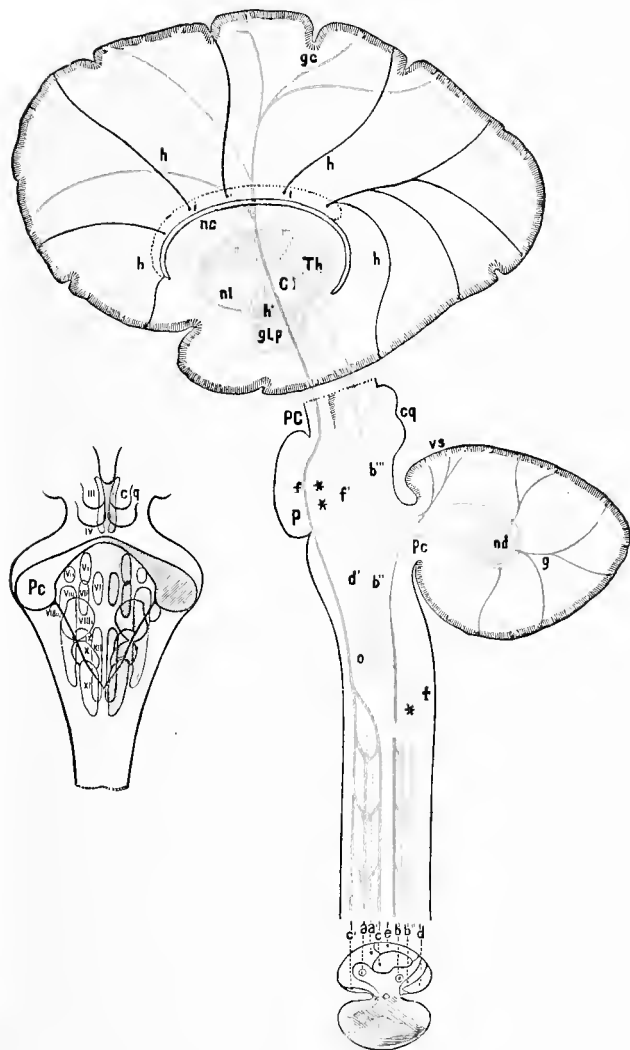

FIG. 361.

medulla; P, pons varolii, with its ganglia on either side (in purple). In III, the nuclei of the cranial nerves-roots are numbered to correspond with the nerves. Red is used for the motor nuclei, and blue for the sensory nuclei. The tracts in the cord are designated by the area similarly colored in the cross-section of the cord beneath. c', column of Furek; c, crossed pyramidal column; a, anterior horn; d', anterior root-zone; e, direct cerebellar column; b, posterior horn; b', column of Burdach; d, column of Goll. Higher up are seen b'', the inferior peduncle of the cerebellum; d', the fillet or lemniscus tract; f, the fibres connecting the ganglia of the pons with the cerebrum and cerebellum; b''', the fibres of the superior cerebellar peduncle; h, the caudo-lenticular and thalamo-cortical fibres; i, the commissural fibres; Th, optic thalamus; nc, nucleus caudatus; nl, nucleus lenticularis; gc, central convolutions.

In this diagram the course of b'' seems to be in error in not undergoing a decussation.

## VII. THE CRANIAL NERVES.

The cranial nerves, twelve in number on each side, arise from different parts of the brain and pass through foramina in the base of the skull, their number being given to them from the order in which they pass out from the base of the brain; other names are, also, given them from the parts to which they are distributed or from their functions.

The cranial nerves are either pure sensory nerves, pure motor nerves, or mixed nerves. The pure sensory nerves are the olfactory (1), optic (2), and acoustic (8); the pure motor nerves are the oculo-motor (3), the pathetic (4), and the abduens (6); the trifacial (5), or trigeminus, is a mixed nerve, arising from a distinct motor and a distinct sensory root comparable to the spinal nerves. Regarding the functions of the other cranial nerves as determined by the functions of their roots, the pneumogastric and glosso-pharyngeal are sensory nerves and the facial, spinal-accessory, and hypoglossal nerves are motor. The trunks of these last five nerves, however, contain both afferent and efferent fibres, the pneumogastric receiving efferent fibres from the spinal-accessory and the glosso-pharyngeal from the facial and motor branch of the trigeminus; while the facial receives afferent fibres from the trigeminus, pneumogastric, and glosso-pharyngeal, and the hypoglossal sensory fibres from the trigeminus, vagus, and three upper cervical nerves.

The functions of these nerves, although already considered under different subjects, will be here recapitulated.

1. THE OLFACTORY NERVE. (See Sense of Smell.)

2. THE OPTIC NERVE. (See Sense of Vision.)

3. THE OCULO-MOTOR NERVE.—This nerve arises from the oculo-motor nucleus under the aqueduct of Sylvius, the fibres of origin being traced into the corpora quadrigemina and through the cerebral peduncle into the lenticular nucleus. It contains three sets of fibres which are distributed (1) to all the muscles of eyeball, with the exception of the superior oblique and external rectus muscles and the levator palpebræ muscles, (2) to the circular muscles of the pupil, and (3) to the ciliary muscle. Hence, it is the path for voluntary motor impulses to all the muscles of the eyeball, with the exception of the muscles above mentioned, it is the efferent nerve for the reflex contraction of the pupil from the action of light on the retina, and it contains the voluntary motor fibres to the muscle of accommodation (ciliary muscle).

4. THE PATHETIC NERVE (*Trochlearis*).—The fibres of the fourth cranial nerve may be traced back from their apparent origin on the outer side of the crus cerebri in front of the pons varolii, beneath the corpora quadrigemina, to the valve of Vieussens (*behind* the fourth ventricle), on the upper surface of which it is connected by commissural fibres with its

fellow from the opposite side. The gray nucleus from which it arises is the posterior part of the oculo-motor nucleus in the floor of the aqueduct of Sylvius; it also is connected with a gray nucleus in the part of the floor of the fourth ventricle near to the origin of the fifth nerve. It is a purely motor nerve and is distributed to the superior oblique muscle of the eyeball.

5. **THE TRIFACIAL NERVE** (*Trigeminus*).—This is a mixed nerve, arising, like the spinal nerves, from a motor and sensory root, the latter being supplied with a ganglion (ganglion of Gasser). The anterior, smaller, motor root arises in the motor trigeminal nucleus in the floor of the fourth ventricle, which is connected with the cortical motor centre on the opposite side of the cerebrum; there is also a descending motor root from the corpora quadrigemina. The larger posterior sensory root is connected with the sensory trigeminal nucleus at the level of the pons with the gray matter of the posterior horns of the spinal cord as far as the cervical vertebra, constituting the ascending root, and with the cerebellum through the crura cerebelli. This extensive origin of the sensory fibres explains the great number of reflex relations of this nerve.

After passing through the cranium the trifacial nerve divides into three divisions—the ophthalmic, superior maxillary, and inferior maxillary branches.

The *ophthalmic division*, which receives fibres from the sympathetic nerve, supplies *sensory* branches to the conjunctiva, lachrymal gland, upper eyelid, brow, and root of nose, trophic fibres to the eyeball, and vaso-motor fibres to the dura mater and lachrymal gland. It is also the afferent nerve for the reflex stimulation of the lachrymal secretion.

The *superior maxillary division* supplies sensory nerves to the dura mater, to the angle of the eye, skin of temple and cheek, to the teeth in the upper jaw, gums, periosteum, the lower eyelid, bridge and sides of the nose and upper lip as far as the angle of the mouth, nasal chambers, hard and soft palate. By receiving motor fibres from the facial (superficial petrosal branch to Meekel's ganglion) it gives motor nerves to the soft palate and uvula, and, receiving vaso-motor fibres from the cervical plexus, it is the vaso-motor nerve for this entire region.

The *inferior maxillary division* contains all the motor fibres of the fifth nerve and supplies motor nerves to the muscles of mastication, the tensor palati, and tensor tympani muscles. It also contains sensory fibres which are distributed to the mucous membrane of the cheek, lower lip, teeth, external auditory canal, and tip of tongue, the lingual branch being, further, the special nerve of taste. This division also contains trophic and vaso-motor fibres.

6. **THE ABDUCENS NERVE**.—The sixth cranial nerve arises from the eminentia teres in the fourth ventricle in front of and partly from the

nucleus of the facial nerve, its nucleus being connected with the nucleus of the third nerve on the opposite side. It is the motor nerve of the external rectus muscle of the eye. In co-ordinate movements of the eyes its action is involuntary. It receives fibres from the sympathetic nerve in the neck.

7. **THE FACIAL NERVE.**—The facial nerve consists solely of efferent fibres, and arises by two roots from the floor of the fourth ventricle, of which the smaller, through the nerve of Wrisberg, forms a connection with the auditory nerve. The origin of the facial, the facial nucleus, lies behind the origin of the sixth nerve and is connected with the cerebrum of the opposite side. The facial nerve is the motor nerve of the muscles of the face, and hence is called the nerve of expression. It also supplies motor branches to the stylo-hyoid, posterior belly of the digastric, buccinator, stapedius, muscles of the external ear, platysma, and levator palati. It is the secretory nerve of the parotid, and through the chorda tympani of the submaxillary gland. It also contains vaso-motor fibres for the tongue and side of the face and vaso-dilator fibres for the submaxillary gland. Through its anastomoses with the trigeminus and vagus it perhaps contains afferent fibres.

8. **THE AUDITORY NERVE.**—(See Sense of Hearing.)

9. **THE GLOSSO-PHARYNGEAL NERVE.**—This nerve arises from the glosso-pharyngeal nucleus deep in the medulla oblongata near the olivary body, and is connected with the nucleus of the vagus. An ascending root from the spinal cord unites with it and serves for the production of spinal reflexes. It is supplied to the palatine and pharyngeal muscles, but its motor function to these muscles is not absolutely established; possibly its motor fibres are derived from the facial. It is the nerve of taste for the back of the tongue and pharynx, as well as being the nerve of general sensation for these parts, the Eustachian tube and tympanum.

10. **THE PNEUMOGASTRIC NERVE.**—The vagus nerve has a common nucleus with the ninth and eleventh nerves in the ala cinerea in the lower half of the calamus scriptorius. It contains both afferent and efferent fibres, the latter, probably, being derived from the spinal-accessory. The efferent fibres are distributed to the muscles of the pharynx, larynx, trachea, bronchi, œsophagus, stomach, and intestines. It is also the inhibitory nerve of the heart, and contains vaso-motor fibres for the lungs and trophic fibres for the lungs and heart. It is the sensory nerve for the external ear, pharynx, œsophagus, stomach, and respiratory passages. It contains afferent fibres, which may augment or inhibit (laryngeal nerve) the respiratory centre, augment the cardio-inhibitory centre, inhibit the medullary vaso-motor centre (depressor nerve); through it afferent impressions may pass which produce the salivary or inhibit the pancreatic secretions.

11. **THE SPINAL-ACCESSORY NERVE.**—This nerve arises by two separate roots, one from the accessory nucleus of the medulla, which is connected with the nucleus of the vagus, the other between the anterior and posterior roots of the spinal nerves, as far down as the fifth cervical nerve, its fibres in the cord having been traced to a nucleus on the outer side of the anterior cornua. The anterior branch passes entirely into the vagus and gives to it most of its motor fibres and all the cardio-inhibitory fibres. The spinal-accessory is the motor nerve to the sternomastoid and trapezius muscles; it receives sensory branches from the cervical nerves.

12. **THE HYPOGLOSSAL NERVE.**—The hypoglossal nerve arises from two large-celled nuclei in the calamus scriptorius and one adjoining small-celled nucleus, being connected both with the olivary body and the brain. It is the motor nerve for the muscles of the tongue and most of the hyoid muscles. It receives afferent fibres from the fifth and tenth nerves and vaso-motor fibres from the sympathetic.

### VIII. THE SYMPATHETIC NERVOUS SYSTEM.

The great sympathetic nerve, constituted by a ganglionic chain, composed of a series of ganglia connected by nerve-fibres, is located on each side of the vertebral column. Three different forms of structure may be recognized in this portion of the nervous system—the ganglia, the peripheral branches, and the connecting filaments. The two chains situated on each side of the median line are connected by transverse fibres, giving off numerous branches, which anastomose among themselves and form plexuses (Fig. 362).

The sympathetic nerve may be divided into three divisions. In the cephalic portion are found the ophthalmic, the spheno-palatine, the otic, the submaxillary, and the sublingual, with the three cervical ganglia. In the thorax and abdomen are found the other two divisions, which likewise consist of a number of ganglia united together by anastomosing filaments.

The ganglia consist of gray substance united with nerve-tubules.

The fibres are non-medullated and connect the ganglia. Each spinal nerve forms connections with adjacent sympathetic ganglia by means of the rami communicantes, which are formed by nerve-fibres coming from both the anterior and the posterior roots of the spinal nerves. In addition to the non-medullated fibres entering into the constitution of the great sympathetic nerve are also fine nerve-tubules, which in their structure are analogous to those of the cerebro-spinal axis. Such filaments are much less abundant than the gray or non-medullated fibres of Remak.

The functions of the sympathetic nervous system have already been

given somewhat in detail in previous sections. The most important function which it fulfills in the animal economy is in the regulation of the calibre of the blood-vessels. This has already been described under the subject of the Circulation.

The sympathetic likewise possesses a number of independent functions either in the way of inhibiting or stimulating various processes which ordinarily are controlled by the cerebro-spinal nerves. As examples of such action may be mentioned the automatic ganglia of the heart, the mesenteric plexuses of the intestine, and the sympathetic plexuses of the uterus, Fallopian tubes, and ureters. Of course, here, also, the share of the sympathetic in regulating the calibre of the blood-vessels occupies an important position.

The sympathetic nerve, also, in addition to such functions in which this nerve may be regarded as an efferent nerve, carrying impulses from the central nervous system, likewise acts as an afferent nerve; as, for instance, in the conduction of sensory impressions from the abdominal viscera through the splanchnic nerves. It has further been claimed that the various ganglia of the sympathetic may themselves act as reflex centres, but no clear demonstration of this statement has ever been reached. Its strongest advocate was Claude Bernard, and he pointed to the submaxillary ganglion as an illustration of such an independent action on the part of the sympathetic ganglia. We have already discussed the grounds for doubting the correctness of this statement.

Probably the main function of the ganglia of the sympathetic nervous system is to modify impulses coming from the central nervous

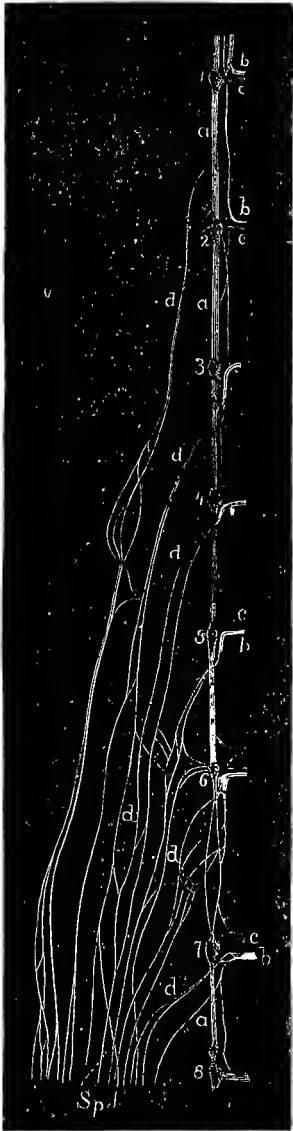

FIG. 362.—SYMPATHETIC NERVE OF THE HORSE. (Flesch.)

a, main trunk; b, rami communicantes; c, gray commissural fibres; d, roots of the splanchnic nerve; Sp., splanchnic nerve.

system is to modify impulses coming from the central nervous



system, through the cerebro-spinal nerves, so as to inhibit or modify the function of certain organs. As an illustration of this may be mentioned the action of the sympathetic upon the pupil. According to Budge, the fibres which are concerned in producing dilatation of the pupil arise from the spinal cord and run from the upper two dorsal and the lowest two cervical nerves into the cervical sympathetic, which conveys them to the head. The influence of the sympathetic in governing the movements of the iris will be given more in detail in the consideration of the eye.

Among other branches arising from the cervical part of the sympathetic are found motor branches going partly to the external rectus muscle of the eye, vaso-motor branches to the ear, the side of the face, the conjunctiva, the iris, the choroid, and to the vessels of this portion of the alimentary and respiratory tract. Secretory and vaso-motor fibres are distributed to the salivary glands and to the sweat-glands of the integument; while, according to certain authorities, the lachrymal glands receive sympathetic secretory fibres from this portion of the sympathetic.

Of the thoracic and abdominal sections of the sympathetic the cardiac plexus, which receives accelerator fibres for the heart, occupies the most important position. The influence of the cœliac plexus of the sympathetic on the heart has already been given. Of the abdominal sympathetic, the cœliac and mesenteric plexuses and the splanchnic nerves are the most important. They also have been already described.

It is thus seen that the fibres of the sympathetic nervous system act as conductors of both afferent and efferent impressions. Impressions traveling from the periphery to the centre through the sympathetic nerve do not produce an impression upon the sensorium. In other words, the brain is not capable of taking cognizance of afferent impulses traveling through the sympathetic. Nor, on the other hand, can voluntary motor impulses pass through this nerve.

#### IX. GENERAL AND SPECIAL SENSIBILITY.

Sensation, or general sensibility, is that function of the brain by which it perceives or becomes conscious of impressions which are made upon the surface of the body or upon the nerves running from the periphery to the nerve-centres. By perception is meant that faculty by which sensations are referred to certain external causes. It is important to understand that all sensations take place, not at the point of contact of the irritant with the periphery, but in the brain itself, and we have evidence of this in the fact that if the brain be in a state of torpor no sensation occurs. Again, if a ligature be passed around an afferent nerve at some point between its origin on the periphery and its termination in the nerve-centre no sensation occurs, no matter how severe be the

stimulation of its peripheral ends; or, if the nerve-trunk be divided, the most powerful irritants may be applied to the peripheral area in which that nerve is distributed without calling forth sensation.

When an impression is made upon a sentient surface, that impression so changes the molecular equilibrium in the terminal filaments as to give rise to afferent impressions, which travel along the nerve-trunk to reach the centres of the brain, and it is the final change which occurs within the nerve-cells which is to be spoken of as sensation, and it is only this latter change of which the brain is cognizant.

Two kinds of sensibility may be recognized,—general and special sensibility. Nerves of general and of special sense are concerned in the perception of these two kinds of sensation. By the term special sensibility is understood that sensation which arises from an impression of a peculiar kind and special character, which is capable of affecting only one kind of nerve; or, rather, which, when applied to one kind of nerve, will invariably produce a sensation peculiar to that nerve. Thus, for example, a stimulus applied to the terminal filaments of the nerve of hearing will invariably be recognized as an auditory sensation; so a stimulus of the optic nerve, whether mechanical, electrical, or chemical, will be recognized as a visual sensation.

By general sensibility is meant the appreciation of sensations arising from impressions of a general character applied to the general tegumentary surface of the body. Under this head are to be included the tactile sense, the sense of heat and cold, and the muscular sense. The special sensations are the sensations of smell, taste, sight, and audition.

Certain conditions are necessary to sensibility. *First*, there must be a certain degree of vascularity. Unless the part be well supplied with blood it cannot be endowed with either general or special sensibility. An illustration of this may be seen on tying any large artery; the part to which it is supplied becomes almost instantly numb; the blood is cut off, the vascularity diminishes, and the irritability of the receptive filaments of the nerve becomes depressed. So, also, cold, as is well known, reduces sensibility by diminishing the blood-supply of the part.

*Secondly*, mere vascularity is not, however, sufficient; there must, likewise, be continuity with the nerve-trunk. Unless the afferent fibres be in such continuity with the centre no sensibility, either general or special, may take place. While, *finally*, the centre itself must be in a state of integrity to recognize or convert into perceptions the impressions brought to it through afferent nerves.

When impressions have been frequently repeated upon nerves of general or special sensibility the sensations to which they ordinarily administer become blunted. An illustration of this may readily be drawn from the nerves of special sense. Sights or sounds constantly present

to the eye or ear after a while fail to impress them. So, also, odors may cease to be recognized.

This point, however, must not be misunderstood. If continued attention be directed to sensations, instead of being blunted they are exalted. Of this we have numerous examples in the capability of the senses to attain a high degree of acuteness of perception from education.

When an impression has been made upon a nerve of special sensibility, or even upon one of general sensibility, that impression always remains a certain length of time after the irritating cause has been removed; thus, when an ignited stick is rapidly moved before the eye the impression made upon the retina in each successive position of the burning point remains sufficiently long to appear continuous with that made in the next situation, and thus the appearance of a line of light is obtained. So in the case of the ear; it is well recognized that musical tones are produced by a regular succession of vibrations. When these vibrations succeed each other more frequently than sixteen times in a second they give rise to a continuous tone. When they occur less frequently than sixteen times in a second there is produced a succession of impressions, each one terminating before the other begins. No nerve of special sense can take upon itself the function of any other; thus the auditory nerve is incapable of transmitting visual impressions, nor can the olfactory nerve serve for audition. In the case of the nerves of general sensibility, the incapability of interchange of function cannot be so positively denied, since we know that a motor nerve may so unite with a sensory nerve as to conduct afferent impressions; or in the case of the sense of taste, which is one of the lowest of the special senses, we shall find that there other than the special nerves of taste may, perhaps, serve for conducting gustatory impressions.

While the nerves of special sense are especially adapted for receiving certain impressions, they may yet be thrown into a condition of irritability by various stimuli, but each of these stimuli will produce the impression characteristic of the nerve over which it passes.

Sensations have been divided into two classes, external and internal, or objective and subjective. External impressions are those which arise from impressions made upon the external surface of the body. By internal impressions are meant those which arise from impressions made upon the internal recesses of the body. All sensations, however, originate and depend upon changes taking place in the gray matter of the brain itself, and, as a consequence, there is no sensation (which in general terms is produced by an impression made upon the peripheral termination of the nerve) which may not to a certain degree be produced by an impression made upon the nerve in its course or at the point in the sensorium where the nerve terminates. To this latter

class of sensations the term subjective is given in contra-distinction to objective sensations, which result from impressions made upon the termination of the nerve. It is a curious fact with regard to internal or subjective sensations that those which arise from impressions made upon a nerve in its course are always referred to the peripheral termination of the nerve on the surface of the body. Thus, if the ulnar nerve is compressed at the elbow-joint the impression is not felt at the point of stimulation, but at the extremity of the fingers. The most common cause of subjective sensations is to be found in changes of the blood-supply of the part; thus, for example, when congestion takes place about the termination of the optic nerve there are flashes of light about the eye; if about the auditory nerve, ringing sounds in the ear.

By the term sensory organs is meant those parts of the body by which, through the nerves of sense, the brain becomes cognizant of its surroundings.

By means of the special senses the preservation of both the individual and of the species is rendered possible. By means of the special senses animals are rendered capable of seeking and recognizing their food and are enabled to avoid danger, and, in a way to be indicated directly, are led to the accomplishment of the act of reproduction.

The more restricted the peripheral portion of any nerve of special sense the more delicate is the structure of that terminal organ. In the case of the sensations of taste and of smell the nerves distribute themselves over a moist mucous membrane which has other functions to fulfill in addition to acting as the peripheral terminations of nerves of special sense. On the other hand, in the case of the nerves of sight and hearing, the terminations are found in structures whose sole function is found in ministering to these special sensations, and in them we find the highest degree of complexity of the end apparatuses.

It is, of course, not possible to decide whether or not in the case of the lower animals impressions made upon the nerves of sense affect the brain in the same manner as in man, since in these animals the expression of sensations is greatly restricted: but from the great similarity of structure of the organs of sense in man and in the higher mammals it may be concluded that impressions are appreciated by these animals in the same manner as in man. As a general rule it may be stated that the senses of the domestic animals are quite as highly developed as in man, and in certain instances greatly exceed in acuteness the corresponding sense in man. Usually, in any special class of animals we find one of the special senses developed out of proportion to the others. Domestication has the usual result of reducing the acuteness of the special senses, since the principal cause for their exercise in the protection of the animal is no longer present.

## A. THE SENSE OF SMELL.

By the sense of smell animals are to a certain extent facilitated in their search for food, in the avoidance of danger, and in seeking the opposite sex.

By the sense of smell is meant the sensation that is created when certain substances in a gaseous form are inhaled by the nostrils. It will be shown that the sense of smell is only excited under certain definite conditions and only when the odorous body comes directly in contact with the organs of sense. Here, as in the case of taste, the sensation is locally excited, probably through some chemical influence, and the result is an entirely specific sensation. It is, therefore, unwarrantable to include the sense of smell among the other senses, since it is quite as different from the sense of touch or of taste as from sight or hearing. The action of the organ of smell is, therefore, due to a special nerve, the olfactory nerve, the first cranial pair, which differs from the others in origin, position, extension, and mode of distribution.

Under the name of olfactory nerves are usually described the masses of gray matter which arise from the anterior portion of the frontal lobe, and in many animals exist in such bulk as to project beyond the frontal lobes. From the structure of these masses, as well as from comparative anatomy and from their developmental history, it is evident that these parts are not to be regarded as identical with the peripheral branches of other nerves of sense, or the cranial nerves, but are to be regarded as distinct parts of the brain. In many animals the olfactory lobes are hollow, their ventricles communicating with the other ventricles of the brain. As olfactory nerves only are to be described the fibres which originate from these olfactory bulbs and pass through the cribriform plate of the ethmoid bone to be distributed to the olfactory portion of the nasal cavities.

Fibres from the olfactory lobes have been traced in three bundles backward into the cerebral hemispheres, and the centre for smell in the cortex of the brain has been located in the tip of the uncinate gyrus on the inner surface of the cerebral hemisphere. Of these three roots, the inner one is small, the middle one is large and curves inward to the anterior commissure around the head of the caudate nucleus and decussates through the anterior commissure to the extremity of the opposite temporo-sphenoidal lobe. The outer root passes transversely into the pyriform lobe and ends in the anterior extremity of the optic thalamus.

Microscopic examination of the olfactory fibres, by which are meant the fibres passing through the cribriform plate, shows that they are thin, transparent fibres, included in a nucleated connective-tissue sheath.

Examination of the structure of the membrane lining the nasal cavities shows marked points of distinction between the region to which the olfactory fibres have been traced and other portions of the nasal chambers. The area of distribution of the olfactory nerve is termed the *regio olfactoria*, and in the main embraces the upper part of the septum and the upper part of the middle turbinated bone. The remainder of the nasal cavity is called the *regio respiratoria*. The olfactory region has a thicker mucous membrane than the respiratory part. It is covered by a single layer of cylindrical epithelial cells, which contain yellow pigment in sufficiently large quantity to serve even by the naked eye to distinguish this part of the nose from the respiratory passages. The latter division of the nasal cavity is covered by ciliated epithelium and contains tubular glands and serous, acinous glands. In the olfactory region are found between the ordinary cylindrical epithelium cells peculiar

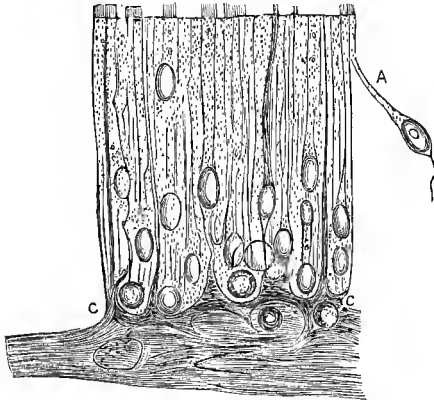

FIG. 363.—DIAGRAM OF THE STRUCTURE OF THE OLFACTORY REGION, AFTER EXNER. (*Brücke.*)

C C, the terminal net-work of the olfactory nerve in which both the so-called olfactory cells (A) and cylindrical cells are imbedded.

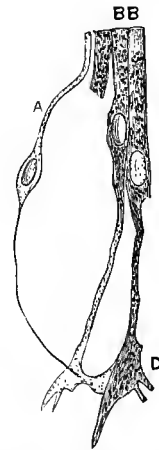

FIG. 364.—DIAGRAM ILLUSTRATING THE MODE OF CONNECTION OF THE OLFACTORY AND CYLINDRICAL CELLS WITH THE TERMINAL NET-WORK OF THE OLFACTORY NERVE. (*Brücke.*)

BB, cylindrical epithelial cells; A, olfactory cell; D, protoplasmic mesh-work in which the olfactory nerve terminates.

spindle-shaped cells with a large nucleus, containing nucleoli, and sending up between the cylindrical cells a narrow projection which in various animals terminates in delicate projecting filaments. These peculiar olfactory cells are said to form a direct communication with the fibres of the olfactory nerve.

It is probable, according to Exner, that these cells do not directly unite with the olfactory fibres, but through the mediation of a net-work of protoplasmic prolongations of these cells lying below their bases. Examination has further shown that not only these long so-called

olfactory cells form communication with this net-work, but, also, processes may be traced into it from the so-called cylindrical cells, and, this being the fact, it would seem unwarrantable now to draw a sharp distinction between the functions of these two classes of cells (Figs. 363 and 364).

In the herbivora the convolutions of the inferior turbinated plate are, as a rule, simpler than in the carnivora, but yet more complex than in man. In the ruminants and solipedes the inferior turbinated bone divides into two plates which are rolled around each other in opposite directions. In most of the carnivora it is also similarly convoluted, but the divisions are much more frequent and the spaces between the different leaves narrow. In the case of the inferior turbinated bone the higher degree of complication does not point, as in the case of the superior turbinated bones, to a higher degree of development of the sense of smell, but in animals where this condition is present it is to be regarded as a means of mechanical protection against the entrance of foreign bodies into the nose.

The different cavities in connection with the nasal chambers, such as the frontal, sphenoidal, and maxillary sinuses, have no connection with the sense of smell, but are to be regarded simply as extensions of the respiratory parts of the nasal chambers; for their mucous membrane is identical with that lining this portion of the nose and contains no terminal filaments of the olfactory nerve. This also applies to the case of the ethmoidal cells; all these cavities, therefore, are simply concerned in warming the inspired air.

Jacobson's organ, on the other hand, is to be regarded as an accessory organ of olfaction. It is present in all mammals, and consists of two narrow tubes protected by cartilage and placed in the lower and anterior part of the nasal septum. Each tube is closed behind, but anteriorly opens into the nasal chamber by a furrow, the naso-palatine canal. The wall next the middle line is connected with the olfactory epithelium, which is in direct communication with the terminal filaments of the olfactory nerve. The outer wall is covered with columnar, ciliated epithelium.

The nose in mammals is generally but slightly detached from the bones of the face. In solipedes and ruminants the nares, which are possessed of a considerable degree of mobility, project but slightly, while in various members of the hog tribe the nose is prolonged anteriorly, forming the snout or muzzle. In the elephant and in the tapir its prolongation acquires its maximum development. In the cetaceans and other aquatic mammals in which the olfactory nerve is absent, as in the dolphin, or where it is only faintly developed, the nasal chambers lose all significance as organs of olfaction and simply fulfill a respiratory function.

In birds the sense of olfaction is less strongly developed than in mammals, its place probably being taken by the higher degree of development of the sense of sight. As a consequence their nasal chambers are simple; at the most three turbinated plates (anterior, middle, and posterior) are present, and these are simple in form. The olfactory nerve is distributed alone to the posterior turbinated bone. The external nares show great variations in shape, while the posterior nares communicate by a small, slit-like opening with the aural cavity. The olfactory lobes are most highly developed in birds of prey and in palmipedes who feed on living fish.

In amphibia the nasal chambers are even less complicated than is the case in birds. The turbinated plates are rudimentary and usually reduced to one in number. In reptiles generally the nasal chambers are limited in extent and are formed of two canals opening externally, and internally communicating with the mouth by two canals passing through the palatine arch.

In the fish the olfactory apparatus is not so arranged as to be traversed by a current of air. In them the olfactory organ consists of two small cavities terminating in a *cul-de-sac* and opening externally by two nostrils. The bottom of these sacs is generally thrown up into folds, arranged as radii from a central point to which fibres coming from the olfactory lobe have been traced. Water carrying odors to this olfactory membrane can affect it but slightly, unless we can conclude that their method of olfaction differs entirely from what holds in air-breathing animals; for we find that if in the latter the nasal chambers be filled with liquid all impression on the sense of smell is impossible.

In the invertebrates no organ of smell can be recognized in the articulates or in the mollusks. It is, nevertheless, certain that in some of the invertebrates, and particularly in insects, the sense of smell is highly developed. It has been supposed that here the antennæ or tentacula are the seat of the sense of smell.

For any substance to be odorous it must possess two properties. In the first place, it must be volatile—that is, be capable of passing into the atmosphere; and, in the second place, it must to a certain extent be soluble in water, that it may pass by imbibition into the fluid which invariably moistens the olfactory membrane. Odorous substances inhaled with the air are brought into contact with the olfactory mucous membrane and act on the terminal cells of the olfactory nerve and not directly upon the nerve-fibres; for we may conclude that just as neither the optic nerve-fibres are affected by waves of light, nor the auditory nerve-fibres by waves of sound, the fibres of the olfactory nerve are equally insensitive to odors. Smell consists, therefore, in the production of some change, probably of a chemical nature, in the terminal apparatus



in the mucous membrane of the olfactory portion of the nose. Changes there excited are conducted through the nerve-filaments to the brain, and only then become recognized as the sensation of smell.

It would appear that the sensation of smell is only developed on the first contact of the odorous particles with the olfactory nerve, and, as a consequence, in order to obtain an exact perception of delicate odors a number of rapid inspirations are taken, the mouth being kept closed. In this way the air is rarified in the nasal chambers and odorous particles stream over the olfactory region. Consequently, if we hold our breath the sensation of smell ceases, even if we are in an atmosphere impregnated with odorous substances. It is further stated that odorous substances taken into the mouth and then expired through the posterior nares produce no sensation of smell, possibly from the fact that in this direction of the atmospheric current the particles are not brought into contact with the olfactory region; while, when bodies are inhaled with the air through the nostrils, the current of entering air is broken up by striking against the inferior turbinated bone, and part of the current passes directly through the respiratory passages and part upward through the olfactory region.

The reason why odorous liquids placed in the nostrils are incapable of affecting the sense of smell is perhaps to be explained by the action of the fluid upon the olfactory cells, which perhaps possess a high degree of imbibition and are paralyzed when brought in contact with large quantities of fluid. Even water alone, as we know, will temporarily arrest the sense of smell, and if the nostrils be filled with water some time will elapse after the removal of the liquid before the sense of smell is regained.

The amount of substance which may be recognized by the sense of smell is extremely small. Valentin has calculated that  $\frac{1}{300,000,000}$  of a grain of musk may be recognized by the sense of smell. Even this is, perhaps, an inside estimate, for a grain of musk will for years give its characteristic odor to the atmosphere of a room, and the most delicate balance will at the end of this time fail to recognize any reduction in weight, and yet we are compelled to suppose that the odor has been given to the atmosphere through the volatilizing of the particles of the musk.

As regards the sense of smell, all attempts to classify the impressions which may be made upon it entirely fail. The only distinction which can be made is into what are termed pleasant and disagreeable odors, and yet, of course, these are simply relative terms. We may say that a substance has the odor of turpentine or of roses, but this, of course, gives us no means of classifying the causes of the sensations produced.

The intensity of the sense of smell depends, *first*, upon the size of the olfactory surface, since we find that in animals in which the sense of smell is most acute the turbinated bones of the olfactory region are most complicated; *secondly*, on the concentration of the odorous substance in the air; and, *thirdly*, on the frequency with which the columns of air containing the odorous particles are conducted to the olfactory organs; hence sniffing tends to increase the intensity of odors.

The development of the sense of smell is always more highly marked in animals than in man and plays an important part in their organization. Game-dogs, as is well known, will recognize the odor from game-birds at several hundred yards, but even this falls below the acuteness of smell possessed by various animals which are able to scent the presence of man at a distance of a mile or more.

### B. THE SENSE OF SIGHT.

Vision is the perception of the sensation caused by the impression of a ray of light upon the retina, and in all animals depends upon the special sensitiveness of the optic nerve-filaments to the vibration of luminous rays. Animals may, nevertheless, be sensible of light without special organs of vision, and may even be capable of giving evidence of the impression of such light; thus, the hydra, although it has no distinct

organs of vision, will move around from side to side of the vessel in which it is placed until it has reached that on which the sun is shining and will turn itself toward the seat of light.

In its simplest form the visual apparatus is represented by a collection of pigment-cells in the outer coverings of the body which are in connection with the termination of afferent nerves. The pigment absorbs the rays of light, and in that function some process, probably of a chemical nature,

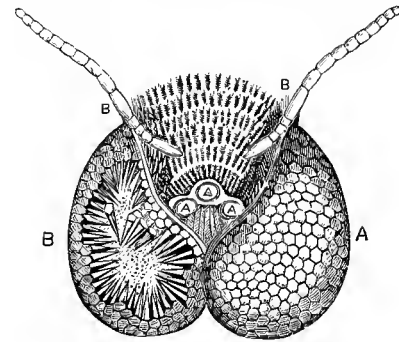

FIG. 365.—HEAD AND COMPOUND EYES OF THE BEE. (Carpenter.)

The ocelli are *in situ* on the one side (A) and displaced on the other (B); A A A, stemmata; B B, antennae.

is excited and the sensitive nerves are stimulated. In the medusæ, as the jelly-fish, and at the ends of the rays of the star-fish and other echinoderms similar collections of pigment are found, but as the lens is wanting no distinct image can be formed, and, consequently, in such cases the distinction between light and darkness is all that is possible. In some of the cephalopod mollusks two simple eyes, consisting of a globular lens with transparent media analogous to the

cornea of higher animals, are found at the tips of the tentacula. Evidences of a choroid and of a nervous net-work representing the retina are also found. Such organs are termed ocelli. It is, therefore, seen that two classes of visual apparatus may be recognized, the simple and the compound; the former consisting simply of a mass of pigment in connection with the nerve-fibres, and the latter of a cornea and of other accessory organs. In many insects and in some crustaceans both species of eyes are found. The simple eyes may be three or more in number and are most usually placed on the summit of the head. In the articulates, such as insects and crustaceans, are found eyes of a special type of construction—what may be termed composite eyes—consisting of a collection of a considerable number of diverging radiating tubes or cones, terminating on the surface in the shape of polygonal opacities and inclosing in their interior a fluid analogous to the vitreous body, while their deep extremity is continuous with the nerve-filament and their

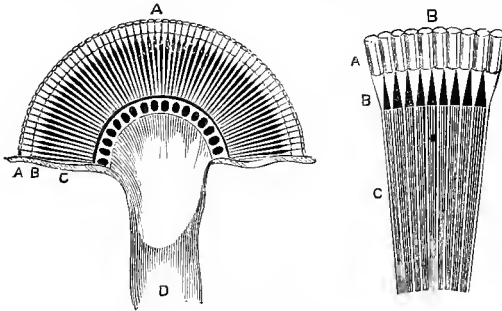

FIG. 366.—SECTION OF THE EYE OF THE COCKCHAFER (*Melolontha vulgaris*). (Carpenter.)

A, facets of the cornea; B, transparent pyramids surrounded with pigment; C, fibres of the optic nerve; D, trunk of the optic nerve. The same description applies to B, which is a portion of the eye more highly magnified.

interior is lined with pigment. Each one of these two eyes, which are frequently but a few millimeters in diameter, often incloses from ten to twenty thousand of these little tubes; while the inclosed membrane, which is analogous to the choroid, is impregnated with pigment over the greater part of its extent, except at the centre, where a transparent opening is present through which the light passes (Fig. 365). These eyes are capable of forming distinct images, but each of the diverging cones, disposed like the rays of a segment of a sphere (Fig. 366), is only capable of transmitting the ray of light which coincides with its long axis; all the other rays, striking more or less obliquely on the internal walls lined with pigment, are absorbed; as a consequence, in such an eye the image is formed by the co-ordination of the rays coming from corresponding isolated points of the object. While, nevertheless, objects may be clearly appreciated by such an eye, a large quantity of light

must be lost by absorption by the pigment, and, as a consequence, the clearness of the image must be sacrificed. The field of vision in such an eye will, of course, depend upon the segment of the sphere represented by the termination of the cones, since, although the eye is convex, no movement in an orbit is possible. So, again, accommodation is not required in such an eye, since all the rays of light appreciated by each cone must be coincident with the axis of each cone. Therefore, such a compound eye may be regarded simply as a combination of an immense number of ocelli compressed together and taking an angular form, in insects six-sided and in crustaceans four-sided. The color of the pigment in such eyes varies, being white, yellow, red, green, purple,

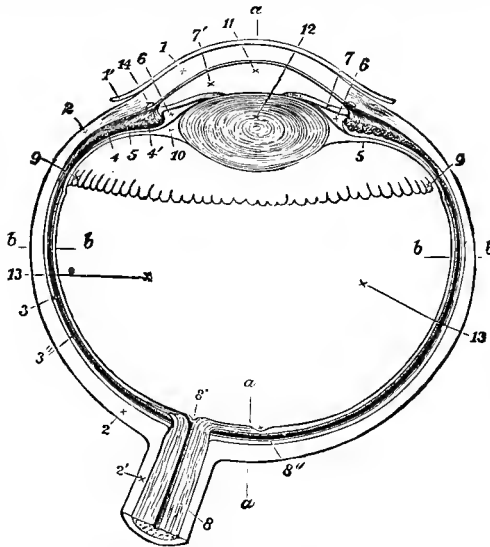

FIG. 367.—DIAGRAM OF A HORIZONTAL SECTION THROUGH THE HUMAN EYE. (*Yeo.*)

1, cornea; 2, sclerotic; 3, choroid; 4, ciliary processes; 5, suspensory ligament of lens; 6, so-called posterior chamber between the iris and the lens; 7, iris; 8, optic nerve; 8', entrance of central artery of retina; *N'*, central depression of retina, or yellow spot; 9, anterior limit of retina; 10, hyaline membrane; 11, aqueous chamber; 12, crystalline lens; 13, vitreous humor; 14, circular venous sinus which lies around the cornea; *a a*, antero-posterior, and *b b*, transverse axes of bulb.

or black. Each cornea, or the termination of each ocellus or tube, is convex on one side and convex or flat on the other, so that, to a certain extent, it takes the part of a lens.

Among the invertebrates the eyes of the cuttle-fish are the largest and most perfect, resembling the eyes of higher animals in possessing a crystalline lens and a chamber behind filled with vitreous humor.

In the vertebrates the eye is formed by a folding in of the external integument to form a lens and an outgrowth from the optic vesicles of the brain to form a sentient surface. The eyeball in vertebrates consists of an external white, spherical case, or sclerotic coat, which serves to

protect the eye from external injury, and, although not transparent, is to a certain extent translucent. Anteriorly it passes into the cornea, which, though equally thick, is absolutely transparent. The latter membrane rises in thickness in front of the eye like a watch-glass. In other words, the radius of curvature of the cornea is that of a smaller circle than that of the body of the eye. The shape of the eye is preserved by two fluids, the aqueous humor filling the cavity behind the cornea, and the denser, jelly-like vitreous humor occupying the larger posterior cavity (Fig. 367).

Between these two chambers is a diaphragm the size of whose aperture is capable of being modified—the iris. Behind the iris lies the crystalline lens and between the vitreous humor and the sclerotic is found the choroid membrane, covered with dark pigment-cells, which are arranged like a mosaic on its inner surface. Between the choroid and the vitreous humor is found the retina, which is the transparent expansion, in a number of layers, of the terminal filaments of the optic nerve.

The most sensitive part of its surface is that which lies in contact with the black pigment. Externally, in most vertebrates, the eyes are protected by eyelids, which are, however, absent in fishes; in them, the eyes being continually bathed in fluid, the lachrymal apparatus is likewise absent. Their eyes are, as a rule, but slightly mobile, the crystalline lens is spherical, the cornea almost flat, and the iris but slightly contractile. In most fishes the eyes are placed so far back that the fields of vision are distinct.

In reptiles three eyelids are often found, although in some, as in the serpents, they are entirely wanting. In the latter case, as in fishes, the ocular globe is then covered only by the transparent conjunctiva. In many reptiles there is often a rudiment of the lachrymal apparatus. The crystalline lens varies greatly in form.

In birds the sense of sight is especially developed. Those which are in the custom of flying at great heights in the atmosphere appear to be able to distinguish with the greatest exactness small bodies on the surface of the earth. In birds, at the centre of the ocular globe and posterior to the crystalline lens, is found a peculiar projection of the choroid, impregnated with the choroid pigment and covered by an extension of the retina, which is termed the *pectin*. It is not known in what way this structure serves to assist vision. Perhaps it contains muscular fibres which act upon the crystalline lens and aid in accommodation.

In mammals the ocular apparatus takes about the same form as is seen in the human species, there scarcely being any difference except in the relative volume of the eyeball and the pupillary opening, and in the fact that sometimes the shape of the eyeball is elongated rather than spherical. Animals which pass the greater part of their time under ground are remarkable for the smallness of their eyeballs. In others



sensations, and we shall, therefore, have then to consider the mode of production of the visual sensations.

1. *The Dioptric Mechanisms of the Eye.*—When rays of light proceed from a luminous body they always pass in straight lines, forming in their divergence a cone, the apex of which is the luminous body and the base such a plane as may intercept them. So long as the medium is of uniform density rays pass in straight lines, and if they come in contact with an opaque, polished surface they will be reflected, and the angle of reflection is equal to the angle of incidence and lies in the same plane (Fig. 368). If the rays fall perpendicularly to this opaque surface they will be reflected in the same straight line in which they impinged. If the rays fall upon a translucent surface as they emerge from the opposite side they will be found to be bent from their original course

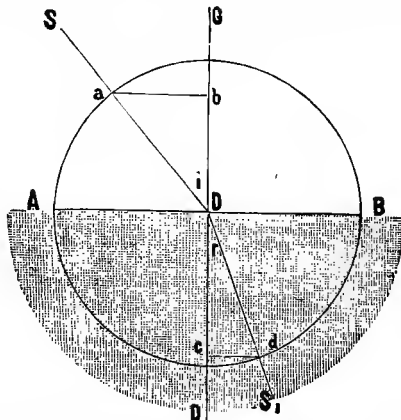

FIG. 370.—DIAGRAM ILLUSTRATING REFRACTION. (*Landois.*)

If  $S_1 D$  represent a ray of light passing through water, when it emerges at  $D$  into the atmosphere it will be bent away from the perpendicular  $G D$  and lie in the direction  $S D$ .

through the medium, and though they pass out of the medium in a line parallel with that in which they entered, yet they are not coincident with it so long as the medium is bounded by parallel surfaces (Fig. 369). If these rays pass from a rarer to a denser medium they are bent toward the perpendicular at the point of incidence. If they pass from a denser to a rarer medium they are refracted from the perpendicular (Fig. 370). Thus, when an oblique luminous ray passes through a piece of plate-glass its course from the atmosphere is from a rarer to a denser medium, hence it is, in the glass, bent toward the perpendicular; but in passing out it passes from a denser to a rarer medium, hence it is refracted from the perpendicular, and as the two surfaces are parallel the amount of refraction toward the perpendicular is equal to the amount of refraction from the perpendicular; therefore the course of the emergent ray is parallel to the course of the entering ray, although not coincident with it.

By the term "refractive index" is meant the number which shows how many times the sine of the angle of incidence ( $ab$ , in Fig. 370, regarding  $SD$  as the incident ray) is greater than the sine of the angle of refraction ( $cd$ ), it being always assumed that in comparing the refractive indices of two media the incident ray passes from air into the medium. On passing from air into water the ray is so refracted that the sine of the angle of incidence is to the sine of the angle of refraction as 4 : 3 ; with glass, the proportion is 3 : 2.

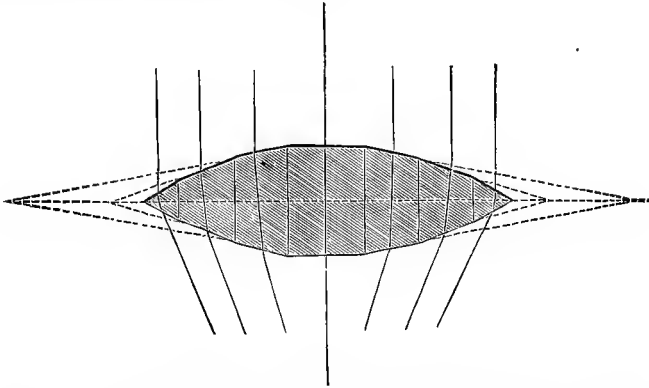

FIG. 371.—DIAGRAM ILLUSTRATING THE COMPOSITION OF A CONVEX LENS OF A NUMBER OF PLANE SURFACES. (*Ganot.*)

An illustration, first suggested by Professor Henry Morton, of Hoboken, serves greatly to simplify the conception of refraction. It has been stated that in passing from a rarer to a denser medium the luminous ray is bent toward the perpendicular. If a line of men, as of soldiers, be marching obliquely toward the edge of a plowed field, the men first reaching the uneven ground will experience difficulty in walking over the rough surface and their end of the line will move more slowly than the end still remaining on the level ground, and, as a consequence, the entire direction of the line of men will be changed. On the other

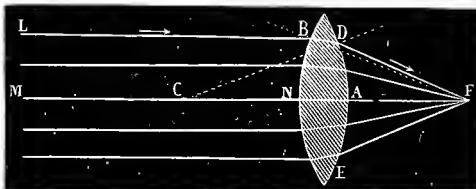

FIG. 372.—DIAGRAM SHOWING REFRACTION BY A DOUBLE CONVEX LENS. (*Ganot.*)

The incident ray,  $LB$ , is refracted at the points of incidence,  $B$ , and emergence,  $D$ , toward the axis,  $MNA$ , which it cuts at  $F$ .

hand, as they reach the opposite side of the plowed surface the end of the line which first entered will be the first to emerge, and, as a consequence, progress now being easier, that end of the line will travel faster than the end still remaining on the plowed ground, and, therefore, the line of men will now be bent from the perpendicular; and as the entire line emerges the line of progress will be parallel with the original line, but will not be coincident with it.



Refraction takes place not only through media with plane surfaces, but likewise through media bounded by curved surfaces, for the circumference of a circle may be supposed to be made up of a number of infinitely small, straight lines: this is indicated in the case of a lens in Fig. 371. Rays of light passing through a double convex lens in passing in are bent toward the perpendicular (Fig. 372). Now, if the rays thus acted upon be followed they will be found to meet at a point on the opposite side of the lens, called the focus, at which light and heat rays will converge. Rays of light striking the centre of curvature of both surfaces of the lens will pass through unchanged. Such a line is called the chief axis, and the centre of this line is the optical centre of the lens. Rays passing through the optical centre are termed principal or chief rays. Rays parallel with the principal axis of the lens are refracted so that they are collected on the opposite side of the lens at a point called the principal focus; the distance of this point from the central point of the lens is called the focal distance. On the other hand, it is evident that rays diverging from a luminous point at the principal focus will be so refracted

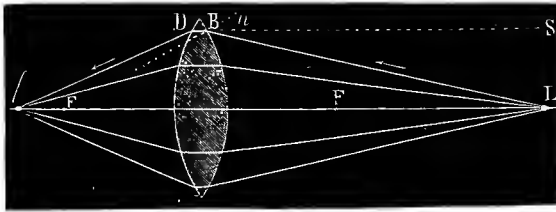

FIG. 373.—DIAGRAM ILLUSTRATING ACTION OF A DOUBLE CONVEX LENS OF HIGH CURVATURE ON DIVERGENT RAYS. (*Ganot*.)

The divergent rays from the luminous point, L, are brought to a focus at *f* behind F, the principal focus at which parallel rays, S B, converge.

as to be parallel when they pass from the lens. Again, rays of light in the principal axis and from a point beyond the principal focus will converge to a point on the opposite side of the lens (Fig. 373).

Four cases are possible: First, when the distance of the light from the lens is equal to the focal distance the focus will lie at the same distance on the opposite side of the lens, *i.e.*, twice the foetal distance; second, if the luminous body approach to the lens, or, what is the same thing, to the focus, then the focal point is moved farther away; third, if the light is still farther from the lens than twice the focal distance, then the focal point comes correspondingly nearer to the lens; fourth, if the rays proceed from a point on the chief axis within the focal distance they will diverge on the opposite side of the lens and not again come to a focus; while, on the other hand, converging rays passing through a convex lens will have their focal distances at a nearer point than that at which parallel rays are collected. These facts are illustrated in the following diagrams (Fig. 374).

In ordinary lenses the amount of refraction at the centre and at the circumference is not equal. Rays passing through the optical centre, as already stated, pass directly without refraction, while those which pass near the centre are less refracted than those which pass near the circum-

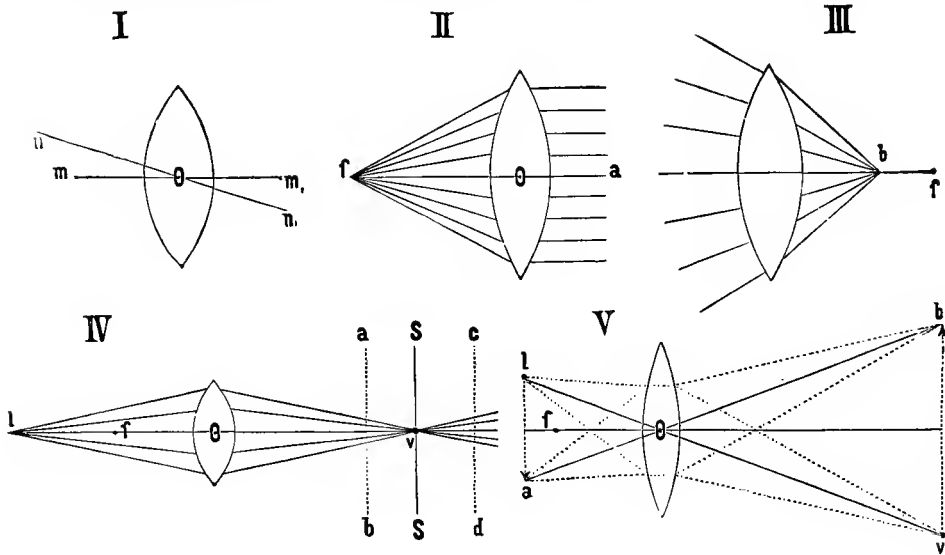

FIG. 374.—ACTION OF A CONVEX LENS ON LIGHT. (Landois.)

I. *m m*, chief axis; *O*, optical centre; rays (*nn*) passing through this centre are principal rays, and are not refracted. II. Parallel rays are collected at a focus, *f*; *f*, *O* being the focal distance. III. Rays diverging from a point, *a*, on the chief axis, within the focal distance, pass out of the other side of the lens less divergent, but do not come to a focus. IV. Rays from a source of light, *l*, beyond the principal focus, *f*, again converge on the opposite side of the lens. V. Formation of an inverted image by a convex lens.

ference; consequently, the amount of refraction increases as the circumference of the lens is approached. This is known as spherical aberration. If a screen be placed in the focus of the rays passing near the centre of

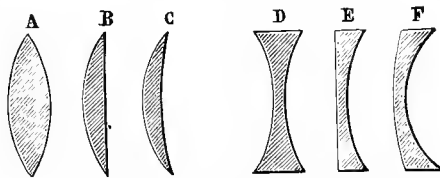

FIG. 375.—DIFFERENT KINDS OF LENSES. (Ganot.)

A, double convex; B, plano-convex; C, converging concavo-convex; D, double concave; E, plano-concave; F, diverging concavo-concave; C and F are also called meniscus lenses.

the lens the resulting image will be bright in its central portion, and will have surrounding it a halo which becomes fainter and fainter as we pass from the centre to the circumference (Fig 376).

Spherical aberration may be corrected in two ways: by increasing

the density of the lens at its central part, in order that it may act more strongly on rays of light, by which the refracting power is increased at that point; this is accomplished in the crystalline lens of the eye in this manner since it is less dense at the circumference than in the centre: or, spherical aberration may be diminished by placing a diaphragm between the object of which the image is to be formed and the lens, so as to cut off those rays which pass through the circumference and allow the image to be formed only by the central rays. This method, also, is adopted in the construction of the eye, where the movable diaphragm is represented by the iris.

Again, another point is to be mentioned: white light, as is well known, is composed of seven colors, which vary in their different degrees of refrangibility—violet, indigo, blue, green, yellow, orange, and red. If a beam of white light is passed through a triangular prism of glass it is

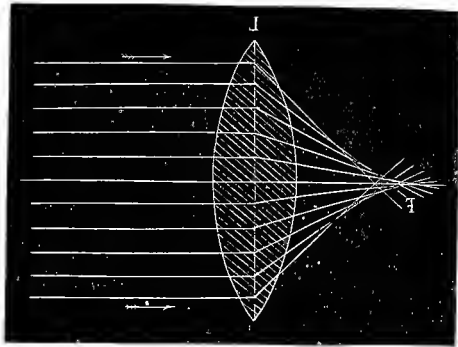

FIG. 376.—DIAGRAM ILLUSTRATING SPHERICAL ABERRATION. (*Ganot*)  
The rays passing through the edges of the lens have a shorter focal distance than those passing nearer to the centre.

decomposed into its constituent rays, the violet rays being refracted most strongly and the red the least (Fig. 377). A white point on a black ground does not form a simple image on the retina, but many colored points appear after each other. If the eye is accommodated so as to focus to a sharp image the violet rays are refracted most strongly; the other colors will form concentric diffusion circles, being most marked in the case of the red rays. In the centre of all the colors a white point is produced by their mixture, while around it are placed colored circles. Such an action, of course, produces dimness of the object, and is known as chromatic aberration.

This, too, may be corrected in two ways: either by making use of the diaphragm and cutting off the rays passing through the circumference of the lens; or in optical instruments by the use of two kinds of glass, one of which has a different dispersing power from the other, but

equal refracting power. Of the one a double convex lens is made, of the other a double concave, and the two combined. They must be of different dispersive power, or the degree of concavity which would correct the chromatic aberration would also destroy the converging power of the convex lens. In crown glass and flint glass we have such media. The flint glass has greater dispersive power, hence the degree of concavity necessary to correct the chromatic aberration will be attained before the degree of concavity will be reached which would destroy the converging power of the convex lens of crown glass.

In the different refractive media of the eye such combinations are to a certain extent represented, and serve, together with the action of the pupil in shutting off the circumferential rays, to correct chromatic aberration.

The eye as an optical instrument is analogous to the camera obscura, and forms, in a manner to be described directly, an inverted image in

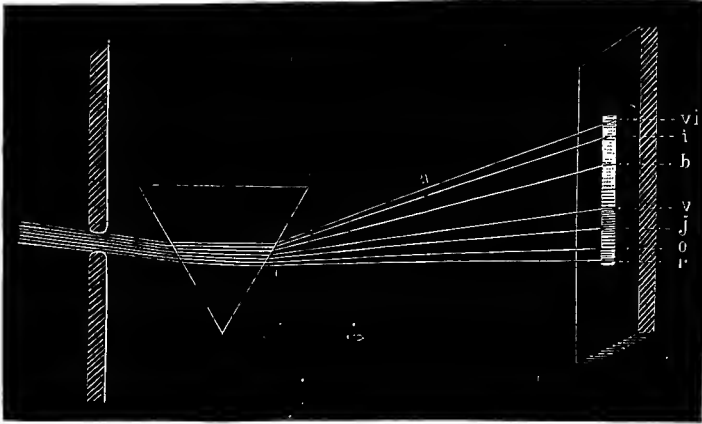

FIG. 377.—DIAGRAM ILLUSTRATING THE DECOMPOSITION, IN PASSING THROUGH A PRISM, OF WHITE LIGHT INTO THE SEVEN COLORS OF THE SPECTRUM. (Béclard.)

r, red; o, orange; j, yellow; v, green; b, blue; i, indigo; vi, violet.

reduced size of objects before it. Instead of a single lens, as in the camera, the eye is composed of a number of different refractive media placed behind each other—the cornea, the aqueous humor, and the lens. The field of projection, or the point on which the image is focused, is the retina, and from changes which have recently been discovered to take place in the retina in which the visual purple becomes bleached the analogy to the process of photography is very striking.

As is well known, by means of a convex lens an image of any object may be formed upon a screen; thus, if a convex lens be held before a window, and a piece of paper placed behind it as a screen, at a certain

distance behind the lens, a reversed image of the window will be formed upon it. The manner in which this image is formed may be represented in the following diagrams (Figs. 378 and 379).

In these figures it is seen that rays from any point of the object, which may be regarded as diverging rays, are brought to a point behind the lens. If the figures should be completed, and lines drawn from each individual point of the objects in the manner represented in the illustrations, it must be evident in tracing each of these lines that a small inverted image

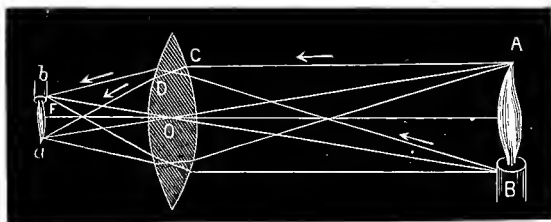

FIG. 378.—DIAGRAM ILLUSTRATING THE FORMATION, BY A DOUBLE CONVEX LENS, OF A SMALLER INVERTED IMAGE. (Ganot.)

must be formed behind the lens. If a screen be placed at this point, which corresponds to the focal length of the lens, it is evident that the image will be distinctly defined. On the other hand, if the screen be either approached or removed farther from the lens an indistinct image will be formed. If the object be farther removed from the lens the image will decrease in size, and to have a distinct image the screen must be approached to the lens; and, conversely, if the object be approached

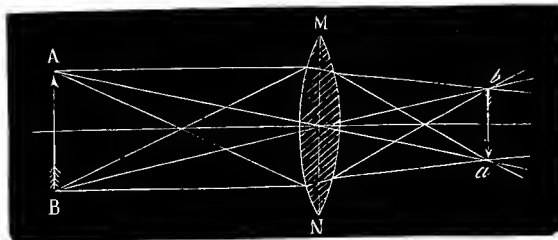

FIG. 379.—DIAGRAM ILLUSTRATING THE FORMATION OF AN IMAGE BY A DOUBLE CONVEX LENS.

to the lens the image will be increased in size, and to have sharp definition the screen must be moved farther from the lens.

A similar process occurs within the eye, although the refraction of rays of light is much more complicated than in the simple convex lens, for in the eye the ray of light passes through several media and is refracted by each. Nevertheless, in the eye, a small inverted image is formed on the retina, as may be readily determined by removing the eye from a recently killed animal, and if the sclerotic be removed from the

posterior portion of the eyeball the image of external objects in a strong light may be seen upon the retina inverted and reduced in size (Figs. 380 and 381).

The principal surfaces by which rays of light passing through the eye are refracted are the cornea and the anterior and posterior surfaces of the lens. Since rays of light passing from the atmosphere to the cornea pass from a rarer to a denser medium, the rays of light will be bent toward the perpendicular. The degree of refraction at this point will be more marked than in passing from the cornea to the aqueous humor, both of which possess the same refractive power. On the other hand, the refraction will be still greater in the lens, so that the rays will be still more strongly deflected inward. It has been seen that rays of light passing through the central point of the optical centre of a convex lens do not undergo refraction, and in a double convex lens of equal curvature the optical centre will coincide with the

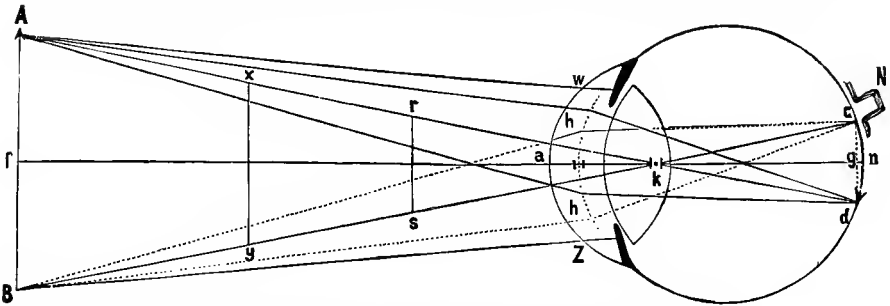

FIG. 380.—FORMATION OF AN IMAGE IN THE EYE. (*Landois.*)

By following the rays from the object, A B, it may be seen that they are brought to a focus on the retina, where a small inverted image is formed.

geometrical centre. In such a compound system of refracting media as in the eye the optical centre is less readily determined. It has been determined that in the eye the optical centre lies, not exactly in the centre of the crystalline lens, but between that point and the posterior surface of the lens; consequently, the rays passing through this point will practically undergo no refraction. It has been stated that a screen may be so arranged in relation to a convex lens that a distinct image of the object will fall upon it. This relation is attained when the screen is in the exact focus of the lens. If approached to the lens or removed a greater distance from it the image becomes indistinct. So, also, similar blurring or indistinctness is produced when the distance between the object and the lens is altered.

In looking at a distant object the rays of light may be regarded as parallel, and, as is well known, are focused with the greatest readiness upon the retina. The difference between the action of the eye in

forming an image and that of a simple lens is evident in the fact that with the normal eye an object may be seen with equal distinctness whether at a great distance or closely approached to the eye. This indicates that there must be some mechanism in the eye by which the focal length of the refracting media can be altered. If the finger be held a short distance before the eye, the other being closed, it may be distinguished with the greatest distinctness. If the finger remain in the same position, and the eye now be fixed on some more distant object, the finger is seen indistinctly, so that at will we may focus our eyes on either the near or the far object and either may be distinctly seen: yet when the eye is arranged for near objects far objects are seen indistinctly, and the reverse. Such an adjustment of the refracting powers of the eye is termed *accommodation*. It was for a time thought that the accommodation of the eye was accomplished by approaching or withdrawing the receiving surface, the retina, to or from the lens. It

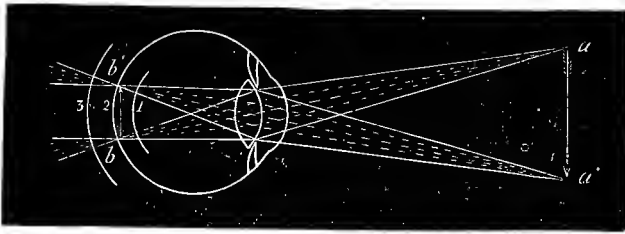

FIG. 381.—DIAGRAM ILLUSTRATING THE FORMATION OF AN IMAGE ON THE RETINA. (*Yeo*)

The rays from the point, *a*, passing through the cornea, lens, etc., are collected in the retina at *b*. Those from *a'* meet at *b'*, and thus the lower point becomes the upper.

has, however, been shown that this is not the case, and that accommodation is accomplished by changes in the curvature of the crystalline lens.

Referring again to our illustration of an object, a convex lens, and a screen, as has been stated, if we determine the focal length of the lens or the point at which a distinct image will be formed upon the screen and then approach the object to the lens, the screen not being removed from its position, the image will be indistinct. If, now, we remove the object, the screen remaining unmoved, and substitute for the lens originally used one of a greater degree of curvature, the degree of refraction will evidently be greater and the focal length shorter, so that the rays from the object in the near position, being more diverging, may be brought to a focus at a point corresponding to that of the less diverging rays from the farther-removed object. So, again, if the point of distinct image be determined and the object farther removed, the screen would then have to be approached to the lens in order to obtain a distinct image. In this

case, also, a distinct image might be formed by substituting a lens of a less degree of curvature.

In the eye accommodation is accomplished by muscular action through which the shape of the lens is changed. When the eye after viewing an object at a distance is adjusted to form a sharp image of a nearer object the crystalline lens becomes thicker through an increase of the curvature of its anterior surface. This change may be represented in the following diagram, after Helmholtz (Fig. 382).

The left portion of the figure represents the eye adjusted for distant objects, while the right half is accommodated for near objects. It is here seen that the anterior surface is increased in convexity, moving nearer the cornea, and has carried the iris with it. It is well known that the refraction of light rays caused by a convex lens increases with its increase of curvature, and that the focal length of one lens will be longer than

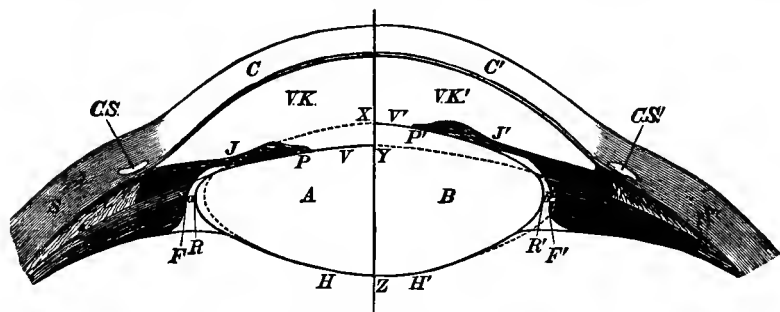

FIG. 382.—SCHEME OF ACCOMMODATION FOR NEAR AND DISTANT OBJECTS, AFTER HELMHOLTZ. (*Landois.*)

The right side of the figure represents the condition of the lens during accommodation for a near object, and the left side when the eye is at rest. The letters indicate the same parts on both sides; those on the right side are marked with a stroke. *A*, left, *B*, right half of lens; *C*, cornea; *S*, sclerotic; *C.S.*, canal of Schlemm; *V.K.*, anterior chamber; *J*, iris; *P*, margin of the pupil; *V*, anterior surface, *H*, posterior surface of the lens; *R*, margin of the lens; *F*, margin of the ciliary processes; *a b*, space between the two former; the line *Z X* indicates the thickness of the lens during accommodation for a near object; *Z Y*, the thickness of the lens when the eye is passive.

that of one of greater curvature—in other words, the latter will produce a greater convergence of the light-rays.

A similar state of affairs holds in the adjustment of the lens in the eye. When the object of our vision is closely approached to the eye the lens is more convex than when the distance is greater, and its refracting power is, therefore, increased and the formation of an image on the retina rendered possible. Of course, with every variation in distance there must be a corresponding variation in the degree of curvature of the lens.

The mechanism by which the change in the curvature of the lens is accomplished is the ciliary muscle. The capsule of the lens is attached at its edge to the zone of Zinn, which radiates outward and keeps the lens in a state of constant tension. At the point where the fibres of this



ligament are attached to the outer membrane are also attached the fibres of the ciliary muscle. When the eye is in a condition of rest, and, therefore, adjusted for distant objects, the ciliary muscle is relaxed and the zone of Zinn, by means of its elastic tension, pulls on the edges of the lens-capsule, thereby extending the lens in a radial direction toward its edge, diminishing its thickness and flattening its curvature. When we want to focus for near objects the zone is drawn forward and inward by the contraction of the ciliary muscle. Its tension, therefore, decreases, and the lens, by means of its elasticity, bulges forward from the release of the tension of the capsule of the lens and so increases in thickness, and its anterior surface becomes more curved. It is, therefore, evident why a strain on the eyes is experienced when looking at near objects, since in a condition of rest of the eye the muscle is relaxed and the eye is adjusted for parallel rays or for viewing distant objects; but when near objects are closely examined a prolonged muscular effort is required, and this, like all other muscular exertions, results in fatigue.

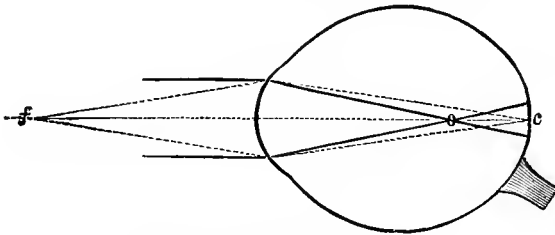

FIG. 383.—MYOPIC EYE. (*Landois.*)

In the normal eye the far point of vision may be placed at an infinite distance, for in the normal eye the degree of refraction of the dioptric media is such that parallel rays of light are brought to a focus on the retina. In myopia, or near-sightedness, parallel rays are not focused on the retina in a condition of rest of the ciliary muscle, but cross within the vitreous humor, and after crossing form a diffused image on the retina. The focal point in the myopic eye for parallel rays falls in front of the retina (Fig. 383). The eyeball is, therefore, too long as compared with the focal length of the refracting media. The near point, on the other hand, or the nearest point at which objects may be distinctly seen, lies abnormally near, and the range of accommodation is diminished.

On the other hand, it is conceivable that the refracting media of the eye may be such that, without accommodation, parallel rays of light, instead of being focused on the retina, as in the emmetropic or normal eye, or in front of the retina, as in the myopic eye, will come to a focus behind the retina (Fig. 384). Such a defect is spoken of as hypermetropia, and is due to the fact that the degree of refraction of the media of the

eye is not sufficiently great to bring parallel rays of light to a focus on the retina. When such an eye is at rest only convergent rays are capable of forming a distinct image on the retina, so that, therefore, distinct images can only be formed by rendering all the rays of light which enter the eye convergent; and, therefore, such an individual will not be able to see distinctly without a convex lens in front of the eye. In such an eye the far point is negative, while the near point is abnormally distant and the range of accommodation great. In the hypermetropic eye, consequently, the distance between the retina and the lens is abnormally short.

When the eye is accommodated for near objects the pupil contracts; when in accommodation for distant objects it dilates. So, also, when the eye is exposed to a bright light the pupil becomes reduced in size, while, on the other hand, it dilates when the light becomes reduced in intensity.

Changes in the pupil are accomplished by the action of the muscular fibres of the iris, which by their relaxation and contraction increase or diminish the size of the pupil.

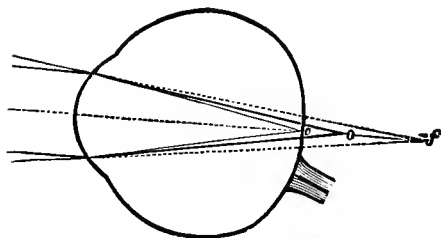

FIG. 384.—HYPERMETROPIC EYE. (*Landois.*)

The iris, therefore, fulfills the function of a diaphragm and serves to cut off the circumferential rays of light, which otherwise would lead to the production of spherical aberration. So, also, as it contracts in a bright light, it serves to regulate the amount of rays of

light entering the eye, while, further, it to a certain extent supports the action of the ciliary muscle, as is seen in the changes which occur in the size of the pupil during accommodation.

The iris is supplied with two sets of muscular fibres, the circular or sphincter fibres, which are supplied by the oculo-motor nerve, and the radiating fibres, or the dilator of the pupil, supplied chiefly by the cervical sympathetic and the trigeminus. When the oculo-motor nerve is divided the pupil dilates, owing to the contraction of the dilator fibres, which still preserve their integrity. On the other hand, when the sympathetic is divided in the neck the pupil contracts through the antagonistic action of the sphincter fibres. The contractility of the circular fibres is, nevertheless, the stronger, for if both nerves be stimulated together contraction of the pupil will take place. The radial muscular fibres are especially developed in birds, while they have been claimed to be absent in many other animals.

Changes in the size of the pupil fall under the head of reflex actions,

since they cannot be produced through the exercise of the will. When a ray of light falls upon the retina it leads to contraction of the pupil, in which the optic nerve is the afferent nerve, the oculo-motor nerve the efferent nerve, while the centre lies in some place in the brain below the corpora quadrigemina. This is proven by the fact that when the optic nerve is divided intense light no longer produces contraction of the pupil, while, also, the division of the third pair renders the pupil insensitive to light, and stimulation of the peripheral portion of the oculo-motor leads to contraction of the pupil. So, also, stimulation of the floor of the aqueduct of Sylvius will, likewise, if the oculo-motor nerve be intact, lead to contraction of the pupil.

In contradistinction to what will be found in many instances, two symmetrically disposed centres are not to be found in the brain for governing the movements of the pupil, since in normal conditions a stimulus applied to one optic nerve will lead to contraction of both pupils, while, also, stimulation of the centre will react on both eyes.

In addition to the oculo-motor nerve, the iris receives nerve-fibres from the short ciliary nerves coming from the ophthalmic ganglion, which is connected by its root with the third nerve, the cervical sympathetic nerve, and the nasal branch of the ophthalmic division of the fifth nerve. It has been mentioned that section of the cervical sympathetic causes contraction of the pupil, and stimulation of the cervical sympathetic dilatation of the pupil. It is evident that these effects on the pupil are directly opposite to those seen in the blood-vessels on stimulation of the sympathetic nerve.

The centre for the dilatation of the pupil likewise lies in the front part of the floor of the aqueduct of Sylvius, while a second or inferior centre, the so-called cilio-spinal centre, lies in the lower cervical portion of the cord and extends downward to the first or third dorsal vertebra. This centre may be reflexly stimulated by irritation of various sensory nerves, when, of course, dilatation of the pupil will take place. It is likewise stimulated by the blood in dyspnoea, and also a single centre governs the movements of both pupils, for if one retina be shaded both pupils will dilate. The cilio-spinal centre is in connection with the upper centre for the dilator of the pupil through fibres passing through the lateral columns of the cord, and it, together with the inferior centre, reacts to the same stimuli.

When the sympathetic nerve is divided in the neck the pupil contracts. This contraction is accompanied by a great increase in the vascularity of the iris from the consequent paralysis of the walls of its blood-vessels. This at one time was supposed to be sufficient to explain the production of contraction of the pupil after section of the sympathetic. Various other conditions which lead to an increased blood

supply of the iris will influence the size of the pupil. Thus, in forced expiration, by which the return of the blood from the head is retarded, the pupil is contracted. So, also, when the intra-ocular pressure is diminished, as by puncture of the anterior chamber, there is less resistance to the flow of blood to the blood-vessels of the iris and the pupil is immediately contracted. On the other hand, strong muscular exertion, which leads to the blood flowing freely into the contracting muscles, will produce dilatation of the pupil.

The size of the pupil may be modified by various drugs. Substances which dilate the pupil are called mydriatics; those which lead to its contraction, myotics.

Of the former may be mentioned atropine, homatropine, duboisine, daturine, and hyoscyamine. They act chiefly by paralysis of the oculo-motor nerve, while also acting slightly upon the dilator fibres, for after complete paralysis of the oculo-motor nerve the moderate dilatation thereby produced may be intensified by the administration of atropine. Atropine appears to act mainly by a local mechanism, since it produces dilatation of the pupil even after destruction of the ophthalmic ganglion and division of all the nerves of the eye except the optic, and even, according to some authorities, will produce dilatation of the pupil in an excised eye.

Myotics, of which physostigmine or eserine is the best known, may produce contraction of the pupil either by stimulation of the oculo-motor nerve or paralysis of the sympathetic.

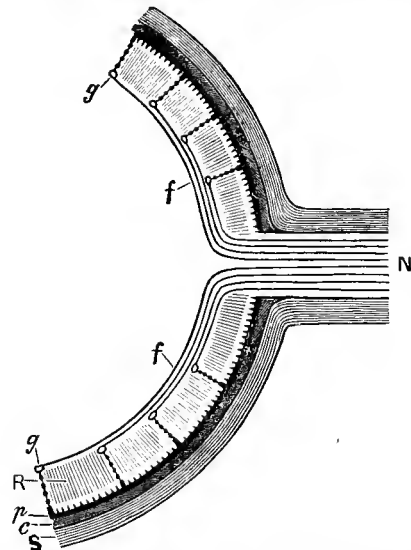

FIG. 385.—DIAGRAM OF THE FORMATION OF THE RETINA. (Yeo.)

The fibres of the optic nerve, N, pass along the inner surface of the retina, R, to meet the ganglion cells, whence special communications pass outward to the layer of rods and cones in the pigment layer, p, next the choroid, c.

2. *Visual Sensations.*—Our considerations of the action of the organ of vision have thus far dealt simply with physical processes. The rays of light entering the eye have been traced backward through the transparent media of the eye until they resulted in the formation of an image. When the rays reach the retina, sensory impulses are excited and are carried through the optic nerve to the sensorium, where they give rise to a sensation.

The nature of the changes that take place within the retina does not

admit of as close analysis as the physical action of the different refracting media of the eye. It is known that it is only the layer of rods and cones of the retina that is concerned in the formation of the image, since rays of light pass through the anterior layers of the retina without giving rise to any sensations. The retina is a highly complicated nervous apparatus, which may, by the use of the microscope, be divided into eight and probably ten distinct layers. The innermost layer—i.e., the layer in contact with the vitreous humor—consists of nerve-fibres in which the optic nerve terminates, radiating from the entrance of the optic

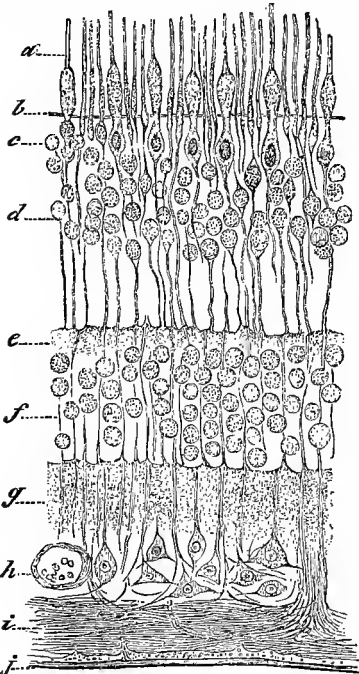

FIG. 386.—VERTICAL SECTION OF HUMAN RETINA. (Landois.)

a, rods and cones; b, external, j, internal limiting membranes; c, external, and f, internal nuclear layers; e, external, and g, internal granular layers; k, blood-vessel and nerve-cells; i, nerve-fibres.

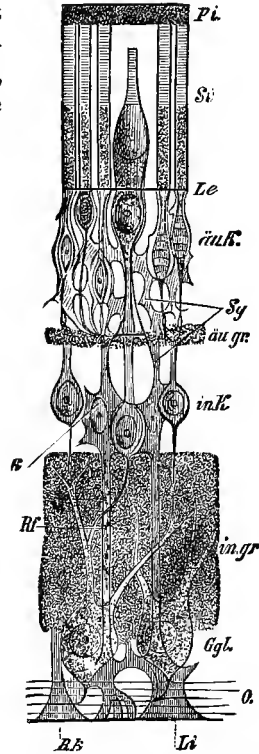

FIG. 387.—LAYERS OF THE RETINA. (Landois.)

Pi, hexagonal pigment cells; Si, rods and cones; Le, external limiting membrane; inK, external nuclear layer; au gr, external granular layer; inK, internal nuclear; in gr, internal granular; Ggl, ganglionic nerve-cells; O, fibres of optic nerve; Li, internal limiting membrane; Rf, fibres of Müller; K, nuclei; Sy, spaces for the nervous elements.

nerve (Fig. 385). At this point, therefore, the retina will consist only of nerve-tubules. At one spot in the centre of the retina no nerve-fibres are to be distinguished, and on account of its color this point is termed the *macula lutea*, or yellow spot, and is the point of most acute vision.

The layers of the retina have been described as follows: *First*, and

most internally, exists a fine limiting membrane; *second*, externally, a layer of nerve-fibres; *third*, a layer of nerve-cells analogous to the ganglionic cells of the brain; *fourth*, a granular layer consisting of an indistinct mass of fine gray granules; *fifth*, the inner granular layer, composed of little round granules; *sixth*, the intermediate granular layer, in which the granular mass is intermingled with small fibres; *seventh*, the outer granular layer, analogous to the inner granular layer; *eighth*, a second delicate membranous structure; and *ninth*, the layer of rods and cones (Figs. 386 and 387).

It is this most external layer of the retina which is concerned in the reception of the rays of light and the formation of the image. It consists of small, transparent rods packed closely together at right angles to the surface of the retina, while at different intervals between them is seen a small rod expanded at the end so as to form a conical shape. These cones are especially abundant in the yellow spot, where there is a slight depression in the retina and where no rods are present. To reach the layer of rods and cones, the rays of light must evidently pass through all the superimposed layers, and are finally stopped at the choroid, which, with its pigment layer, may be regarded as forming a background for the retina.

That the nerve-fibres themselves are insensitive to light may be readily determined by proving that the point of entrance of the optic nerve is entirely insensitive to light. If one eye is closed and the other fixed on a black spot on a white sheet of paper and some other small body be gradually moved laterally toward the outside of the field of vision, at a certain distance the moving body will entirely disappear from sight, while, if the motion be continued, it will again come into the field of vision; or if we place two wafers upon a board at a distance of four or five inches apart and stand at about five times this distance, and closing the right eye, with the left look at the right-hand wafer, the left-hand wafer will disappear. The explanation of this is that when so placed the rays of light from the left-hand wafer will be received directly on the optic nerve, and so indicates that the optic fibres themselves are insensitive to light, and that it is only through the retinal expansion of these fibres that sensations of vision are possible. On the other hand, the macula lutea is the locality of most distinct vision. When we fixedly regard a point with the eye, then the rays of light from that point pass through the middle of the pupil and the centre of the lens and fall almost on the centre of the retina, directly on the yellow spot. The formation of the macula lutea indicates the reason of its especial sensitiveness to light, while at the same time pointing out the constituents of the retina which are concerned in the formation of the image. It has been mentioned that the optic fibres surround the yellow spot without passing

over it. This would appear to indicate such an adjustment of the constituents of the retina as to avoid the slightest interference with rays striking on this point, since we have seen that the optic nerve-fibres are not sensitive.

Again, in the yellow spot the cones of the retina are closely packed together, and in addition numerous ganglionic cells are found, while the other layers of the retina are fainter than elsewhere. The yellow color is due to the deposit of numerous yellow pigment cells.

If it be admitted in the first place that the optic nerve-fibres are not sensitive to light, and in the second place that the layer of rods and cones represents the sentient surface for light-waves, a connection must evidently exist between the receiving surface and the nerve-fibres to admit of the impression becoming a sensation and being perceived by the brain. Microscopical examination will succeed in tracing a connection by means of fine filaments penetrating all the layers of the retina and connecting the nerve-fibres with the ganglionic cells, the granular layers, and finally with the rods and cones. It is through this path that the irritation caused by the rays of light and received in the meshes of the rods and cones passes to the optic nerve-fibres, and thence to the brain, there creating the sensation of light.

Like other nerves of special sense, the fibres of the optic nerve, though insensitive to light, respond to other irritants, and then the brain perceives the sensation peculiar to that special nerve and recognizes that an irritant has acted upon the nerve of vision, and a flash of light is the result. Thus, in cases of section of the optic nerve a flash of light is experienced, and then total darkness follows; so, also, if the optic nerve be stimulated by electricity a sensation of light is the result. All the nerves of special sense to this extent agree in their nature, and the optic nerve no more conveys sound-waves to the brain than does the auditory nerve waves of light; but both nerves at their terminations are supplied with special forms of apparatus, the so-called special sense organs, which only admit of being excited by appropriate stimuli; thus the terminal fibres of the optic nerve are especially adapted for receiving impressions of waves of light, the auditory nerve waves of sound, the difference lying in the different impressions made upon different special centres in the brain.

As to the mode in which rays of light call into action the specific functions of the layer of rods and cones, but little is definitely known. Recent investigations appear to point to a chemical decomposition being concerned in this process. It is well-known that rays of light produce decomposition in many substances, which are then spoken of as sensitive to light. That a ray of light shall produce such decomposition, it must be absorbed. We therefore, perhaps, see the explanation of the invariable

existence of pigment cells in the organ of vision. It has been mentioned that the first indication of organs of vision is represented by an accumulation of pigment cells, and we never find the presence of an eye which is totally free from such pigment matters.

A fact which at first seemed to show exactly how this process was accomplished was the discovery in the retina of the purplish-red pigment, the so-called visual purple, or rhodopsin, which is so extremely sensitive to light that by proper means external objects may actually be photographed in it on the retina. This substance may be extracted from the retina by means of a 2.5 per cent. solution of the bile acids, especially if the eyes have been kept for some time in a 10 per cent. solution of common salt. Kühne stated that by illuminating the retina actual pictures could be produced on the retina, and that they gradually disappeared. The analogy between this fact and the action on the sensitive plate in the photographic apparatus is very striking, and the further behavior of the purple pigment of the retina would perhaps show that it is concerned in the appreciation of light. Thus, if a rabbit is kept in the dark for some time and then killed, and its retina examined by a monochromatic light, it will be found to be of a brilliant purple-red color with the single exception of the macula lutea; on the other hand, exposure to light will result in quickly bleaching it, but it will, however, have its color restored if the eye be again placed in darkness.

Unfortunately, we are as yet entirely unwarranted in forming any such conclusion or affirming any such close connection between this peculiar substance and the sensation of vision by the fact that the pigment is confined to the outer segments of the rods and is absent in the cones, which we have found to be the most sensitive layer; and is, in fact, absent in the macula lutea, which we have found to be the most sensitive point of the retina. Finally, it is absent in pigeons, hens, and bats, although the retina of the latter only consists of cones, while it is found in both nocturnal and diurnal animals. Finally, it is entirely wanting in animals which undoubtedly see very distinctly, and may be entirely removed from the eyes of certain animals, as the monkey, by prolonged exposure to strong light, when the retina will become completely bleached, but will still apparently be perfectly sensitive to light. We cannot, therefore, at present explain visual sensations as due to chemical changes occurring in this pigment. The discovery of the retinal pigment is, nevertheless, to be regarded as an advance in the elucidation of this subject, for it is almost impossible to conceive that it is not in some way concerned in vision.

It has been stated that the two pupils act simultaneously, and as we know the function of the pupil is concerned in regulating the entrance of rays of light to the eye and that vision takes place simul-



taneously with the two eyes, the question arises, Why is it that with two retinæ, each capable of receiving a distinct image, the image so formed by the use of the two eyes is not double? The explanation of this lies not so much in the anatomical distribution of the tunics of the eye as in the fact that when rays of light proceed from a luminous body and fall upon the retinæ they fall upon parts that are accustomed to act together. Every point of the image on one retina falls upon a coincident point upon the other. These points are accustomed to act together and we see a single image. The eyes, indeed, receive a double impression, and this may be illustrated by placing two small bodies, as the fingers, at different distances from the eyes. Directing the eyes to the nearer, the more remote will appear double, or, if the eye be directed to the more remote, the nearer will appear double. This is due to the fact that the images of the object upon which the eye is not especially directed do not fall upon coincident parts of the retina. The same thing may be accomplished by throwing the two parts of the retina out of coincidence with each other, when, almost instantaneously, double vision will occur. If, while looking at a single object, we press to one side the globe of one eye, we bring two parts of the retina to act together which did not ordinarily thus coincide and double vision ensues. Any other cause, such as various poisons, disease, or fatigue, which will disturb the co-ordination of the eyes or such an adjustment of the position of the eyes that rays of light do not fall upon corresponding or coincident parts, will result in double vision.

Again, it has been stated that the image formed upon the retina is an inverted one, and yet it is a matter of common experience that every body is seen in the field of vision as upright. This second mental reversion of the image is the result of experience acquired in the exercise of the sense of sight. It is not to be understood that the brain takes cognizance of the picture upon the retina and that vision is an actual transmission of this image to the sensorium. The mind does not look upon the picture so formed, but vision is a mental act excited by an impression upon the optic nerve whose neurility is excited. There need be no more correspondence between the change in the brain and the image in the eyes than between the signs of the telegraph operator and the words of the written message. It must be remembered that vision consists in the change developed in the central organ as a consequence of changes in the optic nerve. Even supposing that the image on the retina is inverted, what difference does it make? Everything is inverted and the relative position of things is unchanged. All objects hold the same relation to each other whether the image be inverted or erect; hence the mind is not conscious of any inversion.

Although each retina receives an image from the object the pictures

are not precisely the same. If we hold up any object and look at it first with the right eye, having the left eye closed, and then with the left eye, having the right eye closed, it will be readily seen that the picture is not precisely the same. With the right eye we see the right side of the object, and with the left eye the left side. When these two pictures come to be fused in the brain there results an image which differs from either of the other two and which is projected into space, giving the idea of one solid body (Fig. 388).

It is upon this principle that the stereoscope is constructed. The stereoscopic picture is composed of two images, one representing the object as seen by the right eye, and another representing the object as seen by the left.

When these two pictures are fused the resulting picture is formed, which is a compound of the two, and this fusion of the two images gives the idea of solidity of the object.

When the eye has looked at an object for a long time, especially if that object be luminous, the retina becomes fatigued and no longer capable of receiving impressions from it. If the object be small only a small portion of the retina will be impressed. If we turn away from the object and fix the eye upon a white wall we see a dark spot upon the wall corresponding in size with the object upon which we have been looking. Suppose that we fix the eye upon a bright red wafer strongly illuminated, and look at it steadily with our eyes, the rays proceeding from that wafer and falling upon one point of the retina will fatigue that

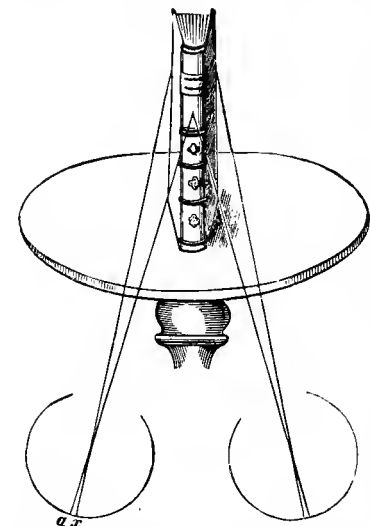

FIG. 388.—DIAGRAM ILLUSTRATING BINOCULAR VISION. (Béclard.)

The lines from the object indicate that the rays from the back of the book fall on coincident points of the retina, while each eye, further, has a special field of vision.

point so that it will not be capable of receiving rays from less luminous objects, and when we turn our eye to the wall we see a spot on the wall like the wafer in size but of a different color, made up of all the colors of the spectrum except red. This combination constitutes what are termed accidental or complementary colors. Again, if we look at a white object for a long time and then look at the wall we see there an object of the size of the original one of a black color. The point of the retina upon which the image fell has become so fatigued that it cannot receive an impression from the fainter rays reflected from the wall, while all the other parts of the retina are impressed by these rays. We, there-

fore, see the wall with a dark spot upon it. These accidental colors are produced by fatigue of the retina, and consist of all the other colors of the spectrum except that of the luminous object at which we have been looking. The primary colors, so-called, are red, yellow, and blue. The intermediate points of the spectrum are made up by combinations of these; thus, violet is a mixture of red and blue, green of yellow and blue, and orange of red and yellow. Blue is thus the complement of orange and yellow of violet.

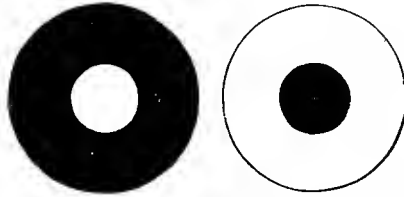

FIG. 389.—DIAGRAM ILLUSTRATING IRRADIATION. (*Stirling.*)

If this diagram is held some distance from the eyes, especially if not exactly focused, the white dot will appear larger than the black, though both are exactly of the same size.

When rays of light from a strongly luminous body fall upon the retina they are not confined exactly to the precise points upon which they impinge, but extend themselves to a greater or less degree around them. Thus, if we make a circular white spot upon a black ground, and a black spot of corresponding dimensions upon a white ground, the former will appear considerably larger than the latter, apparently, because the excitation of the retina by the luminous impression tends to spread itself over the adjacent unexcited space (Figs. 389, 390, and 391).

The same phenomena are seen when the experiment is performed with

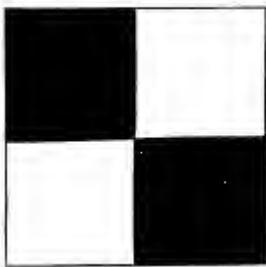

FIG. 390.—DIAGRAM ILLUSTRATING IRRADIATION. (*Stirling.*)

The two white squares appear the larger, and they appear to run into each other, and to be joined by a white strip.

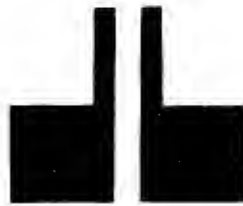

FIG. 391.—DIAGRAM ILLUSTRATING IRRADIATION. (*Stirling.*)

The white strip, which is of equal width throughout, appears wider below, between the black squares, than above.

different colored bodies. If the impressing body, though small in size, illuminate the retina strongly, it may irradiate its impression upon the surrounding part of the retina and make itself appear larger.

In our perceptions of the nature of external objects we find that the sense of vision, like the other sensations, is not infallible, but that

various errors in judgment of visual sensations frequently occur. Some of these admit of explanation, others do not. The most striking example of such an error in perception, and one which is the most readily explained, is as follows:—

If a series of parallel vertical black lines, two millimeters in diameter, are drawn on white paper, with equal white areas between them, and then intently regarded in a good light, in a short time the lines will assume the shape seen in Fig. 392 at A. They appear of this shape because of

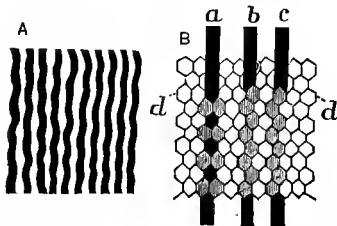

FIG. 392.—DIAGRAM ILLUSTRATING BERGMANN'S EXPERIMENT. (*Stirling.*)

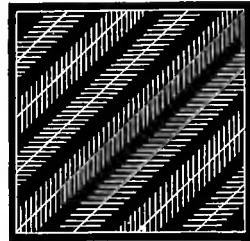

FIG. 393.—ZÖLLNER'S LINES. (*Stirling.*)

the manner in which the images of the lines fall on the cones in the yellow spot, as shown in B.

If a series of oblique lines are drawn perfectly parallel to each other, and then they are crossed in different directions by a number of short parallel oblique lines, although the long oblique lines are perfectly parallel, the short oblique lines cause them to appear to slope inward or outward, according to the direction of the oblique lines (Fig. 393).

In the figure 8 and the capital letter S the upper half to most persons appears of about the same size as the lower half. If, however, the page on which they occur be inverted it will be seen that the lower part



FIG. 394.—DIAGRAM ILLUSTRATING AN IMPERFECTION OF VISUAL JUDGMENT. (*Stirling.*)

is considerably the larger (Fig. 394); or if the centre of Fig. 395 be fixed at about three or four centimeters from the eye, by indirect vision the broad black and white peripheral areas will appear as small and the lines bounding them as straight as the smaller central areas.

If a disk similar to that seen in Fig. 396 is rotated the disk appears to be covered with circles, which, arising in the centre, gradually become larger and disappear at the periphery. If, after looking at such a revolving disk for some moments, it be attempted to read a printed page, or to look at a person's face, the letters appear to move toward the centre, while the person's face appears to become smaller and recede. If the disk be rotated in the opposite direction the opposite results are obtained.

*Movements of the Eye.*—The position of the eyeball in the orbit

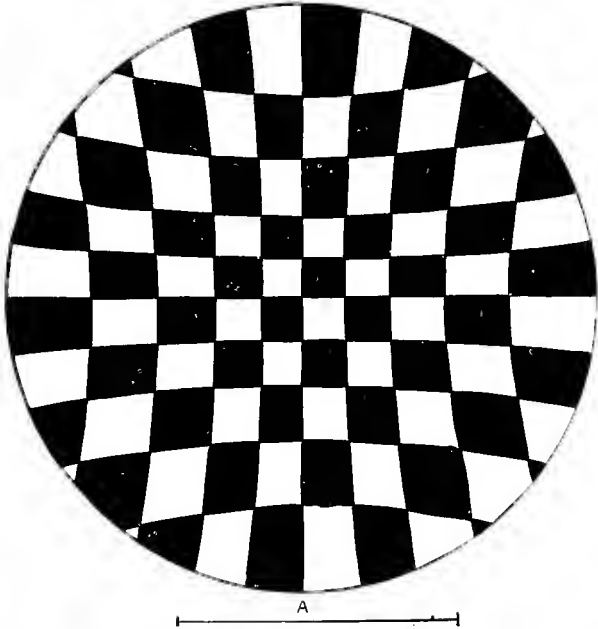

FIG. 395.—DIAGRAM ILLUSTRATING IMPERFECT PERCEPTION OF SIZE. (*Stirling*)

corresponds to a ball-and-socket joint, and each eyeball is capable of moving around an immovable centre of rotation, which has been found to be



FIG. 396.—DIAGRAM ILLUSTRATING RADIAL MOVEMENT. (*Stirling.*)

placed a short distance behind the centre of the eye. The movements of the eye are accomplished by six muscles—four straight and two oblique.

The recti, or straight muscles, all take origin about the optic foramen and radiate outward, being inserted in the globe of the eye on either side, above and below, constituting thus the external and internal straight muscles. Of the oblique muscles, the superior alone arises from the optic foramen and runs forward over the superior and inner part of the orbit through a pulley in the depression just within the inner extremity of the superior orbital margin, then outward and backward beneath the superior straight muscle,

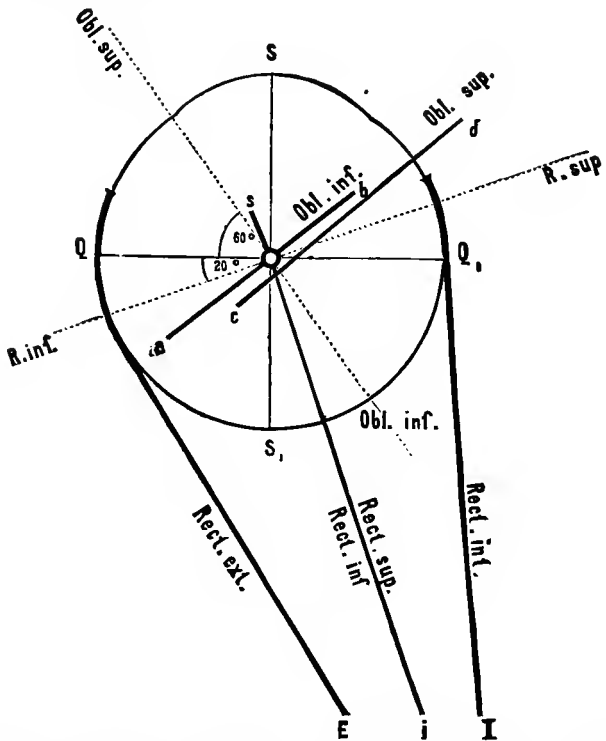

FIG. 397.—SCHEME OF THE ACTION OF THE OCULAR MUSCLES. (Landois.)

and is inserted in the eyeball midway between the latter and the external straight muscle, the cornea, and the optic nerve. The inferior oblique muscle arises from the anterior portion of the edge of the orbit, and runs by its tendon to be inserted beneath that of the external rectus muscle. The function of the superior oblique muscle is to roll the eye downward and inward, that of the inferior oblique muscle upward and inward, although this may be accomplished by the different recti muscles acting simultaneously. The above diagram indicates the action of the ocular muscles (Fig. 397).

The oculo-motor nerve supplies all of the muscles of the eye with the exception of the external rectus and the superior oblique. The external rectus muscle is supplied by the abducens, or sixth pair, while the superior oblique is supplied by the patheticus or fourth pair.

### C. THE SENSE OF HEARING.

The sense of hearing or audition may be defined as that sense by which the mind takes cognizance of the undulations of the elastic medium which give rise to the sensation of sound. The mind recognizes not the body producing the sound, but the impression made by its vibrations upon the sensorium. Sound, then, does not take place in the ear, but in the brain. When we speak of a resounding string or a sonorous bell we make a mistake; the string and the bell simply vibrate. These vibrations give rise to undulations in the elastic ether, which undulations are transmitted in various directions, and finally through the auditory passages impress the auditory nerve and give rise to sound. The physiological aspects of the question are here alone regarded. Regarding sound as the recognition of the impressions made by vibrating sonorous bodies on the auditory nerve, if every one were deaf there would, of course, be no sound; but, on the other hand, we say that no sound may be produced in a vacuum, although we know that sonorous vibrations still take place; hence we are also permitted in a physical sense to give the above explanation of the word sound.

The simplest form of the organ of hearing is a sac filled with fluid, in which the ends of the auditory nerve terminate. In all groups of animals the essential part of the organ of hearing consists in a certain special form of termination of the nerve, which is alone capable of receiving auditory impressions and of transmitting them to the central ganglia of the brain. The more highly complicated forms of auditory apparatus simply depend upon modifications which assist in the transmission of sound to this part.

In all the invertebrates the organ of hearing is restricted to such a simple sacular form, in some instances containing otoliths, or small, hard granules, and the vibrations of the sonorous body are communicated to the nerve of hearing spread over this sac. In such animals it is probable that while a nerve of hearing is present only simple sounds and noises can be recognized, while no difference in pitch or intensity can be distinguished. Such a simple form of apparatus, consisting simply of liquid contained in a sac, is found in mollusks.

In crustaceans there is a rudimentary organ of hearing present, placed on each side of the base of the anterior antennæ. It likewise consists simply of a membranous sac filled with fluid, and on which ramify the fibres of the nerve of hearing.

Many insects are apparently free from any evidences of anything resembling an organ of hearing, yet it is clear that these animals are sensible of external sounds. It is possible that in these animals, as in certain radiates and many mollusks, the vibrations of sound are not appreciated as sound, but, perhaps, as some modification of the sense of touch.

In fishes there is no external ear, no tympanic cavity, and no cochlea. The ear is reduced to the membranous part of the vestibule and the semicircular canals, the latter varying from two to three in number, while the vestibule and semicircular canals represent a closed cavity, since there is neither oval nor round window, no tympanic cavity, nor auditory ossicles. Sometimes, as in cartilaginous fishes, the membranous internal ear is lodged in the cartilaginous substance of the bones of the head, while in osseous fishes it is sometimes in part within the bones of the cranium, and part free in the cephalic cavity, resting against the brain. The internal ear is in all cases supplied with terminal fibres of the auditory nerve, and is filled with a liquid in which are found various calcareous concretions of greater or less volume.

In reptiles there is no external ear, neither a pinna nor an external auditory canal, the tympanic membrane being flush with the head and lying directly below the skin, although in some instances a drum membrane is absent. When present, as is the case in the majority of instances, it communicates generally by a large opening—the Eustachian tube—with the pharynx. The auditory ossicles are usually reduced to two in number. When the tympanic membrane is absent, the ossicles, attached at one side to the oval window, are fastened on the other directly against the external integument.

In lizards, crocodiles, and serpents the internal ear is composed of the vestibule, semicircular canals, and cochlea. In them, consequently, the internal ear communicates with the cavity of the tympanum by the oval window and by the round window. The cochlea in them is not convoluted, but almost straight.

In the batrachians no cochlea is present, and, as a consequence, no round window, the internal ear being reduced to the vestibule and the semicircular canals, the only communication with the tympanum being by the oval window.

In birds the apparatus of hearing is almost as complete as in mammals, with the single exception of the external auditory pinna, which is absent. The external auditory canal is formed by a bony canal traversing the temporal bone, and the tympanic cavity, separated from this canal by the tympanic membrane, is well developed. It communicates with bony cavities in the interior of almost all the cranial bones, and by the intermediation of the Eustachian tube with the pharynx. The



internal ear is formed of the vestibule, semicircular canals, and cochlea; the latter, being but little developed, is not convoluted in a spiral form, but, resembling that of lizards and serpents, consists of an almost straight osseous tube canal terminating in a *cul-de-sac*.

In mammals the ear, for the convenience of study, may be divided into three parts—the external, the middle, and the internal ear. Of these three the internal ear is the essential, and the others are simply for the purpose of receiving or modifying impressions from the sounding body.

In the external ear we include the auricle, or pinna, and the external auditory meatus, bounded internally by the membrane of the tympanum; in the middle ear, the tympanum, or drum of the ear, with its contained ossicles; and in the internal ear, that portion situated in the petrous portion of the temporal bone, consisting of the semicircular canals, the vestibule, and the cochlea (Fig. 398).

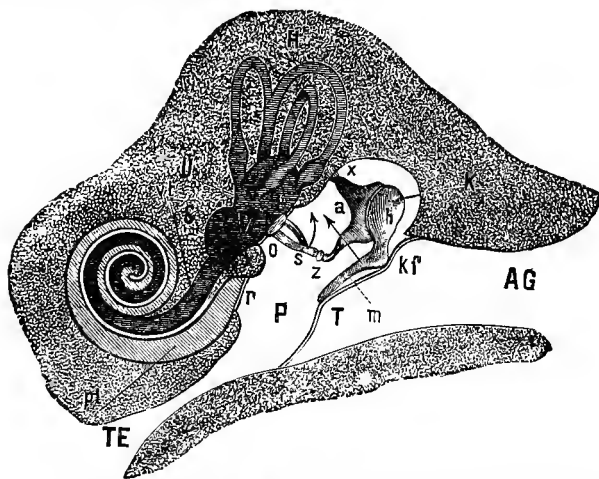

FIG. 398.—SCHEME OF THE ORGAN OF HEARING. (*Landois.*)

AG, external auditory meatus; T, tympanic membrane; K, malleus with its head (h), short process (Kf), and handle (m); a, incus with its short process (x) and long process; the latter is united to the stapes (s) by means of the Sylvian ossicle (z); P, middle ear; o, fenestra ovalis; r, fenestra rotunda; x, beginning of the lamina spiralis of the cochlea; pt, its scala tympani; vt, its scala vestibuli; V, vestibule; S, sacculi; U, utricle; H, semicircular canals; TE, Eustachian tube. The long arrow indicates the line of traction of the tensor tympani; the short, curved one, that of the stapedius.

In different groups of mammals a marked difference is found in the form and size of the auricle, or pinna. This, in the majority of cases, is a trumpet-shaped dilatation of the external auditory canal formed for the purpose of receiving the undulations communicated to the atmosphere, collecting them, and transmitting them inward to the middle ear. This portion of the external auditory canal owes its shape to the cartilages present in it, which in some instances, as in the horse, the ass, the goat, and the rabbit, are erect and straight; while in other cases the cartilages are more delicate and soft, folding on themselves so that the auricles lie

in contact with the side of the head, although they may by the influence of various muscles be drawn into a more or less erect position. Such is the case in the elephant and in the dog. In most mammals the auricle

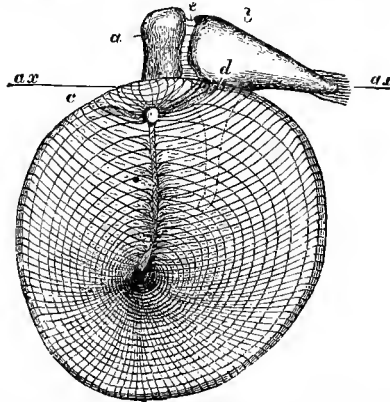

FIG. 399.—DIAGRAM OF THE EXTERNAL SURFACE OF THE LEFT TYMPANIC MEMBRANE. (*Hensen.*)

*a*, head of the malleus; *b*, incus; *c*, joint between malleus and incus; between *c* and *d* is the flaccid portion of the membrane; *ax*, axis of rotation of ossicles. The deeply shaded central portion is called the "umbo."

is much more mobile than in man, and may be directed toward the source of sound by the contraction of voluntary muscles and thus be enabled to accomplish more successfully its functions.

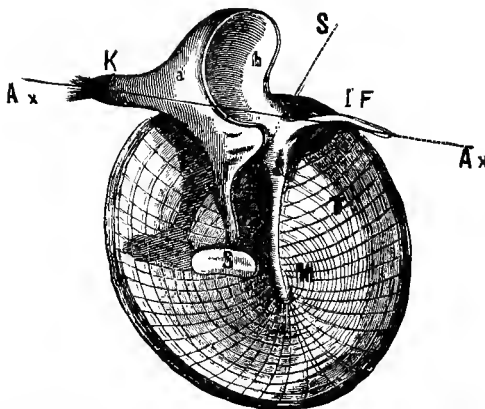

FIG. 400.—TYMPANIC MEMBRANE AND AUDITORY OSSICLES SEEN FROM THE TYMPANIC CAVITY. (*Landois.*)

*M*, manubrium, or handle of the malleus; *T*, insertion of the tensor tympani; *b*, head, *l* *F* long process, of the malleus; *a*, incus with the short (*K*) and the long (*l*) processes; *S*, plate of the stapes; *Ax*, *Ax* is the common axis of rotation of the auditory ossicles; *S*, the pinion-wheel arrangement between the malleus and incus.

The external auditory meatus is a canal, partly cartilaginous and partly bony, which varies in length according to the species. Thus, while it is five or six centimeters long in ruminants, it is very short in

carnivora. It is bounded internally by the tympanic membrane and its function is to conduct to the middle ear the undulations collected by the auricle. In the external auditory canal are found the ceruminous glands secreting the wax, which is principally intended for lubricating purposes, and thus facilitates the transmission of sound, while, also, by its extremely bitter taste it perhaps prevents the entrance of insects.

The tympanic membrane forms the boundary between the external auditory canal and the middle ear. This membrane consists of three distinct layers, the outer, the external integument, the middle or fibrous layer, and the inner or mucous layer, continuous with mucous membrane lining the middle ear. This membrane is an elastic, almost unyielding,

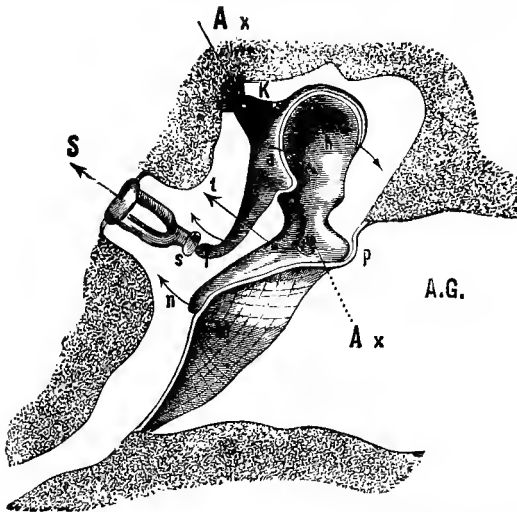

FIG. 401.—LEFT TYMPANUM AND AUDITORY OSSICLES. (*Landois.*)

A.G., external meatus; M, membrana tympani, which is attached to the handle of the malleus, n, and near it the short process, p; h, head of the malleus; a, incus; K, its short process, with its ligament; l, long process; s, Sylvian ossicle; S, stapes; A x, A x, the axis of rotation of the ossicles, shown in perspective; t, line of traction of the tensor tympani. The other arrows show the movements of the ossicles when the tensor contracts.

membrane, elliptical in form, and is placed obliquely in the floor of the external meatus at an angle of about  $40^{\circ}$ , being directed from above downward and inward. This oblique position enables a larger surface to be presented to the undulations conducted from the external auditory canal than if it were placed vertically. This membrane is not entirely flat, but at its centre is drawn slightly inward where the handle of the malleus is attached to it, while the short process of the malleus causes a slight bulging of the membrane near its upper margin (Figs. 399 and 400).

The middle ear, or the drum of the ear or the tympanum, is bounded by the tympanic membrane on the exterior, and on the interior by the

labyrinth. It connects interiorly with the fauces by the Eustachian tube, and posteriorly with the mastoid cells of the mastoid portion of the temporal bone. In some animals these mastoid cells are greatly developed and so form an important augmentation of the tympanic cavity, while the Eustachian tube, which is short and straight in the case of most ruminants, is very much dilated in the horse where it forms what may be termed guttural pouches (Fig. 401).

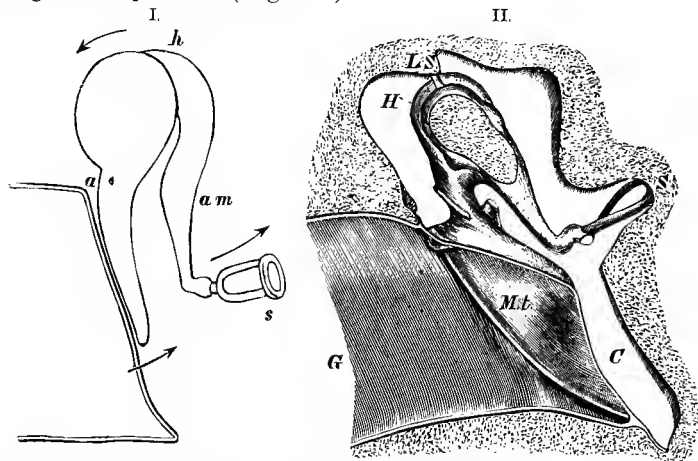

FIG. 402.—I. THE MECHANICS OF THE AUDITORY OSSICLES, AFTER HELMOLTZ. II. SECTION OF THE MIDDLE EAR, AFTER HENSEN. (*Munk*)

I. *a*, malleus; *h*, incus; *am*, long process of incus; *s*, stapes; the arrows show the direction of motion. II. *G*, external auditory canal; *Mt.*, membrana tympani; *C*, tympanum; *H*, malleus; *LS*, superior ligament; *S*, stapes.

Stretching across the middle ear from one side to the other is the chain of bones, each named from its resemblance to some instrument; thus, the malleus, so-called from its resemblance to a hammer, is attached to the membranum of the tympanum by its handle (Fig. 402). The second

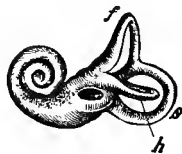

FIG. 403.—EXTERNAL APPEARANCE OF THE LABYRINTH AND FENESTRA OVALIS. (*Landois.*)

*f* upper, *h* horizontal, and *s* posterior semi-circular canals of the left side. The cochlea is seen to the left of the figure.

bone, from its resemblance to an anvil, is called the incus, and is attached on the one side to the malleus and on the other to the stapes or stirrup-bone, which is connected by its base to the membrane of the fenestra ovalis, which opens into the internal ear. All these ossicles are movable on each other, but they have no lateral connection with any structure.

Sometimes at the end of the incus is found a separate bone known as the os orbiculare. In the inner boundary of the middle ear is placed, in addition to the oval window, a second, also communicating with the vestibule, and called the fenestra rotunda, or round window.

The internal ear, or labyrinth, is composed of bone, and consists of

the vestibule, and, communicating with this, three semicircular canals and the cochlea (Figs. 403 and 404). Lining the internal ear and forming a complete cast of the vestibule and semicircular canals is the so-called membranous labyrinth, while between the walls of the membranous

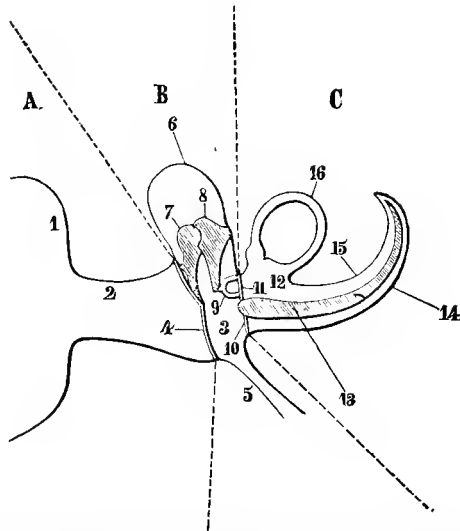

FIG. 404.—SCHEME OF THE AUDITORY APPARATUS. (*Beauvis.*)

A, external ear; B, middle ear; C, internal ear; 1, auricle; 2, external auditory canal; 3, tympanic cavity; 4, tympanic membrane; 5, Eustachian tube; 6, mastoid cells; 7, malleus; 8, incus; 9, stapes; 10, round window; 11, oval window; 12, vestibule; 13, cochlea; 14, scala tympani; 15, scala vestibuli; 16, semicircular canal.

labyrinth and the semicircular canals and vestibule is a fluid called the perilymph, which is also contained in the cochlea. Within the membranous labyrinth is a similar fluid termed the endolymph. In the interior of the membranous labyrinth are often found little particles consisting almost entirely of carbonate of lime, called otoliths, or ear-stones (Fig. 405). Sometimes these are attached to the walls of the membranous labyrinth, and sometimes they are found lying loosely and are intended to increase the intensity of the sounds.

The cochlea consists of a spiral canal making two and one-half revolutions about a central axis. It is divided by a spiral lamina, partly membranous and partly bony, into two divisions known as *scalæ*, of which one is above the other. The superior at its inferior extremity terminates in the vestibule and is known as the

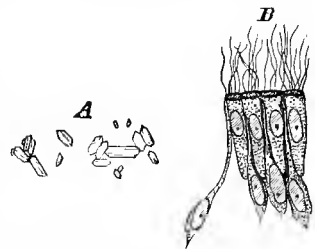

FIG. 405.—A, OTOLITHS FROM THE HORSE; B, EPITHELIUM WITH AUDITORY HAIRS FROM THE CRISTA ACOUSTICA OF THE RABBIT. (*Munk.*)

scala vestibuli, while the other, or inferior, terminates in the round window and is called the scala tympani. On these laminae spirales are distributed portions of the auditory nerve, which takes origin from the floor of the fourth ventricle and runs into the petrous portion of the temporal bone through the meatus auditorius internus and divides into two divisions, one going to the cochlea and the other to the vestibule near to the end of the semicircular canals. It loses itself upon the walls of the vestibule and the walls of the ampullae, or membranous dilatations at the commencement of the three semicircular canals (Fig. 406).

The cochlear nerve is distributed to the scalae of the cochlea, where its terminal fibres form connection with Corti's organ, which is placed

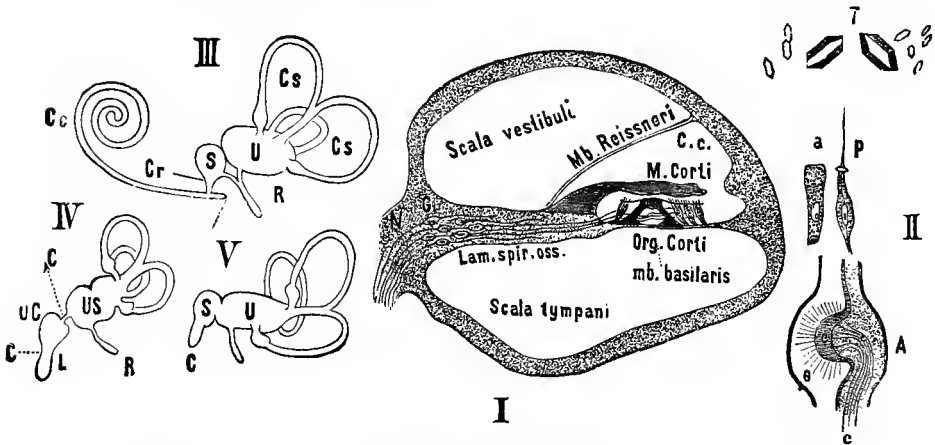

FIG. 406.—SCHEME OF THE LABYRINTH AND TERMINATION OF THE AUDITORY NERVE. (Landois.)

I. Transverse section of a turn of the cochlea. II. A, ampulla of a semicircular canal: a, p, auditory cells, p, provided with a fine hair; T, otoliths. III. Scheme of the human labyrinth. IV. Scheme of a bird's labyrinth. V. Scheme of a fish's labyrinth.

in the ductus cochlearis, a small, triangular chamber; cut off from the scala vestibuli by the membrane of Reissner (Fig. 407).

Corti's organ is placed on the membranous portion of the lamina spiralis, and consists of an apparatus composed of the so-called Corti's arches, each of which consists of two Corti's rods. Every two rods unite to form an arch, so that there are always two or three inner rods and two outer rods. Toward the apex of the cochlea the rods become longer and the span of the arches increases. The terminal organs of the cochlear nerve are the cylindrical hair-cells described by Corti, of which there are two rows, the row of inner cells resting on a layer of small, granular cells, and the outer cells distributed in three or four rows resting on a basement membrane. Between the outer cells there are

other cellular structures to be noticed, which are, perhaps, to be regarded as special cells (Fig. 408).

Waves of sound falling upon the auditory nerve produce no sound, but only when the terminal organs are stimulated.

*The Function of Hearing.*—To be enabled to understand the use of the different portions of this complicated organ it will be necessary to refer to some of the more important laws governing the propagation of sound. Sound, as before stated, is the result of the vibrations of elastic bodies, which result in the production of alternate condensation and rarefaction of the surrounding medium. As a consequence, sound-waves

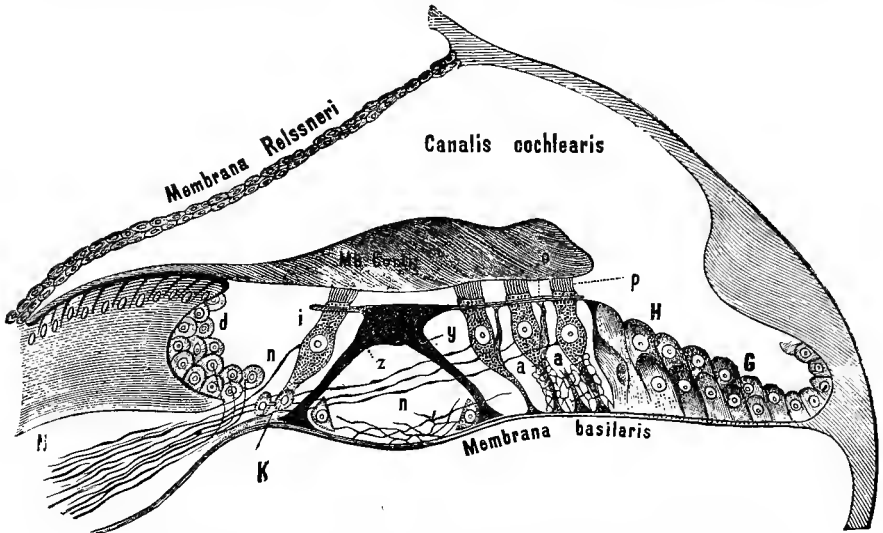

FIG. 407.—SCHEME OF THE DUCTUS COCHLEARIS AND THE ORGAN OF CORTI. (Landolt.)

N, cochlear nerve; K inner and P outer hair-cells; n, nerve-fibrils terminating in P; a, a, supporting cells; d, cells in the sulcus spiralis; z, inner rod of Corti; Mb Corti, membrane of Corti, or the membrana tectoria; o, the membrana reticularis; H, G, cells filling up the space near the outer wall.

are produced, in which the particles vibrate longitudinally, or in the direction of the propagation of the sound, forming so-called waves of condensation and rarefaction, occurring in concentric circles around the sounding body.

Like rays of light, sound-waves may be reflected when they impinge upon an opaque solid, and the same rules as to the angle of incidence and reflection prevails. It is this throwing back of sound from a resisting medium that constitutes the echo.

When transmitted through the atmosphere these waves of sound are collected by the auricle, and from the auricle they are transmitted through the external auditory meatus to the membrana tympani, which is thus thrown into vibration. Thus, they are communicated to the

chain of bones and reach the membrane of the fenestra ovalis. From that point they are communicated to the perilymph, thence to the membranous labyrinth, thence to the endolymph, and finally to the otoliths, which serve to increase the vibratory impression upon the nerve of hearing. This transmission of sound from the exterior and its recognition in the centre plainly involves important considerations with regard to the propagation of sounds.

Sounds are transmitted in three ways: first, by reeiproceation; second, by sympathetic vibration; and, third, by conduction. As regards vibrations by reeiproceation, if two strings of equal tension, length, and

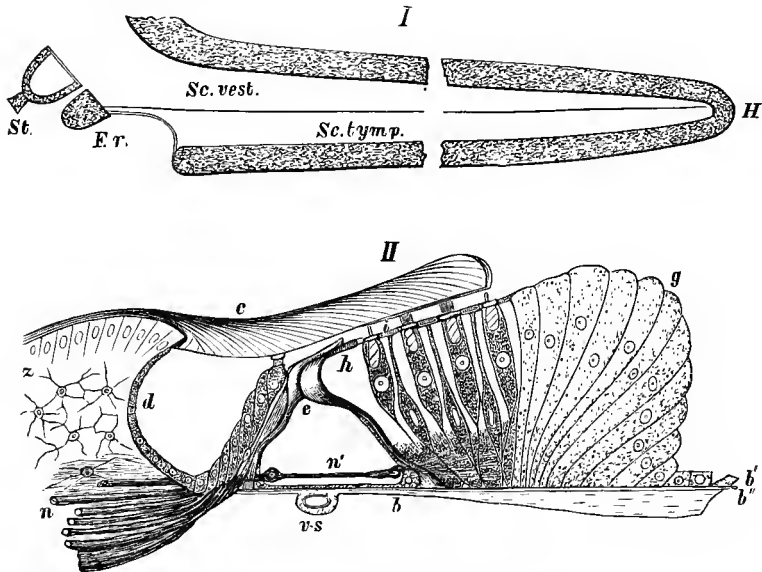

FIG. 408.—I. SECTION THROUGH THE UNCOILED COCHLEA. II. SECTION THROUGH THE TERMINAL NERVE-APPARATUS OF THE COCHLEA, AFTER HEUSEN. (*Munk.*)

I. *F. r.*, Fenestra rotunda; *H.*, the helicotrema; *St.*, the stapes. II. *z.*, Huschke's process; *b'*, basilar membrane; *c*, Corti's arch; *g*, supporting cells; *h*, cylindrical cells; *i*, Deiter's hair-cells; *c*, membrana tectoria; *n*, nerve-fibres; *n'*, non-medullated nerve-fibres.

density be stretched side by side each one is capable of producing the same musical tone when thrown into vibration. Now, when one of these strings is thrown into vibration the other will fall into vibration by reeiproceation, although it be not itself touched. The same thing will occur when the same musical note is sounded on another instrument, as the tuning-fork, if in sufficient proximity. If one of the strings be stretched tighter than the other a higher musical note will be produced. If this string be thrown into vibration near one of lower note the latter will be divided into equal divisions, which are likewise thrown into vibrations of reeiproceation, and increased sound will result. If, however,



a string of less tension be thrown into vibration near one of higher tension there will be no response, for no membrane or string can reciprocate a note lower than its own fundamental note. By the term fundamental note we mean the lowest note which any string or membrane can produce. If a higher note be sounded alongside of a string of low tension the latter, as before stated, will divide itself, and the divisions will be separated by points of rest, called nodal points, while the intermediate parts of the string in vibration are termed loops.

These remarks are true not only of strings, but also of membranes. If some sand be sprinkled on a membrane stretched across a drum-head, so as to be capable of a musical tone, and then another note of precisely the same pitch be struck near it, the sand will begin to dance on the surface of the drum-head, thrown into vibrations of reciprocation, and will accumulate on the lines of rest—the nodal lines; but if we sound near it a note higher than that of the membrane stretched across the drum, then the membrane, instead of vibrating across its whole surface, will divide itself, and the sand will collect in dark lines on the nodal points as before. If we sound near the membrane a note lower than its fundamental note, it will not respond.

A column of air may be thrown into vibrations of reciprocation by sounding a note in proximity to it.

Sounds are also propagated by resonance. If an instrument capable of producing a musical note while vibrating be placed in contact with a medium whose molecules are capable of being thrown into vibration, the second substance will vibrate and increase the intensity of the original sound, even if the medium with which we place the sounding instrument in contact is not itself capable of producing musical tones. Thus, when we strike a tuning-fork under ordinary circumstances in the air the sound is but faintly heard, while if we place the fork in contact with a piece of wood, the sound is greatly increased in intensity. The woody fibres are thrown into vibrations which reciprocate the original sound.

Sound is also propagated by conduction, and this occurs when any sonorous body during its vibrations is brought in contact with any medium capable of being thrown into vibration. A familiar example of this is found in the fact that while the tuning-fork held in the air is but indistinctly heard, if placed in contact with the bones of the head it is heard distinctly. In this case the sound is conducted from the tuning-fork to the nerve of hearing through the bones of the head. All media do not conduct sounds with the same degree of rapidity. Solids conduct better than fluids, fluids better than gases, while in a vacuum no sound whatever can be conducted.

That a sound may be appreciated, it is evident that it must be conducted to the terminal filaments of the auditory nerve in the labyrinth,

and the first process, therefore, to be considered in the study of the function of hearing is the means by which sound-waves reach the labyrinth, and then the way in which they excite the nerve of hearing.

It has been seen that every sonorous body is in a state of vibration and that it transmits these vibrations to the surrounding atmosphere, resulting in waves of condensation and rarefaction traveling in radii from the locality in which the sonorous body is located.

It has been further stated that sound-waves may be conducted through any elastic medium, but in the appreciation of sound by the ear evidently the greatest importance is to be placed on the conduction of sound-waves through the air, since the conduction of sounds through solids can but infrequently be of any importance. It has been stated that sound-waves can be conducted through the bones of the head, and although this must be exceptional in the case of man, yet in fishes, where no external ear, auditory canal, or ear-bones are present, it plays an important part. So, in this case, the sound-waves of the water are directly transferred to the labyrinth.

We have now to trace the path of the sound-waves from the sonorous body, through the external ear and auditory canal, through the tympanum to their termination in the labyrinth, with the operation of the different apparatuses by which this transfer is facilitated.

The external ear evidently fulfills the part of an ear-trumpet, and the great improvement in hearing produced by artificial addition to the auricle serves to emphasize this point. The external ear is evidently of a certain amount of assistance in recognizing the direction of sound, but, as is well known, we are liable in this respect to make errors of judgment. The origin of sound-waves is determined simply by the fact that the sound is heard most distinctly when the auditory canal is in the line of propagation of the sound-waves, and, therefore, in order to determine the direction of a sound we turn the head from one side to the other until the sound appears to be the loudest. In the lower animals this is, to a certain extent, facilitated by the exceptional degree of mobility possessed by the auricle, where we must assume that the recognition of the direction of a sound is a matter of greater importance and accomplished with a greater degree of facility and perhaps exactness.

Having reached the auricle, sound-waves enter through the external auditory canal and strike against the tympanic membrane. It has been stated that if a tightly stretched membrane be set into vibration it will produce a sound, the lowest note being termed the fundamental tone; and, further, that if a sound which corresponds with the fundamental tone of such a membrane be sounded in its proximity the membrane will be set in vibration by sympathy. It is evident, if such a fact were applicable to the tympanic membrane, the greatest confusion would result

in the perception of sounds. Sounds which coincide with the fundamental tone of the tympanic membrane would so predominate as to drown or confuse all other sounds. The tympanic membrane, however, is free from this disadvantage, while it possesses in the highest degree the power of being set in motion by an immense range of vibrations. Thus, sounds may be recognized that are dependent upon thirty-two vibrations a second up to such an extremely high pitch as sounds with thirty-eight thousand vibrations a second will produce. This property of the tympanic membrane by which it appreciates such a wide range of sounds, while being free from any fundamental tone itself, is due to two factors—in the first place, the funnel-shaped form of the membrane, and, in the second place, its being damped by the chain of ear-ossicles. If a sheet of india-rubber be stretched over a wide tube and be pressed by a rod in the centre perpendicularly inward it will form a funnel-shaped surface curved from within outward. It is evident that in such a membrane the tension will vary at different parts, increasing toward the centre. Such a membrane, like the tympanic membrane, will have no fundamental tone, since its tension is not equal, while the tympanic membrane will also have in principle the same form, since it radiates from the centre, within outward, in a convex form. The tympanic membrane, therefore, is not very extensible, but its tension is just sufficient to draw it slightly inward from the centre without it being able to produce any audible fundamental tone.

On the other hand, great resistance is offered to the vibrations of the tympanic membrane by its union with the auditory ossicles, which not only deprive the membrane of every trace of a fundamental tone, so that it can accommodate itself equally well to vibrations of every degree of rapidity, but by loading the membrane entirely prevent the occurrence of after-vibrations; so that, therefore, in this respect the ear-bones act like the dampers of the pianoforte, which fall upon the wire after every note has been struck.

Another point is worthy of attention in this connection. Since the tympanic membrane possesses the shape of a funnel, the point of greatest vibration must be situated somewhere between the apex and the edge, but the force of all vibrations passes from the sides toward the centre and at this point vibrations of the greatest intensity are produced. Moreover, the tension of the tympanic membrane may be altered by muscular action in a way to be directly described. The tympanic membrane is in direct contact with the chain of ear-bones, and this serves to transfer the vibrations of the tympanic membrane to the perilymph of the labyrinth, and, likewise, by their points of attachment to different muscles, serve to vary the tension of the membrana tympani and at the same time the pressure on the lymph of the labyrinth.

The ear-ossicles form a jointed chain of bones connecting the membrane with the oval window. As is well known, solids are capable of conducting sound-waves by being thrown into molecular vibration, and the rapidity of such conduction is greater on account of the greater elasticity and density than in the atmosphere. From the very fact of the greater rapidity of the conduction through solids the wave length will be longer, but the conduction of sound through the ear-ossicles is entirely distinct from such molecular vibrations. In the transmission of sound-waves from the tympanic membrane to the labyrinth the chain of bones vibrates as a whole. The average wave length of medium tones in the ear varies from one-half to one meter, while in solid bodies it is still greater. The ear-bones are by no means immovably fixed. From their small mass they are extremely light, so that an impulse acting on one end will set the whole chain of bones in motion. Consequently, when waves of sound strike against the tympanic membrane the vibrations are transmitted directly to the ear-bones, and they vibrate in a transverse direction and carry the vibrations to the oval window by vibrating in mass and not through molecular vibration.

The mode of movement of the ear-ossicles has been a subject of considerable study. As is known, the handle of the malleus is attached to the tympanic membrane through its entire length, while its head projects above the edge of the membrane into the tympanic cavity. Besides this, the malleus is fixed by ligaments in such a way that motion is only possible in a to-and-fro vibration around the so-called axis of rotation, which lies in a plane almost parallel to the tympanic membrane and passes through the neck of the malleus. When the handle of the malleus is drawn inward its head will, of course, move in the opposite direction, and as the handle of the hammer is set in vibration the anvil will also be set in motion through its articulation with the head of the hammer. The incus is only loosely connected by a ligament passing through its short process to the posterior wall of the tympanic cavity in front of the openings of the mastoid cells, while its mode of articulation with the malleus has been compared by Helmholtz to the action of cog-wheels; so that when the handle of the malleus moves inward to the tympanic cavity the incus and its long process, which is parallel with the handle of the malleus, also passes inward, from the fact that the head of the malleus pulls the articulating surface of the incus outward. Therefore, the handle of the malleus and the long process of the incus vibrate in the same direction. As the long process of the incus moves inward it gives an impression to the stirrup-bone, with which it articulates almost at right angles. If, however, as by a great condensation of air in the tympanum, the tympanic membrane is moved outward it, of course, draws the handle of the malleus with it, and, as a consequence, the hammer-head is forced inward,

and the tendency would be to drag the stapes from the oval window. This is, however, prevented by the loose articulation of the malleus and incus, which separate to a certain extent and thus prevent dragging on the stapes (Fig. 409).

Hence, the system of ear-ossicles forms an angular lever, which moves around a common axis in a plane vertical to the plane of the membrana tympani, one arm of the lever on which the power of the vibrations act being the hammer-handle, the other, the hammer-head with

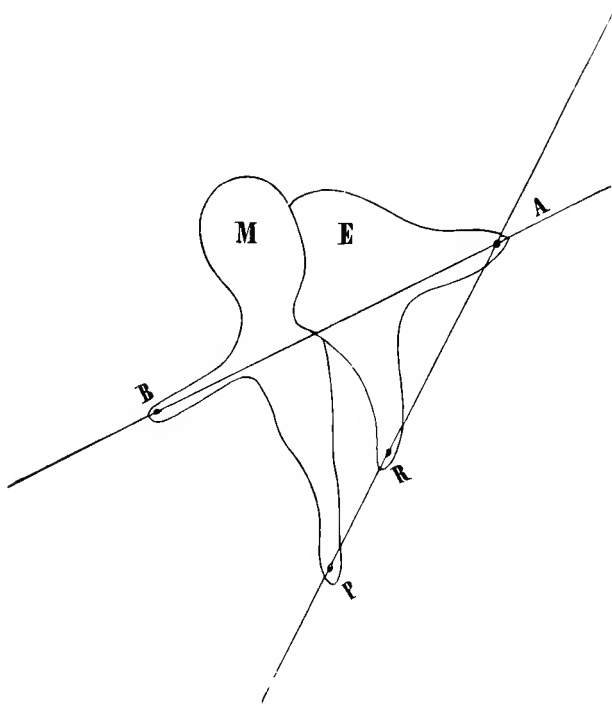

FIG. 409.—MOVEMENTS OF THE MALLEUS AND INCUS. (*Beaunis*.)

M, malleus; E, incus; A, short process of the incus; R, long process of the incus; P, handle of the malleus; A B, axis of movement of the ossicles.

the handle, serving to set the entire fluid of the labyrinth into vibration. The vibrations of the ear-ossicles are, therefore, transverse, although not analogous to the transverse vibrations occurring in a stretched cord, since the ear-ossicles do not vibrate on account of their elasticity, but resemble a system of movable levers. As the long process of the incus is only one-third the length of the handle of the malleus, of course the excursions of the former, and with it the stapes, will be less than that of the tip of the malleus, while, on the other hand, the force of the vibration in the former will be increased; so that the stapes is forced inward by

a more powerful but less extensive vibration. So much for the mode of conduction of sound through the ossicles.

By contraction of the muscular fibres in connection with the ear-ossicles the position and tension of the tympanic membrane, as well as the pressure on the lymph of the labyrinth, may be altered. Two muscles are found in connection with the ear-ossicles, the tensor tympani and the stapedius muscle. The tensor tympani lies in the osseous groove above the Eustachian tube, and has its tendon inserted into the malleus immediately above the axis. When this muscle contracts the handle of the malleus is pulled inward and the tympanic membrane tightened. As a consequence, the stapes is likewise pressed inward. On the other hand, when this muscle relaxes the elasticity of the axial ligament and of the tympanic membrane itself causes the membrane to again assume its condition of equilibrium. By the increased tension of the tympanic membrane a greater resistance is offered to the sympathetic vibrations when the sound-waves are very intense, since it has been found that stretched membranes are less susceptible to sympathetic vibrations than are relaxed membranes; and increase of the tension of the tympanic membrane by contraction of this muscle, therefore, serves to protect the auditory apparatus by preventing intense vibrations reaching the nerve terminations.

The stapedius muscle arises within the pyramidal eminence, and is inserted into the head of the stapes. When it contracts it draws upon the head of the stapes and causes the bone to assume an oblique position, the posterior end of the plate being pressed deeply inward into the fenestra ovalis, while the anterior edge of the plate is displaced outward. The stapes is thus firmly fixed and the annular ligament surrounding the fenestra ovalis becomes more tense. The function of this muscle is likewise directed to preventing the communication of too intense an impulse from the incus to the stapes. The stapedius muscle is supplied by the facial nerve and the tensor tympani by a branch of the trigeminus which passes from the otic ganglion.

The chain of bones lies within the tympanic cavity, and it is evident that the vibration of the tympanic membrane will greatly vary according as the air in the tympanic cavity is in a greater or less degree of condensation. If this space were entirely shut off from the atmosphere the air in it would evidently soon be absorbed, or, at any rate, undergo change in its composition, and probably be replaced by fluid secretions, since we know that the middle ear is lined by a secreting mucous membrane. By means of the Eustachian tube the ventilation of the middle ear is rendered possible. Through it secretions are conducted out, and by it the equilibrium of pressure between the air in the tympanum and the atmosphere is rendered possible. As soon as the

pressure of the atmosphere is greater than that within the tympanum the membrane of the tympanum would be pressed inward. On the other hand, if the pressure within the tympanum be greater than that of the atmosphere the membrane would be pressed outward, and in both cases the movements of the tympanic membrane would be restricted and sound to such an extent interfered with. The equilibrium is maintained through the opening of the Eustachian tube in the act of swallowing,—an act which is performed not only during eating, but also at frequent intervals to carry away the secreted saliva. At other times the Eustachian tube is closed, and by this means the conduction of sound-waves downward into the pharynx or the conduction upward of sound-waves from the voice is rendered impossible.

The sound-waves are thus conducted from the tympanic membrane to the chain of ossicles, and thence by the vibration of the stapes to the oval window. The membrane of the fenestra ovalis is, as a consequence, set into transverse vibration, and these vibrations are directly communicated to the fluid of the labyrinth. The lymph, like other fluids, is incompressible, and if, therefore, the membrane of the oval window be pressed inward there must be a corresponding exit at some other point of the apparatus. This counter-opening is found in the round window, and as soon, therefore, as the stapes vibrates inward the membrane of the circular window vibrates outward, and the pressure upon the fluid of the labyrinth is thus relieved while being set into vibrations corresponding with those of the stapes.

From the oval window the wave travels into the vestibule and from there into the cochlea, and we must assume that it there throws the membranous apparatus with its organ of Corti into vibration. The vestibule is, however, divided by the two membranous sacs which it contains into two portions, each containing fluid, the one in connection with the oval window and the other with the round window; so that, therefore, we cannot imagine that the fluid in the vestibule is directly driven by the vibrations of the stirrup-bone to the round window, for the *seala vestibuli* of the cochlea, which is in connection with the oval window, is shut off from the *seala tympani* by the membrane, and any wave, therefore, started by the vibrations of the stapes will pass rapidly up the *seala vestibuli*, while it will also transfer its vibrations to the membranous partition and thus throw the fluid of the *seala tympani* likewise into vibration.

In the cochlea the vibrations of the perilymph throw into vibration the fibres of the basilar membrane and the organ of Corti, consisting of the rods and the inner and outer hair-cells, which may be regarded as a series of stretched strings; a portion of which may be thrown into sympathetic vibration independently of the whole.

The vibrations communicated to these structures in some way give rise to nervous impulses passing into the terminal filaments of the auditory nerve. As to the way in which this is accomplished but little is known. The temptation is strong to find the receiving apparatus in the organ of Corti, which is composed of a long series of rods varying regularly in length and in the span of their arches. The analogy between these structures and, for example, the strings of the piano is very striking. As is well known, a musical tone sounded in front of an open piano will set into vibration the corresponding string of this instrument. The temptation is almost irresistible to suppose that a similar mechanism is concerned in the perception of different sounds. If we could imagine that certain definite parts of the organ of Corti were thrown into vibration only by appropriate sounds the complex process of the perception of different musical intervals would be greatly simplified, but the more the subject is examined into the greater are the difficulties surrounding such an explanation.

In the first place, the terminal filaments of the auditory nerve have been traced to the inner and outer hair-cells, and it must, therefore, be in this locality and not in the rods of Corti that the sensory impulses commence.

In the second place, the rods of Corti are entirely absent in birds, who, without doubt, are capable of appreciating musical sounds; while, again, the variation in length of the rods of Corti would be insufficient to explain the great scope which the ear possesses in the recognition of the pitch of sounds.

On the other hand, the basilar membrane is tense in a radial direction and loose longitudinally, and, therefore, as Helmholtz has suggested, may be compared to a series of strings of varying tension and length.

If this basilar membrane be looked upon as the receptive organ we must then assume that each vibration travels up the scala tympani, throws into sympathetic vibration a small part of the basilar membrane, which transfers the vibration to the sensory structures above it.

In support of this view it may be mentioned that the radial dimensions of the basilar membrane offer a wider field of difference than we find in the length of Corti's rods. The whole subject is, however, in the highest degree obscure, and all that we can say is that the organ of Corti, composed of the basilar membrane, the rods, and hair-cells, is in some way concerned in the reception of sound-waves; the manner is, however, entirely unknown. After all, it must not be forgotten that the perception of sound takes place not in the ear but in the brain, and that sound-waves, received in whatever way by the terminal filaments of the



auditory nerve, must be conducted to the brain to be recognized as sounds, and that the analysis of sounds take place not in the ear, although, perhaps, we may have there a special organ set aside for the observation of certain sounds, but in the brain.

#### D. THE SENSE OF TASTE.

The sense of taste is generally described as the faculty by which the flavors of different sapid substances is distinguished. It will be shown directly that the sense of taste is much more limited than this, as many substances which are said to be appreciated through the sense of taste are only effective through exciting the sense of smell. The sense of taste even in this restricted sense is more highly developed in man than in other animals, for it is not the sense of taste but the sense of smell which guides animals in their choice of food, for that choice precedes the prehension of food.

Even in man and the higher mammals there is a considerable difference of opinion as to what regions of the mouth are endowed with the sense of taste, and this difficulty of location becomes even more marked as we descend the animal series. In animals where a tongue is present it is probable that that organ partakes, with the upper part of the digestive tract, in the property of presiding over the sensation of taste, but in many animals the tongue is absent or is so horny as to preclude this possibility. In invertebrates, where no analogue of a tongue exists, if the sense of taste is present, as it would seem without doubt to be, as in insects, its seat must be in the parts about the mouth, such as the proboscis, suckers, etc. In fishes the tongue is rudimentary and in many it is covered with horny scales or even rudimentary teeth, and if the sense of taste is present in this group of animals it is either confined to the upper part of the digestive passages or perhaps to the olfactory cavities.

In reptiles a thick, fleshy tongue is often present, but it is more frequently slender, sometimes bifid and protractile, and is to be regarded, as already indicated, as an organ for the prehension of food.

In birds the sense of taste must be very obtuse, since they swallow their food without comminution, and the tongue is usually hard or semi-cartilaginous, especially at the point. This particularly obtains in herbivorous birds, while in birds of prey, where the tongue is fleshy, it may perhaps be supposed that the sense of taste is present.

In mammals the sense of taste may, to a certain extent, be definitely localized in the tongue, and special sense organs have been detected which apparently preside over this function. The so-called taste bulbs are found on the lateral surface of the circumvallate papillæ and upon the external side of the depression which surrounds the central eminence

(Fig. 410). They are also found to a less extent on the fungiform papillæ, the papillæ of the soft palate and uvula, and even on the posterior surface of the epiglottis and on the inner side of the arytenoid cartilages, and on the vocal cords. These latter localities would seem to throw doubt upon the connection between these structures and their connection with the sense of taste, but the fact that after section of the glosso-pharyngeal nerve these taste bulbs degenerate, and that direct communication can be traced between this nerve and these cells, would seem to place their position as the terminal organs of the special nerve of taste beyond doubt.

These taste bulbs are barrel-shaped and consist of series of nucleated external, almost cylindrical protective cells, arranged so as to leave an opening,—the so-called gustatory pore. Lying in the axis of such a structure are found from one to ten gustatory cells, some provided with

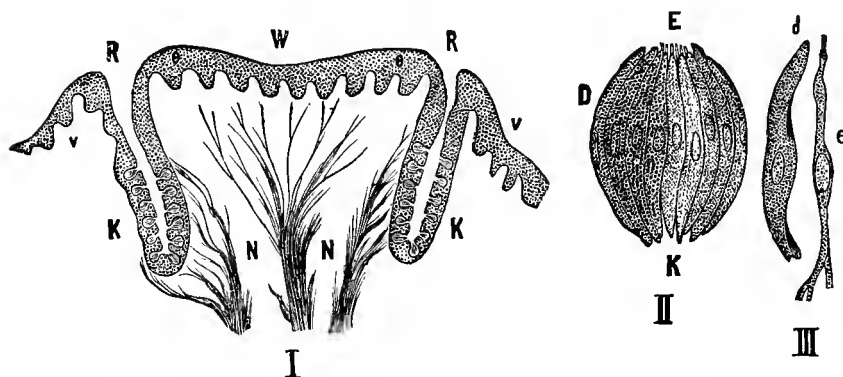

FIG. 410.—STRUCTURE OF THE GUSTATORY ORGANS. (Landois.)

I. Transverse section of a circumvallate papilla: W, the papilla; v, v, the wall in section; R, R, the circular slit of fossa; K, K, the taste bulbs in position; N, N, the nerves. II. Isolated taste bulbs: D, supporting or protective cells; K, under end; E, free end, open, with the projecting apices of the taste cells. III. Isolated protective cell, d, with a taste cell, e.

delicate processes at their free extremities, while their lower, fixed ends become continuous with the non-medullated terminations of the nerve of taste (Figs. 411, 412, and 413).

The tongue of mammals in its general characteristics resembles that of man, and similar papillæ are found on it. In the different domestic animals, especially in the herbivora, the sense of taste must differ from that in the carnivora, although we have every day evidences of its existence, and we know that in the herbivora likewise decided preference for different substances are manifest, which evidently must be dependent upon differing degrees of excitation of the sense of taste, although the explanation of that fact is yet entirely beyond us. Thus, as to why a horse should prefer oats to hay, or the latter to straw, must evidently be explained by some difference in impression of the substances on the nerve of taste and not a mere matter of instinct.

Only four different varieties of taste can be distinguished. Substances may be either bitter, sweet, acid, or saline. Substances to which we attribute the property of flavor owe that characteristic more to their implication of the sense of smell than of taste. Thus, we speak of tasting wines, onions, asafoetida, and so on, while, as is well known, their flavor is due to the excitement of the sense of smell, and not to a specific stimulation of the nerve of taste; this may be readily proven by the disappearance of their characteristic flavors when smell, by closure of the nostrils or by catarrh, is rendered impossible.

That substances may be tasted it is necessary, in the first place,

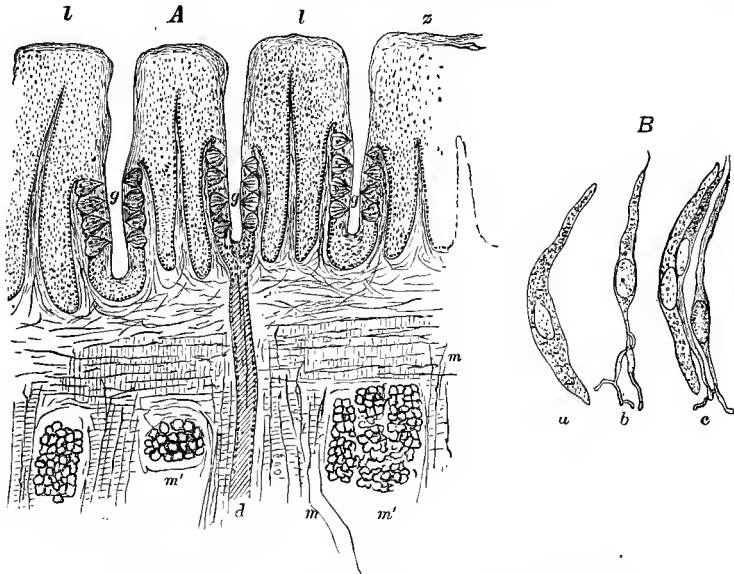

FIG. 411.—STRUCTURE OF THE GUSTATORY ORGANS. (*Munk.*)

*A*, perpendicular section through the taste organs of a rabbit's tongue; *g*, taste furrows. *B*, isolated protective (*a*) and (*b* *c*) taste cells.

that they should be dissolved in the fluids of the mouth, while the intensity of the sensation will depend upon the size of the surface acted upon and upon the concentration of the solution. It has been found that the following series of substances cease to be distinguished in the order here stated, as they are gradually diluted: syrup, sugar, common salt, aloes, quinine, and sulphuric acid. Thus, quinine may be diluted twenty times more than salt and still be distinguished.

The time elapsing between the contact of the substance with the tongue and its appreciation by the taste also varies with different substances. Saline substances are tasted most rapidly, perhaps, from their more rapid diffusion.

The galvanic current is likewise capable of producing the sensation of taste, which varies according to the direction of the current. Thus, a bitter metallic taste is developed when the anode, and an acid taste when the cathode, is placed on the tongue. In this instance it is doubtful whether the sensation of taste is due to a direct stimulation of the taste bulbs or to electrolytic changes occurring through the action of the galvanic current.

All the localities in which the taste bulbs have been detected are probably possessed of the sense of taste, although certain regions, as the entrance to the larynx and the hard palate, do not admit of experimental demonstration as regards this point. Without doubt the root of the tongue and its tip and margins are gustatory, while it is probable that the under surface of the tongue possesses no power of taste.

The nerves which preside over the sense of taste are certain fibres of the lingual and the glosso-pharyngeal. After the lingual nerve is divided the sense of taste disappears from the tip of the tongue. When the glosso-pharyngeal is divided the sense of taste is lost in the posterior

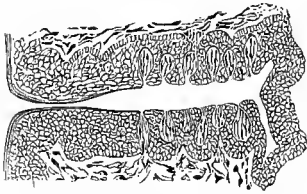

FIG. 412.—TASTE FURROW IN MAYER'S ORGAN IN THE HOG. (Csokor.)

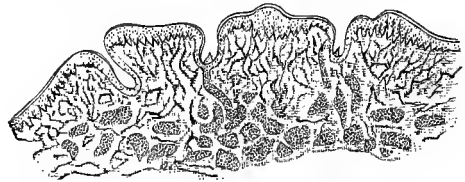

FIG. 413.—SECTION OF MAYER'S ORGAN IN THE HORSE. (Csokor.)

part of the dorsum of the tongue. Contrary to our experience with the other nerves of special sense, stimulation of the trunks of these nerves does not give rise to the sense of taste, probably owing to the fact that both of these nerves are mixed nerves, and contain other afferent fibres as well as those of the sense of taste.

Certain substances seem to possess the power of antagonizing the impressions which others ordinarily make on the terminal filaments of the nerves of taste; thus the taste of bitter and sour substances may to a certain extent be corrected by the admixture of sugar, even without any chemical change occurring in the mixture. Such a result is only to be explained as some kind of interference of the sensations; on the other hand, substances having a sweet taste do not possess the power of modifying saline tastes.

Any explanation as to why certain substances possess one peculiar taste and others another is in our present state of knowledge impossible, with the single exception of the characteristic taste of acids and alkalis, where we find the characteristic taste associated with certain definite chemical characteristics.

The acuteness of the sense of taste admits of education, but is by no means as delicate as the sense of smell; thus, a solution of one part of sulphuric acid to one thousand of water gives its characteristic taste when only one drop, which may be said to contain about  $\frac{1}{2000}$  part of a gramme, is placed upon the tongue.

#### E. THE SENSE OF TOUCH.

When any portion of the external integument is brought in contact with a foreign body we appreciate what is termed the sensation of touch, and we are, therefore, warranted in regarding the skin as a sensory organ, inclosing our entire body and adapted to render every part of the body sensible to external impressions. These may be of the most manifold kind, and excite peculiar sensations dependent upon the nature of the contact. To a limited extent this power of tactile sensibility possessed by the integument belongs likewise to the internal mucous surfaces of the body, but only for a short distance from their respective orifices.

Tactile sensations, as we shall find directly, vary among themselves, and give us means of determining the physical characters of the body producing the contact and the locality at which the contact takes place. When such a tactile sensation is increased in intensity it may be converted into a painful sensation. If, for example, as in the illustration given by Weber, the edge of a knife is placed on the skin we feel the edge by means of the sense of touch, a sensation is perceived which is referred to the object which has caused it. If, however, the skin is cut by the knife pain is felt, a feeling which is no longer referred to the cutting knife, but which we feel within ourselves, and which indicates to us the fact of a change of condition in our own body. By the sensation of pain we are neither able to recognize the object which causes it nor its nature. Thus, if a body is placed within the mouth we are able to recognize its general characters and to a certain extent its shape, whether it be solid or liquid, hot or cold; but if the body be swallowed tactile sensation disappears as soon as the body reaches the œsophagus, and then, if any sensation be excited, it can only be a painful sensation. The sensation caused by a too hot liquid cannot be distinguished from a corroding acid liquid, or from the passage of an irregular hard body through the œsophagus.

The sense of touch is the simplest and is the only universal sense, and exists in all members of the animal kingdom. In the articulatæ, whether covered by horny (insects) or by calcareous (crustaceans) coverings, the sensation of touch is possessed by all parts of the body in common, while it is especially developed in the antennæ which project from the sides of the head.

In mollusks and zoöphytes sensibility is much more obtuse, but is

likewise distributed over the entire surface of the body, and here, also, is perhaps more highly developed in the tentacles or pseudopods which are so often found.

In fishes projecting organs at the side of the buccal opening receive terminations of afferent nerves, and these, together with the fins, may be regarded as especially developed tactile organs, although here, also, the entire body surface possesses general sensibility.

In reptiles no special tactile organ is present, unless the tongue, in certain instances, may fulfill this function.

In birds the tactile sensibility of the skin must be to a certain extent interfered with by the thick coating of feathers and the sensibility of the feet by the dense scales which usually cover these parts. In birds in general it is the beak which possesses tactile sensibility in the highest degree.

In mammals the greatest variation exists in the specialization of certain parts of the body for the appreciation of tactile sensations. In monkeys, although four hands may be said to be present, they are not to be regarded as sensitive organs as are the hands of man; since, in the first place, their fingers do not possess the power of separate movement and their thumb is much shorter and incapable of being brought into apposition with the fingers; while the palm of the hand, which frequently serves as a means of progression, is covered with calloused epithelium. In certain monkeys with prehensile tails this organ is doubtless possessed of tactile power in the highest degree.

In solipedes, ruminants, and carnivora, in whom the extremities of the limbs terminate in a single or double hoof, in claws, or calloused skin, in these localities the sense of touch must be very imperfect. But these parts of the animal body must be capable, nevertheless, of giving distinct notions as regards resistance, solidity, and consistence, since these horny parts rest on a highly developed papillary layer of the derm. In solipedes and ruminants, especially in the former, the lips possess a considerable degree of mobility, and are, as has been shown, the principal organs of prehension and are highly endowed with tactile sensibility. In carnivora the termination of the soft parts about the anterior nares is extremely sensitive and is employed by them as a tactile organ, while it is only a step farther to the hog or the elephant, where the prolongation of this part of the body acquires extreme perfection as an organ of tactile sensibility. In certain animals the long hairs growing from the upper lip, as in the cat and the rat and the seal, are to be regarded as tactile organs, since they conduct tactile impressions to the sensory nerves. Probably, also, the spines of the porcupine fulfill the same function.

Like the more specific sensations, the sensations of touch require for

their production terminal organs which are found in the epidermis of the skin and surrounding the underlying nerve structures. The manner in which the terminal filaments of the sensory nerves are distributed to the skin varies.

Five general different modes of distribution have been recognized. The touch corpuscles of Wagner and Meissner lie in the papillæ of the true skin and are most numerous in the palm of the hand and the sole of the foot, and especially on the fingers and toes. They are oval or elliptical bodies covered by layers of connective tissue arranged transversely and containing within a granular mass with longitudinally striped nuclei. Each of these corpuscles is surrounded in a special manner by a medullated nerve-fibre which loses its myelin and divides into a number of fibrils within the corpuscle.

Pacini's corpuscles are oval bodies likewise found in the subcutaneous tissue of the skin of the fingers and toes and of various other localities. They consist of numerous layers of nucleated connective tissue separated from each other by fluid and lying one within the other, like the coats of an onion. Into the axis of each passes a medullated nerve-fibre whose sheath of Schwann becomes united with the capsule. In the interior or central core of the corpuscle each nerve-fibril terminates in a small, hair-shaped enlargement.

Crouse's corpuscles are elongated or rounded bodies found in the deeper layers of the conjunctiva, the floor of the mouth, and various other mucous surfaces. The sheath of Henle communicates with the nucleated capsule, while the non-medullated fibre is continued into the internal core.

Merkel's tactile corpuscles occur in the beak and tongue of the duck and goose, in the tactile hairs or feelers, and also in the epidermis of man and other mammals. They are composed of a capsule containing two or three or more granular nucleated cells piled one on another in a vertical row. Each corpuscle receives at one side a medullated nerve-fibre which terminates either in the cells themselves or in the transparent protoplasmic substance between the cells. In addition to these special terminal organs of the afferent nerves in many localities their axis cylinder splits up into fibrils to form a nervous net-work which is to be regarded as an organ of sensation.

Nerve-trunks are supposed to contain fibres which are especially concerned in conducting painful impressions and tactile impressions. Sensations of temperature fall under the second head. As already indicated, the first of these modes of sensation may be converted into the second.

Thus, when a body is brought in contact with the skin we may form a conception of the weight of the body—that is, the amount of pressure

which it exerts upon the skin—and to a certain extent its temperature. If the degree of pressure be greatly increased, the sensation of pressure gives place to one of pain, and so, also, for extremely hot or extremely cold bodies. On the other hand, impressions which are not localized on the terminal organs, as, for example, the passage of the electric current through the skin, are not capable of being regarded as tactile sensations. In other words, we are unable to distinguish one such mode of stimulation, except within narrow limits, from another. Thus, for example, the sensation of mechanically pricking the skin is probably identical with that produced by the passage of the current. Again, the contact of a fluid with the skin will cause a tactile sensation, since it is in contact with the nerve terminations, and if that fluid be an acid and pass below the terminal organs and implicate the nerve-fibres a sensation of pain will be caused; so that stimulus which when applied only to the nerve terminations may cause a tactile impression, when applied to the nerve-trunk results in a painful sensation.

The intensity of the sensation produced by pressure depends almost as much upon the rapidity of the application of the pressure as upon the degree of the pressure. If the increase be gradual, more pressure may be applied with scarcely a perceptible sensation; while, on the other hand, the rapid application of a less pressure may cause a much more intense sensation. All parts of the skin are not equally susceptible to pressure for the simple reason that all parts are not equally supplied with tactile corpuscles. In man the most sensitive localities are on the palmar surface of the fingers, on the forehead, and on the flexor surfaces of the limbs as contrasted with the extensor surfaces.

If two points of the skin are subjected to pressure the sensation becomes fused when the two points are sufficiently close. When an impression is made upon any part of the body, not only the character but the locality are appreciated. This power, however, of localizing pressure sensations varies in different localities.

The following table from Weber gives the minimum distances at which simultaneous stimulation of two points may be recognized as two distinct sensations:—

Tip of tongue, . . . . .	1.1 millimeter.
Palm of last phalanx of finger, . . . . .	2.2 “
Palm of second phalanx of finger, . . . . .	4.4 “
Tip of nose, . . . . .	6.6 “
White part of lips, . . . . .	8.8 “
Back of second phalanx of finger, . . . . .	11.1 “
Skin over malar bone, . . . . .	15.4 “
Back of hand, . . . . .	29.8 “
Forearm, . . . . .	39.6 “
Sternum, . . . . .	44. “
Back, . . . . .	66. “



BOOK III.

THE REPRODUCTIVE FUNCTIONS.



## SECTION I.

### THE REPRODUCTIVE PROCESSES.

ALL of the functions of the animal body economy which have as yet been considered have dealt solely with the preservation of the individual. Through the exercise of the reproductive function is accomplished the preservation of the species. The duration of the life of any single animal is a limited one, and if, therefore, each species did not possess the power of reproducing itself in a new and similar individual the species would eventually die out.

The mechanism by which reproduction is accomplished greatly differs in different groups of the animal kingdom. In all vertebrates it is accomplished by the union of two individuals of opposite sexes, male and female. In a large number of the invertebrate animals the two sexes, or at least the two sexual organs, are found united in the same individual, and the different acts of generation are thus accomplished in the body of the same animal; while the mode of reproduction offers a strong analogy to that of the vegetables, which, likewise, contain within the same floral envelope the organs of the two sexes. In other animals still more imperfect a mode of generation may be observed which is analogous to that of cryptogamous plants. Here no organs of generation can be detected, and reproduction is accomplished by separation of parts of the parent body which possess the power of development and growth. Sometimes the germ detaches itself from the individual in the form of a vesicle, which passes through all the phases of development. Such a mode of reproduction is spoken of as generation by spores. At other times a bud may be noticed to form from within or without the animal, which, after having acquired a more or less complete development, separates itself from the parent, and after the separation continues to grow and develop into a new animal. Such a mode of reproduction is spoken of as gemmiparous generation. Finally, the new organism may develop from the parent organism by a simple process of detachment of a part of the parent, after the separation the detached portion forming a new animal, while the parent replaces the part which was lost. Such a mode of reproduction is spoken of as generation by fission.

In all animals provided with organs of generation, whether borne by different individuals or united in the same individual, generation is

invariably accomplished by the formation of an egg by the female and of a fecundating liquid by the male, which, coming in contact with the egg developed by the female organism, gives to the latter its power of independent growth and development. Sometimes the fluid formed by the male comes in contact with the egg of the female after it has passed from the body of the female, as is the case in fishes, while at other times the male fecundates the egg before its exit and while it is still within the body of the female, where it undergoes a certain part of its developmental changes, as in the bird. Finally, the egg fecundated by the male may be retained within the cavity of the female until it has undergone the first phases of its development.

Although numerous differences may be met with in different members of the animal kingdom, these fundamental facts are always observed: on the one side the production of an egg, and on the other the production of a fecundating fluid.

In all the vertebrates, whether mammals, birds, reptiles, or fishes, generation is accomplished by the union of the two sexes, the sexual organs being found in different individuals.

In mammals the process of fecundation takes place within the interior of the sexual organs of the female, and copulation is, therefore, essential. In most reptiles a similar process takes place, although in some fecundation is external; that is to say, the male extrudes the seminal fluid upon the eggs as they leave the body of the female. This latter process is also that which holds in fishes. In the fishes the eggs, covered, as in the case of the batrachians, with a soft membrane, are usually deposited along the banks or at the bottoms of rivers or ponds, while the male deposits at variable intervals the fecundating liquid. As a consequence of the exposure to so many different causes of destruction a large number of eggs escape fecundation, but the immense number deposited by the fishes serves, however, to prevent the ultimate extinction of the species. As many as a million eggs have been said to be extruded at one time from the body of the female of various fishes.

The ovaries of the female fish are two voluminous glands, which almost fill the abdominal cavity of the fish at the time of spawning. In most of the bony fishes the oviducts are continuous with the ovaries and form the extrusory canal. In many of the cartilaginous fishes the abdominal extremity of the duct is free, as is the case in mammals, reptiles, and birds. The oviducts open into the cloaca.

The testicles form in the male two voluminous glands, opening by means of the spermatic canals either into the cloaca, or by a special opening in the neighborhood of the anus. In certain of the cartilaginous fishes fecundation occurs within the body of the female, and there is, therefore, true copulation analogous to that in birds. In these fishes the

eggs are covered by a horny envelope. In others the fecundated eggs remain in the interior of the oviducts and there develop, and the animal bears its young.

In reptiles, as in birds, the product of generation comes from the female organs in the state of an egg, while in most cases fecundation precedes, as in the birds, the escape of the egg, and the egg at the time of its exit is contained within a solid envelope, although, as a rule, less resistant than that surrounding the egg of the bird.

Various batrachians extrude their eggs before fecundation and the male fecundates them while clinging to the body of the female at the moment of their exit. In cases where copulation takes place the exit of the eggs occurs at a considerable interval after their detachment from the ovary, and the egg retained in the oviduct develops and is not expelled until just at the point at which the young is able to carry on a separate existence; while in some instances, as in some serpents, incubation is terminated and the eggs are ruptured within the body of the female, and the living young are expelled from the body of the mother. Reptiles, as a rule, do not incubate their eggs themselves after extrusion, but they deposit them in the sand or in the water, as in the case of the amphibious reptiles, where the external heat is sufficient to accomplish their incubation.

Females of the class of reptiles have two ovaries and two oviducts, which open separately into the cloaca, the oviducts, as in birds and mammals, not being continuous with the ovary, but being free in the abdominal cavity, and possessing trumpet-shaped extremities analogous to the fimbriated extremities of the Fallopian tubes in mammals.

The male organs of generation differ in different species. In the batrachians there are no organs of copulation. The spermatic canals open into the cloaca, and fecundation occurs, as in the birds, by the application of the ani, when fecundation precedes the expulsion of the eggs. In other groups of reptiles a penis is present, into which the spermatic canals open.

Of all the reptiles batrachians are the most productive. Turtles extrude four to five eggs, serpents ten to twenty, and frogs many hundreds. After escaping from the egg batrachians are not, as a rule, fully developed, but during the first two weeks undergo a true metamorphosis, first existing in the form of tadpoles, deprived of limbs, but having a tail and breathing by branchia situated at the side of the neck. Gradually limbs develop and the tail as well as the gills disappear, and the animal then breathes by lungs.

In birds the product of generation leaves the sexual organs of the female while still within the egg, and such animals are, therefore, termed oviparous, although it must not be forgotten that man and other animals

are also in the strict sense of the word oviparous animals, only in them the egg does not leave the body of the female until completely developed.

In mammals the fecundated egg passes through the Fallopian tube and becomes arrested in the uterus and is there fixed, and there undergoes what may be termed an internal incubation, while at the same time vascular connections between the egg and the body of the mother are established. In birds, likewise, the fecundated egg passes through the oviduct and there becomes coated with an albuminous layer, around which is finally deposited a layer of calcareous matter which hardens before the egg is extruded. It, therefore, contains within itself the materials necessary for the development of the embryo, and is, as a consequence, more voluminous than that of the mammal. The eggs of birds are finally developed by external incubation.

Birds, like reptiles, are, as a rule, possessed of no external male organs of copulation. The testicles are placed near the kidneys, and the spermatic canals open at the inferior extremity of the digestive tract at the cloaca, and it is by the application of the anus of the male to the cloaca of the female that fecundation is accomplished. In certain birds, as the ostrich, duck, and goose, a rudimentary penis is, nevertheless, present.

The fundamental part of the egg, or the yelk, is formed in the ovary of the female. When the yelk has attained its full development the ovarian capsule breaks and the yelk, inclosed by the vitelline membrane, passes into the oviduct. There it meets with the seminal fluid and becomes enveloped by a layer of albuminous matter, while the yelk undergoes a rotatory movement and the chalazæ, or albuminous ligaments, found in the white of the egg are formed. About six hours after the exit from the ovary, and when the egg has reached the lower third of the oviduct, the albuminous layer, or the white of the egg, becomes enveloped by a membrane, at first transparent, and which finally doubles itself into two folds. The fold adhering to the albumen remains in the state of a membrane, while calcareous matters are deposited in the more external membrane so as to form the egg-shell. The formation of the shell is much slower than that of the albumen, and it is only after about twenty-four hours that the complete egg is expelled from the inferior part of the oviduct into the cloaca and thence to the exterior, the small point of the egg being first extruded.

If examined while still within the oviduct, or immediately after its extrusion, it may be readily determined that characteristic changes have occurred within the germinal vesicle, and these progress until the embryo is completely developed, its life being sustained during the period of incubation by the albuminous matters stored up in the egg, while respiration takes place through the pores of the shell membrane. In the case

of birds, in contradistinction to what holds in mammals, segmentation is partial, while the remainder of the yolk contained within the umbilical vesicle, and consequently communicating with the intestine of the bird, serves for its nutrition; as a consequence the umbilical vesicle persists during the entire period of incubation and even up to the time when the bird issues from the shell.

The heat necessary for the development of the embryo within the egg is, as a rule, supplied by the body of the mother, but, as is well known, eggs may be artificially incubated, it only being necessary to place them at a constant temperature of from  $35^{\circ}$  to  $40^{\circ}$  C., turning them each day.

In mammals the female nourishes its young for a variable period after birth through the secretion formed by the mammary glands.

In mammals the different acts of generation closely correspond with similar processes in man, the principal differences lying in the number of the young, the duration of gestation, the frequency of the acts of reproduction, and certain anatomical peculiarities relative to the mode of adherence of the fœtus or fœtuses to the uterine cavity. Among mammals some bear but one young at a time. These are the cow, mare, ass, stag, elephant, and monkey; the bear, the roebuck, the castor, the marmot, and the guinea-pig three to four; the lion, the tiger, and the leopard four to five; the dog, the fox, the wolf, and the cat five to six; the rabbit and the water-rat six to eight; the pig and the rat as many as fifteen.

The duration of gestation is three weeks in the guinea-pig, four weeks in the rabbit and hare, five weeks in the rat and marmot, six weeks in the ferret, eight weeks in the cat, nine weeks in the dog and fox, ten weeks in the sloth, fourteen weeks in the lion, seventeen weeks in the castor and sow, twenty-one weeks in the sheep, twenty-two weeks in the goat, twenty-four weeks in the roebuck, thirty weeks in the bear, thirty-six weeks in the stag, forty-one weeks in the cow, forty-three weeks in the mare, the ass, and the zebra, forty-five weeks in the camel, and one hundred weeks in the elephant.

The number of young borne by mammals is capable of being modified under different conditions. Animals which in a state of nature copulate but once in a year, when reduced to a state of domestication enter anew into heat and may copulate a short time after the previous birth; this is, without doubt, due to the more abundant nourishment supplied to such animals in a state of domestication. The mare may pass into heat ten or twelve days after the birth, the cow after twenty days.

The number of young borne by mammals is principally subordinate to the duration of gestation. Small mammals, which carry their young but a short time, as a rule bear more frequently than those in which

gestation is of longer duration. Thus, the water-rat or guinea-pig may bear five or six times a year.

In most mammals the uterus is not constituted by a single cavity, as in the human female, but is prolonged more or less on each side, constituting what are termed the horns of the uterus. Sometimes, as in carnivora, the division of the uterus is prolonged up to the vaginal orifice of the uterus. This division of the uterus into two horns, or two pouches, more or less distinct, does not occasion any difference in the mode of eonnection of the eggs with the uterine mucous membranc. In the carnivora and in rodents the mucous membrane, as in the human species, adheres to the body of the organ and separation is extremely difficult. In solipedes and the pæhyderms the uterine mucous membrane is but slightly adherent to the subjacent tissue and may even be thrown into folds.

In horned ruminants, as the cow, the mode of union of the egg with the uterine mucous membrane presents a remarkable peculiarity. The foetal placenta occurs in isolated cotyledons, the cotyledons being formed, as in the human species, of vaseular loops implanted in the mucous membrane of the uterus, being designated under the name of the uterine cotyledons. These uterine cotyledons exist in the female even before pregnancy and persist after the separation of the foetus and its multiple plaeenta.

When the young of a mammal is born the membranes of the egg and the umbilical eord frequently rupture spontaneously. In other cases the female breaks the membranes and the cord with her teeth. Most carnivorous animals devour the after-birth. In the horned ruminants the adhesion of the cotyledons of the foetal placenta with the uterine cotyledons is so elose that frequently several days elapse after the birth of the foetus before the placenta becomes detaehed. In such animals the expulsion of the placenta cannot be faecilitated by drawing on the umbilical cord without great risk of hemorrhage from rupture of the uterine vessels.

When the animal is multiparous the membranes and placenta of each are expelled with the young to which they belong. In certain species of mammals the young are but slightly developed and are incapable of making use of their limbs. Many such animals, as the marsupials, remain permanently attached to the breasts of the mother while carried in pouches formed by a fold of the integument of the abdomen.

1. THE REPRODUCTIVE TISSUES OF THE FEMALE.—As already stated, reproduction is dependent upon the union of the ovum contributed by the female with the spermatozoa formed by the sexual organs of the male. These reproductive tissues in mammals now deserve somewhat further attention. Nothing need be added to the morphological descrip-



tion of the ovum, which has already been fully considered. Some points in the development of the ovum and its attendant phenomena nevertheless deserve consideration.

The ova are developed in the matrix of the ovary. The latter consists of a connective-tissue frame-work supplied with blood-vessels, nerves, and lymphatics, whose surface is covered with a layer of columnar epithelium—the remains of the germinal epithelium. The most superficial layer of the ovary is called the tunica albuginea and contains no ova; but if section be made of the ovary, throughout its entire substance will be found small follicles varying from one-hundredth to one-thirtieth of an inch in size. In each of these Graafian follicles will be found an ovum in different stages of development. Immediately after

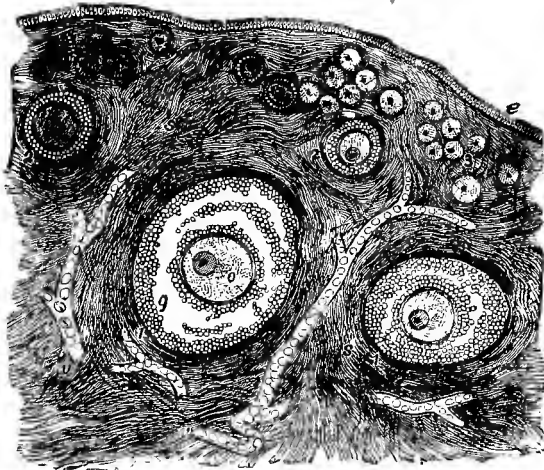

FIG. 414.—SECTION OF AN OVARY. (Landois.)

*e*, germ epithelium; 1, large-sized follicles; 2, 2, smaller sized follicles; *o*, ovum within a Graafian follicle; *v*, *v*, blood-vessels of the stroma; *g*, cells of the membrana granulosa.

birth the ovary contains immense numbers of ova—in the human female infant from forty thousand to seventy thousand. The ova develop from the layer of germinal epithelium which originally completely surrounded the ovary. At different intervals on the surface depressions form, which serve to carry in a layer of germinal epithelium to form the so called ovarian tubes. These tubules gradually become deeper and deeper, and contain within their interior large, single, spherical cells, with a nucleus and a nucleolus, in addition to the small, columnar cells lining the tube. As the tubules extend into the ovary the growth of the stroma of the ovary serves to constrict the orifices of the tubules, and finally their openings become completely obliterated, and the tubule, which originally began as a pocket-shaped depression on the surface of the ovary, now

exists as a closed, more or less circular follicle, completely separated by the ovarian stroma from the surface (Fig. 414).

Each compartment, or Graafian follicle, so formed usually contains one, or at the most two, ova, which develop from the large cells (primordial cells) already referred to.

The lining of the tubule, which it must not be forgotten was derived from the exterior covering membrane of the ovary, is spoken of as the *membrana granulosa*, and at one point its cells become elevated to form a projection, the *proligerous disk*, by which the ovum is connected with the *membrana granulosa*. The follicles are at first only .03 millimeter in diameter, but they gradually become larger, especially at the time of puberty. The entire cavity of the Graafian follicle is occupied by a fluid, the so-called *liquor folliculari*, which gradually accumulates during the growth of the Graafian follicle. Each Graafian follicle is, therefore, composed of an external tunic which is highly vascular in character. Within this is the granular layer rising at one point to form the *proligerous disk*, in contact with which is the ovum, while the remainder of the follicle is occupied with fluid. As the follicles increase in size they become depressed toward the centre of the ovary, but when about to burst again rise to the surface, until, finally, the walls of the Graafian follicle will lie directly below the germinal epithelium on the surface of the ovary. Its diameter is now from one millimeter to 1.5 millimeters. The rupture of the first Graafian follicle corresponds with the occurrence of puberty or of fertility and indicates the period at which the female organism first becomes capable of the functions of generation. The smaller the mammal the earlier does this capability for procreation appear. In the smaller mammals, such as the rabbit, the guinea-pig, and the rat, as well as in birds, it appears within the first year; in larger animals, as the cat and the dog, in the second year, while in the largest mammals, as the horse, cattle, and the lion, in three years; in the llama, in four years; in the camel, in five years; in the human female, about the fourteenth year, and in the elephant, between the twentieth and the thirtieth year.

Puberty in the human female is recognized by the first occurrence of menstruation, which consists in the escape of blood from the external genitals. In warm climates menstruation first sets in between the ages of eleven and twelve years; in cold climates between the ages of fourteen and sixteen years. The duration of each single menstrual period varies, as a rule, from three to five days, although it may last as long as eight, or only one or two days. Toward the age of forty or fifty years in the human female the procreative faculty disappears and with it the menses cease. Such a period is spoken of as the climacteric or menopause.

At the occurrence of puberty various changes take place which mark the appearance of reproductiveness. As such may be mentioned increased vascularity and development of the external and internal generative organs, the characteristic changes which now commence in the pelvis, the development of the mammæ, and the growth of hair on the pubes and in the axilla. Menstruation recurs, usually, at intervals of twenty-eight days, and each menstrual period corresponds with the ripening and rupture of a Graafian follicle. During menstruation from one hundred to two hundred grammes of blood escape. This blood has lost its power of coagulation, probably through mixture with the alkaline secretions of the uterus and vagina. The source of the hemorrhage is the mucous membrane lining the uterus. The ciliated epithelium of the uterus becomes swollen, congested, and soft, and almost entirely shed. A similar congestion likewise occurs in the ovaries and Fallopian tubes, the congestion of the ovary leading to a greater transudation of fluid into the Graafian follicle and consequent rupture, while the great congestion and engorgement of the blood-vessels of the uterus lead to the rupture of the finer capillaries and the consequent escape of blood.

In addition to the congestion of the internal genital organs, the external genital organs also become more strongly congested and swollen.

Phenomena analogous to the process of menstruation in the human female occur in all females of the class of mammals, in the domestic animals the condition being spoken of as heat, and its first occurrence marks not only the first appearance of the power of procreation but also the times at which copulation with the male will be permitted. In all of the domestic animals the occurrence of heat coincides with the rupture of one or more Graafian follicles and the escape of one or more ova from the ovary, together with the increased vascularity of the genitals. The external signs of heat are the following: Slight swelling and reddening of the vagina and vulva, more or less flow of mucous, reddish discharge from the genitals, characterized by a peculiar odor, which especially seems to possess the power of attracting the male, frequent urination, often slight swelling of the mammary gland with alteration in the characters of the milk; the disposition of the animal becomes restless, it seeks the male of the same species, frequently gives vent to various cries, and sometimes refuses to eat. The characteristics of heat vary somewhat in different animals. In the mare urination is frequent, the vulva is the seat of spasmodic discharge, and the clitoris becomes erect. The mare whinnies and seeks the male. Occasionally a small amount of blood escapes from the external genitals. The cow becomes very restless, continually bellows, and attempts to mount other animals even of the same sex. In sheep the appearances of heat are less characteristic, and are

evidenced simply by greater uneasiness, leaving the flock and seeking the ram, and will only then permit the act of copulation. The same remarks also apply to the goat. The sow at this time appears to grunt more than usual, is more irritable and more vivacious, is restless, may bite, and shows loss of appetite. Heat reaches its maximum in twelve to sixteen hours. In the bitch there occurs a great hyperæmia of the genital parts and an abundant exudation of bloody mucus. The vulva is congested and swollen, and the animal is much more lively and vivacious than usual and playful, especially with dogs which are attracted from a great distance by the peculiar odor of the discharge.

In all the domestic animals the phenomena of heat have a longer or shorter duration. In the mare they last from two to three days; in the cow, from fifteen to thirty hours; in the sow, from one to three days; in the sheep, from two to three days; in the goat, from two to three days, and in the bitch, from nine to fourteen days.

If conception occurs the phenomena of heat only make their reappearance after delivery. In the cow this occurs in three to four weeks after delivery, and recurs every three weeks if impregnation does not occur. In the mare heat may appear from five to nine weeks after delivery, and, if impregnation does not occur, every nine days afterward. So long as the sow is suckling phenomena of heat do not appear, but after the removal of the young heat comes on about the third day, and, if impregnation does not occur, recurs every nine or twelve days. In the sheep, after delivery, heat occurs in from three to four weeks; when suckling only two to four months later, and recurs at intervals of from seventeen to twenty-five days. The mare is in heat usually in the spring and again in the autumn; the goat in the autumn; the sheep in the autumn and spring, while the other animals are in heat at intervals throughout the entire year at the intervals already mentioned (Strebel).

The occurrence of menstruation and heat coincides with the ripening of an ovum. In the human female, as in the mare and cow, one ovum or, at the most, two ripen at one time; in the goat, from one to four, while in the dog and cat as many as ten ova may mature together.

Through an increase of the blood pressure in the vessels of the ovary blood transudes into the interior of the Graafian follicle, and thus, by increasing the pressure, causes a rupture of the wall at its thinnest point, and the ovule, together with the proligerous disk and the follicular fluid, escape into the abdominal cavity. The ovary lies free in the abdominal cavity in a fold of the peritoneum. As the ovule escapes from the ovary the Fallopian tube, and its fimbriated extremity, is found, from its state of congestion, in a condition of erection, and in all probability the fimbriated extremity becomes closely applied to the ovary. As a consequence, the ova escaping from the ovary fall within the mouth of the

ovarian tube and are carried toward the uterus by means of the cilia lining the Fallopian tube. Frequently such a close contact does not occur, since numerous cases of failure of the ova to enter the Fallopian tube are recorded, and, as a consequence, abdominal pregnancy may take place. Still, there is no doubt that the congestion of the Fallopian tubes must result in their erection, as may be accomplished artificially by injection of their blood-vessels. It is probable that the currents set up by the continued motion of the cilia in the Fallopian tubes are the main cause in leading to the entrance of the ova into the Fallopian tubes.

After the ovum has entered the Fallopian tube from one to three days is required for its passage to the uterus. Here, if not already impregnated, it may meet with spermatozoa, or may undergo fatty degeneration, although certain changes, as already detailed, may occur in the ovum even when unimpregnated.

As the Graafian follicle bursts it discharges its contents and collapses, while in its interior remains the residue of the granular membrane and a small quantity of blood, which rapidly coagulates. The vascular walls of the follicle swell up, and connective-tissue proliferation gradually leads to the filling up of the follicle, whose contents finally undergo fatty degeneration, and from the yellow appearance thus produced the name *corpus luteum* has been applied to this spot. If pregnancy has not occurred the fatty matter is rapidly absorbed, the blood breaks up into hæmatin and other derivatives, while the entire mass gradually shrivels, and by the end of four weeks has almost disappeared. Such a corpus luteum is spoken of as a false corpus luteum. If impregnation has taken place this corpus luteum instead of disappearing increases in size, so that at the end of three or four months its walls are thicker and its color deeper, and at the termination of gestation it may be as large as six or ten millimeters in diameter, and may remain for a long time afterward. Such a form is spoken of as a true corpus luteum. It is, however, probable that too much importance has been laid upon the distinction between these two forms.

2. THE REPRODUCTIVE TISSUES OF THE MALE.—The secretion of the male genital organs is known as the seminal fluid, or sperm, and it is formed by the secreting tubules of the testicles. It consists of a whitish-yellow, sticky fluid of high specific gravity and of neutral or alkaline reaction. In the seminal fluid of the horse are found 18 per cent. of solids, in that of the bull 17.6 per cent., while in that of man there is only 10 per cent. of solids, of which 4 per cent. consists of inorganic salts, especially of calcium and magnesium phosphate. When exposed to the air it becomes more fluid, and when water is added to it, it becomes gelatinous. The seminal fluid as discharged from the urethra is mixed with the secretions

of the glands of the vas deferens, of Cowper's glands, of the prostate gland, and of the vesiculæ seminales. It contains water, varying from 80 per cent. to 90 per cent. in different animals, serum-albumen, alkali albumen, nuclein, lecithin, eholesterin, fats, salts, especially the phosphates of the alkaline earths, with sulphates, carbonates, and chlorides, and a peculiar odorous principle the nature of which is unknown.

When examined with the microscope it is found that the seminal fluid may be divided into a plasma and formed elements. The constituents already mentioned constitute the plasma of the semen and the formed elements are the so-called spermatozoa, and it is the latter which are the active elements of the secretion in the function of reproduction.

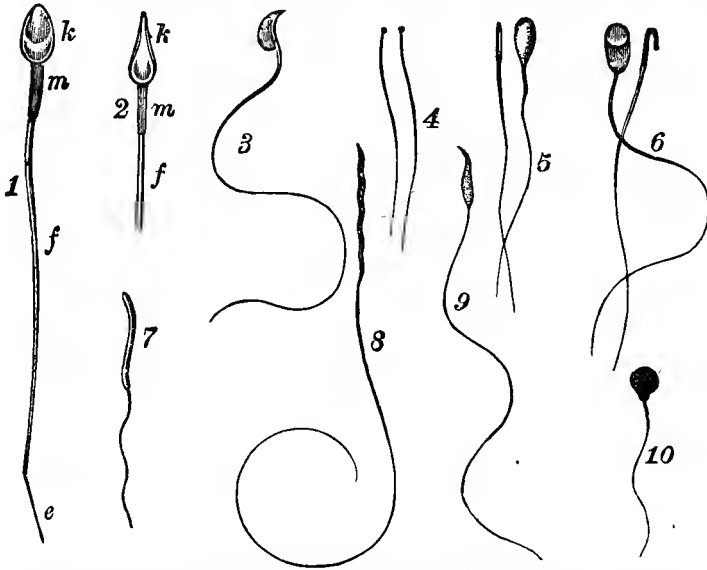

FIG. 415.—SPERMATOZOA. (Landois.)

1, human ( $\times 600$ ), the head seen from the side; 2, on edge; *k*, head; *m*, middle piece; *f*, tail; *e*, terminal filament. 3, mouse. 4, bothriocephalus latus. 5, deer. 6, mole. 7, green woodpecker. 8, black swan. 9, from a cross between a goldfinch (*m*) and canary (*f*). 10, cobitis.

Each spermatozoon consists of a flattened or pear-shaped head, followed by a rod-shaped middle piece with a long, tail-like prolongation, or cilium. When examined shortly after extrusion from the testicle, the cilium is found to be in rapid vibration, and by this motion the entire spermatozoon is propelled forward at the rate of about half a millimeter in a second. The movement of the spermatozoon is identical with that of other forms of ciliated movement and is affected in the same way by the same reagents. At first the movements are active, and, under favorable circumstances, they come to rest only after two or three days. The spermatozoa of different animals differ in shape and size, as is shown in

the accompanying diagram (Fig. 415). In man the spermatozoa are about .05 millimeter in length, the head being oval with a thickened posterior border, and their shape is, therefore, somewhat analogous to that of a pear.

The spermatozoa are developed from the nucleated protoplasmic cells which line the seminal tubules of the testicle. These tubules are lined by several layers of more or less cubical cells. The outer cells, next the basement membrane, often show a large nucleus in process of subdivision. Internal to these are several layers of inner cells with nuclei, often dividing so that they form a progeny of cells internal to those toward the lumen of the tube. From these cells so formed by subdivision and which are termed spermatoblasts the spermatozoa are formed. These spermatogenic cells are spindle-shaped and form nucleated protoplasmic prolongations which project into the lumen of the tube and break up at their free ends into flat, round, or oval lobules. During the

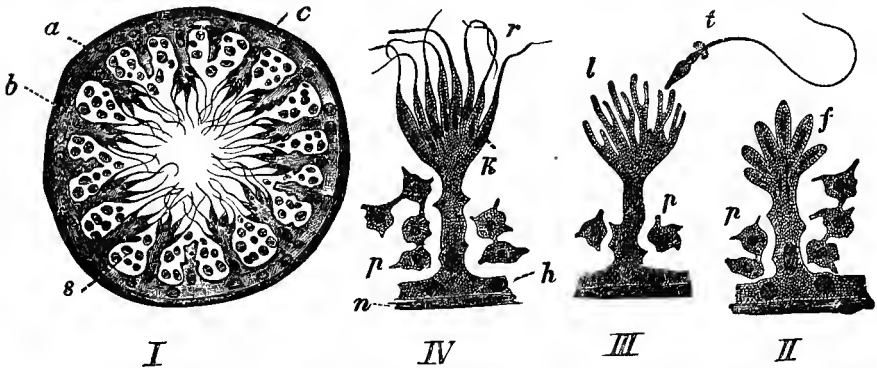

FIG. 416.—SEMI-DIAGRAMMATIC SPERMATOGENESIS. (Landois.)

*I.* Transverse section of a seminal tubule; *a*, membrane; *b*, protoplasmic inner lining; *c*, spermatoblast; *s*, seminal cells. *II.* Unripe spermatoblast; *f*, rounded cleavage lobules; *p*, seminal cells. *III.* Spermatoblast, with a free spermatozoon, *t*. *IV.* Spermatoblast, with ripe spermatozoa, *k*, not yet detached; *r*, tail; *n*, wall of the seminal tubule; *h*, its protoplasmic layer.

process of development of these spermatoblasts each lobule lengthens into a tail or cilium-like prolongation, while the deeper part still in connection with the walls of the tube will ultimately form the head and middle portion of the spermatozoon: so that in this stage of its development the sperm is composed of an enlarged cylindrical cell terminating in cilium-like prolongations. When the development is complete the head becomes detached and the remainder of the spermatoblast undergoes fatty degeneration, although a small amount of the protoplasm may remain temporarily attached to the head of the spermatozoon (Fig. 416).

Between the spermatoblasts lining the lumen of the seminal tubules are found numerous round cells possessed of amœboid movement, the so-called seminal cells, which are probably concerned in the formation of the fluid parts of the semen.

As in the maturity of the ova, so the formation and maturity of the spermatozoa indicate the occurrence of puberty. In the human male this takes place about the age of fifteen or sixteen years, and in other mammals it occurs a short time later than the occurrence of fertility in the female of the same species. The appearance of puberty in the male is also attended with certain characteristic signs. The larynx undergoes a rapid increase in size, and, as a consequence, the voice becomes deeper, while hair makes its appearance on the pubes, in the axillæ, and on the face. The sebaceous glands become larger and more active. In the male of the domestic animals the appearance of procreativeness is recognized by the occurrence of the capability of erection of the penis and the birth of sexual desires. In the domestic animals in a state of nature sexual excitement occurs in the male only at definite periods of the year, but in domestication this makes its appearance whenever a mature male is in the neighborhood of a female of the same species when in heat.

**IMPREGNATION.**—Only those mammalian ova become developed into embryos which are fecundated through contact with the male spermatic element, and that this may be accomplished the introduction of the seminal fluid within the internal genital organs of the female is essential. That this process, which is termed coition, may be accomplished the erection of the male genital organ, the penis, is essential in order to permit its penetration within the vagina of the female.

The penis is composed of the two cylindrical corpora cavernosa with the corpus spongiosum, perforated by the urethra, lying between and below them, these three bodies being held together by fibrous and muscular sheaths. The corpora cavernosa, and to a less extent the corpus spongiosum, are composed of erectile tissue, which consists of a tendinous connective-tissue sheath containing thickly woven elastic tissue and smooth muscular fibres, forming thus a fibrous envelope; while the interior is composed of numerous fibrous interlacing trabeculæ, the spaces being in communication with the veins, and are thus to be regarded as venous sinuses. At the outer part of the corpus spongiosum some of the small arteries terminate directly in the outer venous sinuses, while some, however, terminate in capillaries which ultimately reach the venous sinuses, to be collected again in the venous radicals which converge to form the dorsal vein of the penis.

Erection is accomplished by the overfilling of these venous sinuses, while the engorgement so produced by compressing the outgoing venous trunk serves to prevent the escape of blood from these parts. The overfilling of the blood-vessels of the penis results in a three- or four-fold increase in its volume, while, at the same time, a higher temperature, pulsatile movement, an increased consistence, and erection of the organ results. The first phenomenon in the production of erection is to



be found in the dilatation of the minute arteries through the action of the *nervi erigentes*. These nerves are to be regarded as containing vasodilator fibres which are in connection with a centre in the spinal cord, controlled to a certain extent by the *medulla oblongata*, and also capable of being reflexly excited by impressions made upon the terminal filaments of the sensory nerves of the penis. The centre in the lumbar portion of the cord is also capable of being controlled by various other afferent impulses, especially by the psychical activity of the cerebrum. When, through any impression on the centre for erection, the blood-vessels dilate through the action of the *nervi erigentes*, the completion of the act of erection is accomplished by the action of several transversely striated muscles. The *ischio-cavernosus* muscle arises from the coccyx, and by its tendinous union with its fellow from the opposite side surrounds the root of the penis, and by its contraction compresses the penis so as, to a certain extent, to prevent the flow of blood from the organ. This muscular action was at one time supposed to be the main factor in the accomplishment of erection, but that this is not the case is proven by the fact that the dorsal vein, lying in the groove between the two *corpora cavernosa*, is protected from compression, and the congestion of the organ is by no means due to the complete arrest of the venous circulation. Otherwise, in certain pathological conditions where erection is continuous, gangrene would result. The deep transverse muscle of the perineum also serves to facilitate erection by compressing the deep veins of the penis as they come from the *corpora cavernosa* between its contracted horizontal fibres; while, finally, the *bulbo-cavernosus* muscle compresses the bulb of the urethra and so assists in the erection of the urethral corpus spongiosum. That erection is dependent upon the nervous system is proven by the fact that section of the nerves of the penis will prevent erection, as has been experimentally proven in the case of the stallion.

In the bull, in the process of erection, the S-shaped curve disappears and the erected organ, protruding from the sheath, may acquire a length of a meter or more, while the increase in diameter, owing to the great development of the fibrous sheath of the organ, is less than in other mammals.

The erection of the penis has simply for its object the giving such an increase to the rigidity of the organ as to permit of its introduction within the genital organs of the female.

The contact of the sensitive glans with the rugæ of the vagina inaugurates a reflex process which terminates in the discharge of the seminal fluid through the urethra.

In this process, which is termed ejaculation, two different factors are concerned. In the first place, the passage of the seminal fluid to the

vesiculæ seminales is caused by the newly secreted fluid forcing on, through the influence of the ciliated epithelium and the peristaltic action of the vas deferens, the fluid already formed in front of it; so that, therefore, the seminal fluid, being continuously formed by the secreting surface of the testicle, is gradually pushed onward, even in the intervals of sexual excitement, to the vesiculæ seminales, where it collects. Ejaculation is, however, due to strong peristaltic contraction of the vasa deferentia and the vesiculæ seminales, due to the reflex stimulation of the centre in the spinal cord, which co-ordinates the muscular phenomena of ejaculation. The mechanical stimulation of the sensitive integument of the glans, through action on this centre, leads to rhythmical contraction of the bulbo-cavernosus muscles and to strong peristalsis of the vasa deferentia and the vesiculæ seminales, which discharge their contents into the urethra. At the same time the ischio-cavernosus and the deep transverse muscle of the perineum contract, although the former has no effect on the act of ejaculation, and through their rhythmical contraction the seminal fluid is projected from the extremity of the urethra. The degree of stimulation of the glans which is required to start this mechanism varies very considerably in different animals. In all, the rôle fulfilled by the male is an active process, the female being passive, although a condition somewhat similar to that of ejaculation also exists in the female. It has been found that at the moment of ejaculation a reflex movement sets in in the Fallopian tubes and uterus resulting in the discharge of a certain amount of uterine mucus into the vagina. This is followed by a rhythmical contraction of the sphincter cunni, which is the analogue of the bulbo-cavernosus and of the ischio-cavernosus and of the deep transverse muscle of the perineum, while, at the same time, the uterus is erected by the contraction of its muscular fibres and round ligaments, at the same time descending toward the vagina. In the case of the bull, ejaculation occurs almost immediately after the introduction of the male organ within the vagina of the female, and the to-and-fro movement characteristic of the process in other animals is here absent. This is probably to be explained by the peculiar shape of the penis of the bull. In the first place, as has been stated, the organ increases but slightly in its diameter, and, as a consequence, any friction of the body with the capacious vagina of the female would be at best at a minimum. In the second place, the glans penis of the bull is extremely pointed, and it has been supposed that the glans directly enters the open mouth of the uterus, and that the irritation thus produced is sufficient to start the process of ejaculation. This view is to a certain extent supported by the fact that examination of the female ruminant immediately after the act of copulation will disclose the presence of spermatozoa within the uterine cavity. This has frequently been determined to be the case in sheep, where the

process is similar. In the case of the horse the process is more prolonged. Here the glans, instead of being pointed, as in the case of the bull, possesses a considerably larger diameter than other portions of the organ, and it is found that complete erection of this portion of the penis does not take place until after the introduction of the organ within the vagina of the female. The penis completely fills the vagina of the mare, and more or less prolonged friction between its surface and that of the penis is necessary before the act of ejaculation is accomplished.

In the dog, on the other hand, the process differs from what has been described in either of the other groups of mammals. After the introduction of the penis within the vagina of the female spasmodic contraction of the sphincter *unni* muscle sets in, and, as a consequence, the withdrawal of the male organ from the body of the female is, on account of its peculiar shape, rendered impossible until almost complete relaxation has taken place. In the dog the process of relaxation is slower than in other animals, and may not be completed until within half an hour or even so long as two hours after the act of ejaculation. In these animals, therefore, after the act of coition is accomplished, the penis becomes inverted on itself, until, instead of projecting anteriorly, it is drawn backward between the hind legs of the animals through the attempts of the male to leave the body of the female, and the two posterior surfaces are kept in contact by the imprisonment of the male organ.

Ejaculation is accompanied by the contraction of various other muscles. The cremaster muscle elevates the testicle within the scrotum, and the walls of the urethra contract in its various portions, serving to compress the prostate and Cowper's glands and so cause the extrusion of their contents. In the stallion the act of ejaculation is accompanied by a rhythmical contraction of the muscles inserted into the tail. By every contraction of the ejaculator *urinæ* muscles the muscles passing from around the anus to the tail are compressed, and, as a consequence, the rhythmical motion of the ejaculator *seminalis* is communicated to the tail, and, therefore, by its movement affords an index to the completion of the act of ejaculation. After the act of copulation is completed the male organ is withdrawn and erection gradually disappears, while there may be an escape of seminal fluid from the genital organs of the female. This is especially observable in the case of the mare, where it has become the custom immediately after the completion of the act of copulation to either load the back of the mare or to make her move rapidly, so as to prevent to a certain extent this loss.

A single spermatozoon is, in all probability, sufficient to fertilize an ovum, and this is accomplished by the entrance of the spermatozoon into the ovum by a boring movement through the vitelline membrane, either through the porous canals or the micropyle.

The locality in which fertilization takes place may be either the ovary, as is shown by the occurrence of abdominal pregnancy, the Fallopian tube, or the cavity of the uterus itself. The manner in which the spermatozoa obtain access to the ovum is not capable of clear demonstration. In the case of the ruminants, as has been seen, there are reasons for believing that the spermatozoa are deposited directly within the cavity of the uterus. In other animals, where in all probability this does not take place, the entrance of the spermatozoa into the uterus may be accomplished by the suction which results from the relaxation of the uterus as this condition of erection and engorgement passes off, and it is a matter of common experience that the introduction of semen even within the vestibule of the vagina is frequently sufficient to produce fertilization. It is probable that the vibration of the cilia is concerned in causing their movement to meet the ova. It must not be forgotten, however, that within the uterus, and especially within the Fallopian tubes, the motion of the ciliated epithelium is normally in the opposite direction to that in which the spermatozoa must move to reach the ovary, so that while this ciliary motion would facilitate the descent of the ovum, it must offer an obstacle to the ascent of the spermatozoa.

Nothing absolutely definite is known as to the manner in which the bringing together of the male and female spermatie elements is accomplished. It is only clearly known that the spermatozoa in some way possess the power of rapidly ascending through the internal sexual organs of the female. Spermatozoa have been found within the uterine cavity of the dog a quarter of an hour after the act of copulation, and in the Fallopian tube, even at its abdominal end, within one or two hours.

The spermatozoa retain their power of fertilizing the ovum, as indicated by the persistence of their power of movement, for as long as eight days while within the body of the female,—a period which is abundant to permit the ripening and discharge of an ovum and its contact with the spermatozoa. Even if copulation takes place in the intervals between the maturing of the ova, fertilization may, nevertheless, take place.

As a rule, fertilization of ova is only possible from the contact with spermatozoa from the same species; yet in certain instances fertilization may take place between different species of the same genus of animals, as, for example, between the horse and the ass, between the dog and the wolf, between the dog and the fox, between the lion and the tiger, and between the rabbit and the hare. The results of such impregnation are spoken of as hybrids, and possess characteristics midway between the two species. The products of such impregnation are, as a rule, barren from arrested development of their genital organs (testicle and ovary).

The impregnated ovum, whatever be the locality in which impregnation takes place, is borne to the interior of the uterus, there to

undergo the changes which, starting in the cleavage of the blastodermic membrane, as already described, terminate in the development of the embryo. When such a fecundated ovum reaches the uterus it inaugurates certain changes in the mucous membrane of that organ. It has been noticed that the maturity and escape of the ovum is accompanied by congestion and swelling of the uterine mucous membrane with the ultimate solution and discharge of the mucous surface. When the impregnated ovum reaches the uterus it becomes covered by a membrane which was first described by William Hunter as the *membrana decidua*, because it was removed at birth. Three different divisions of this membrane may be recognized. The *decidua vera* is the thickened, highly vascular, and softened mucous membrane of the uterus. As the ovum reaches the uterine cavity it becomes fixed (conception) in a fold of the uterine decidua or *decidua vera*, which grows up in the form of folds, entirely surrounding the ovum. These folds finally meet over the back of the ovum and so form the *decidua reflexa*. The part of the *decidua vera* behind the ovum, *i.e.*, between the ovum and the uterine wall, is spoken of as the *decidua serotina*, in which locality the placenta is ultimately formed. The ovum, covered with villous processes, is thus entirely surrounded by the decidua, and, gradually increasing in size, remains within the cavity of the uterus until mature.

For the consideration of the development of the different tissues and organs of the embryo, the reader is referred to text-books on Anatomy or Embryology.



PLATE I.

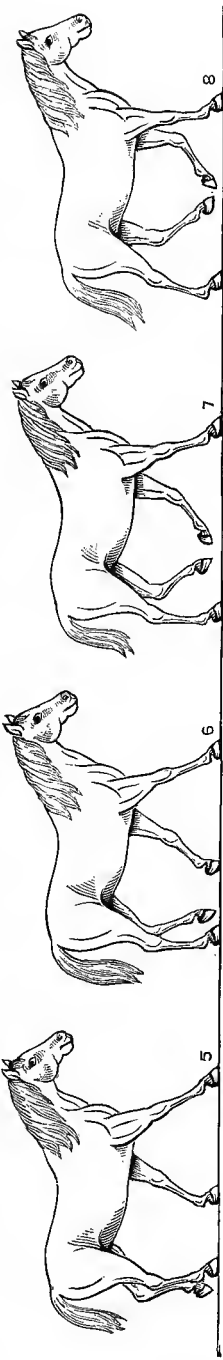
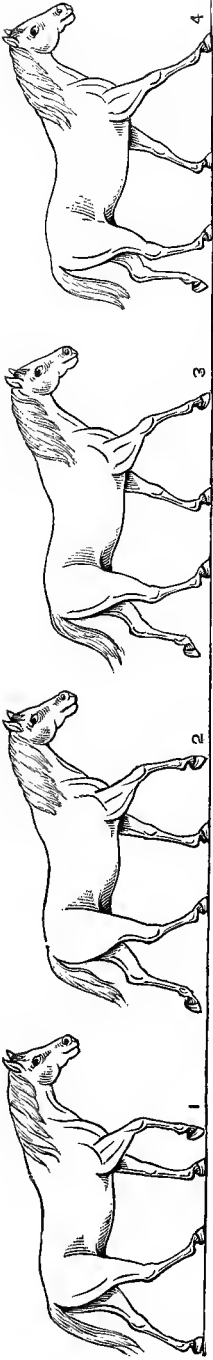

Walking.





PLATE II.



1



2



3

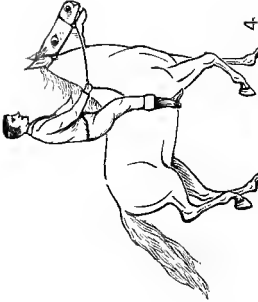

4

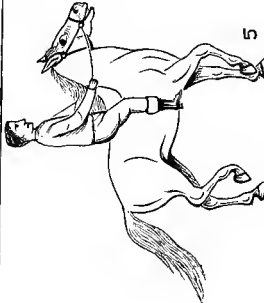

5



6



7

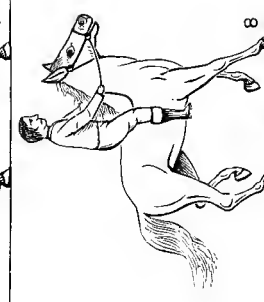

8



9

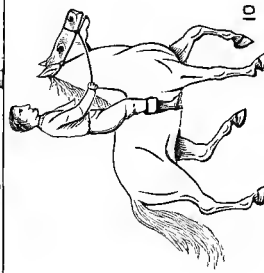

10

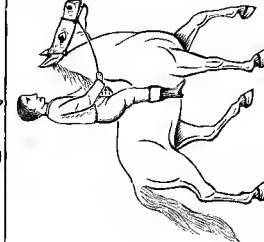

11

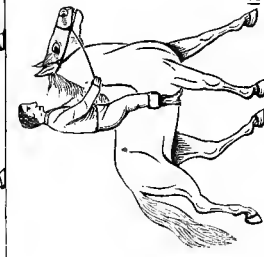

12



PLATE III.

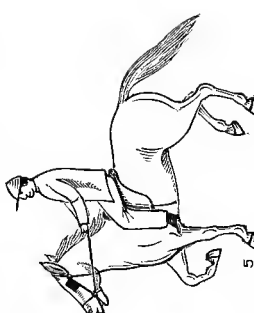
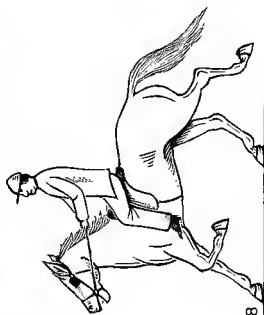
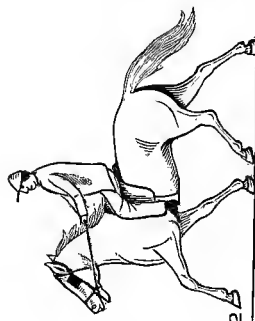

Facing.



PLATE IV.

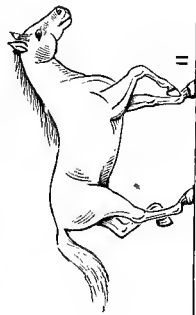
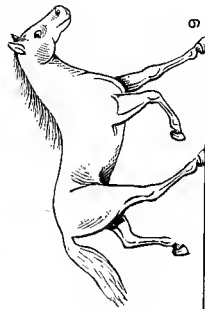
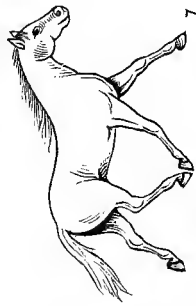
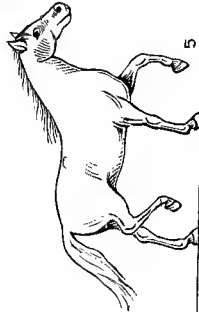
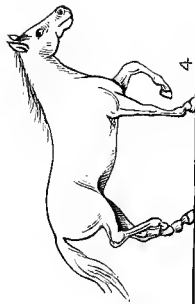
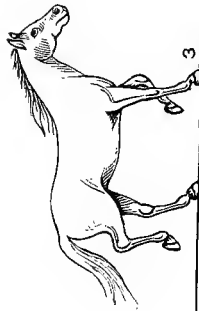
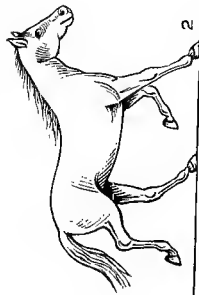
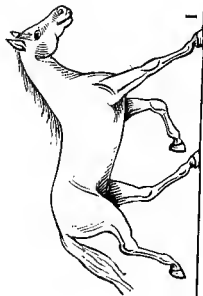

Trotting.



PLATE V.



1



2



3

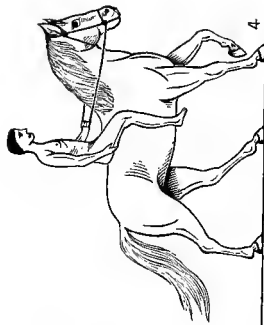

4



5

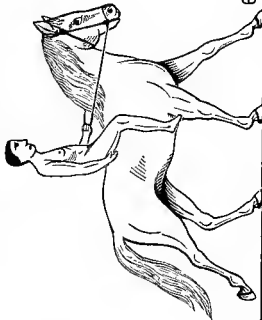

6

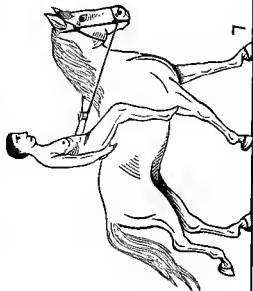

7

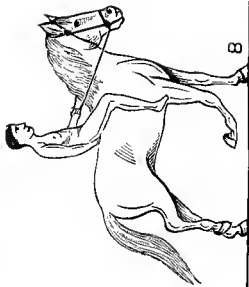

8



9



10



11



12

Centering.





PLATE VI.



1



2



3



4



5



6



7



8



9



10



11



12



13



14



15



16



17



18



19



20

Running.



# INDEX.

- Abdominal muscles, action of, in expiration, 579  
Abducens nerve, 833, 875  
Aberration, chromatic, 855  
    spherical, 854  
Abomasum, structure of, 320  
Absorption, 453  
    by the lymphatics, 456  
    by the skin, 656  
    coefficient of, 59  
    of fat, 456  
    of gases, 58  
    of tissues for colors, 68  
Accelerator nerves of the heart, 551  
Accessory foods, 160  
    muscles of inspiration, 578  
Accommodation, mechanism of, 859  
Acid albumen, 98  
    of gastric juice, 349  
Adamkiewicz's test for proteids, 92  
Adhesion, 40  
Adipose tissue, formation of, 120, 664  
Age, signs of, in domestic animals, 262  
    the determination of, by the teeth, 255  
Air-vesicles, 571  
Ajutage, influence of, 518  
Albumen, alkali, 101  
    destruction of, in starvation, 676  
    factor of, 673  
    of milk, estimation of, 634  
Albumens, 92  
Albuminates, derived, 98  
Albuminoids, 104  
    collagenous, 105  
Albuminous bodies, 85  
    classes of, 92  
    decomposition of, 109  
    general characteristics of, 88  
    food-constituents, fate of, 660  
Alcoholic fermentation, 147  
Alimentary rations, 195  
Alkali albumen, 101  
    albuminate, 101  
Alkaline phosphates, 130  
Amandin, 94  
Amble, the, 746  
Ammonium carbonate, 136  
Amœba, 13  
    digestive processes in, 204  
Amœboid contractility, 14  
    movements, 14, 75  
Amphiarthroses, 729  
Amphibia, brain of, 804  
    olfaction in, 844  
Amyloid substance, 102, 115  
Amyolytic ferment, 112  
Amyloses, 112  
Amylum, 113  
Analysis of milk, 631  
Anelectrotonus, 780  
Animal cells, chemical processes in, 142  
    foods, 188  
    composition of, 184  
    heat, 693  
    influence of nervous system on, 697  
    of different animals, 696  
    locomotion, 731  
Animals and plants, distinctions between, 5  
    diet of, 193  
Anode, 777  
Anterior pyramids, structure of, 811  
Antipeptone, 409  
Aortic valves, action of, 514  
Arabin, 120  
Arabinose, 120  
Area opaca, 21  
    pellucida, 21  
Arterial blood, characteristics of, 597  
    gases of, 592  
    tension, 526  
    tonus, 557  
Arteries, blood pressure in, 528  
    circulation in, 523  
    elastic tissue of, 525  
    influence of the nervous system on, 552  
    muscular coat of, 525  
    physical structure of, 524  
Arterioles, circulation in, 538  
Articulata, nervous system of, 767  
Articulations, classification of, 729  
Arthrodia, 730  
Asphyxia, 604  
Ass, larynx of, 760  
Aster, 17  
Atropine, action of, on heart, 543  
Audition, 875  
Auditory apparatus of birds, 876  
    of fishes, 876  
    of reptiles, 876  
    canals, 880  
    nerve, 834  
Augmentation, 785  
Auricle, 877  
Auricles, contraction of, 503  
    muscular fibres of, 501  
Auriculo-ventricular valves, action of, 510  
Automatism, 765, 784  
    of protoplasm, 14

- Ball-and-socket joint, 730  
 Barley-bran, 171  
   composition of, 170  
   straw, 171  
 Basal ganglia of the brain, development of, 807  
   functions of, 822  
 Basis cruris, 819  
 Beef-tea, composition of, 190  
 Beet residue, 182  
 Beets, 174  
 Bile, 382  
   acid, preparation of, 385  
   acids, 384  
   chemical characteristics of, 383  
   coloring matters of, 387  
     test for, 388  
   composition of, 383  
   crystallized preparation of, 385  
   inorganic constituents of, 390  
   physiological action of, 393  
   salts, test for, 385  
   secretion of, 391  
 Biliary fistulæ, 394  
 Bilirubin, 388  
 Biliverdin, 389  
 Birds, auditory apparatus of, 876  
   brain of, 804  
   digestive apparatus of, 211  
   gastric digestion in, 379  
   nervous system of, 770  
   olfaction in, 844  
   organs of circulation in, 497  
   production of sound in, 759  
   reproduction in, 905  
   respiratory apparatus of, 568  
   vision in, 849  
 Biuret reaction of proteids, 91  
 Blastema, 16  
 Blastoderm, 20  
   changes in form in impregnation, 22  
   section of, 21  
   segmentation of, 22  
 Blastodermic vesicle, 25  
 Blastopore, 25  
 Blood, 469  
   absorption of carbon dioxide, 595  
     of gases, 592  
   circulation of, 491  
   coagulation, 483  
   composition of, 471  
   corpuscles, 27  
     red, 471, 474  
     white, 479  
   crystals, 475  
   current, velocity of, 530  
   gases of, 490, 592  
   plasma, 483  
   plates, 483  
   pressure, 525  
     experiment, 526  
     in arteries, 528  
     in different mammals, 530  
   Blood pressure in the capillaries, 538  
     quantity of, 470  
     respiratory changes in, 591  
     serum, 489, 595  
     tension of gases in, 596  
 Bone-corpuscles, 29  
 Bone, development of, 35  
 Bones of the ear, 880  
   heart, 509  
 Bran, barley, 171  
 Branching tubes, flow of liquids in, 521  
 Brain, development of, 803  
   functions of, 803  
   of mammals, 809  
   size of, in different animals, 808  
   weight of, in different animals, 809  
 Bread, composition of, 165  
 Brewers' grains, 179  
 British gum, 116  
 Bronchi, structure of, 570  
 Brunner's glands, 416  
 Buckwheat, 171  
 Buckwheat-meal, 172  
 Buckwheat-straw, 172  
 Budding, 16  
 Bulbs and roots, 174  
 Burdach, column of, 787, 797  
 Butter, 617  
   estimation of, 633  
 Buttermilk, 188  
 Butyric acid, 122  
 Butyrin, 122  
 Cæcal fistulæ, 428  
 Cæcum, 221  
   functions of, 423  
   secretion of, 428  
   structure of, 426  
 Calcium carbonate, 130  
   fluoride, 136  
   phosphate, 133  
   sulphate, 136  
 Cane-sugar, 119  
   gastric digestion of, 354  
 Canter, 751  
 Capillaries, blood pressure in, 538  
   circulation in, 536  
   development of, 34  
   of the lung, 571  
   structure of, 536  
 Capillarity, 40  
 Capillary phenomena, explanation of, 40  
 Carbohydrate food-constituents, fate of, 666  
 Carbohydrates, 112  
   action of pancreatic juice on, 406  
   as sources of fat, 666  
   construction of, 85  
   gastric digestion of, 354  
   influence of, on nutrition, 683  
 Carbonate of ammonium, 136  
   of calcium, 130  
   of magnesium, 130  
   of potassium, 129

- Carbonate of sodium, 129  
 Carbon dioxide, absorption of, by blood, 595  
 Cardiac contraction, phases of, 508  
   ganglia, 541  
 Cardiograph, 506  
 Cardio-inhibitory centre, 551, 816  
 Carnivora, characteristics of, 196  
   urine of, 637  
   dentition of, 254  
   digestive power of, 436  
   faeces of, 446  
   foods of, 160  
   gastric digestion in, 360  
   mastication in, 239  
   prehension of food in, 235  
   stomach of, 215  
 Cartilage, fibrillar, 35  
   fibro-, 35  
   forms of, 29  
   hyaline, 35  
   structure of, 35  
 Casein, 102, 614  
   estimation of, 634  
   gluten, 94, 95  
   mode of formation of, 627  
 Caseins, vegetable, 94  
 Cat-fat, 123  
 Cathode, 777  
 Cattle, normal foods for, 690  
 Cell-constituents, inorganic, 123  
   nitrogenous organic, 88  
   non-nitrogenous, 112  
 Cell, contents of, 12  
   variation in, 29  
   definition of, 13  
   doctrine, 15  
   formation, endogenous, 17  
     free, 16  
   membrane, 13  
   nucleolus of, 13  
   nucleus, 13  
   pigment, motions in, 75, 76  
   polar, 18  
   typical, 12  
 Cells, 11  
   chemical constituents of, 85  
   chemical processes in, 136  
   ciliated epithelial, 77  
   development of force in, 147  
   difference in size of, 27  
   endogenous formation of, 16  
   epiblastic, 25  
   form of, 27  
   general properties of, 12  
   hypoblastic, 25  
   inorganic constituents of, 86  
   mechanical movement in, 70  
   modification in the form of, 26  
   of spinal cord, 27  
   origin of, 14  
   physical process in, 37  
   protoplasmic, movements in contents of, 73  
   reproduction of, 16  
     water of, 86  
 Cellular chemistry, 85  
   physics, 37  
 Cellulose, 114  
   digestion of, 429  
 Cement, structure of, 246  
 Centre, cardio-inhibitory, 551, 816  
   cilio-spinal, 795  
   for closure of the eyelids, 816  
   for coughing, 817  
   for deglutition, 817  
   for dilatation of the pupil, 817  
   for glycogenesis, 817  
   for inhibition of reflex action, 793  
   for micturition, 649  
   for respiration, 816  
   for secretion of saliva, 817  
   for sneezing, 816  
   for suckling and mastication, 817  
   for vomiting, 817  
   of gravity of animals, 731  
 Cereals, 163  
 Cerebellar peduncle, results of section of, 827  
   tract, 797  
 Cerebellum, functions of, 825  
   structure of, 818  
 Cerebral convolutions, 804  
   cortex, functions of, 824  
   hemispheres, 809  
   lobes, 804  
   functions of, 823  
   peduncles, functions of, 821  
 Cerebrin, 775  
 Cerebrum, structure of, 823  
   functions of, 824  
 Chameleon, movements of pigment-cells, 75  
 Cheeks, action of, in mastication, 264  
 Cheese, 188  
 Chemical constituents of cells, 85  
   phenomena in respiration, 587  
   processes in animal cells, 142  
   in cells, 136  
   in vegetable cells, 137  
 Chloride of magnesium, 136  
   of potassium, 128, 129  
   of sodium, 128  
 Chlorophyll, functions of, 136, 137  
 Cholesterin, 389  
 Cholic acid, 387  
 Chondrin, 107  
 Chondrogen, 107  
 Chorda tympani, influence on salivary secretion, 298  
 Choroid membrane, 849  
 Chromatic aberration, 855  
 Chyle, 459  
   composition of, 461  
   movement of, 462  
 Chyle-vessels, 457  
 Chyme, characteristics of, 419  
 Cicatricula, 20

- Ciliary movement, 77  
   influence of acids on, 80  
     alkalies on, 81  
     anesthetics on, 81  
     imbibition on, 80  
     mechanical force of, 78  
     protoplasmic nature of, 81  
     temperature on, 80  
   nerves, 863  
 Ciliated epithelial cells, 77  
 Cilio-spinal centre, 795  
 Circulation, hydraulic principles of, 516  
   estimation of duration of, 531  
   in arteries, 523  
   in fishes, 494  
   influence of nervous system on, 540  
     of the respiration on, 605  
   in mammals, 497  
   in the capillaries, 536  
   in the veins, 539  
   of lymph, 467  
   of the blood, 491  
   organs of, 491  
   rapidity of, 531  
 Clarke's column, 799  
 Cleavage of ovum, 15, 19  
 Clover, composition of, 187  
 Coagulated proteids, 102  
 Coagulation of blood, 483  
   of milk, 614  
 Cochlea, 877  
 Cochlear nerve, 882  
 Co-efficient of absorption of gases, 59  
   of elasticity, 66  
 Cohesion, 38  
   of tissues, 62  
 Cold, action of on heart, 548  
 Collagen, 106  
 Collagenous albuminoids, 105  
 Colloids, osmosis of, 52  
 Colon, functions of, 429  
 Colostrum, 609  
   changes in, 620  
   corpuscles, 610  
 Comparative physiology, definition of, 1  
 Complementary volume of air, 573  
 Conduction in the spinal cord, 795  
 Conglutin, 94  
 Connective-tissue constituents, 104  
   tissues, 34  
 Constituents of food, fate of, 664  
 Contents of cells, 12  
 Contractile tissues, 701  
 Contractility of protoplasm, 14, 70  
 Convolutions of the brain, 804  
 Co-ordination, 785  
 Copper, 136  
 Cornea, 849  
 Corpora bigemina, 807  
   quadrigenina, 807  
   functions of, 822  
   striata, 807  
 Corpuscles of bone, 29  
   Corpus luteum, 913  
   Corpus striatum, functions of, 822  
   Cortex of the brain, functions of, 524  
   Corti's organ, 882  
   Cotton-seed cake, 183  
   Coughing, 605  
     centre for, 817  
   Cranial nerves, 832  
     origin of, 812  
   Cream, 617  
     composition of, 618  
   Crop, functions of, 380  
   Crura cerebri, 818  
     functions of, 821  
   Crying, 605  
   Crystallin, 97  
   Crystalline lens, 849  
   Cutaneous absorption, 656  
     functions, 651  
     respiration, 656  
   Cyclosis, 73  
   Cytoblasts, 16  
   Decomposition of the albuminous bodies,  
     109  
   Decussation of pyramids, 810  
   Defæcation, 451  
   Deglutition, 307  
     centre for, 817  
   Dental formula, 252  
   Dentine, structure of, 246  
   Dentition in domestic animals, 263  
     in herbivora, 258  
   Depressor nerve, 556  
   Derived albuminates, 98  
   Development of bone, 35  
     of tissue, explanation of, 15  
     of tissues and organs, 31  
   Dextrin, 116  
     test for, 116  
   Dextrose, 117  
   Diabetes, production of, 672  
   Diabetic centre, 671, 817  
   Dialysis, 53  
   Diapedesis, 539  
   Diarthroses, 729  
   Diarthrosis rotatoria, 730  
   Diastatic ferment of the liver, 671  
   Diaster, 17  
   Dicrotic wave, explanation of, 536  
   Diet of animals, 193  
   Diffusion, application of to respiration, 596  
   Diffusion of gases, 56  
     in the animal organism, 60  
     in the lungs, 592  
     through porous partitions, 58  
     of liquids, 49  
   Digestive muscle, functions of in mastication, 242  
   Digestibility of food-stuffs, 432  
   Digestion, 203  
     gastric, 337  
     in the mouth, 268

- Digestion in the small intestine, 382  
 Digestive apparatus, characteristics of, 203  
     co-efficient, 435  
 Dionæa muscipula, movements of, 72  
 Dioptric mechanisms of the eye, 851  
 Distillery mash, 180  
 Diuretics, mode of action of, 647  
 Division of nucleus, 17  
 Dog, dentition in, 260  
     fat, 123  
     larynx of, 761  
     urine of, 640  
 Dogs, diet of, 362  
 Double refraction, 68  
 Drinking, mechanism of, 236  
 Dry fodder, 162  
     composition of, 184  
 Duodenal follicles, 416  
 Dyspnœa, 603  
  
 Ear-ossicles, 880  
     movements of, 888  
 Ear, structure of, 877  
 Egg-albumen, 93  
 Egg of hen, formation of, 20, 21  
 Egg-osmometer, 55  
 Eggs, composition of, 190  
 Egg-yolk, structure of, 20  
 Elasticity, co-efficient of, 66  
     of tissues, 65  
 Elastic tissues, 35  
     tubes, flow of liquids through, 522  
 Elastin, 108  
 Electrical phenomena of tissues, 70  
     in muscle, 721  
     in nerves, 779  
 Electricity, influence of, on nerves, 777  
 Electrotonus, 780  
 Elementary organisms, 11  
 Enamel, structure of, 245  
 Enarthrosis, 730  
 Encephalin, 775  
 Endogenous cell-formation, 16  
 Endolymph, 881  
 Endothelia, 33  
 Ensilage, 177  
 Enzymes, 111  
 Epiblast, 23  
 Epiblastic cells, 25  
     spheres, 24  
 Epithelial cells, 28  
 Epitheliums, structure of, 33  
 Erection, mechanism of, 916  
 Esparcet, 176  
 Eustachian tube, 880, 890  
 Expiration, mechanism of, 578  
 Expired air, constituents of, 588  
     temperature of, 588  
     watery vapor of, 588  
 Extensibility of tissues, 66  
 External intercostal muscles, action of, in  
     inspiration, 577  
 Eyeball, muscles of, 874  
  
 Eye, development of, 848  
     formation of image in, 857  
     refraction in, 858  
 Eyes, composite, 847  
     structure of, 848  
  
 Facial nerve, 834  
 Fæces, composition of, 445  
 Fat, absorption of, 456  
     feeding with, 682  
 Fat-ferment, 112  
 Fat of milk, production of, 626  
     influence of, on nitrogenous waste, 677  
     on nutrition, 680  
     metabolism of, 673  
     sources of, 665  
 Fats, 120  
     action of pancreatic juice on, 406  
     composition of, 123  
     detection of, 121  
     factor of, 673  
     of milk, 617  
 Fattening animals, foods of, 687  
 Fatty acids, construction of, 85  
     constituents of food, fate of, 664  
     tissue, formation of, 664  
 Feeding, nutritive processes in, 680  
     proper intervals between, 689  
     with carbohydrates, nutritive pro-  
         cesses in, 683  
     with meat, nutritive processes in, 680  
 Fenestra ovalis, 880  
     rotunda, 880  
 Ferment, amyolytic, 112  
     diastatic, 112  
     fat, 112  
     fibrin, 487  
     inversive, 112  
     milk-curdling, 112  
     of the liver, 112, 671  
     proteolytic, 112  
 Fermentation, alcoholic, 147  
     of lactic acid, 147  
     in small intestine, 418  
     putrefactive, 147  
 Fermentations, 145  
 Ferments, 110  
     of the pancreatic juice, 403, 404  
     soluble, 110  
 Fertilization of ovum, result of, 15  
 Fibrillar cartilage, 35  
 Fibrin, 98, 488  
     ferment, 487  
     formation of, 485  
     gluten, 95  
     vegetable, 95  
 Fibrinogen, 97, 487  
 Fibrinoplastin, 487  
 Fibro-cartilage, 35  
 Fibrous tissue, 35  
 Filtration, 48  
     in the kidneys, 644  
 Fishes, auditory apparatus of, 876

- Fishes, brain of, 804  
 circulation in, 494  
 digestive apparatus of, 210  
 eyes of, 849  
 nervous system of, 770  
 olfactory apparatus in, 844  
 reproduction in, 904  
 respiratory apparatus of, 566
- Fistula, gastric, 342  
 pancreatic, 398  
 parotid, 275  
 submaxillary, 279
- Flexibility of tissues, 67
- Flustra, digestive apparatus of, 205
- Fodders, amounts of salts in, 679  
 changes in, 176  
 composition of, 184  
 dry, 162  
 green, 162  
 influence of chopping on, 688  
 nutritive proportions in, 685
- Food, action of gastric juice on, 351  
 carbohydrate, fate of, 666  
 constituents, albuminous, fate of, 660  
 for cattle, horses, sheep, and swine, 690  
 prehension of, 226  
 products, composition of, 184  
 required by the herbivora under different conditions, 684  
 stuffs, digestibility of, 432
- Foods, 157  
 animal, 188  
 inorganic, 191  
 nutritive values of, 685  
 of animals, 158  
 of carnivora, 160  
 of herbivora, 160  
 vegetable, 161
- Force, consumption of, in cells, 147  
 development of, in cells, 147
- Formatio reticularis, 811
- Form of cells, modification in, 26
- Frog, heart of, 502
- Frohde's test for proteids, 92
- Fructivora, characteristics of, 197
- Functions, animal, 8  
 definition of, 8  
 nutritive, 155  
 of relation, definition of, 8  
 reproductive, 8, 901  
 specialization of, 15, 32  
 vegetative, definition of, 8
- Funiculus cuneatus, 797  
 gracilis, 810
- Gaits of the horse, 739
- Gall-bladder, 382
- Gallop, 749
- Ganglia of the heart, 541  
 sporadic, 782
- Ganglion-cell, 27
- Ganglionic cells, structure of, 772
- Gaseous diffusion, 56  
 in the animal organism, 60  
 through porous partitions, 58
- Gases, absorption of, 58  
 of blood, 490
- Gastric digestion, 337  
 in birds, 379  
 in carnivora, 360  
 in omnivora, 363  
 in the horse, 368  
 in ruminants, 374  
 fistula, 342  
 glands, changes of, in digestion, 357  
 juice, acid of, 349  
 action of, on food, 351  
 artificial, 341  
 chemistry of, 342  
 influence of nervous system on, 360  
 mechanism of secretion of, 360  
 secretion of, 356  
 movements, 340
- Gelatin, 106  
 vegetable, 96
- Gelatinous tissue, 35
- Gemmation, 16
- Gemmparous generation, 903
- General physiology, definition of, 1
- Generation by fission, 903  
 by spores, 903
- Germinal disk of hen's egg, 23  
 spot, 15  
 vesicle, 15
- Gestation, duration of in different animals, 907
- Ginglymous joint, 730
- Gizzard, functions of, 381
- Glands, mammary, structure of, 624  
 of stomach, tubular, 356  
 structure of, 36
- Glandular tissue, 34
- Gliadin, 96
- Globulins, 96  
 vegetable, 97
- Glomerulus, functions of, 642
- Glosso-pharyngeal nerve, 384
- Glottis, movements of, 762  
 in respiration, 579
- Glucoses, 117  
 tests for, 118
- Glucosides, 117
- Gluten, 95  
 casein, 95  
 fibrin, 95
- Glycerin, 122
- Glyceryl, 121
- Glycin, 387
- Glycochol, 387, 664
- Glycocholate of sodium, 384
- Glycocholic acid, 386
- Glycogen, 116  
 characteristics of, 668  
 influence of the nervous system on, 671



- Glycogen, origin of, 669  
 preparation of, 668  
 relation of, to diet, 669
- Glycogenic centre, 817
- Glycogenesis, 667
- Goat and sheep, urine of, 640  
 prehension of food in, 235
- Goll, column of, 787, 797
- Graafian follicles, 909
- Graham's law of the diffusion of gases, 58
- Grains and fruits, composition of, 184
- Granivora, characteristics of, 197
- Granulose, 114
- Grape-sugar, 117
- Grasses, 175
- Green fodder, 162  
 composition of, 184
- Growth of protoplasm, 14
- Gustatory cells, 894  
 nerves, 896
- Hæmoglobin, 475, 593  
 reduced, 594  
 spectrum of, 594
- Harder's gland, 850
- Hauling, mechanism of, 755
- Hay, composition of, 187
- Hearing, function of, 883  
 sense of, 875
- Heart, accelerator nerves of, 551  
 action of, 499  
 heat on, 547  
 changes of shape in contraction, 505  
 inhibitory nerves of, 549  
 intrinsic nervous system of, 540  
 movements of, 502  
 in mammals, 503, 504  
 of frog, 502  
 of mammals, 498  
 of ox, 509  
 sounds of, 514  
 structure of, 500  
 tetanus, 547  
 work of, 532
- Heat, action of, on heart, 547  
 animal, 693  
 centres, 698  
 modes of loss of, 696  
 sources of, 694, 696  
 symptoms of, in animals, 911
- Hemipeptone, 409
- Hen's egg, structure of, 20
- Herbivora, characteristics of, 197  
 urine of, 637  
 digestive power of, 436  
 fæces of, 446  
 food required by, 684  
 foods of, 160
- Hiccough, 604
- Hippuric acid, 663
- Hog, composition of hile of, 384  
 larynx of, 761  
 structure of stomach of, 363
- Hogs, food required in fattening, 688  
 normal foods for, 690
- Holoblastic ovum, 19
- Homocerebrin, 775
- Horse, dentition of, 253  
 fat, 123  
 gaits of, 739  
 gastric digestion in, 368  
 juice of, 370  
 glottis of, 760  
 mechanics of the limbs of, 739  
 normal foods for, 690  
 power, 755  
 prehension of food in, 234  
 respiratory movements of, 582  
 tongue of, 233  
 urine of, 638
- Human physiology, definition of, 1
- Hunger, 692
- Hyaline cartilage, 35
- Hydra, digestive processes in, 205
- Hydrates, formation of, from anhydrates, 146
- Hydraulic principles of the circulation, 516
- Hydrocarbons, 120  
 construction of, 85
- Hydrochloric acid, 135
- Hypermetropia, 861
- Hypoblast, 24  
 division of, 25
- Hypoblastic cells, 25  
 spheres, 24
- Hypoglossal nerve, 835
- Imbibition, 44  
 influence on ciliary movements, 80  
 on protoplasmic motion, 82
- Impregnation, 916
- Incus, 880
- Indican, 412
- Indol, 411
- Infusoria, ciliated movement in, 77  
 digestive processes in, 204
- Inhibition, 785
- Inhibitory nerves of the heart, 549
- Inorganic cell-constituents, 123  
 constituents of cells, 86  
 foods, 191
- Inosite, 118
- Insects, digestive apparatus of, 207  
 eyes of, 847
- Inspiration, mechanism of, 574
- Intensity of sound, 758
- Intercellular tissues, 34
- Intercostal muscles, action of, in inspira-  
 tion, 577  
 nerves, influence of on respiration, 599
- Intestinal digestion, 382  
 in different animals, 419  
 fistula, 416  
 juice, 416  
 action of on food-stuffs, 418  
 characteristics of, 417

- Intestinal reaction, 421  
 Intestines, characteristics of, 217  
   fermentation in, 418  
   large, digestion in, 423  
   movements of, 448  
   muscular structure of, 448  
 Inulin, 116  
 Inverse ferment, 112, 418  
 Invert-sugar, 119, 418  
 Iris, 849  
   muscular fibres of, 862  
 Iron, 136  
 Irradiation, 871  
 Irritability, muscular, 709  
   of muscle, influence of temperature on, 719  
   of nerves, 776  
  
 Jacobson's organ, 843  
 Jaws, movements of, 241  
 Joints, formation of, 729  
   gliding, 730  
   hinged, 730  
   rotatory, 730  
 Jumping, mechanism of, in man, 738  
  
 Karyokinesis, 17  
 Kathelectrotonus, 780  
 Keratin, 109  
 Kicking, 753  
 Kidney, structure of, 640  
 Kidneys and skin, correlation of, 645  
 Kreatin, formation of, 661  
  
 Labyrinth of the ear, 880  
 Lachrymal apparatus of mammals, 850  
   duct, 850  
   secretion, 658  
 Lacteals, 457  
 Lactic acid fermentation, 147  
 Lactose, 120  
 Lævulose, 118  
 Lardacein, 102  
 Large intestine, digestion in, 423  
   structure of, 430  
 Larvæ, digestive apparatus of, 206  
 Laryngeal muscles, action of, 762  
 Larynx, nerves of, 764  
   of birds, 760  
 Latent period in muscular contraction, 713  
 Laughing, 605  
 Lecithin, 481  
 Legumin, 94  
 Leguminous plants, 173  
 Lens, action of, 853  
 Lenses, formation of images by, 857  
 Leucin, 410  
 Levatores costarum, action of in inspiration, 577  
 Lever motion of muscles, 725  
 Levers, 724  
 Lieberkuhn's glands, 416  
 Light, reflection of, 851  
  
 Lignin, 115  
 Lips, action of, in mastication, 264  
 Liquids, cohesion of, 39  
   diffusion of, 49  
   flow of, through elastic tubes, 522  
   rigid tubes, 518  
   surface tension of, 39  
 Liver ferment, 112, 671  
   glycogenic function of, 667  
 Lobes of the brain, 804  
 Localization of the functions in the cortex, 825  
 Locomotion, animal, 731  
 Lungs, diffusion of gases in, 592  
 Lying down and rising up, mechanism of, 754  
 Lymph, 463  
   circulation of, 467  
 Lymphatics, absorption of, 456  
  
 Macula lutea, 865  
 Magnesium-ammonium phosphate, 136  
   carbonate, 130  
   chloride, 136  
   phosphate, 134  
 Malleus, 880  
 Maltose, 120  
 Mammalian heart, 498  
   ovum, changes in, from impregnation, 24  
   segmentation of, 19  
 Mammals, brain of, 809  
   circulation in, 497  
   digestive apparatus of, 213  
   movements of the heart in, 503  
   ocular apparatus in, 849  
   process of fecundation in, 904  
   reproduction in, 906  
 Mammary glands, histological changes in, 628  
   innervation of, 629  
   structure of, 624  
   secretion, 609  
 Manganese, 136  
 Manometer, 526  
 Manyplices, functions of, 377  
   structure of, 319  
 Marey's tambour, 581  
 Margaric acid, 122  
 Margarin, 122  
 Masseter muscle, action of, 243  
 Mastication, 338  
   centre for, 817  
   duration of, 266  
   influence of saliva on, 267  
 Meal, buckwheat, 172  
 Meat, 188  
   composition of, 189  
   nutritive processes of feeding with, 680  
 Mechanical movement in cells, 70  
 Meconium, composition of, 445  
 Medulla oblongata, 810, 816

- Medulla oblongata, course of fibres of, 818  
     functions of, 814  
 Membrane of cells, 13  
     vitelline, 15  
 Mesencephalon, 803  
 Mesoblast, 23, 25  
 Meta-albumen, 103  
 Micturition, centre for, 649  
     mechanism of, 648  
 Milk, 188  
     cistern, 624  
     coagulation, 614  
     curdling ferment, 112, 347  
         action of, 615  
         of pancreatic juice, 411  
     gases of, 619  
     gastric digestion of, 354  
     globules, 610  
     influence of albuminoids on, 622  
         diet on quantity of, 622  
         fat on, 623  
         water on, 622  
     inorganic constituents of, 619  
     inspection and analysis, 631  
     of different animals, composition of,  
         613  
     physical and chemical properties of,  
         610  
     quantity of, 620  
     reaction of, 611  
     secretion of, 609, 624  
         influence of nervous system on,  
             629  
     skimmed, 619  
     solids, estimation of, 633  
     sugar, 120, 616  
         estimation of, 634  
         origin of, 627  
     uterine, 610  
     variation in the quantity and compo-  
         sition of, 619  
 Millon's reaction for proteids, 91  
 Mimosa pudica, 71  
 Mitral valves, 509  
 Mollusks, digestive apparatus of, 209  
     nervous system of, 767  
 Motion from imbibition in cells, 70  
 Motor centres of the cortex, 825  
     impulses in spinal cord, path of, 801  
 Motory impulses, paths of, 829  
 Mouth, digestion in, 268  
 Movement, ciliary, 77  
     physiology of, 701  
     protoplasmic, general conditions of, 82  
 Movements, amoeboid, 75  
     from imbibition in cells, 70  
         of cell contents, 70  
     in cells, 70  
     in protoplasmic contents of cells, 73  
     of intestines, 448  
     of stomach, 340  
     of the heart, 502  
 Mucedin, 96  
 Mucoid tissue, 35  
 Mulberry mass, 15, 19  
 Muscarine, 546  
 Muscin, 104  
     characteristics of, 105  
     preparation of, 105  
 Muscle, accessory, 578  
     analysis of, 709  
     chemical composition of, 704  
         processes in, 708  
     coagulation of, 705  
     current, 722  
     curve, 713  
     electrical phenomena in, 721  
     ferment, 706  
     gases of, 708  
     microscopic changes of, in contrac-  
         tion, 719  
     plasma, 705  
     serum, 707  
     stapedius, 890  
     tensor tympani, 890  
 Muscles, classification of, 722  
     intercostal, action of, 577  
     of the eye, 874  
     structure of, 36, 701  
 Muscular contraction, 81, 710, 714  
     chemical changes in, 719  
     heat production in, 720  
     phenomena of, 710  
     wave of, 718  
     work of, 721  
     contractility, applications of, 722  
     corpuscles, 703  
     fibres, isolated, 28  
         of heart, 500  
         striped, 701  
         structure of, 701  
         unstriped, 703  
     irritability, 709  
     preparation, 711  
     sound, 716  
     stimuli, 710  
     tissue, 34  
 Myelencephalon, 803  
 Myo-albumose, 707  
 Myoglobulin, 707  
 Myograph, 712  
 Myopic eye, 861  
 Myosin, 97, 99, 704  
     ferment, 706  
 Myosinogen, 706, 707  
 Myriapods, digestive apparatus of, 206  
 Negative impulse, 508  
     variation of nerve-current, 780  
 Nerve, abducens, 833  
     auditory, 834  
     centres, general physiology of, 781  
         of spinal cord, 789  
     corpuscles, structure of, 772  
     current, 779  
     depressor, 556

- Nerve, facial, 834  
 fibres, physical properties of, 775  
 structure of, 30  
 hypoglossal, 835  
 oculo-motor, 832  
 olfactory, 832  
 optic, 832  
 pathetic, 832  
 pneumogastric, 834  
 spinal accessory, 835  
 stimuli, 776  
 tissue, development of, 34  
 trifacial, 833  
 trigeminal, 833  
 trunk, structure of, 772
- Nerves, accelerator, 551  
 afferent, 772  
 centrifugal, 772  
 centripetal, 772  
 degeneration of, 778  
 efferent, 772  
 electrical phenomena in, 779  
 functional, distinctions between, 772  
 influence of constant current on, 777,  
 780  
 inhibitory, 549  
 intercostal, 599  
 laryngeal, influence of, in respiration,  
 601  
 of taste, 896  
 phrenic, 599  
 pneumogastric, influence of in respira-  
 tion, 600  
 vaso-constrictor, 558  
 vaso-dilator, 558  
 vaso-motor, 554
- Nervous influence on protoplasmic motion,  
 76  
 irritability, 776  
 system, conduction of motor and sen-  
 sory impulses through, 827  
 influence of, on arteries, 552  
 on bodily temperature, 697  
 on circulation, 540  
 on micturition, 649  
 on renal secretion, 645  
 on respiration, 598  
 secretion of milk, 629  
 of articulates, 767  
 of birds, 770  
 of fishes, 770  
 of mollusks, 767  
 of reptiles, 770  
 of star-fish, 766  
 of the heart, 540  
 of vertebrates, 769  
 organs of, 36  
 physiology of, 765  
 scheme of, 766  
 structure of, 770  
 sympathetic, 835  
 tissues, chemical and physical charac-  
 teristics of, 774
- Neurokeratin, 775  
 Nicotine, action of, on heart, 546  
 Nitrogen, excretion of, 672  
 Nitrogenous matter, metabolism of, 673  
 organic cell-constituents, 88  
 tissue, constituents of, 85
- Nœud vital, 600
- Non-nitrogenous organic cell-constituents,  
 112  
 tissue, constituents of, 85
- Nostrils, movements of, in respiration, 579
- Nuclein, 482  
 Nucleolus of cells, 13  
 Nucleus, deviation in form of, 27  
 division of, 17  
 of cells, 13  
 of Pander, 21
- Nutrition, 659  
 of nerves, influence of spinal cord on,  
 778  
 of protoplasm, 14  
 statistics of, 672
- Nutritive functions, 155  
 processes in feeding, 680  
 proportion in foods, 684  
 proportions, 195  
 salts, 192  
 substances, 159
- Oats, composition of, 167  
 Oesophageal canal, 320  
 functions of, 376
- Ocelli, 847
- Ocular apparatus in mammals, 849  
 muscles, 875
- Oculo-motor nerve, 832, 875  
 action of, on pupil, 862
- Odoriferous substances, properties of, 844
- Oleic acid, 122
- Olein, 122
- Olfactory cells, 842  
 lobes, 807, 841  
 nerve, 832, 841  
 distribution of, 842
- Olivary bodies, 811
- Omasum, structure of, 319
- Omnivora, characteristics of, 198  
 digestive power of, 436  
 gastric digestion in, 363
- Optical characteristics of tissues, 68
- Optic lobes, 807  
 nerve, 832  
 nerve-fibres, 867  
 thalamus, functions of, 823
- Organic acids, construction of, 85  
 nitrogenous cell-constituents, 88
- Organisms, elementary, 11
- Organized and unorganized bodies, distinc-  
 tions between, 2  
 bodies, structure of, 11  
 body, definition of, 2
- Organs and tissues, development of, 31  
 classification of, 36

- Organs, composition of, 36  
 of circulation, 491  
 of respiration, 562
- Origin of cells, 14
- Osmosis, 51  
 causes of, 55  
 explanation of, 54  
 illustrations of, 56  
 rapidity of, 52
- Osmotic equivalent, 52
- Osteoblasts, 36
- Otoliths, 881
- Ova, 909
- Ovary, 909
- Ovum, 15  
 changes of fertilization in, 18  
 cleavage of, 15, 19  
 fertilization of, 15  
 holoblastic, 19  
 meroblastic, 19  
 of animals, classes of, 19  
 of mammals, 18  
 of rabbit, size of, 25  
 size of, 15
- Ox, dentition in, 258  
 fat, 123  
 heart of, 509  
 prehension of food in, 234  
 tongue of, 233  
 urine of, 639
- Oxen, food required in fattening, 687
- Oxygen, absorption of, by hæmoglobin, 594  
 by the blood, 592  
 influence of protoplasmic movements,  
 83
- Oxyhæmoglobin, 476  
 spectrum of, 594
- Pacing, 747
- Palmitic acid, 122
- Palmitin, 122
- Pancreas, anatomy of, 639  
 histological changes of, in digestion,  
 413  
 of the bird, 398  
 of the cat, 398  
 of the dog, 397
- Pancreatic ferments, 403  
 isolation of, 404  
 fistulæ, 398  
 juice, action of, on carbohydrates, 406  
 on fats, 406  
 on food-stuffs, 405  
 on proteids, 408  
 artificial, 405  
 chemical composition of, 402  
 milk-curdling ferment of, 411  
 secretion of, 412  
 secretion, 396  
 influence of nervous system on,  
 415
- Pander, nucleus of, 21
- Papillary muscles, 510
- Para-albumen, 103
- Paraglobulin, 97, 487
- Paramyosinogen, 706
- Parapeptone, 99
- Parotid fistula, 275  
 gland, nervous supply of, 303  
 saliva, composition of, 278  
 secretion, 274
- Pathetic nerve, 832, 875
- Pathology, definition of, 1
- Peas, composition of, 173
- Penis, structure of, 916
- Pepsin, 112  
 preparation and characteristics of, 346
- Pepsinogen, 358
- Peptone, absorption of, 454  
 characters of, 353
- Peptones, 103
- Perichondrium, 36
- Peristalsis of the intestines, 448
- Perspiration, 652
- Phosphate of alkalis, 130  
 of calcium, 133  
 of magnesium, 134  
 of magnesium and ammonium, 136  
 of potassium, 130  
 of sodium, 130
- Phrenic nerves, influence of, in respiration,  
 599
- Physical process in cells, 37  
 properties of proteids, 89  
 of tissues, 61
- Physiology, definition of, 1  
 of movement, 701
- Pig, dentition in, 261  
 fat, 123  
 prehension of food in, 235  
 urine of, 640
- Pigment-cells, motions in chameleon, 75
- Pinna, 877
- Pitch of sounds, 758
- Placenta of ruminants, 908
- Plants and animals, distinction between, 5  
 reproduction in, 903  
 respiration in, 562
- Plasma of blood, 483
- Plasmine, 486
- Pneumogastric, direct stimulation of, 550  
 influence of section of, 551  
 reflex action of, 550  
 nerve, 834  
 action of, on heart, 549  
 of frog, 545  
 nerves, influence of, in respiration, 600
- Polar cell, 18
- Pons varolii, functions of, 821  
 structure of, 819
- Potassium carbonate, 129  
 chlorides, 128  
 phosphates, 130  
 sulphate, 135
- Prehension of food, 226  
 of liquids, 236

- Prehension of solids, 226  
 Processes, reproductive, 903  
 Pronucleus, female, 18  
 Prosencephalon, 803  
 Protagon, 775  
 Protamœba primitiva, 13  
 Proteids, action of pancreatic juice on, 408  
   Adamkiewicz's test for, 92  
   biuret reaction of, 91  
   chemical properties of, 90  
   coagulated, 102  
   coagulation of, 90  
   composition of, 88  
   Frohde's test for, 92  
   general characteristics of, 88  
   Millon's reaction for, 91  
   origin of, 88  
   physical properties of, 89  
   Schultz's test for, 92  
   tests for, 90  
   xantho-proteic reaction of, 91  
 Proteolytic ferment, 112  
 Protoplasm, 11  
   automatism of, 14  
   characteristics of, 73  
   contractility of, 14  
   nutrition of, 14  
   properties of, 14, 73  
   reproduction of, 14  
   respiration of, 14  
 Protoplasmic contents of cells, movements  
   in, 73  
   growth, 14  
   movement, 70  
     general conditions of, 82  
     influence of degree of imbibition  
       on, 82  
       chemical and physical agents  
       on, 84  
       nervous system on, 76  
       oxygen on, 83  
       temperature on, 82  
     nature of ciliary movements, 81  
 Psalter, functions of, 377  
   structure of, 319  
 Pseudo-fibrin, 101  
 Pseudopodia, 14  
 Ptyalin, 112, 273  
 Pulmonary capillaries, 571  
   infundibula, 570  
   valves, action of, 514  
 Pulse, 533  
   and blood pressure, causes of modifica-  
   tions in, 560  
   of different animals, 548  
   wave, production of, 534  
     rate of movement of, 533  
 Pupil, centre for the dilatation of, 817,  
   863  
   changes of in accommodation, 862  
   influence of drugs on, 864  
   nerve supply of, 862  
 Putrefactive fermentation, 147  
 Pyloric glands, 356  
 Pyramidal tract of spinal cord, 797  
 Quality of sounds, 758  
 Rabbit ovum, size of, 25  
 Rack, the, 747  
 Rations, alimentary, 195  
 Rearing, 751  
 Red blood-corpuscles, 474  
 Reduced hæmoglobin, 594  
 Reflection of light, 851  
 Reflex action, 782  
   laws of, 791  
     inhibitory centre, 793  
     nutritive action, 794  
     secretory action, 793  
     vaso-motor action, 793  
 Refraction, double, 68  
   of light, 851  
   of tissues, 68  
 Refractive index, 852  
 Regio olfactoria of the nose, 842  
   respiratoria, 842  
 Relation, functions of, 8  
 Remak's division, 17  
 Renal secretion, 635  
   mechanism of, 640  
 Rennet, 112  
   action of, on milk, 615  
 Reproduction, 903  
   of cells, 16  
   of protoplasm, 14  
 Reproductive functions, 8, 901  
   processes, 903  
   tissues of the female, 908  
   of the male, 913  
 Reptiles, auditory apparatus of, 876  
   brain of, 804  
   digestive apparatus of, 210  
   nervous system of, 770  
   organs of circulation in, 496  
   reproduction in, 904  
   respiratory apparatus of, 568  
   vision in, 849  
 Residual volume of air, 574  
 Resistance to traction, 63  
 Resonance, 885  
 Respiration, 561  
   changes of the air in, 588  
   chemical phenomena in, 587  
   cutaneous, 656  
   influence of, on circulation, 605  
   mechanical processes of, 574  
   nervous mechanism of, 598  
   of protoplasm, 14  
   organs of, 562  
   rhythm, 579  
 Respirations, numbers of, in different ani-  
   mals, 581  
 Respiratory centre, 816  
   action of blood on, 602  
   location of, 600

- Respiratory changes in the blood, 591  
 curve, 581  
 movements, modified, 604  
 organs of birds, 568  
   of fishes, 566  
   of reptiles, 568  
   types of, 563  
 volumes of air, 585
- Restiform bodies, 811
- Reticulum, functions of, 376  
 structure of, 318
- Retina, functions of, 867  
 structure of, 865
- Retinal purple, 868
- Rheoscopic frog, 722
- Rhodopsin, 868
- Rhythm of respiration, 579
- Ribs, movements of, in respiration, 575
- Rigid tubes, flow of liquids through, 518
- Rigor mortis, 704
- Rising up and lying down, mechanism of, 754
- Roots and bulbs, composition of, 184
- Rotatory joint, 730
- Rumen, functions of, 374
- Ruminants, convolutions of the brain of, 805  
 dentition of, 258  
 gastric digestion in, 374  
 larynx of, 761  
 respiratory movements of, 582
- Rumination, 316  
 changes of food in, 323  
 influence of nervous system on, 330  
 structure of, 317
- Running in quadrupeds, 749  
 mechanism of, in men, 738
- Rut, 911
- Rye residue, 181
- Saccharates, 119
- Saccharose, 119
- Saliva, centre for secretion of, 817  
 chemical composition of, 271  
 course of, 270  
 physiological uses of, 287  
 quantity of, 286
- Salivary glands, experiments on, 295  
 histological changes in, 305  
 secretion, 268  
   characteristics of, 284  
   mechanism of, 293
- Salts, absorption of, 454  
 amount of, in fodders, 679  
 influence of, on nutrition, 678  
 nutritive, 192
- Saponification, 121
- Sarkin, 663
- Scalene muscles, action of, in inspiration, 577
- Schleiden's cell doctrine, 15
- Schultze's test for reaction of proteids, 92
- Schwann's cell doctrine, 15
- Sclerotic, 849
- Sebaceous secretion of the skin, 655
- Secretion of bile, 391  
   of gastric juice, 356  
   of milk, 609  
   of sweat, 652  
   of tears, 658  
   of the skin, sebaceous, 655  
   parotid, 274  
   salivary, 268  
   sublingual, 283  
   submaxillary, 279
- Secretory phenomena, 793
- Section of spinal cord, results of, 800
- Segmentation of mammalian ovum, 19
- Semicircular canals, 877
- Semilunar valves, action of, 513
- Seminal fluid, 913
- Sensation, 837
- Sensations, tactile, 897  
 visual, 864
- Sense of hearing, 875  
 of sight, 846  
 of smell, 841  
 of taste, 893  
 of touch, 897
- Sensibility, conditions of, 838  
 general and special, 837
- Sensitive plant, 71  
 motions of, 71
- Sensory impulses, paths of, 801, 827
- Serum-albumen, 92  
 of blood, 489
- Setchenow's inhibitory centre, 793
- Sheep and goat, urine of, 640
- Sheep, dentition of, 259  
 fat, 123  
 food required in fattening, 687  
 normal foods for, 690  
 prehension of food in, 235
- Shell-membrane of egg, formation of, 22
- Sighing, 604
- Sight, sense of, 846
- Silicon, 136
- Sinus venosus, 503
- Sitting, mechanism of, in man, 733
- Skin as a heat regulator, 651  
 as an excretory organ, 651  
 functions of, 651  
 sebaceous, secretion of, 655
- Smell, intensity of, 846  
 sense of, 841
- Sneezing, 605  
 centre for, 816
- Soaps, 121
- Sobbing, 605
- Socket-and-ball joint, 730
- Sodium carbonate, 129  
 chloride, 128  
 phosphate of, 130  
 sulphate, 135
- Solids, prehension of, 226
- Solipedes, gastric digestion in, 368

- Soluble ferments, 110  
 Solution, 43  
 Sound, reflection of, 883  
 Sounds, conduction of, 884  
   of the heart, 514  
   pitch of, 884  
   reciprocation of, 884  
   sympathetic vibration of, 884  
   transmission of, 884  
   variations in, 758  
 Special physiology, definition of, 1  
 Specialization of function, 15, 32  
 Specific gravity of tissues, 62  
 Spectra of hæmoglobin, 477  
 Spermacti, 122  
 Spermatic cells, 915  
 Spermatoblasts, 915  
 Spermatozoa, 28, 914  
   development of, 915  
   motion of, 77  
 Spherical aberration, 854  
 Sphygmograph, 536  
 Spinal accessory nerve, 835  
   cord as a collection of nerve-centres,  
     789  
   course of fibres in, 789, 797  
   functions of, 786  
   histology of, 789  
   influence of, on renal secretion,  
     645  
   reflex action of, 790  
   section of antero-lateral columns  
     of, 801  
     experiments on, 800  
     longitudinal section of, 801  
     section of, 800  
   structure of, 786  
   tracts of, 796  
   roots, course of fibres in, 798  
   influence of, on nervous nutrition,  
     778  
 Splanchnic nerves, influence of, on renal  
   secretion, 645  
 Spleen, influence of on pancreas, 409  
 Stability of animal bodies, 731  
 Stable equilibrium, 731  
 Standing in quadrupeds, 733  
   mechanism of, in man, 732  
 Stapedius muscle, 890  
 Stapes, 880  
 Starch, changes of, through saliva, 289  
 Starches, 112  
   gastric digestion of, 354  
   test for, 114  
 Star-fish, nervous system of, 766  
 Starvation, loss of weight in different tis-  
   sues, 676  
   tissue changes in, 674  
 Stearic acid, 122  
 Stearin, 122  
 Stereoscope, 870  
 Stimuli of nerves, 776  
 Stomach, accumulation of food in, 338  
   Stomach, changes of food in, 341  
     characteristics of, 215  
     of hog, 216  
       structure of, 363  
     of horse, 215  
     of ruminant, capacity of, 339  
     structure of, 356  
 Straw, barley, 171  
   buckwheat, 172  
   composition of, 178  
 Stroma of blood-corpuscles, 474  
 Structure of organized bodies, 11  
 Sublingual secretion, 283  
 Submaxillary saliva, composition of, 280  
   fistula, 279  
   secretion, 279  
 Succus entericus, 416  
 Suckling and mastication, centre for, 817  
 Sugar, absorption of, 454  
   fate of, 670  
   milk, 120  
   of milk, 616  
 Sulphate of calcium, 136  
   of potassium, 135  
   of sodium, 135  
 Supplemental volume of air, 573  
 Sweat, composition of, 652  
   influence of nervous system on, 654  
   quantity of, 653  
   secretion, 652  
     of, 654  
 Swimming in the horse, 755  
 Swine, normal foods for, 690  
 Sympathetic nerve, 835  
   action of, on pupil, 862  
   influence of, on temperature, 697  
 Synarthroses, 729  
 Syntonin, 99  
 Syrinx of birds, 760  
 Tactile sensations, 897  
 Taste bulbs, 893  
   nerves of, 896  
   sense of, 893  
 Taurin, 387  
 Taurocholate of sodium, 384  
 Taurocholic acid, 386  
 Tears, composition of, 658  
 Teeth, action of, in mastication, 245  
   compound, structure of, 246  
   structure of, 245  
 Tegmentum cruris, 819  
 Temperature influence on ciliary motion, 80  
   on nerve irritability, 776  
   on protoplasmic movement, 82  
   of different domestic animals, 696  
 Temporal muscle, action of, 243  
 Tensor tympani muscle, 890  
 Tetanus, 715  
 Thirst, 92  
 Thoracic duct, chyle of, 460  
 Thorax, 571  
 Tidal volume of air, 573



- Timbre of sounds, 758  
 Timothy, composition of, 187  
 Tissue changes in starvation, 674  
   elastic, 35  
   fibrous, 35  
   gelatinous, 35  
   glandular, 34  
   mucoid, 35  
   muscular, 34  
   nerve, development of, 34  
   nitrogenous constituents of, 85  
   non-nitrogenous constituents of, 85  
 Tissues, absorption of, for colors, 68  
   and organs, development of, 31  
   classification of, 33  
   cohesion of, 62  
   connective, 34  
   contractile, 701  
   development of, 15  
   elasticity of, 65  
   electrical phenomena of, 70  
   extensibility of, 66, 67  
   flexibility of, 67  
   intercellular, 34  
   optical characteristics of, 68  
   physical properties, 61  
   refraction of, 68  
   reproductive, of the female, 908  
   resistance of, to flexion, 64  
     to pressure, 63  
     to torsion, 64  
     to traction, 63  
   specific gravity of, 62  
 Tongue, action of, in mastication, 264  
   of horse, 233  
   of ox, 233  
 Torricelli's theorem, 517  
 Touch corpuscles, 899  
   sense of, 897  
 Trachea, structure of, 569  
 Tradescantia virginica, 73  
 Transudation, 48  
 Tread, 20  
 Trifacial nerve, 833  
 Tricuspid valve, 509  
 Trigeminal nerve, 833  
 Trochlearis, 832  
 Trot, 748  
 Trypsin, 409  
 Tubular glands of stomach, 356  
 Tympanic membrane, 879  
 Tympanum, 877, 879  
 Tyrosin, 410  
  
 Unformed ferments, 111  
 Unorganized and organized bodies, distinctions between, 22  
 Unstable equilibrium, 731  
 Urea, excretion of, in starvation, 676  
   formation of, 661, 662  
 Uric acid, 663  
   source of, 662  
 Urinary secretion, mechanism of, 640  
  
 Urinary tubules, functions of, 643, 646  
 Urination, mechanism of, 648  
 Urine, composition of, 636  
   of carnivora, 637  
   of dog, 640  
   of herbivora, 637  
   of horse, 638  
   of ox, 639  
   of pig, 640  
   of sheep and goat, 640  
   physical and chemical properties of, 635  
 Uterus, 908  
  
 Vagus nerve of frog, 545  
   wave, 549  
 Vallisneria, movements in, 74  
 Valves of the heart, action of, 508  
 Vaso-constrictor nerves, 558  
   dilator nerves, 558  
   motor centre, 555  
   centres, 794  
   nerves, 554  
 Vegetable albumens, 93  
   caseins, 94  
   cells, chemical processes in, 137  
   fibrin, 95  
   foods, 161  
   gelatin, 96  
   globulins, 97  
   physiology, definition of, 10  
 Vegetative functions, definition of, 8  
 Veins, blood pressure in, 539  
   circulation in, 539  
   velocity of circulation in, 540  
 Velocity of the blood, 530  
 Vena contracta, 518  
 Venous absorption, 453  
   blood, gases of, 592  
   sinus, 503  
 Ventricle, fourth, of the brain, 812  
 Ventricles, capacity of, 532  
   movements of, 503  
   muscular fibres of, 502  
 Ventriculus, functions of, 380  
 Venus' fly-trap, motions of, 8  
 Vernix caseosa, 655  
 Vertebrates, digestive apparatus of, 209  
   nervous system of, 769  
 Vesicle, blastodermic, 25  
   germinal, 15  
   modifications of free fertilization in, 18  
 Vestibule of the ear, 877  
 Villi, structure and functions of, 456  
 Vision, sense of, 846  
 Visual apparatus, structure of, 846  
   imperfection, 872  
   purple, 868  
   sensations, 864  
 Vital capacity, volume of, 586  
 Vitellin, 97  
 Vitelline membrane, 15

- Vitreous humor, 849  
Vocal cords, 757  
    muscles of, 762  
Voice, 757  
    production of, 758  
Vomiting, centre for, 817  
    mechanism of, 330  
    nervous mechanism of, 334  
Walking backward in the horse, 754  
    mechanism of, in the horse, 744  
    in man, 737  
Water, 124, 191  
    in cells, 86  
White blood-corpuscles, 479  
Wool-producing animals, food required by, 688  
Worms, digestive apparatus of, 205  
Xanthin, 663  
Xantho-proteic reaction of proteids, 91  
Yawning, 604  
Yolk of egg, structure of, 20  
Yellow spot of the retina, 865  
Zona pellucida, 15  
    radiata, 15  
Zymogen, 409

H. R. Ryder











